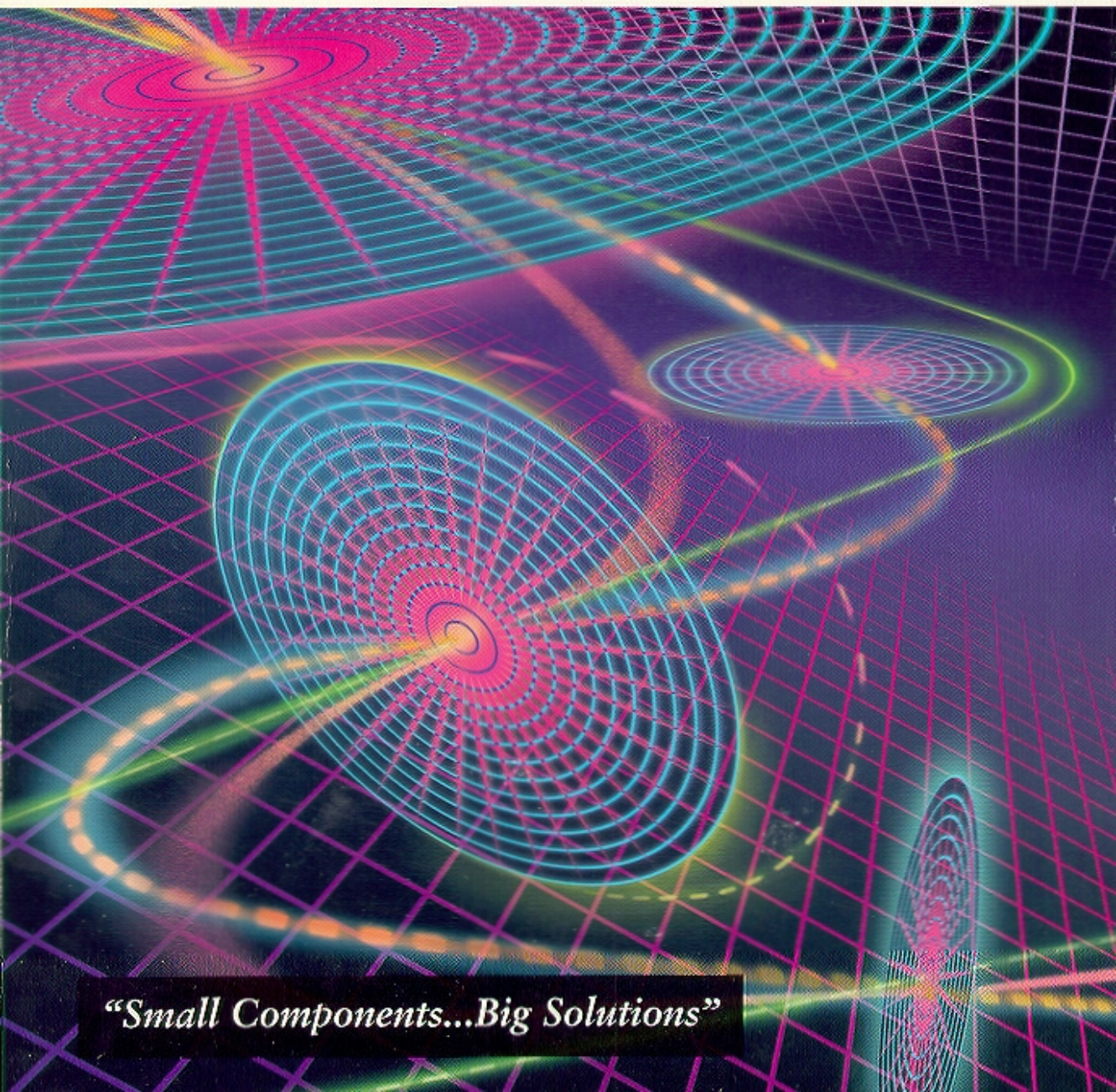


Small-Signal

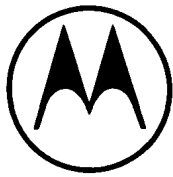
Transistors, FETs and Diodes Device Data



"Small Components...Big Solutions"

Selector Guide	1
Plastic-Encapsulated Transistors	2
GreenLine™ Portfolio Devices	3
Small-Signal Field-Effect Transistors and MOSFETs	4
Small-Signal Tuning and Switching Diodes	5
Tape and Reel Specifications and Packaging Specifications	6
Surface Mount Information	7
Package Outline Dimensions	8
Reliability and Quality Assurance	9
Replacement Devices	10
Alphanumeric Index	11

TMOS® is a registered trademark of Motorola Inc.
HDTMOS and GreenLine are trademarks of Motorola Inc.
Thermal Clad is a trademark of the Bergquist Company.



MOTOROLA


SMALL-SIGNAL TRANSISTORS, FETs AND DIODES

This publication presents technical information for the several product families that comprise the Motorola small-signal semiconductor line. The families include bipolar transistors, field-effect transistors, and diodes. These are available in a variety of through hole and surface mount packages. Complete device specifications and typical performance curves are given on individual data sheets, which are grouped by the various families.

A quick comparison of performance characteristics is presented in the easy-to-use selector guide in the first section. The tables will assist in the selection of the proper device for a specific application.

Separate sections are included to describe package outline drawings and footprints and product reliability and quality considerations.

The information in this book has been carefully checked and is believed to be accurate; however, no responsibility is assumed for inaccuracies. Furthermore, this information does not convey to the purchaser of semiconductor devices any license under the patent rights to the manufacturer.

Motorola reserves the right to make changes without further notice to any products herein. Motorola makes no warranty, representation or guarantee regarding the suitability of its products for any particular purpose, nor does Motorola assume any liability arising out of the application or use of any product or circuit, and specifically disclaims any and all liability, including without limitation consequential or incidental damages. "Typical" parameters which may be provided in Motorola data sheets and/or specifications can and do vary in different applications and actual performance may vary over time. All operating parameters, including "Typicals" must be validated for each customer application by customer's technical experts. Motorola does not convey any license under its patent rights nor the rights of others. Motorola products are not designed, intended, or authorized for use as components in systems intended for surgical implant into the body, or other applications intended to support or sustain life, or for any other application in which the failure of the Motorola product could create a situation where personal injury or death may occur. Should Buyer purchase or use Motorola products for any such unintended or unauthorized application, Buyer shall indemnify and hold Motorola and its officers, employees, subsidiaries, affiliates, and distributors harmless against all claims, costs, damages, and expenses, and reasonable attorney fees arising out of, directly or indirectly, any claim of personal injury or death associated with such unintended or unauthorized use, even if such claim alleges that Motorola was negligent regarding the design or manufacture of the part. Motorola and  are registered trademarks of Motorola, Inc. Motorola, Inc. is an Equal Opportunity/Affirmative Action Employer.

Printed in U.S.A.

© Motorola, Inc. 1997
Previous Edition © 1994
"All Rights Reserved"

About This Revision

To accommodate the increasing requirements for surface mount components, this publication adds a variety of device types in several choices of surface mount packages.

- An expanded MOSFET portfolio to include new lower $R_{DS(on)}$ HDTMOS devices in the TSOP-6 package.
- Dual transistors and diodes in the SC-70 multi-lead package.
- A Family of transistors and diodes in the smaller SC-90 package.

It should be noted that Metal Can Transistors previously listed in this data book have been removed for this revision. Replacement devices for these parts can be found in Chapter 10.

Motorola Device Classifications

In an effort to provide current information to the customer regarding the status of any given device, Motorola has classified all devices into three categories: Preferred devices, Current product and Not Recommended for New Design products.

A Preferred device is a device which is recommended as a first choice for future use. These devices are "preferred" by virtue of their performance, price functionality, or combination of attributes which offer the overall "best" value to the customer. This category contains both advanced and mature devices which will remain available for the foreseeable future (generally 3 to 5 years).

Device types identified as "current" are not a first choice product for **new** designs, but will continue to be available because of the popularity and/or standardization or volume usage in current production designs. These products can be acceptable for new designs but the preferred types are considered better alternatives for long term usage.

Any device that has not been identified as a "preferred device" is a "current" device.

Products designated as "Not Recommended for New Design" may become obsolete as dictated by poor market acceptance, or a technology or package that is reaching the end of its life cycle. Devices in this category have an uncertain future and do not represent a good selection for new device designs or long term usage.

All "Not Recommended for New Design" devices have been removed from the data book. In the event the device you need is no longer found within an appropriate section of the data book, refer to the Replacement Devices index at the back of the book to see if there is a Replacement Part for the device in question.

Table of Contents

Selector Guide	1-1	Small-Signal Tuning and Switching Diodes	5-1
Bipolar Devices	1-2	Embossed Tape and Reel	5-2
Plastic-Encapsulated Transistors	1-2	Radial Tape in Fan Fold Box or Reel	5-2
Plastic-Encapsulated Multiple Transistors	1-8	Device Markings/Date Code Characters	5-2
Plastic-Encapsulated Surface Mount Transistors	1-10	Data Sheets	5-3
Field-Effect Transistors	1-18	Tape and Reel Specifications and Packaging Specifications	6-1
JFETs	1-18	Tape and Reel Specifications	6-2
TMOS FETs	1-20	Packaging Specifications	6-5
Surface Mount FETs	1-21	Surface Mount Information	7-1
Tuning and Switching Diodes	1-23	Information for Using Surface Mount Packages	7-2
Tuning Diodes — Abrupt Junction	1-23	Footprints for Soldering	7-4
Tuning Diodes — Hyper-Abrupt Junction	1-26	Package Outline Dimensions	8-1
Schottky Diodes	1-29	Package Outline Dimensions	8-2
Switching Diodes	1-31	Reliability and Quality Assurance ...	9-1
Multiple Switching Diodes	1-35	Outgoing Quality	9-2
GreenLine Devices	1-36	Reliability Data Analysis	9-2
Small Signal Multi-Integrated Devices	1-38	Thermal Resistance	9-4
Plastic-Encapsulated Transistors ...	2-1	Air Flow	9-4
Embossed Tape and Reel	2-2	Activation Energy	9-4
Radial Tape in Fan Fold Box or Reel	2-2	Reliability Stress Tests	9-5
Device Markings/Date Code Characters	2-2	Statistical Process Control	9-7
Data Sheets	2-3	Replacement Devices	10-1
GreenLine™ Portfolio	3-1	Alphanumeric Index	11-1
Data Sheets	3-2		
Small-Signal Field-Effect Transistors and MOSFETs	4-1		
Embossed Tape and Reel	4-2		
Radial Tape in Fan Fold Box or Reel	4-2		
Device Markings/Date Code Characters	4-2		
Data Sheets	4-3		

Section 1

Selector Guide

In Brief . . .

This selector guide highlights semiconductors that are the most popular and have a history of high usage for the most applications.

A large selection of encapsulated plastic transistors, FETs and diodes are available for surface mount and insertion assembly technology. Plastic packages include TO-92 (TO-226AA), 1-Watt TO-92 (TO-226AE), SOT-23, SC-70/SOT-323, SC-90/SOT-416, SC-59, SOD-123, SOT-223, SOT-363, and TSOP-6. Plastic multiples are available in 14-pin and 16-pin dual-in-line packages for insertion applications: SO-14 and SO-16 for surface mount applications.

Bipolar Transistors

Plastic-Encapsulated Transistors

Motorola's Small Signal TO-226 plastic transistors encompass hundreds of devices with a wide variety of characteristics for general-purpose, amplifier and switching applications. The popular high-volume package combines proven reliability, performance, economy and convenience to provide the perfect solution for industrial and consumer design problems. All devices are laser marked for ease of identification and shipped in antistatic containers, as part of Motorola's ongoing practice of maintaining the highest standards of quality and reliability.

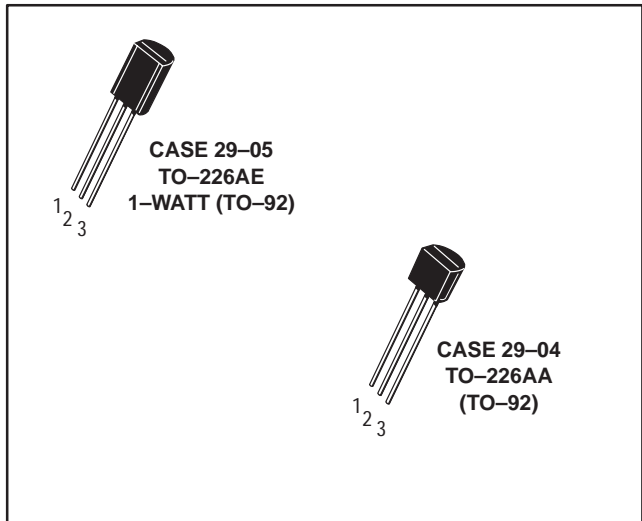


Table 1. Plastic-Encapsulated General-Purpose Transistors

These general-purpose transistors are designed for small-signal amplification from dc to low ratio frequencies. They are also useful as oscillators and general-purpose switches. Complementary devices shown where available (Tables 1-4).

NPN	PNP	V _(BR) CEO Volts Min	f _T @ I _C		I _C mA Max	h _{FE} @ I _C			NF dB Max	Style
			MHz Min	mA		Min	Max	mA		

Case 29-04 — TO-226AA (TO-92)

MPS8099	MPS8599	80	150	10	500	100	300	1.0	—	1
MPSA06	MPSA56	80	100	10	500	100	—	100	—	1
2N4410	—	80	60	10	250	60	400	10	—	1
BC546	BC556	65	150	10	100	120	450	2.0	10	17
BC546B	BC556B	65	150	10	100	180	450	2.0	10	17
MPSA05	MPSA55	60	100	10	500	100	—	100	—	1
—	MPS2907A	60	200	50	600	100	300	150	—	1
BC182	BC212	50	200 ⁽¹⁾	10	100	120	500	2.0	10	14
BC237B	BC307B	45	150	10	100	200	460	2.0	10	17
BC337	BC327	45	210 ⁽¹⁾	10	800	100	630	100	—	17
BC547	BC557	45	150	10	100	120	800	2.0	10	17
BC547A	BC557A	45	150	10	100	120	220	2.0	10	17
BC547B	BC557B	45	150	10	100	180	450	2.0	10	17
BC547C	BC557C	45	150	10	100	380	800	2.0	10	17
MPSA20	MPSA70	40	125	5.0	100	40	400	5.0	—	1
MPS2222A	—	40	300	20	600	100	300	150	—	1
2N4401	2N4403	40	200	20	600	100	300	150	—	1
2N4400	2N4402	40	150	20	600	50	150	150	—	1
MPS6602	MPS6652	40	100	50	1000	50	—	500	—	1
2N3903	2N3905	40	200	10	200	50	150	10	6.0	1
2N3904	2N3906	40	250	10	200	100	300	10	5.0	1
BC548	—	30	300 ⁽¹⁾	10	100	110	800	2.0	10	17
BC548A	—	30	300 ⁽¹⁾	10	100	120	220	2.0	10	17
BC548B	BC558B	30	300 ⁽¹⁾	10	100	200	450	2.0	10	17
BC548C	—	30	300	10	100	420	800	2.0	10	17
2N4123	2N4125	30	200	10	200	50	150	2.0	6.0	1
2N4124	—	25	250	10	200	120	360	2.0	4.0	1
BC338	BC328	25	210 ⁽¹⁾	10	800	100	630	100	—	17

(1) Typical

Devices listed in bold, italic are Motorola preferred devices.

Plastic-Encapsulated Transistors (continued)

Table 1. Plastic-Encapsulated General-Purpose Transistors (continued)

NPN	PNP	$V_{(BR)CEO}$ Volts Min	f_T @ I_C		I_C A Max	h_{FE} @ I_C			$V_{CE(sat)}$ @ I_C @ I_B			Style
			MHz Min	mA		Min	Max	mA	Volts Max	mA	mA	
Case 29-05 — TO-226AE (1-WATT TO-92)												
BDC01D	—	100	50	200	0.5	40	400	100	0.7	1000	100	14
BDB01C	BDB02C	80	50	200	0.5	40	400	100	0.7	1000	100	1
MPS6717	—	80	50	200	0.5	80	—	50	0.5	250	10	1
<i>MPSW06</i>	<i>MPSW56</i>	80	50	200	0.5	80	—	50	0.4	250	10	1

Table 2. Plastic-Encapsulated Low-Noise and Good h_{FE} Linearity

These devices are designed to use on applications where good h_{FE} linearity and low-noise characteristics are required: Instrumentation, hi-fi preamplifier.

NPN	PNP	$V_{(BR)CEO}$ Volts	h_{FE} @ I_C			$V_T^{(4)}$ mV Typ	NF ⁽⁵⁾ dB Max	f_T MHz Typ	Style
			Min	Max	mA				
Case 29-04 — TO-226AA (TO-92)									
—	<i>2N5087</i>	50	250	800	0.1	—	2.0	40 ⁽²⁾	1
MPS6428	—	50	250	650	0.1	7.0 ⁽⁷⁾	3.5 ⁽⁸⁾	100 ⁽²⁾	1
BC239	—	45	120	800	2.0	9.5	2.0 ⁽¹⁾	280	17
BC550B	—	45	180	450	2.0	—	2.5	250	17
BC550C	BC560C	45	380	800	2.0	—	2.5	250	17
<i>MPSA18</i>	—	45	500	—	1.0	6.5 ⁽¹⁾	—	160	1
MPS3904	MPS3906	40	100	300	10	—	5.0	200 ⁽²⁾	1
—	MPS4250	40	250	—	10	—	2.0	—	1
BC549B	BC559B	30	200	450	2.0	—	2.5	250	17
BC549C	BC559C	30	380	800	2.0	—	2.5	250	17
2N5088	—	30	350	—	1.0	—	3.0	50	1
2N5089 ⁽⁶⁾	—	25	450	—	1.0	—	2.0	50	1
<i>MPS6521</i>	MPS6523	25	300	600	2.0	—	3.0	—	1

(1) Typical

(2) Min

(4) V_T : Total Input Noise Voltage (see BC413/BC414 and BC415/BC416 Data Sheets) at $R_S = 2.0 \text{ k}\Omega$, $I_C = 200 \text{ }\mu\text{A}$, $V_{CE} = 5.0 \text{ Volts}$.

(5) NF: Noise Figure at $R_S = 2.0 \text{ k}\Omega$, $I_C = 200 \text{ }\mu\text{A}$, $V_{CE} = 5.0 \text{ Volts}$. $f = 30 \text{ Hz}$ to 15 kHz .

(7) $R_S = 10 \text{ k}\Omega$, BW = 1.0 Hz, $f = 100 \text{ MHz}$

(8) $R_S = 500 \text{ }\Omega$, BW = 1.0 Hz, $f = 10 \text{ MHz}$

Devices listed in bold, italic are Motorola preferred devices.

Plastic-Encapsulated Transistors (continued)

Table 3. Plastic-Encapsulated Darlington Transistors

Darlington amplifiers are cascade transistors used in applications requiring very high-gain and input impedance. These devices have monolithic construction.

NPN	PNP	$V_{(BR)CEO}$ Volts	I_C Max	$h_{FE} @ I_C$			$V_{CE(sat)} @ I_C \& I_B$			$f_T @ I_C$		Style
				Min	Max	mA	Volts Max	mA	mA	Min	mA	

Case 29-05 — TO-226AE (1-WATT TO-92)

MPSW45A	—	50	1000	25K	150K	200	1.5	1000	2.0	100	200	1
—	MPSW64	30	1000	20K	—	100	1.5	100	0.1	125	10	1

Case 29-04 — TO-226AA (TO-92)

MPSA29	—	100	500	10K	—	100	1.5	100	0.1	125	10	1
BC373	—	80	1000	10K	160K	100	1.1	250	0.25	100	100	1
MPSA27	MPSA77	60	500	10K	—	100	1.5	100	0.1	—	—	1
BC618	—	55	1000	10K	50K	200	1.1	200	0.2	150	500	17
—	MPSA75	40	500	10K	—	100	1.5	100	0.1	—	—	1
2N6427	—	40	500	20K	200K	100	1.5	500	0.5	—	—	1
2N6426	—	40	500	30K	300K	100	1.5	500	0.5	125	10	1
MPSA14	MPSA64	30	500	20K	—	100	1.5	100	0.1	125	10	1
MPSA13	MPSA63	30	500	10K	—	100	1.5	100	0.1	125	10	1
BC517	—	30	1000	30K	—	20	1.0	100	0.1	200(1)	10	17

Table 4. Plastic-Encapsulated High-Current Transistors

The following table is a listing of devices that are capable of handling a higher current range for small-signal transistors.

NPN	PNP	$V_{(BR)CEO}$ Volts Min	$f_T @ I_C$		I_C mA Max	$h_{FE} @ I_C$			$V_{CE(sat)} @ I_C \& I_B$			Style
			MHz Min	mA		Min	Max	mA	Volts Max	mA	mA	

Case 29-05 — TO-226AE (1-WATT TO-92)

MPS6715	MPS6727	40	—	—	1000	50	—	1000	0.5	1000	100	1
MPSW01A	MPSW51A	40	50	50	1000	50	—	1000	0.5/0.7	1000	100	1

Case 29-04 — TO-226AA (TO-92)

BC489	BC490	80	200/150(1)	50	1000	60	400	100	0.3/0.5	1000	100	17
BC639	BC640	80	60	10	500	40	160	150	0.5	500	50	14
MPS651	MPS751	60	75	50	2000	75	—	1000	0.5	2000	200	1
MPS650	MPS750	40	75	50	2000	75	—	1000	0.5	2000	200	1
BC368	BC369	20	65	10	1000	60	—	1000	0.5	1000	100	1

(1) Typical

Devices listed in bold, italic are Motorola preferred devices.

Plastic-Encapsulated Transistors (continued)

Table 5. Plastic-Encapsulated High-Voltage Amplifier Transistors

These high-voltage transistors are designed for driving neon bulbs and indicator tubes, for direct line operation, and for other applications requiring high-voltage capability at relatively low collector current. These devices are listed in order of decreasing breakdown voltage ($V_{(BR)CEO}$).

Device Type	$V_{(BR)CEO}$ Volts Min	I_C Amp Max	$h_{FE} @ I_C$		$V_{CE(sat)} @ I_C \& I_B$			$f_T @ I_C$		Style	
			Min	mA	Volts Max	mA	mA	MHz Min	mA		
Case 29-05 — TO-226AE (1-WATT TO-92) — NPN											
<i>MPSW42</i>	300	0.5	40	30	0.5	20	2.0	50	10	1	
Case 29-05 — TO-226AE (1-WATT TO-92) — PNP											
<i>MPSW92</i>	300	0.5	25	30	0.5	20	2.0	50	10	1	
Case 29-04 — TO-226AA (TO-92) — NPN											
BF844	400	0.3	50	10	0.5	10	1.0	—	—	1	
<i>MPSA44</i>	400	0.3	40	100	0.75	50	5.0	—	—	1	
<i>2N6517</i>	350	0.5	30	30	0.3	10	1.0	40	10	1	
BF393	300	0.5	40	10	0.2	20	2.0	50	10	1	
<i>MPSA42</i>	300	0.5	40	10	0.5	20	2.0	50	10	1	
<i>2N5551</i>	160	0.6	80	10	0.15	10	1.0	100	10	1	
Case 29-04 — TO-226AA (TO-92) — PNP											
BF493S	350	0.5	40	10	20	20	2.0	50	10	1	
<i>2N6520</i>	350	0.5	30	30	0.3	10	1.0	40	10	1	
<i>MPSA92</i>	300	0.5	40	10	0.5	20	2.0	50	10	1	
2N6519	300	0.5	45	30	0.3	10	1.0	40	10	1	
<i>2N5401</i>	150	0.6	60	10	0.2	10	1.0	100	10	1	
Case 29-04 — TO-226AA (TO-92)											
NPN	PNP	$V_{(BR)CEO}$ Volts Min	I_C Amp Cont	$h_{FE} @ I_C$		$V_{CE(sat)} @ I_C \& I_B$			$f_T @ I_C$		Style
				Min	mA	Volts Max	mA	mA	MHz Min	mA	
BF420	BF421	300	0.5	50	25	2.0	20	2.0	60	10	14
BF422	BF423	250	0.5	50	25	2.0	20	2.0	60	10	14

Devices listed in bold, italic are Motorola preferred devices.

Plastic-Encapsulated Transistors (continued)

Table 6. Plastic-Encapsulated RF Transistors

The RF transistors are designed for small-signal amplification from RF to VHF/UHF frequencies. They are also used as mixers and oscillators in the same frequency ranges.

Device Type	V _{(BR)CEO} Volts Min	I _C mA Max	hFE @ I _C			f _T MHz Typ	CRE/CRB pF Max	NF dB Typ	f MHz	Style
			Min	mA	V _{CE} V					
Case 29-04 — TO-226AA (TO-92) — NPN										
BF224	30	50	30	7.0	10	600	0.28	2.5	100	21
MPSH11	25	—	60	4.0	10	650 ⁽²⁾	0.9	—	—	2
MPSH10	25	—	60	4.0	10	650 ⁽²⁾	0.65	—	—	2
BF199	25	100	40	7.0	10	750	0.35	2.5	35	21
BF959	20	100	40	20	10	600 ⁽²⁾	0.65	3.0	200	21
MPSH17	15	—	25	5.0	10	800 ⁽²⁾	0.9	6.0 ⁽³⁾	200	2
MPS918	15	50	20	8.0	10	600 ⁽²⁾	1.7	6.0 ⁽³⁾	60	1
MPS5179	12	50	25	3.0	1.0	2000 ⁽³⁾	—	5.0 ⁽³⁾	200	1
MPS3563	12	50	20	8.0	10	800	1.7	6.0 ⁽³⁾	60	1

Case 29-04 — TO-266AA (TO-92) — PNP

MPSH81	20	50	60	5.0	10	600 ⁽²⁾	0.85	—	—	2
---------------	----	----	----	-----	----	--------------------	------	---	---	---

Table 7. Plastic-Encapsulated High-Speed Saturated Switching Transistors

Device Type	t _{on} & t _{off} @ I _C			V _{(BR)CEO} Volts Min	hFE @ I _C		V _{CE(sat)} @ I _C & I _B			f _T @ I _C		Style
	ns Max	ns Max	mA		Min	mA	Volts Max	mA	mA	MHz Min	mA	
Case 29-04 — TO-226AA (TO-92) — NPN												
2N4264	25	35	10	15	40	10	0.22	10	1.0	300	10	1
MPS3646	18	28	300	15	30	30	0.2	30	3.0	350	30	1
MPS2369A	12	18	10	15	40	10	0.2	10	1.0	—	—	1

(2) Min

(3) Max

(9) AGC Capable

Devices listed in bold, italic are Motorola preferred devices.

Plastic–Encapsulated Transistors (continued)

Table 8. Plastic–Encapsulated Choppers

Devices are listed in decreasing $V_{(BR)EBO}$.

Device Type	$V_{(BR)EBO}$ Volts Min	I_C Amp ⁽¹⁾ Max	$h_{FE} @ I_C$		$V_{CE(sat)} @ I_C \& I_B$			$f_T @ I_C$		Style
			Min	mA	Volts Max	mA	mA	MHz Min	mA	

Case 29–04 — TO–226AA (TO–92) — NPN

<i>MPSA17</i>	15	100	200	5.0	0.25	10	1.0	80	5.0	1
----------------------	----	-----	-----	-----	------	----	-----	----	-----	---

Case 29–04 — TO–266AA (TO–92) — PNP

<i>MPS404A</i>	–25	–150	30	–12	–0.2	–24	1.0	—	—	1
-----------------------	-----	------	----	-----	------	-----	-----	---	---	---

Table 9. Plastic–Encapsulated Telecom Transistors

These devices are special product ranges intended for use in telecom applications.

Device Type	$V_{(BR)CEO}$ Volts	P_D mW 25°C Amb	I_C mA Cont	$h_{FE} @ I_C @ V_{CE}$				f_T MHz Min	Style
				Min	Max	mA	Volts		

Case 29–04 — TO–226AA (TO–92) — NPN

<i>P2N2222A</i>	40	625	600	75	—	10	10	300	17
------------------------	----	-----	-----	----	---	----	----	-----	----

Case 29–04 — TO–226AA (TO–92) — PNP

<i>P2N2907A</i>	60	625	600	100	—	10	10	200	17
------------------------	----	-----	-----	-----	---	----	----	-----	----

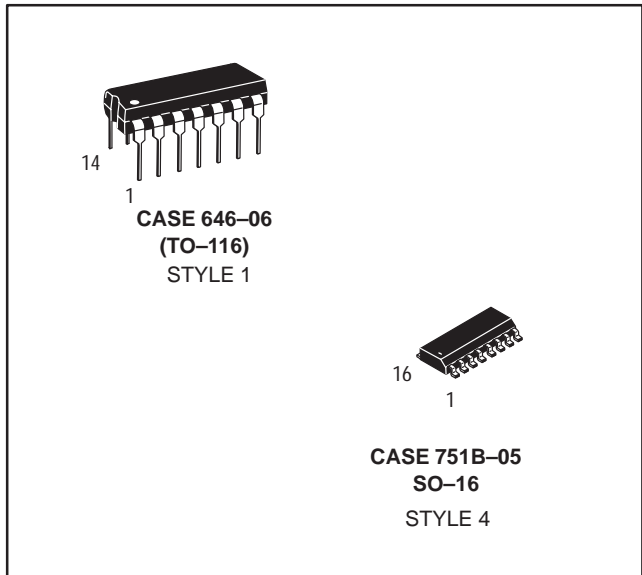
(1) Typical

Devices listed in bold, italic are Motorola preferred devices.

Plastic-Encapsulated Multiple Transistors

The manufacturing trend has been toward printed circuit board design with requirements for smaller packages with more functions. In the case of discrete components the use of the multiple device package helps to reduce board space requirements and assembly costs.

Many of the most popular devices are offered in the standard plastic DIP and surface mount IC packages. This includes small-signal NPN and PNP bipolar transistors, N-channel and P-channel FETs, as well as diode arrays.



Specification Tables

The following short form specifications include Quad and Dual transistors listed in alphanumeric order. Some columns denote two different types of data indicated by either **bold** or *italic* typeface. See key and headings for proper identification. This applies to Table 10 and 11 of this section only.

KEY										
TYPE NO.	ID	Ref. Point PD Watts One Die Only	Subscript V _{CE} Volts	I _C Amp Max	Unit h _{FE} @ I _C Min	f _T MHz Min	C _{ob} pF Max	h _{FE1} h _{FE2} t _{on} ns Max	ΔV _{BE} mV Max t _{off} ns Max	G _p dB Min NF dB Max @ f V _{CE} (sat) @ I _C Volts Max I _B
Alphanumeric listing type numbers					Common-emitter DC Current Gain.					G _p — Power Gain NF — Noise Figure f — Test Frequency AUD — 10–15 kHz Frequency Units: H — Hertz M — MHz K — kHz G — GHz V _{CE} (sat) — Collector-Emitter Saturation Voltage I _C — Test Current Current Units: u — μA m — mA A — Amp
Identification Code					Units for test Current: A — ampere m — mA u — μA					h _{FE1} /h _{FE2} — Current Gain Ratio V _{BE} — Differential Base Voltage [V _{BE1} — V _{BE2}]. Differential Amplifiers t _{on} — turn-on time t _{off} — turn-off time
First Letter: Polarity C — both types in multiple device N — NPN P — PNP Second Letter: Use A — General Purpose Amplifier E — Low Noise Audio Amplifier F — Low Noise RF Amplifier G — General Purpose Amplifier and Switch H — Tuned RF/IF Amplifier M — Differential Amplifier S — High Speed Switch D — Darlington					Current-Gain-Bandwidth Product					
Power Dissipation specified at 25°C. Single die rating. Ref. Point: A — Ambient Temperature C — Case Temperature					Continuous (DC) Collector Current					Output Capacitance, common-base. Shown without distinction: C _{cb} — Collector-Base Capacitance C _{re} — Common-Emitter Reverse Transfer Capacitance
					Rated Minimum Collector-Emitter Voltage Subscript letter identifies base termination listed below in order of preference. SUBSCRIPT: 0 — V _{CEO} , open					

Plastic-Encapsulated Multiple Transistors (continued)

Table 10. Plastic-Encapsulated Multiple Transistors — Quad

The following table is a listing of the most popular multiple devices available in the plastic DIP package. These devices are available in NPN, PNP, and NPN/PNP configurations. (See note.)

Device	ID	PD Watts One Die Only	V _{CEO} Volts	I _C Amp Max	hFE Min	@ I _C	f _T MHz Min	C _{ob} pF Max	hFE1	ΔV _{BE}	G _p	NF	@ f
									hFE2	mV Max	dB Min	dB Max	dB Typ ⁽¹⁾
									t _{on} ns Max	t _{off} ns Max	V _{CE} (sat) Volts Max	@ I _C	I _C

Case 646-06 — TO-116

MPQ2222A	NA	0.65	40	0.5	100	150 m	200	8.0	35 ⁽¹⁾	285 ⁽¹⁾	0.3	10	150 m
MPQ2369	NS	0.5	15	0.5	40	10 m	450	4.0	9.0 ⁽¹⁾	15 ⁽¹⁾	0.25	10	10 m
MPQ2483	NA	0.625	40	0.05	150	1.0 m	50					3.0(1)	AUD
MPQ2484	NA	0.625	40	0.05	300	1.0 m	50					2.0(1)	AUD
MPQ2907A	PA	0.65	60	0.6	100	150 m	200	8.0	45 ⁽¹⁾	180 ⁽¹⁾	0.4	10	150 m
MPQ3467	PS	0.75	40	1.0	20	500 m	125	25	40	90	0.5	10	500 m
MPQ3725	NS	1.0	40	1.0	25	500 m	250	10	35	60	0.45	10	500 m
MPQ3762	PS	0.75	40	1.5	35	150 m	150	15	50	120	0.55	10	500 m
MPQ3798	PA	0.625	40	0.05	150	0.1 m	60	4.0				3.0(1)	AUD
MPQ3799	PA	0.625	60	0.05	300	0.1 m	60	4.0				2.0(1)	AUD
MPQ3904	NG	0.5	40	0.2	75	10 m	250	4.0	37 ⁽¹⁾	136 ⁽¹⁾	0.2	10	10 m
MPQ3906	PG	0.5	40	0.2	75	10 m	200	4.5	43 ⁽¹⁾	155 ⁽¹⁾	0.25	10	10 m
MPQ6001	CG	0.65	30	0.5	40	150 m	200	8.0	30 ⁽¹⁾	225 ⁽¹⁾	0.4	10	150 m
MPQ6002	CG	0.65	30	0.5	100	150 m	200	8.0	30 ⁽¹⁾	225 ⁽¹⁾	0.4	10	150 m
MPQ6100A	CA	0.5	45	0.05	150	1.0 m	50	4.0				4.0(1)	AUD
MPQ6426	ND	0.5	30	0.5	10K	100 m	125	8.0	—	—	1.5	10	100 m
MPQ6502	CG	0.65	30	0.5	100	150 m	200	8.0	30 ⁽¹⁾	225 ⁽¹⁾	0.4	10	150 m
MPQ6600A1	CA	0.5	45	0.05	150	1.0 m	50	4.0	0.8	20	0.25	10	1.0 m
MPQ6700	CA	0.5	40	0.2	70	10 m	200	4.5			0.25	10	1.0 m
MPQ6842	CA	0.75	40	0.5	70	10 m	300	4.5	45	150	0.15	10	0.5 m
MPQ7043	NA	0.75	250	0.5	25	1.0 m	50	5.0			0.5	10	20 m
MPQ7042	NA	0.75	200	0.5	25	1.0 m	50	5.0			0.5	10	20 m
MPQ7051	CG	0.75	150	0.5	25	1.0 m	50	6.0			0.7	10	20 m
MPQ7093	PA	0.75	250	0.5	25	1.0 m	50	5.0			0.5	10	20 m

Table 11. Plastic-Encapsulated Multiple Transistors — Quad Surface Mount

The following table is a listing of the most popular multiple devices available in the plastic SOIC surface mount package. These devices are available in NPN, PNP, and NPN/PNP configurations.

Device	V _{(BR)CEO}	V _{(BR)CBO}	hFE @ I _C		f _T @ I _C	
			Min	mA	MHz Min	mA

Case 751B-05 — SO-16

MMPQ2222A	40	75	40	500	200	20
MMPQ2369	15	40	20	100	450	10
MMPQ2907A	50	60	50	500	200	50
MMPQ3467	40	40	20	500	125	50
MMPQ3725	40	60	25	500	250	50
MMPQ3904	40	60	75	10	250	10
MMPQ3906	40	40	75	10	200	10
MMPQ6700(12)	40	40	70	10	200	10

(1) Typical

(12) NPN/PNP

NOTE: Some columns show 2 different types of data indicated by either **bold** or *italic* typefaces. See key and headings.

Devices listed in bold, italic are Motorola preferred devices.

Plastic-Encapsulated Surface Mount Transistors

This section of the selector guide lists the small-signal plastic devices that are available for surface mount applications. These devices are encapsulated with the latest state-of-the-art mold compounds that enhance reliability and exhibit excellent performance in high temperature and high humidity environments. This package offers higher power dissipation capability for small-signal applications.

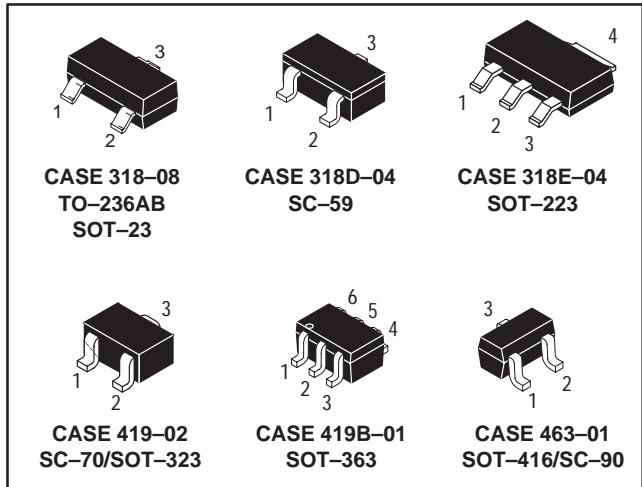


Table 12. Plastic-Encapsulated Surface Mount General-Purpose Transistors

The following tables are a listing of small-signal general-purpose transistors in the SOT-23, SC-59, SOT-223, SC-70, SC-90, and SOT-363 surface mount packages. These devices are intended for small-signal amplification for DC, audio, and lower RF frequencies. They also have applications as oscillators and general-purpose, low voltage switches.

Pinout: 1-Base, 2-Emitter, 3-Collector

Devices are listed in order of descending breakdown voltage.

Device	Marking	$V_{(BR)CEO}$	$h_{FE} @ I_C$			f_T MHz Min
			Min	Max	mA	

Case 318-08 — TO-236AB (SOT-23) — NPN

<i>BC846ALT1</i>	1A	65	110	220	2.0	100
<i>BC846BLT1</i>	1B	65	200	450	2.0	100
BC817-16LT1	6A	45	100	250	100	200
BC817-25LT1	6B	45	160	400	100	200
BC817-40LT1	6C	45	250	600	100	200
<i>BC847ALT1</i>	1E	45	110	220	2.0	100
<i>BC847BLT1</i>	1F	45	200	450	2.0	100
<i>BC847CLT1</i>	1G	45	420	800	2.0	100
<i>MMBT2222ALT1</i>	1P	40	100	300	150	200
<i>MMBT3904LT1</i>	1AM	40	100	300	10	300
<i>MMBT4401LT1</i>	2X	40	100	300	150	250
<i>BC848ALT1</i>	1J	30	110	220	2.0	100
<i>BC848BLT1</i>	1K	30	200	450	2.0	100
<i>BC848CLT1</i>	1L	30	420	800	2.0	100

Case 318-08 — TO-236AB (SOT-23) — PNP

<i>BC856ALT1</i>	3A	65	125	250	2.0	100
<i>BC856BLT1</i>	3B	65	220	475	2.0	100
<i>MMBT2907ALT1</i>	2F	60	100	300	150	200
BC807-16LT1	5A	45	100	250	100	200
<i>BC807-25LT1</i>	5B	45	160	400	100	200
<i>BC807-40LT1</i>	5C	45	250	600	100	200
<i>BC857ALT1</i>	3E	45	125	250	2.0	100
<i>BC857BLT1</i>	3F	45	220	475	2.0	100
<i>MMBT3906LT1</i>	2A	40	100	300	10	250
<i>MMBT4403LT1</i>	2T	40	100	300	150	200
<i>BC858ALT1</i>	3J	30	125	250	2.0	100
<i>BC858BLT1</i>	3K	30	220	475	2.0	100
<i>BC858CLT1</i>	3L	30	420	800	2.0	100

Devices listed in bold, italic are Motorola preferred devices.

Plastic-Encapsulated Surface Mount Transistors (continued)

Table 12. Plastic-Encapsulated Surface Mount General-Purpose Transistors (continued)

Pinout: 1-Base, 2-Emitter, 3-Collector

Devices are listed in order of descending breakdown voltage.

Device	Marking	V(BR)CEO	hFE @ IC			f _T MHz Min
			Min	Max	mA	
Case 318D-04 — SC-59 — NPN						
<i>MSD601-RT1</i>	YR	25	210	340	2.0	150 ⁽¹⁾
MSD601-ST1	YS	25	290	460	2.0	150 ⁽¹⁾
<i>MSD602-RT1</i>	WR	25	120	240	150	200 ⁽¹⁾
MSD1328-RT1	1DR	20	200	350	500	200 ⁽¹⁾
Case 318D-04 — SC-59 — PNP						
<i>MSB709-RT1</i>	AR	25	210	340	2.0	100 ⁽¹⁾
<i>MSB710-RT1</i>	CR	25	120	240	150	200 ⁽¹⁾
Case 419-02 — SC-70/SOT-323 —NPN						
<i>BC818WT1</i>	6I	45	100	600	100	—
<i>BC818-25WT1</i>	6F	45	160	400	100	—
<i>BC818-40WT1</i>	6G	45	250	600	100	—
<i>BC846AWT1</i>	1A	65	110	220	2.0	100
<i>BC846BWT1</i>	1B	65	200	450	2.0	100
<i>BC847AWT1</i>	1E	45	110	220	2.0	100
<i>BC847BWT1</i>	1F	45	200	450	2.0	100
<i>BC847CWT1</i>	1G	45	420	800	2.0	100
<i>BC848AWT1</i>	1J	30	110	220	2.0	100
<i>BC848BWT1</i>	1K	30	200	450	2.0	100
<i>BC848CWT1</i>	1L	30	420	800	2.0	100
<i>MMBT2222AWT1</i>	1P	40	100	300	150	300
<i>MMBT3904WT1</i>	AM	40	100	300	10	300
<i>MSC3930-BT1</i>	VB	20	70	140	1.0	150
<i>MSD1819A-RT1</i>	ZR	50	210	340	2.0	—
Case 419-02 — SC-70/SOT-323 —PNP						
<i>BC808-25WT1</i>	5F	45	160	400	100	—
<i>BC808-40WT1</i>	6F	45	250	600	100	—
<i>BC856AWT1</i>	3A	65	125	250	2.0	100
<i>BC856BWT1</i>	3B	65	220	475	2.0	100
<i>BC857AWT1</i>	3E	45	125	250	2.0	100
<i>BC857BWT1</i>	3F	45	220	475	2.0	100
<i>BC858AWT1</i>	3J	30	110	220	2.0	100
<i>BC858BWT1</i>	3K	30	200	450	2.0	100
<i>BC858CWT1</i>	3L	30	420	800	2.0	100
<i>MMBT2907AWT1</i>	20	60	100	300	150	200
<i>MMBT3906WT1</i>	2A	40	100	300	10	250
<i>MSB1218A-RT1</i>	BR	45	210	340	2.0	—
Case 419B-01 — SOT-363 — Dual NPN						
<i>MBT3904DW1T1</i>	MA	40	100	300	10	300
<i>MBT3904DW9T1</i>	MB	40	100	300	10	300
Case 419B-01 — SOT-363 — Dual PNP						
<i>MBT3906DW1T1</i>	A2	-40	100	300	10	250
<i>MBT3906DW9T1</i>	A3	-40	100	300	10	250

(1) Typical

Devices listed in bold, italic are Motorola preferred devices.

Plastic-Encapsulated Surface Mount Transistors (continued)

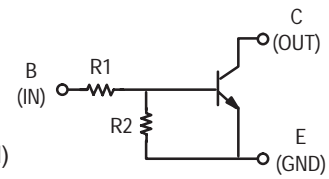


Table 12. Plastic-Encapsulated Surface Mount General-Purpose Transistors (continued)

Pinout: 1-Base, 2-Emitter, 3-Collector

Devices are listed in order of descending breakdown voltage.

Device	Marking	$V_{(BR)CEO}$	$h_{FE} @ I_C$			f_T MHz Min
			Min	Max	mA	
Case 419B-01 — SOT-363 — Dual Combination NPN and PNP						
<i>MBT3946DW1T1</i>	46	40	100	300	10	250
Case 463-01 — SOT-416/SC-90 — NPN						
<i>2SC4617</i>	B9	50	120	560	1.0	180
Case 463-01 — SOT-416/SC-90 — PNP						
<i>2SA1774</i>	F9	50	120	560	1.0	140

Table 13. Plastic-Encapsulated Surface Mount Bias Resistor Transistors for General Purpose Applications

Pinout: 1-Base, 2-Emitter, 3-Collector

These devices include bias resistors on the semiconductor chip with the transistor. See the BRT diagram for orientation of resistors.

Device		Marking		$V_{(BR)CEO}$ Volts (Min)	$h_{FE} @ I_C$		I_C mA Max	R_1 Ohm	R_2 Ohm
NPN	PNP	NPN	PNP		Min	mA			
Case 318D-04 — SC-59									
<i>MUN2211T1</i>	<i>MUN2111T1</i>	8A	6A	50	35	5.0	100	10K	10K
<i>MUN2212T1</i>	<i>MUN2112T1</i>	8B	6B	50	60	5.0	100	22K	22K
<i>MUN2213T1</i>	<i>MUN2113T1</i>	8C	6C	50	80	5.0	100	47K	47K
<i>MUN2214T1</i>	<i>MUN2114T1</i>	8D	6D	50	80	5.0	100	10K	47K
<i>MUN2215T1</i>	<i>MUN2115T1</i>	8E	6E	50	160	5.0	100	10K	∞
<i>MUN2216T1</i>	<i>MUN2116T1</i>	8F	6F	50	160	5.0	100	4.7K	∞
<i>MUN2230T1</i>	<i>MUN2130T1</i>	8G	6G	50	3.0	5.0	100	1.0K	1.0K
<i>MUN2231T1</i>	<i>MUN2131T1</i>	8H	6H	50	8.0	5.0	100	2.2K	2.2K
<i>MUN2232T1</i>	<i>MUN2132T1</i>	8J	6J	50	15	5.0	100	4.7K	4.7K
<i>MUN2233T1</i>	<i>MUN2133T1</i>	8K	6K	50	80	5.0	100	4.7K	47K
<i>MUN2234T1</i>	<i>MUN2134T1</i>	8L	6L	50	80	5.0	100	22K	47K
Case 318-08 — TO-236AB (SOT-23)									
<i>MMUN2211LT1</i>	<i>MMUN2111LT1</i>	A8A	A6A	50	35	5.0	100	10K	10K
<i>MMUN2212LT1</i>	<i>MMUN2112LT1</i>	A8B	A6B	50	60	5.0	100	22K	22K
<i>MMUN2213LT1</i>	<i>MMUN2113LT1</i>	A8C	A6C	50	80	5.0	100	47K	47K
<i>MMUN2214LT1</i>	<i>MMUN2114LT1</i>	A8D	A6D	50	80	5.0	100	10K	47K
<i>MMUN2215LT1</i>	<i>MMUN2115LT1</i>	A8E	A6E	50	160	5.0	100	10K	∞
<i>MMUN2216LT1</i>	<i>MMUN2116LT1</i>	A8F	A6F	50	160	5.0	100	4.7K	∞
<i>MMUN2230LT1</i>	<i>MMUN2130LT1</i>	A8G	A6G	50	3.0	5.0	100	1.0K	1.0K
<i>MMUN2231LT1</i>	<i>MMUN2131LT1</i>	A8H	A6H	50	8.0	5.0	100	2.2K	2.2K
<i>MMUN2232LT1</i>	<i>MMUN2132LT1</i>	A8J	A6J	50	15	5.0	100	4.7K	4.7K
<i>MMUN2233LT1</i>	<i>MMUN2133LT1</i>	A8K	A6K	50	80	5.0	100	4.7K	47K
<i>MMUN2234LT1</i>	<i>MMUN2134LT1</i>	A8L	A6L	50	80	5.0	100	22K	47K

Devices listed in bold, italic are Motorola preferred devices.

Plastic-Encapsulated Surface Mount Transistors (continued)

Table 13. Plastic-Encapsulated Surface Mount Bias Resistor Transistors for General Purpose Applications (continued)

Pinout: 1-Base, 2-Emitter, 3-Collector

Device		Marking		V(BR)CEO Volts (Min)	hFE @ IC		IC mA Max	R1 Ohm	R2 Ohm
NPN	PNP	NPN	PNP		Min	mA			

Case 419-02 — SC-70/SOT-323

<i>MUN5211T1</i>	<i>MUN5111T1</i>	8A	6A	50	35	5.0	50	10K	10K
<i>MUN5212T1</i>	<i>MUN5112T1</i>	8B	6B	50	60	5.0	50	22K	22K
<i>MUN5213T1</i>	<i>MUN5113T1</i>	8C	6C	50	80	5.0	50	47K	47K
<i>MUN5214T1</i>	<i>MUN5114T1</i>	8D	6D	50	80	5.0	50	10K	47K
<i>MUN5215T1</i>	<i>MUN5115T1</i>	8E	6E	50	160	5.0	50	10K	∞
<i>MUN5216T1</i>	<i>MUN5116T1</i>	8F	6F	50	160	5.0	50	4.7K	∞
<i>MUN5230T1</i>	<i>MUN5130T1</i>	8G	6G	50	3.0	5.0	50	1.0K	1.0K
<i>MUN5231T1</i>	<i>MUN5131T1</i>	8H	6H	50	8.0	5.0	50	2.2K	2.2K
<i>MUN5232T1</i>	<i>MUN5132T1</i>	8J	6J	50	15	5.0	50	4.7K	4.7K
<i>MUN5233T1</i>	<i>MUN5133T1</i>	8K	6K	50	80	5.0	50	4.7K	47K
<i>MUN5234T1</i>	<i>MUN5134T1</i>	8L	6L	50	80	5.0	50	22K	47K

Case 419B-01 — SOT-363 Duals

<i>MUN5211DW1T1</i>	<i>MUN5111DW1T1</i>	7A	8A	50	35	5.0	100	10K	10K
<i>MUN5212DW1T1</i>	<i>MUN5112DW1T1</i>	7B	8B	50	60	5.0	100	22K	22K
<i>MUN5213DW1T1</i>	<i>MUN5113DW1T1</i>	7C	8C	50	80	5.0	100	47K	47K
<i>MUN5214DW1T1</i>	<i>MUN5114DW1T1</i>	7D	8D	50	80	5.0	100	10K	47K
<i>MUN5215DW1T1</i>	<i>MUN5115DW1T1</i>	7E	8E	50	160	5.0	100	10K	∞
<i>MUN5216DW1T1</i>	<i>MUN5116DW1T1</i>	7F	8F	50	160	5.0	100	4.7K	∞
<i>MUN5230DW1T1</i>	<i>MUN5130DW1T1</i>	7G	8G	50	3.0	5.0	100	1.0K	1.0K
<i>MUN5231DW1T1</i>	<i>MUN5131DW1T1</i>	7H	8H	50	8.0	5.0	100	2.2K	2.2K
<i>MUN5232DW1T1</i>	<i>MUN5132DW1T1</i>	7J	8J	50	15	5.0	100	4.7K	4.7K
<i>MUN5233DW1T1</i>	<i>MUN5133DW1T1</i>	7K	8K	50	80	5.0	100	4.7K	47K
<i>MUN5234DW1T1</i>	<i>MUN5134DW1T1</i>	7L	8L	50	80	5.0	100	22K	47K
<i>MUN5235DW1T1</i>	<i>MUN5135DW1T1</i>	7M	8M	50	80	5.0	100	2.2K	47K

Device	Marking	V(BR)CEO	hFE @ IC		IC mA Max	R1 Ohm	R2 Ohm
			Min	mA			

Case 419B-01 — SOT-363 — Dual Combination NPN and PNP

<i>MUN5311DW1T1</i>	11	50	35	5.0	100	10K	10K
<i>MUN5312DW1T1</i>	12	50	60	5.0	100	22K	22K
<i>MUN5313DW1T1</i>	13	50	80	5.0	100	47K	47K
<i>MUN5314DW1T1</i>	14	50	80	5.0	100	10K	47K
<i>MUN5315DW1T1</i>	15	50	160	5.0	100	10K	∞
<i>MUN5316DW1T1</i>	16	50	160	5.0	100	4.7K	∞
<i>MUN5330DW1T1</i>	3X	50	3.0	5.0	100	1.0K	1.0K
<i>MUN5331DW1T1</i>	31	50	8.0	5.0	100	2.2K	2.2K
<i>MUN5332DW1T1</i>	32	50	15	5.0	100	4.7K	4.7K
<i>MUN5333DW1T1</i>	33	50	80	5.0	100	4.7K	47K
<i>MUN5334DW1T1</i>	34	50	80	5.0	100	22K	47K
<i>MUN5335DW1T1</i>	35	50	80	5.0	100	2.2K	47K

Device		Marking		V(BR)CEO Volts (Min)	hFE @ IC		IC mA Max	R1 Ohm	R2 Ohm
NPN	PNP	NPN	PNP		Min	mA			

Case 463-01 — SOT-416/SC-90

<i>DTC114TE</i>	—	94	—	50	100	1.0	100	10K	∞
<i>DTC114YE</i>	<i>DTA114YE</i>	69	59	50	80	5.0	100	10K	47K
—	<i>DTA143EE</i>	—	43	50	15	5.0	100	4.7K	4.7K

Devices listed in bold, italic are Motorola preferred devices.

Plastic–Encapsulated Surface Mount Transistors (continued)

Table 14. Plastic–Encapsulated Surface Mount Switching Transistors

The following tables are a listing of devices intended for high–speed, low saturation voltage, switching applications. These devices have very fast switching times and low output capacitance for optimized switching performance.

Pinout: 1–Base, 2–Emitter, 3–Collector

Device	Marking	Switching Time (ns)		$V_{(BR)CEO}$	$h_{FE} @ I_C$			f_T MHz Min
		t_{on}	t_{off}		Min	Max	mA	
Case 318–08 — TO–236AB (SOT–23) — NPN								
<i>MMBT2369LT1</i>	M1J	12	18	15	20	—	100	—
<i>MMBT2369ALT1</i>	1JA	12	18	15	20	—	100	—
<i>BSV52LT1</i>	B2	12	18	12	40	120	10	400
Case 318–08 — TO–236AB (SOT–23) — PNP								
<i>MMBT3640LT1</i>	2J	25	35	12	20	—	50	500

Table 15. Plastic–Encapsulated Surface Mount VHF/UHF Amplifiers, Mixers, Oscillators

The following table is a listing of devices intended for small–signal RF amplifier applications to VHF/UHF frequencies. These devices may also be used as VHF/UHF oscillators and mixers.

Pinout: 1–Base, 2–Emitter, 3–Collector

Device	Marking	$V_{(BR)CEO}$	$C_{cb}^{(13)}$ pF Max	$f_T @ I_C$	
				GHz Min	mA
Case 318–08 — TO–236AB (SOT–23) — NPN					
<i>MMBTH10LT1</i>	3EM	25	0.7	0.65	4.0
<i>MMBT918LT1</i>	M3B	15	1.7 ⁽¹⁴⁾	0.6	4.0
<i>MMBTH24LT1</i>	M3A	30	0.45	0.4	8.0
Case 318–08 — TO–236AB (SOT–23) — PNP					
<i>MMBTH81LT1</i>	3D	20	0.85	0.6	5.0
<i>MMBTH69LT1</i>	M3J	15	0.35 ⁽¹³⁾	2.0	10
Pinout: 1–Emitter, 2–Base, 3–Collector					
Case 318D–04 — SC–59 — NPN					
<i>MSC2295–BT1</i>	VB	20	1.5 ⁽¹³⁾	0.15	1.0
<i>MSC2295–CT1</i>	VC	20	1.5 ⁽¹³⁾	0.15	1.0
<i>MSC3130T1</i>	1S	10	—	1.4	5.0
Case 318D–04 — SC–59 — PNP					
<i>MSA1022–CT1</i>	EC	20	2.0 ⁽¹³⁾	0.15	1.0

⁽¹³⁾ C_{re}

⁽¹⁴⁾ C_{ob}

Devices listed in bold, italic are Motorola preferred devices.

Plastic-Encapsulated Surface Mount Transistors (continued)

Table 16. Plastic-Encapsulated Surface Mount Choppers

The following table is a listing of small-signal devices intended for chopper applications where a higher than normal $V_{(BR)CEO}$ is required in the circuit application.

Pinout: 1-Base, 2-Emitter, 3-Collector

Device	Marking	$V_{(BR)CEO}$	$V_{(BR)EBO}$	$h_{FE} @ I_C$		
				Min	Max	mA
Case 318-08 — TO-236AB (SOT-23) — PNP						
<i>MMBT404ALT1</i>	2N	35	25	30	400	12

Table 17. Plastic-Encapsulated Surface Mount Darlingtonts

The following table is a listing of small-signal devices that have very high h_{FE} and input impedance characteristics. These devices utilize monolithic, cascade transistor construction.

Pinout: 1-Base, 2-Emitter, 3-Collector

Devices are listed in order of descending h_{FE} .

Device	Marking	$V_{(BR)CES}$	$V_{CE(sat)}$ Volts Max	$h_{FE} @ I_C$		
				Min	Max	mA
Case 318-08 — TO-236AB (SOT-23) — NPN						
<i>MMBTA14LT1</i>	1N	30	1.5	20K	—	100
<i>MMBTA13LT1</i>	1M	30	1.5	10K	—	100
Case 318-08 — TO-236AB (SOT-23) — PNP						
<i>MMBTA64LT1</i>	2V	30	1.5	20K	—	100

Table 18. Plastic-Encapsulated Surface Mount Low-Noise Transistors

The following table is a listing of small-signal devices intended for low noise applications in the audio range. These devices exhibit good linearity and are candidates for hi-fi and instrumentation equipment.

Pinout: 1-Base, 2-Emitter, 3-Collector

Devices are listed in order of ascending NF.

Device	Marking	NF dB Typ	$V_{(BR)CEO}$	$h_{FE} @ I_C$			f_T MHz Min
				Min	Max	mA	
Case 318-08 — TO-236AB (SOT-23) — NPN							
<i>MMBT5089LT1</i>	1R	2.0 ⁽¹⁵⁾	25	400	—	10	50
<i>MMBT2484LT1</i>	1U	3.0 ⁽¹⁵⁾	60	—	800	10	—
<i>MMBT6428LT1</i>	1KM	3.0	50	250	—	10	100
<i>MMBT6429LT1</i>	1L	3.0	45	500	—	10	100
Case 318-08 — TO-236AB (SOT-23) — PNP							
<i>MMBT5087LT1</i>	2Q	2.0 ⁽¹⁵⁾	50	250	—	10	40

⁽¹⁵⁾ Max

Devices listed in bold, italic are Motorola preferred devices.

Plastic-Encapsulated Surface Mount Transistors (continued)

Table 19. Plastic-Encapsulated Surface Mount High-Voltage Transistors

The following table is a listing of small-signal high-voltage devices designed for direct line operation requiring high voltage breakdown and relatively low current capability.

Pinout: 1-Base, 2-Emitter, 3-Collector

Devices are listed in order of descending breakdown voltage.

Device	Marking	$V_{(BR)CEO}$	$h_{FE@ I_C}$			f_T MHz Min
			Min	Max	mA	
Case 318-08 — TO-236AB (SOT-23) — NPN						
<i>MMBT6517LT1</i>	1Z	350	15	—	100	40
<i>MMBTA42LT1</i>	1D	300	40	—	30	50
<i>MMBT5551LT1</i>	G1	160	30	—	50	100
Case 318-08 — TO-236AB (SOT-23) — PNP						
<i>MMBT6520LT1</i>	2Z	350	15	—	100	40
<i>MMBTA92LT1</i>	2D	300	25	—	30	50
<i>MMBT5401LT1</i>	2L	150	50	—	50	100

Table 20. Plastic-Encapsulated Surface Mount Drivers

The following is a listing of small-signal devices intended for medium voltage driver applications at fairly high current levels.

Pinout: 1-Base, 2-Emitter, 3-Collector

Device	Marking	$V_{(BR)CEO}$	$V_{CE(sat)}$	$V_{BE(sat)}$	$h_{FE@ I_C}$		
					Min	Max	mA
Case 318-08 — TO-236AB (SOT-23) — NPN							
<i>MMBTA06LT1</i>	1GM	80	0.25	—	100	—	100
<i>BSS64LT1</i>	AM	80	0.15	—	20	—	10
Case 318-08 — TO-236AB (SOT-23) — PNP							
<i>BSS63LT1</i>	T1	100	-0.25	-0.90	30	—	25
<i>MMBTA56LT1</i>	2GM	80	-0.25	—	100	—	100

The following devices are designed to conserve energy. They offer ultra-low collector saturation voltage.

Case 318-08 — TO-236AB (SOT-23) — PNP

<i>MMBT1010LT1</i>	GLP	15	0.1	1.1	300	600	100
Case 318-03 — SC-59 — PNP							
<i>MSD1010T1</i>	GLP	15	0.1	1.1	300	600	100

Table 21. Plastic-Encapsulated Surface Mount General Purpose Amplifiers

Pinout: 1-Base, 2-Collector, 3-Emitter, 4-Collector

Device	Marking	$V_{(BR)CEO}$	$h_{FE@ I_C}$		
			Min	Max	mA
Case 318E-04 — SOT-223 — NPN					
<i>BCP56T1</i>	BH	80	40	250	150
Case 318E-04 — SOT-223 — PNP					
Pinout: 1-Gate, 2-Drain, 3-Source, 4-Drain					
<i>BCP53T1</i>	AH	80	40	25	150

Devices listed in bold, italic are Motorola preferred devices.

Plastic-Encapsulated Surface Mount Transistors (continued)

Table 22. Plastic-Encapsulated Surface Mount Switching Transistors

Pinout: 1-Base, 2-Collector, 3-Emitter, 4-Collector

Device	Marking	t _{on}	t _{off}	V _{(BR)CEO}	h _{FE}		f _T	
					Min	Max	@ I _C (mA)	Min (MHz)
Case 318E-04 — SOT-223 — NPN								
<i>PZT2222AT1</i>	P1F	35	285	40	100	300	20	300
Case 318E-04 — SOT-223 — PNP								
<i>PZT2907AT1</i>	P2F	45	100	60	100	300	50	200

Table 23. Plastic-Encapsulated Surface Mount Darlingtonts

Pinout: 1-Base, 2-Collector, 3-Emitter, 4-Collector

Device	Marking	V _{(BR)CER}	V _{CE(sat)} Max (V)	h _{FE}		@ I _C (mA)
				Min	Max	
Case 318E-04 — SOT-223 — NPN						
<i>BSP52T1</i>	AS3	80	1.3	2000	—	500
<i>PZTA14T1</i>	P1N	30	1.5	20k	—	100
Case 318E-04 — SOT-223 — PNP						
<i>BSP62T1</i>	BS3	90	1.3	2000	—	500
<i>PZTA64T1</i>	P2V	30	1.5	20k	—	100

Table 24. Plastic-Encapsulated Surface Mount High-Voltage Transistors

Pinout: 1-Base, 2-Collector, 3-Emitter, 4-Collector

Device	Marking	V _{(BR)CEO}	h _{FE}		f _T	
			Min	Max	@ I _C (mA)	Min (MHz)
Case 318E-04 — SOT-223 — NPN						
<i>BSP19AT1</i>	SP19A	350	40	—	20	70
<i>PZTA42T1</i>	P1D	300	40	—	10	50
<i>BF720T1</i>	BF720	250	50	—	10	60
Case 318E-04 — SOT-223 — PNP						
<i>PZTA96T1</i>	ZTA96	450	50	150	10	50
<i>PZTA92T1</i>	P2D	300	40	—	10	50
<i>BSP16T1</i>	BSP16	300	30	150	10	15
<i>BF721T1</i>	BF721	250	50	—	10	60

Table 25. Plastic-Encapsulated Surface Mount High Current Transistors

Pinout: 1-Base, 2-Collector, 3-Emitter, 4-Collector

Device	Marking	V _{(BR)CEO}	V _{CE(sat)} Volts	h _{FE} @ I _C		
				Min	Max	mA
Case 318E-04 — SOT-223 — NPN						
<i>PZT651T1</i>	651	60	0.5	75	—	1000
<i>BCP68T1</i>	CA	20	0.5	60	—	1000
Case 318E-04 — SOT-223 — PNP						
<i>PZT751T1</i>	ZT751	60	0.5	75	—	1000
<i>BCP69T1</i>	CE	20	0.5	60	—	1000

Devices listed in bold, italic are Motorola preferred devices.

Field-Effect Transistors

JFETs

JFETs operate in the depletion mode. They are available in both P- and N-channel and are offered in both Through-hole and Surface Mount packages. Applications include general-purpose amplifiers, switches and choppers, and RF amplifiers and mixers. These devices are economical and very rugged. The drain and source are interchangeable on many typical FETs.

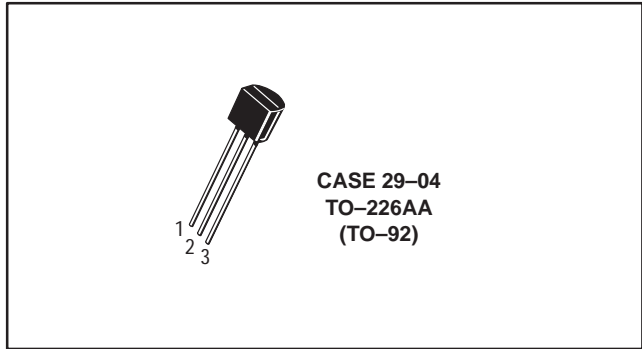


Table 26. JFET Low-Frequency/Low-Noise

The following table is a listing of small-signal JFETs intended for low-noise applications in the audio range. These devices exhibit good linearity and are candidates for hi-fi and instrumentation equipment.

Device	$R_e Y_{fs} @ f$		$R_e Y_{os} @ f$		C_{iss} pF Max	C_{rss} pF Max	$V_{(BR)GSS}$ $V_{(BR)GDO}$ Volts Min	$V_{GS(off)}$ Volts		I_{DSS} mA		Style
	mmho Min	kHz	μ mho Max	kHz				Min	Max	Min	Max	
Case 29-04 — TO-226AA (TO-92) — N-Channel												
J202	—	—	—	—	—	—	40	0.8	4.0	0.9	4.5	5
2N5457	1.0	1.0	50	1.0	7.0	3.0	25	0.5	6.0	1.0	5.0	5
2N5458	1.5	1.0	50	1.0	7.0	3.0	25	1.0	7.0	2.0	9.0	5

Case 29-04 — TO-226AA (TO-92) — P-Channel

2N5460	1.0	1.0	75	1.0	7.0	2.0	40	0.75	6.0	1.0	5.0	7
2N5461	1.5	1.0	75	1.0	7.0	2.0	40	1.0	7.5	2.0	9.0	7
2N5462	2.0	1.0	75	1.0	7.0	2.0	40	1.8	9.0	4.0	16	7

Table 27. JFET High-Frequency Amplifiers

The following is a listing of small-signal JFETs that are intended for hi-frequency applications. These are candidates for VHF/UHF oscillators, mixers and front-end amplifiers.

Device	$R_e Y_{fs} @ f$		$R_e Y_{os} @ f$		C_{iss} pF Max	C_{rss} pF Max	NF @ $R_G = 1K$		$V_{(BR)GSS}$ $V_{(BR)GDO}$ Volts Min	$V_{GS(off)}$ Volts		I_{DSS} mA		Style
	mmho Min	MHz	μ mho Max	MHz			dB Max	f MHz		Min	Max	Min	Max	
Case 29-04 — TO-226AA (TO-92) — N-Channel														
MPF102	1.6	100	200	100	7.0	3.0	—	—	25	—	8.0	2.0	20	5
2N5484	2.5	100	75	100	5.0	1.0	3.0	100	25	0.3	3.0	1.0	5.0	5
2N5485	3.0	400	100	400	5.0	1.0	4.0	400	25	0.5	4.0	4.0	10	5
2N5486	3.5	400	100	400	5.0	1.0	4.0	400	25	2.0	6.0	8.0	20	5
J308	12 ⁽¹⁾	100	250 ⁽¹⁾	100	7.5	2.5	1.5 ⁽¹⁾	100	25	1.0	6.5	12	60	5
J309	12 ⁽¹⁾	100	250 ⁽¹⁾	100	7.5	2.5	1.5 ⁽¹⁾	100	25	1.0	4.0	12	30	5
J310	12 ⁽¹⁾	100	250 ⁽¹⁾	100	7.5	2.5	1.5 ⁽¹⁾	100	25	2.0	6.5	24	60	5

(1) Typical

Devices listed in bold, italic are Motorola preferred devices.

JFETs (continued)

Table 28. JFET Switches and Choppers

The following is a listing of JFETs intended for switching and chopper applications.

Device	R _{DS(on)} @ I _D		V _{GS(off)} Volts		I _{DSS} mA		V _{(BR)GSS} V _{(BR)GDO} Volts Min	C _{iss} pF Max	C _{rss} pF Max	t _{on} ns Max	t _{off} ns Max	Style
	Ω Max	mA	Min	Max	Min	Max						
Case 29-04 — TO-226AA (TO-92) — N-Channel												
J112	50	—	1.0	5.0	5.0	—	35	28	5.0	—	—	5
<i>MPF4392</i>	60	—	—	—	25	75	30	10	3.5	15	35	5
2N5639	60	1.0	—	(8.0) ⁽¹⁾	25	—	30	10	4.0	—	—	5
<i>MPF4393</i>	100	—	—	(12) ⁽¹⁾	5.0	30	30	10	3.5	15	55	5
2N5640	100	1.0	—	(6.0) ⁽¹⁾	5.0	—	30	10	4.0	18	45	5
2N5555	150	—	—	1.0 ⁽¹⁶⁾	15	—	25	5.0	1.2	10	25	5
J110	18	—	0.5	4.0	10	—	25	—	—	—	—	5

⁽¹⁾ Typical

⁽¹⁶⁾ V_{GS(f)}

Devices listed in bold, italic are Motorola preferred devices.



TMOS FETs

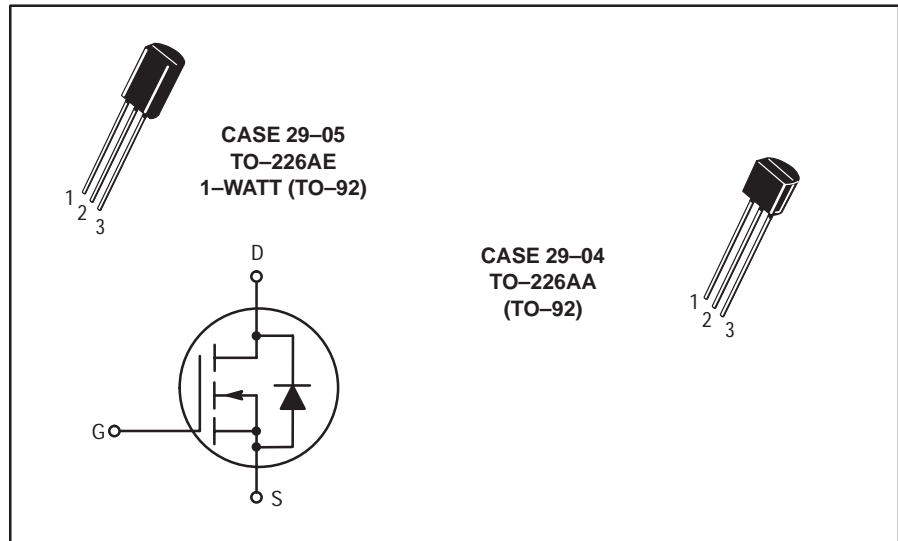


Table 29. TMOS Switches and Choppers

The following is a listing of small-signal TMOS devices that are intended for switching and chopper applications. These devices offer low $R_{DS(on)}$ characteristics.

Device	$R_{DS(on)}$ @ I_D		$V_{GS(th)}$ Volts		$V_{(BR)DSS}$ Volts Min	C_{iss} pF Max	C_{rss} pF Max	t_{on} ns Max	t_{off} ns Max	Style
	Ω Max	A	Min	Max						
Case 29-05 — TO-226AE (1-WATT TO-92) — N-Channel										
MPF930	1.4	1.0	1.0	3.5	35	70(1)	20(1)	15	15	22
MPF960	1.7	1.0	1.0	3.5	60	70(1)	20(1)	15	15	22
MPF6659	1.8	1.0	0.8	2.0	35	30(1)	4(1)	5.0	5.0	22
MPF990	2.0	1.0	1.0	3.5	90	70(1)	20(1)	15	15	22
MPF6660	3.0	1.0	0.8	2.0	60	30(1)	4(1)	5.0	5.0	22
MPF6661	4.0	1.0	0.8	2.0	90	30(1)	4(1)	5.0	5.0	22
MPF910	5.0	0.5	0.3	2.5	60	—	—	—	—	22
VN10LM	5.0	0.5	0.8	2.5	60	60	5.0	10	10	22
Case 29-04 — TO-226AA (TO-92) — N-Channel										
VN0300L	1.2	1.0	0.8	2.5	60	100	25	30	30	22
2N7000	5.0	0.5	0.8	3.0	60	60	5.0	10	10	22
BS170	5.0	0.2	0.8	3.0	60	25(1)	3.0(1)	10	10	30
VN0610LL	5.0	0.5	0.8	2.5	60	60	5.0	10	10	22
VN2406L	6.0	0.5	0.8	2.0	240	125	20	8.0	23	22
BS107A	6.4	0.25	1.0	3.0	200	60(1)	6.0(1)	15	15	30
2N7008	7.5	0.5	1.0	2.5	60	50	5.0	20	20	22
VN2222LL	7.5	0.5	0.6	2.5	60	60	5.0	10	10	22
VN2410L	10	0.5	0.8	2.0	240	125	20	8.0	23	22
BS107	14	0.2	1.0	3.0	200	60(1)	6.0(1)	15	15	30

(1) Typical

Devices listed in bold, italic are Motorola preferred devices.

Surface Mount FETs

This section contains the FET plastic packages available for surface mount applications. Most of these devices are the most popular metal-can and insertion type parts carried over to the new surface mount packages.

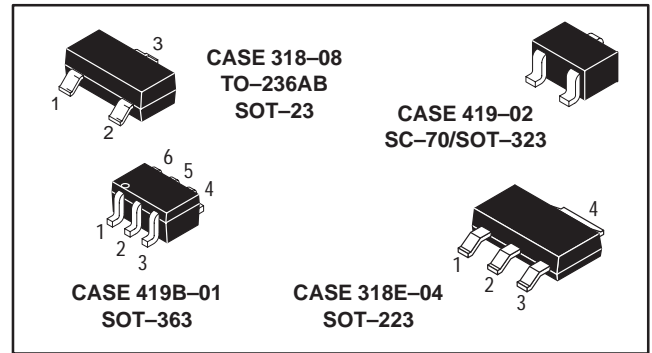


Table 30. Surface Mount RF JFETs

The following is a list of surface mount FETs which are intended for VHF/UHF RF amplifier applications.

Pinout: 1–Drain, 2–Source, 3–Gate

Device	Marking	NF		$Y_{fs} @ V_{DS}$			$V_{(BR)GSS}$	Style
		dB Typ	f MHz	mmhos Min	mmhos Max	Volts		
Case 318–08 — TO–236AB (SOT–23) — N–Channel								
<i>MMBFJ309LT1</i>	6U	1.5	450	10	20	10	25	10
<i>MMBFJ310LT1</i>	6T	1.5	450	8.0	18	10	25	10
<i>MMBFU310LT1</i>	M6C	1.5	450	10	18	10	25	10
<i>MMBF4416LT1</i>	M6A	2 ⁽³⁾	100	4.5	7.5	15	30	10
<i>MMBF5484LT1</i>	M6B	2.0	100	3.0	6.0	15	25	10

Case 419B–01 — SOT–363 — Dual N–Channel

<i>MBF4416DW1T1</i>	M6	2.0	100	4.5	7.5	15	30	7
---------------------	----	-----	-----	-----	-----	----	----	---

⁽³⁾ Max

Table 31. Surface Mount General–Purpose JFETs

The following table is a listing of surface mount small–signal general purpose FETs. These devices are intended for small–signal amplification for DC, audio, and lower RF frequencies. They also have applications as oscillators and general–purpose, low–voltage switches.

Pinout: 1–Drain, 2–Source, 3–Gate

Device	Marking	$V_{(BR)GSS}$	$Y_{fs} @ V_{DS}$			I_{DSS}		Style
			mmhos Min	mmhos Max	Volts	mA Min	mA Max	
Case 318–08 — TO–236AB (SOT–23) — N–Channel								
<i>MMBF5457LT1</i>	6D	25	1.0	5.0	15	1.0	5.0	10
Case 318–08 — TO–236AB (SOT–23) — P–Channel								
<i>MMBF5460LT1</i>	M6E	40	1.0	4.0	15	1.0	5.0	10
Case 419B–01 — SOT–363 — Dual N–Channel								
<i>MBF5457DW1T1</i>	6D	25	1.0	5.0	15	1.0	5.0	7

⁽³⁾ Max

Devices listed in bold, italic are Motorola preferred devices.

Surface Mount FETs (continued)

Table 32. Surface Mount Choppers/Switches JFETs

The following is a listing of small-signal surface mount JFET devices intended for switching and chopper applications.

Pinout: 1–Drain, 2–Source, 3–Gate

Device	Marking	R _{DS(on)} Ohms Max	t _{off} ns Max	V _{(BR)GSS}	V _{GS(off)}		I _{DSS}		Style
					Volts Min	Volts Max	mA Min	mA Max	
Case 318–08 — TO–236AB (SOT–23) — N–Channel									
<i>MMBF4391LT1</i>	6J	30	20	30	–4.0	–10	50	150	10
<i>MMBF4392LT1</i>	6K	60	35	30	–2.0	–5.0	25	75	10
<i>MMBF4393LT1</i>	6G	100	50	30	–0.5	–3.0	5.0	30	10
Case 318–08 — TO–236AB (SOT–23) — P–Channel									
<i>MMBFJ175LT1</i>	6W	125	—	30	3.0	6.0	7.0	60	10
<i>MMBFJ177LT1</i>	6Y	300	—	30	0.8	2.5	1.5	20	10

Table 33. TMOS FETs

The following is a listing of small-signal surface mount TMOS FETs which exhibit low R_{DS(on)} characteristics.

Pinout: 1–Gate, 2–Source, 3–Drain

Device	Marking	R _{DS(on)} @ I _D		V _{DSS}	V _{GS(th)}		Switching Time		Style
		Ohm	mA		Volts Min	Volts Max	t _{on} ns	t _{off} ns	
Case 318–08 — TO–236AB (SOT–23) — N–Channel									
<i>MMBF170LT1</i>	6Z	5.0	200	60	0.8	3.0	10	10	21
<i>BSS123LT1</i>	SA	6.0	100	100	0.8	2.8	20	40	21
<i>BSS138LT1</i>	J1	3.5	200	50	0.5	1.5	20	20	21
<i>2N7002LT1</i>	702	7.5	500	60	1.0	2.5	20	20	21
<i>MMBF0201NLT1</i>	N1	1.0	300	20	1.0	2.4	2.5	15	21
<i>MGSF1N02LT1</i>	N2	0.085	1200	20	1.0	2.4	2.5	16	21
<i>MGSF1N03LT1</i>	N3	0.09	1200	30	1.0	2.4	2.5	16	21
Case 318–08 — TO–236 (SOT–23) — P–Channel									
<i>BSS84LT1</i>	PD	6.0	100	50	1.0	2.4	2.5	16	21
<i>MMBF0202PLT1</i>	P3	1.4	200	20	1.0	2.0	2.5	16	21
<i>MGSF1P02LT1</i>	PC	0.35	1500	20	1.0	2.4	2.5	16	21
<i>MGSF1P02ELT1</i>	PE	0.16	1500	20	0.7	1.2	2.5	15	21

Pinout: 1–Gate, 2–Drain, 3–Source, 4–Drain

Device	Marking	R _{DS(on)}		V _{DSS}	V _{GS(th)}		Switching Time		Style
		Ohm	mA		Volts Min	Volts Max	t _{on} ns	t _{off} ns	
Case 318E–04 — SOT–223 — N–Channel									
<i>MMFT960T1</i>	FT960	1.7	1000	60	1.0	3.5	15	15	3
<i>MMFT6661T1</i>	T6661	4.0	1000	90	0.8	2.0	5.0	5.0	3
<i>MMFT2406T1</i>	T2406	10	200	240	0.8	2.0	—	—	3
<i>MMFT107T1</i>	FT107	14	200	200	1.0	3.0	15	15	3
Case 419–02 — SC–70/SOT–323 — N–Channel									
<i>MMBF2201NT1</i>	N1	1.0	300	20	1.0	2.4	2.5	15	8
Case 419–02 — SC–70/SOT–323 — P–Channel									
<i>MMBF2202PT1</i>	P3	2.2	200	20	1.0	2.4	2.5	16	8

Devices listed in bold, italic are Motorola preferred devices.

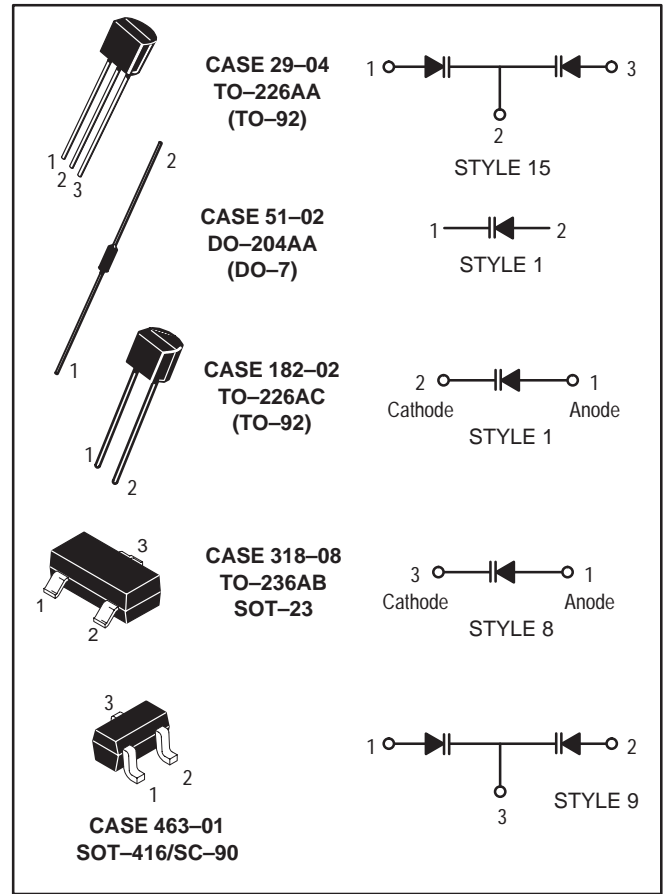
Tuning and Switching Diodes

Tuning Diodes — Abrupt Junction

Motorola supplies voltage-variable capacitance diodes serving the entire range of frequencies from HF through UHF. Used in RF receivers and transmitters, they have a variety of applications, including:

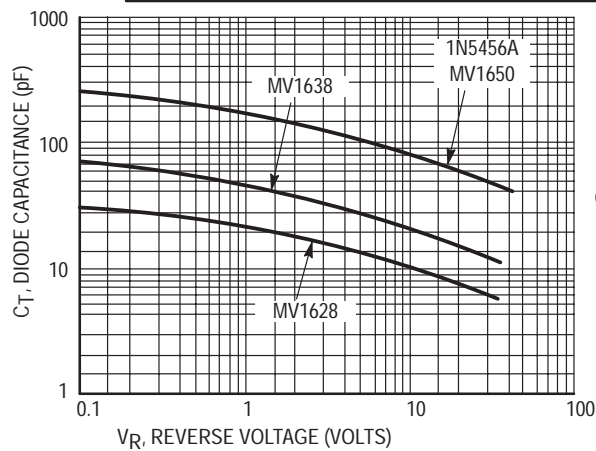
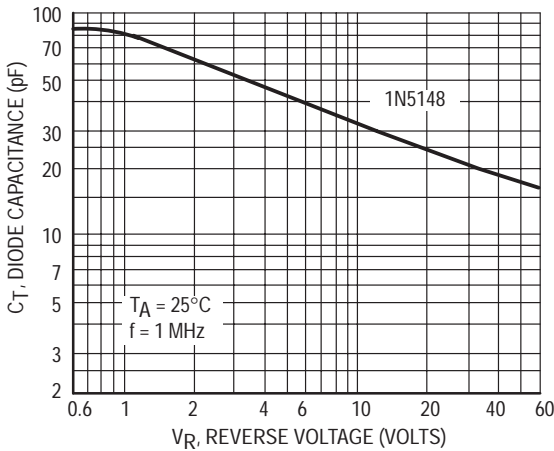
- Phase-locked loop tuning systems
- Local oscillator tuning
- Tuned RF preselectors
- RF filters
- RF phase shifters
- RF amplifiers
- Automatic frequency control
- Video filters and delay lines
- Harmonic generators
- FM modulators

Two families of devices are available: Abrupt Junction and Hyper Abrupt Junction. The Abrupt Junction family includes devices suitable for virtually all tuned-circuit and narrow-range tuning applications throughout the spectrum.

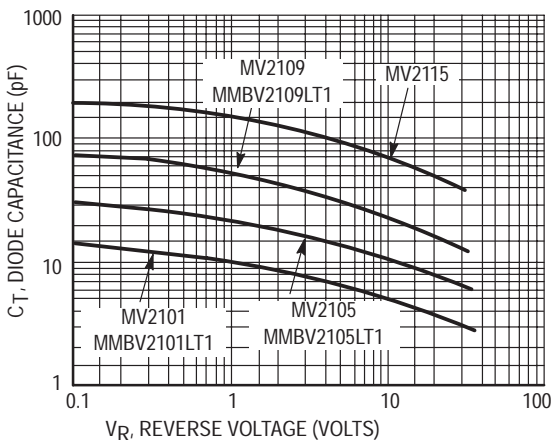


Typical Characteristics

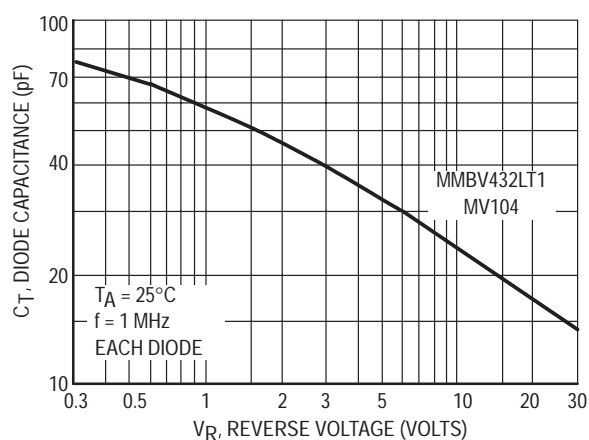
Diode Capacitance versus Reverse Voltage



(See Tables 34 Thru 36)



(See Tables 37 and 38)



(See Table 39)

Tuning Diodes — Abrupt Junction (continued)

**Table 34. General-Purpose Glass Abrupt Tuning Diodes
High Q Capacitance Ratio @ 4.0 Volts/60 Volts**

The following is a listing of axial leaded, general-purpose, abrupt tuning diodes. These devices exhibit high Q characteristics.

Device(19)	C _T @ V _R = 4.0 V, 1.0 MHz			V _{(BR)R} Volts	Cap Ratio C4/C60 Min	Q 4.0 V, 50 MHz Min
	pF Min	pF Nominal	pF Max			
Case 51-02 — DO-204AA (DO-7)						
1N5148	42.3	47	51.7	60	3.2	200

**Table 35. General-Purpose Glass Abrupt Tuning Diodes
High Q Capacitance Ratio @ 2.0 Volts/30 Volts**

The following is a listing of axial leaded, general-purpose, abrupt tuning diodes. These devices exhibit very high Q characteristics.

Device(20)	C _T @ V _R = 4.0 V, 1.0 MHz			V _{R(BR)R} Volts	Cap Ratio C2/C30 Min	Q 4.0 V, 50 MHz Min
	pF Min	pF Nominal	pF Max			
Case 51-02 — DO-204AA (DO-7)						
1N5446ARL	16.2	18	19.8	30	2.6	350
1N5448ARL	19.8	22	24.2	30	2.6	350
1N5456A	90	100	110	30	2.7	175

(19)Suffix A = 10.0%

(20)Suffix B = 5.0%

**Table 36. General-Purpose Glass Abrupt Tuning Diodes
Capacitance Ratio @ 2.0 Volts/20 Volts**

The following is a listing of axial leaded, general-purpose, abrupt tuning diodes. These devices exhibit high Q characteristics.

Device	C _T @ V _R = 4.0 V, 1.0 MHz			V _{(BR)R} Volts	Cap Ratio C2/C20 Min	Q 4.0 V, 50 MHz Typ
	pF Min	pF Nominal	pF Max			
Case 51-02 — DO-204AA (DO-7)						
MV1626	10.8	12	13.2	20	2.0	300
MV1628	13.5	15	16.5	20	2.0	250
MV1630	16.2	18	19.8	20	2.0	250
MV1634	19.8	22	24.2	20	2.0	250
MV1638	29.7	33	36.3	20	2.0	200
MV1648	73.8	82	90.2	20	2.0	150
MV1650	90	100	110	20	2.0	150

**Table 37. General-Purpose Plastic Abrupt Tuning Diodes
Capacitance Ratio @ 2.0 Volts/30 Volts**

The following is a listing of plastic package, general-purpose, abrupt tuning diodes. These devices exhibit high Q characteristics.

Device	C _T @ V _R = 4.0 V, 1.0 MHz			V _{R(BR)R} Volts	Cap Ratio C4/C30 Min	Q 4.0 V, 50 MHz Typ
	pF Min	pF Nominal	pF Max			
Case 182-02 — TO-226AC (TO-92) — 2-Lead						
MV2101	6.1	6.8	7.5	30	2.5	400
MV2104	10.8	12	13.2	30	2.5	350
MV2105	13.5	15	16.5	30	2.5	350
MV2108	24.3	27	29.7	30	2.5	250
MV2109	29.7	33	36.3	30	2.5	200
MV2111	42.3	47	51.7	30	2.5	150
MV2115	90	100	110	30	2.6	100

Tuning Diodes — Abrupt Junction (continued)

**Table 38. Surface Mount Abrupt Tuning Diodes
Capacitance Ratio @ 2.0 Volts/30 Volts**

The following is a listing of surface mount abrupt junction tuning diodes intended for general-purpose variable capacitance circuit applications.

Device	C _T @ V _R = 4.0 V, 1.0 MHz			V _{R(BR)R} Volts	Cap Ratio C ₂ /C ₃₀ Min	Q 4.0 V, 50 MHz Typ
	pF Min	pF Nominal	pF Max			
Case 318-08 — DO-236AB (SOT-23)						
<i>MMBV2101LT1</i>	6.1	6.8	7.5	30	2.5	400
MMBV2103LT1	9.0	10	11	30	2.5	350
<i>MMBV2105LT1</i>	13.5	15	16.5	30	2.5	350
MMBV2107LT1	19.8	22	24.2	30	2.5	300
MMBV2108LT1	24.3	27	29.7	30	2.5	250
<i>MMBV2109LT1</i>	29.7	33	36.3	30	2.5	200

Table 39. Abrupt Tuning Diodes for FM Radio — Dual

The following is a listing of abrupt tuning diodes that are available as dual units in a single package.

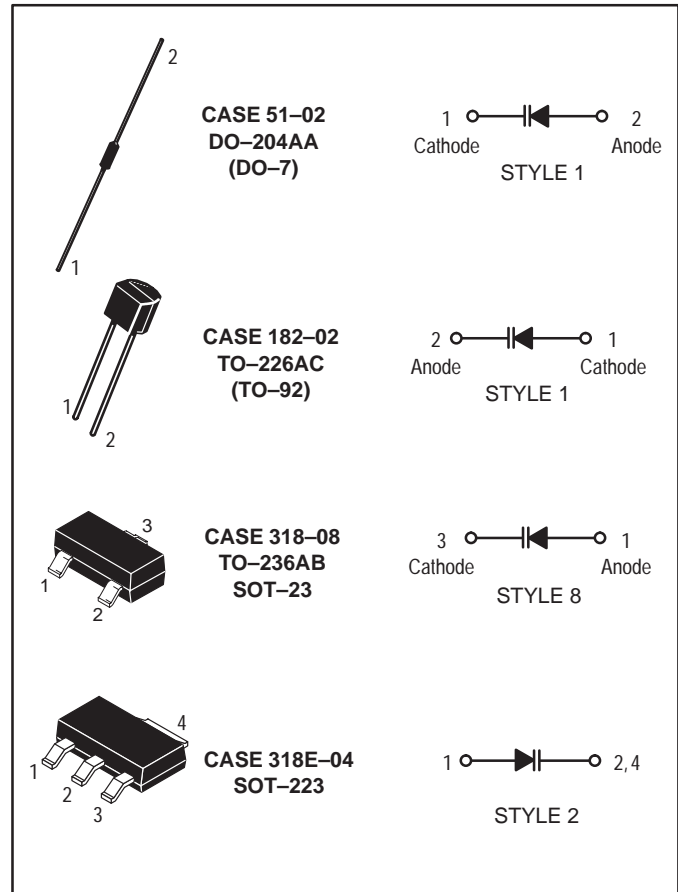
Device	C _T @ V _R ⁽²²⁾			Cap Ratio C ₃ /C ₃₀ Min	Q 3.0 V, 50 MHz Min	V _{(BR)R} Volts	Device Marking	Style
	pF Min	pF Max	Volts					
Case 29-04 — TO-226AA (TO-92)								
<i>MV104</i>	37	42	3.0	2.5	100	32	—	15
Case 318-08 — TO-236AB (SOT-23)								
<i>MMBV432LT1</i>	43	48.1	2.0	1.5 ⁽²¹⁾	100	14	M4B	9

⁽²¹⁾C₂/C₈

⁽²²⁾Each Diode

Tuning Diodes — Hyper–Abrupt Junction

The Hyper–Abrupt family exhibits higher capacitance, and a much larger capacitance ratio. It is particularly well suited for wider–range applications such as AM/FM radio and TV tuning.



Typical Characteristics

Diode Capacitance versus Reverse Voltage

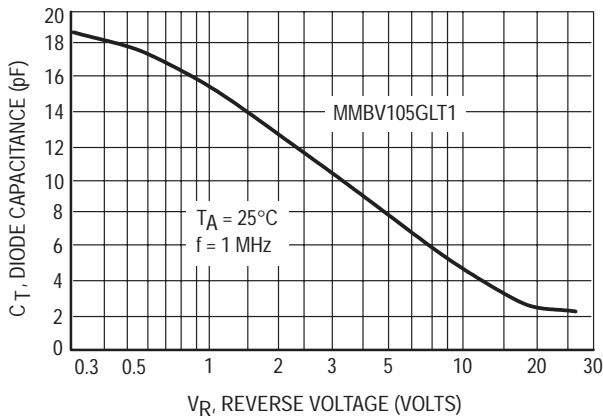


Figure 1. Diode Capacitance

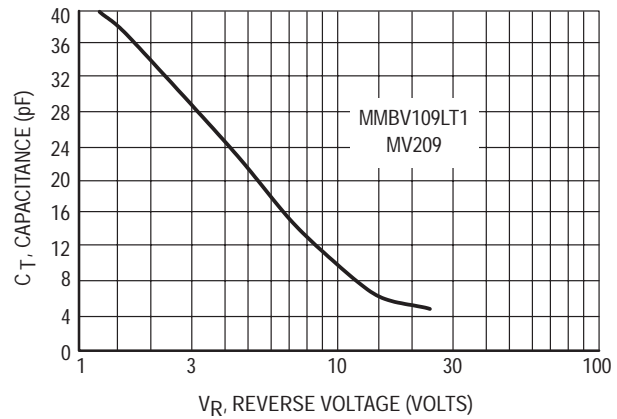


Figure 2. Diode Capacitance

Tuning Diodes — Hyper-Abrupt Junction (continued)

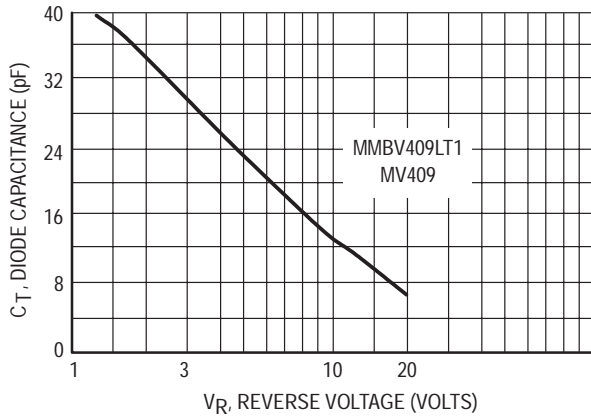


Figure 3. Diode Capacitance

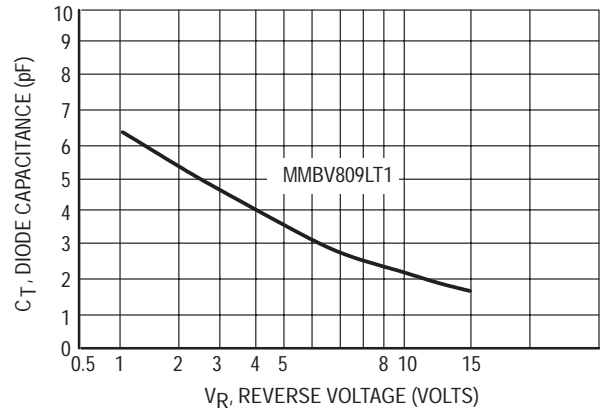


Figure 4. Diode Capacitance

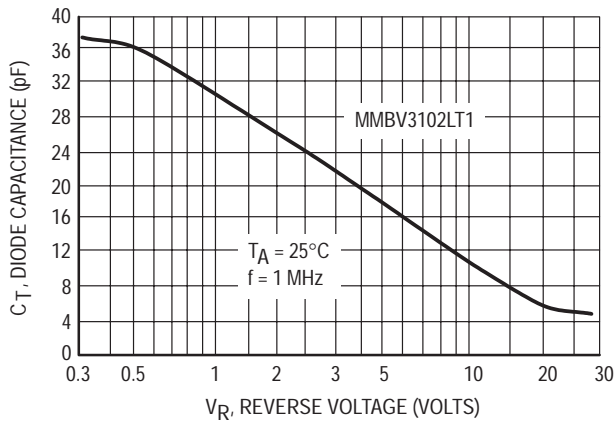


Figure 5. Diode Capacitance

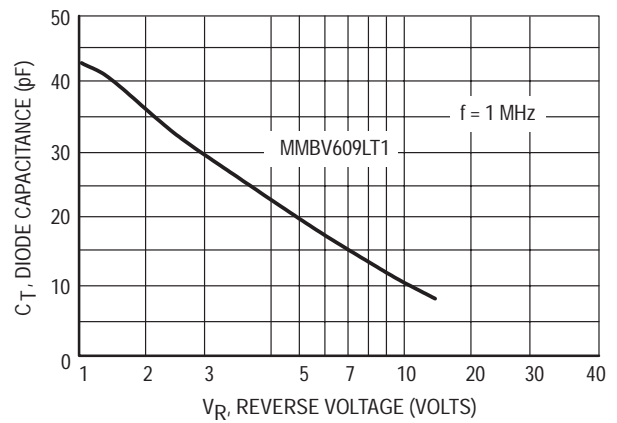


Figure 6. Diode Capacitance Each Die

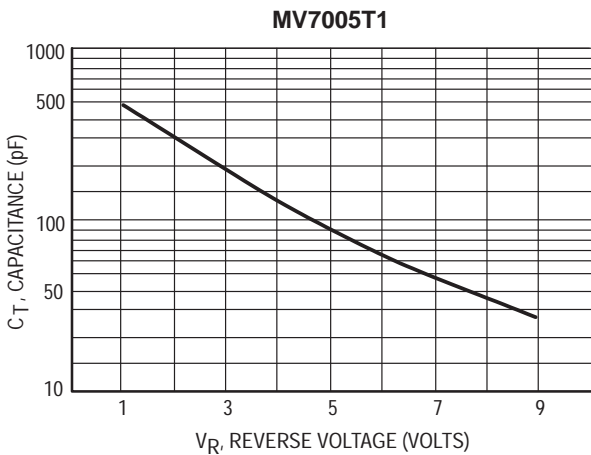


Figure 7. Capacitance versus Reverse Voltage

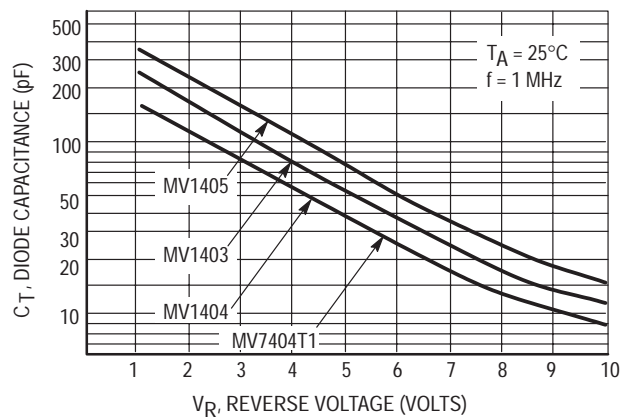


Figure 8. Diode Capacitance versus Reverse Voltage

Tuning Diodes — Hyper-Abrupt Junction (continued)

Table 40. Hyper-Abrupt Tuning Diodes for Telecommunications — Single

The following is a listing of hyper-abrupt tuning diodes intended for high frequency, FM radio, and TV tuner applications.

Device	C _T @ V _R (f = 1.0 MHz)			Cap Ratio @ V _R			Q		V _{(BR)R} Volts	Device Marking	Case Style	CV Curve Fig
	pF Min	pF Max	Volts	Min	Max	Volts	3.0 V Min	50 MHz Max				
Case 182-02 — TO-226AC (TO-92)												
<i>MV209</i>	26	32	3.0	5.0	6.5	3/25	200	—	30	—	1	2
<i>MV409</i>	26	32	3.0	1.5	2.0	3/8	200	—	20	—	1	3
Case 318-08 — TO-236AB (SOT-23)												
<i>MMBV105GLT1</i>	1.5	2.8	25	4.0	6.5	3/25	200	—	30	M4E	8	1
<i>MMBV109LT1</i>	26	32	3.0	5.0	6.5	3/25	200	—	30	M4A	8	2
<i>MMBV409LT1</i>	26	32	3.0	1.5	1.9	3/8	200	—	20	X5	8	3
<i>MMBV809LT1</i>	4.5	6.1	2.0	1.8	2.6	2/8	300	—	20	5K	8	4
<i>MMBV3102LT1</i>	20	25	3.0	4.5	—	3/25	200	—	30	M4C	8	5
Case 419-02 — SC-70/SOT-323												
<i>MBV109T1</i>	26	32	3.0	5.0	6.5	3/25	200	—	30	M4A	8	—

Table 41. Hyper-Abrupt Tuning Diodes for Communications — Dual

Device	C _T @ V _R (f = 1.0 MHz)			Cap Ratio @ V _R			Q		V _{(BR)R} Volts	Device Marking	Case Style	CV Curve Fig
	pF Min	pF Max	Volts	Min	Max	Volts	3.0 V Min	50 MHz Max				
Case 318-08 — TO-236AB (SOT-23)												
<i>MMBV609LT1</i>	26	32	3.0	1.8	2.4	3/8	250	—	20	5L	9	6

Table 42. Hyper-Abrupt High Capacitance Voltage Variable Diode — Surface Mount

The following are high capacitance voltage variable diodes intended for low frequency applications and circuits requiring large tuning capacitance.

Device	V _{(BR)R} Volts	I _R nA	C _T @ f = 1.0 MHz		Cap Ratio Min	Q Min	Style	CV Curve Figure
			Min pF	Max pF				
Case 318E-04 — SOT-223								
Pinout: 1—Anode, 2, 4—Cathode, 3—NC								
<i>MV7005T1</i>	15	100	400	520	12 ⁽²⁶⁾	150 ⁽²⁸⁾	2	8
<i>MV7404T1</i>	12	100	96	144	10 ⁽²⁷⁾	200 ⁽²⁹⁾	2	11

Table 43. Hyper-Abrupt High Capacitance Tuning Diodes — Axial Lead Glass Package

Device	C _T @ V _R			Cap Ratio C ₂ /C ₁₀ Min	Q 2.0 V, 1.0 MHz Min	V _{(BR)R} Volts	Style	CV Curve Figure
	pF Min	pF Max	Volts					
Case 51-02 — DO-204AA (DO-7)								
<i>MV1404</i>	96	144	2.0	10	200	12	1	11
<i>MV1403</i>	140	210	2.0	10	200	12	1	11
<i>MV1405</i>	200	300	2.0	10	200	12	1	11

⁽²⁶⁾ V_R = 1.0 V/V_R = 9.0 V

⁽²⁷⁾ V_R = 2.0 V/V_R = 10 V

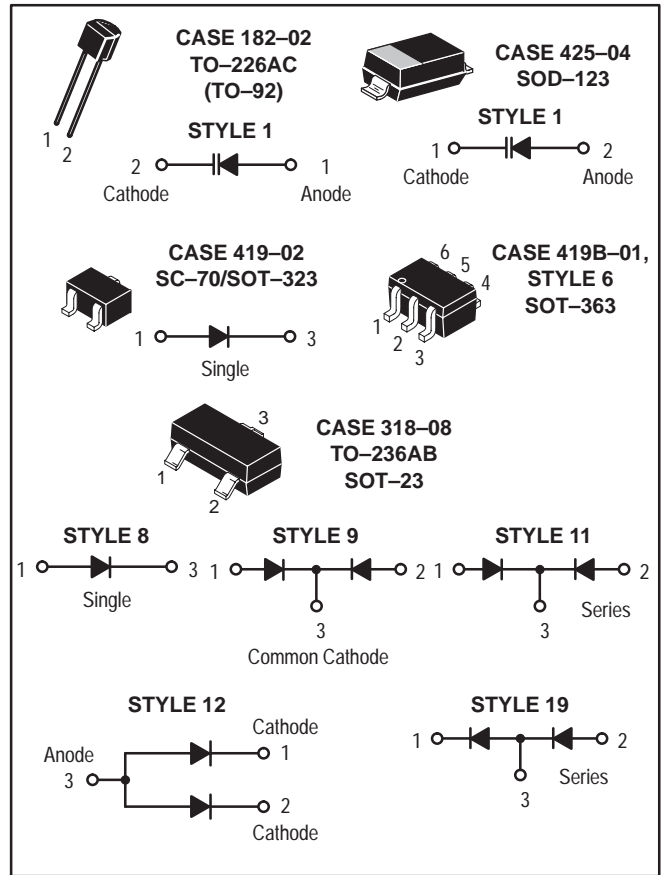
⁽²⁸⁾ V_R = 1.0 V, f = 1.0 MHz

⁽²⁹⁾ V_R = 2.0 V, f = 1.0 MHz

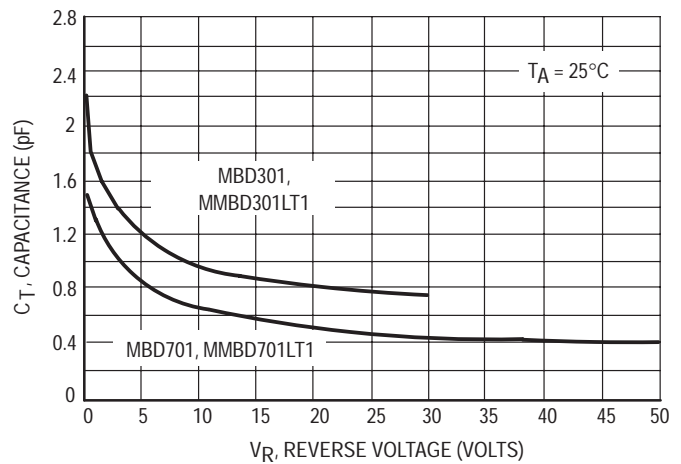
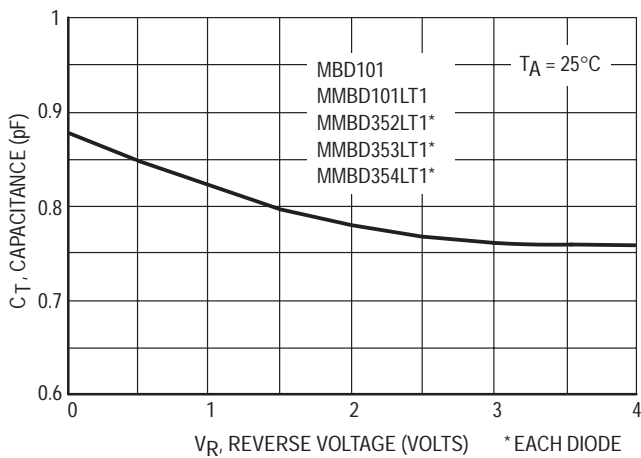
Devices listed in bold, italic are Motorola preferred devices.

Schottky Diodes

Schottky diodes are ideal for VHF and UHF mixer and detector applications as well as many higher frequency applications. They provide stable electrical characteristics by eliminating the point-contact diode presently used in many applications.



Typical Characteristics Capacitance versus Reverse Voltage



(See Table 44)

Devices listed in bold, italic are Motorola preferred devices.

Schottky Diodes (continued)

Table 44. Schottky Diodes

The following is a listing of Schottky diodes that exhibit low forward voltage drop for improved circuit efficiency.

Device	V _{(BR)R} Volts	C _T @ V _R pF Max	V _F @ 10 mA Volts Max	I _R @ V _R nA Max	Minority Lifetime pS (TYP)	Device Marking	Style
--------	-----------------------------	----------------------------------------------	----------------------------------------	----------------------------------------------	----------------------------------	-------------------	-------

Case 182-02 — TO-226AC (TO-92)

MBD701	70	1.0 @ 20 V	1.0	200 @ 35 V	15	—	1
MBD301	30	1.5 @ 15 V	0.6	200 @ 25 V	15	—	1
MBD101	7.0	1.0 @ 0 V	0.6	250 @ 3.0 V	—	—	1

Case 318-08 — TO-236AB (SOT-23) – Single

BAS40LT1	40	5.0 @ 1.0 V	0.5 @ 30 mA	1000 @ 25 V	—	B1	8
BAS40-04LT1	40	5.0 @ 1.0 V	0.5 @ 30 mA	1000 @ 25 V	—	—	12
BAS70LT1	70	2.0 @ 0 V	0.75	100 @ 50 V	—	BE	8
BAT54ALT1	30	10 @ 1.0 V	0.4	2000 @ 25 V	—	—	12
BAT54LT1	30	10 @ 1.0 V	0.4	2000 @ 25 V	—	LV3	8
BAT54SLT1	30	10 @ 1.0 V	0.4	2000 @ 25 V	—	LD3	11
MMBD701LT1	70	1.0 @ 20 V	1.0	200 @ 35 V	15	5H	8
MMBD301LT1	30	1.5 @ 15 V	0.6	200 @ 25 V	15	4T	8
MMBD101LT1	7.0	1.0 @ 0 V	0.6	250 @ 3.0 V	15	4M	8

Case 318-08 — TO-236AB (SOT-23) – Dual

BAS40-06LT1	40	5.0 @ 1.0 V	0.5 @ 30 mA	1000 @ 25 V	—	—	11
BAS70-04LT1 (23)	70	2.0 @ 0 V	0.75	100 @ 50 V	—	—	12
MMBD352LT1	7.0	1.0 @ 0 V	0.6	250 @ 3.0 V	15	M5G	11
MMBD353LT1	7.0	1.0 @ 0 V	0.6	250 @ 3.0 V	15	M4F	19
MMBD354LT1	7.0	1.0 @ 0 V	0.6	250 @ 3.0 V	15	M6H	9
MMBD355LT1	7.0	1.0 @ 0 V	0.6	250 @ 3.0 V	15	MJ1	12
MMBD452LT1	30	1.5 @ 1.5 V	0.6	200 @ 25 V	15	5N	11

Case 425-04 — (SOD-123)

BAT54T1	30	10 @ 1.0 V	0.4	2000 @ 25 V	—	—	1
MMSD701T1	70	1.0 @ 20 V	1.2	0.2 @ 35 V	15	5H	1
MMSD301T1	30	1.5 @ 15 V	0.6	0.2 @ 25 V	15	4T	1
MMSD101T1	4	1.0 @ 0 V	0.6	0.25 @ 3 V	15	4M	1

Case 419-02 — (SC-70/SOT-323) – Single

BAT54WT1	30	10 @ 1.0 V	0.4	2000 @ 25 V	—	—	2
MMBD330T1	30	1.5 @ 15 V	0.6	0.2 @ 25 V	—	4T	2
MMBD770T1	70	1.0 @ 20 V	1.0	0.2 @ 35 V	—	5H	2

Case 419-02 — (SC-70/SOT-323) – Dual

BAT54SWT1	30	10 @ 1.0 V	0.4	2000 @ 25 V	—	—	9
MMBD352WT1	7.0	1.0 @ 0 V	0.6	250 @ 3.0 V	—	M5	9
MMBD717LT1 (23)	20	2.5 @ 1.0 V	0.37 @ 1 mA	0.2 @ 10 V	—	B3	2

(23) Common Anode

Case 419B-01 — SOT-363 – Duals

Device	Marking	V _{(BR)R}		I _R		V _F			C _T (30) Max (pF)	t _{rr} Max (ns)	Case Style
		Min Volts	@ I _{BR} (μA)	Max (μA)	@ V _R Volts	Min Volts	Max Volts	@ I _F (mA)			
MBD54DWT1	BL	30	10	2.0	25	—	0.32	1.0	1.0	5.0	6
MBD110DWT1	M4	7.0	10	200	25	—	0.6	1.0	1.0	—	6
MBD330DWT1	T4	30	10	200	25	—	0.4	1.0	1.5	—	6
MBD770DWT1	H5	70	10	200	25	—	0.5	1.0	1.0	—	6

(30) V_R = 0 V, f = 1.0 MHz

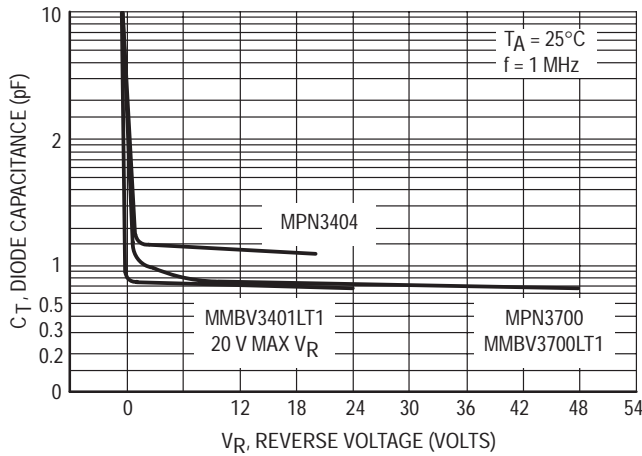
Devices listed in bold, italic are Motorola preferred devices.

Switching Diodes

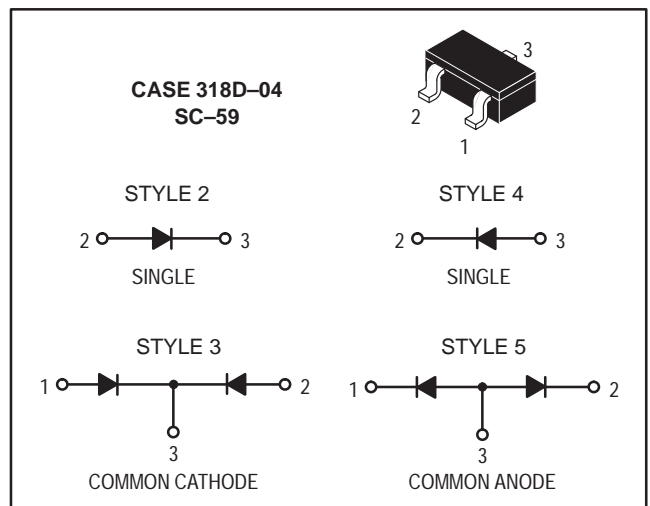
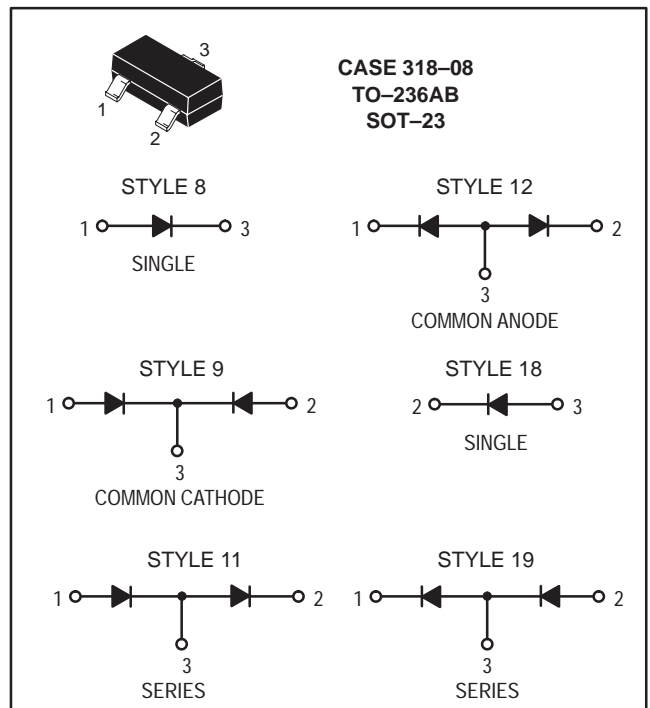
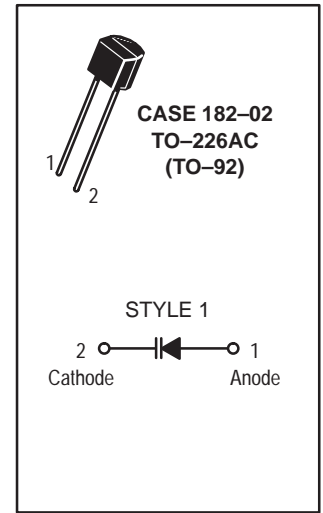
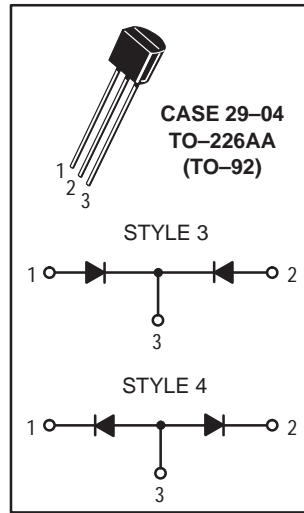
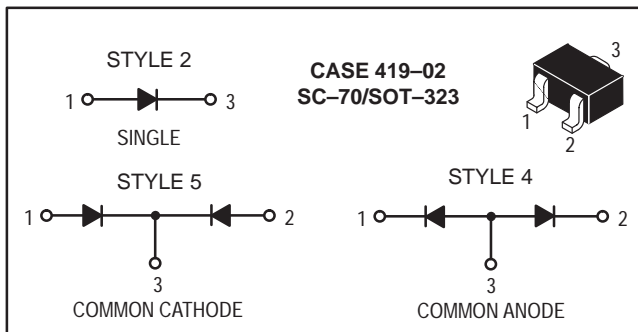
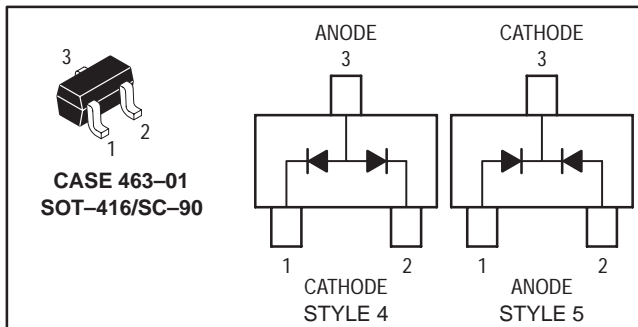
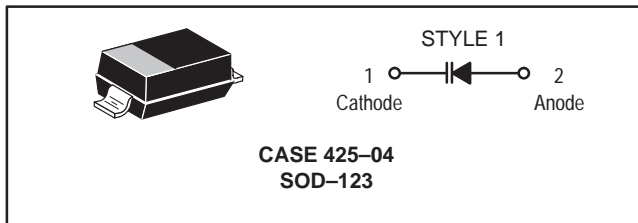
Small-signal switching diodes are intended for low current switching and steering applications. Hot-Carrier, PIN and general-purpose diodes allow a wide selection for specific application requirements.

Typical Characteristics

Capacitance versus Reverse Voltage



(See Table 45)



Switching Diodes (continued)

Table 45. PIN Switching Diodes

The following PIN diodes are designed for VHF band switching and general-purpose low current switching applications.

Device	V _{(BR)R} Volts Min	C _T @ V _R @ 1.0 MHz		I _R @ V _R μA Max	Series Resistance Ohm Max	Device Marking	Style
		pF Max	Volts				
Case 182-02 — TO-226AC (TO-92)							
MPN3700 <i>MPN3404</i>	200 20	1.0 2.0	20 15	0.1 @ 150 0.1 @ 25 V	1.0 @ 10 mA 0.85 @ 10 mA	— —	1 1
Case 318-08 — TO-236AB (SOT-23)							
MMBV3700LT1 <i>MMBV3401LT1</i>	200 35	1.0 1.0	20 20	0.1 @ 150 0.1 @ 25 V	1.0 @ 10 mA 0.7 @ 10 mA	4R 4D	8 8

Table 46. General-Purpose Signal and Switching Diodes — Single

The following is a listing of small-signal switching diodes in surface mount packages. These diodes are intended for low current switching and signal steering applications.

Device	Marking	V _{(BR)R}		I _R		V _F			C _T (³⁰)	t _{rr}	Case Style
		Min Volts	@ I _{BR} (μA)	Max (μA)	@ V _R Volts	Min Volts	Max Volts	@ I _F (mA)	Max (pF)	Max (ns)	
Case 318-08 — TO-236AB (SOT-23)											
<i>BAS21LT1</i>	JS	250	100	0.1	200	—	1.0	100	5.0	50	8
<i>MMBD914LT1</i>	5D	100	100	5.0	75	—	1.0	10	4.0	4.0	8
<i>BAS16LT1</i>	A6	75	100	1.0	75	—	1.0	50	2.0	6.0	8
<i>MMBD6050LT1</i>	5A	70	100	0.1	50	0.85	1.1	100	2.5	4.0	8
<i>BAL99LT1</i>	JF	70	100	2.5	70	—	1.0	50	1.5	6.0	18
Case 318D-04 — SC-59											
<i>M1MA151AT1</i>	MA	40	100	0.1	35	—	1.2	100	2.0	3.0	4
<i>M1MA151KT1</i>	MH	40	100	0.1	35	—	1.2	100	2.0	3.0	2
Case 419-02 — SC-70/SOT-323											
<i>BAS16WT1</i>	A6	75	1.0	0.02	20	—	1.25	150	2.0	6.0	2
<i>M1MA141KT1</i>	MH	40	100	0.1	35	—	1.2	100	2.0	3.0	2
<i>M1MA142KT1</i>	MI	80	100	0.1	75	—	1.2	100	2.0	3.0	2
<i>M1MA174T1</i>	J6	100	100	5.0	75	—	1.0	10	4.0	4.0	2
Case 425-04 — SOD-123											
<i>MMSD914T1</i>	5D	100	100	5.0	75	—	1.0	10	4.0	4.0	1
<i>MMSD71RKT1</i>	6S	—	—	0.5	80	—	1.2	100	2.0	4.0	1

(³⁰) V_R = 0 V, f = 1.0 MHz

Devices listed in bold, italic are Motorola preferred devices.

Switching Diodes (continued)

Table 47. General-Purpose Signal and Switching Diodes — Dual

The following is a listing of small-signal switching diodes in surface mount packages. These diodes are intended for low current switching and signal steering applications.

Device	Marking	$V_{(BR)R}$		I_R		V_F			$C_T^{(30)}$	t_{rr}	Case Style
		Min Volts	@ I_{BR} (μA)	Max (μA)	@ V_R Volts	Min Volts	Max Volts	@ I_F (mA)	Max (pF)	Max (ns)	

Case 318-08 — TO-236AB (SOT-23)

MMBD7000LT1	M5C	100	100	1.0	50	0.75	1.1	100	1.5	4.0	11
MMBD2836LT1	A2	75	100	0.1	50	—	1.0	10	4.0	4.0	12
MMBD2838LT1	A6	75	100	0.1	50	—	1.0	10	4.0	4.0	9
BAV70LT1	A4	70	100	5.0	70	—	1.0	50	1.5	6.0	9
BAV99LT1	A7	70	100	2.5	70	—	1.0	50	1.5	4.0	11
BAW56LT1	A1	70	100	2.5	70	—	1.0	50	2.0	6.0	12
MMBD6100LT1	5BM	70	100	0.1	50	0.85	1.1	100	2.5	4.0	9
BAV74LT1	JA	50	5.0	0.1	50	—	1.0	100	2.0	4.0	9
MMBD2835LT1	A3	35	100	0.1	30	—	1.0	10	4.0	4.0	12
MMBD2837LT1	A5	35	100	0.1	30	—	1.0	10	4.0	4.0	9

Case 318D-04 — SC-59

M1MA151WAT1	MN	40	100	0.1	35	—	1.2	100	15	10	5
M1MA151WKT1	MT	40	100	0.1	35	—	1.2	100	2.0	3.0	3

Case 419-02 — SC-70/SOT-323

M1MA142WKT1	MU	80	100	0.1	75	—	1.2	100	2.0	3.0	5
M1MA142WAT1	MO	80	100	0.1	75	—	1.2	100	15	10	4
BAW56WT1	A1	70	100	2.5	70	—	1.0	50	2.0	6.0	4
BAV70WT1	A4	70	100	5.0	70	—	1.0	50	1.5	6.0	5
BAV99WT1	A7	70	100	2.5	70	—	1.0	50	1.5	6.0	9
BAV99RWT1	F7	70	100	2.5	70	—	1.0	50	1.5	6.0	10
M1MA141WKT1	MT	40	100	0.1	35	—	1.2	100	2.0	3.0	5
M1MA141WAT1	MN	40	100	0.1	35	—	1.2	100	15	10	4

Case 463-01 — SOT-416/SC-90 (Common Anode)

DAP222	P9	80	100	100	70	—	1.2	100	3.5	4.0	4
---------------	----	----	-----	-----	----	---	-----	-----	-----	-----	---

Case 463-01 — SOT-416/SC-90 (Common Cathode)

DAN222	N9	80	100	100	70	—	1.2	100	3.5	4.0	5
---------------	----	----	-----	-----	----	---	-----	-----	-----	-----	---

Table 48. Low-Leakage Medium Speed Switching Diodes — Single

Device	Marking	$V_{(BR)R}$		I_R		V_F			$C_T^{(30)}$	t_{rr}	Case Style
		Min Volts	@ I_{BR} (μA)	Max (nA)	@ V_R Volts	Min Volts	Max Volts	@ I_F (mA)	Max (pF)	Max (ns)	

Case 318-08 — TO-236AB (SOT-23)

BAS116LT1	JV	75	100	5.0	75	—	1.0	10	2.0	3000	8
MMBD1000LT1	AY	30	100	0.5	30	—	0.95	10	2.0	3000	6

Case 419-02 — (SOT-323)/(SC-70)

MMBD2000T1	DH	30	100	0.5	30	—	0.95	10	2.0	3000	2
-------------------	----	----	-----	-----	----	---	------	----	-----	------	---

Case 318D-04 — (SC-59)

MMBD3000T1	XP	30	100	0.5	30	—	0.95	10	2.0	3000	2
-------------------	----	----	-----	-----	----	---	------	----	-----	------	---

Case 425-04 — (SOD-123)

MMSD1000T1	4K	30	100	0.5	30	—	0.95	10	2.0	3000	1
-------------------	----	----	-----	-----	----	---	------	----	-----	------	---

Devices listed in bold, italic are Motorola preferred devices.

Switching Diodes (continued)

Table 49. Low-Leakage Medium Speed Switching Diodes — Dual

Device	Marking	$V_{(BR)R}$		I_R		V_F			$C_T^{(30)}$	t_{rr}	Case Style
		Min Volts	@ I_{BR} (μA)	Max (nA)	@ V_R Volts	Min Volts	Max Volts	@ I_F (mA)	Max (pF)	Max (ns)	
Case 318-08 — TO-236AB (SOT-23)											
<i>BAV170LT1</i>	JX	70	100	5.0	70	—	1.0	10	2.0	3000	9
<i>BAV199LT1</i>	JY	70	100	5.0	70	—	1.0	10	2.0	3000	11
<i>BAW156LT1</i>	JZ	70	100	5.0	70	—	1.0	10	2.0	3000	12
<i>MMBD1005LT1</i>	A3	30	100	0.5	30	—	0.95	10	2.0	3000	12
<i>MMBD1010LT1</i>	A5	30	100	0.5	30	—	0.95	10	2.0	3000	9
Case 419-02 — (SOT-323)/(SC-70) — DUAL											
<i>MMBD2005T1</i>	DI	30	100	0.5	30	—	0.95	10	2.0	3000	4
<i>MMBD2010T1</i>	DP	30	100	0.5	30	—	0.95	10	2.0	3000	5
Case 318D-04 — (SC-59) — DUAL											
<i>MMBD3005T1</i>	XQ	30	100	0.5	30	—	0.95	10	2.0	3000	5
<i>MMBD3010T1</i>	XS	30	100	0.5	30	—	0.95	10	2.0	3000	3

⁽³⁰⁾ $V_R = 0 V, f = 1.0 MHz$

Devices listed in bold, italic are Motorola preferred devices.

Multiple Switching Diodes

Multiple diode configurations utilize monolithic structures fabricated by the planar process. They are designed to satisfy fast switching requirements as in core driver and encoding/decoding applications where their monolithic configurations offer lower cost, higher reliability and space savings.



Diode Array Diagrams

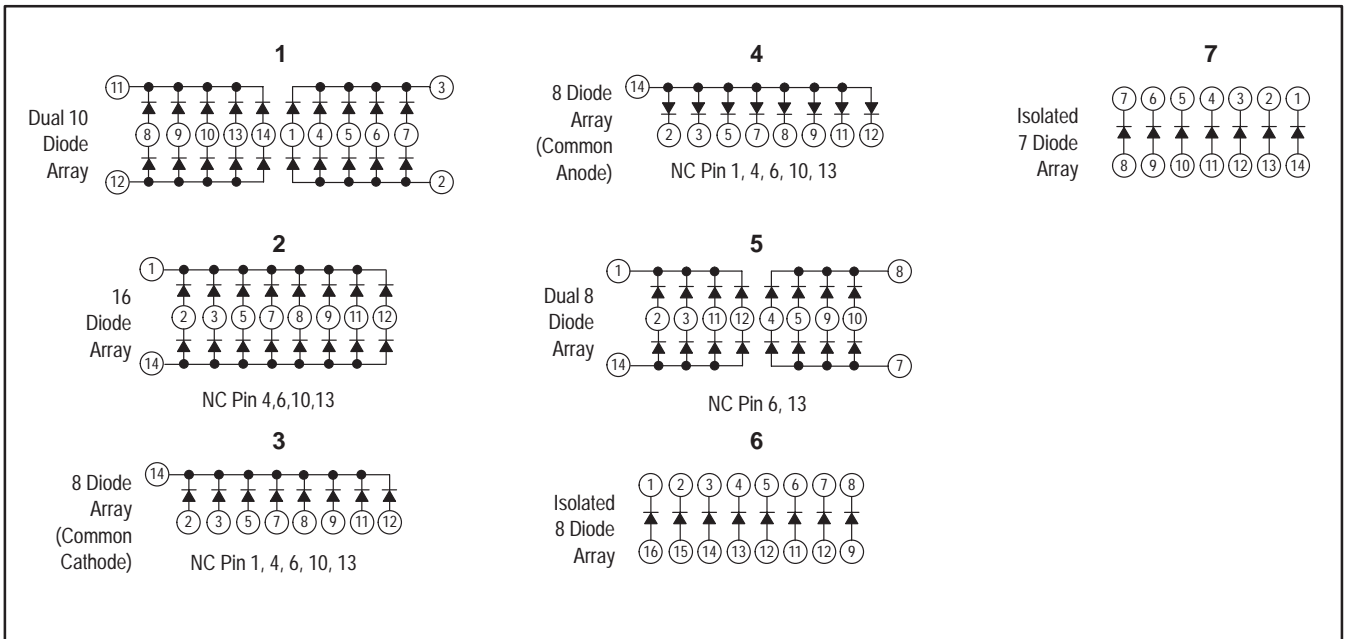


Table 50. Diode Arrays

Case 751A-03— SO-14

MMAD130	Dual 10 Diode Array	1
MMAD1103	16 Diode Array	2
MMAD1105	8 Diode Common Cathode Array	3
MMAD1106	8 Diode Common Anode Array	4
MMAD1107	Dual 8 Diode Array	5
MMAD1109	7 Isolated Diode Array	7

Case 751B-05 — SO-16

MMAD1108	8 Isolated Diode Array	6
-----------------	------------------------	---



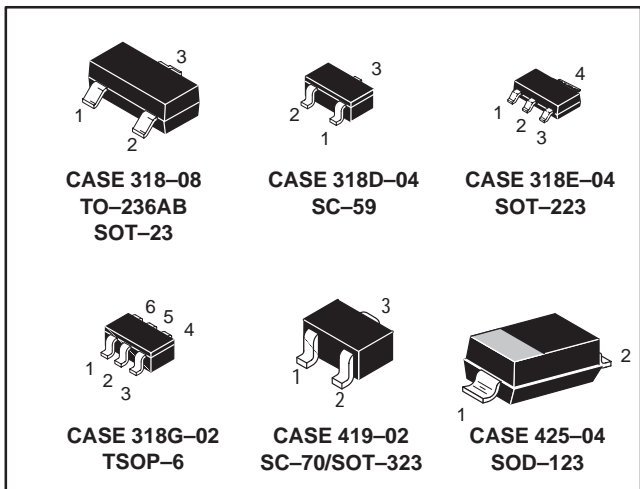
Plastic-Encapsulated Surface Mount Devices

Energy. It's something Motorola is putting a lot of energy into helping save. That's why we're introducing our GreenLine™ portfolio of devices, featuring energy-conserving traits superior to those of our existing line of standard parts for the same usage. GreenLine devices can actually help reduce the power demands of your products.

Wide Range of Applications

Currently, our portfolio consists of three families.

- **Low-Leakage Switching Diodes:** With reverse leakage specifications guaranteed to 500 pA, they help extend battery life, making them ideal for small battery-operated systems in which standby power is essential. Applications include ESD protection, reverse voltage protection, and steering logic.
- **Bipolar Output Driver Transistors:** Offering ultra-low collector saturation voltage, they deliver more energy to the intended load with less power wasted through dissipation loss. They are especially effective in today's lower voltage battery-powered applications, and prolong battery life in portable and hand-held communications and personal digital equipment.



- **Small Signal HDTMOS™:** These devices provide our lowest ever drain-source resistance versus package size. Lower $r_{DS(on)}$ means less wasted energy through dissipation loss, making them especially effective for low-current applications where energy conservation is crucial, such as low current switchmode power supplies, uninterruptable power supplies (UPS), power management systems, and bias switching. This makes them ideal for portable computer-type products or any system where the combination of power management and energy conservation is key.

Save Energy — Save Money

In an increasingly power-hungry world, Motorola's GreenLine portfolio makes powerful sense. So much sense that we plan to continue adding devices to the portfolio. Chances are, there are Motorola GreenLine devices applicable to one or more of your products — ones that can help save energy, dollars — and the environment.

Table 51. Bipolar Driver Transistor — PNP

These offer ultra-low collector saturation voltage.

Pinout: 1-Base, 2-Emitter, 3-Collector

Device Type	Marking	Case	$V_{(BR)CEO}$	$V_{CE(sat)}$	$V_{BE(sat)}$	$h_{FE} @ I_C$		
						Min	Max	mA
<i>MMBT1010LT1</i>	GLP	SOT-23	15	0.1	1.1	300	600	100
<i>MSD1010T1</i>	GLP	SC-59	15	0.1	1.1	300	600	100

Table 52. Low Leakage Switching Diodes

These offer reverse leakage specifications guaranteed to 500 pA. Versions available in single and dual.

Device Type	Marking	Case	Style	V _{(BR)R}		I _R	
				Min Volts	@ I _{BR} (μA)	Max (nA)	@ V _R Volts
<i>MMBD1000LT1</i>	AY	SOT-23	Single	30	100	0.5	30
<i>MMBD1005LT1</i>	A3	SOT-23	Dual Anode	30	100	0.5	30
<i>MMBD1010LT1</i>	A5	SOT-23	Dual Cathode	30	100	0.5	30
<i>MMBD2000T1</i>	DH	SC-70	Single	30	100	0.5	30
<i>MMBD2005T1</i>	DI	SC-70	Dual Anode	30	100	0.5	30
<i>MMBD2010T1</i>	DP	SC-70	Dual Cathode	30	100	0.5	30
<i>MMBD3000T1</i>	XP	SC-59	Single	30	100	0.5	30
<i>MMBD3005T1</i>	XQ	SC-59	Dual Anode	30	100	0.5	30
<i>MMBD3010T1</i>	XS	SC-59	Dual Cathode	30	100	0.5	30
<i>MMSD1000T1</i>	4K	SOD-123	Single	30	100	0.5	30

Table 53. Small Signal HDTMOS™ MOSFETs

These provide the lowest drain-source resistance versus package size.

Device Type	Marking	Channel	R _{DS(on)} Ω Max			V _{DSS}	V _{GS(th)}		Switching Time		Style
			@ V _{gs1} (10 V)	@ V _{gs2} (4.5 V)	@ V _{gs3} (2.5 V)		Volts Min	Volts Max	t _(on) ns	t _(off) ns	

Case 318-08 — TO-236AB (SOT-23) — P-Channel and N-Channel

<i>2N7002LT1</i>	702	N	7.5	—	—	60	1.0	2.5	—	—	21
<i>BSS84LT1</i>	PD	P	—	10	—	50	0.8	2.0	2.5	16	21
<i>BSS123LT1</i>	SA	N	6.0	—	—	100	0.8	2.8	20	40	21
<i>BSS138LT1</i>	J1	N	—	3.5	—	50	0.5	1.5	20	20	21
<i>MMBF0201NLT1</i>	N1	N	1.0	1.4	—	20	1.0	2.4	2.5	15	21
<i>MMBF0202PLT1</i>	P3	P	1.4	3.5	—	20	1.0	2.4	2.5	16	21
<i>MGSF1N02LT1</i>	—	N	0.085	0.125	—	20	1.0	2.4	2.5	16	21
<i>MGSF1N03LT1</i>	—	N	0.10	0.145	—	30	1.0	2.4	2.5	16	21
<i>MGSF1P02LT1</i>	—	P	3.5	0.5	—	20	1.0	2.4	2.5	16	21
<i>MGSF1P02ELT1</i>	—	P	0.16	0.21	—	20	0.7	1.2	2.5	15	21

Case 318G-02 — TSOP-6 — P-Channel and N-Channel

<i>MGSF3441VT1</i>	—	P	—	0.10	0.135	20	0.45	—	27	52	1
<i>MGSF3441XT1</i>	—	P	—	0.10	0.135	20	0.45	—	27	52	1
<i>MGSF3442VT1</i>	—	N	—	0.07	0.095	20	0.6	—	8.0	36	1
<i>MGSF3442XT1</i>	—	N	—	0.07	0.095	20	0.6	—	8.0	36	1
<i>MGSF3454VT1</i>	—	N	0.065	0.095	—	30	1.0	—	10	20	1
<i>MGSF3454XT1</i>	—	N	0.065	0.095	—	30	1.0	—	10	20	1
<i>MGSF3455VT1</i>	—	P	0.10	0.19	—	30	1.0	—	10	20	1
<i>MGSF3455XT1</i>	—	P	0.10	0.19	—	30	1.0	—	10	20	1

Case 419-02 — SC-70/SOT-323

<i>MMBF2202PT1</i>	P3	P	2.2	3.5	—	20	1.0	2.4	2.5	16	7
<i>MMBF2201NT1</i>	N1	N	1.0	1.4	—	20	1.0	2.4	2.5	15	7

Devices listed in bold, italic are Motorola preferred devices.

Small Signal Multi-integrated Devices

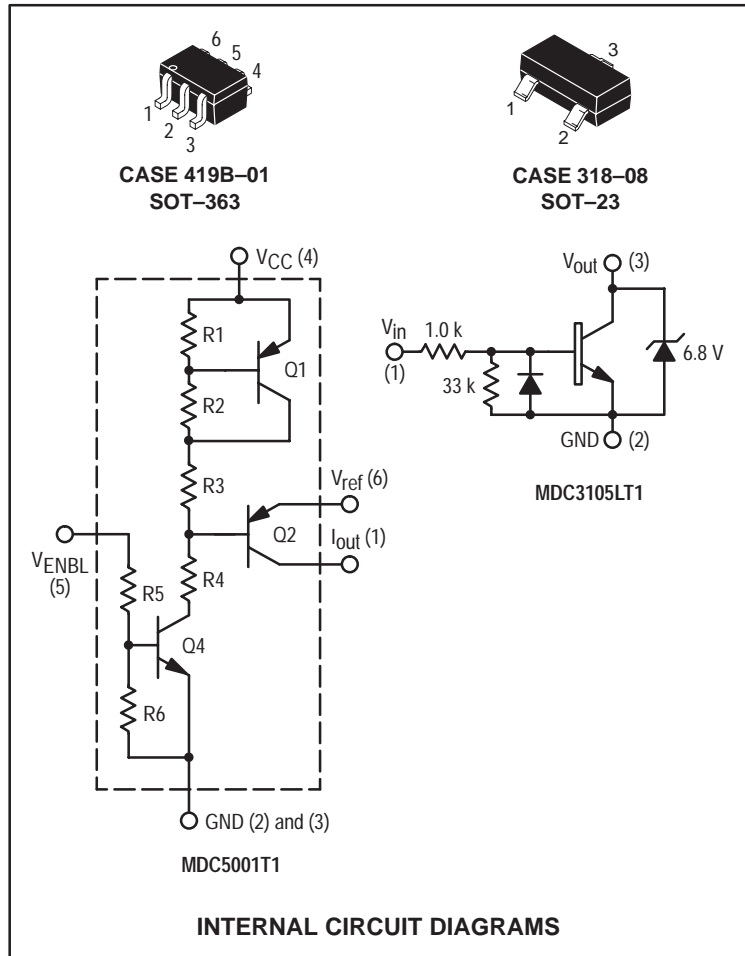


Table 54. Low Voltage Bias Stabilizer

A silicon SMALLBLOCK™ integrated circuit which maintains stable bias current in various discrete bipolar junction and field effect transistors.

Device Type	Marking	V_{CC} (Volts)		I_{CC} μA	V_{ref} Volts	ΔV_{ref} Volts
		Min	Max			
Case 419B-01 — SOT-363						
MDC5001T1	E6	1.8	10	200	2.1	± 50

Table 55. Integrated Relay/Solenoid Driver

Monolithic circuit block to switch 3.0 V to 5.0 V relays. It is intended to replace an array of three to six discrete components.

Device Type	V_{CC} (Volts)		V_{in} (Volts)		V_{sat} (Volts)	I_{in} (mA)	$I_{C(on)}$ (mA)
	Min	Max	Min	Max			
Case 318-08 — SOT-23							
MDC3105LT1	2.0	5.5	2.0	5.5	0.4	2.5	250

Devices listed in bold, italic are Motorola preferred devices.

Section 2

Plastic-Encapsulated Transistors

In Brief . . .

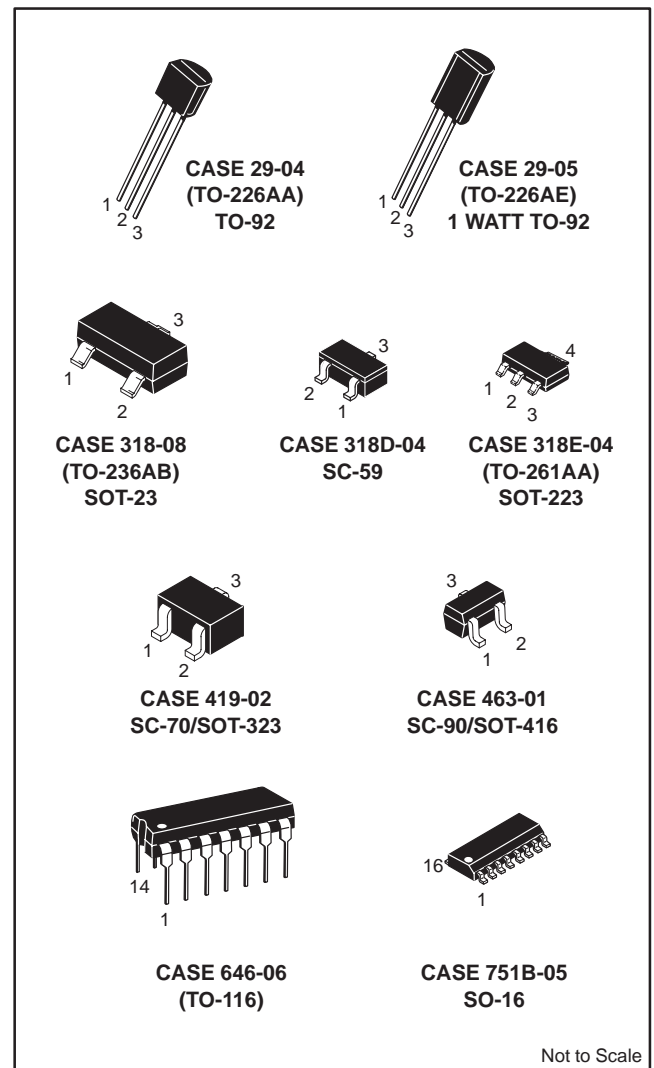
Motorola's plastic transistors and diodes encompass hundreds of devices spanning the gamut from general-purpose amplifiers and switches with a wide variety of characteristics to dedicated special-purpose devices for the most demanding applications. The popular TO-92, 1-Watt TO-92 and TO-116 combine proven reliability performance and economy for through-the-hole manufacturing, while the SOT-23, SC-59, SC-70/SOT-323, SC-90/SOT-416, SOT-223, and SO-16 offer the same solutions for surface mount manufacturing.

As an additional service to our customers Motorola will, upon request, supply many of these devices in tape and reel for automatic insertion.

Contact your Motorola representative for ordering information.

This section contains both single and multiple plastic-encapsulated transistors.

NOTE: All SOT-23 package devices have had a "T1" suffix added to the device title.



EMBOSSSED TAPE AND REEL

SOT-23, SC-59, SC-70/SOT-323, SC-90/SOT-416, SOT-223 and SO-16 packages are available only in Tape and Reel. Use the appropriate suffix indicated below to order any of the SOT-23, SC-59, SC-70/SOT-323, SOT-223 and SO-16 packages. (See Section 6 on Packaging for additional information).

- SOT-23: available in 8 mm Tape and Reel
Use the device title (which already includes the "T1" suffix) to order the 7 inch/3000 unit reel.
Replace the "T1" suffix in the device title with a "T3" suffix to order the 13 inch/10,000 unit reel.
- SC-59: available in 8 mm Tape and Reel
Use the device title (which already includes the "T1" suffix) to order the 7 inch/3000 unit reel.
Replace the "T1" suffix in the device title with a "T3" suffix to order the 13 inch/10,000 unit reel.
- SC-70/
SOT-323: available in 8 mm Tape and Reel
Use the device title (which already includes the "T1" suffix) to order the 7 inch/3000 unit reel.
Replace the "T1" suffix in the device title with a "T3" suffix to order the 13 inch/10,000 unit reel.
- SOT-223: available in 12 mm Tape and Reel
Use the device title (which already includes the "T1" suffix) to order the 7 inch/1000 unit reel.
Replace the "T1" suffix in the device title with a "T3" suffix to order the 13 inch/4000 unit reel.
- SO-16: available in 16 mm Tape and Reel
Add an "R1" suffix to the device title to order the 7 inch/500 unit reel.
Add an "R2" suffix to the device title to order the 13 inch/2500 unit reel.

RADIAL TAPE IN FAN FOLD BOX OR REEL

TO-92 packages are available in both bulk shipments and in Radial Tape in Fan Fold Boxes or Reels. Fan Fold Boxes and Radial Tape Reel are the best methods for capturing devices for automatic insertion in printed circuit boards.

- TO-92: available in Fan Fold Box
Add an "RLR" suffix and the appropriate Style code* to the device title to order the Fan Fold box.
- available in 365 mm Radial Tape Reel
Add an "RLR" suffix and the appropriate Style code* to the device title to order the Radial Tape Reel.

*Refer to Section 6 on Packaging for Style code characters and additional information on ordering requirements.

DEVICE MARKINGS/DATE CODE CHARACTERS

SOT-23, SC-59, SC-70/SOT-323, and the SC-90/SOT-416 packages have a device marking and a date code etched on the device. The generic example below depicts both the device marking and a representation of the date code that appears on the SC-70/SOT-323, SC-59 and SOT-23 packages.



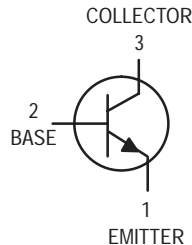
The "D" represents a smaller alpha digit Date Code. The Date Code indicates the actual month in which the part was manufactured.

General Purpose Transistors

NPN Silicon

2N3903
2N3904*

*Motorola Preferred Device



CASE 29-04, STYLE 1
TO-92 (TO-226AA)

MAXIMUM RATINGS

Rating	Symbol	Value	Unit
Collector–Emitter Voltage	V_{CEO}	40	Vdc
Collector–Base Voltage	V_{CBO}	60	Vdc
Emitter–Base Voltage	V_{EBO}	6.0	Vdc
Collector Current — Continuous	I_C	200	mAdc
Total Device Dissipation @ $T_A = 25^\circ\text{C}$ Derate above 25°C	P_D	625 5.0	mW mW/ $^\circ\text{C}$
Total Device Dissipation @ $T_C = 25^\circ\text{C}$ Derate above 25°C	P_D	1.5 12	Watts mW/ $^\circ\text{C}$
Operating and Storage Junction Temperature Range	T_J, T_{stg}	-55 to +150	$^\circ\text{C}$

THERMAL CHARACTERISTICS(1)

Characteristic	Symbol	Max	Unit
Thermal Resistance, Junction to Ambient	$R_{\theta JA}$	200	$^\circ\text{C}/\text{W}$
Thermal Resistance, Junction to Case	$R_{\theta JC}$	83.3	$^\circ\text{C}/\text{W}$

ELECTRICAL CHARACTERISTICS ($T_A = 25^\circ\text{C}$ unless otherwise noted)

Characteristic	Symbol	Min	Max	Unit
----------------	--------	-----	-----	------

OFF CHARACTERISTICS

Collector–Emitter Breakdown Voltage ⁽²⁾ ($I_C = 1.0 \text{ mAdc}, I_E = 0$)	$V_{(BR)CEO}$	40	—	Vdc
Collector–Base Breakdown Voltage ($I_C = 10 \mu\text{Adc}, I_E = 0$)	$V_{(BR)CBO}$	60	—	Vdc
Emitter–Base Breakdown Voltage ($I_E = 10 \mu\text{Adc}, I_C = 0$)	$V_{(BR)EBO}$	6.0	—	Vdc
Base Cutoff Current ($V_{CE} = 30 \text{ Vdc}, V_{EB} = 3.0 \text{ Vdc}$)	I_{BL}	—	50	nAdc
Collector Cutoff Current ($V_{CE} = 30 \text{ Vdc}, V_{EB} = 3.0 \text{ Vdc}$)	I_{CEX}	—	50	nAdc

1. Indicates Data in addition to JEDEC Requirements.
2. Pulse Test: Pulse Width $\leq 300 \mu\text{s}$; Duty Cycle $\leq 2.0\%$.

Preferred devices are Motorola recommended choices for future use and best overall value.

REV 2

2N3903 2N3904

ELECTRICAL CHARACTERISTICS ($T_A = 25^\circ\text{C}$ unless otherwise noted) (Continued)

Characteristic	Symbol	Min	Max	Unit
ON CHARACTERISTICS				
DC Current Gain ⁽¹⁾ ($I_C = 0.1 \text{ mAdc}$, $V_{CE} = 1.0 \text{ Vdc}$)	h_{FE}	20	—	—
2N3903		40	—	
2N3904				
($I_C = 1.0 \text{ mAdc}$, $V_{CE} = 1.0 \text{ Vdc}$)		35	—	
2N3903		70	—	
2N3904				
($I_C = 10 \text{ mAdc}$, $V_{CE} = 1.0 \text{ Vdc}$)		50	150	
2N3903		100	300	
2N3904				
($I_C = 50 \text{ mAdc}$, $V_{CE} = 1.0 \text{ Vdc}$)		30	—	
2N3903		60	—	
2N3904				
($I_C = 100 \text{ mAdc}$, $V_{CE} = 1.0 \text{ Vdc}$)		15	—	
2N3903		30	—	
2N3904				
Collector–Emitter Saturation Voltage ⁽¹⁾ ($I_C = 10 \text{ mAdc}$, $I_B = 1.0 \text{ mAdc}$) ($I_C = 50 \text{ mAdc}$, $I_B = 5.0 \text{ mAdc}$)	$V_{CE(sat)}$	—	0.2	Vdc
		—	0.3	
Base–Emitter Saturation Voltage ⁽¹⁾ ($I_C = 10 \text{ mAdc}$, $I_B = 1.0 \text{ mAdc}$) ($I_C = 50 \text{ mAdc}$, $I_B = 5.0 \text{ mAdc}$)	$V_{BE(sat)}$	0.65	0.85	Vdc
		—	0.95	

SMALL–SIGNAL CHARACTERISTICS

Current–Gain — Bandwidth Product ($I_C = 10 \text{ mAdc}$, $V_{CE} = 20 \text{ Vdc}$, $f = 100 \text{ MHz}$)	f_T	250	—	MHz
2N3903		300	—	
2N3904				
Output Capacitance ($V_{CB} = 5.0 \text{ Vdc}$, $I_E = 0$, $f = 1.0 \text{ MHz}$)	C_{obo}	—	4.0	pF
Input Capacitance ($V_{EB} = 0.5 \text{ Vdc}$, $I_C = 0$, $f = 1.0 \text{ MHz}$)	C_{ibo}	—	8.0	pF
Input Impedance ($I_C = 1.0 \text{ mAdc}$, $V_{CE} = 10 \text{ Vdc}$, $f = 1.0 \text{ kHz}$)	h_{ie}	1.0	8.0	k Ω
2N3903		1.0	10	
2N3904				
Voltage Feedback Ratio ($I_C = 1.0 \text{ mAdc}$, $V_{CE} = 10 \text{ Vdc}$, $f = 1.0 \text{ kHz}$)	h_{re}	0.1	5.0	$\times 10^{-4}$
2N3903		0.5	8.0	
2N3904				
Small–Signal Current Gain ($I_C = 1.0 \text{ mAdc}$, $V_{CE} = 10 \text{ Vdc}$, $f = 1.0 \text{ kHz}$)	h_{fe}	50	200	—
2N3903		100	400	
2N3904				
Output Admittance ($I_C = 1.0 \text{ mAdc}$, $V_{CE} = 10 \text{ Vdc}$, $f = 1.0 \text{ kHz}$)	h_{oe}	1.0	40	μhos
Noise Figure ($I_C = 100 \mu\text{Adc}$, $V_{CE} = 5.0 \text{ Vdc}$, $R_S = 1.0 \text{ k } \Omega$, $f = 1.0 \text{ kHz}$)	NF	—	6.0	dB
2N3903		—	5.0	
2N3904				

SWITCHING CHARACTERISTICS

Delay Time	$(V_{CC} = 3.0 \text{ Vdc}$, $V_{BE} = 0.5 \text{ Vdc}$, $I_C = 10 \text{ mAdc}$, $I_{B1} = 1.0 \text{ mAdc}$)		t_d	—	35	ns
Rise Time			t_r	—	35	ns
Storage Time	$(V_{CC} = 3.0 \text{ Vdc}$, $I_C = 10 \text{ mAdc}$, $I_{B1} = I_{B2} = 1.0 \text{ mAdc}$)	2N3903	t_s	—	175	ns
Fall Time		2N3904		—	200	ns
			t_f	—	50	ns

1. Pulse Test: Pulse Width $\leq 300 \mu\text{s}$; Duty Cycle $\leq 2.0\%$.

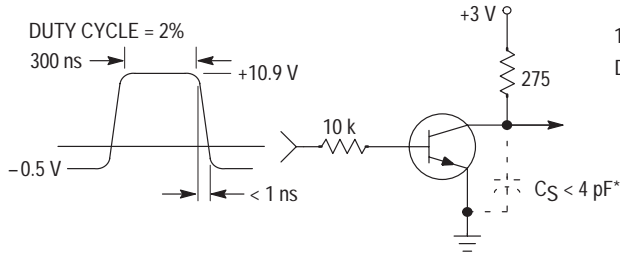


Figure 1. Delay and Rise Time Equivalent Test Circuit

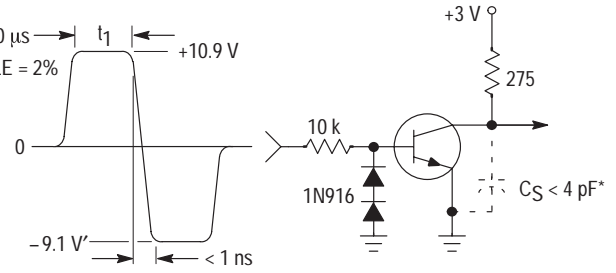


Figure 2. Storage and Fall Time Equivalent Test Circuit

* Total shunt capacitance of test jig and connectors

TYPICAL TRANSIENT CHARACTERISTICS

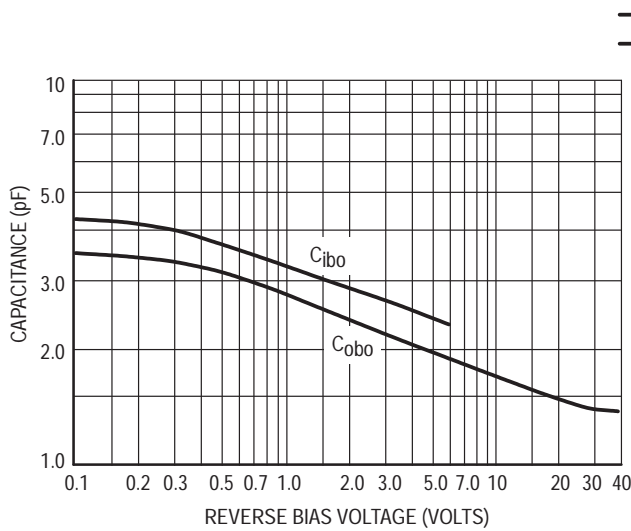


Figure 3. Capacitance

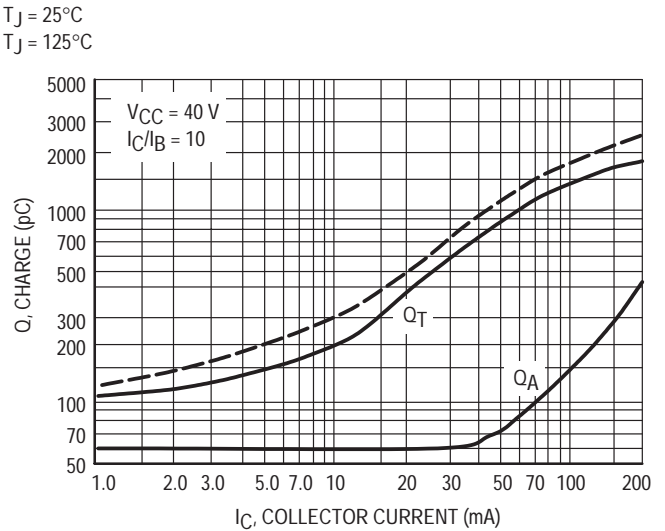


Figure 4. Charge Data

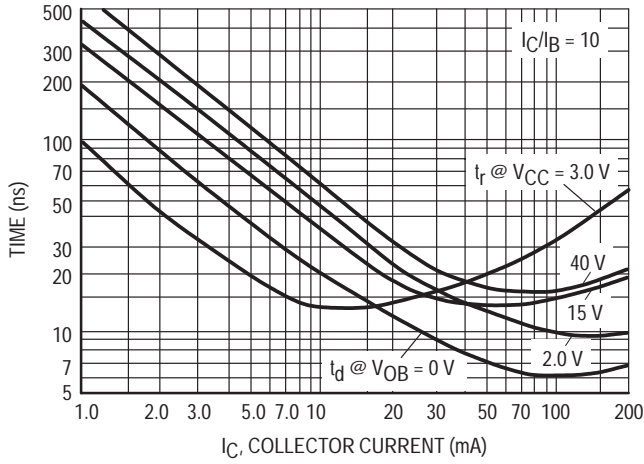


Figure 5. Turn-On Time

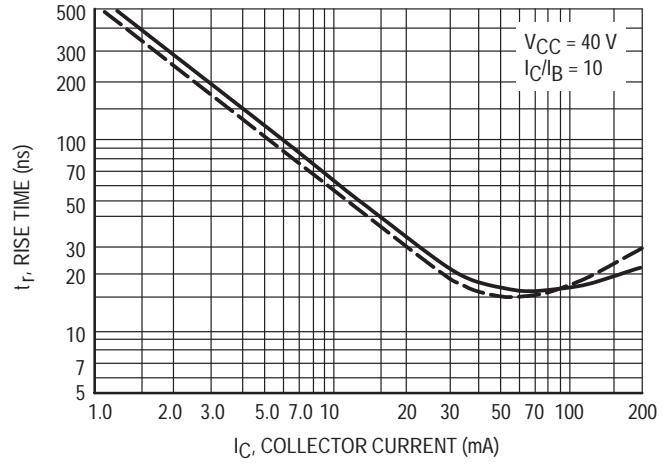


Figure 6. Rise Time

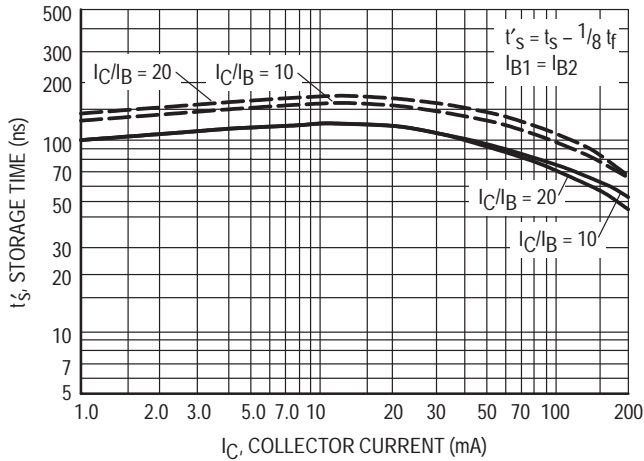


Figure 7. Storage Time

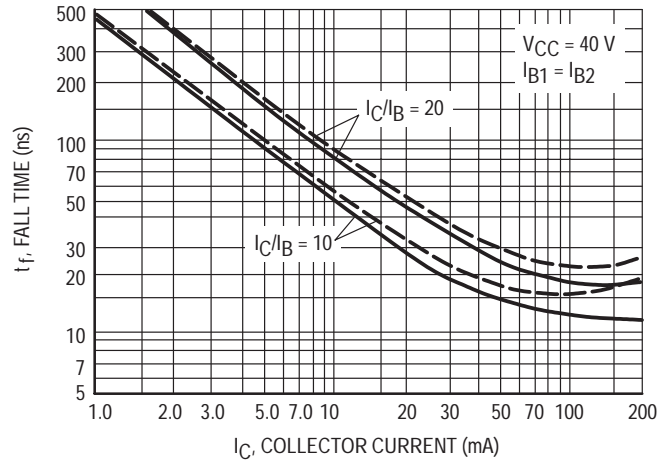


Figure 8. Fall Time

TYPICAL AUDIO SMALL-SIGNAL CHARACTERISTICS
NOISE FIGURE VARIATIONS

($V_{CE} = 5.0 \text{ Vdc}$, $T_A = 25^\circ\text{C}$, Bandwidth = 1.0 Hz)

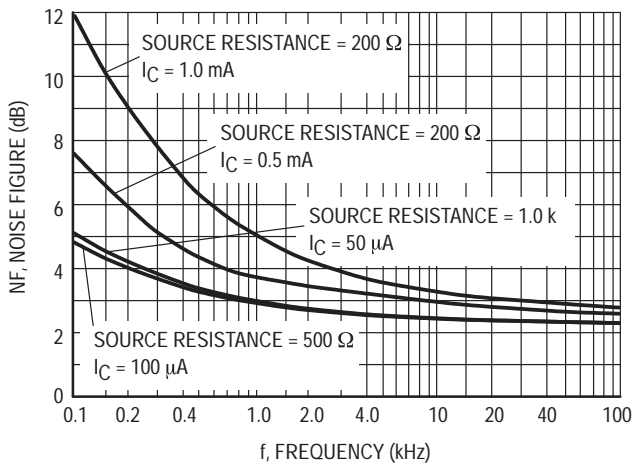


Figure 9.

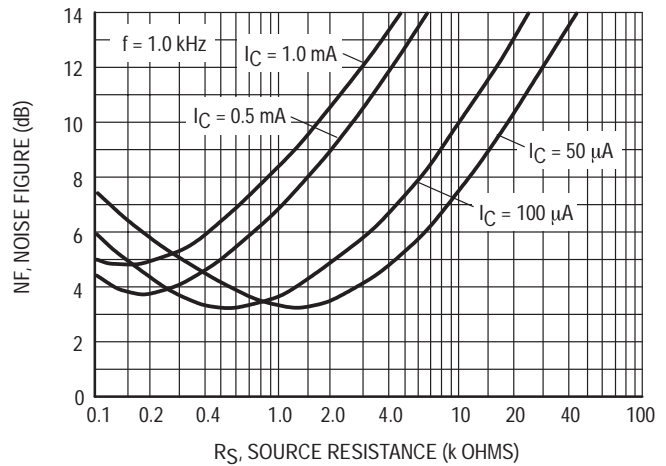


Figure 10.

h PARAMETERS

($V_{CE} = 10 \text{ Vdc}$, $f = 1.0 \text{ kHz}$, $T_A = 25^\circ\text{C}$)

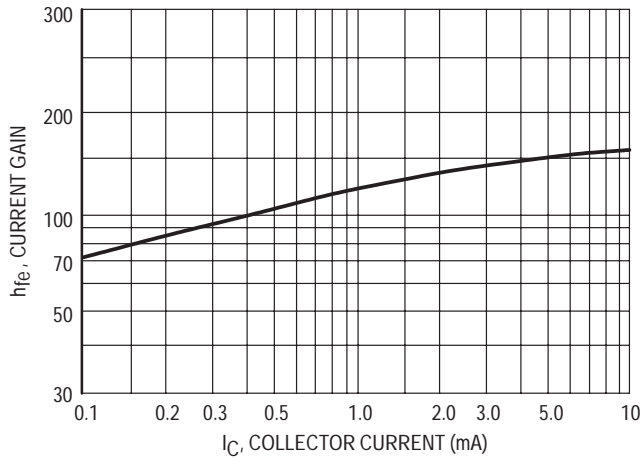


Figure 11. Current Gain

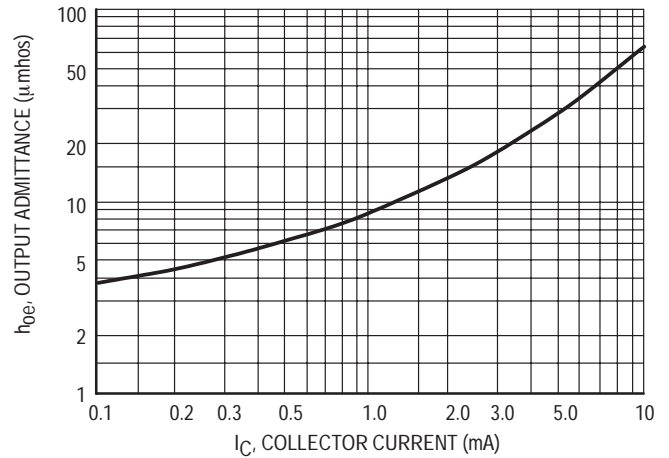


Figure 12. Output Admittance

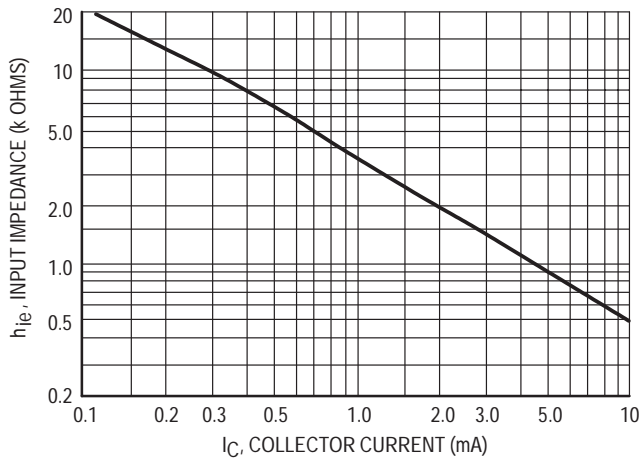


Figure 13. Input Impedance

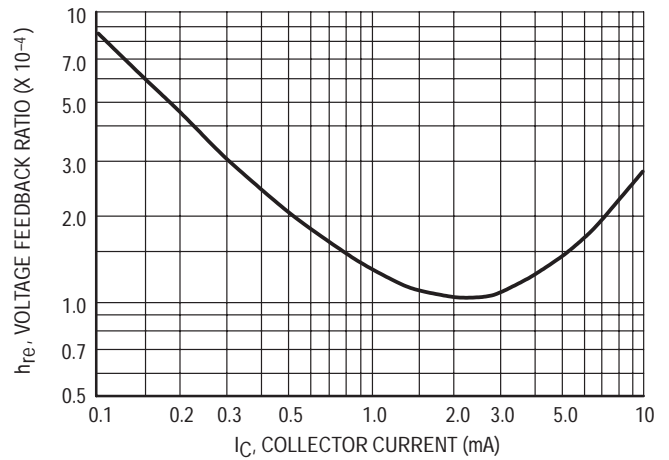


Figure 14. Voltage Feedback Ratio

TYPICAL STATIC CHARACTERISTICS

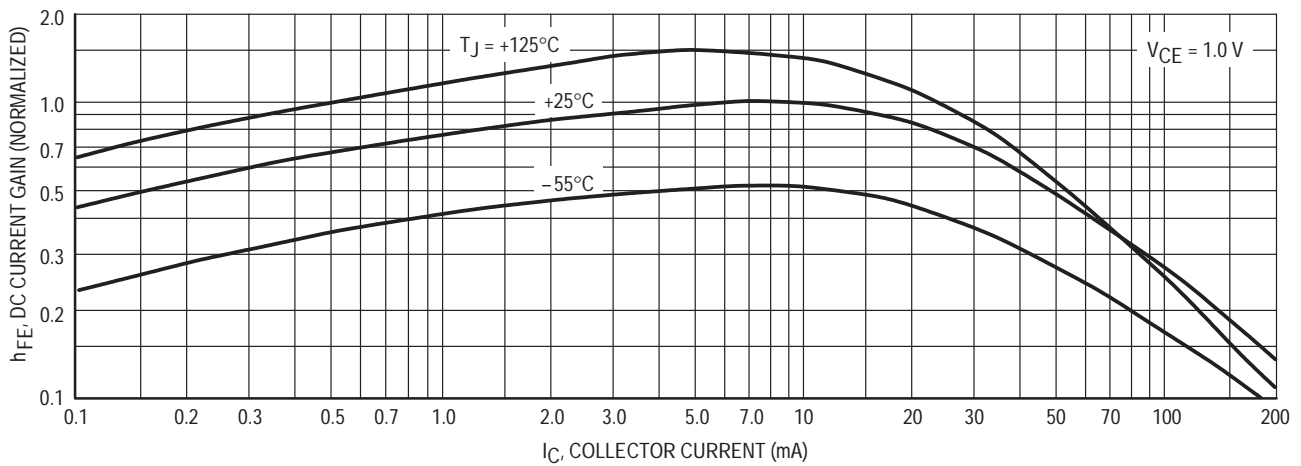


Figure 15. DC Current Gain

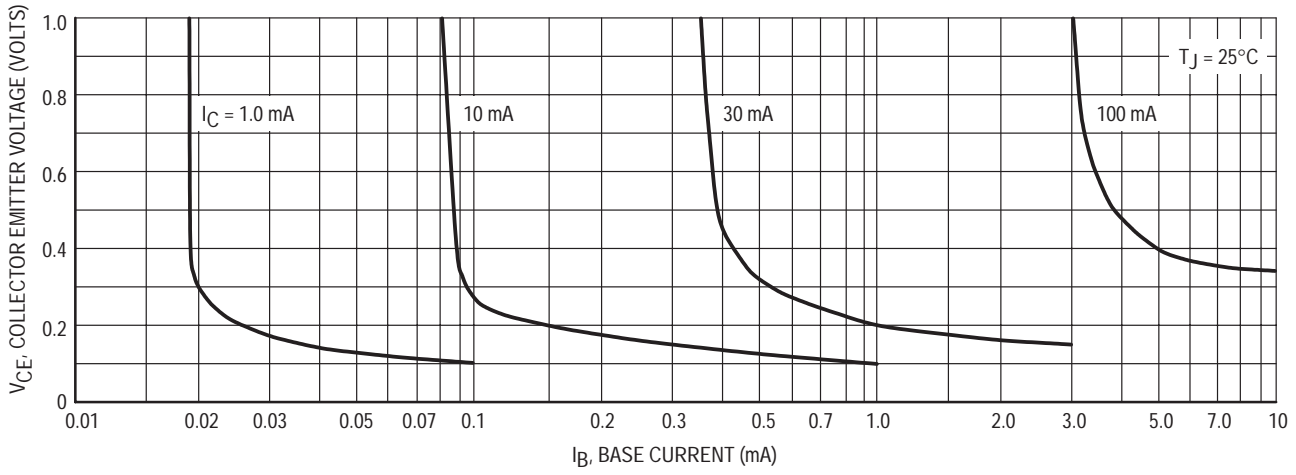


Figure 16. Collector Saturation Region

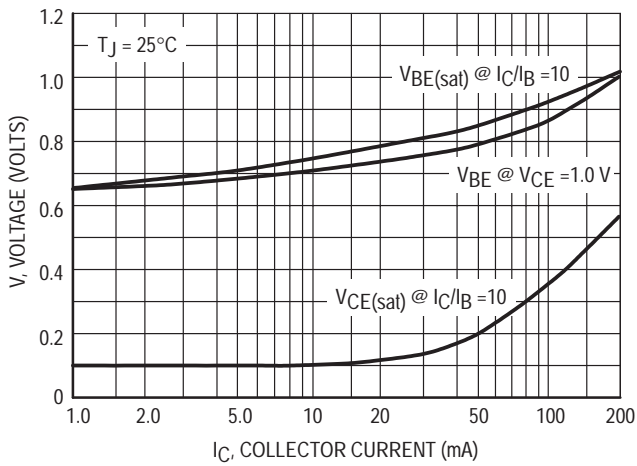


Figure 17. "ON" Voltages

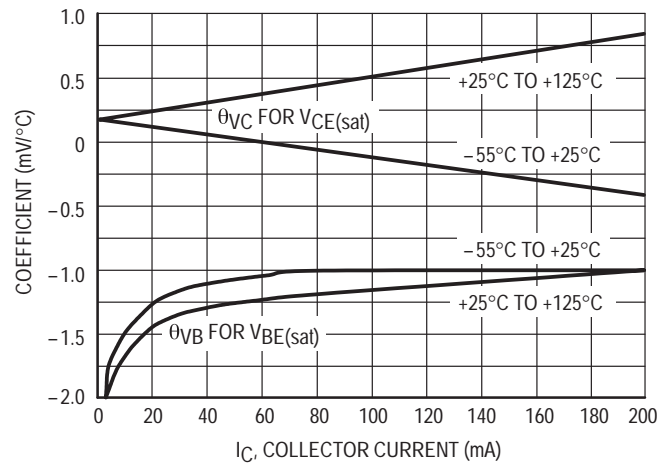


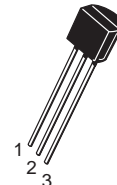
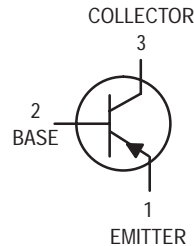
Figure 18. Temperature Coefficients

General Purpose Transistors

PNP Silicon

2N3905
2N3906*

*Motorola Preferred Device



CASE 29-04, STYLE 1
TO-92 (TO-226AA)

MAXIMUM RATINGS

Rating	Symbol	Value	Unit
Collector–Emitter Voltage	V_{CEO}	40	Vdc
Collector–Base Voltage	V_{CBO}	40	Vdc
Emitter–Base Voltage	V_{EBO}	5.0	Vdc
Collector Current — Continuous	I_C	200	mAdc
Total Device Dissipation @ $T_A = 25^\circ\text{C}$ Derate above 25°C	P_D	625 5.0	mW mW/ $^\circ\text{C}$
Total Power Dissipation @ $T_A = 60^\circ\text{C}$	P_D	250	mW
Total Device Dissipation @ $T_C = 25^\circ\text{C}$ Derate above 25°C	P_D	1.5 12	Watts mW/ $^\circ\text{C}$
Operating and Storage Junction Temperature Range	T_J, T_{stg}	-55 to +150	$^\circ\text{C}$

THERMAL CHARACTERISTICS(1)

Characteristic	Symbol	Max	Unit
Thermal Resistance, Junction to Ambient	$R_{\theta JA}$	200	$^\circ\text{C}/\text{W}$
Thermal Resistance, Junction to Case	$R_{\theta JC}$	83.3	$^\circ\text{C}/\text{W}$

ELECTRICAL CHARACTERISTICS ($T_A = 25^\circ\text{C}$ unless otherwise noted)

Characteristic	Symbol	Min	Max	Unit
----------------	--------	-----	-----	------

OFF CHARACTERISTICS

Collector–Emitter Breakdown Voltage (2) ($I_C = 1.0 \text{ mAdc}, I_B = 0$)	$V_{(BR)CEO}$	40	—	Vdc
Collector–Base Breakdown Voltage ($I_C = 10 \mu\text{Adc}, I_E = 0$)	$V_{(BR)CBO}$	40	—	Vdc
Emitter–Base Breakdown Voltage ($I_E = 10 \mu\text{Adc}, I_C = 0$)	$V_{(BR)EBO}$	5.0	—	Vdc
Base Cutoff Current ($V_{CE} = 30 \text{ Vdc}, V_{EB} = 3.0 \text{ Vdc}$)	I_{BL}	—	50	nAdc
Collector Cutoff Current ($V_{CE} = 30 \text{ Vdc}, V_{EB} = 3.0 \text{ Vdc}$)	I_{CEX}	—	50	nAdc

1. Indicates Data in addition to JEDEC Requirements.
2. Pulse Test: Pulse Width $\leq 300 \mu\text{s}$; Duty Cycle $\leq 2.0\%$.

Preferred devices are Motorola recommended choices for future use and best overall value.

2N3905 2N3906

ELECTRICAL CHARACTERISTICS ($T_A = 25^\circ\text{C}$ unless otherwise noted) (Continued)

Characteristic	Symbol	Min	Max	Unit
ON CHARACTERISTICS(1)				
DC Current Gain ($I_C = 0.1 \text{ mAdc}$, $V_{CE} = 1.0 \text{ Vdc}$)	h_{FE}	30	—	—
2N3905		60	—	
2N3906				
($I_C = 1.0 \text{ mAdc}$, $V_{CE} = 1.0 \text{ Vdc}$)		40	—	
2N3905		80	—	
2N3906				
($I_C = 10 \text{ mAdc}$, $V_{CE} = 1.0 \text{ Vdc}$)		50	150	
2N3905		100	300	
2N3906				
($I_C = 50 \text{ mAdc}$, $V_{CE} = 1.0 \text{ Vdc}$)		30	—	
2N3905		60	—	
2N3906				
($I_C = 100 \text{ mAdc}$, $V_{CE} = 1.0 \text{ Vdc}$)		15	—	
2N3905		30	—	
2N3906				
Collector–Emitter Saturation Voltage ($I_C = 10 \text{ mAdc}$, $I_B = 1.0 \text{ mAdc}$) ($I_C = 50 \text{ mAdc}$, $I_B = 5.0 \text{ mAdc}$)	$V_{CE(sat)}$	—	0.25 0.4	Vdc
Base–Emitter Saturation Voltage ($I_C = 10 \text{ mAdc}$, $I_B = 1.0 \text{ mAdc}$) ($I_C = 50 \text{ mAdc}$, $I_B = 5.0 \text{ mAdc}$)	$V_{BE(sat)}$	0.65 —	0.85 0.95	Vdc

SMALL–SIGNAL CHARACTERISTICS

Current–Gain — Bandwidth Product ($I_C = 10 \text{ mAdc}$, $V_{CE} = 20 \text{ Vdc}$, $f = 100 \text{ MHz}$)	f_T	200 250	— —	MHz
Output Capacitance ($V_{CB} = 5.0 \text{ Vdc}$, $I_E = 0$, $f = 1.0 \text{ MHz}$)	C_{obo}	—	4.5	pF
Input Capacitance ($V_{EB} = 0.5 \text{ Vdc}$, $I_C = 0$, $f = 1.0 \text{ MHz}$)	C_{ibo}	—	10.0	pF
Input Impedance ($I_C = 1.0 \text{ mAdc}$, $V_{CE} = 10 \text{ Vdc}$, $f = 1.0 \text{ kHz}$)	h_{ie}	0.5 2.0	8.0 12	k Ω
Voltage Feedback Ratio ($I_C = 1.0 \text{ mAdc}$, $V_{CE} = 10 \text{ Vdc}$, $f = 1.0 \text{ kHz}$)	h_{re}	0.1 0.1	5.0 10	$\times 10^{-4}$
Small–Signal Current Gain ($I_C = 1.0 \text{ mAdc}$, $V_{CE} = 10 \text{ Vdc}$, $f = 1.0 \text{ kHz}$)	h_{fe}	50 100	200 400	—
Output Admittance ($I_C = 1.0 \text{ mAdc}$, $V_{CE} = 10 \text{ Vdc}$, $f = 1.0 \text{ kHz}$)	h_{oe}	1.0 3.0	40 60	μhos
Noise Figure ($I_C = 100 \mu\text{Adc}$, $V_{CE} = 5.0 \text{ Vdc}$, $R_S = 1.0 \text{ k } \Omega$, $f = 1.0 \text{ kHz}$)	NF	— —	5.0 4.0	dB

SWITCHING CHARACTERISTICS

Delay Time	$(V_{CC} = 3.0 \text{ Vdc}$, $V_{BE} = 0.5 \text{ Vdc}$, $I_C = 10 \text{ mAdc}$, $I_{B1} = 1.0 \text{ mAdc}$)	t_d	—	35	ns
Rise Time		t_r	—	35	ns
Storage Time	$(V_{CC} = 3.0 \text{ Vdc}$, $I_C = 10 \text{ mAdc}$, $I_{B1} = I_{B2} = 1.0 \text{ mAd}$)	t_s	— —	200 225	ns
Fall Time		t_f	— —	60 75	ns

1. Pulse Test: Pulse Width $\leq 300 \mu\text{s}$; Duty Cycle $\leq 2.0\%$.

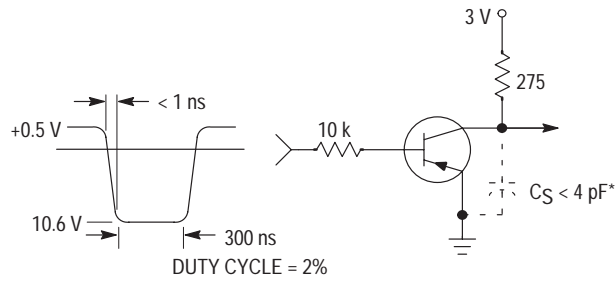


Figure 1. Delay and Rise Time Equivalent Test Circuit

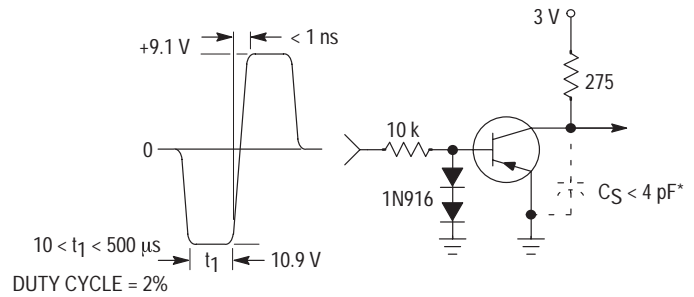


Figure 2. Storage and Fall Time Equivalent Test Circuit

* Total shunt capacitance of test jig and connectors

TYPICAL TRANSIENT CHARACTERISTICS

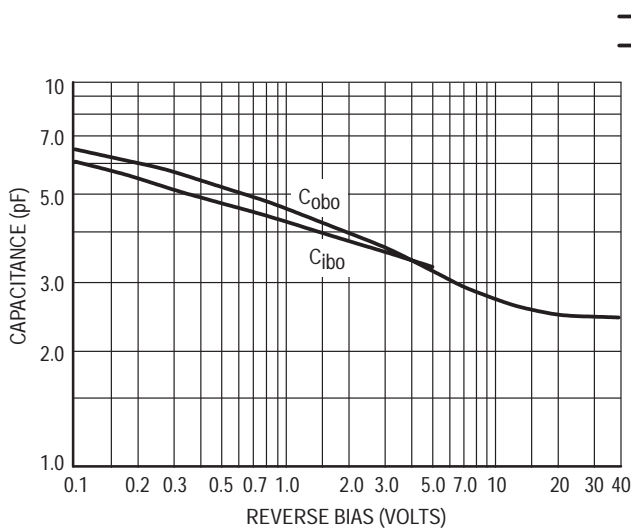


Figure 3. Capacitance

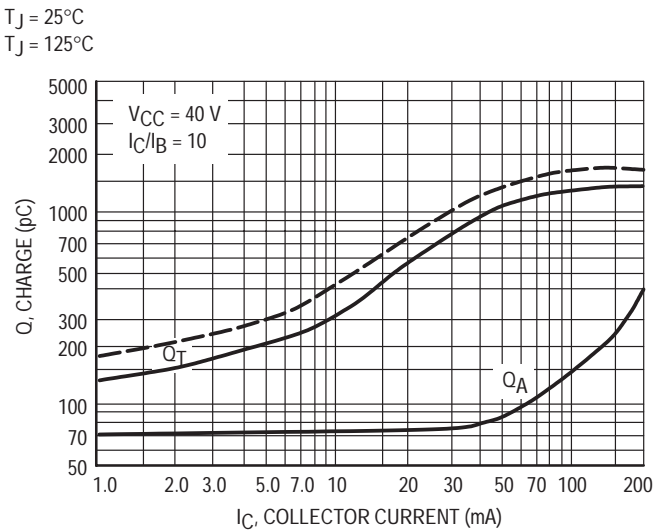


Figure 4. Charge Data

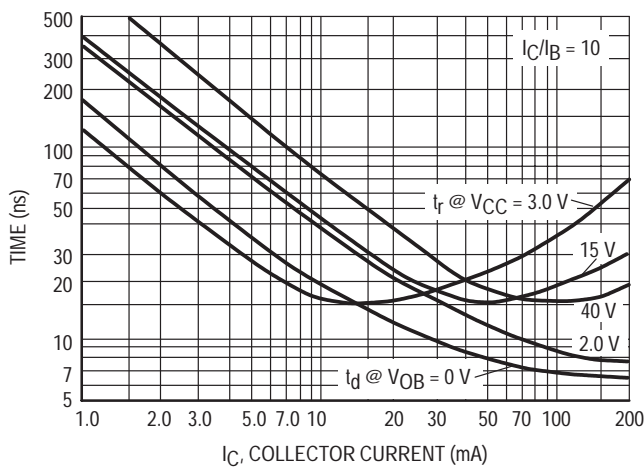


Figure 5. Turn-On Time

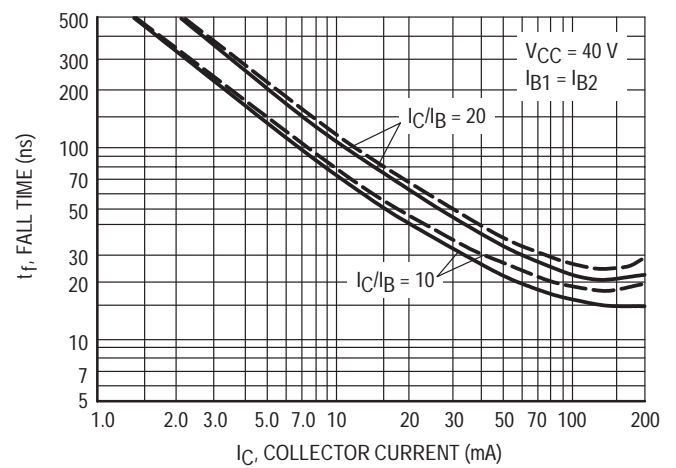


Figure 6. Fall Time

TYPICAL AUDIO SMALL-SIGNAL CHARACTERISTICS
NOISE FIGURE VARIATIONS

($V_{CE} = -5.0$ Vdc, $T_A = 25^\circ\text{C}$, Bandwidth = 1.0 Hz)

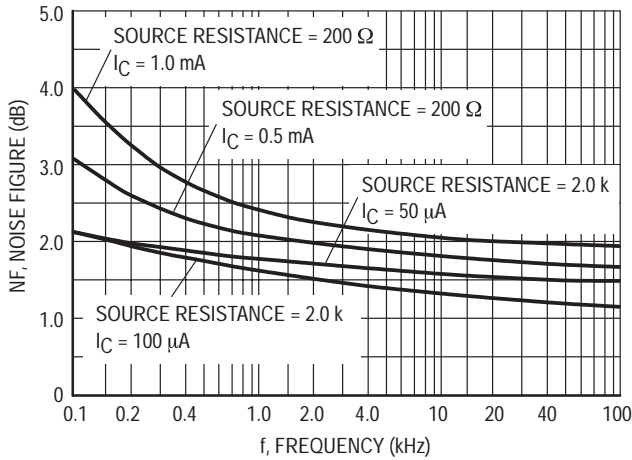


Figure 7.

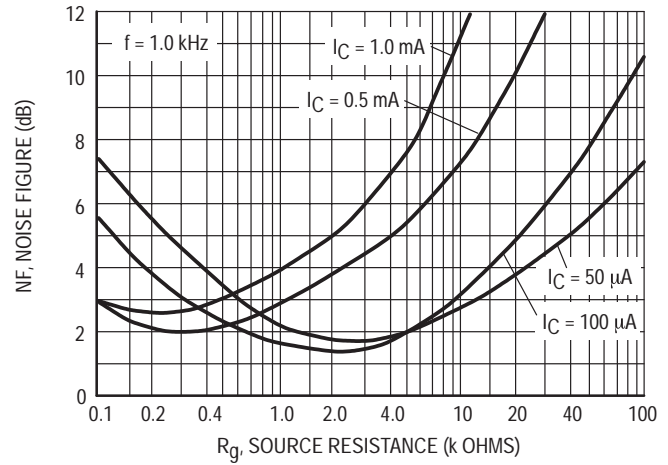


Figure 8.

h PARAMETERS

($V_{CE} = -10$ Vdc, $f = 1.0$ kHz, $T_A = 25^\circ\text{C}$)

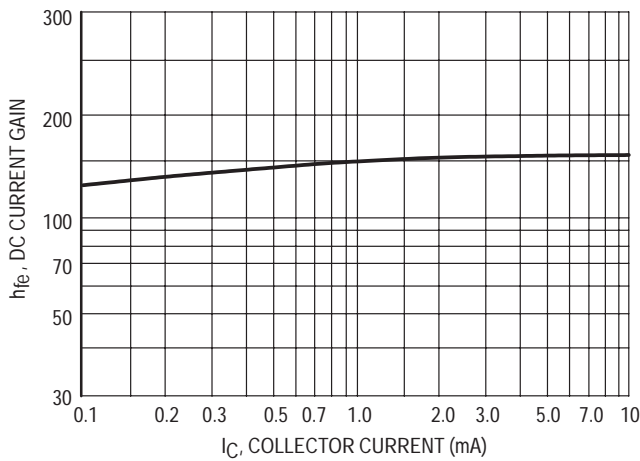


Figure 9. Current Gain

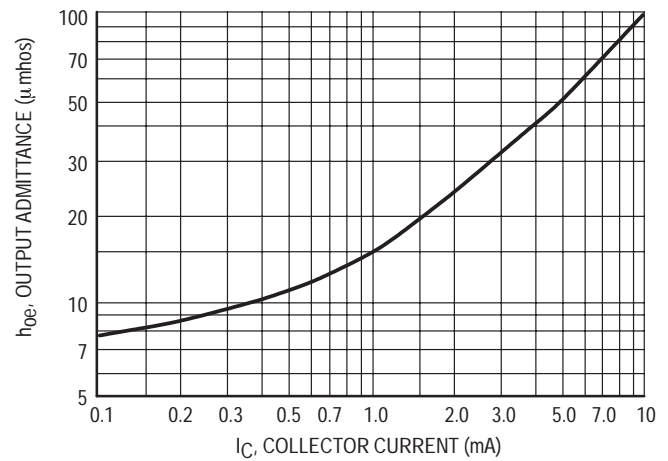


Figure 10. Output Admittance

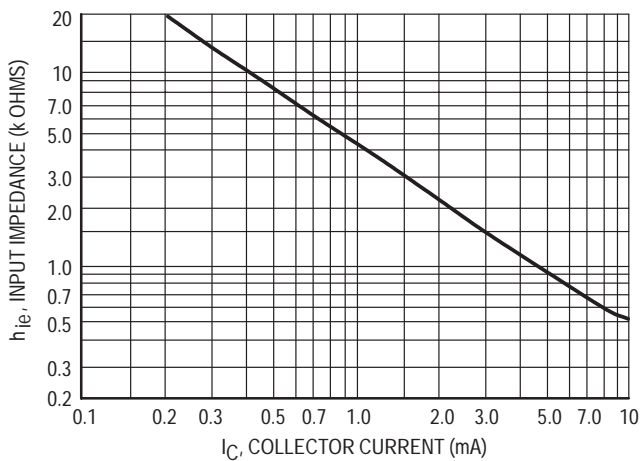


Figure 11. Input Impedance

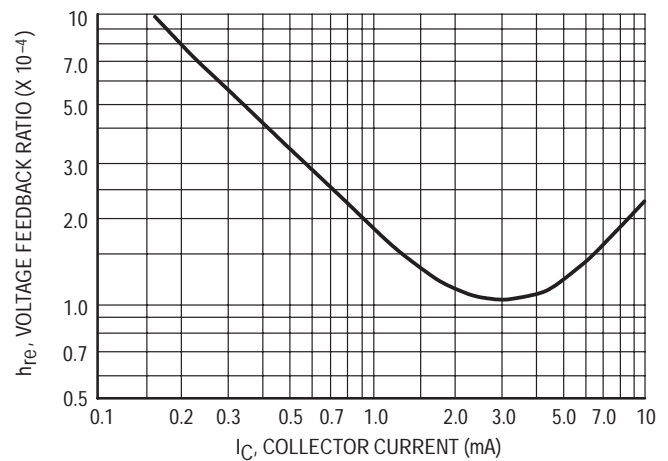


Figure 12. Voltage Feedback Ratio

TYPICAL STATIC CHARACTERISTICS

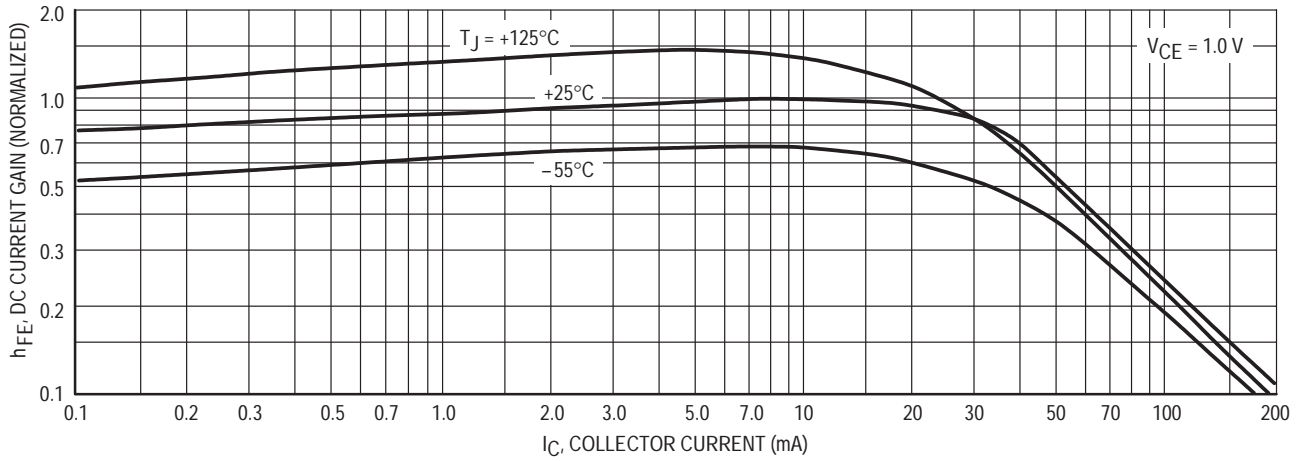


Figure 13. DC Current Gain

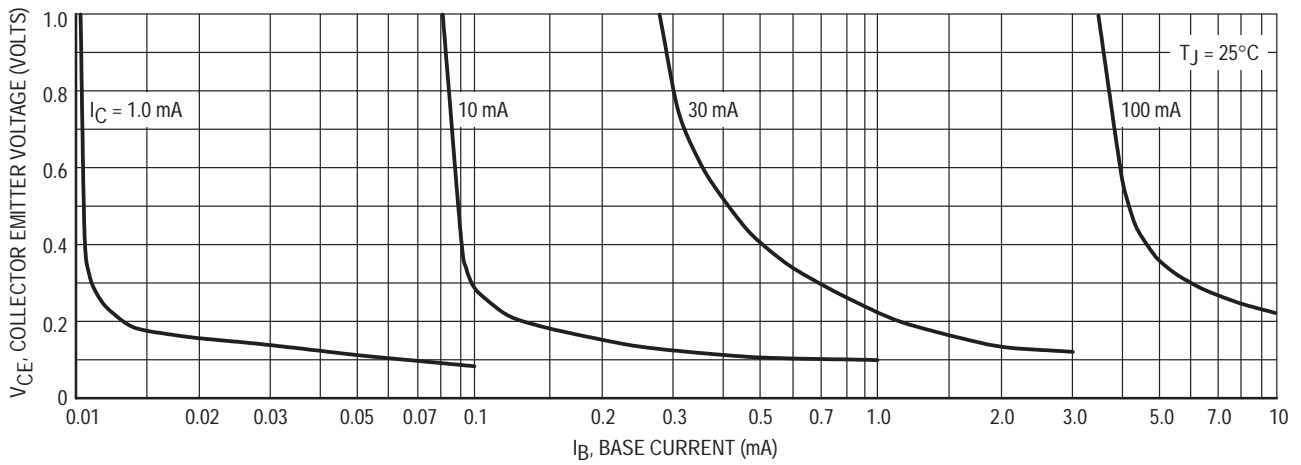


Figure 14. Collector Saturation Region

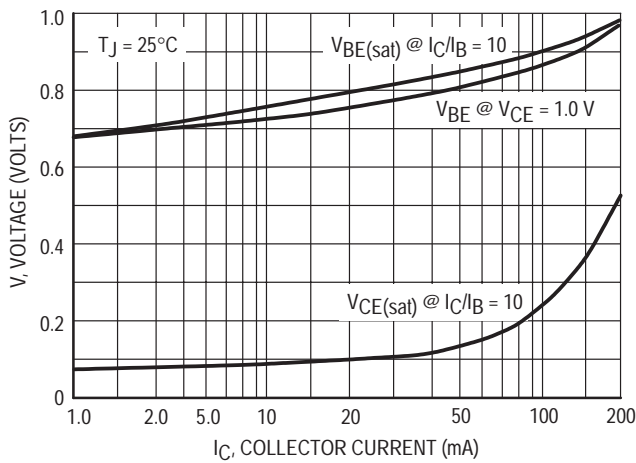


Figure 15. "ON" Voltages

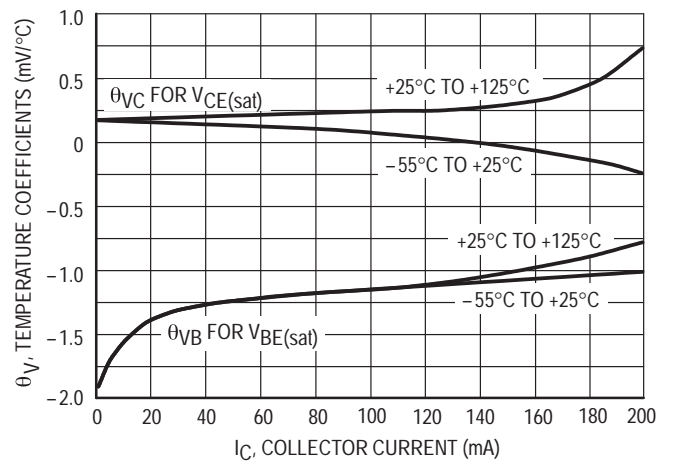
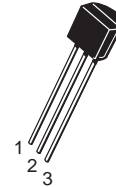
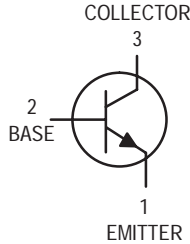


Figure 16. Temperature Coefficients

General Purpose Transistors

NPN Silicon

2N4123
2N4124



CASE 29-04, STYLE 1
TO-92 (TO-226AA)

MAXIMUM RATINGS

Rating	Symbol	2N4123	2N4124	Unit
Collector–Emitter Voltage	V_{CEO}	30	25	Vdc
Collector–Base Voltage	V_{CBO}	40	30	Vdc
Emitter–Base Voltage	V_{EBO}	5.0		Vdc
Collector Current — Continuous	I_C	200		mAdc
Total Device Dissipation @ $T_A = 25^\circ\text{C}$ Derate above 25°C	P_D	625	5.0	mW mW/°C
Total Device Dissipation @ $T_C = 25^\circ\text{C}$ Derate above 25°C	P_D	1.5	12	Watts mW/°C
Operating and Storage Junction Temperature Range	T_J, T_{stg}	–55 to +150		°C

THERMAL CHARACTERISTICS

Characteristic	Symbol	Max	Unit
Thermal Resistance, Junction to Ambient	$R_{\theta JA}$	200	°C/W
Thermal Resistance, Junction to Case	$R_{\theta JC}$	83.3	°C/W

ELECTRICAL CHARACTERISTICS ($T_A = 25^\circ\text{C}$ unless otherwise noted)

Characteristic	Symbol	Min	Max	Unit
----------------	--------	-----	-----	------

OFF CHARACTERISTICS

Collector–Emitter Breakdown Voltage ⁽¹⁾ ($I_C = 1.0 \text{ mAdc}, I_E = 0$)	2N4123 2N4124	$V_{(BR)CEO}$	30 25	— —	Vdc
Collector–Base Breakdown Voltage ($I_C = 10 \mu\text{Adc}, I_E = 0$)	2N4123 2N4124	$V_{(BR)CBO}$	40 30	— —	Vdc
Emitter–Base Breakdown Voltage ($I_E = 10 \mu\text{Adc}, I_C = 0$)		$V_{(BR)EBO}$	5.0	—	Vdc
Collector Cutoff Current ($V_{CB} = 20 \text{ Vdc}, I_E = 0$)		I_{CBO}	—	50	nAdc
Emitter Cutoff Current ($V_{EB} = 3.0 \text{ Vdc}, I_C = 0$)		I_{EBO}	—	50	nAdc

1. Pulse Test: Pulse Width = 300 μs , Duty Cycle = 2.0%.

ELECTRICAL CHARACTERISTICS ($T_A = 25^\circ\text{C}$ unless otherwise noted) (Continued)

Characteristic	Symbol	Min	Max	Unit
ON CHARACTERISTICS				
DC Current Gain ⁽¹⁾ ($I_C = 2.0\text{ mAdc}$, $V_{CE} = 1.0\text{ Vdc}$)	h_{FE}	50	150	—
2N4123		120	360	
2N4124				
($I_C = 50\text{ mAdc}$, $V_{CE} = 1.0\text{ Vdc}$)		25	—	
2N4123		60	—	
2N4124				
Collector–Emitter Saturation Voltage ⁽¹⁾ ($I_C = 50\text{ mAdc}$, $I_B = 5.0\text{ mAdc}$)	$V_{CE(sat)}$	—	0.3	Vdc
Base–Emitter Saturation Voltage ⁽¹⁾ ($I_C = 50\text{ mAdc}$, $I_B = 5.0\text{ mAdc}$)	$V_{BE(sat)}$	—	0.95	Vdc

SMALL–SIGNAL CHARACTERISTICS

Current–Gain — Bandwidth Product ($I_C = 10\text{ mAdc}$, $V_{CE} = 20\text{ Vdc}$, $f = 100\text{ MHz}$)	f_T	250	—	MHz
2N4123		300	—	
2N4124				
Input Capacitance ($V_{EB} = 0.5\text{ Vdc}$, $I_C = 0$, $f = 1.0\text{ MHz}$)	C_{ibo}	—	8.0	pF
Collector–Base Capacitance ($I_E = 0$, $V_{CB} = 5.0\text{ V}$, $f = 1.0\text{ MHz}$)	C_{cb}	—	4.0	pF
Small–Signal Current Gain ($I_C = 2.0\text{ mAdc}$, $V_{CE} = 10\text{ Vdc}$, $R_S = 10\text{ k ohm}$, $f = 1.0\text{ kHz}$)	h_{fe}	50	200	—
2N4123		120	480	
2N4124				
Current Gain — High Frequency ($I_C = 10\text{ mAdc}$, $V_{CE} = 20\text{ Vdc}$, $f = 100\text{ MHz}$)	$ h_{fe} $	2.5	—	—
2N4123		3.0	—	
2N4124				
($I_C = 2.0\text{ mAdc}$, $V_{CE} = 10\text{ V}$, $f = 1.0\text{ kHz}$)		50	200	
($I_C = 2.0\text{ mAdc}$, $V_{CE} = 10\text{ V}$, $f = 1.0\text{ kHz}$)		120	480	
2N4123				
2N4124				
Noise Figure ($I_C = 100\text{ }\mu\text{A}$, $V_{CE} = 5.0\text{ Vdc}$, $R_S = 1.0\text{ k ohm}$, $f = 1.0\text{ kHz}$)	NF	—	6.0	dB
2N4123		—	5.0	
2N4124				

1. Pulse Test: Pulse Width = 300 μs , Duty Cycle = 2.0%.

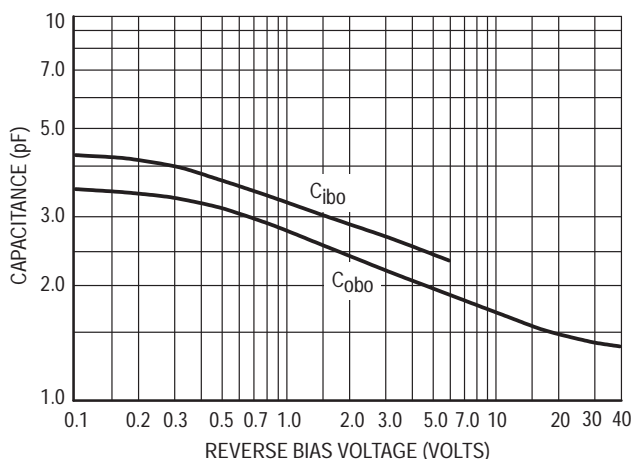


Figure 1. Capacitance

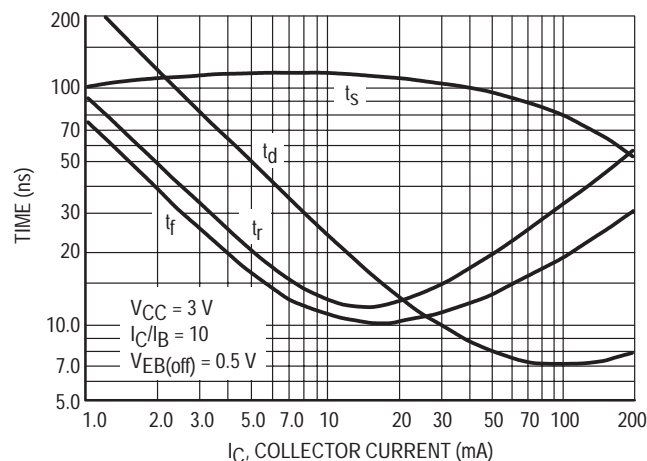


Figure 2. Switching Times

AUDIO SMALL-SIGNAL CHARACTERISTICS

NOISE FIGURE

($V_{CE} = 5 \text{ Vdc}$, $T_A = 25^\circ\text{C}$)
 Bandwidth = 1.0 Hz

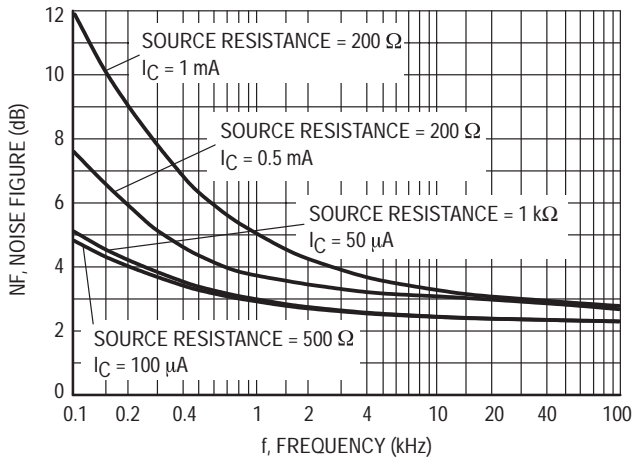


Figure 3. Frequency Variations

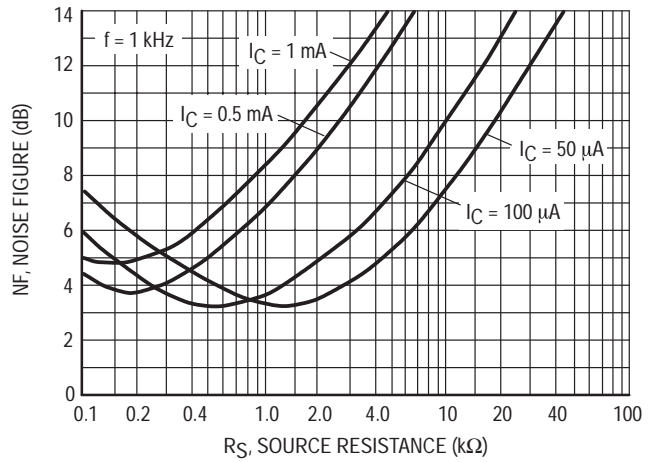


Figure 4. Source Resistance

h PARAMETERS

($V_{CE} = 10 \text{ V}$, $f = 1 \text{ kHz}$, $T_A = 25^\circ\text{C}$)

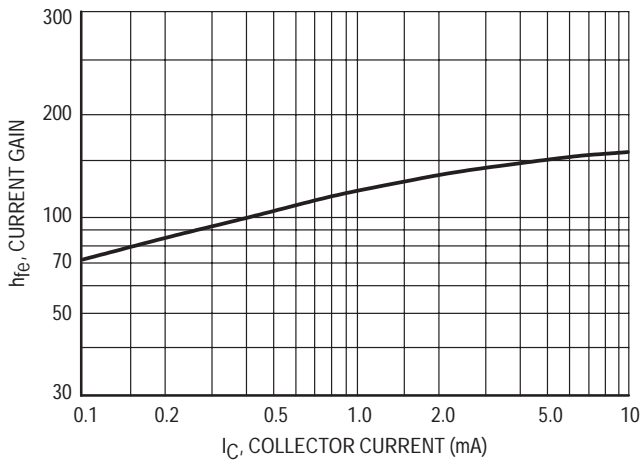


Figure 5. Current Gain

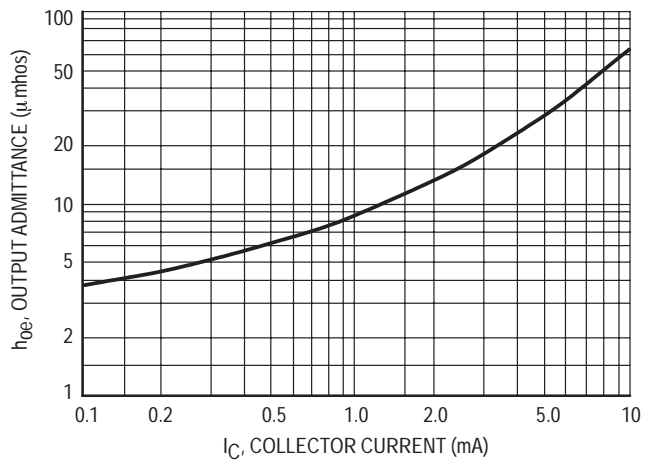


Figure 6. Output Admittance

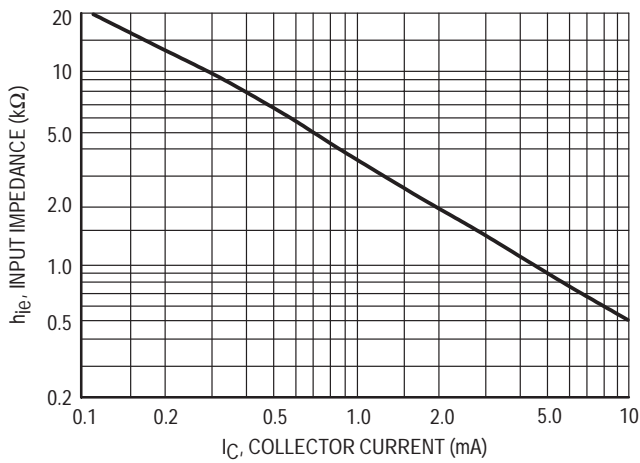


Figure 7. Input Impedance

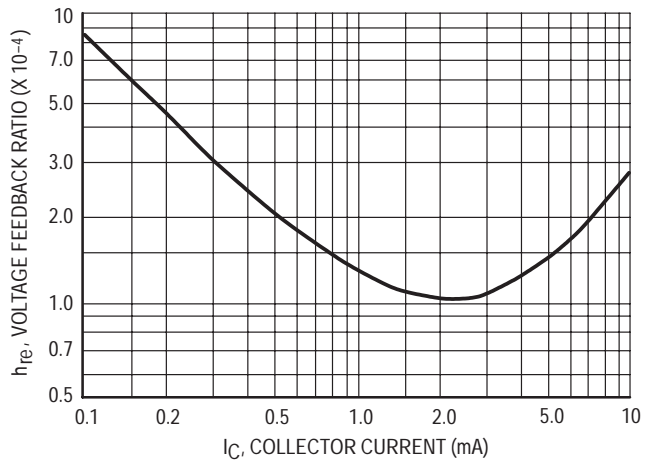


Figure 8. Voltage Feedback Ratio

STATIC CHARACTERISTICS

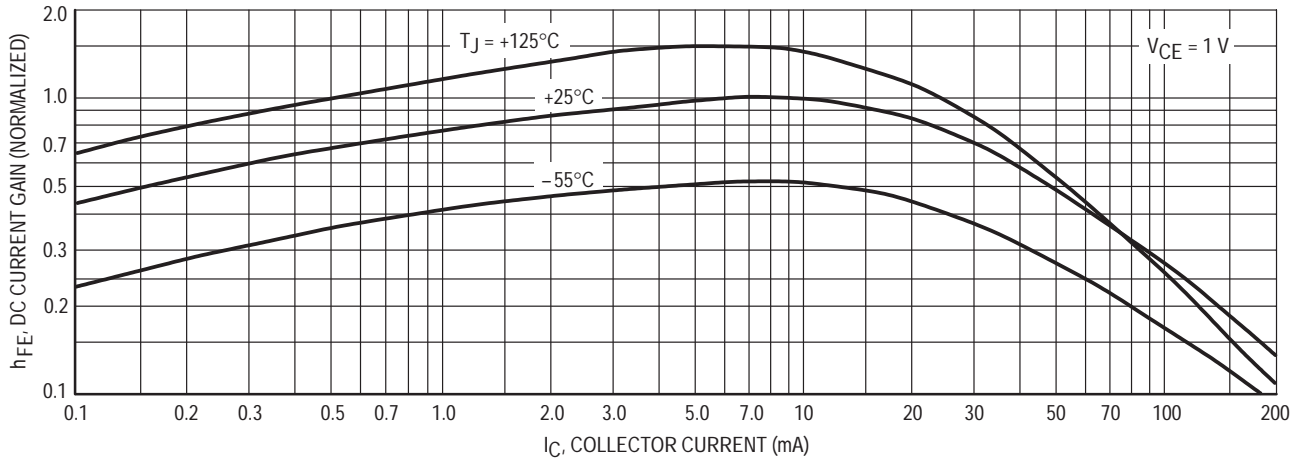


Figure 9. DC Current Gain

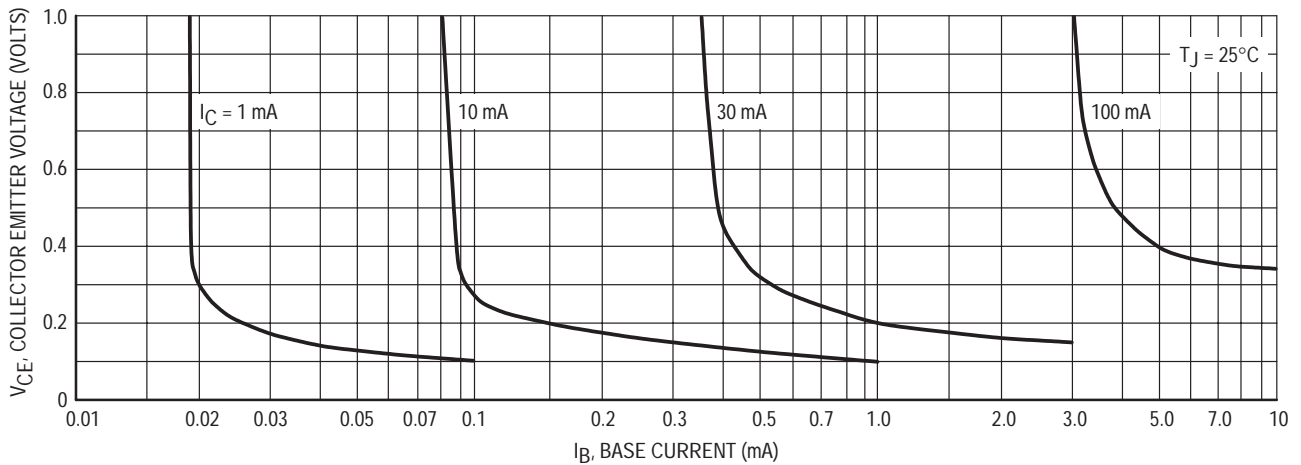


Figure 10. Collector Saturation Region

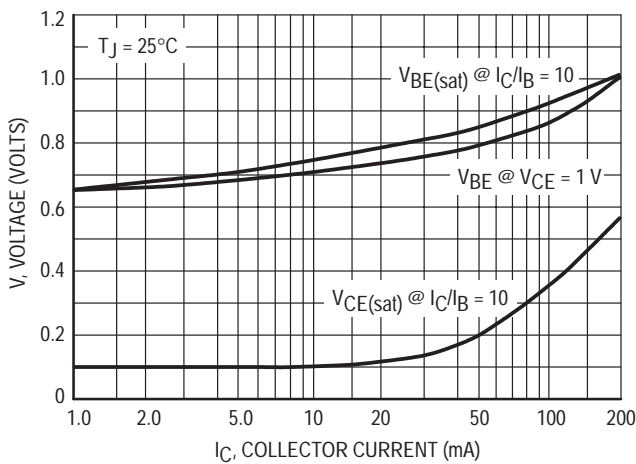


Figure 11. "On" Voltages

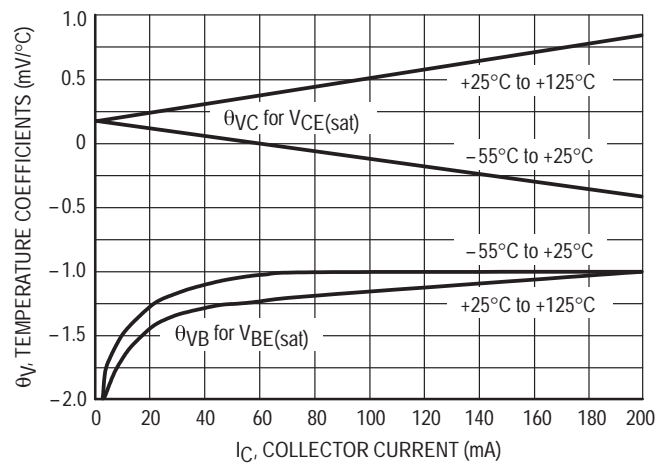
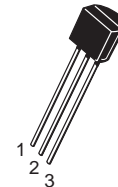
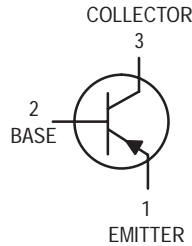


Figure 12. Temperature Coefficients

Amplifier Transistor

PNP Silicon

2N4125



CASE 29-04, STYLE 1
TO-92 (TO-226AA)

MAXIMUM RATINGS

Rating	Symbol	Value	Unit
Collector–Emitter Voltage	V_{CEO}	30	Vdc
Collector–Base Voltage	V_{CBO}	30	Vdc
Emitter–Base Voltage	V_{EBO}	4.0	Vdc
Collector Current — Continuous	I_C	200	mAdc
Total Device Dissipation @ $T_A = 25^\circ\text{C}$ Derate above 25°C	P_D	625 5.0	mW mW/ $^\circ\text{C}$
Total Device Dissipation @ $T_C = 25^\circ\text{C}$ Derate above 25°C	P_D	1.5 12	Watts mW/ $^\circ\text{C}$
Operating and Storage Junction Temperature Range	T_J, T_{stg}	-55 to +150	$^\circ\text{C}$

THERMAL CHARACTERISTICS

Characteristic	Symbol	Max	Unit
Thermal Resistance, Junction to Ambient	$R_{\theta JA}$	200	$^\circ\text{C}/\text{W}$
Thermal Resistance, Junction to Case	$R_{\theta JC}$	83.3	$^\circ\text{C}/\text{W}$

ELECTRICAL CHARACTERISTICS ($T_A = 25^\circ\text{C}$ unless otherwise noted)

Characteristic	Symbol	Min	Max	Unit
----------------	--------	-----	-----	------

OFF CHARACTERISTICS

Collector–Emitter Breakdown Voltage ⁽¹⁾ ($I_C = 1.0 \text{ mAdc}, I_B = 0$)	$V_{(BR)CEO}$	30	—	Vdc
Collector–Base Breakdown Voltage ($I_C = 10 \mu\text{Adc}, I_E = 0$)	$V_{(BR)CBO}$	30	—	Vdc
Emitter–Base Breakdown Voltage ($I_E = 10 \mu\text{Adc}, I_C = 0$)	$V_{(BR)EBO}$	4.0	—	Vdc
Collector Cutoff Current ($V_{CB} = 20 \text{ Vdc}, I_E = 0$)	I_{CBO}	—	50	nAdc
Emitter Cutoff Current ($V_{EB} = 3.0 \text{ Vdc}, I_C = 0$)	I_{EBO}	—	50	nAdc

1. Pulse Test: Pulse Width $\leq 300 \mu\text{s}$, Duty Cycle = 2.0%.

ELECTRICAL CHARACTERISTICS ($T_A = 25^\circ\text{C}$ unless otherwise noted) (Continued)

Characteristic	Symbol	Min	Max	Unit
ON CHARACTERISTICS				
DC Current Gain ⁽¹⁾ ($I_C = 2.0 \text{ mA}$, $V_{CE} = 1.0 \text{ V}$) ($I_C = 50 \text{ mA}$, $V_{CE} = 1.0 \text{ V}$)	h_{FE}	50 25	150 —	—
Collector–Emitter Saturation Voltage ⁽¹⁾ ($I_C = 50 \text{ mA}$, $I_B = 5.0 \text{ mA}$)	$V_{CE(sat)}$	—	0.4	Vdc
Base–Emitter Saturation Voltage ⁽¹⁾ ($I_C = 50 \text{ mA}$, $I_B = 5.0 \text{ mA}$)	$V_{BE(sat)}$	—	0.95	Vdc

SMALL–SIGNAL CHARACTERISTICS

Current–Gain — Bandwidth Product ($I_C = 10 \text{ mA}$, $V_{CE} = 20 \text{ V}$, $f = 100 \text{ MHz}$)	f_T	200	—	MHz
Input Capacitance ($V_{EB} = 0.5 \text{ V}$, $I_C = 0$, $f = 1.0 \text{ MHz}$)	C_{ibo}	—	10	pF
Collector–Base Capacitance ($V_{CB} = 5.0 \text{ V}$, $I_E = 0$, $f = 1.0 \text{ MHz}$)	C_{cb}	—	4.5	pF
Small–Signal Current Gain ($I_C = 2.0 \text{ mA}$, $V_{CE} = 10 \text{ V}$, $f = 1.0 \text{ kHz}$)	h_{fe}	50	200	—
Current Gain — High Frequency ($I_C = 10 \text{ mA}$, $V_{CE} = 20 \text{ V}$, $f = 100 \text{ MHz}$)	$ h_{fe} $	2.0	—	—
Noise Figure ($I_C = 100 \mu\text{A}$, $V_{CE} = 5.0 \text{ V}$, $R_S = 1.0 \text{ k}\Omega$, $f = 1.0 \text{ kHz}$)	NF	—	5.0	dB

1. Pulse Test: Pulse Width $\leq 300 \mu\text{s}$, Duty Cycle = 2.0%.

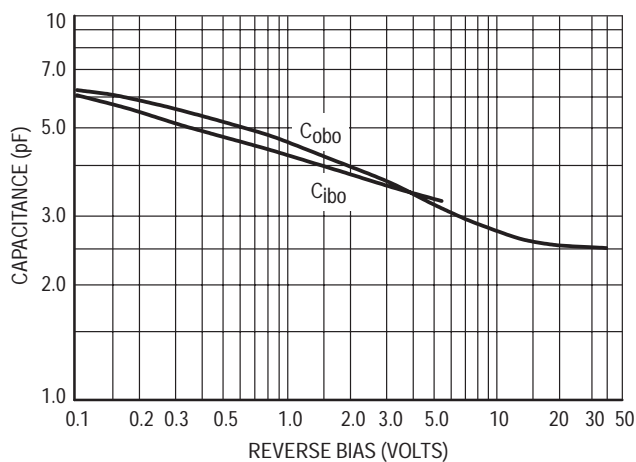


Figure 1. Capacitance

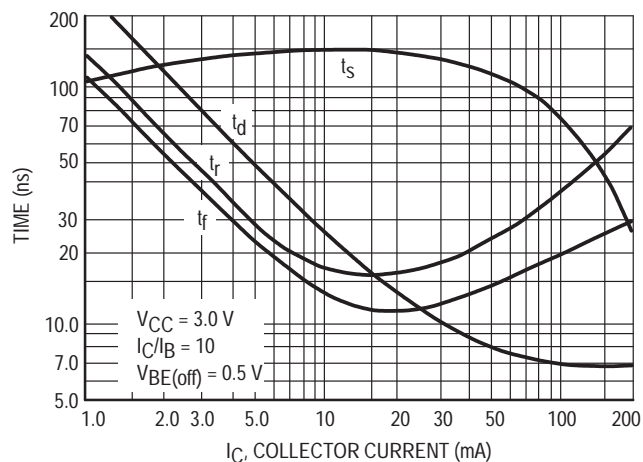


Figure 2. Switching Times

AUDIO SMALL-SIGNAL CHARACTERISTICS

NOISE FIGURE

$V_{CE} = -5.0 \text{ Vdc}$, $T_A = 25^\circ\text{C}$
Bandwidth = 1.0 Hz

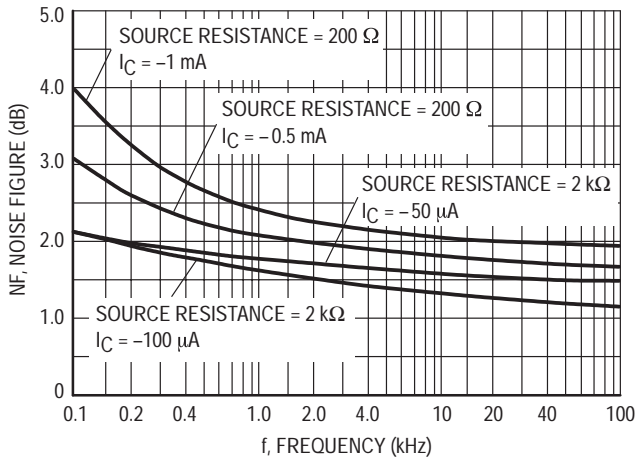


Figure 3. Frequency Variations

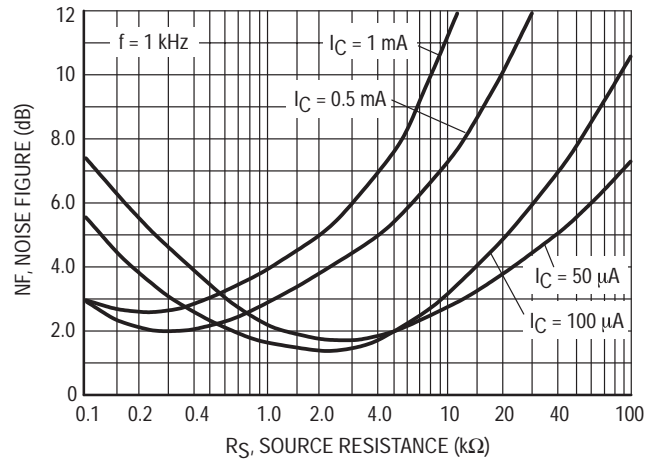


Figure 4. Source Resistance

h PARAMETERS

$V_{CE} = 10 \text{ V}$, $f = 1 \text{ kHz}$, $T_A = 25^\circ\text{C}$

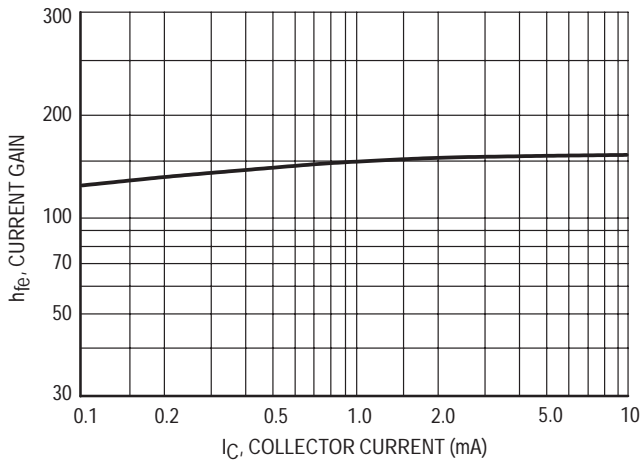


Figure 5. Current Gain

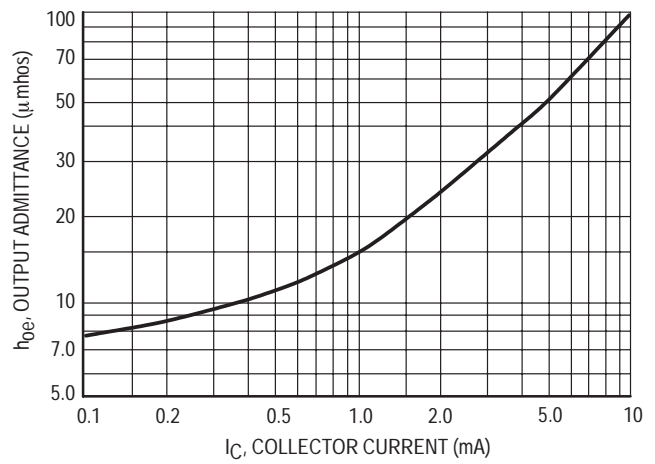


Figure 6. Output Admittance

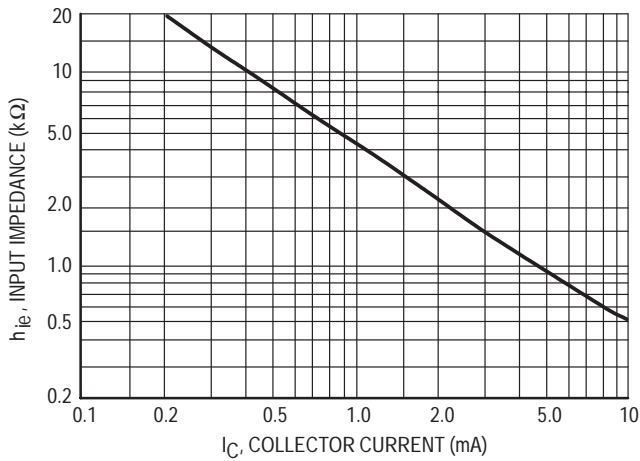


Figure 7. Input Impedance

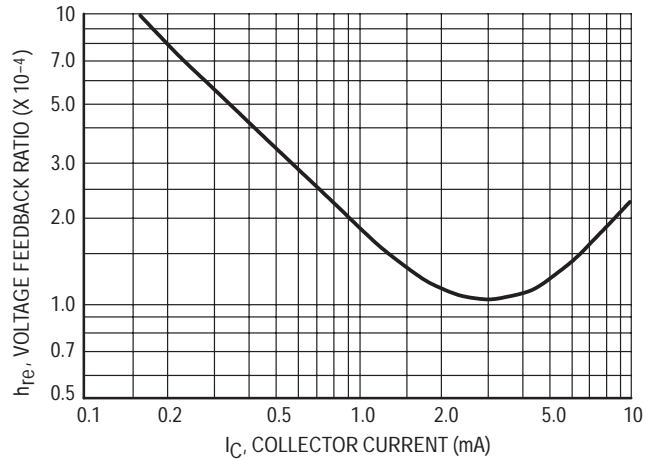


Figure 8. Voltage Feedback Ratio

STATIC CHARACTERISTICS

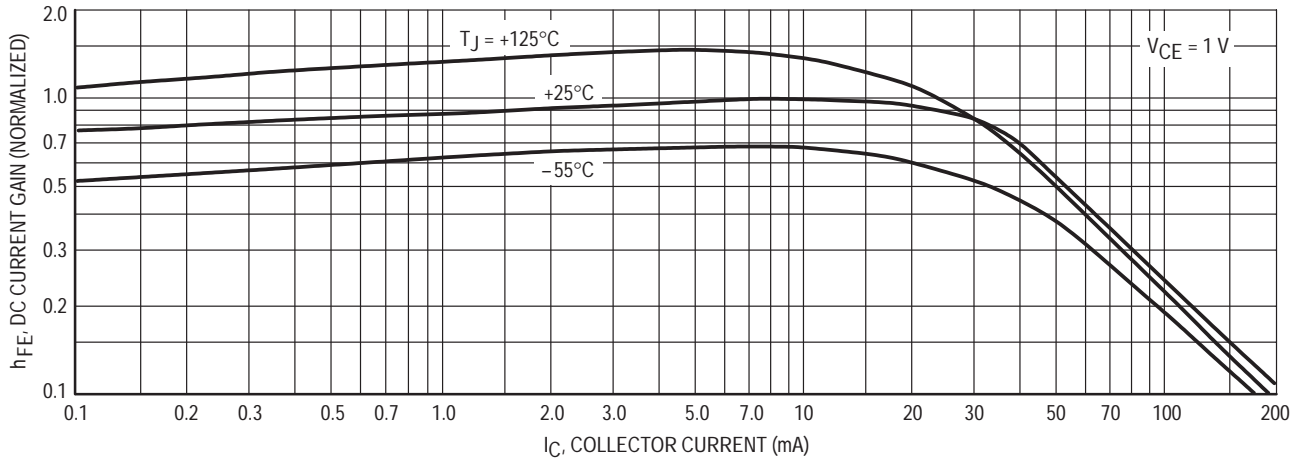


Figure 9. DC Current Gain

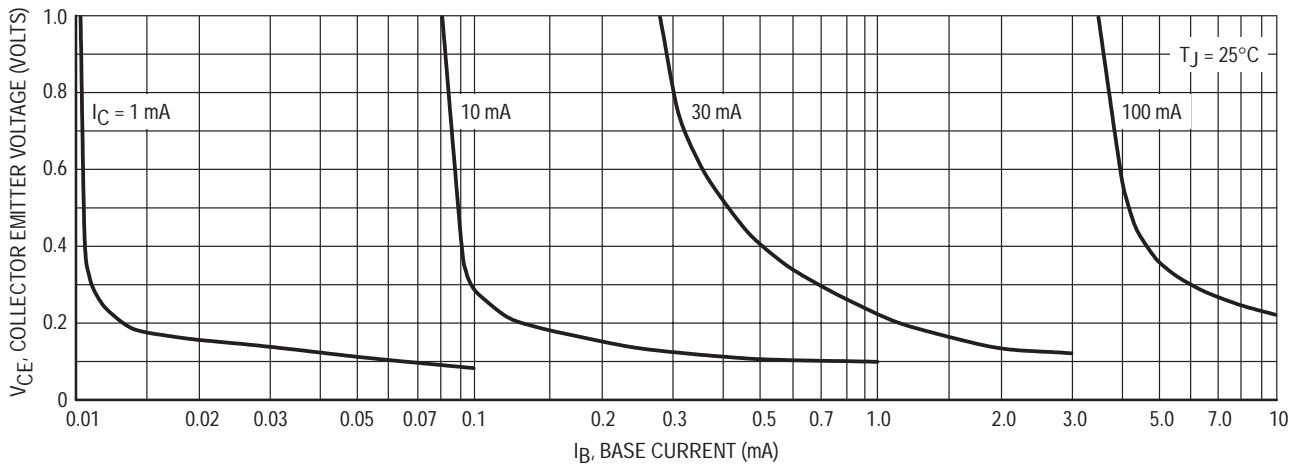


Figure 10. Collector Saturation Region

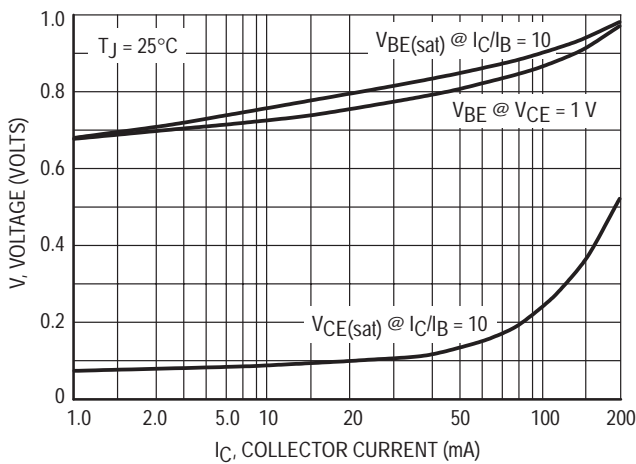


Figure 11. "On" Voltages

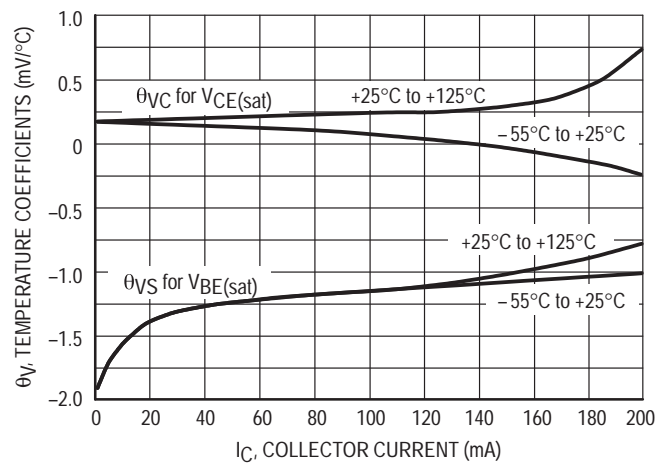
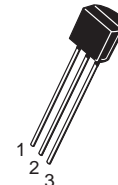
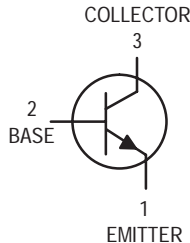


Figure 12. Temperature Coefficients

General Purpose Transistor

NPN Silicon

2N4264



CASE 29-04, STYLE 1
TO-92 (TO-226AA)

MAXIMUM RATINGS

Rating	Symbol	Value	Unit
Collector–Emitter Voltage	V_{CEO}	15	Vdc
Collector–Base Voltage	V_{CBO}	30	Vdc
Emitter–Base Voltage	V_{EBO}	6.0	Vdc
Collector Current — Continuous	I_C	200	mAdc
Total Device Dissipation @ $T_A = 25^\circ\text{C}$ Derate above 25°C	P_D	350 2.8	mW mW/ $^\circ\text{C}$
Total Device Dissipation @ $T_C = 25^\circ\text{C}$ Derate above 25°C	P_D	1.0 8.0	Watts mW/ $^\circ\text{C}$
Operating and Storage Junction Temperature Range	T_J, T_{stg}	-55 to +150	$^\circ\text{C}$

THERMAL CHARACTERISTICS

Characteristic	Symbol	Max	Unit
Thermal Resistance, Junction to Ambient	$R_{\theta JA}$	357	$^\circ\text{C}/\text{W}$
Thermal Resistance, Junction to Case	$R_{\theta JC}$	125	$^\circ\text{C}/\text{W}$

ELECTRICAL CHARACTERISTICS ($T_A = 25^\circ\text{C}$ unless otherwise noted)

Characteristic	Symbol	Min	Max	Unit
----------------	--------	-----	-----	------

OFF CHARACTERISTICS

Collector–Emitter Breakdown Voltage ($I_C = 1.0$ mAdc, $I_B = 0$)	$V_{(BR)CEO}$	15	—	Vdc
Collector–Base Breakdown Voltage ($I_C = 10$ μAdc , $I_E = 0$)	$V_{(BR)CBO}$	30	—	Vdc
Emitter–Base Breakdown Voltage ($I_E = 10$ μAdc , $I_C = 0$)	$V_{(BR)EBO}$	6.0	—	Vdc
Base Cutoff Current ($V_{CE} = 12$ Vdc, $V_{EB(off)} = 0.25$ Vdc) ($V_{CE} = 12$ Vdc, $V_{EB(off)} = 0.25$ Vdc, $T_A = 100^\circ\text{C}$)	I_{BEV}	— —	0.1 10	μAdc
Collector Cutoff Current ($V_{CE} = 12$ Vdc, $V_{EB(off)} = 0.25$ Vdc)	I_{CEX}	—	100	nAdc

ELECTRICAL CHARACTERISTICS ($T_A = 25^\circ\text{C}$ unless otherwise noted) (Continued)

Characteristic	Symbol	Min	Max	Unit
ON CHARACTERISTICS				
DC Current Gain ($I_C = 1.0\text{ mA}$, $V_{CE} = 1.0\text{ Vdc}$) ($I_C = 10\text{ mA}$, $V_{CE} = 1.0\text{ Vdc}$) ($I_C = 10\text{ mA}$, $V_{CE} = 1.0\text{ Vdc}$, $T_A = -55^\circ\text{C}$) ($I_C = 30\text{ mA}$, $V_{CE} = 1.0\text{ Vdc}$) ($I_C = 100\text{ mA}$, $V_{CE} = 1.0\text{ Vdc}$)(1) ($I_C = 200\text{ mA}$, $V_{CE} = 1.0\text{ Vdc}$)(1)	h_{FE}	25 40 20 40 30 20	— 160 — — — —	—
Collector–Emitter Saturation Voltage ($I_C = 10\text{ mA}$, $I_B = 1.0\text{ mA}$) ($I_C = 100\text{ mA}$, $I_B = 10\text{ mA}$)(1)	$V_{CE(sat)}$	— —	0.22 0.35	Vdc
Base–Emitter Saturation Voltage ($I_C = 10\text{ mA}$, $I_B = 1.0\text{ mA}$) ($I_C = 100\text{ mA}$, $I_B = 10\text{ mA}$)(1)	$V_{BE(sat)}$	0.65 0.75	0.8 0.95	Vdc

SMALL–SIGNAL CHARACTERISTICS

Current–Gain — Bandwidth Product ($I_C = 10\text{ mA}$, $V_{CE} = 10\text{ Vdc}$, $f = 100\text{ MHz}$)	f_T	300	—	MHz
Input Capacitance ($V_{EB} = 0.5\text{ Vdc}$, $I_C = 0$, $f = 1.0\text{ MHz}$)	C_{ibo}	—	8.0	pF
Output Capacitance ($V_{CB} = 5.0\text{ Vdc}$, $I_E = 0$, $f = 1.0\text{ MHz}$, $I_E = 0$)	C_{obo}	—	4.0	pF

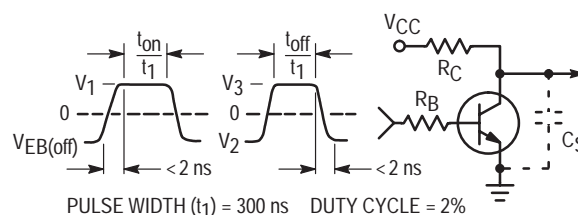
SWITCHING CHARACTERISTICS

Delay Time	($V_{CC} = 10\text{ Vdc}$, $V_{EB(off)} = 2.0\text{ Vdc}$, $I_C = 100\text{ mA}$, $I_{B1} = 10\text{ mA}$) (Fig. 1, Test Condition C)	t_d	—	8.0	ns
Rise Time		t_r	—	15	ns
Storage Time	$V_{CC} = 10\text{ Vdc}$, ($I_C = 10\text{ mA}$, for t_s) ($I_C = 100\text{ mA}$ for t_f) ($I_{B1} = -10\text{ mA}$) ($I_{B2} = 10\text{ mA}$) (Fig. 1, Test Condition C)	t_s	—	20	ns
Fall Time		t_f	—	15	ns
Turn–On Time	($V_{CC} = 3.0\text{ Vdc}$, $V_{EB(off)} = 1.5\text{ Vdc}$, $I_C = 10\text{ mA}$, $I_{B1} = 3.0\text{ mA}$) (Fig. 1, Test Condition A)	t_{on}	—	25	ns
Turn–Off Time	($V_{CC} = 3.0\text{ Vdc}$, $I_C = 10\text{ mA}$, $I_{B1} = 3.0\text{ mA}$, $I_{B2} = 1.5\text{ mA}$) (Fig. 1, Test Condition A)	t_{off}	—	35	ns
Storage Time	($V_{CC} = 10\text{ Vdc}$, $I_C = 10\text{ mA}$, $I_{B1} = I_{B2} = 10\text{ mA}$) (Fig. 1, Test Condition B)	t_s	—	20	ns
Total Control Charge	($V_{CC} = 3.0\text{ Vdc}$, $I_C = 10\text{ mA}$, $I_B = \text{mA}$) (Fig. 3, Test Condition A)	Q_T	—	80	pC

1. Pulse Test: Pulse Width = 300 μs , Duty Cycle = 2.0%.

Figure 1. Switching Time Equivalent Test Circuit

Test Condition	I_C	V_{CC}	R_S	R_C	$C_S(\text{max})$	$V_{BE(off)}$	V_1	V_2	V_3
	mA	V	Ω	Ω	pF	V	V	V	V
A	10	3	3300	270	4	-1.5	10.55	-4.15	10.70
B	10	10	560	960	4	—	—	-4.65	6.55
C	100	10	560	96	12	-2.0	6.35	-4.65	6.55



CURRENT GAIN CHARACTERISTICS

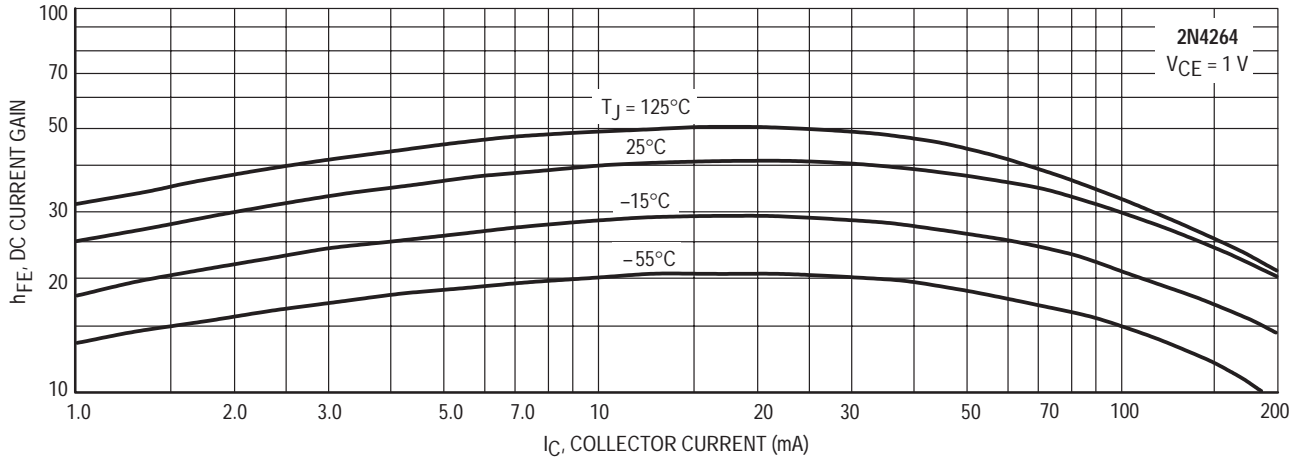


Figure 2. Minimum Current Gain

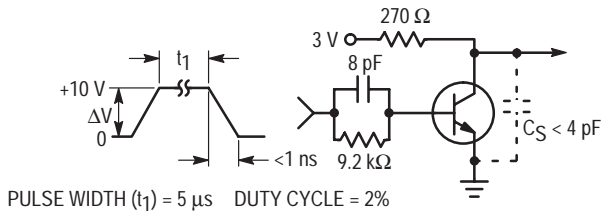


Figure 3. Q_T Test Circuit

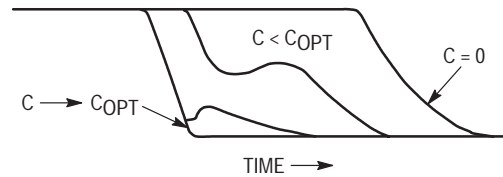


Figure 4. Turn-Off Waveform

NOTE 1

When a transistor is held in a conductive state by a base current, I_B , a charge, Q_S , is developed or "stored" in the transistor. Q_S may be written: $Q_S = Q_1 + Q_V + Q_X$.

Q_1 is the charge required to develop the required collector current. This charge is primarily a function of alpha cutoff frequency. Q_V is the charge required to charge the collector-base feedback capacity. Q_X is excess charge resulting from overdrive, i.e., operation in saturation.

The charge required to turn a transistor "on" to the edge of saturation is the sum of Q_1 and Q_V which is defined as the active region charge, Q_A . $Q_A = I_{B1}t_r$ when the transistor is driven by a constant current step (I_{B1}) and $I_{B1} < < \frac{I_C}{h_{FE}}$.

If I_B were suddenly removed, the transistor would continue to conduct until Q_S is removed from the active regions through an external path or through internal recombination. Since the internal recombination time is long compared to the ultimate capability of a transistor, a charge, Q_T , of opposite polarity, equal in magnitude, can be stored on an external capacitor, C , to neutralize the internal charge and considerably reduce the turn-off time of the transistor. Figure 3 shows the test circuit and Figure 4 the turn-off waveform. Given Q_T from Figure 13, the external C for worst-case turn-off in any circuit is: $C = Q_T/\Delta V$, where ΔV is defined in Figure 3.

“ON” CONDITION CHARACTERISTICS

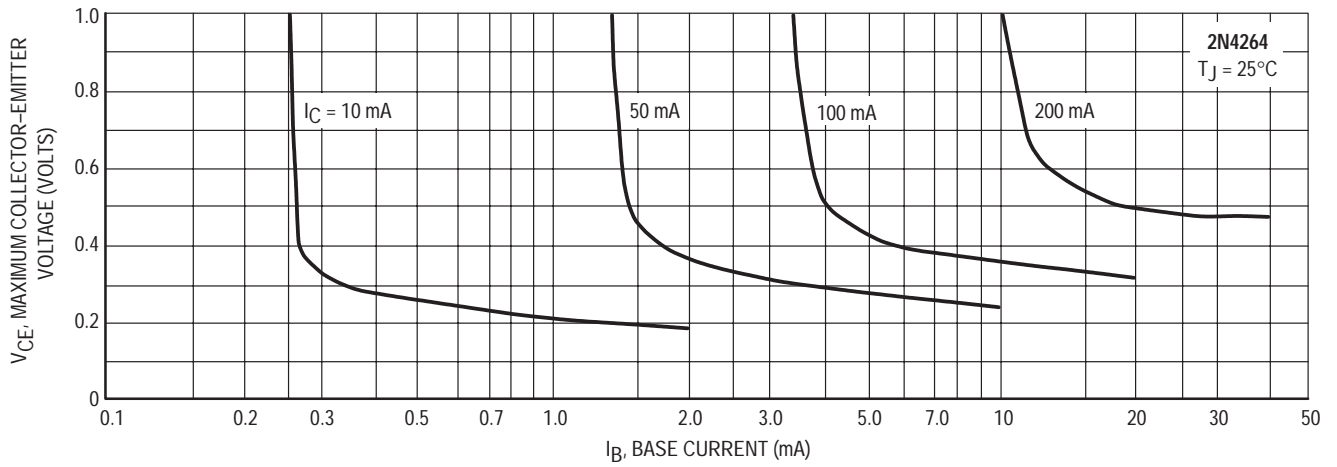


Figure 5. Collector Saturation Region

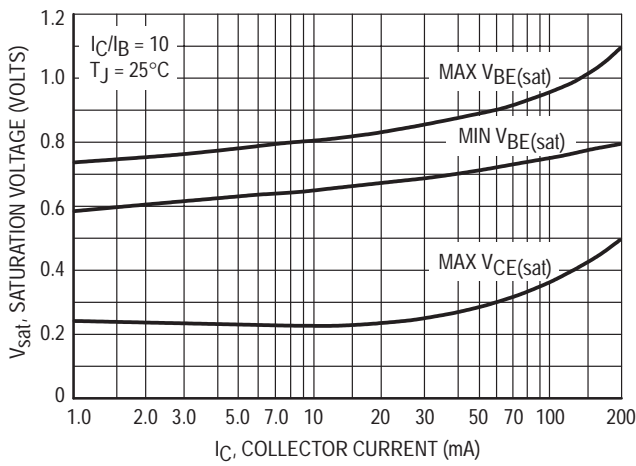


Figure 6. Saturation Voltage Limits

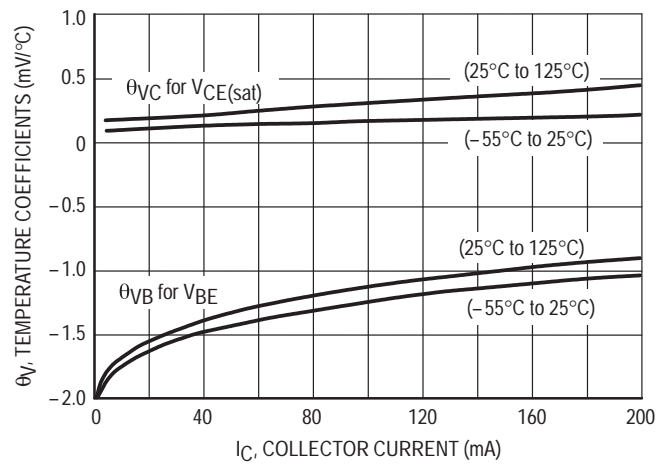


Figure 7. Temperature Coefficients

DYNAMIC CHARACTERISTICS

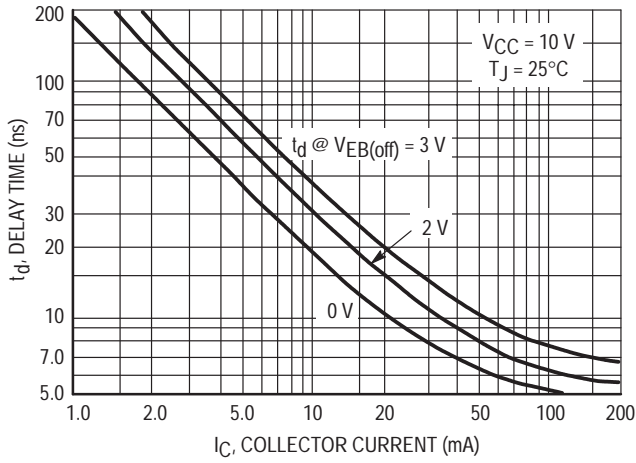


Figure 8. Delay Time

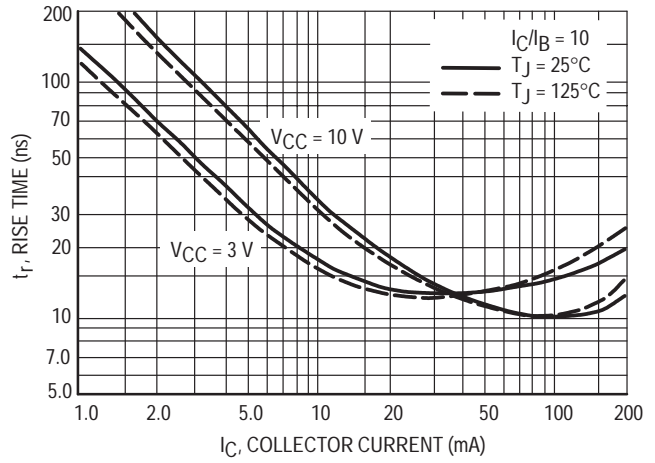


Figure 9. Rise Time

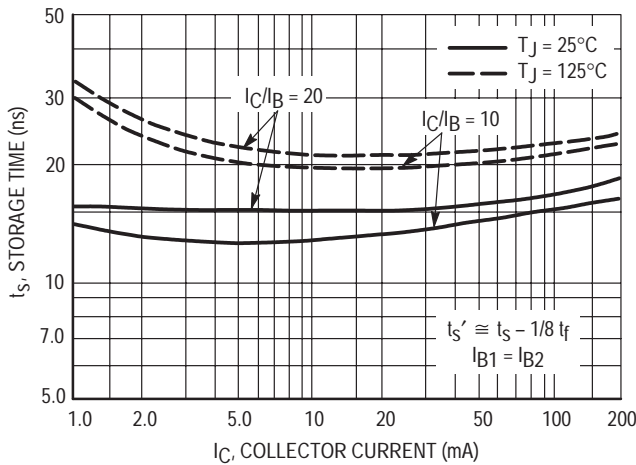


Figure 10. Storage Time

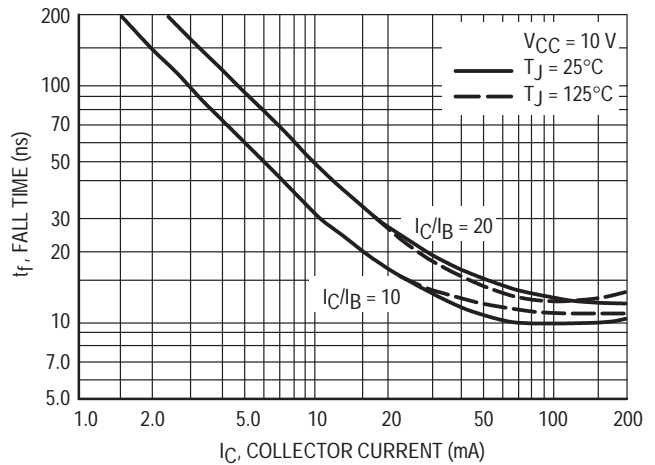


Figure 11. Fall Time

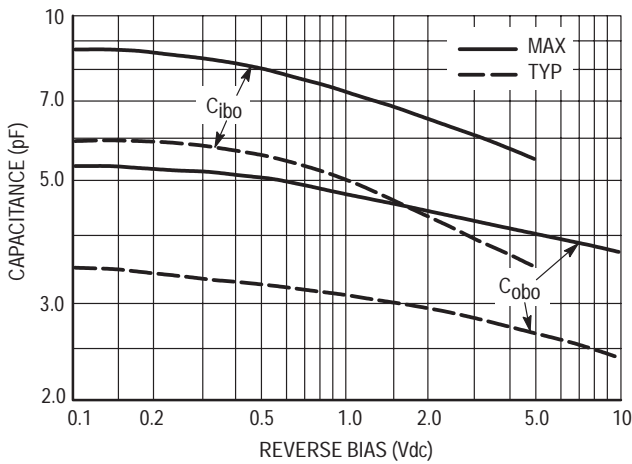


Figure 12. Junction Capacitance

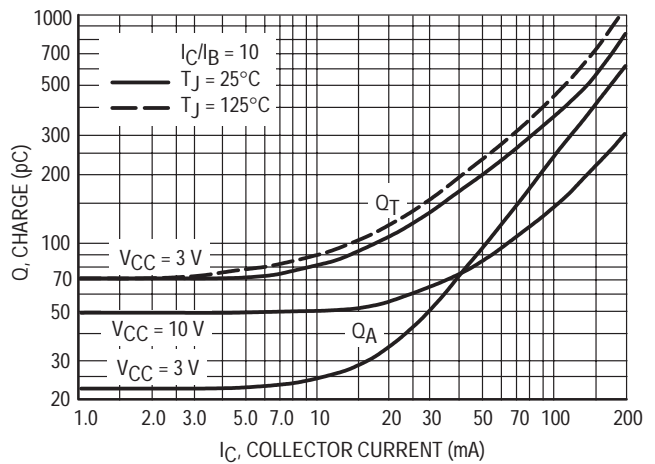


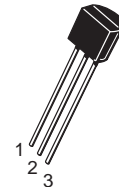
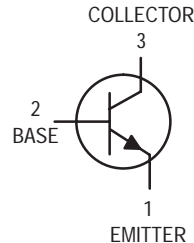
Figure 13. Maximum Charge Data

General Purpose Transistors

NPN Silicon

2N4400
2N4401*

*Motorola Preferred Device



CASE 29-04, STYLE 1
TO-92 (TO-226AA)

MAXIMUM RATINGS

Rating	Symbol	Value	Unit
Collector–Emitter Voltage	V_{CEO}	40	Vdc
Collector–Base Voltage	V_{CBO}	60	Vdc
Emitter–Base Voltage	V_{EBO}	6.0	Vdc
Collector Current — Continuous	I_C	600	mAdc
Total Device Dissipation @ $T_A = 25^\circ\text{C}$ Derate above 25°C	P_D	625 5.0	mW mW/ $^\circ\text{C}$
Total Device Dissipation @ $T_C = 25^\circ\text{C}$ Derate above 25°C	P_D	1.5 12	Watts mW/ $^\circ\text{C}$
Operating and Storage Junction Temperature Range	T_J, T_{stg}	-55 to +150	$^\circ\text{C}$

THERMAL CHARACTERISTICS

Characteristic	Symbol	Max	Unit
Thermal Resistance, Junction to Ambient	$R_{\theta JA}$	200	$^\circ\text{C}/\text{W}$
Thermal Resistance, Junction to Case	$R_{\theta JC}$	83.3	$^\circ\text{C}/\text{W}$

ELECTRICAL CHARACTERISTICS ($T_A = 25^\circ\text{C}$ unless otherwise noted)

Characteristic	Symbol	Min	Max	Unit
----------------	--------	-----	-----	------

OFF CHARACTERISTICS

Collector–Emitter Breakdown Voltage ⁽¹⁾ ($I_C = 1.0$ mAdc, $I_B = 0$)	$V_{(BR)CEO}$	40	—	Vdc
Collector–Base Breakdown Voltage ($I_C = 0.1$ mAdc, $I_E = 0$)	$V_{(BR)CBO}$	60	—	Vdc
Emitter–Base Breakdown Voltage ($I_E = 0.1$ mAdc, $I_C = 0$)	$V_{(BR)EBO}$	6.0	—	Vdc
Base Cutoff Current ($V_{CE} = 35$ Vdc, $V_{EB} = 0.4$ Vdc)	I_{BEV}	—	0.1	μAdc
Collector Cutoff Current ($V_{CE} = 35$ Vdc, $V_{EB} = 0.4$ Vdc)	I_{CEX}	—	0.1	μAdc

1. Pulse Test: Pulse Width ≤ 300 μs , Duty Cycle $\leq 2.0\%$.

Preferred devices are Motorola recommended choices for future use and best overall value.

REV 1

2N4400 2N4401

ELECTRICAL CHARACTERISTICS (T_A = 25°C unless otherwise noted) (Continued)

Characteristic	Symbol	Min	Max	Unit
ON CHARACTERISTICS(1)				
DC Current Gain (I _C = 0.1 mA _{dc} , V _{CE} = 1.0 V _{dc})	h _{FE}	20	—	—
(I _C = 1.0 mA _{dc} , V _{CE} = 1.0 V _{dc})		20	—	
		40	—	
(I _C = 10 mA _{dc} , V _{CE} = 1.0 V _{dc})		40	—	
		80	—	
(I _C = 150 mA _{dc} , V _{CE} = 1.0 V _{dc})		50	150	
		100	300	
(I _C = 500 mA _{dc} , V _{CE} = 2.0 V _{dc})		20	—	
		40	—	
Collector–Emitter Saturation Voltage (I _C = 150 mA _{dc} , I _B = 15 mA _{dc}) (I _C = 500 mA _{dc} , I _B = 50 mA _{dc})	V _{CE(sat)}	—	0.4 0.75	V _{dc}
Base–Emitter Saturation Voltage (I _C = 150 mA _{dc} , I _B = 15 mA _{dc}) (I _C = 500 mA _{dc} , I _B = 50 mA _{dc})	V _{BE(sat)}	0.75	0.95 1.2	V _{dc}

SMALL–SIGNAL CHARACTERISTICS

Current–Gain — Bandwidth Product (I _C = 20 mA _{dc} , V _{CE} = 10 V _{dc} , f = 100 MHz)	f _T	200 250	—	MHz
Collector–Base Capacitance (V _{CB} = 5.0 V _{dc} , I _E = 0, f = 1.0 MHz)	C _{cb}	—	6.5	pF
Emitter–Base Capacitance (V _{EB} = 0.5 V _{dc} , I _C = 0, f = 1.0 MHz)	C _{eb}	—	30	pF
Input Impedance (I _C = 1.0 mA _{dc} , V _{CE} = 10 V _{dc} , f = 1.0 kHz)	h _{ie}	0.5 1.0	7.5 15	k ohms
Voltage Feedback Ratio (I _C = 1.0 mA _{dc} , V _{CE} = 10 V _{dc} , f = 1.0 kHz)	h _{re}	0.1	8.0	X 10 ⁻⁴
Small–Signal Current Gain (I _C = 1.0 mA _{dc} , V _{CE} = 10 V _{dc} , f = 1.0 kHz)	h _{fe}	20 40	250 500	—
Output Admittance (I _C = 1.0 mA _{dc} , V _{CE} = 10 V _{dc} , f = 1.0 kHz)	h _{oe}	1.0	30	μmhos

SWITCHING CHARACTERISTICS

Delay Time	(V _{CC} = 30 V _{dc} , V _{BE} = 2.0 V _{dc} , I _C = 150 mA _{dc} , I _{B1} = 15 mA _{dc})	t _d	—	15	ns
Rise Time		t _r	—	20	ns
Storage Time	(V _{CC} = 30 V _{dc} , I _C = 150 mA _{dc} , I _{B1} = I _{B2} = 15 mA _{dc})	t _s	—	225	ns
Fall Time		t _f	—	30	ns

1. Pulse Test: Pulse Width ≤ 300 μs, Duty Cycle ≤ 2.0%.

SWITCHING TIME EQUIVALENT TEST CIRCUITS

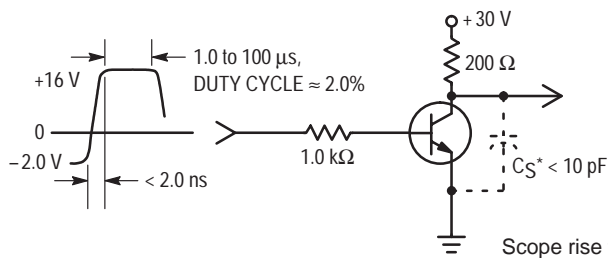


Figure 1. Turn–On Time

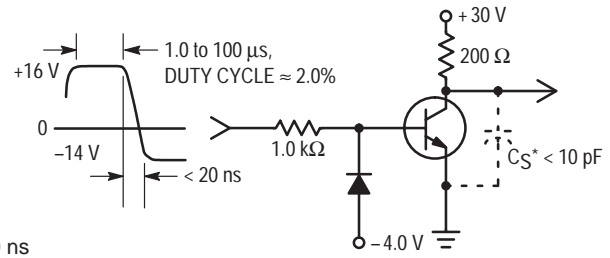


Figure 2. Turn–Off Time

TRANSIENT CHARACTERISTICS

— 25°C - - - 100°C

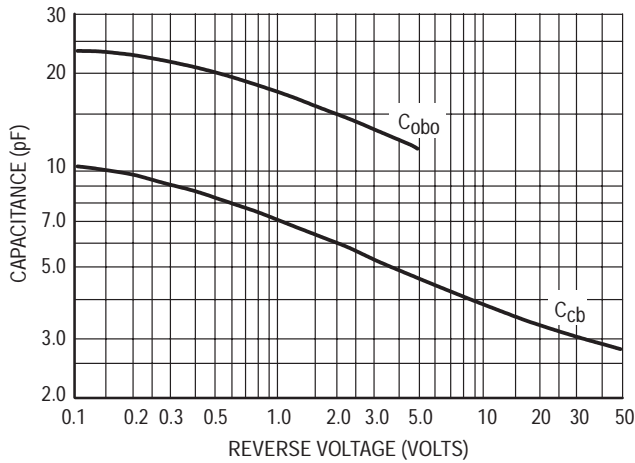


Figure 3. Capacitances

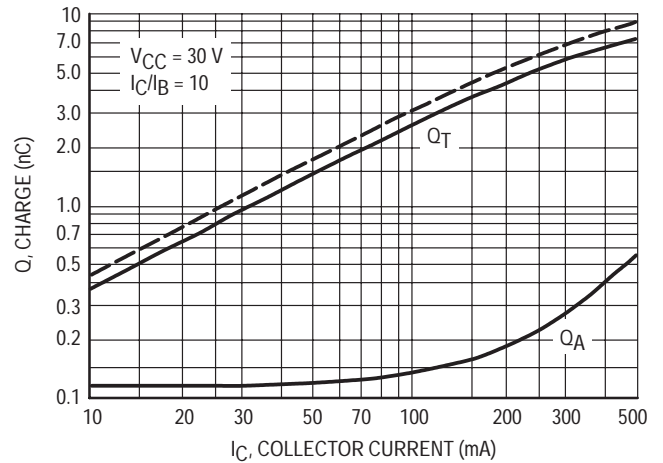


Figure 4. Charge Data

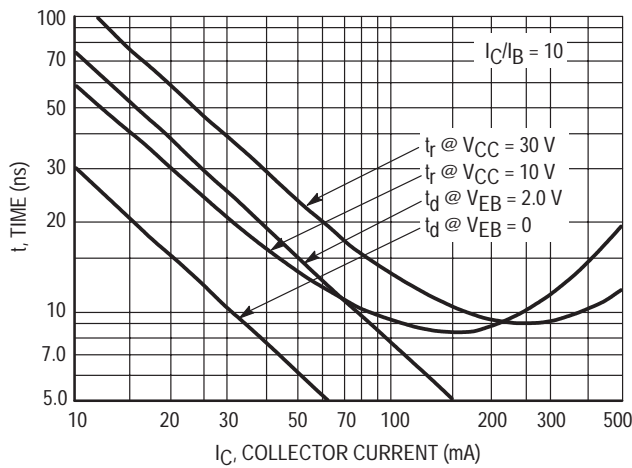


Figure 5. Turn-On Time

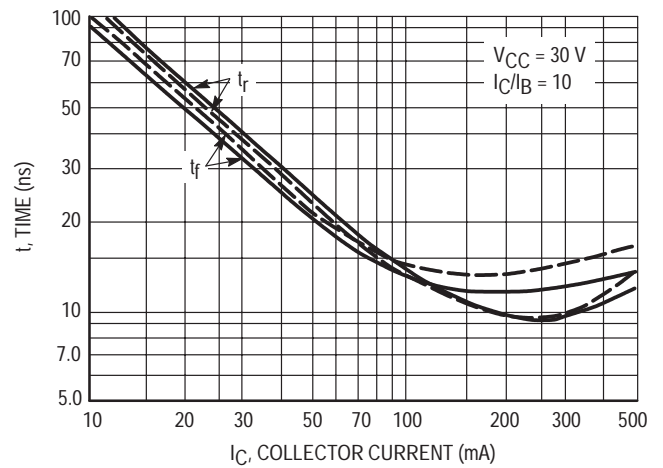


Figure 6. Rise and Fall Times

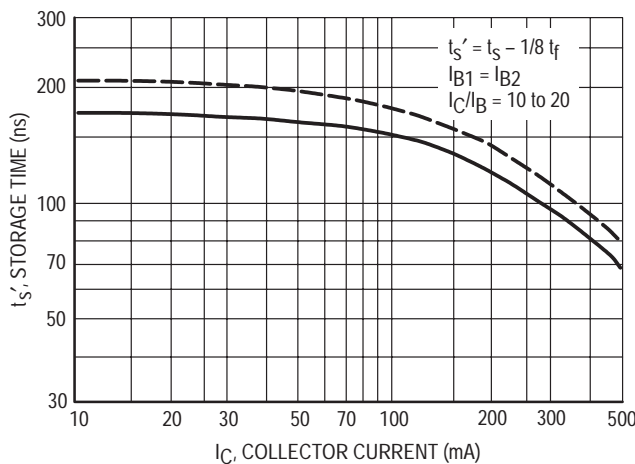


Figure 7. Storage Time

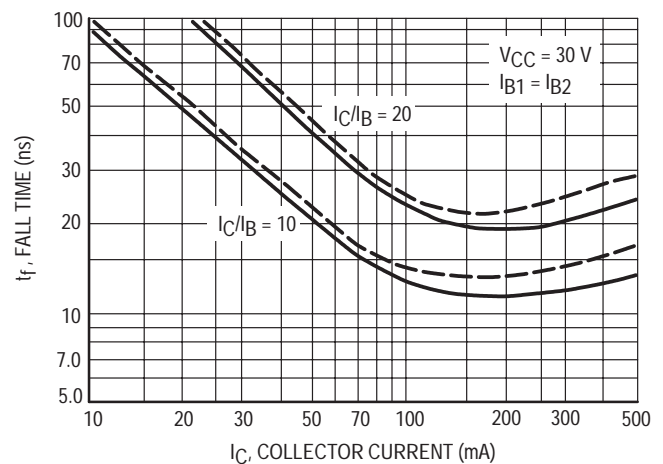


Figure 8. Fall Time

SMALL-SIGNAL CHARACTERISTICS

NOISE FIGURE

$V_{CE} = 10 \text{ Vdc}$, $T_A = 25^\circ\text{C}$
Bandwidth = 1.0 Hz

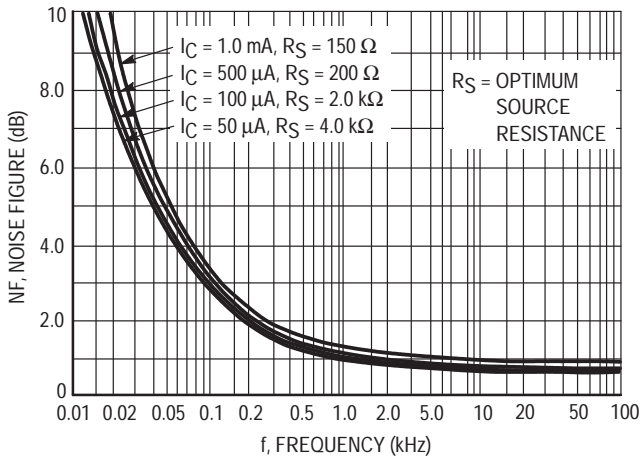


Figure 9. Frequency Effects

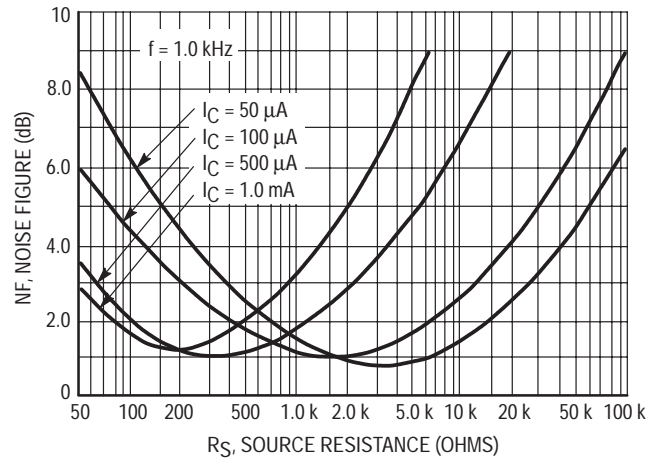


Figure 10. Source Resistance Effects

h PARAMETERS

$V_{CE} = 10 \text{ Vdc}$, $f = 1.0 \text{ kHz}$, $T_A = 25^\circ\text{C}$

This group of graphs illustrates the relationship between h_{fe} and other "h" parameters for this series of transistors. To obtain these curves, a high-gain and a low-gain unit were

selected from both the 2N4400 and 2N4401 lines, and the same units were used to develop the correspondingly numbered curves on each graph.

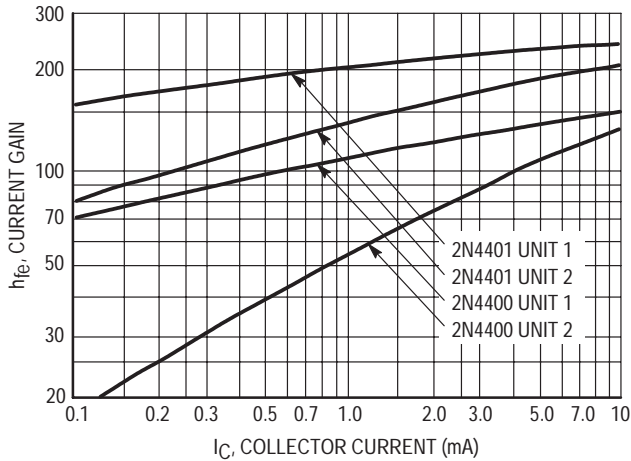


Figure 11. Current Gain

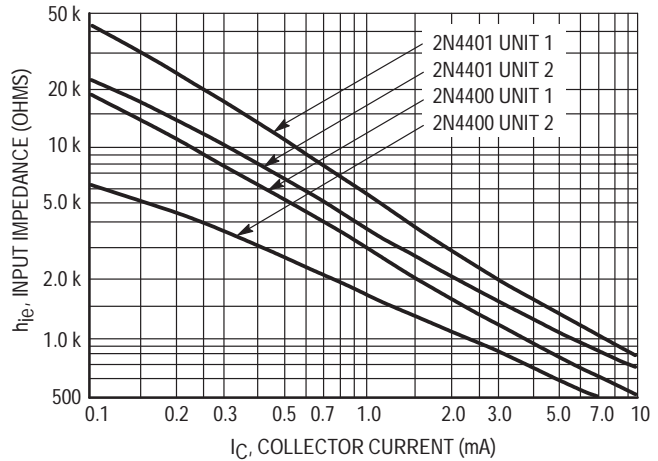


Figure 12. Input Impedance

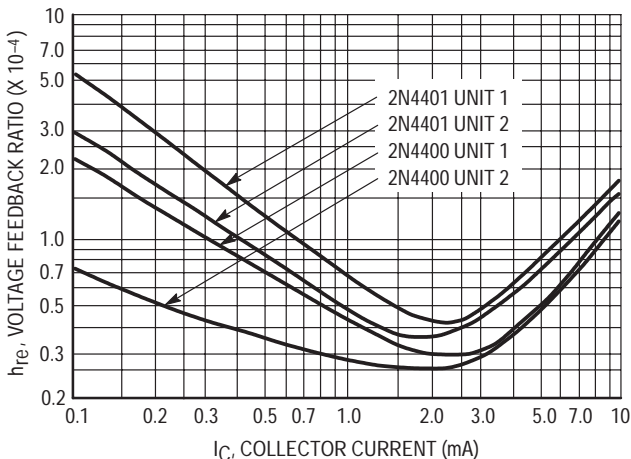


Figure 13. Voltage Feedback Ratio

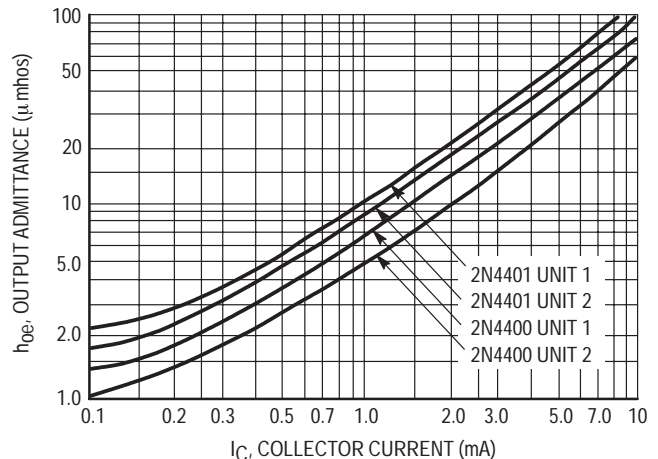


Figure 14. Output Admittance

STATIC CHARACTERISTICS

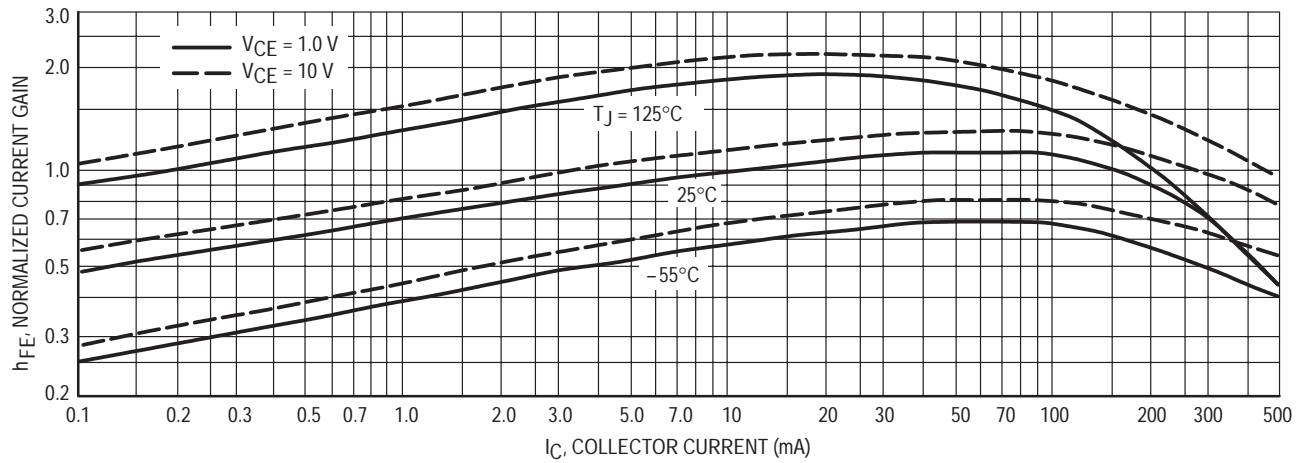


Figure 15. DC Current Gain

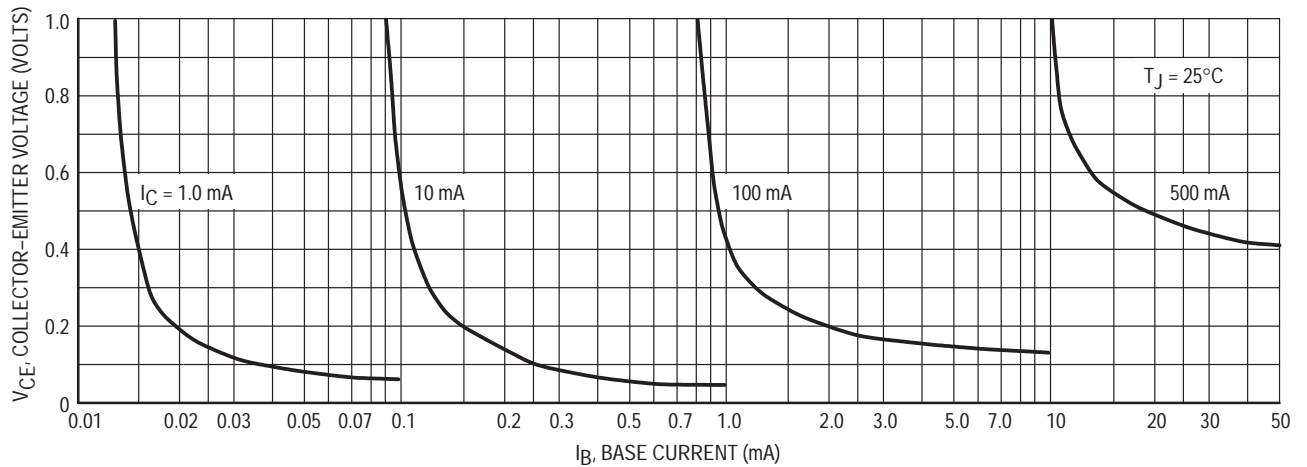


Figure 16. Collector Saturation Region

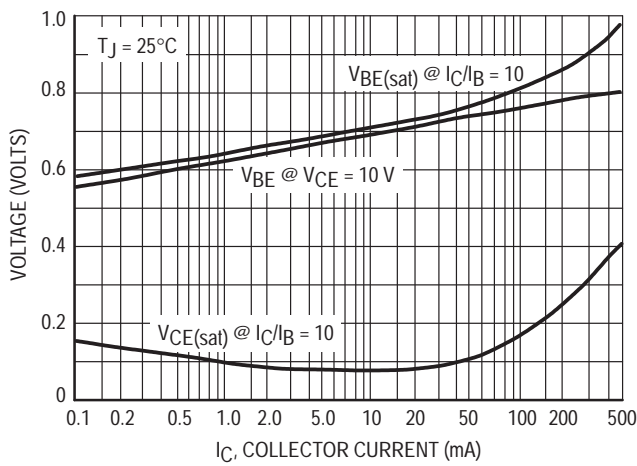


Figure 17. "On" Voltages

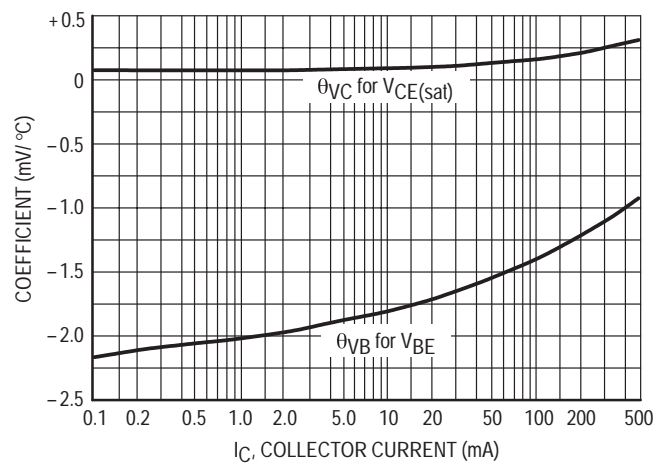


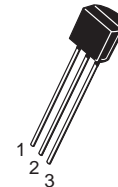
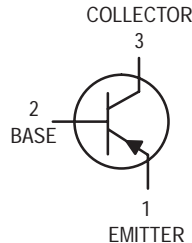
Figure 18. Temperature Coefficients

General Purpose Transistors

PNP Silicon

2N4402
2N4403*

*Motorola Preferred Device



CASE 29-04, STYLE 1
TO-92 (TO-226AA)

MAXIMUM RATINGS

Rating	Symbol	Value	Unit
Collector–Emitter Voltage	V_{CEO}	40	Vdc
Collector–Base Voltage	V_{CBO}	40	Vdc
Emitter–Base Voltage	V_{EBO}	5.0	Vdc
Collector Current — Continuous	I_C	600	mAdc
Total Device Dissipation @ $T_A = 25^\circ\text{C}$ Derate above 25°C	P_D	625 5.0	mW mW/ $^\circ\text{C}$
Total Device Dissipation @ $T_C = 25^\circ\text{C}$ Derate above 25°C	P_D	1.5 12	Watt mW/ $^\circ\text{C}$
Operating and Storage Junction Temperature Range	T_J, T_{stg}	-55 to +150	$^\circ\text{C}$

THERMAL CHARACTERISTICS

Characteristic	Symbol	Max	Unit
Thermal Resistance, Junction to Ambient	$R_{\theta JA}$	200	$^\circ\text{C}/\text{W}$
Thermal Resistance, Junction to Case	$R_{\theta JC}$	83.3	$^\circ\text{C}/\text{W}$

ELECTRICAL CHARACTERISTICS ($T_A = 25^\circ\text{C}$ unless otherwise noted)

Characteristic	Symbol	Min	Max	Unit
----------------	--------	-----	-----	------

OFF CHARACTERISTICS

Collector–Emitter Breakdown Voltage ⁽¹⁾ ($I_C = 1.0$ mAdc, $I_B = 0$)	$V_{(BR)CEO}$	40	—	Vdc
Collector–Base Breakdown Voltage ($I_C = 0.1$ mAdc, $I_E = 0$)	$V_{(BR)CBO}$	40	—	Vdc
Emitter–Base Breakdown Voltage ($I_E = 0.1$ mAdc, $I_C = 0$)	$V_{(BR)EBO}$	5.0	—	Vdc
Base Cutoff Current ($V_{CE} = 35$ Vdc, $V_{EB} = 0.4$ Vdc)	I_{BEV}	—	0.1	μAdc
Collector Cutoff Current ($V_{CE} = 35$ Vdc, $V_{EB} = 0.4$ Vdc)	I_{CEX}	—	0.1	μAdc

1. Pulse Test: Pulse Width ≤ 300 μs , Duty Cycle $\leq 2.0\%$.

Preferred devices are Motorola recommended choices for future use and best overall value.

ELECTRICAL CHARACTERISTICS (T_A = 25°C unless otherwise noted) (Continued)

Characteristic	Symbol	Min	Max	Unit
ON CHARACTERISTICS				
DC Current Gain (I _C = 0.1 mA, V _{CE} = 1.0 Vdc)	h _{FE}	30	—	—
(I _C = 1.0 mA, V _{CE} = 1.0 Vdc)	2N4403	30	—	—
	2N4402	60	—	—
(I _C = 10 mA, V _{CE} = 1.0 Vdc)	2N4402	50	—	—
	2N4403	100	—	—
(I _C = 150 mA, V _{CE} = 2.0 Vdc) ⁽¹⁾	2N4402	50	150	—
	2N4403	100	300	—
(I _C = 500 mA, V _{CE} = 2.0 Vdc) ⁽¹⁾	Both	20	—	—
Collector–Emitter Saturation Voltage ⁽¹⁾ (I _C = 150 mA, I _B = 15 mA) (I _C = 500 mA, I _B = 50 mA)	V _{CE(sat)}	—	0.4 0.75	Vdc
Base–Emitter Saturation Voltage ⁽¹⁾ (I _C = 150 mA, I _B = 15 mA) (I _C = 500 mA, I _B = 50 mA)	V _{BE(sat)}	0.75 —	0.95 1.3	Vdc

SMALL-SIGNAL CHARACTERISTICS

Current–Gain — Bandwidth Product (I _C = 20 mA, V _{CE} = 10 Vdc, f = 100 MHz)	f _T	150 200	—	—	MHz
Collector–Base Capacitance (V _{CB} = 10 Vdc, I _E = 0, f = 1.0 MHz)	C _{cb}	—	8.5	—	pF
Emitter–Base Capacitance (V _{EB} = 0.5 Vdc, I _C = 0, f = 1.0 MHz)	C _{eb}	—	30	—	pF
Input Impedance (I _C = 1.0 mA, V _{CE} = 10 Vdc, f = 1.0 kHz)	h _{ie}	750 1.5 k	7.5 k 15 k	—	ohms
Voltage Feedback Ratio (I _C = 1.0 mA, V _{CE} = 10 Vdc, f = 1.0 kHz)	h _{re}	0.1	8.0	—	X 10 ⁻⁴
Small–Signal Current Gain (I _C = 1.0 mA, V _{CE} = 10 Vdc, f = 1.0 kHz)	h _{fe}	30 60	250 500	—	—
Output Admittance (I _C = 1.0 mA, V _{CE} = 10 Vdc, f = 1.0 kHz)	h _{oe}	1.0	100	—	μmhos

SWITCHING CHARACTERISTICS

Delay Time	(V _{CC} = 30 Vdc, V _{BE} = +2.0 Vdc, I _C = 150 mA, I _{B1} = 15 mA)	t _d	—	15	ns
Rise Time		t _r	—	20	ns
Storage Time	(V _{CC} = 30 Vdc, I _C = 150 mA, I _{B1} = 15 mA, I _{B2} = 15 mA)	t _s	—	225	ns
Fall Time		t _f	—	30	ns

1. Pulse Test: Pulse Width ≤ 300 μs, Duty Cycle ≤ 2.0%.

SWITCHING TIME EQUIVALENT TEST CIRCUIT

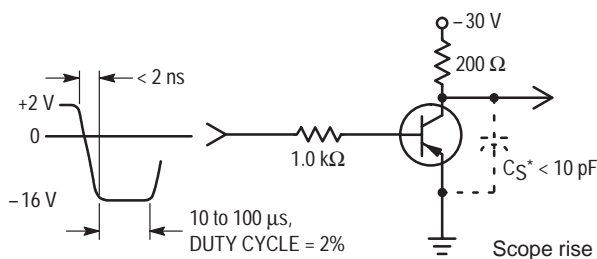


Figure 1. Turn–On Time

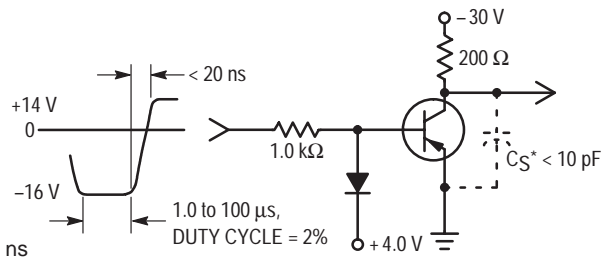


Figure 2. Turn–Off Time

TRANSIENT CHARACTERISTICS

— 25°C - - - 100°C

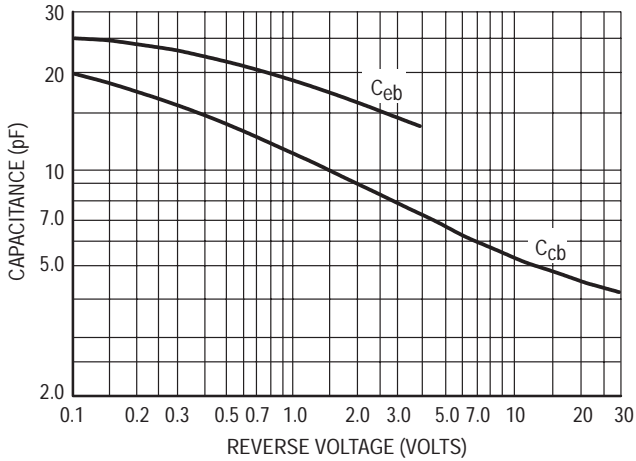


Figure 3. Capacitances

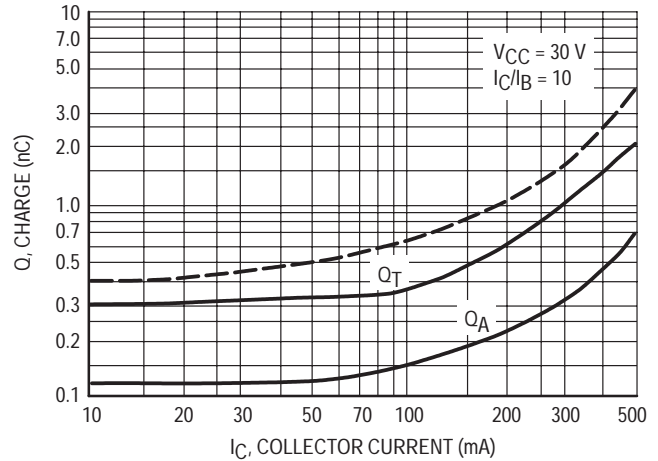


Figure 4. Charge Data

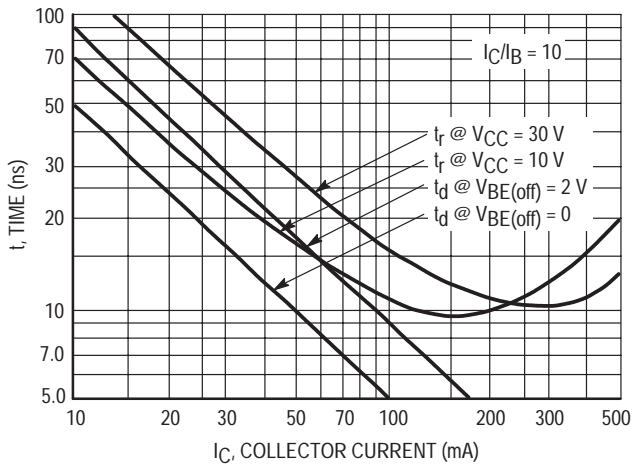


Figure 5. Turn-On Time

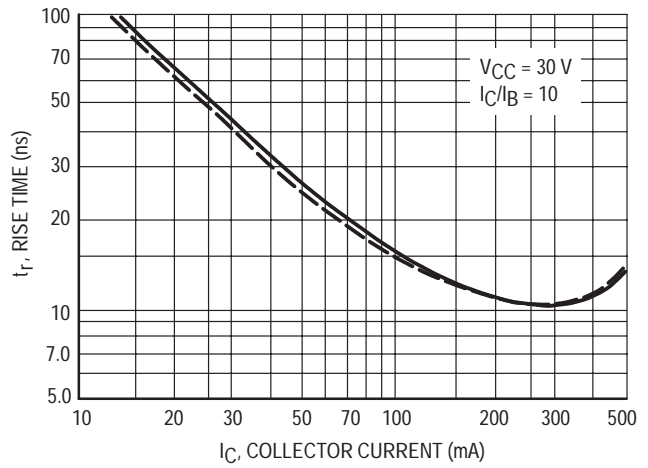


Figure 6. Rise Time

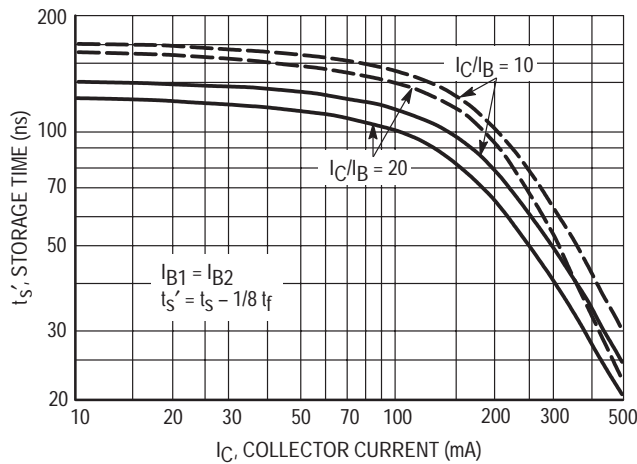


Figure 7. Storage Time

SMALL-SIGNAL CHARACTERISTICS

NOISE FIGURE

$V_{CE} = -10 \text{ Vdc}$, $T_A = 25^\circ\text{C}$

Bandwidth = 1.0 Hz

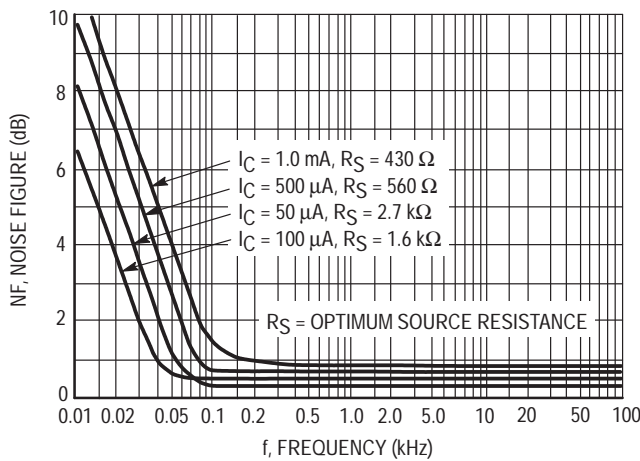


Figure 8. Frequency Effects

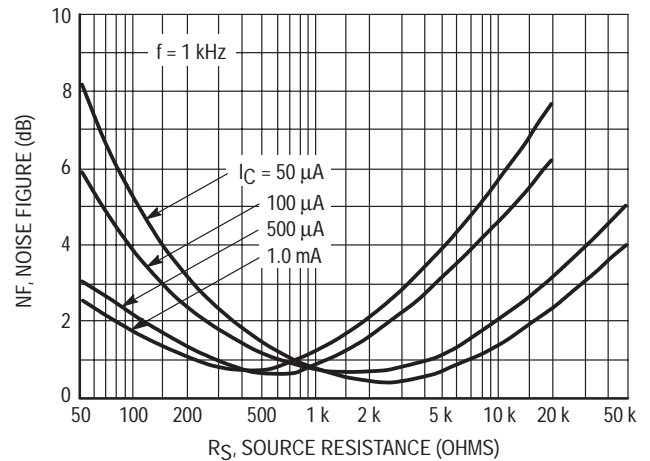


Figure 9. Source Resistance Effects

h PARAMETERS

$V_{CE} = -10 \text{ Vdc}$, $f = 1.0 \text{ kHz}$, $T_A = 25^\circ\text{C}$

This group of graphs illustrates the relationship between h_{fe} and other "h" parameters for this series of transistors. To obtain these curves, a high-gain and a low-gain unit were

selected from both the 2N4402 and 2N4403 lines, and the same units were used to develop the correspondingly-numbered curves on each graph.

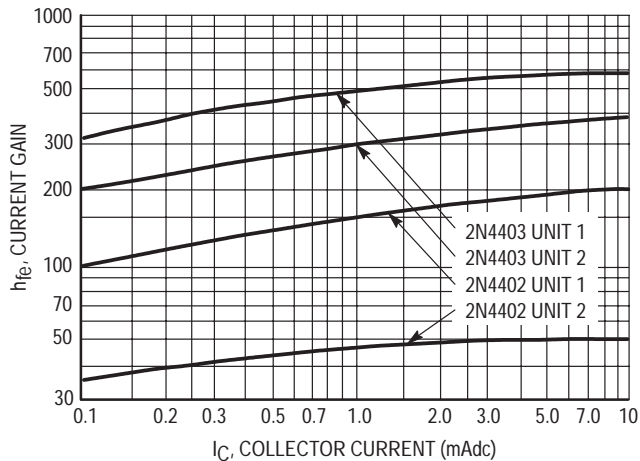


Figure 10. Current Gain

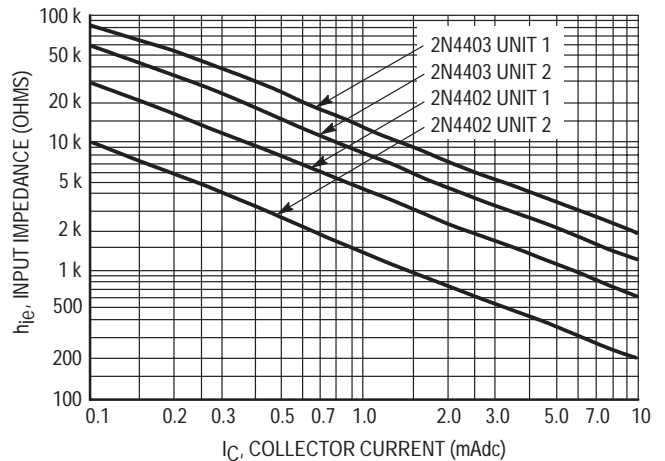


Figure 11. Input Impedance

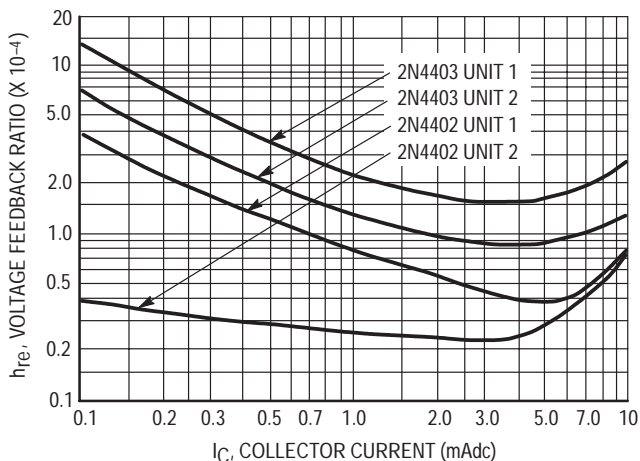


Figure 12. Voltage Feedback Ratio

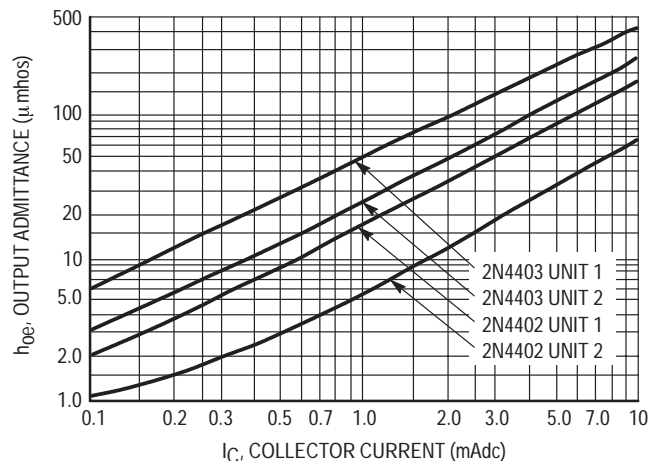


Figure 13. Output Admittance

STATIC CHARACTERISTICS

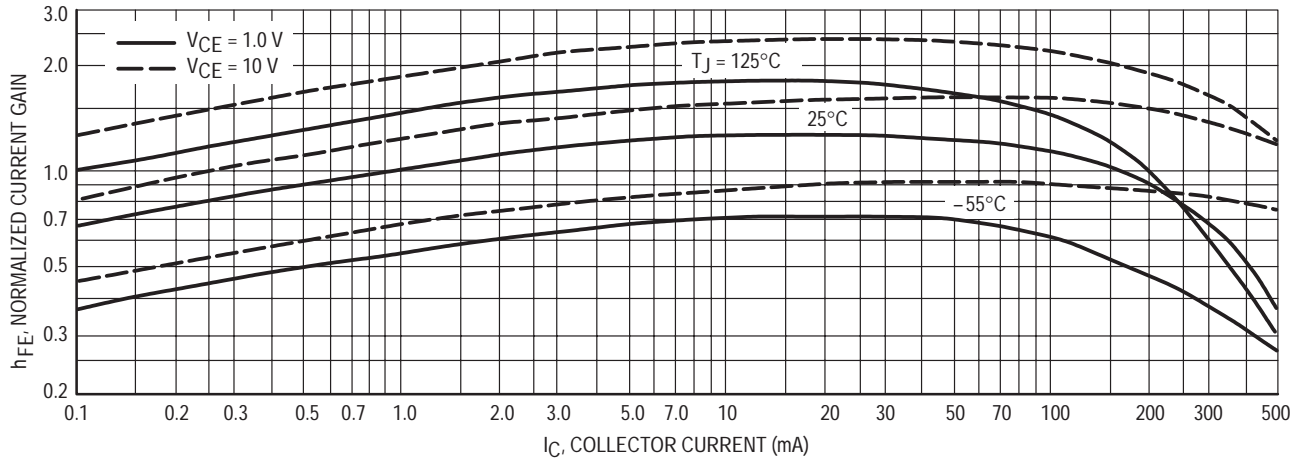


Figure 14. DC Current Gain

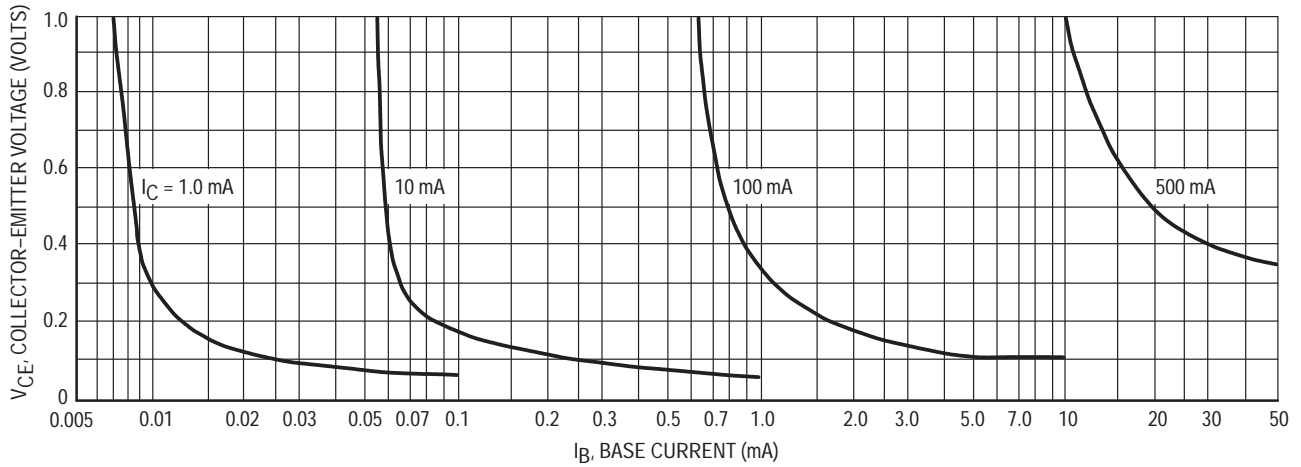


Figure 15. Collector Saturation Region

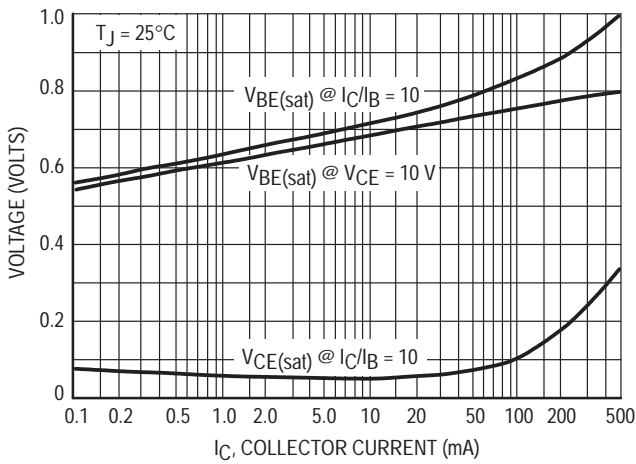


Figure 16. "On" Voltages

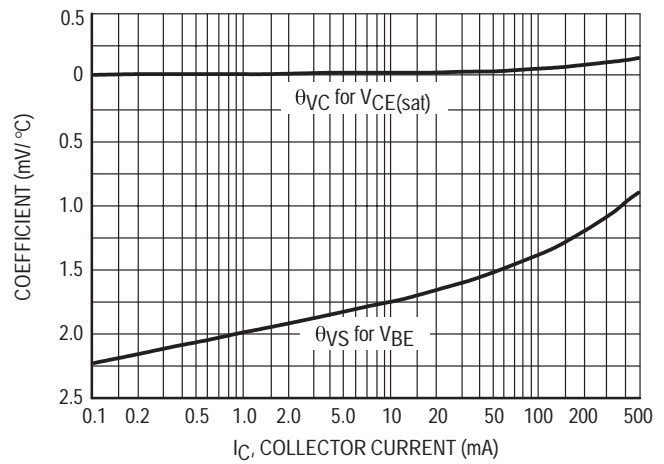
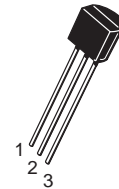
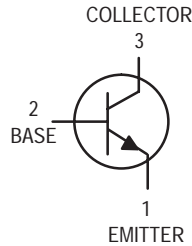


Figure 17. Temperature Coefficients

Amplifier Transistor

NPN Silicon

2N4410



CASE 29-04, STYLE 1
TO-92 (TO-226AA)

MAXIMUM RATINGS

Rating	Symbol	Value	Unit
Collector–Emitter Voltage	V_{CEO}	80	Vdc
Collector–Base Voltage	V_{CBO}	120	Vdc
Emitter–Base Voltage	V_{EBO}	5.0	Vdc
Collector Current — Continuous	I_C	250	mAdc
Total Device Dissipation @ $T_A = 25^\circ\text{C}$ Derate above 25°C	P_D	625 5.0	mW mW/ $^\circ\text{C}$
Total Device Dissipation @ $T_C = 25^\circ\text{C}$ Derate above 25°C	P_D	1.5 12	Watts mW/ $^\circ\text{C}$
Operating and Storage Junction Temperature Range	T_J, T_{stg}	-55 to +150	$^\circ\text{C}$

THERMAL CHARACTERISTICS

Characteristic	Symbol	Max	Unit
Thermal Resistance, Junction to Ambient	$R_{\theta JA}$	200	$^\circ\text{C}/\text{W}$
Thermal Resistance, Junction to Case	$R_{\theta JC}$	83.3	$^\circ\text{C}/\text{W}$

ELECTRICAL CHARACTERISTICS ($T_A = 25^\circ\text{C}$ unless otherwise noted)

Characteristic	Symbol	Min	Max	Unit
----------------	--------	-----	-----	------

OFF CHARACTERISTICS

Collector–Emitter Breakdown Voltage ⁽¹⁾ ($I_C = 1.0 \text{ mAdc}, I_B = 0$)	$V_{(BR)CEO}$	80	—	Vdc
Collector–Emitter Breakdown Voltage ($I_C = 500 \mu\text{Adc}, V_{BE} = 5.0 \text{ Vdc}, R_{BE} = 8.2 \text{ k ohms}$)	$V_{(BR)CEX}$	120	—	Vdc
Collector–Base Breakdown Voltage ($I_C = 10 \mu\text{Adc}, I_E = 0$)	$V_{(BR)CBO}$	120	—	Vdc
Emitter–Base Breakdown Voltage ($I_E = 10 \mu\text{Adc}, I_C = 0$)	$V_{(BR)EBO}$	5.0	—	Vdc
Collector Cutoff Current ($V_{CB} = 100 \text{ Vdc}, I_E = 0$) ($V_{CB} = 100 \text{ Vdc}, I_E = 0, T_A = 100^\circ\text{C}$)	I_{CBO}	— —	0.01 1.0	μAdc
Emitter Cutoff Current ($V_{EB} = 4.0 \text{ Vdc}, I_C = 0$)	I_{EBO}	—	0.1	μAdc

1. Pulse Test: Pulse Width $\leq 300 \mu\text{s}$, Duty Cycle $\leq 2.0\%$.

ELECTRICAL CHARACTERISTICS ($T_A = 25^\circ\text{C}$ unless otherwise noted) (Continued)

Characteristic	Symbol	Min	Max	Unit
ON CHARACTERISTICS				
DC Current Gain ($I_C = 1.0\text{ mA}$, $V_{CE} = 1.0\text{ Vdc}$) ($I_C = 10\text{ mA}$, $V_{CE} = 1.0\text{ Vdc}$)	h_{FE}	60 60	— 400	—
Collector–Emitter Saturation Voltage ($I_C = 1.0\text{ mA}$, $I_B = 0.1\text{ mA}$)	$V_{CE(sat)}$	—	0.2	Vdc
Base–Emitter Saturation Voltage ($I_C = 1.0\text{ mA}$, $I_B = 0.1\text{ mA}$)	$V_{BE(sat)}$	—	0.8	Vdc
Base–Emitter On Voltage ($I_C = 1.0\text{ mA}$, $V_{CE} = 5.0\text{ Vdc}$)	$V_{BE(on)}$	—	0.8	Vdc

SMALL–SIGNAL CHARACTERISTICS

Current–Gain — Bandwidth Product ⁽²⁾ ($I_C = 10\text{ mA}$, $V_{CE} = 10\text{ Vdc}$, $f = 20\text{ MHz}$)	f_T	60	300	MHz
Collector–Base Capacitance ($V_{CB} = 10\text{ Vdc}$, $I_E = 0$, $f = 1.0\text{ MHz}$, emitter guarded)	C_{cb}	—	12	pF
Emitter–Base Capacitance ($V_{EB} = 0.5\text{ Vdc}$, $I_C = 0$, $f = 1.0\text{ MHz}$, collector guarded)	C_{eb}	—	50	pF

2. $f_T = |h_{fe}| \cdot f_{test}$.

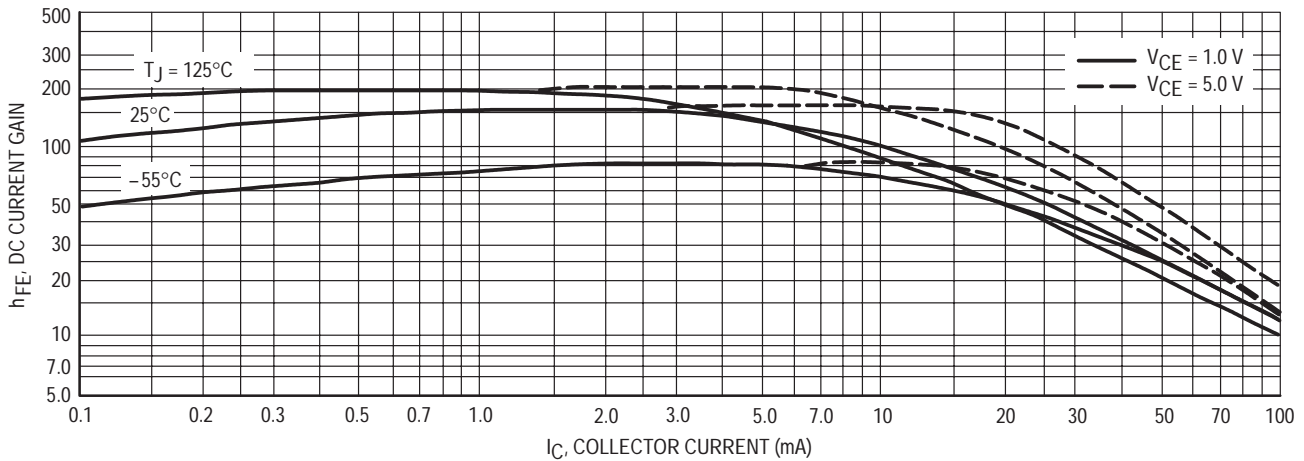


Figure 1. DC Current Gain

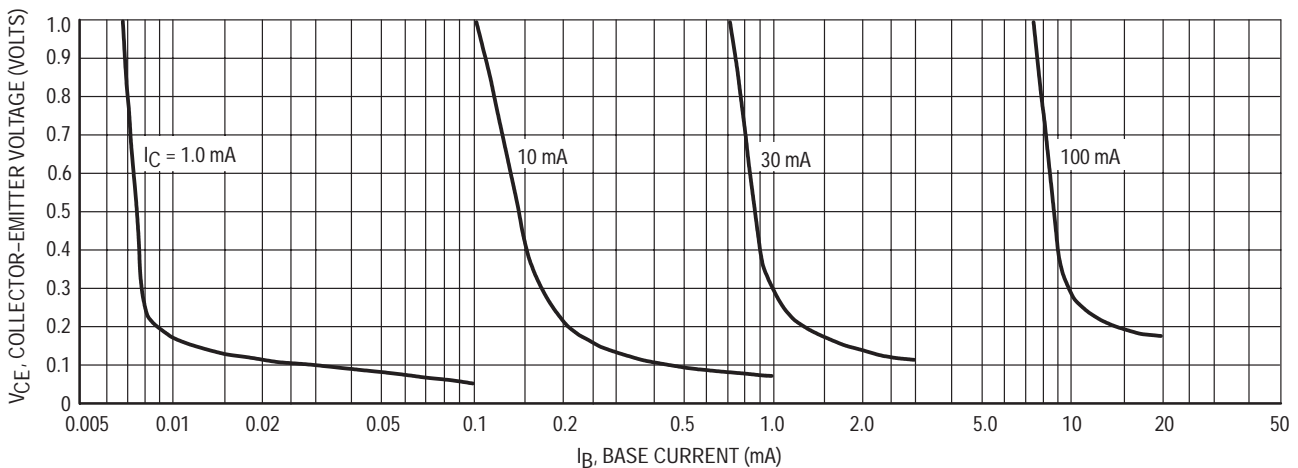


Figure 2. Collector Saturation Region

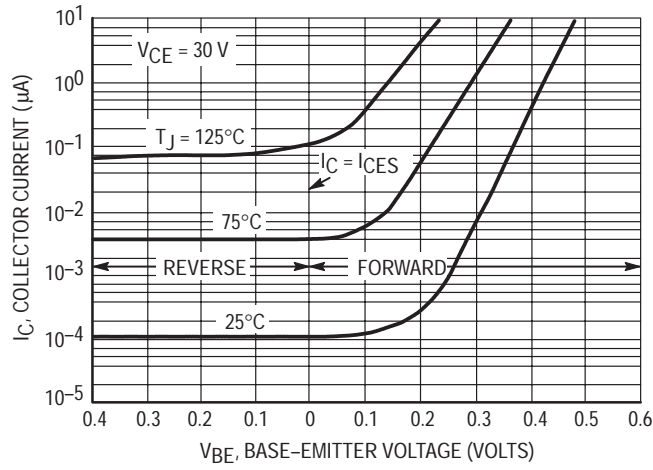


Figure 3. Collector Cut-Off Region

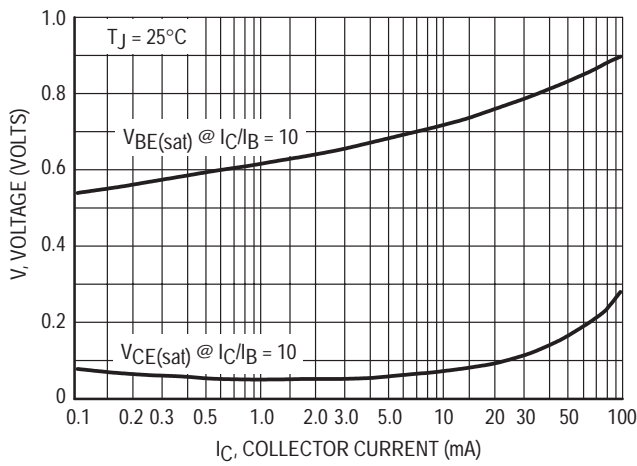


Figure 4. "On" Voltages

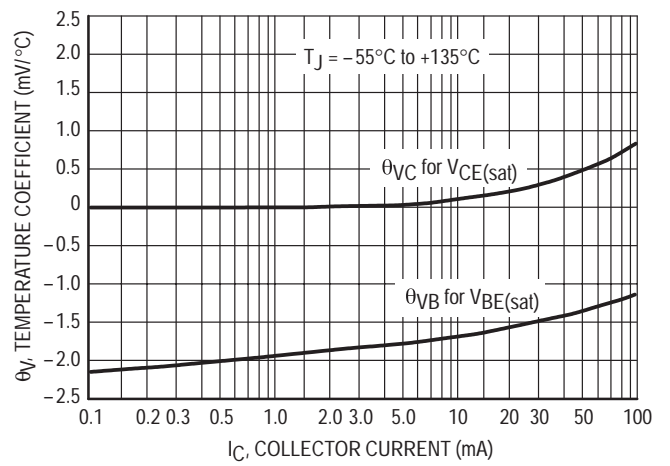
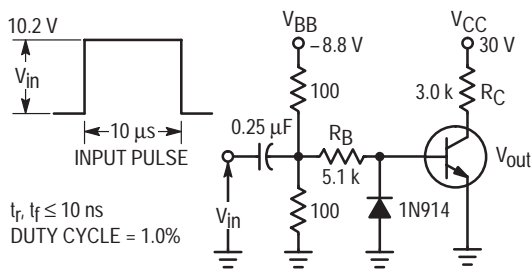


Figure 5. Temperature Coefficients



Values Shown are for I_C @ 10 mA

Figure 6. Switching Time Test Circuit

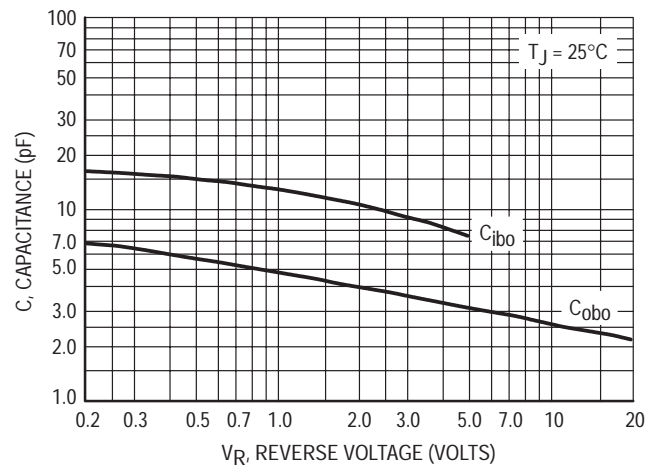


Figure 7. Capacitances

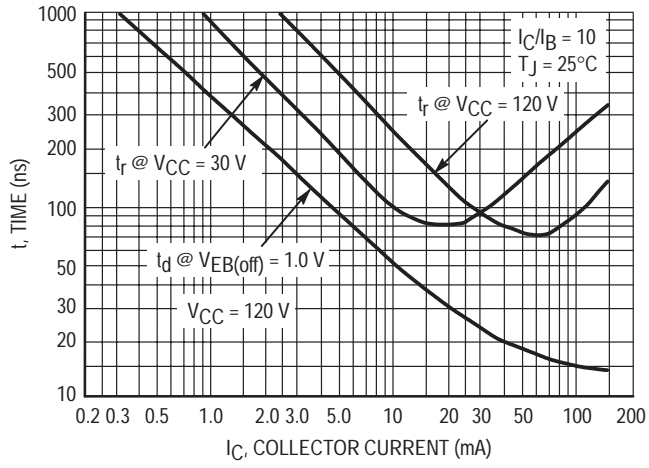


Figure 8. Turn-On Time

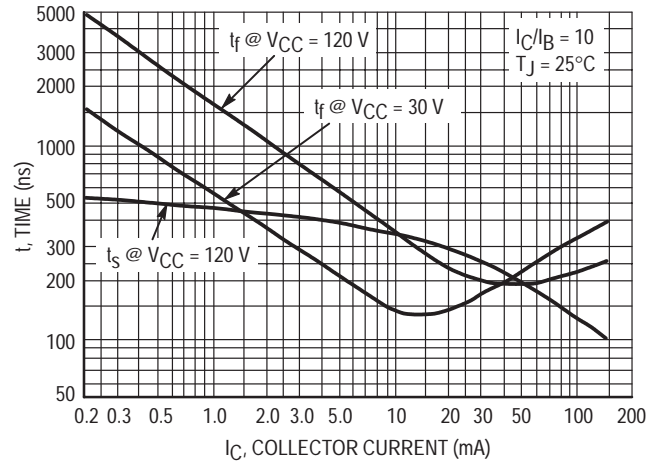
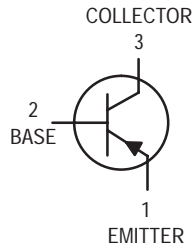


Figure 9. Turn-Off Time

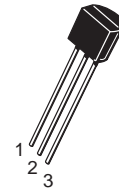
Amplifier Transistor

PNP Silicon



2N5087

Motorola Preferred Device



CASE 29-04, STYLE 1
TO-92 (TO-226AA)

MAXIMUM RATINGS

Rating	Symbol	Value	Unit
Collector–Emitter Voltage	V_{CEO}	50	Vdc
Collector–Base Voltage	V_{CBO}	50	Vdc
Emitter–Base Voltage	V_{EBO}	3.0	Vdc
Collector Current — Continuous	I_C	50	mAdc
Total Device Dissipation @ $T_A = 25^\circ\text{C}$ Derate above 25°C	P_D	625 5.0	mW mW/ $^\circ\text{C}$
Total Device Dissipation @ $T_C = 25^\circ\text{C}$ Derate above 25°C	P_D	1.5 12	Watts mW/ $^\circ\text{C}$
Operating and Storage Junction Temperature Range	T_J, T_{stg}	-55 to +150	$^\circ\text{C}$

THERMAL CHARACTERISTICS

Characteristic	Symbol	Max	Unit
Thermal Resistance, Junction to Ambient	$R_{\theta JA}$	200	$^\circ\text{C}/\text{W}$
Thermal Resistance, Junction to Case	$R_{\theta JC}$	83.3	$^\circ\text{C}/\text{W}$

ELECTRICAL CHARACTERISTICS ($T_A = 25^\circ\text{C}$ unless otherwise noted)

Characteristic	Symbol	Min	Max	Unit
----------------	--------	-----	-----	------

OFF CHARACTERISTICS

Collector–Emitter Breakdown Voltage ⁽¹⁾ ($I_C = 1.0 \text{ mAdc}, I_E = 0$)	$V_{(BR)CEO}$	50	—	Vdc
Collector–Base Breakdown Voltage ($I_C = 100 \mu\text{Adc}, I_E = 0$)	$V_{(BR)CBO}$	50	—	Vdc
Collector Cutoff Current ($V_{CB} = 35 \text{ Vdc}, I_E = 0$)	I_{CBO}	—	50	nAdc
Emitter Cutoff Current ($V_{EB} = 3.0 \text{ Vdc}, I_C = 0$)	I_{EBO}	—	50	nAdc

1. Pulse Test: Pulse Width $\leq 300 \mu\text{s}$, Duty Cycle $\leq 2.0\%$.

Preferred devices are Motorola recommended choices for future use and best overall value.

(Replaces 2N5086/D)

ELECTRICAL CHARACTERISTICS ($T_A = 25^\circ\text{C}$ unless otherwise noted) (Continued)

Characteristic	Symbol	Min	Max	Unit
ON CHARACTERISTICS				
DC Current Gain ($I_C = 100 \mu\text{A}$, $V_{CE} = 5.0 \text{ Vdc}$) ($I_C = 1.0 \text{ mA}$, $V_{CE} = 5.0 \text{ Vdc}$) ($I_C = 10 \text{ mA}$, $V_{CE} = 5.0 \text{ Vdc}$)(1)	h_{FE}	250 250 250	800 — —	—
Collector–Emitter Saturation Voltage ($I_C = 10 \text{ mA}$, $I_B = 1.0 \text{ mA}$)	$V_{CE(sat)}$	—	0.3	Vdc
Base–Emitter On Voltage ($I_C = 1.0 \text{ mA}$, $V_{CE} = 5.0 \text{ Vdc}$)	$V_{BE(on)}$	—	0.85	Vdc

SMALL–SIGNAL CHARACTERISTICS

Current–Gain — Bandwidth Product ($I_C = 500 \mu\text{A}$, $V_{CE} = 5.0 \text{ Vdc}$, $f = 20 \text{ MHz}$)	f_T	40	—	MHz
Collector–Base Capacitance ($V_{CB} = 5.0 \text{ Vdc}$, $I_E = 0$, $f = 1.0 \text{ MHz}$)	C_{cb}	—	4.0	pF
Small–Signal Current Gain ($I_C = 1.0 \text{ mA}$, $V_{CE} = 5.0 \text{ Vdc}$, $f = 1.0 \text{ kHz}$)	h_{fe}	250	900	—
Noise Figure ($I_C = 20 \mu\text{A}$, $V_{CE} = 5.0 \text{ Vdc}$, $R_S = 1.0 \text{ k}\Omega$, $f = 1.0 \text{ kHz}$) ($I_C = 100 \mu\text{A}$, $V_{CE} = 5.0 \text{ Vdc}$, $R_S = 3.0 \text{ k}\Omega$, $f = 1.0 \text{ kHz}$)	NF	— —	2.0 2.0	dB

1. Pulse Test: Pulse Width $\leq 300 \mu\text{s}$, Duty Cycle $\leq 2.0\%$.

TYPICAL NOISE CHARACTERISTICS

($V_{CE} = -5.0 \text{ Vdc}$, $T_A = 25^\circ\text{C}$)

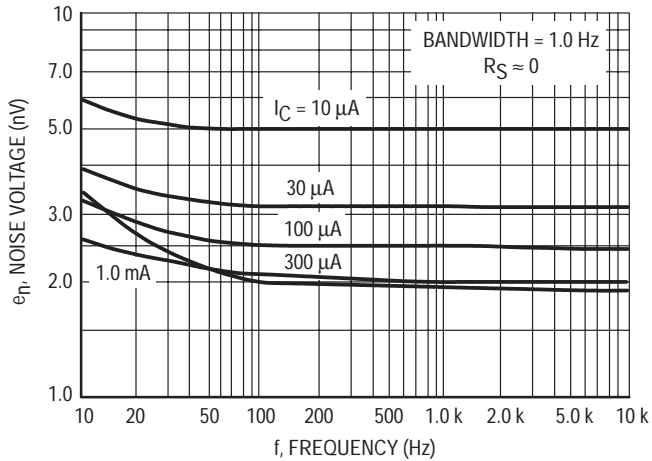


Figure 1. Noise Voltage

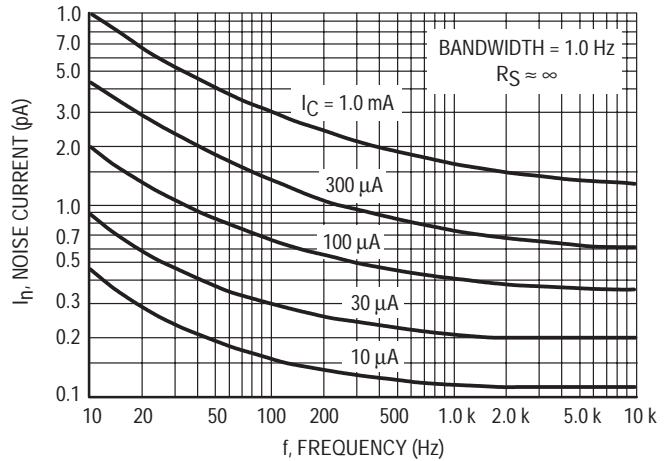


Figure 2. Noise Current

NOISE FIGURE CONTOURS

($V_{CE} = -5.0 \text{ Vdc}$, $T_A = 25^\circ\text{C}$)

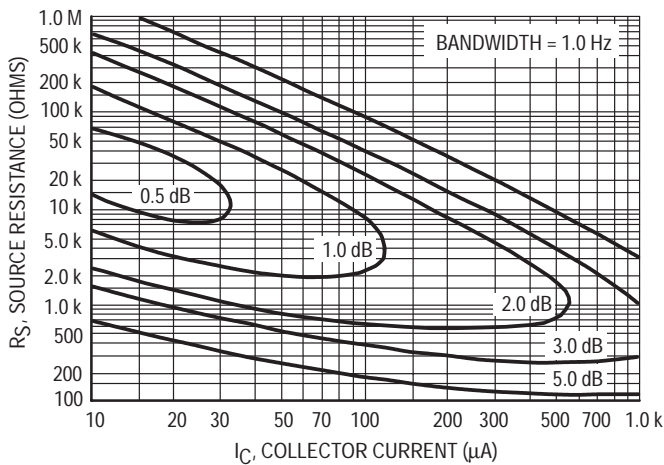


Figure 3. Narrow Band, 100 Hz

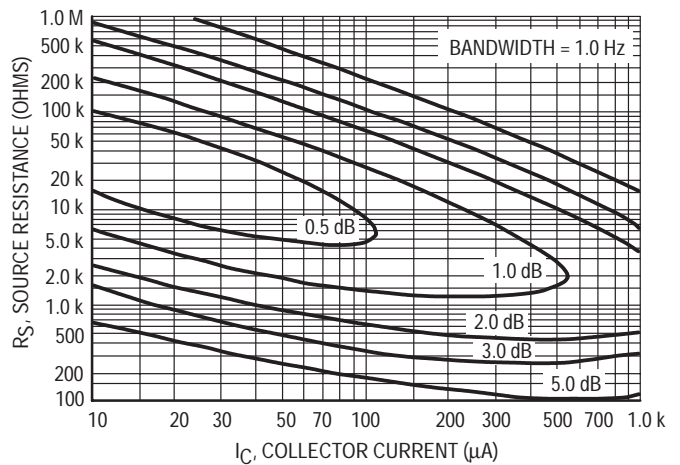


Figure 4. Narrow Band, 1.0 kHz

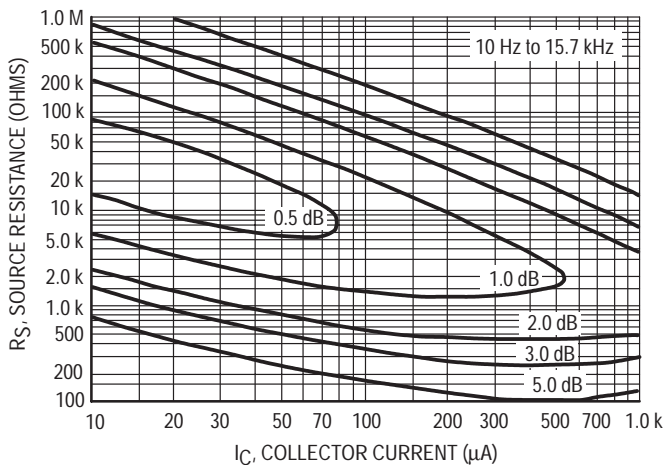


Figure 5. Wideband

Noise Figure is Defined as:

$$NF = 20 \log_{10} \left[\frac{e_n^2 + 4KTR_S + I_n^2 R_S^2}{4KTR_S} \right]^{1/2}$$

- e_n = Noise Voltage of the Transistor referred to the input. (Figure 3)
- I_n = Noise Current of the Transistor referred to the input. (Figure 4)
- K = Boltzman's Constant ($1.38 \times 10^{-23} \text{ J/}^\circ\text{K}$)
- T = Temperature of the Source Resistance ($^\circ\text{K}$)
- R_S = Source Resistance (Ohms)

TYPICAL STATIC CHARACTERISTICS

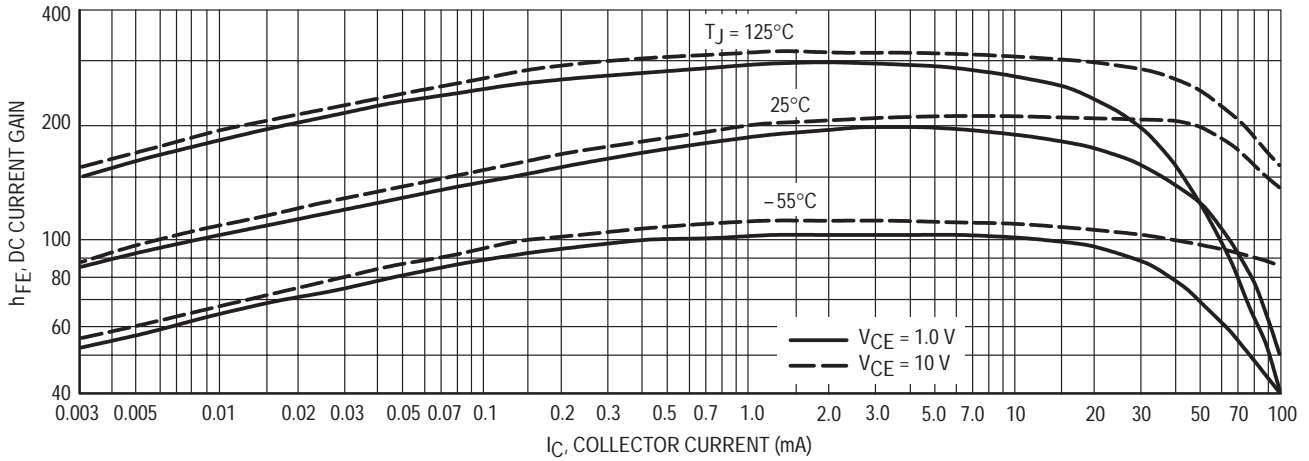


Figure 6. DC Current Gain

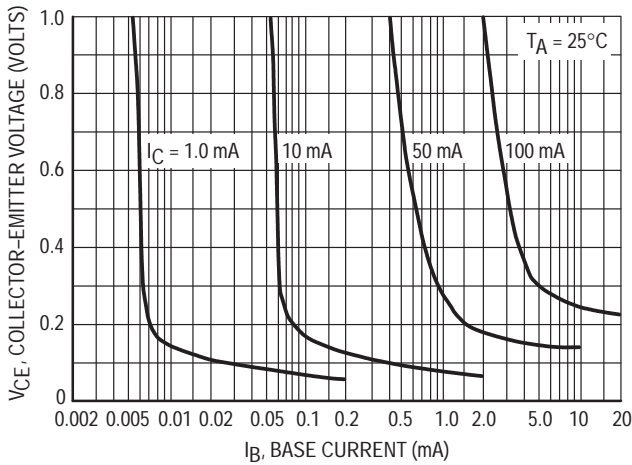


Figure 7. Collector Saturation Region

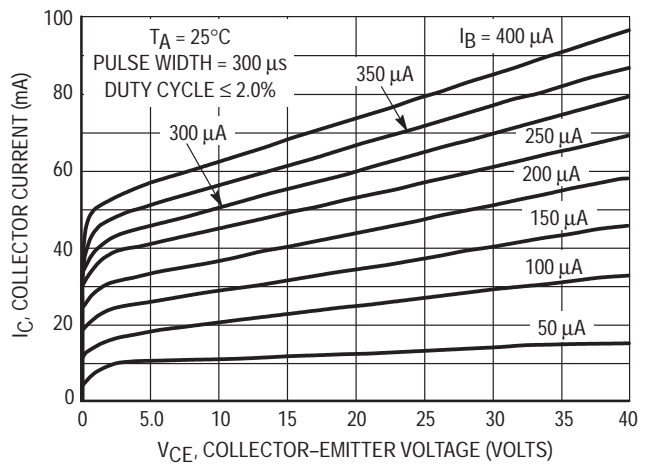


Figure 8. Collector Characteristics

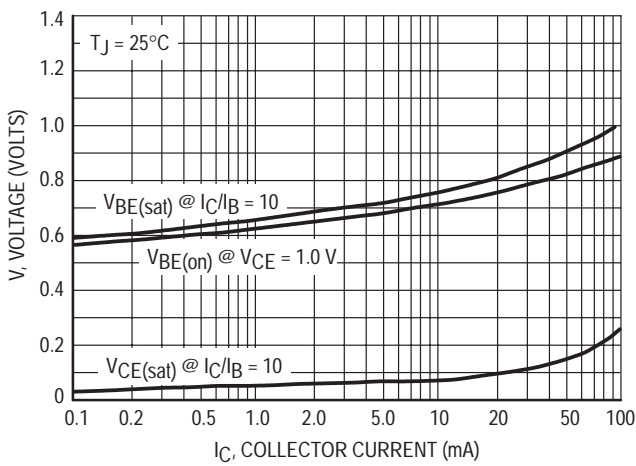


Figure 9. "On" Voltages

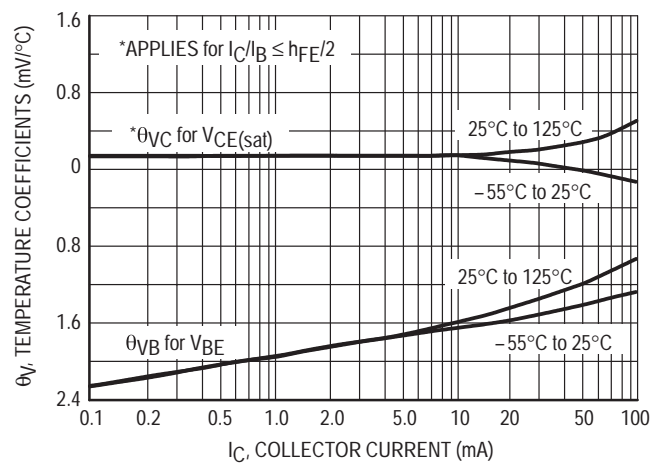


Figure 10. Temperature Coefficients

TYPICAL DYNAMIC CHARACTERISTICS

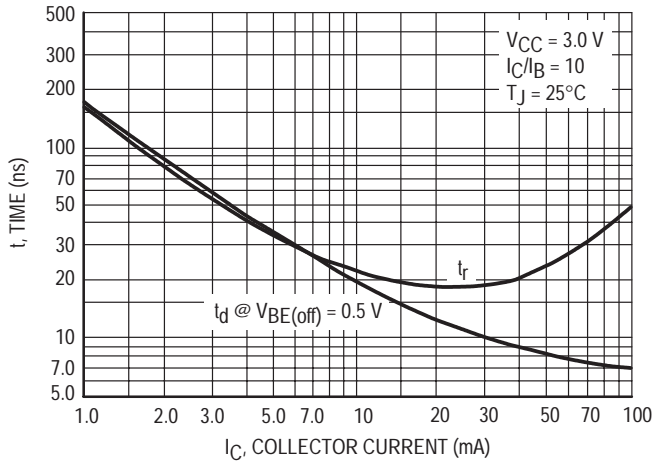


Figure 11. Turn-On Time

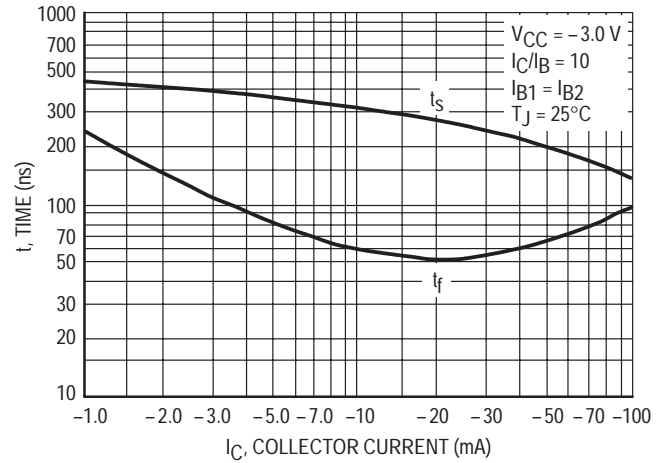


Figure 12. Turn-Off Time

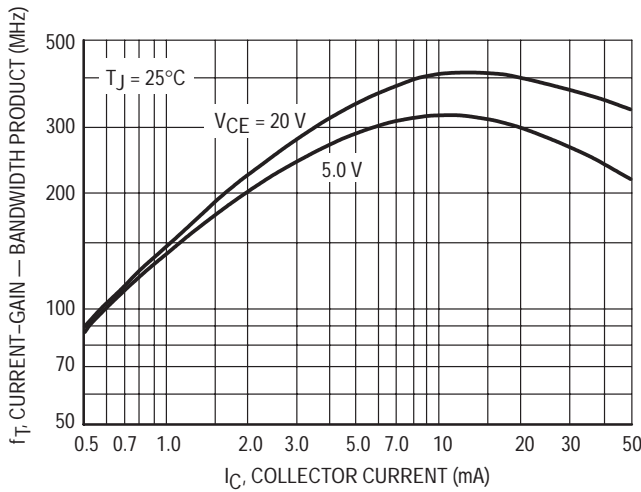


Figure 13. Current-Gain — Bandwidth Product

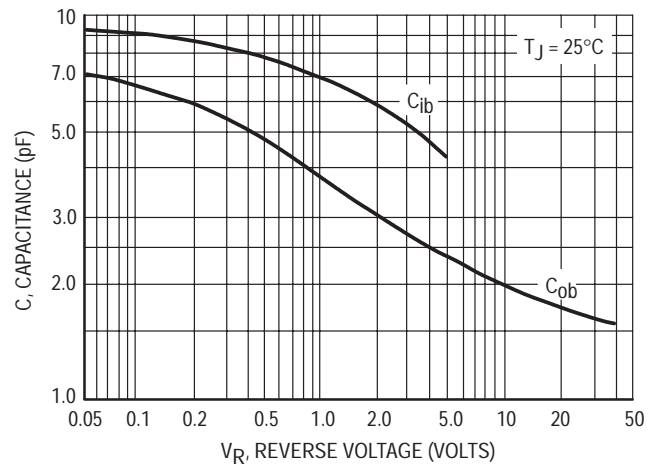


Figure 14. Capacitance

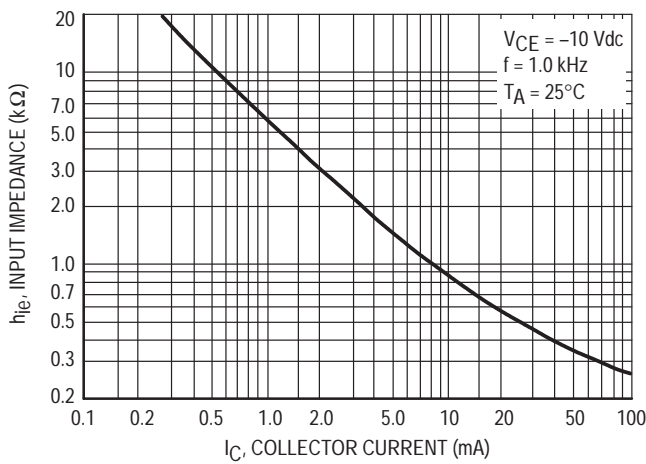


Figure 15. Input Impedance

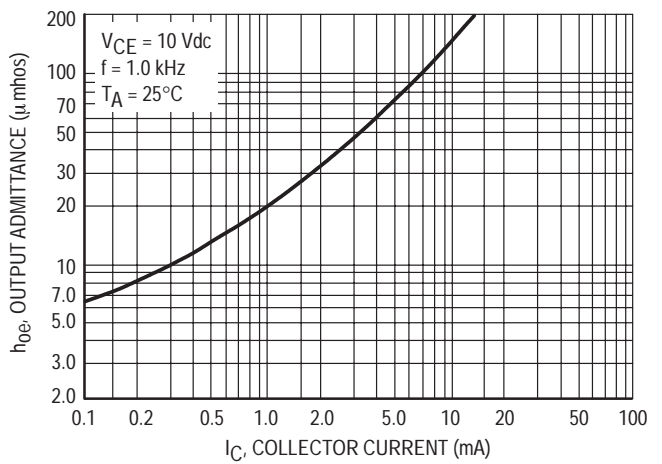


Figure 16. Output Admittance

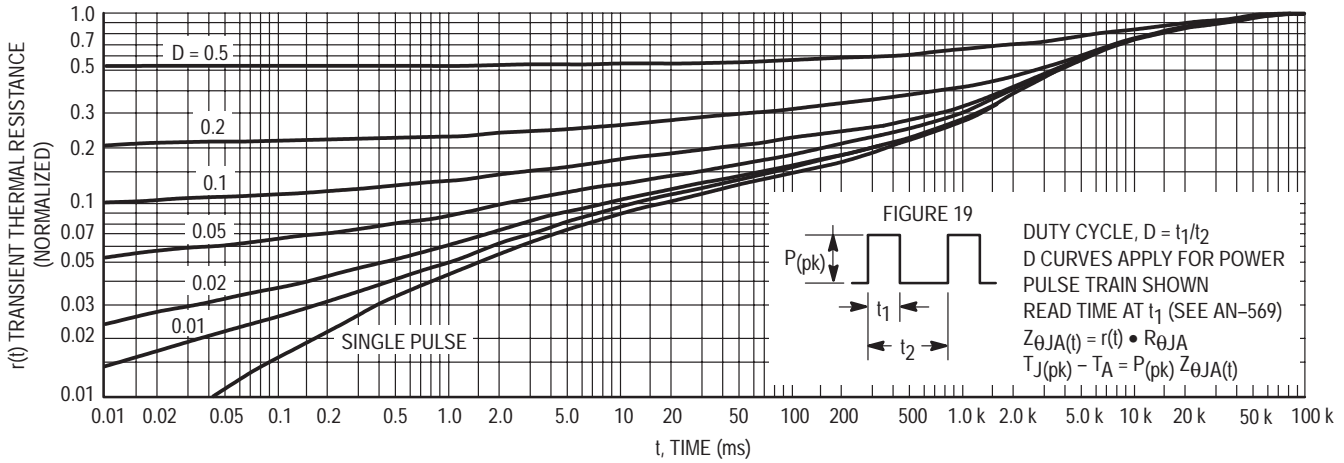


Figure 17. Thermal Response

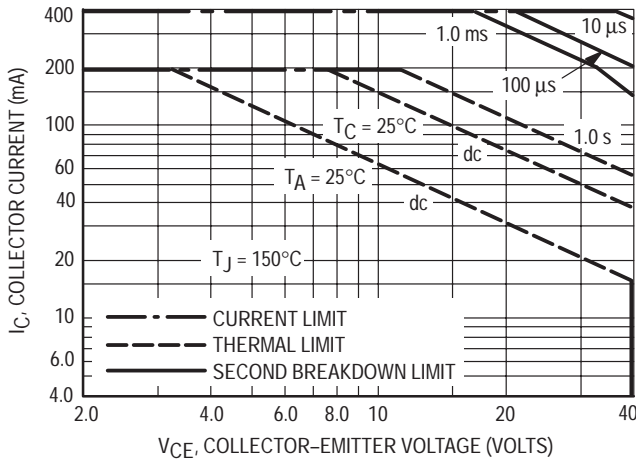


Figure 18. Active-Region Safe Operating Area

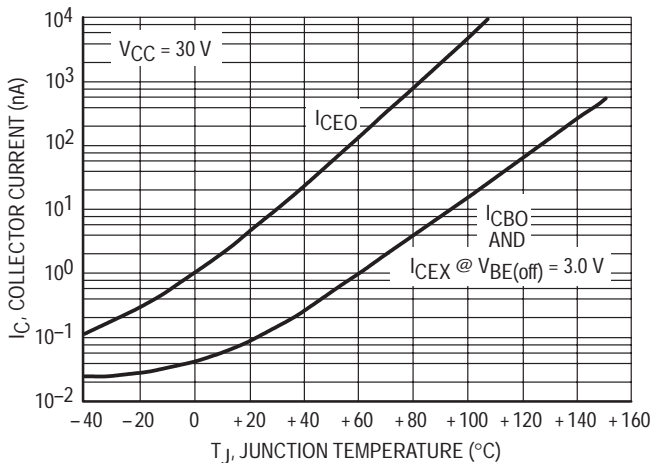


Figure 19. Typical Collector Leakage Current

The safe operating area curves indicate I_C - V_{CE} limits of the transistor that must be observed for reliable operation. Collector load lines for specific circuits must fall below the limits indicated by the applicable curve.

The data of Figure 18 is based upon $T_{J(pk)} = 150^\circ\text{C}$; T_C or T_A is variable depending upon conditions. Pulse curves are valid for duty cycles to 10% provided $T_{J(pk)} \leq 150^\circ\text{C}$. $T_{J(pk)}$ may be calculated from the data in Figure 17. At high case or ambient temperatures, thermal limitations will reduce the power than can be handled to values less than the limitations imposed by second breakdown.

DESIGN NOTE: USE OF THERMAL RESPONSE DATA

A train of periodical power pulses can be represented by the model as shown in Figure 19. Using the model and the device thermal response the normalized effective transient thermal resistance of Figure 17 was calculated for various duty cycles.

To find $Z_{\theta JA}(t)$, multiply the value obtained from Figure 17 by the steady state value $R_{\theta JA}$.

Example:

The 2N5087 is dissipating 2.0 watts peak under the following conditions:

$$t_1 = 1.0 \text{ ms}, t_2 = 5.0 \text{ ms} (D = 0.2)$$

Using Figure 17 at a pulse width of 1.0 ms and $D = 0.2$, the reading of $r(t)$ is 0.22.

The peak rise in junction temperature is therefore

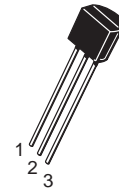
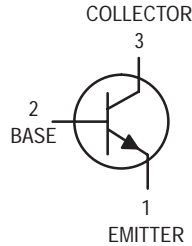
$$\Delta T = r(t) \times P(pk) \times R_{\theta JA} = 0.22 \times 2.0 \times 200 = 88^\circ\text{C}.$$

For more information, see AN-569.

Amplifier Transistors

NPN Silicon

2N5088
2N5089



CASE 29-04, STYLE 1
TO-92 (TO-226AA)

MAXIMUM RATINGS

Rating	Symbol	2N5088	2N5089	Unit
Collector–Emitter Voltage	V_{CEO}	30	25	Vdc
Collector–Base Voltage	V_{CBO}	35	30	Vdc
Emitter–Base Voltage	V_{EBO}	3.0		Vdc
Collector Current — Continuous	I_C	50		mAdc
Total Device Dissipation @ $T_A = 25^\circ\text{C}$ Derate above 25°C	P_D	625	5.0	mW mW/ $^\circ\text{C}$
Total Device Dissipation @ $T_C = 25^\circ\text{C}$ Derate above 25°C	P_D	1.5	12	Watts mW/ $^\circ\text{C}$
Operating and Storage Junction Temperature Range	T_J, T_{stg}	–55 to +150		$^\circ\text{C}$

THERMAL CHARACTERISTICS

Characteristic	Symbol	Max	Unit
Thermal Resistance, Junction to Ambient	$R_{\theta JA}^{(1)}$	200	$^\circ\text{C/W}$
Thermal Resistance, Junction to Case	$R_{\theta JC}$	83.3	$^\circ\text{C/W}$

ELECTRICAL CHARACTERISTICS ($T_A = 25^\circ\text{C}$ unless otherwise noted)

Characteristic	Symbol	Min	Max	Unit
----------------	--------	-----	-----	------

OFF CHARACTERISTICS

Collector–Emitter Breakdown Voltage ⁽²⁾ ($I_C = 1.0 \text{ mAdc}, I_E = 0$)	2N5088 2N5089	$V_{(BR)CEO}$	30 25	— —	Vdc
Collector–Base Breakdown Voltage ($I_C = 100 \mu\text{Adc}, I_E = 0$)	2N5088 2N5089	$V_{(BR)CBO}$	35 30	— —	Vdc
Collector Cutoff Current ($V_{CB} = 20 \text{ Vdc}, I_E = 0$) ($V_{CB} = 15 \text{ Vdc}, I_E = 0$)	2N5088 2N5089	I_{CBO}	— —	50 50	nAdc
Emitter Cutoff Current ($V_{EB(off)} = 3.0 \text{ Vdc}, I_C = 0$) ($V_{EB(off)} = 4.5 \text{ Vdc}, I_C = 0$)		I_{EBO}	— —	50 100	nAdc

- $R_{\theta JA}$ is measured with the device soldered into a typical printed circuit board.
- Pulse Test: Pulse Width $\leq 300 \mu\text{s}$, Duty Cycle $\leq 2.0\%$.

2N5088 2N5089

ELECTRICAL CHARACTERISTICS ($T_A = 25^\circ\text{C}$ unless otherwise noted) (Continued)

Characteristic	Symbol	Min	Max	Unit
ON CHARACTERISTICS				
DC Current Gain ($I_C = 100 \mu\text{A}$, $V_{CE} = 5.0 \text{ Vdc}$)	h_{FE}	300	900	—
	2N5088	400	1200	
	2N5089			
($I_C = 1.0 \text{ mA}$, $V_{CE} = 5.0 \text{ Vdc}$)		350	—	
	2N5088	450	—	
	2N5089			
($I_C = 10 \text{ mA}$, $V_{CE} = 5.0 \text{ Vdc}$) ⁽²⁾		300	—	
	2N5088	400	—	
	2N5089			
Collector–Emitter Saturation Voltage ($I_C = 10 \text{ mA}$, $I_B = 1.0 \text{ mA}$)	$V_{CE(sat)}$	—	0.5	Vdc
Base–Emitter On Voltage ($I_C = 10 \text{ mA}$, $V_{CE} = 5.0 \text{ Vdc}$) ⁽²⁾	$V_{BE(on)}$	—	0.8	Vdc

SMALL–SIGNAL CHARACTERISTICS

Current–Gain — Bandwidth Product ($I_C = 500 \mu\text{A}$, $V_{CE} = 5.0 \text{ Vdc}$, $f = 20 \text{ MHz}$)	f_T	50	—	MHz
Collector–Base Capacitance ($V_{CB} = 5.0 \text{ Vdc}$, $I_E = 0$, $f = 1.0 \text{ MHz}$)	C_{cb}	—	4.0	pF
Emitter–Base Capacitance ($V_{EB} = 0.5 \text{ Vdc}$, $I_C = 0$, $f = 1.0 \text{ MHz}$)	C_{eb}	—	10	pF
Small–Signal Current Gain ($I_C = 1.0 \text{ mA}$, $V_{CE} = 5.0 \text{ Vdc}$, $f = 1.0 \text{ kHz}$)	h_{fe}	350	1400	—
	2N5088	450	1800	
	2N5089			
Noise Figure ($I_C = 100 \mu\text{A}$, $V_{CE} = 5.0 \text{ Vdc}$, $R_S = 1.0 \text{ k}\Omega$, $f = 1.0 \text{ kHz}$)	NF	—	3.0	dB
	2N5088	—	2.0	
	2N5089			

2. Pulse Test: Pulse Width $\leq 300 \mu\text{s}$, Duty Cycle $\leq 2.0\%$.

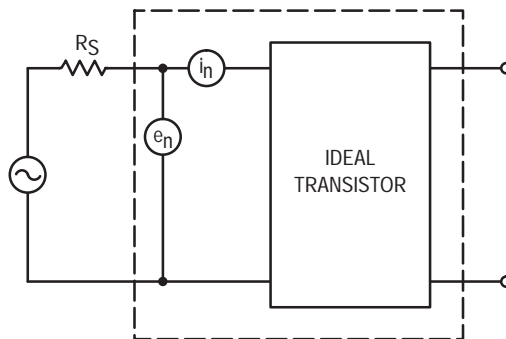


Figure 1. Transistor Noise Model

NOISE CHARACTERISTICS

($V_{CE} = 5.0 \text{ Vdc}$, $T_A = 25^\circ\text{C}$)

NOISE VOLTAGE

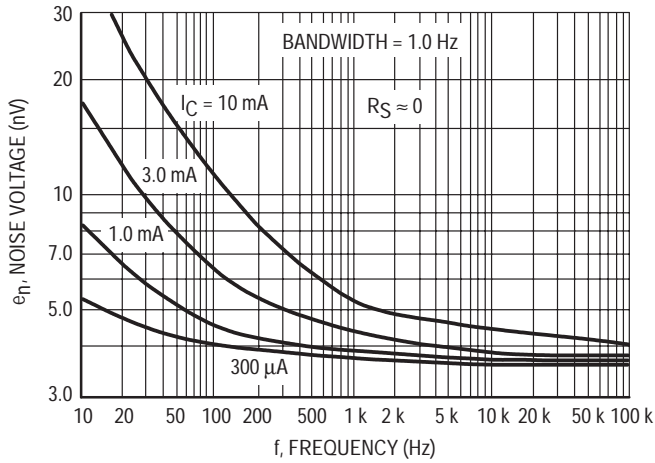


Figure 2. Effects of Frequency

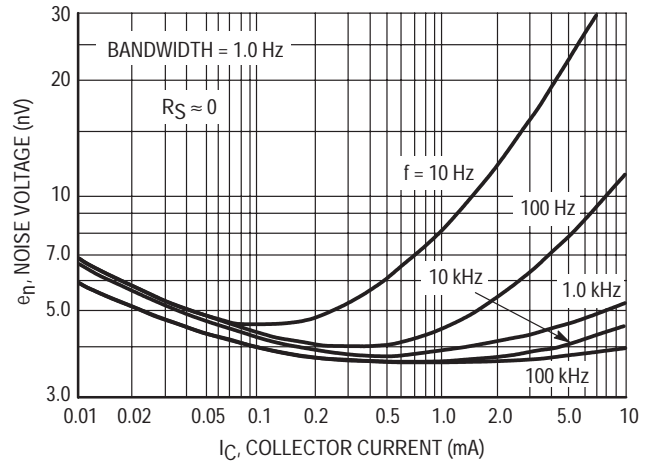


Figure 3. Effects of Collector Current

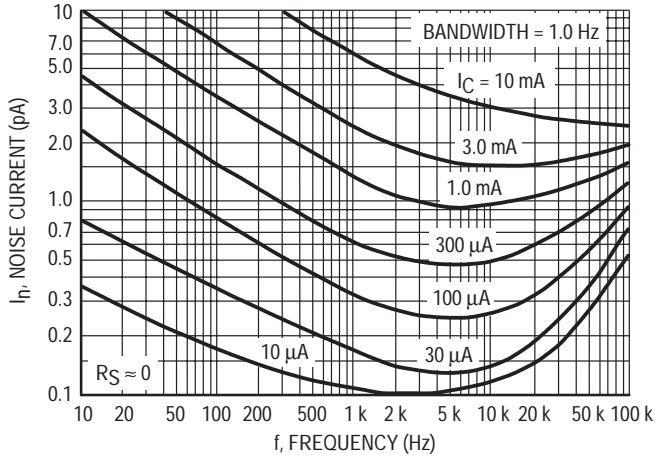


Figure 4. Noise Current

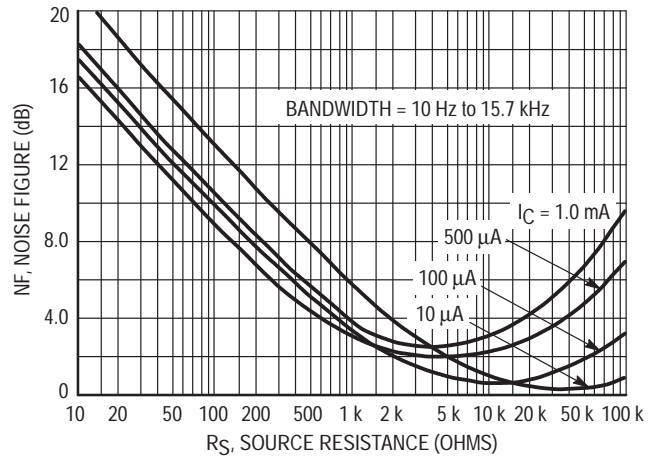


Figure 5. Wideband Noise Figure

100 Hz NOISE DATA

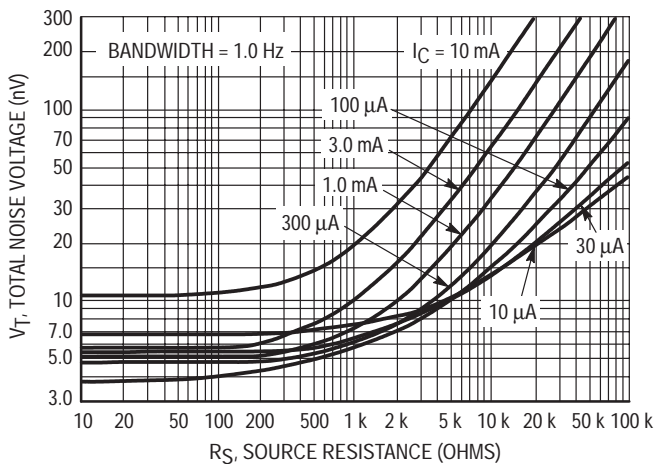


Figure 6. Total Noise Voltage

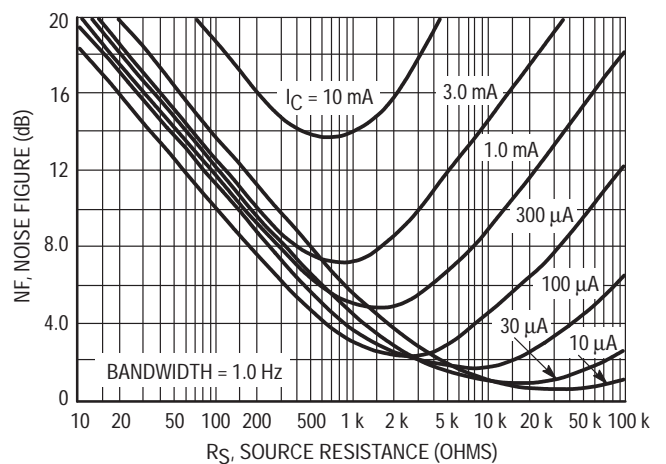


Figure 7. Noise Figure

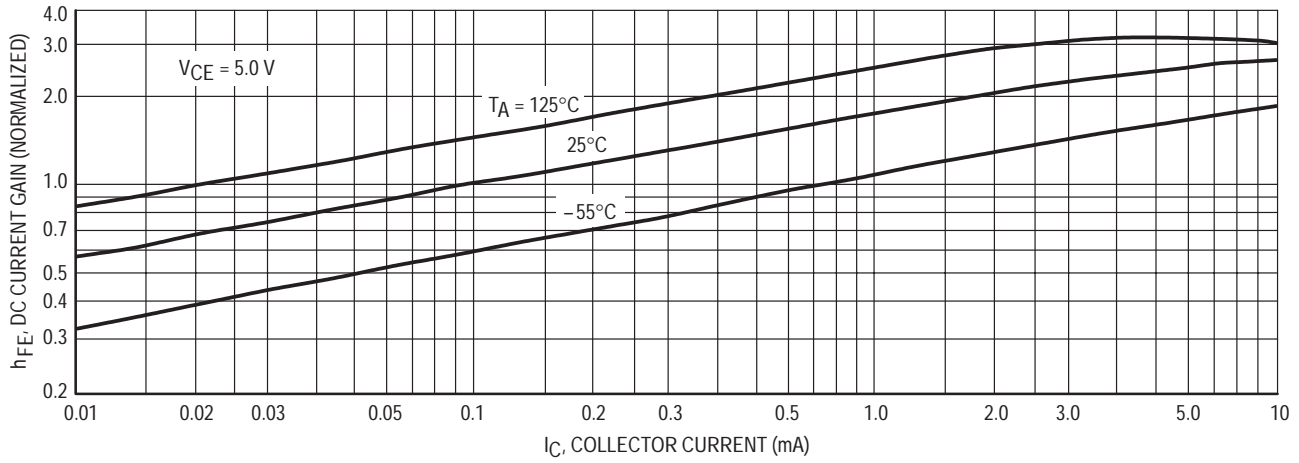


Figure 8. DC Current Gain

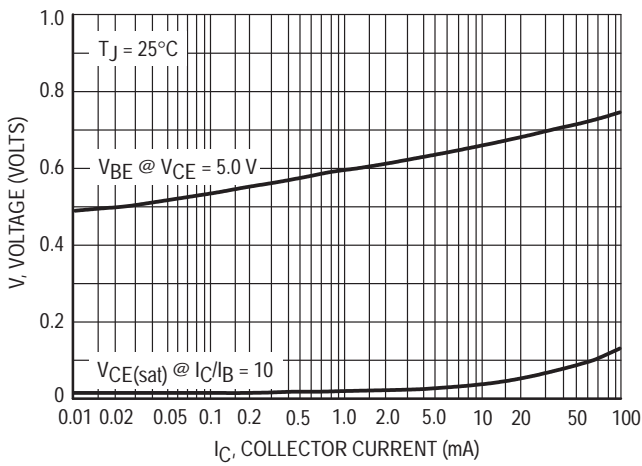


Figure 9. "On" Voltages

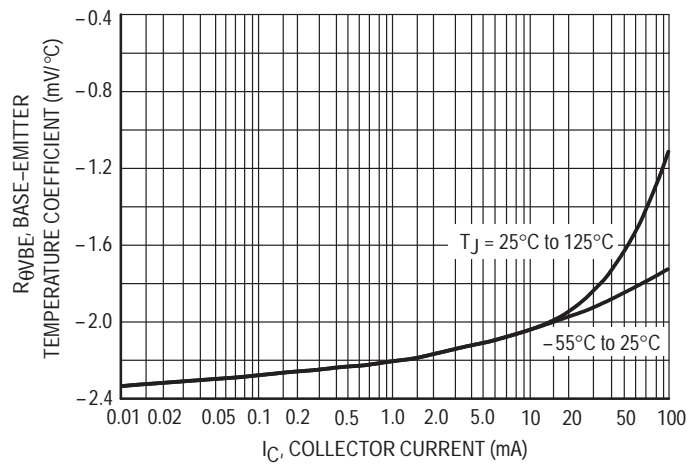


Figure 10. Temperature Coefficients

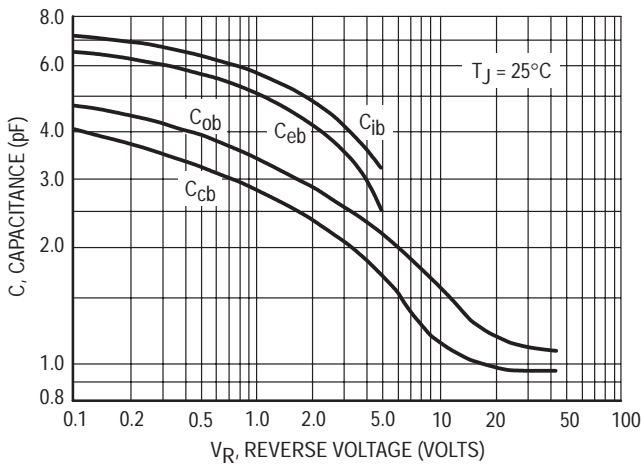


Figure 11. Capacitance

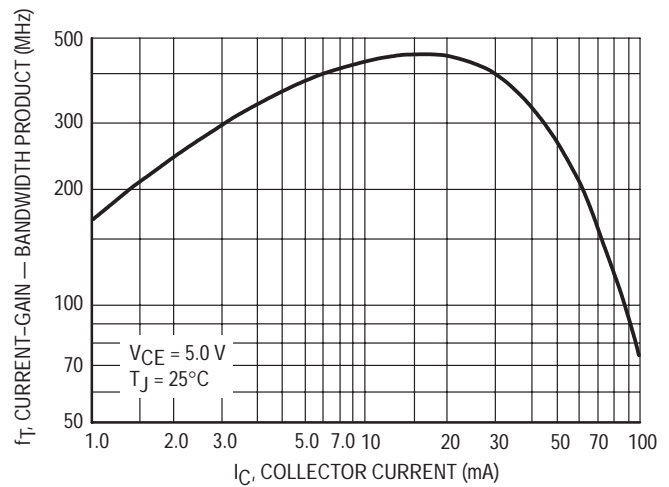
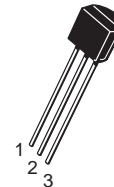
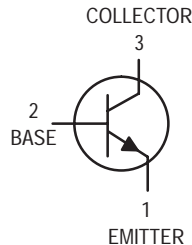


Figure 12. Current-Gain — Bandwidth Product

Amplifier Transistors

NPN Silicon

2N5209
2N5210



CASE 29-04, STYLE 1
TO-92 (TO-226AA)

MAXIMUM RATINGS

Rating	Symbol	Value	Unit
Collector–Emitter Voltage	V_{CEO}	50	Vdc
Collector–Base Voltage	V_{CBO}	50	Vdc
Emitter–Base Voltage	V_{EBO}	4.0	Vdc
Collector Current — Continuous	I_C	50	mAdc
Total Device Dissipation @ $T_A = 25^\circ\text{C}$ Derate above 25°C	P_D	625 5.0	mW mW/ $^\circ\text{C}$
Total Device Dissipation @ $T_C = 25^\circ\text{C}$ Derate above 25°C	P_D	1.5 12	Watts mW/ $^\circ\text{C}$
Operating and Storage Junction Temperature Range	T_J, T_{stg}	-55 to +150	$^\circ\text{C}$

THERMAL CHARACTERISTICS

Characteristic	Symbol	Max	Unit
Thermal Resistance, Junction to Ambient	$R_{\theta JA}$	200	$^\circ\text{C}/\text{W}$
Thermal Resistance, Junction to Case	$R_{\theta JC}$	83.3	$^\circ\text{C}/\text{W}$

ELECTRICAL CHARACTERISTICS ($T_A = 25^\circ\text{C}$ unless otherwise noted)

Characteristic	Symbol	Min	Max	Unit
----------------	--------	-----	-----	------

OFF CHARACTERISTICS

Collector–Emitter Breakdown Voltage ($I_C = 1.0 \text{ mAdc}, I_B = 0$)	$V_{(BR)CEO}$	50	—	Vdc
Collector–Base Breakdown Voltage ($I_C = 0.1 \text{ mAdc}, I_E = 0$)	$V_{(BR)CBO}$	50	—	Vdc
Collector Cutoff Current ($V_{CB} = 35 \text{ Vdc}, I_E = 0$)	I_{CBO}	—	50	nAdc
Emitter Cutoff Current ($V_{EB} = 3.0 \text{ Vdc}, I_C = 0$)	I_{EBO}	—	50	nAdc

2N5209 2N5210

ELECTRICAL CHARACTERISTICS ($T_A = 25^\circ\text{C}$ unless otherwise noted) (Continued)

Characteristic	Symbol	Min	Max	Unit
ON CHARACTERISTICS				
DC Current Gain ($I_C = 100 \mu\text{A}$, $V_{CE} = 5.0 \text{ Vdc}$)	h_{FE}	100	300	—
		200	600	
($I_C = 1.0 \text{ mA}$, $V_{CE} = 5.0 \text{ Vdc}$)		150	—	
		250	—	
($I_C = 10 \text{ mA}$, $V_{CE} = 5.0 \text{ Vdc}$) ⁽¹⁾		150	—	
		250	—	
Collector–Emitter Saturation Voltage ($I_C = 10 \text{ mA}$, $I_B = 1.0 \text{ mA}$)	$V_{CE(sat)}$	—	0.7	Vdc
Base–Emitter On Voltage ($I_C = 1.0 \text{ mA}$, $V_{CE} = 5.0 \text{ Vdc}$)	$V_{BE(on)}$	—	0.85	Vdc

SMALL–SIGNAL CHARACTERISTICS

Current–Gain — Bandwidth Product ($I_C = 500 \mu\text{A}$, $V_{CE} = 5.0 \text{ Vdc}$, $f = 20 \text{ MHz}$)	f_T	30	—	MHz
Collector–Base Capacitance ($V_{CB} = 5.0 \text{ Vdc}$, $I_E = 0$, $f = 1.0 \text{ MHz}$)	C_{cb}	—	4.0	pF
Small–Signal Current Gain ($I_C = 1.0 \text{ mA}$, $V_{CE} = 5.0 \text{ Vdc}$, $f = 1.0 \text{ kHz}$)	h_{fe}	150	600	—
		250	900	
Noise Figure ($I_C = 20 \mu\text{A}$, $V_{CE} = 5.0 \text{ Vdc}$, $R_S = 22 \text{ k}\Omega$, $f = 1.0 \text{ kHz}$)	NF	—	3.0	dB
		—	2.0	
($I_C = 20 \mu\text{A}$, $V_{CE} = 5.0 \text{ Vdc}$, $R_S = 10 \text{ k}\Omega$, $f = 1.0 \text{ kHz}$)		—	4.0	
		—	3.0	

1. Pulse Test: Pulse Width = 300 μs , Duty Cycle = 2.0%.

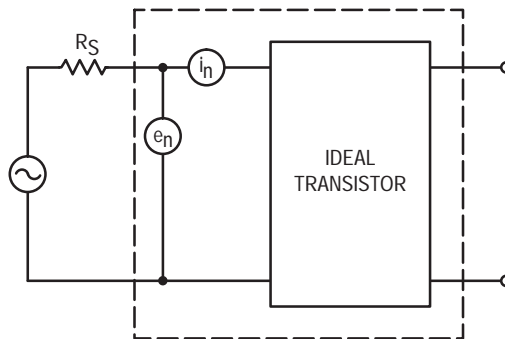


Figure 1. Transistor Noise Model

NOISE CHARACTERISTICS

($V_{CE} = 5.0 \text{ Vdc}$, $T_A = 25^\circ\text{C}$)

NOISE VOLTAGE

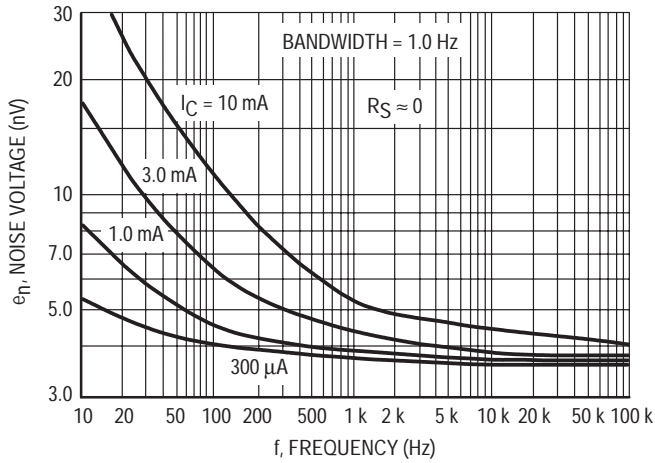


Figure 2. Effects of Frequency

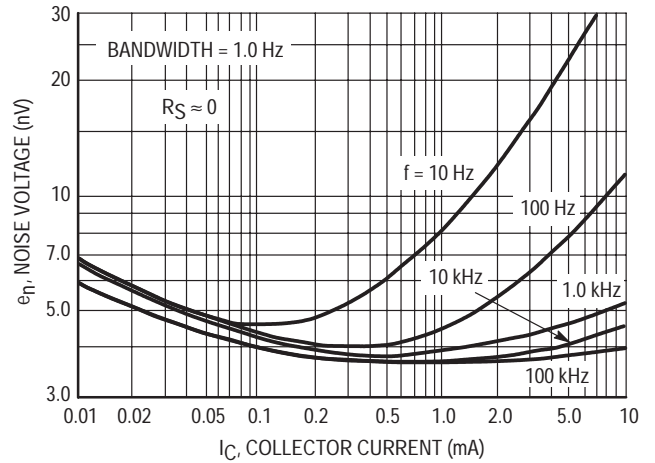


Figure 3. Effects of Collector Current

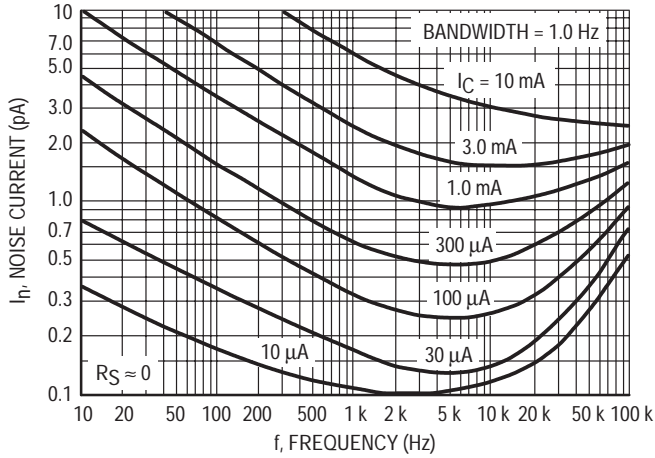


Figure 4. Noise Current

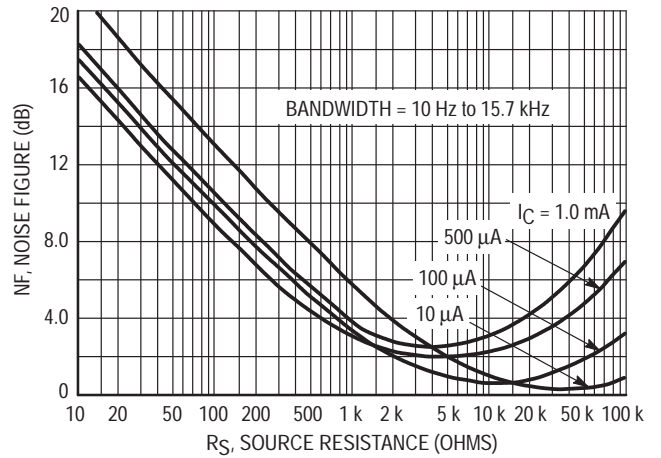


Figure 5. Wideband Noise Figure

100 Hz NOISE DATA

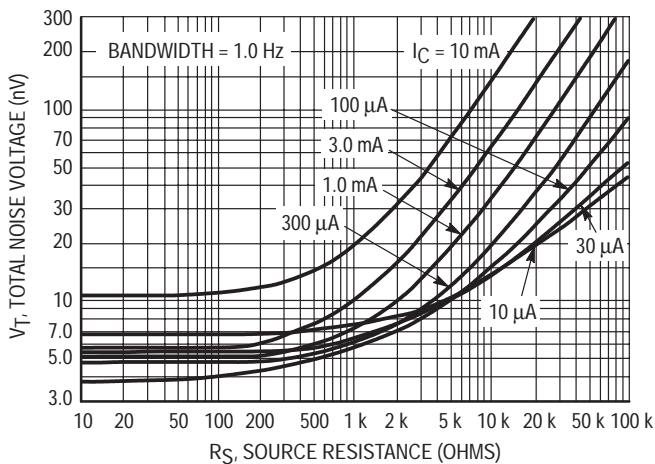


Figure 6. Total Noise Voltage

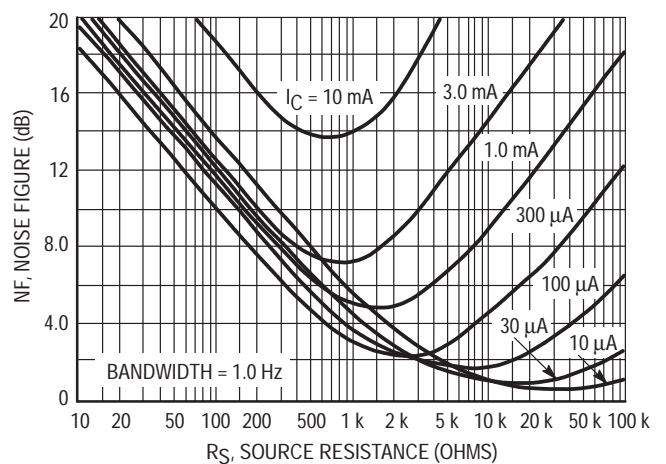


Figure 7. Noise Figure

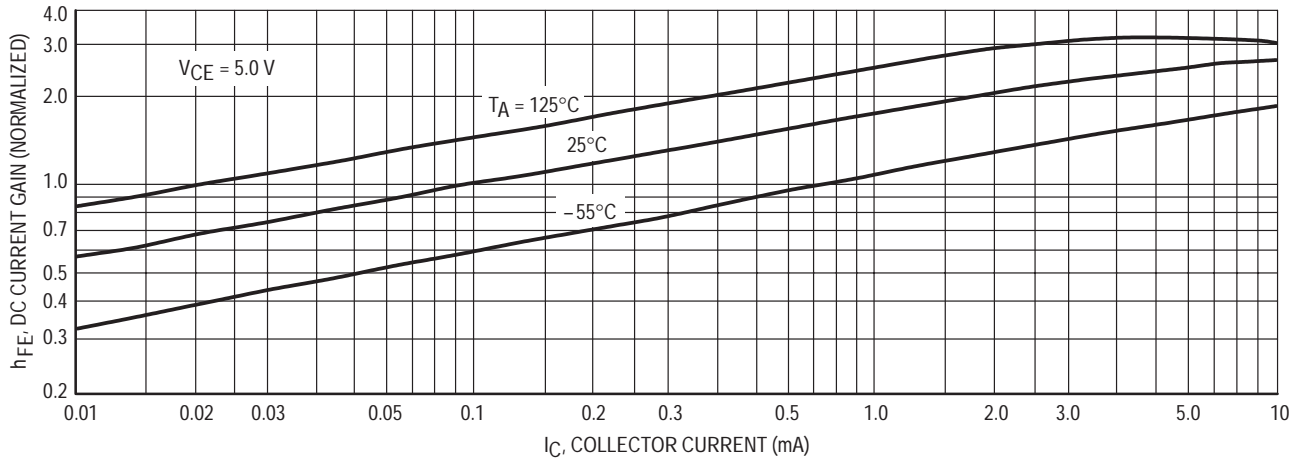


Figure 8. DC Current Gain

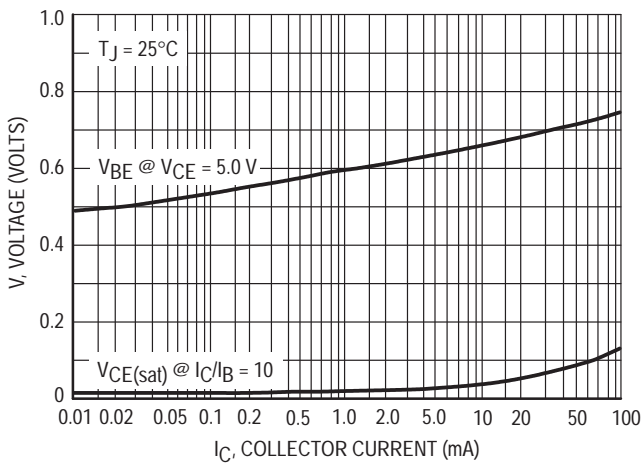


Figure 9. "On" Voltages

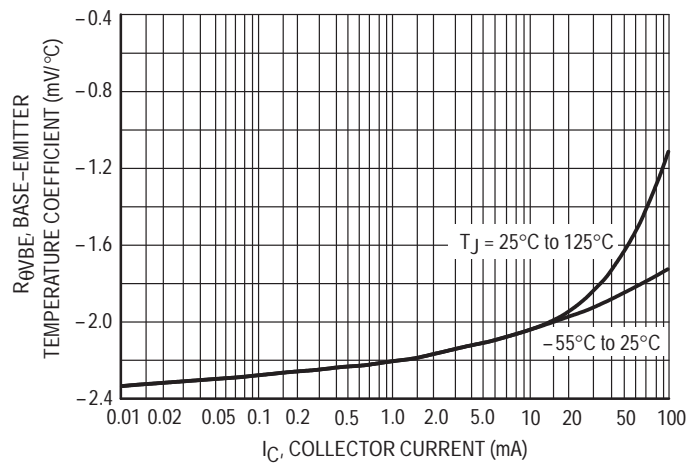


Figure 10. Temperature Coefficients

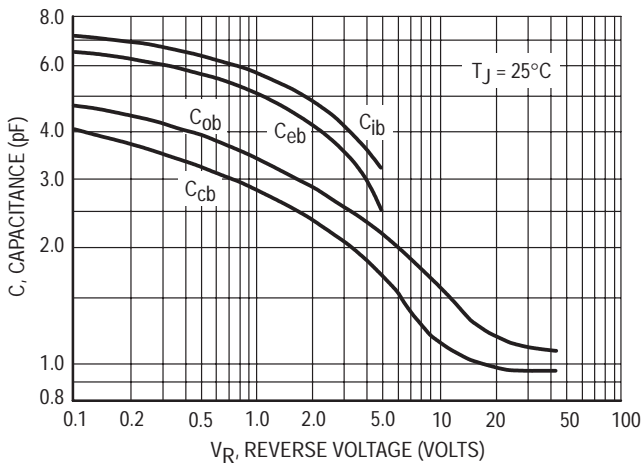


Figure 11. Capacitance

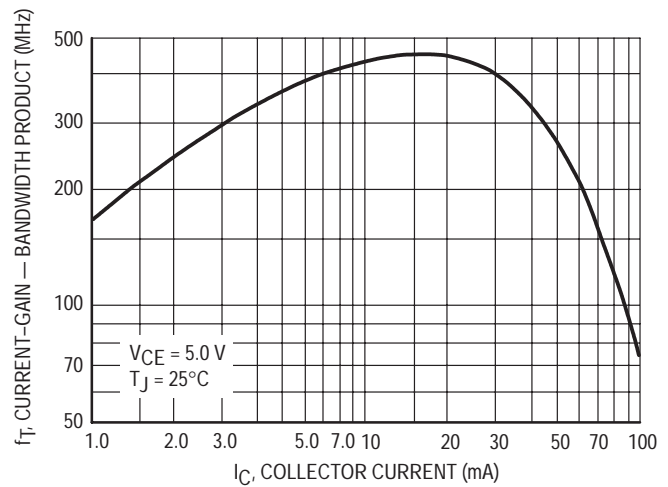


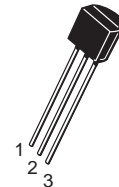
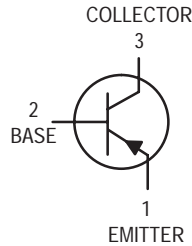
Figure 12. Current-Gain — Bandwidth Product

Amplifier Transistors

PNP Silicon

2N5400
2N5401*

*Motorola Preferred Device



CASE 29-04, STYLE 1
TO-92 (TO-226AA)

MAXIMUM RATINGS

Rating	Symbol	2N5400	2N5401	Unit
Collector–Emitter Voltage	V_{CEO}	120	150	Vdc
Collector–Base Voltage	V_{CBO}	130	160	Vdc
Emitter–Base Voltage	V_{EBO}	5.0		Vdc
Collector Current — Continuous	I_C	600		mAdc
Total Device Dissipation @ $T_A = 25^\circ\text{C}$ Derate above 25°C	P_D	625	5.0	mW mW/ $^\circ\text{C}$
Total Device Dissipation @ $T_C = 25^\circ\text{C}$ Derate above 25°C	P_D	1.5	12	Watts mW/ $^\circ\text{C}$
Operating and Storage Junction Temperature Range	T_J, T_{stg}	–55 to +150		$^\circ\text{C}$

THERMAL CHARACTERISTICS

Characteristic	Symbol	Max	Unit
Thermal Resistance, Junction to Ambient	$R_{\theta JA}$	200	$^\circ\text{C}/\text{W}$
Thermal Resistance, Junction to Case	$R_{\theta JC}$	83.3	$^\circ\text{C}/\text{W}$

ELECTRICAL CHARACTERISTICS ($T_A = 25^\circ\text{C}$ unless otherwise noted)

Characteristic	Symbol	Min	Max	Unit
----------------	--------	-----	-----	------

OFF CHARACTERISTICS

Collector–Emitter Breakdown Voltage ⁽¹⁾ ($I_C = 1.0 \text{ mAdc}, I_E = 0$)	$V_{(BR)CEO}$	120 150	— —	Vdc
Collector–Base Breakdown Voltage ($I_C = 100 \mu\text{Adc}, I_E = 0$)	$V_{(BR)CBO}$	130 160	— —	Vdc
Emitter–Base Breakdown Voltage ($I_E = 10 \mu\text{Adc}, I_C = 0$)	$V_{(BR)EBO}$	5.0	—	Vdc
Collector Cutoff Current ($V_{CB} = 100 \text{ Vdc}, I_E = 0$) ($V_{CB} = 120 \text{ Vdc}, I_E = 0$) ($V_{CB} = 100 \text{ Vdc}, I_E = 0, T_A = 100^\circ\text{C}$) ($V_{CB} = 120 \text{ Vdc}, I_E = 0, T_A = 100^\circ\text{C}$)	I_{CBO}	— — — —	100 50 100 50	nAdc μAdc
Emitter Cutoff Current ($V_{EB} = 3.0 \text{ Vdc}, I_C = 0$)	I_{EBO}	—	50	nAdc

1. Pulse Test: Pulse Width = 300 μs , Duty Cycle = 2.0%.

Preferred devices are Motorola recommended choices for future use and best overall value.

2N5400 2N5401**ELECTRICAL CHARACTERISTICS** ($T_A = 25^\circ\text{C}$ unless otherwise noted) (Continued)

Characteristic		Symbol	Min	Max	Unit
ON CHARACTERISTICS(1)					
DC Current Gain ($I_C = 1.0\text{ mAdc}$, $V_{CE} = 5.0\text{ Vdc}$)	2N5400	h_{FE}	30	—	—
	2N5401		50	—	—
	2N5400		40	180	—
	2N5401		60	240	—
	2N5400		40	—	—
	2N5401		50	—	—
Collector–Emitter Saturation Voltage ($I_C = 10\text{ mAdc}$, $I_B = 1.0\text{ mAdc}$) ($I_C = 50\text{ mAdc}$, $I_B = 5.0\text{ mAdc}$)		$V_{CE(sat)}$	—	0.2 0.5	Vdc
Base–Emitter Saturation Voltage ($I_C = 10\text{ mAdc}$, $I_B = 1.0\text{ mAdc}$) ($I_C = 50\text{ mAdc}$, $I_B = 5.0\text{ mAdc}$)		$V_{BE(sat)}$	—	1.0 1.0	Vdc

SMALL–SIGNAL CHARACTERISTICS

Current–Gain — Bandwidth Product ($I_C = 10\text{ mAdc}$, $V_{CE} = 10\text{ Vdc}$, $f = 100\text{ MHz}$)	2N5400 2N5401	f_T	100 100	400 300	MHz
Output Capacitance ($V_{CB} = 10\text{ Vdc}$, $I_E = 0$, $f = 1.0\text{ MHz}$)		C_{obo}	—	6.0	pF
Small–Signal Current Gain ($I_C = 1.0\text{ mAdc}$, $V_{CE} = 10\text{ Vdc}$, $f = 1.0\text{ kHz}$)	2N5400 2N5401	h_{fe}	30 40	200 200	—
Noise Figure ($I_C = 250\text{ }\mu\text{A}$, $V_{CE} = 5.0\text{ Vdc}$, $R_S = 1.0\text{ k}\Omega$, $f = 1.0\text{ kHz}$)		NF	—	8.0	dB

1. Pulse Test: Pulse Width = 300 μs , Duty Cycle = 2.0%.

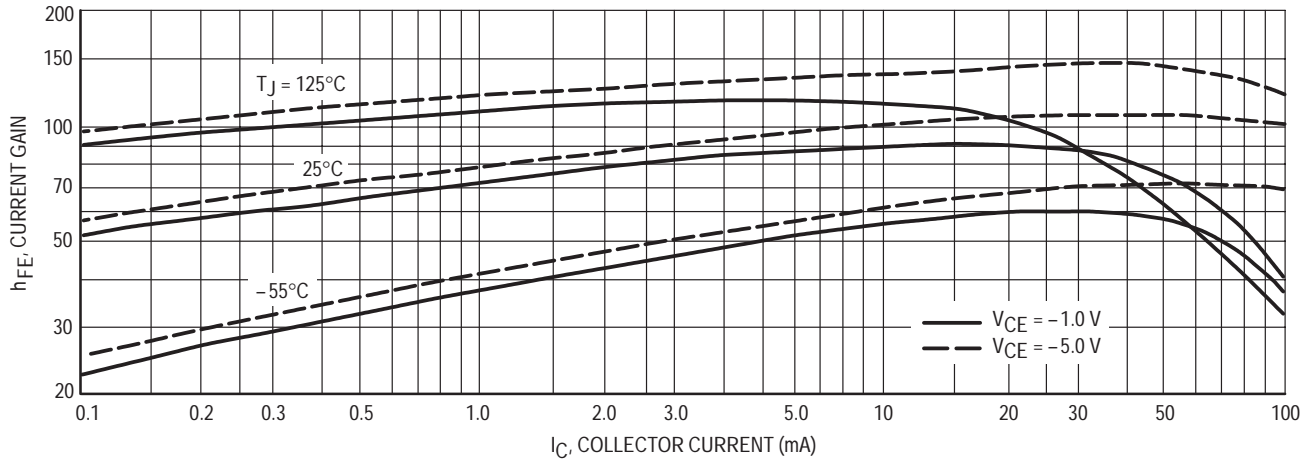


Figure 1. DC Current Gain

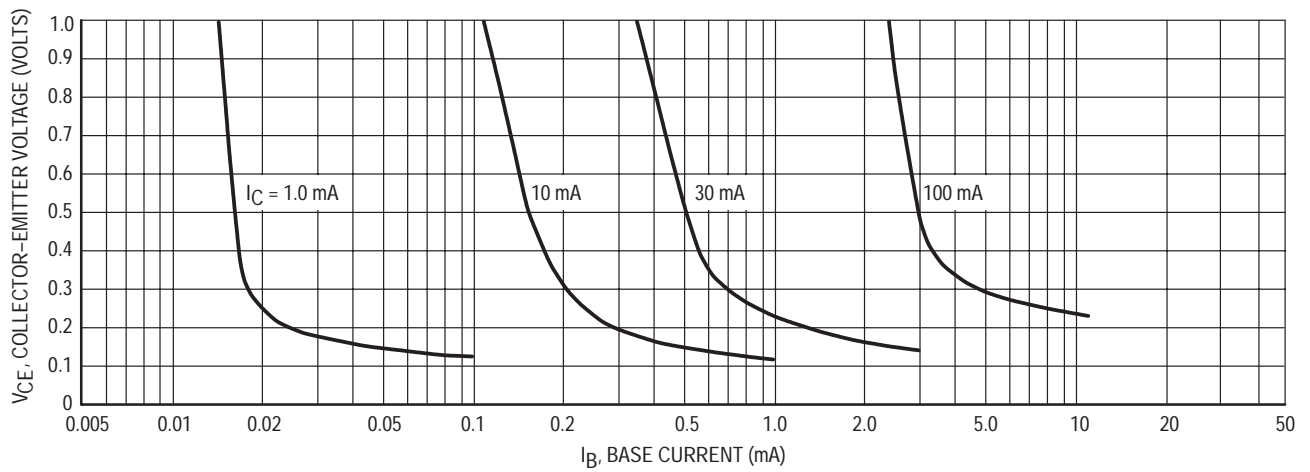


Figure 2. Collector Saturation Region

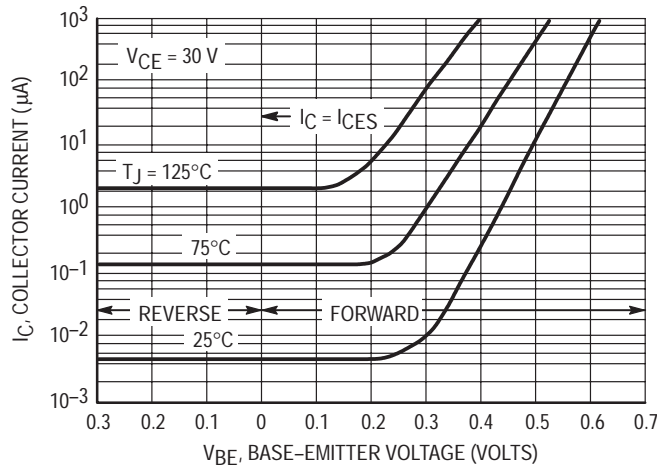


Figure 3. Collector Cut-Off Region

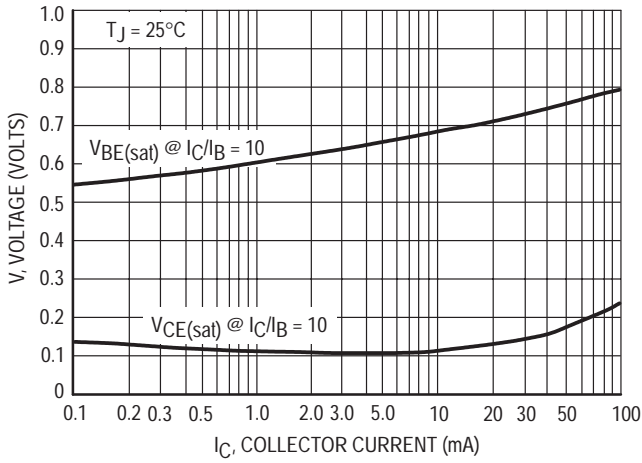


Figure 4. "On" Voltages

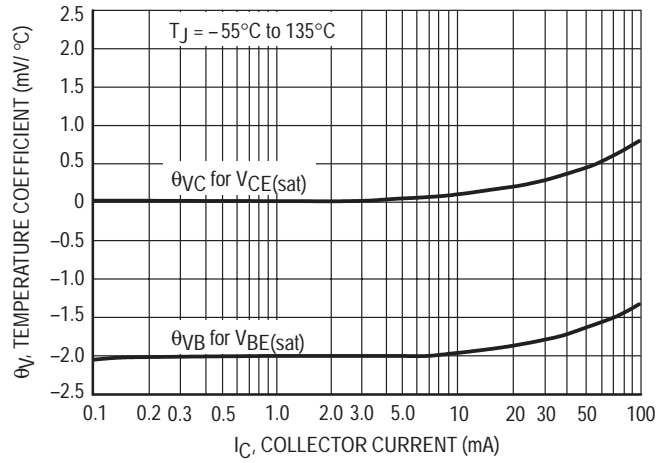
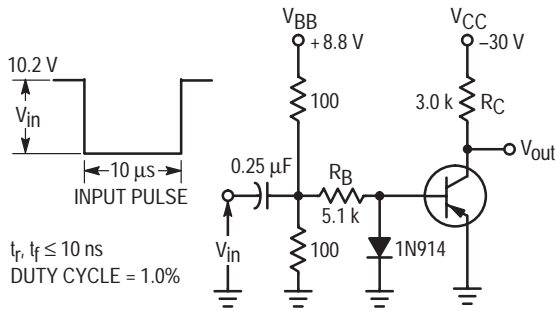


Figure 5. Temperature Coefficients



Values Shown are for $I_C @ 10\ \text{mA}$

Figure 6. Switching Time Test Circuit

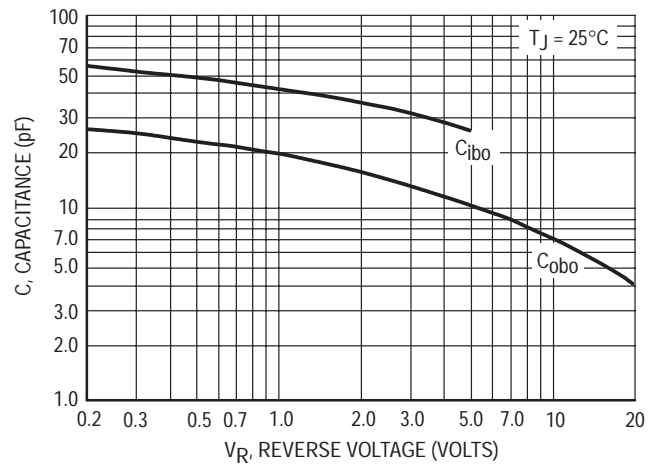


Figure 7. Capacitances

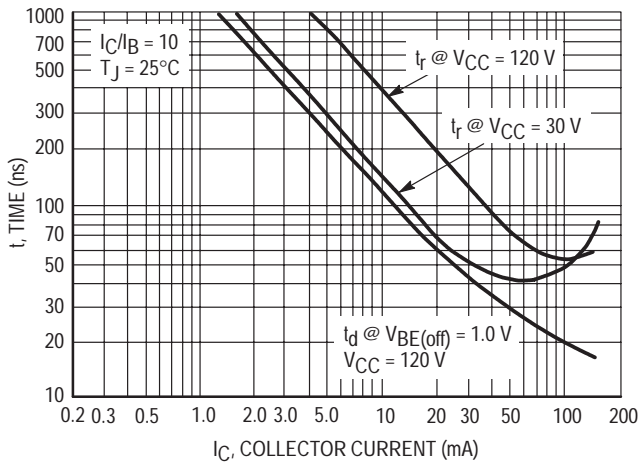


Figure 8. Turn-On Time

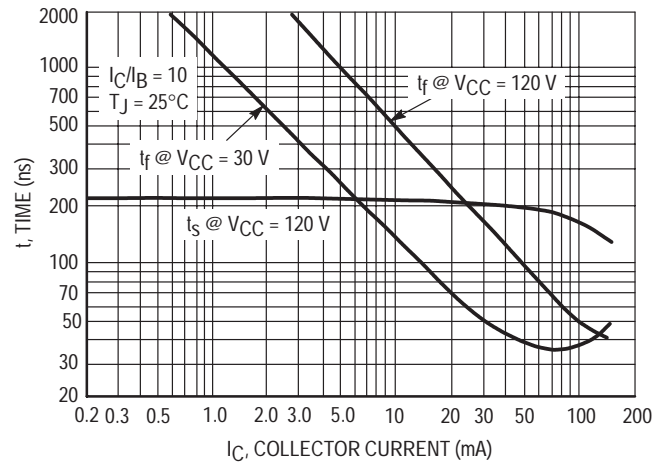
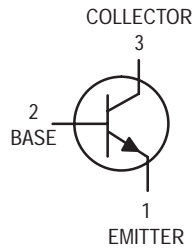


Figure 9. Turn-Off Time

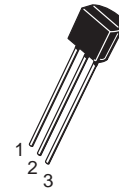
Amplifier Transistors

NPN Silicon



2N5550
2N5551*

*Motorola Preferred Device



CASE 29-04, STYLE 1
TO-92 (TO-226AA)

MAXIMUM RATINGS

Rating	Symbol	2N5550	2N5551	Unit
Collector–Emitter Voltage	V_{CEO}	140	160	Vdc
Collector–Base Voltage	V_{CBO}	160	180	Vdc
Emitter–Base Voltage	V_{EBO}	6.0		Vdc
Collector Current — Continuous	I_C	600		mAdc
Total Device Dissipation @ $T_A = 25^\circ\text{C}$ Derate above 25°C	P_D	625	5.0	mW mW/ $^\circ\text{C}$
Total Device Dissipation @ $T_C = 25^\circ\text{C}$ Derate above 25°C	P_D	1.5	12	Watts mW/ $^\circ\text{C}$
Operating and Storage Junction Temperature Range	T_J, T_{stg}	–55 to +150		$^\circ\text{C}$

THERMAL CHARACTERISTICS

Characteristic	Symbol	Max	Unit
Thermal Resistance, Junction to Ambient	$R_{\theta JA}$	200	$^\circ\text{C}/\text{W}$
Thermal Resistance, Junction to Case	$R_{\theta JC}$	83.3	$^\circ\text{C}/\text{W}$

ELECTRICAL CHARACTERISTICS ($T_A = 25^\circ\text{C}$ unless otherwise noted)

Characteristic	Symbol	Min	Max	Unit
----------------	--------	-----	-----	------

OFF CHARACTERISTICS

Collector–Emitter Breakdown Voltage ⁽¹⁾ ($I_C = 1.0 \text{ mAdc}, I_E = 0$)	$V_{(BR)CEO}$	140 160	— —	Vdc
Collector–Base Breakdown Voltage ($I_C = 100 \mu\text{Adc}, I_E = 0$)	$V_{(BR)CBO}$	160 180	— —	Vdc
Emitter–Base Breakdown Voltage ($I_E = 10 \mu\text{Adc}, I_C = 0$)	$V_{(BR)EBO}$	6.0	—	Vdc
Collector Cutoff Current ($V_{CB} = 100 \text{ Vdc}, I_E = 0$) ($V_{CB} = 120 \text{ Vdc}, I_E = 0$) ($V_{CB} = 100 \text{ Vdc}, I_E = 0, T_A = 100^\circ\text{C}$) ($V_{CB} = 120 \text{ Vdc}, I_E = 0, T_A = 100^\circ\text{C}$)	I_{CBO}	— — — —	100 50 100 50	nAdc μAdc
Emitter Cutoff Current ($V_{EB} = 4.0 \text{ Vdc}, I_C = 0$)	I_{EBO}	—	50	nAdc

1. Pulse Test: Pulse Width = 300 μs , Duty Cycle = 2.0%.

Preferred devices are Motorola recommended choices for future use and best overall value.

2N5550 2N5551

ELECTRICAL CHARACTERISTICS ($T_A = 25^\circ\text{C}$ unless otherwise noted) (Continued)

Characteristic		Symbol	Min	Max	Unit
ON CHARACTERISTICS(1)					
DC Current Gain ($I_C = 1.0 \text{ mAdc}$, $V_{CE} = 5.0 \text{ Vdc}$)	2N5550	h_{FE}	60	—	—
	2N5551		80	—	—
	2N5550		60	250	—
	2N5551		80	250	—
	2N5550		20	—	—
	2N5551		30	—	—
Collector–Emitter Saturation Voltage ($I_C = 10 \text{ mAdc}$, $I_B = 1.0 \text{ mAdc}$)	Both Types	$V_{CE(sat)}$	—	0.15	Vdc
	2N5550		—	0.25	—
	2N5551		—	0.20	—
	2N5551		—	0.20	—
Base–Emitter Saturation Voltage ($I_C = 10 \text{ mAdc}$, $I_B = 1.0 \text{ mAdc}$)	Both Types	$V_{BE(sat)}$	—	1.0	Vdc
	2N5550		—	1.2	—
	2N5551		—	1.0	—
	2N5551		—	1.0	—

SMALL–SIGNAL CHARACTERISTICS

Current–Gain — Bandwidth Product ($I_C = 10 \text{ mAdc}$, $V_{CE} = 10 \text{ Vdc}$, $f = 100 \text{ MHz}$)		f_T	100	300	MHz
Output Capacitance ($V_{CB} = 10 \text{ Vdc}$, $I_E = 0$, $f = 1.0 \text{ MHz}$)		C_{obo}	—	6.0	pF
Input Capacitance ($V_{EB} = 0.5 \text{ Vdc}$, $I_C = 0$, $f = 1.0 \text{ MHz}$)	2N5550	C_{ibo}	—	30	pF
	2N5551		—	20	
Small–Signal Current Gain ($I_C = 1.0 \text{ mAdc}$, $V_{CE} = 10 \text{ Vdc}$, $f = 1.0 \text{ kHz}$)		h_{fe}	50	200	—
Noise Figure ($I_C = 250 \mu\text{Adc}$, $V_{CE} = 5.0 \text{ Vdc}$, $R_S = 1.0 \text{ k}\Omega$, $f = 1.0 \text{ kHz}$)	2N5550	NF	—	10	dB
	2N5551		—	8.0	

1. Pulse Test: Pulse Width = 300 μs , Duty Cycle = 2.0%.

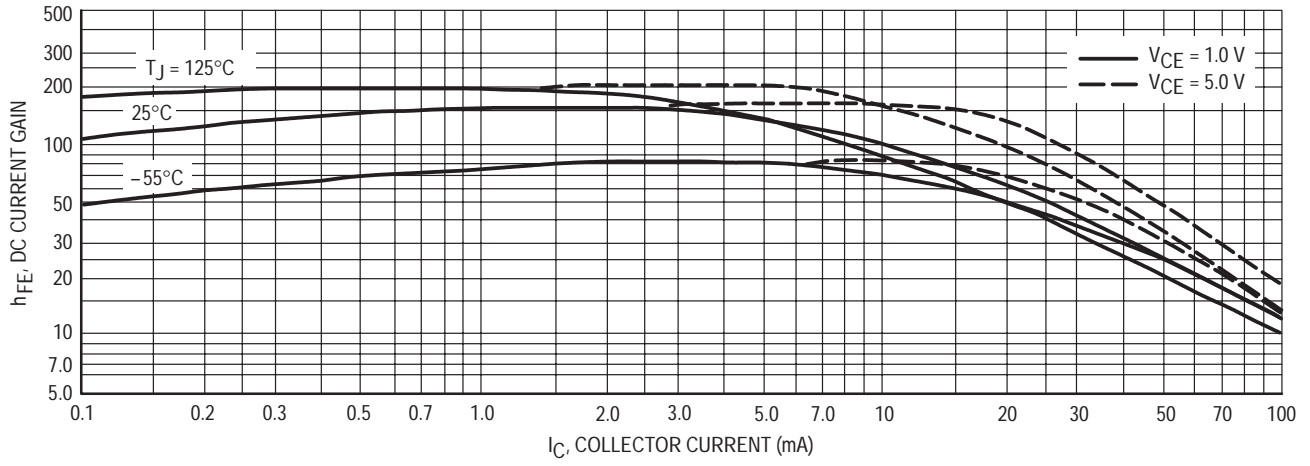


Figure 1. DC Current Gain

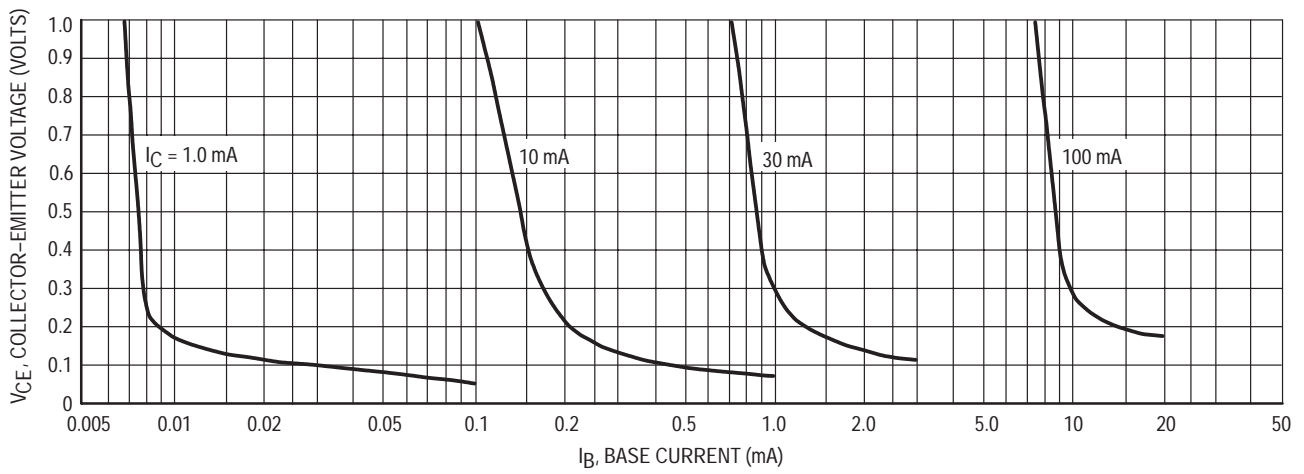


Figure 2. Collector Saturation Region

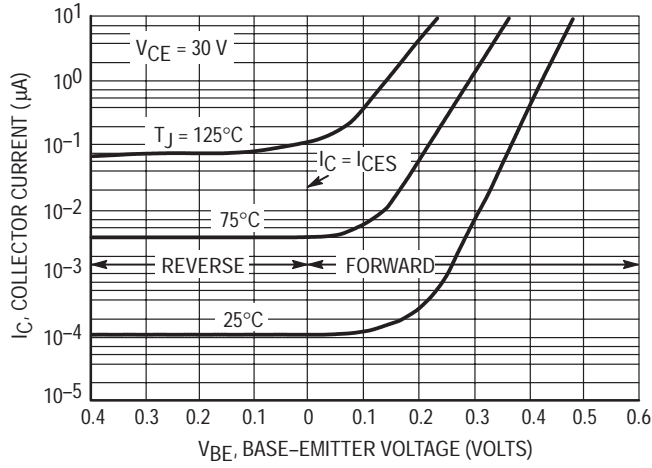


Figure 3. Collector Cut-Off Region

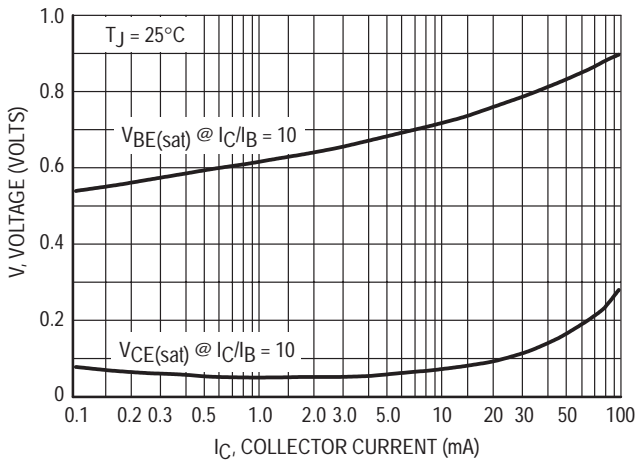


Figure 4. "On" Voltages

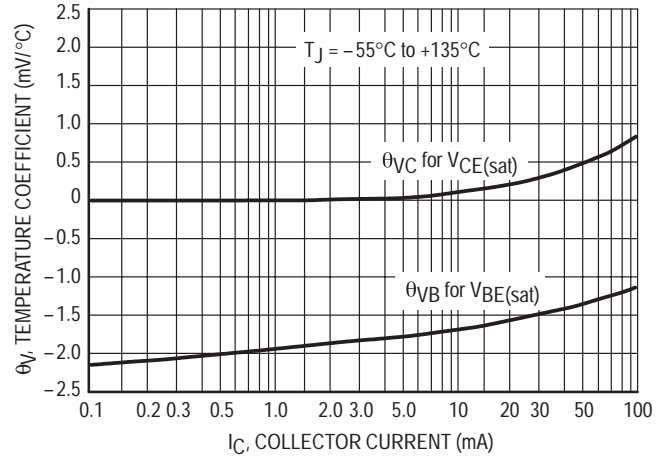
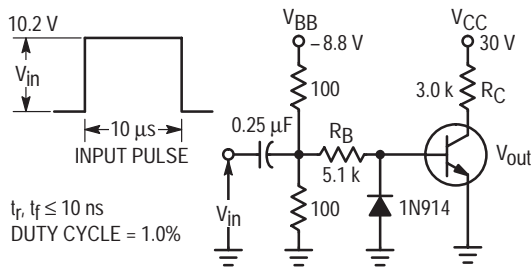


Figure 5. Temperature Coefficients



Values Shown are for I_C @ 10 mA

Figure 6. Switching Time Test Circuit

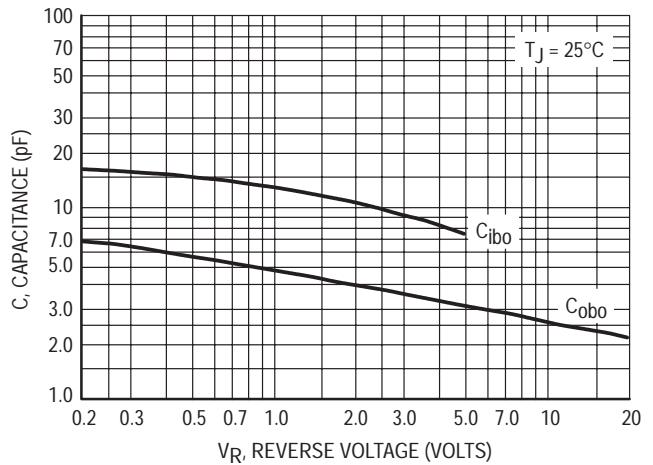


Figure 7. Capacitances

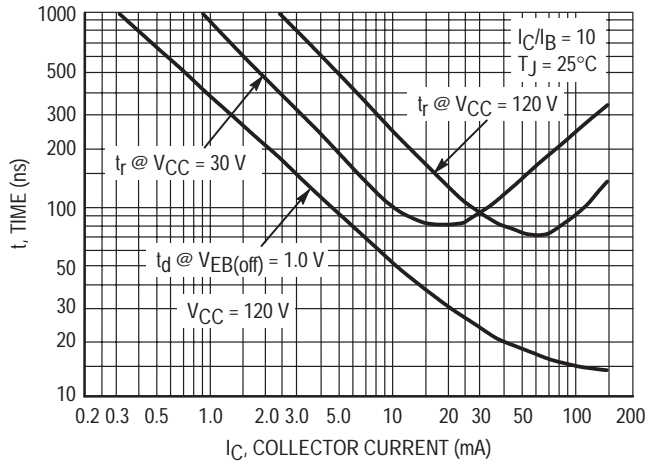


Figure 8. Turn-On Time

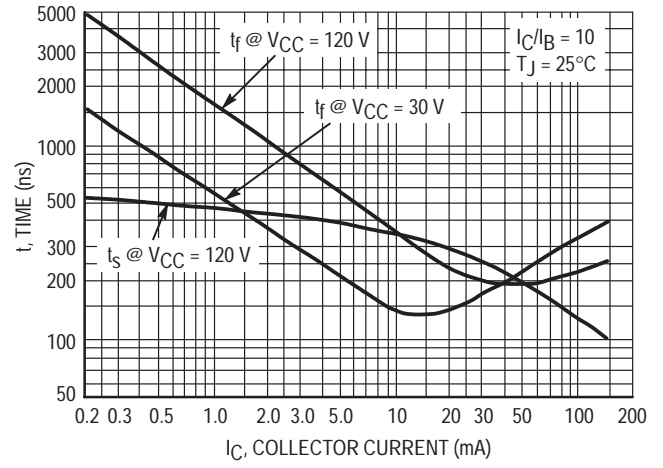
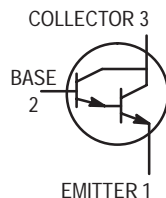


Figure 9. Turn-Off Time

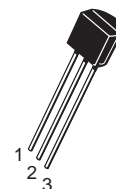
Darlington Transistors

NPN Silicon



2N6426*
2N6427

*Motorola Preferred Device



CASE 29-04, STYLE 1
TO-92 (TO-226AA)

MAXIMUM RATINGS

Rating	Symbol	Value	Unit
Collector–Emitter Voltage	V_{CEO}	40	Vdc
Collector–Base Voltage	V_{CBO}	40	Vdc
Emitter–Base Voltage	V_{EBO}	12	Vdc
Collector Current — Continuous	I_C	500	mAdc
Total Device Dissipation @ $T_A = 25^\circ\text{C}$ Derate above 25°C	P_D	625 5.0	mW mW/ $^\circ\text{C}$
Total Device Dissipation @ $T_C = 25^\circ\text{C}$ Derate above 25°C	P_D	1.5 12	Watts mW/ $^\circ\text{C}$
Operating and Storage Junction Temperature Range	T_J, T_{stg}	-55 to +150	$^\circ\text{C}$

THERMAL CHARACTERISTICS

Characteristic	Symbol	Max	Unit
Thermal Resistance, Junction to Ambient	$R_{\theta JA}$	200	$^\circ\text{C}/\text{W}$
Thermal Resistance, Junction to Case	$R_{\theta JC}$	83.3	$^\circ\text{C}/\text{W}$

ELECTRICAL CHARACTERISTICS ($T_A = 25^\circ\text{C}$ unless otherwise noted)

Characteristic	Symbol	Min	Typ	Max	Unit
----------------	--------	-----	-----	-----	------

OFF CHARACTERISTICS

Collector–Emitter Breakdown Voltage ⁽¹⁾ ($I_C = 10 \text{ mAdc}, V_{BE} = 0$)	$V_{(BR)CEO}$	40	—	—	Vdc
Collector–Base Breakdown Voltage ($I_C = 100 \mu\text{Adc}, I_E = 0$)	$V_{(BR)CBO}$	40	—	—	Vdc
Emitter–Base Breakdown Voltage ($I_E = 10 \mu\text{Adc}, I_C = 0$)	$V_{(BR)EBO}$	12	—	—	Vdc
Collector Cutoff Current ($V_{CE} = 25 \text{ Vdc}, I_B = 0$)	I_{CES}	—	—	1.0	μAdc
Collector Cutoff Current ($V_{CB} = 30 \text{ Vdc}, I_E = 0$)	I_{CBO}	—	—	50	nAdc
Emitter Cutoff Current ($V_{EB} = 10 \text{ Vdc}, I_C = 0$)	I_{EBO}	—	—	50	nAdc

1. Pulse Test: Pulse Width $\leq 300 \mu\text{s}$; Duty Cycle $\leq 2.0\%$.

Preferred devices are Motorola recommended choices for future use and best overall value.

ELECTRICAL CHARACTERISTICS ($T_A = 25^\circ\text{C}$ unless otherwise noted) (Continued)

Characteristic	Symbol	Min	Typ	Max	Unit
ON CHARACTERISTICS					
DC Current Gain ⁽¹⁾ ($I_C = 10\text{ mA}$, $V_{CE} = 5.0\text{ Vdc}$)	h_{FE}	20,000	—	200,000	—
	2N6426	10,000	—	100,000	
	2N6427				
($I_C = 100\text{ mA}$, $V_{CE} = 5.0\text{ Vdc}$)		30,000	—	300,000	
	2N6426	20,000	—	200,000	
	2N6427				
($I_C = 500\text{ mA}$, $V_{CE} = 5.0\text{ Vdc}$)		20,000	—	200,000	
	2N6426	14,000	—	140,000	
	2N6427				
Collector–Emitter Saturation Voltage ($I_C = 50\text{ mA}$, $I_B = 0.5\text{ mA}$) ($I_C = 500\text{ mA}$, $I_B = 0.5\text{ mA}$)	$V_{CE(sat)}$	—	0.71	1.2	Vdc
		—	0.9	1.5	
Base–Emitter Saturation Voltage ($I_C = 500\text{ mA}$, $I_B = 0.5\text{ mA}$)	$V_{BE(sat)}$	—	1.52	2.0	Vdc
Base–Emitter On Voltage ($I_C = 50\text{ mA}$, $V_{CE} = 5.0\text{ Vdc}$)	$V_{BE(on)}$	—	1.24	1.75	Vdc

SMALL–SIGNAL CHARACTERISTICS

Output Capacitance ($V_{CB} = 10\text{ Vdc}$, $I_E = 0$, $f = 1.0\text{ MHz}$)	C_{obo}	—	5.4	7.0	pF
Input Capacitance ($V_{EB} = 1.0\text{ Vdc}$, $I_C = 0$, $f = 1.0\text{ MHz}$)	C_{ibo}	—	10	15	pF
Input Impedance ($I_C = 10\text{ mA}$, $V_{CE} = 5.0\text{ Vdc}$, $f = 1.0\text{ kHz}$)	h_{ie}	100	—	2000	k Ω
	2N6426	50	—	1000	
	2N6427				
Small–Signal Current Gain ($I_C = 10\text{ mA}$, $V_{CE} = 5.0\text{ Vdc}$, $f = 1.0\text{ kHz}$)	h_{fe}	20,000	—	—	—
	2N6426	10,000	—	—	
	2N6427				
Current–Gain — High Frequency ($I_C = 10\text{ mA}$, $V_{CE} = 5.0\text{ Vdc}$, $f = 100\text{ MHz}$)	$ h_{fe} $	1.5	2.4	—	—
	2N6426	1.3	2.4	—	
	2N6427				
Output Admittance ($I_C = 10\text{ mA}$, $V_{CE} = 5.0\text{ Vdc}$, $f = 1.0\text{ kHz}$)	h_{oe}	—	—	1000	μhos
Noise Figure ($I_C = 1.0\text{ mA}$, $V_{CE} = 5.0\text{ Vdc}$, $R_S = 100\text{ k}\Omega$, $f = 1.0\text{ kHz}$)	NF	—	3.0	10	dB

1. Pulse Test: Pulse Width $\leq 300\ \mu\text{s}$; Duty Cycle $\leq 2.0\%$.

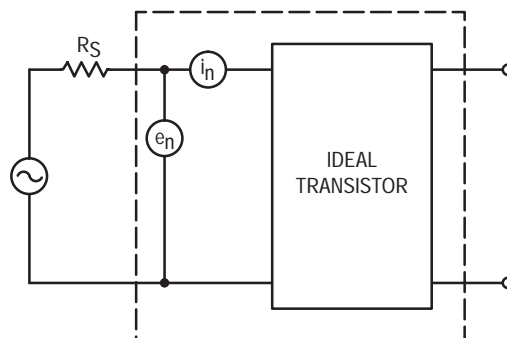


Figure 1. Transistor Noise Model

NOISE CHARACTERISTICS

($V_{CE} = 5.0 \text{ Vdc}$, $T_A = 25^\circ\text{C}$)

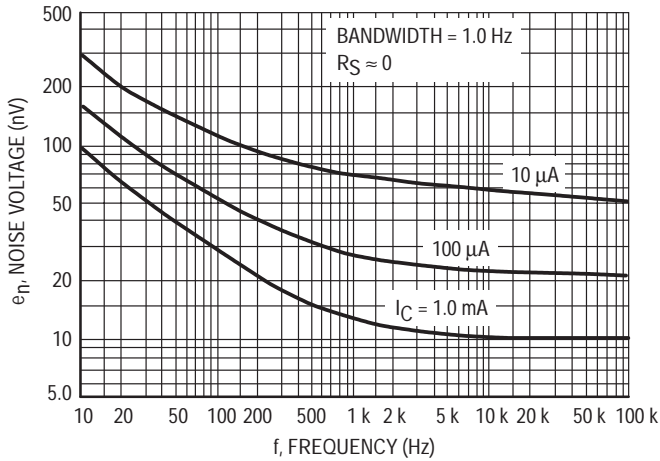


Figure 2. Noise Voltage

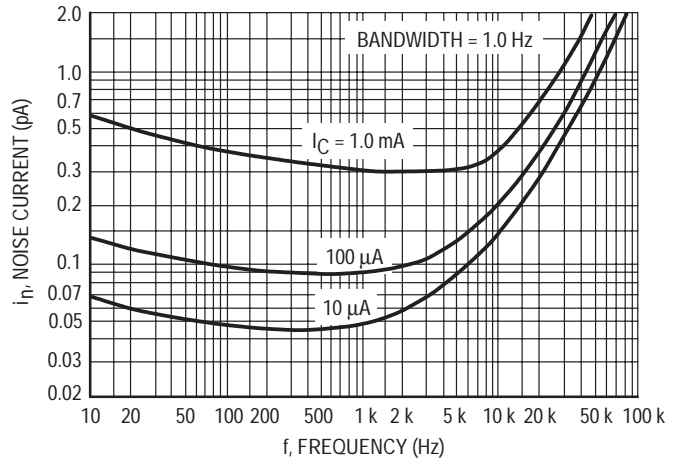


Figure 3. Noise Current

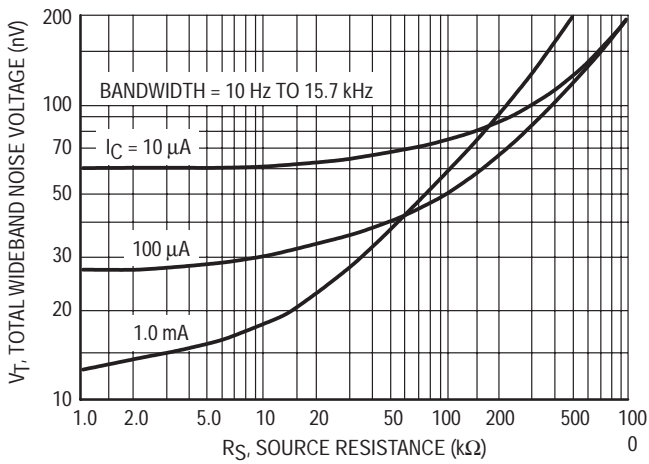


Figure 4. Total Wideband Noise Voltage

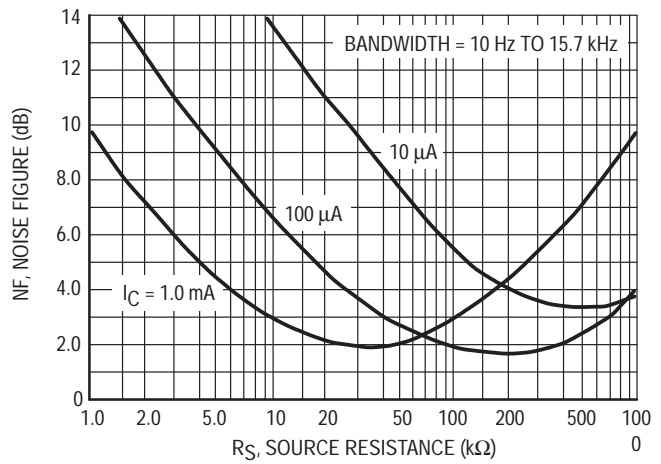


Figure 5. Wideband Noise Figure

SMALL-SIGNAL CHARACTERISTICS

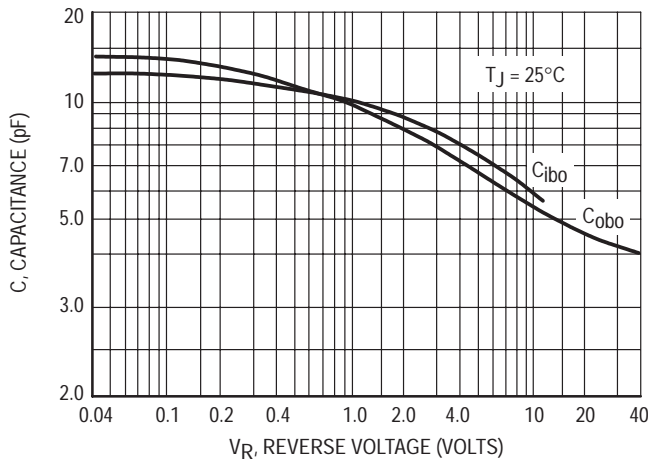


Figure 6. Capacitance

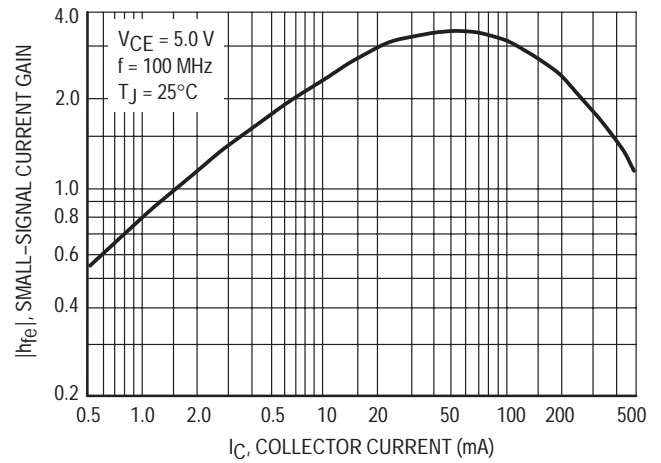


Figure 7. High Frequency Current Gain

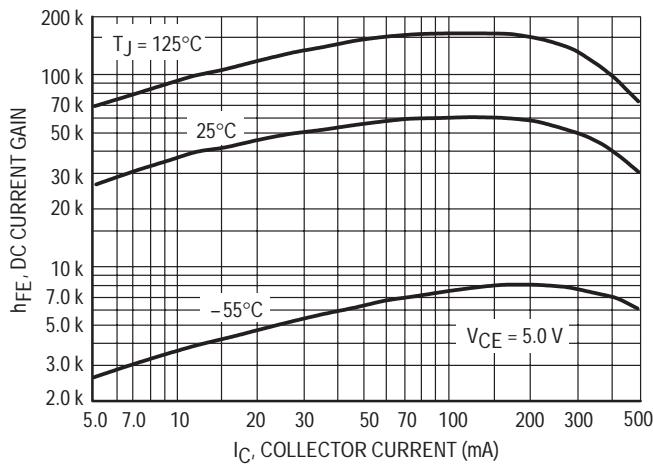


Figure 8. DC Current Gain

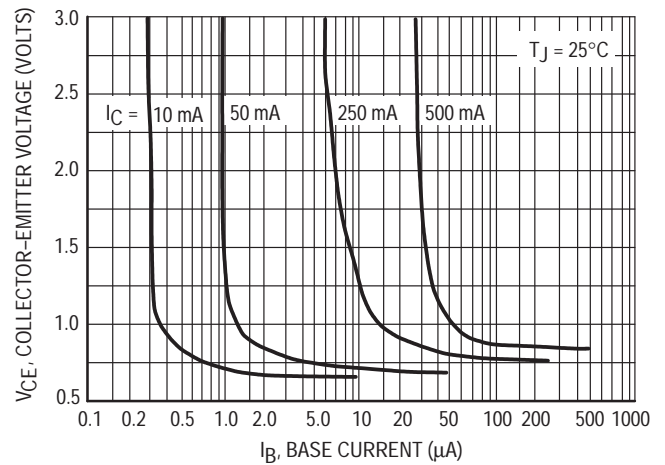


Figure 9. Collector Saturation Region

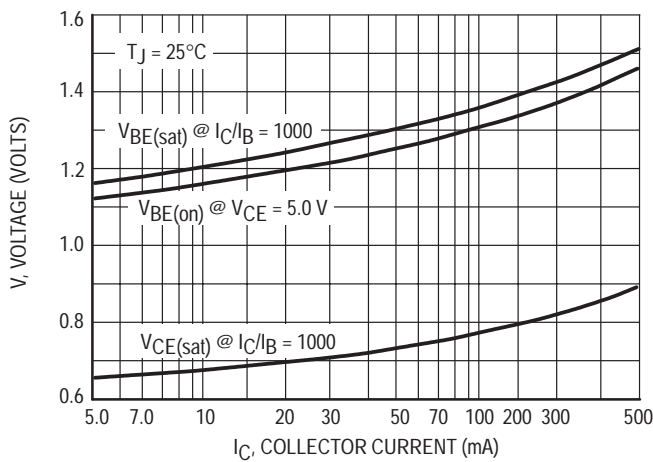


Figure 10. "On" Voltages

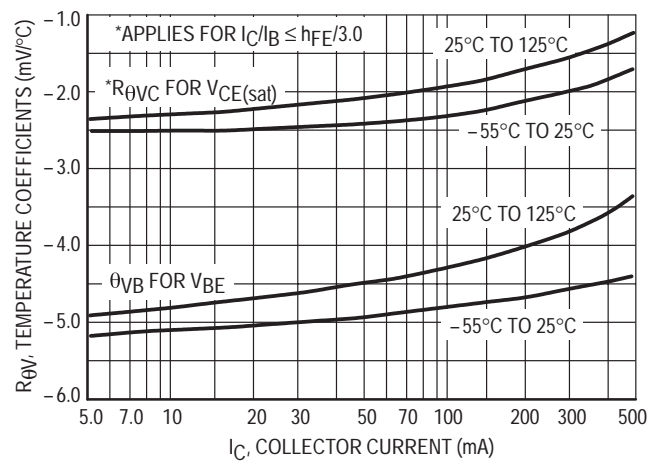


Figure 11. Temperature Coefficients

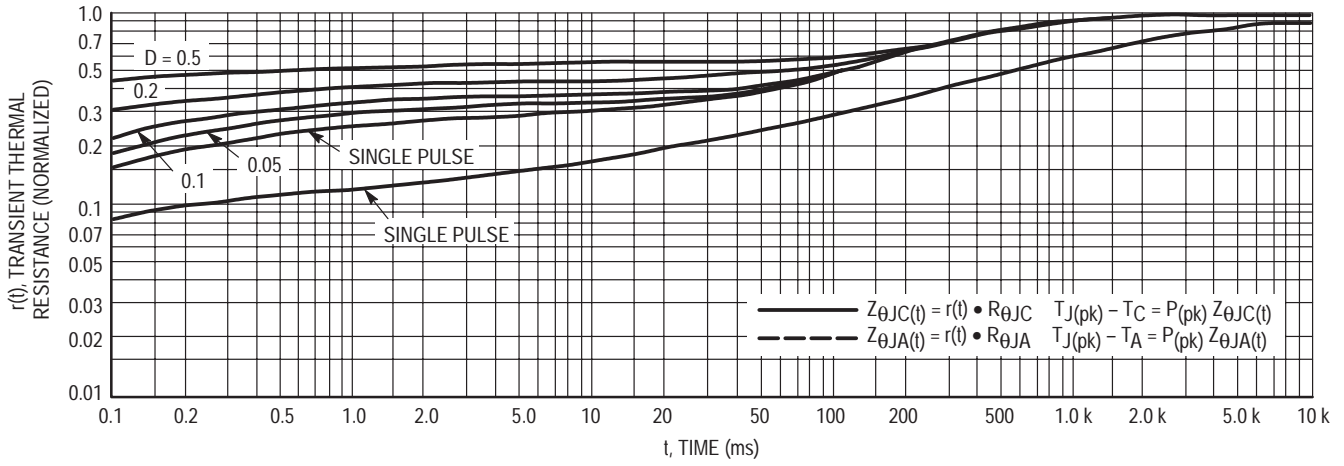


Figure 12. Thermal Response

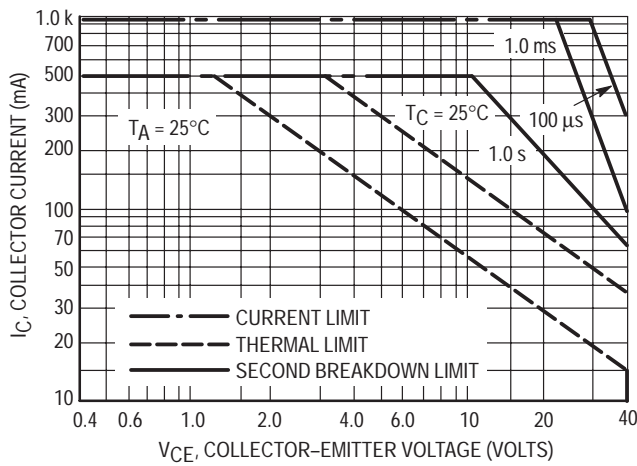
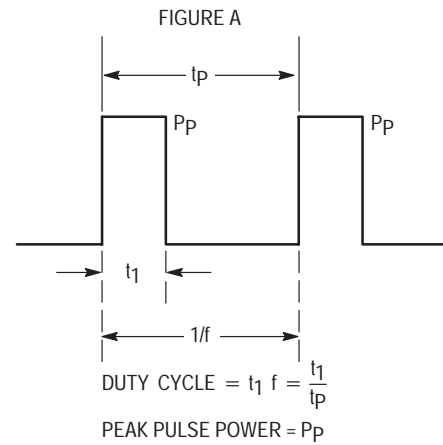
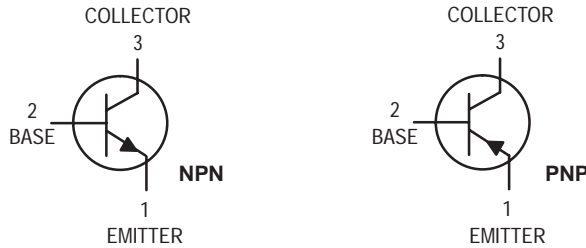


Figure 13. Active Region Safe Operating Area



Design Note: Use of Transient Thermal Resistance Data

High Voltage Transistors

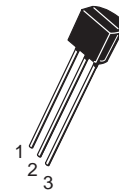


NPN
2N6515
2N6517
PNP
2N6519
2N6520

Voltage and current are negative for PNP transistors

MAXIMUM RATINGS

Rating	Symbol	2N6515	2N6519	2N6517 2N6520	Unit
Collector–Emitter Voltage	V_{CEO}	250	300	350	Vdc
Collector–Base Voltage	V_{CBO}	250	300	350	Vdc
Emitter–Base Voltage 2N6515, 2N6516, 2N6517 2N6519, 2N6520	V_{EBO}	6.0 5.0			Vdc
Base Current	I_B	250			mAdc
Collector Current — Continuous	I_C	500			mAdc
Total Device Dissipation @ $T_A = 25^\circ\text{C}$ Derate above 25°C	P_D	625 5.0			mW mW/°C
Total Device Dissipation @ $T_C = 25^\circ\text{C}$ Derate above 25°C	P_D	1.5 12			Watts mW/°C
Operating and Storage Junction Temperature Range	T_J, T_{stg}	–55 to +150			°C



CASE 29–04, STYLE 1
TO–92 (TO–226AA)

THERMAL CHARACTERISTICS

Characteristic	Symbol	Max	Unit
Thermal Resistance, Junction to Ambient	$R_{\theta JA}$	200	°C/W
Thermal Resistance, Junction to Case	$R_{\theta JC}$	83.3	°C/W

ELECTRICAL CHARACTERISTICS ($T_A = 25^\circ\text{C}$ unless otherwise noted)

Characteristic	Symbol	Min	Max	Unit
----------------	--------	-----	-----	------

OFF CHARACTERISTICS

Collector–Emitter Breakdown Voltage ⁽¹⁾ ($I_C = 1.0 \text{ mAdc}, I_B = 0$)	2N6515 2N6519 2N6517, 2N6520	$V_{(BR)CEO}$	250 300 350	— — —	Vdc
Collector–Base Breakdown Voltage ($I_C = 100 \mu\text{Adc}, I_E = 0$)	2N6515 2N6519 2N6517, 2N6520	$V_{(BR)CBO}$	250 300 350	— — —	Vdc
Emitter–Base Breakdown Voltage ($I_E = 10 \mu\text{Adc}, I_C = 0$)	2N6515, 2N6517 2N6519, 2N6520	$V_{(BR)EBO}$	6.0 5.0	— —	Vdc

1. Pulse Test: Pulse Width $\leq 300 \mu\text{s}$, Duty Cycle $\leq 2.0\%$.

NPN 2N6515 2N6517 PNP 2N6519 2N6520
ELECTRICAL CHARACTERISTICS ($T_A = 25^\circ\text{C}$ unless otherwise noted) (Continued)

Characteristic	Symbol	Min	Max	Unit
OFF CHARACTERISTICS (Continued)				
Collector Cutoff Current ($V_{CB} = 150\text{ Vdc}$, $I_E = 0$) ($V_{CB} = 200\text{ Vdc}$, $I_E = 0$) ($V_{CB} = 250\text{ Vdc}$, $I_E = 0$)	I_{CBO}	—	50	nAdc
			50	
			50	
Emitter Cutoff Current ($V_{EB} = 5.0\text{ Vdc}$, $I_C = 0$) ($V_{EB} = 4.0\text{ Vdc}$, $I_C = 0$)	I_{EBO}	—	50	nAdc
			50	

ON CHARACTERISTICS(1)

DC Current Gain ($I_C = 1.0\text{ mAdc}$, $V_{CE} = 10\text{ Vdc}$)	h_{FE}	35	—	—
		30	—	
		20	—	
($I_C = 10\text{ mAdc}$, $V_{CE} = 10\text{ Vdc}$)		50	—	
		45	—	
		30	—	
($I_C = 30\text{ mAdc}$, $V_{CE} = 10\text{ Vdc}$)		50	300	
		45	270	
		30	200	
($I_C = 50\text{ mAdc}$, $V_{CE} = 10\text{ Vdc}$)		45	220	
		40	200	
		20	200	
($I_C = 100\text{ mAdc}$, $V_{CE} = 10\text{ Vdc}$)		25	—	
		20	—	
		15	—	
Collector–Emitter Saturation Voltage ($I_C = 10\text{ mAdc}$, $I_B = 1.0\text{ mAdc}$) ($I_C = 20\text{ mAdc}$, $I_B = 2.0\text{ mAdc}$) ($I_C = 30\text{ mAdc}$, $I_B = 3.0\text{ mAdc}$) ($I_C = 50\text{ mAdc}$, $I_B = 5.0\text{ mAdc}$)	$V_{CE(sat)}$	—	0.30	Vdc
		—	0.35	
		—	0.50	
		—	1.0	
Base–Emitter Saturation Voltage ($I_C = 10\text{ mAdc}$, $I_B = 1.0\text{ mAdc}$) ($I_C = 20\text{ mAdc}$, $I_B = 2.0\text{ mAdc}$) ($I_C = 30\text{ mAdc}$, $I_B = 3.0\text{ mAdc}$)	$V_{BE(sat)}$	—	0.75	Vdc
		—	0.85	
		—	0.90	
Base–Emitter On Voltage ($I_C = 100\text{ mAdc}$, $V_{CE} = 10\text{ Vdc}$)	$V_{BE(on)}$	—	2.0	Vdc

SMALL–SIGNAL CHARACTERISTICS

Current–Gain — Bandwidth Product(1) ($I_C = 10\text{ mAdc}$, $V_{CE} = 20\text{ Vdc}$, $f = 20\text{ MHz}$)	f_T	40	200	MHz
Collector–Base Capacitance ($V_{CB} = 20\text{ Vdc}$, $I_E = 0$, $f = 1.0\text{ MHz}$)	C_{cb}	—	6.0	pF
Emitter–Base Capacitance ($V_{EB} = 0.5\text{ Vdc}$, $I_C = 0$, $f = 1.0\text{ MHz}$)	C_{eb}	—	80	pF
		—	100	

SWITCHING CHARACTERISTICS

Turn–On Time ($V_{CC} = 100\text{ Vdc}$, $V_{BE(off)} = 2.0\text{ Vdc}$, $I_C = 50\text{ mAdc}$, $I_{B1} = 10\text{ mAdc}$)	t_{on}	—	200	μs
Turn–Off Time ($V_{CC} = 100\text{ Vdc}$, $I_C = 50\text{ mAdc}$, $I_{B1} = I_{B2} = 10\text{ mAdc}$)	t_{off}	—	3.5	μs

 1. Pulse Test: Pulse Width $\leq 300\ \mu\text{s}$, Duty Cycle $\leq 2.0\%$.

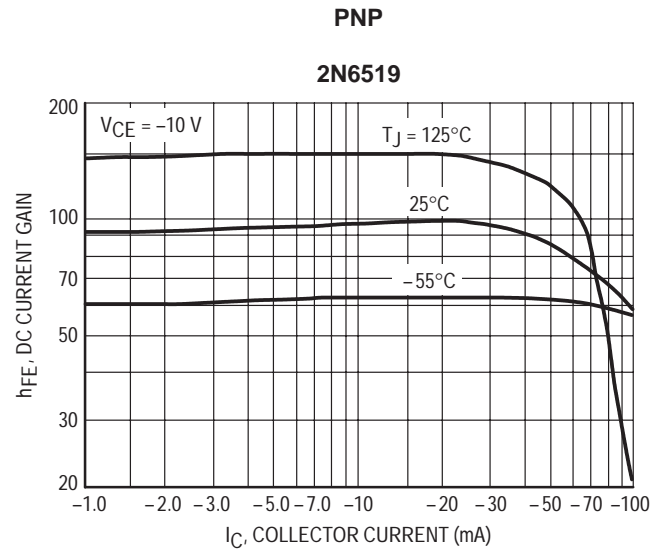
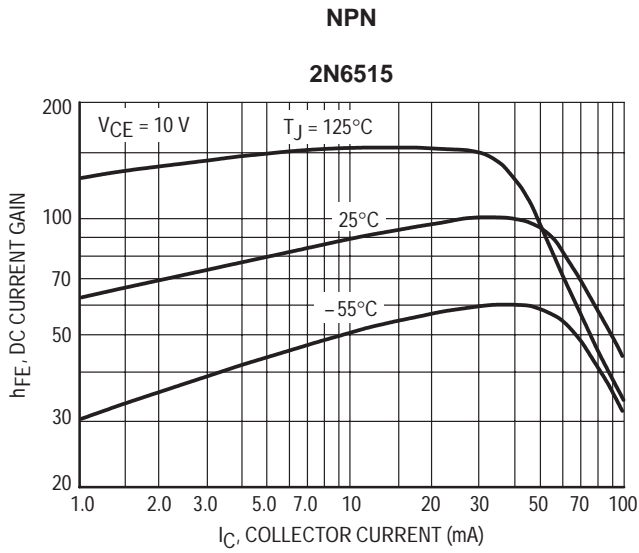


Figure 1. DC Current Gain

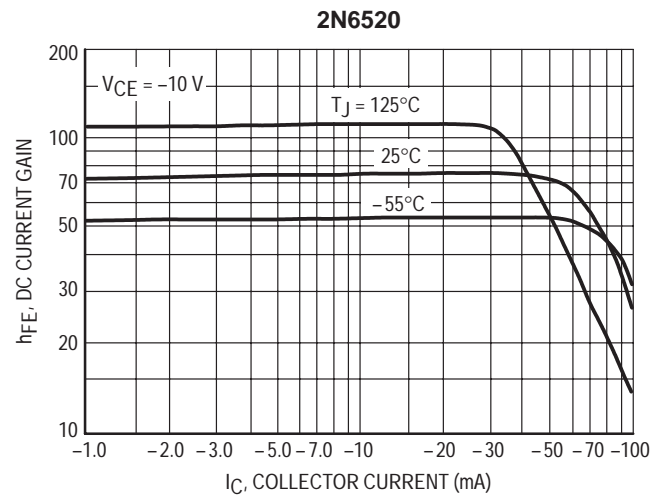
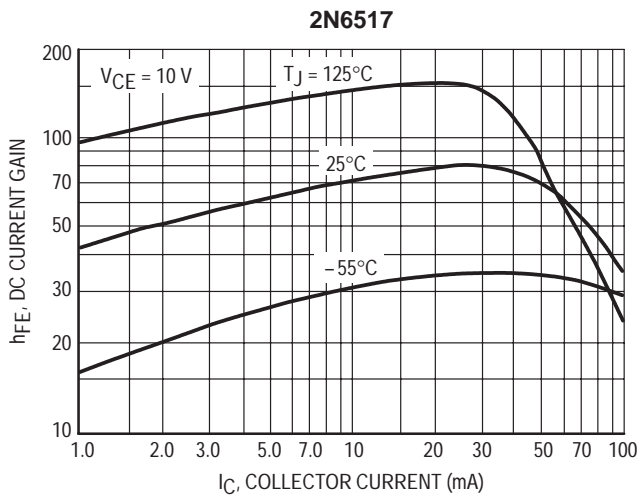


Figure 2. DC Current Gain

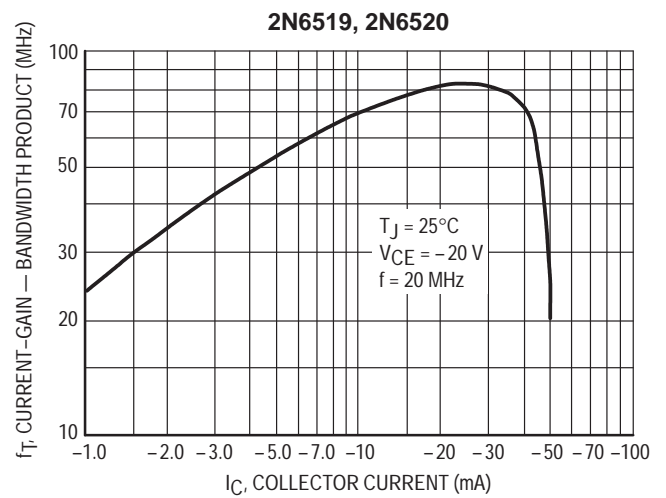
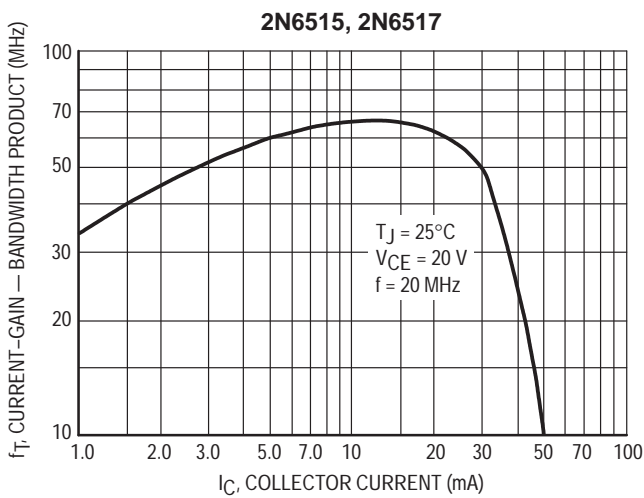


Figure 3. Current-Gain — Bandwidth Product

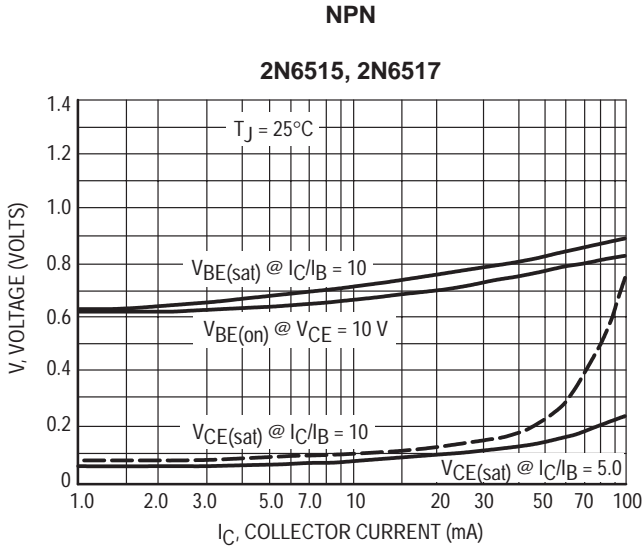


Figure 4. "On" Voltages

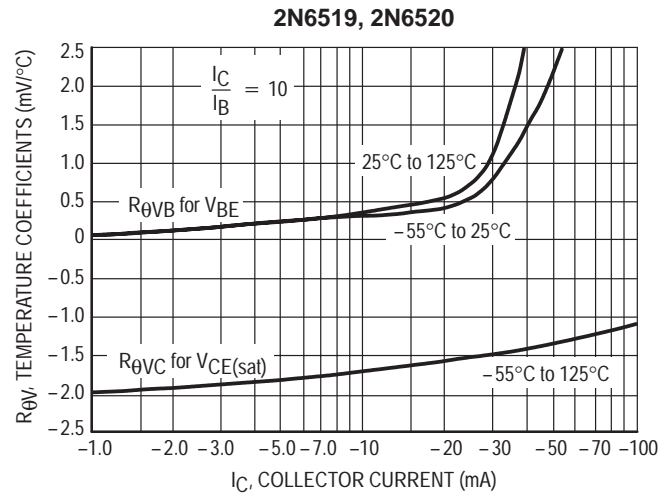
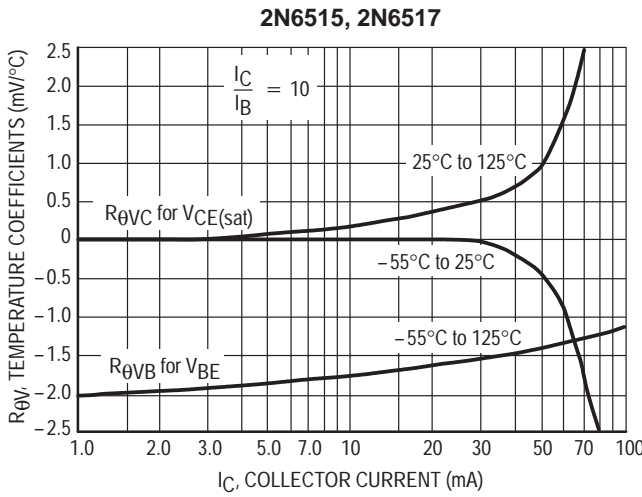


Figure 5. Temperature Coefficients

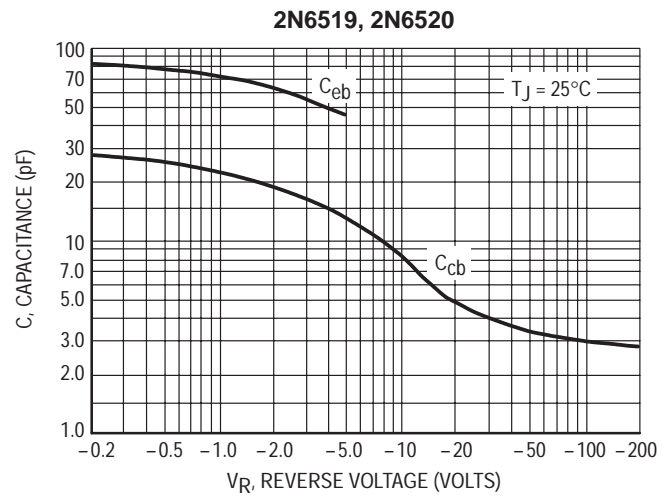
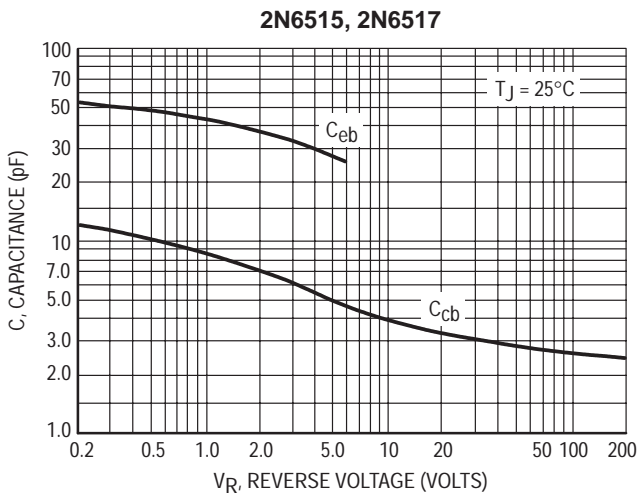


Figure 6. Capacitance

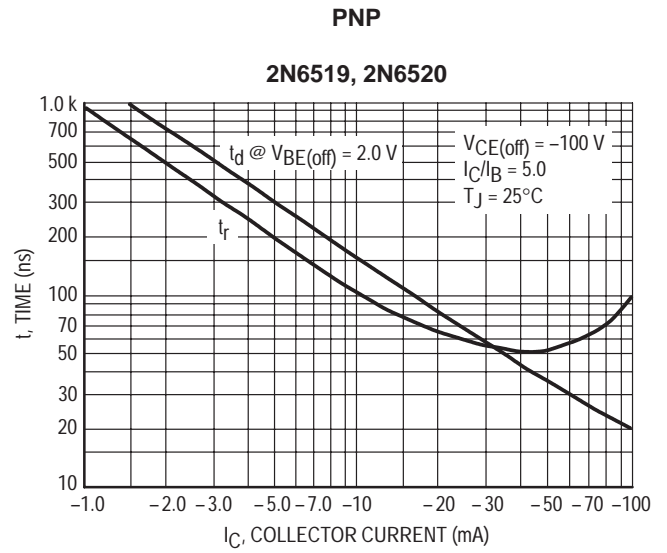
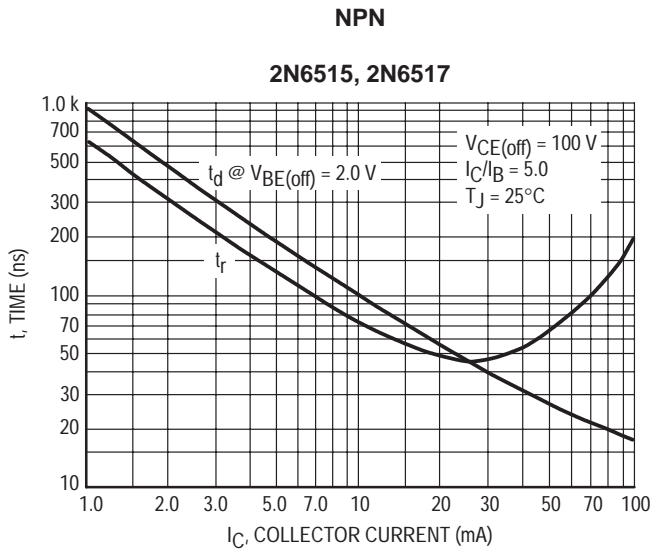


Figure 7. Turn-On Time

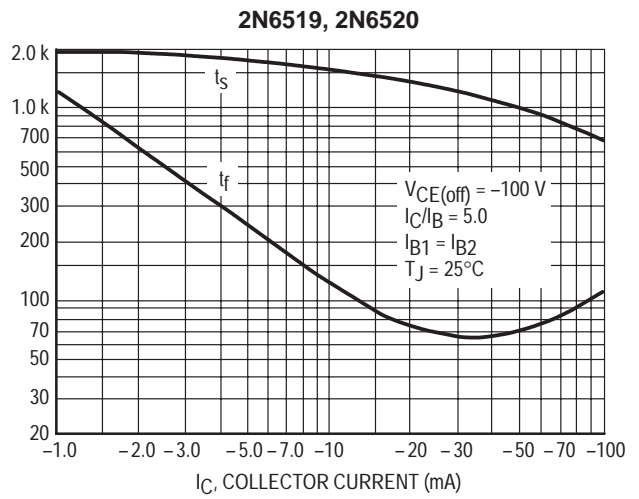
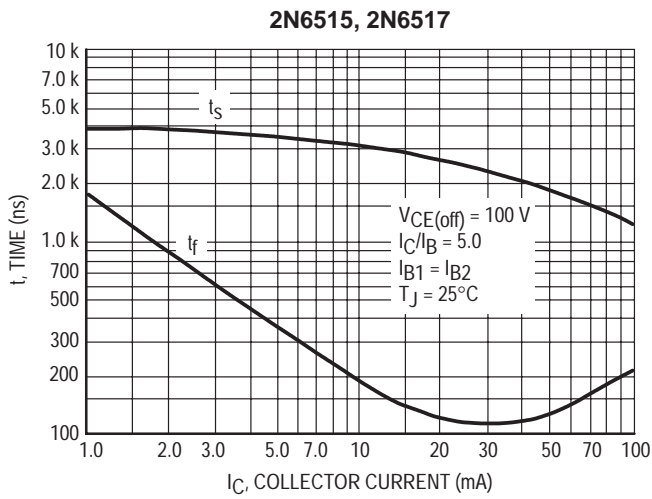


Figure 8. Turn-Off Time

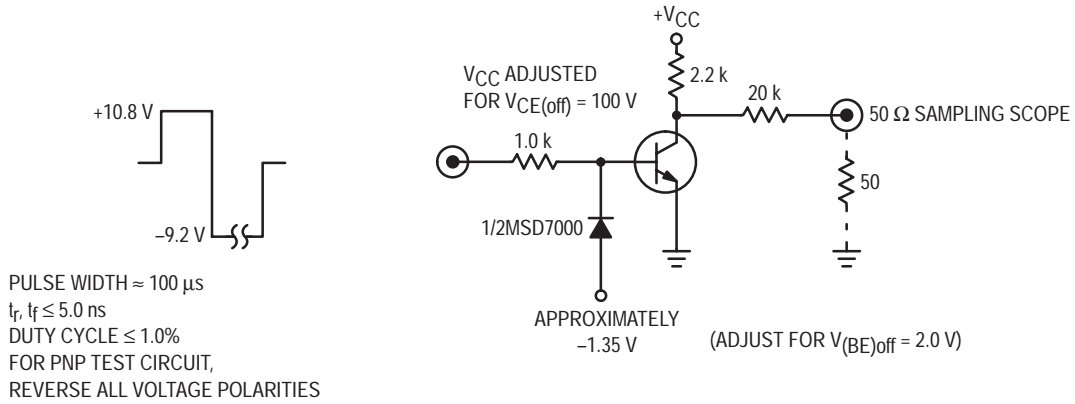


Figure 9. Switching Time Test Circuit

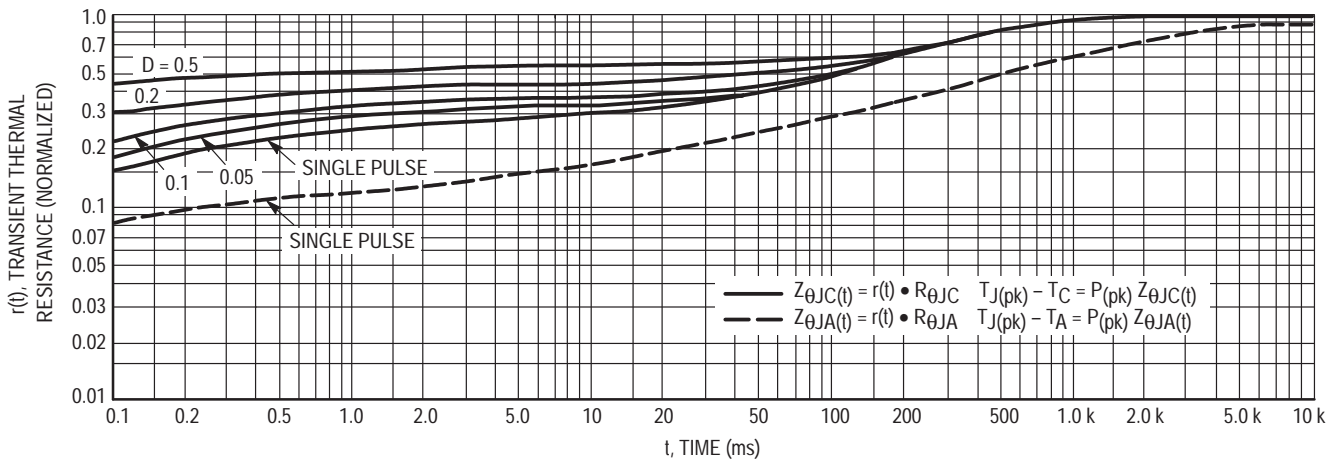


Figure 10. Thermal Response

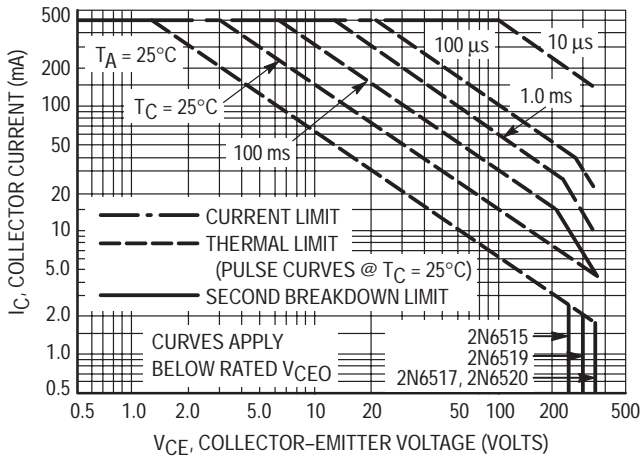
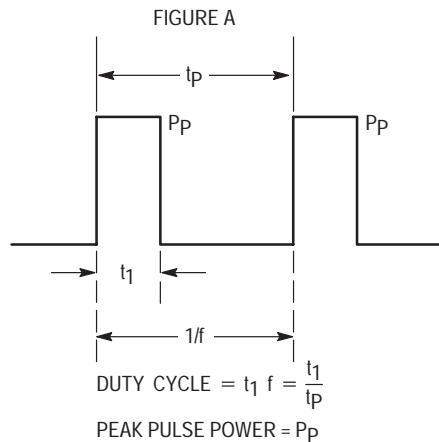


Figure 11. Active Region Safe Operating Area



Design Note: Use of Transient Thermal Resistance Data

PNP Silicon General Purpose Amplifier Transistor

This PNP transistor is designed for general purpose amplifier applications. This device is housed in the SOT-416/SC-90 package which is designed for low power surface mount applications, where board space is at a premium.

- Reduces Board Space
- High h_{FE} , 210–460 (typical)
- Low $V_{CE(sat)}$, < 0.5 V
- Available in 8 mm, 7-inch/3000 Unit Tape and Reel

MAXIMUM RATINGS ($T_A = 25^\circ\text{C}$)

Rating	Symbol	Value	Unit
Collector–Base Voltage	$V_{(BR)CBO}$	–60	Vdc
Collector–Emitter Voltage	$V_{(BR)CEO}$	–50	Vdc
Emitter–Base Voltage	$V_{(BR)EBO}$	–6.0	Vdc
Collector Current — Continuous	I_C	–100	mAdc

DEVICE MARKING

2SA1774 = F9

THERMAL CHARACTERISTICS

Rating	Symbol	Max	Unit
Power Dissipation ⁽¹⁾	P_D	150	mW
Junction Temperature	T_J	150	$^\circ\text{C}$
Storage Temperature Range	T_{stg}	–55 ~ +150	$^\circ\text{C}$

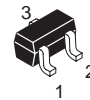
ELECTRICAL CHARACTERISTICS ($T_A = 25^\circ\text{C}$)

Characteristic	Symbol	Min	Typ	Max	Unit
Collector–Base Breakdown Voltage ($I_C = -50 \mu\text{Adc}$, $I_E = 0$)	$V_{(BR)CBO}$	–60	—	—	Vdc
Collector–Emitter Breakdown Voltage ($I_C = -1.0 \text{ mAdc}$, $I_B = 0$)	$V_{(BR)CEO}$	–50	—	—	Vdc
Emitter–Base Breakdown Voltage ($I_E = -50 \mu\text{Adc}$, $I_C = 0$)	$V_{(BR)EBO}$	–6.0	—	—	Vdc
Collector–Base Cutoff Current ($V_{CB} = -30 \text{ Vdc}$, $I_E = 0$)	I_{CBO}	—	—	–0.5	nA
Emitter–Base Cutoff Current ($V_{EB} = -5.0 \text{ Vdc}$, $I_B = 0$)	I_{EBO}	—	—	–0.5	μA
Collector–Emitter Saturation Voltage ⁽²⁾ ($I_C = -50 \text{ mAdc}$, $I_B = -5.0 \text{ mAdc}$)	$V_{CE(sat)}$	—	—	–0.5	Vdc
DC Current Gain ⁽²⁾ ($V_{CE} = -6.0 \text{ Vdc}$, $I_C = -1.0 \text{ mAdc}$)	h_{FE}	120	—	560	—
Transition Frequency ($V_{CE} = -12 \text{ Vdc}$, $I_C = -2.0 \text{ mAdc}$, $f = 30 \text{ MHz}$)	f_T	—	140	—	MHz
Output Capacitance ($V_{CB} = -12 \text{ Vdc}$, $I_E = 0 \text{ Adc}$, $f = 1 \text{ MHz}$)	C_{OB}	—	3.5	—	pF

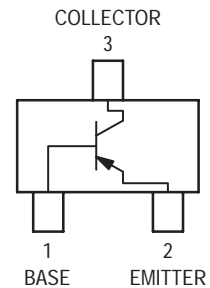
1. Device mounted on a FR-4 glass epoxy printed circuit board using the minimum recommended footprint.
2. Pulse Test: Pulse Width $\leq 300 \mu\text{s}$, D.C. $\leq 2\%$.

2SA1774

PNP GENERAL
PURPOSE AMPLIFIER
TRANSISTORS
SURFACE MOUNT



CASE 463–01, STYLE 1
SOT–416/SC–90



TYPICAL ELECTRICAL CHARACTERISTICS

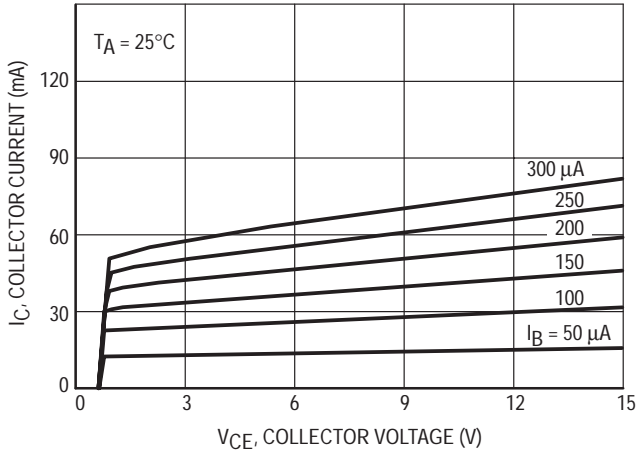


Figure 1. $I_C - V_{CE}$

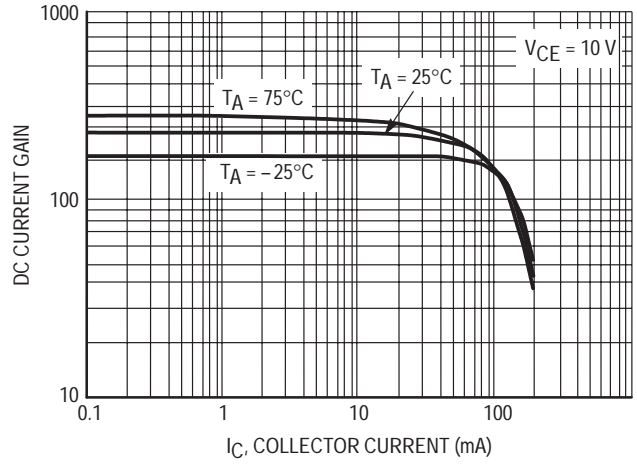


Figure 2. DC Current Gain

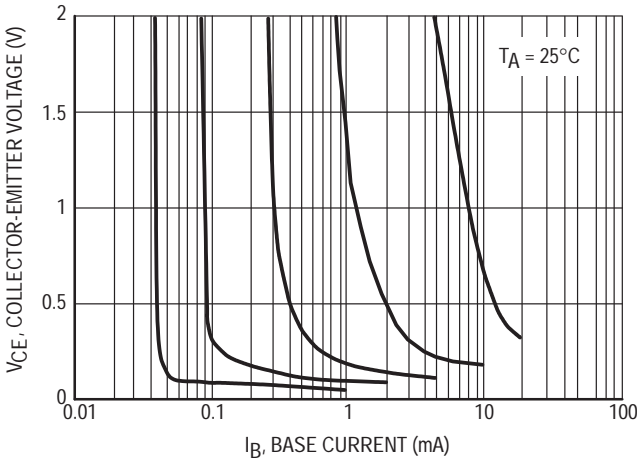


Figure 3. Collector Saturation Region

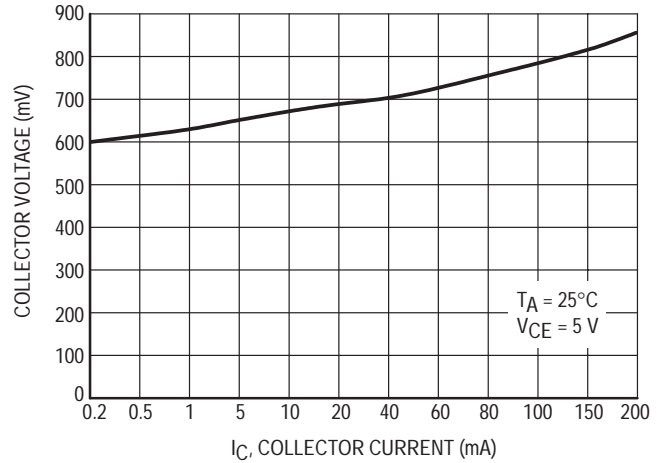


Figure 4. On Voltage

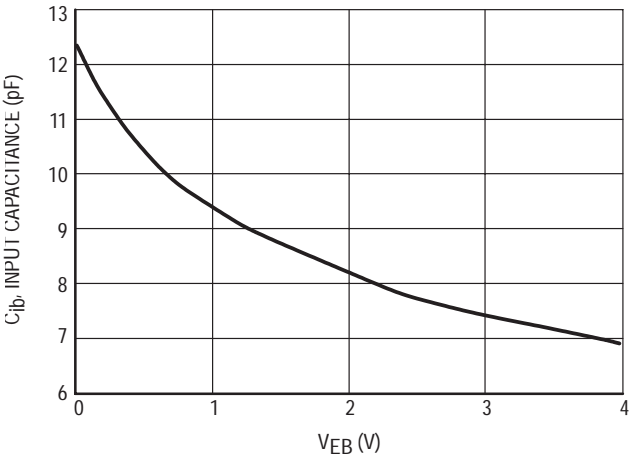


Figure 5. Capacitance

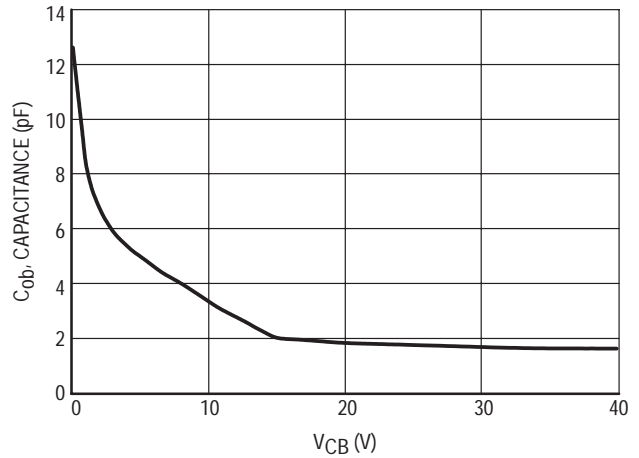


Figure 6. Capacitance

Preliminary Information
**NPN Silicon General Purpose
Amplifier Transistor**

This NPN transistor is designed for general purpose amplifier applications. This device is housed in the SOT-416/SC-90 package which is designed for low power surface mount applications, where board space is at a premium.

- Reduces Board Space
- High h_{FE} , 210–460 (typical)
- Low $V_{CE(sat)}$, < 0.5 V
- Available in 8 mm, 7-inch/3000 Unit Tape and Reel

MAXIMUM RATINGS ($T_A = 25^\circ\text{C}$)

Rating	Symbol	Value	Unit
Collector-Base Voltage	$V_{(BR)CBO}$	50	Vdc
Collector-Emitter Voltage	$V_{(BR)CEO}$	50	Vdc
Emitter-Base Voltage	$V_{(BR)EBO}$	5.0	Vdc
Collector Current — Continuous	I_C	100	mAdc

DEVICE MARKING

2SC4617 = B9

THERMAL CHARACTERISTICS

Rating	Symbol	Max	Unit
Power Dissipation ⁽¹⁾	P_D	125	mW
Junction Temperature	T_J	150	$^\circ\text{C}$
Storage Temperature Range	T_{stg}	-55 ~ +150	$^\circ\text{C}$

ELECTRICAL CHARACTERISTICS ($T_A = 25^\circ\text{C}$)

Characteristic	Symbol	Min	Typ	Max	Unit
Collector-Base Breakdown Voltage ($I_C = 50 \mu\text{Adc}$, $I_E = 0$)	$V_{(BR)CBO}$	50	—	—	Vdc
Collector-Emitter Breakdown Voltage ($I_C = 1.0 \text{ mAdc}$, $I_B = 0$)	$V_{(BR)CEO}$	50	—	—	Vdc
Emitter-Base Breakdown Voltage ($I_E = 50 \mu\text{Adc}$, $I_C = 0$)	$V_{(BR)EBO}$	5.0	—	—	Vdc
Collector-Base Cutoff Current ($V_{CB} = 30 \text{ Vdc}$, $I_E = 0$)	I_{CBO}	—	—	0.5	μA
Emitter-Base Cutoff Current ($V_{EB} = 4.0 \text{ Vdc}$, $I_B = 0$)	I_{EBO}	—	—	0.5	μA
Collector-Emitter Saturation Voltage ⁽²⁾ ($I_C = 60 \text{ mAdc}$, $I_B = 5.0 \text{ mAdc}$)	$V_{CE(sat)}$	—	—	0.4	Vdc
DC Current Gain ⁽²⁾ ($V_{CE} = 6.0 \text{ Vdc}$, $I_C = 1.0 \text{ mAdc}$)	h_{FE}	120	—	560	—
Transition Frequency ($V_{CE} = 12 \text{ Vdc}$, $I_C = 2.0 \text{ mAdc}$, $f = 30 \text{ MHz}$)	f_T	—	180	—	MHz
Output Capacitance ($V_{CB} = 12 \text{ Vdc}$, $I_C = 0 \text{ Adc}$, $f = 1 \text{ MHz}$)	C_{OB}	—	2.0	—	pF

1. Device mounted on a FR-4 glass epoxy printed circuit board using the minimum recommended footprint.
2. Pulse Test: Pulse Width $\leq 300 \mu\text{s}$, D.C. $\leq 2\%$.

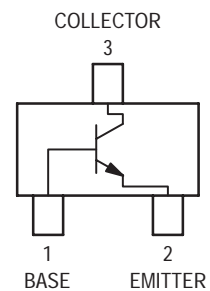
This document contains information on a product under development. Motorola reserves the right to change or discontinue this product without notice.

2SC4617

**NPN GENERAL
PURPOSE AMPLIFIER
TRANSISTORS
SURFACE MOUNT**



**CASE 463-01, STYLE 1
SOT-416/SC-90**



TYPICAL ELECTRICAL CHARACTERISTICS

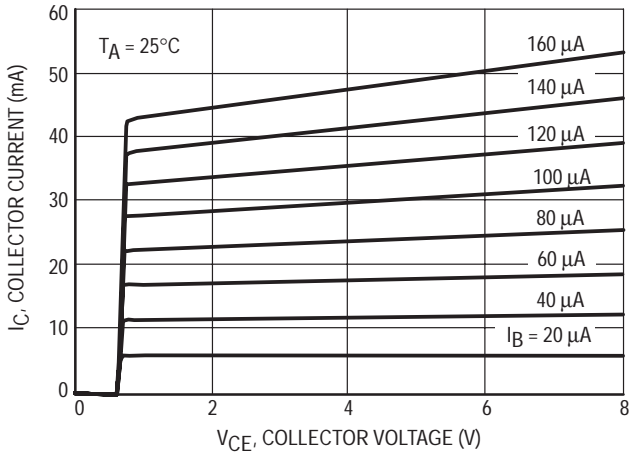


Figure 1. $I_C - V_{CE}$

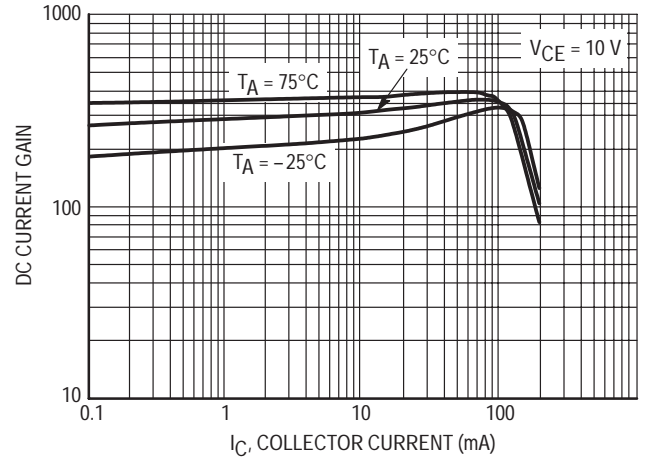


Figure 2. DC Current Gain

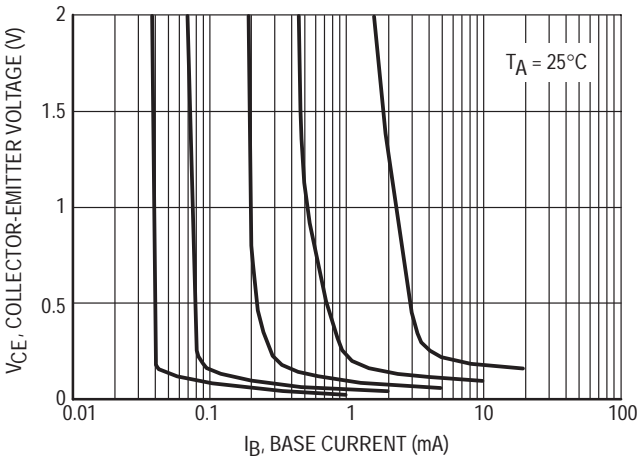


Figure 3. Collector Saturation Region

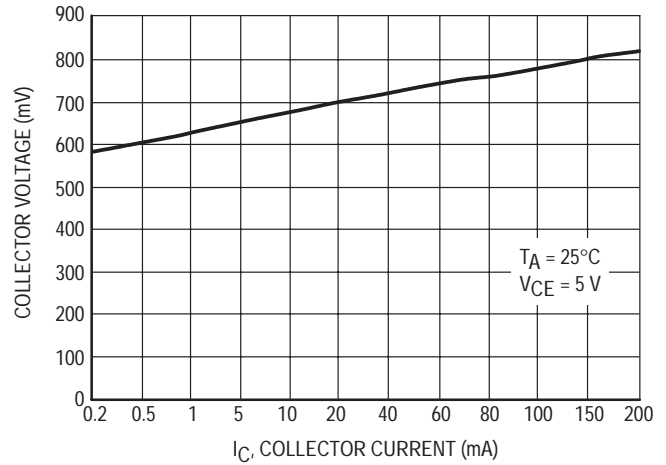


Figure 4. On Voltage

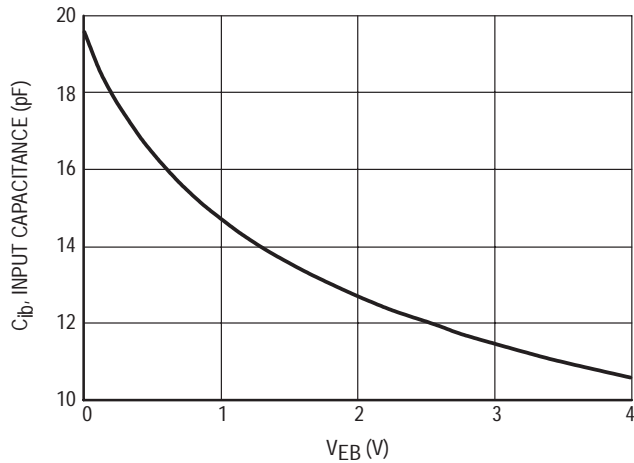


Figure 5. Capacitance

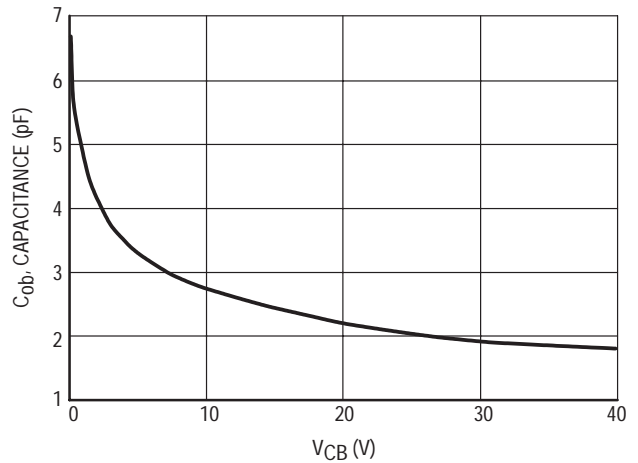
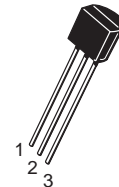
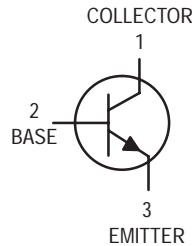


Figure 6. Capacitance

Amplifier Transistors

NPN Silicon

BC182,A,B
BC183
BC184



CASE 29-04, STYLE 17
TO-92 (TO-226AA)

MAXIMUM RATINGS

Rating	Symbol	BC182	BC183	BC184	Unit
Collector–Emitter Voltage	V_{CEO}	50	30	30	Vdc
Collector–Base Voltage	V_{CBO}	60	45	45	Vdc
Emitter–Base Voltage	V_{EBO}	6.0			Vdc
Collector Current — Continuous	I_C	100			mAdc
Total Device Dissipation @ $T_A = 25^\circ\text{C}$ Derate above 25°C	P_D	350 2.8			mW mW/°C
Total Device Dissipation @ $T_C = 25^\circ\text{C}$ Derate above 25°C	P_D	1.0 8.0			Watts mW/°C
Operating and Storage Junction Temperature Range	T_J, T_{stg}	–55 to +150			°C

THERMAL CHARACTERISTICS

Characteristic	Symbol	Max	Unit
Thermal Resistance, Junction to Ambient	$R_{\theta JA}$	357	°C/W
Thermal Resistance, Junction to Case	$R_{\theta JC}$	125	°C/W

ELECTRICAL CHARACTERISTICS ($T_A = 25^\circ\text{C}$ unless otherwise noted)

Characteristic	Symbol	Min	Typ	Max	Unit
----------------	--------	-----	-----	-----	------

OFF CHARACTERISTICS

Collector–Emitter Breakdown Voltage ($I_C = 2.0\text{ mA}, I_B = 0$)	BC182 BC183 BC184	$V_{(BR)CEO}$	50 30 30	— — —	— — —	V
Collector–Base Breakdown Voltage ($I_C = 10\text{ }\mu\text{A}, I_E = 0$)	BC182 BC183 BC184	$V_{(BR)CBO}$	60 45 45	— — —	— — —	V
Emitter–Base Breakdown Voltage ($I_E = 100\text{ }\mu\text{A}, I_C = 0$)		$V_{(BR)EBO}$	6.0	—	—	V
Collector Cutoff Current ($V_{CB} = 50\text{ V}, V_{BE} = 0$) ($V_{CB} = 30\text{ V}, V_{BE} = 0$)	BC182 BC183 BC184	I_{CBO}	— — —	0.2 0.2 0.2	15 15 15	nA
Emitter–Base Leakage Current ($V_{EB} = 4.0\text{ V}, I_C = 0$)		I_{EBO}	—	—	15	nA

BC182,A,B BC183 BC184
ELECTRICAL CHARACTERISTICS ($T_A = 25^\circ\text{C}$ unless otherwise noted) (Continued)

Characteristic	Symbol	Min	Typ	Max	Unit
ON CHARACTERISTICS					
DC Current Gain ($I_C = 10\ \mu\text{A}$, $V_{CE} = 5.0\ \text{V}$) ($I_C = 2.0\ \text{mA}$, $V_{CE} = 5.0\ \text{V}$) ($I_C = 100\ \text{mA}$, $V_{CE} = 5.0\ \text{V}$)	BC182	40	—	—	—
	BC183	40	—	—	—
	BC184	100	—	—	—
	BC182	120	—	500	—
	BC183	120	—	800	—
	BC184	250	—	800	—
	BC182	80	—	—	—
	BC183	80	—	—	—
	BC184	130	—	—	—
Collector–Emitter On Voltage ($I_C = 10\ \text{mA}$, $I_B = 0.5\ \text{mA}$) ($I_C = 100\ \text{mA}$, $I_B = 5.0\ \text{mA}$) ⁽¹⁾	$V_{CE(\text{sat})}$	—	0.07 0.2	0.25 0.6	V
Base–Emitter Saturation Voltage ($I_C = 100\ \text{mA}$, $I_B = 5.0\ \text{mA}$) ⁽¹⁾	$V_{BE(\text{sat})}$	—	—	1.2	V
Base–Emitter On Voltage ($I_C = 100\ \mu\text{A}$, $V_{CE} = 5.0\ \text{V}$) ($I_C = 2.0\ \text{mA}$, $V_{CE} = 5.0\ \text{V}$) ($I_C = 100\ \text{mA}$, $V_{CE} = 5.0\ \text{V}$) ⁽¹⁾	$V_{BE(\text{on})}$	—	0.5	—	V
		0.55	0.62	0.7	
		—	0.83	—	
DYNAMIC CHARACTERISTICS					
Current–Gain — Bandwidth Product ($I_C = 0.5\ \text{mA}$, $V_{CE} = 3.0\ \text{V}$, $f = 100\ \text{MHz}$) ($I_C = 10\ \text{mA}$, $V_{CE} = 5.0\ \text{V}$, $f = 100\ \text{MHz}$)	BC182	—	100	—	MHz
	BC183	—	120	—	
	BC184	—	140	—	
	BC182	150	200	—	
	BC183	150	240	—	
	BC184	150	280	—	
Common Base Output Capacitance ($V_{CB} = 10\ \text{V}$, $I_C = 0$, $f = 1.0\ \text{MHz}$)	C_{ob}	—	—	5.0	pF
Common Base Input Capacitance ($V_{EB} = 0.5\ \text{V}$, $I_C = 0$, $f = 1.0\ \text{MHz}$)	C_{ib}	—	8.0	—	pF
Small–Signal Current Gain ($I_C = 2.0\ \text{mA}$, $V_{CE} = 5.0\ \text{V}$, $f = 1.0\ \text{kHz}$)	BC182	125	—	500	—
	BC183	125	—	900	
	BC184	240	—	900	
	BC182A	125	—	260	
	BC182B	240	—	500	
Noise Figure ($I_C = 0.2\ \text{mA}$, $V_{CE} = 5.0\ \text{V}$, $R_S = 2.0\ \text{k}\Omega$, $f = 1.0\ \text{kHz}$) ($I_C = 0.2\ \text{mA}$, $V_{CE} = 5.0\ \text{V}$, $R_S = 2.0\ \text{k}\Omega$, $f = 1.0\ \text{kHz}$, $f = 200\ \text{Hz}$)	BC184	—	2.0	4.0	dB
	BC182	—	2.0	10	
	BC183	—	2.0	10	
	BC184	—	2.0	4.0	

 1. Pulse Test: T_p 300 s, Duty Cycle 2.0%.

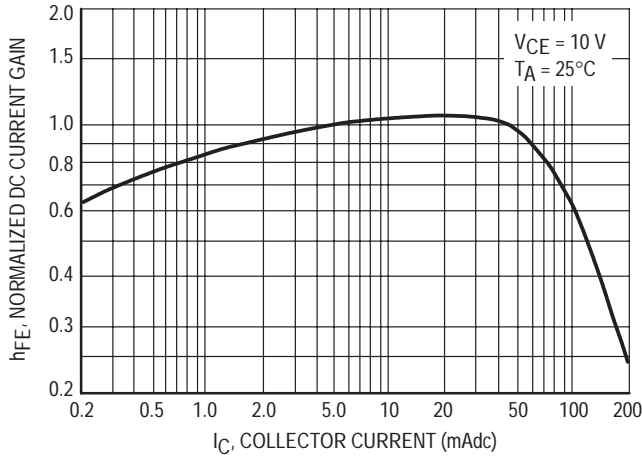


Figure 1. Normalized DC Current Gain

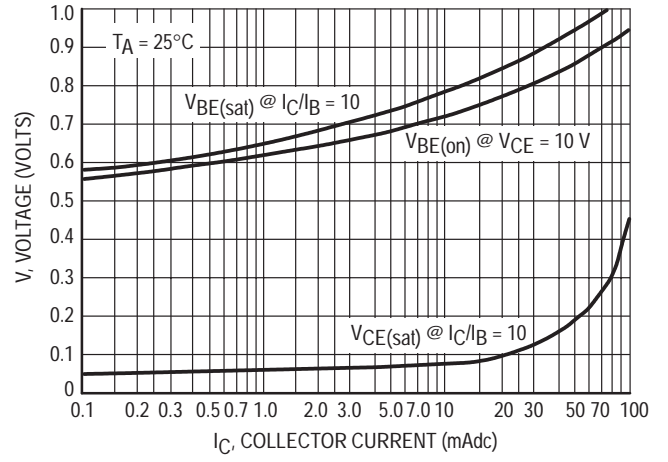


Figure 2. "Saturation" and "On" Voltages

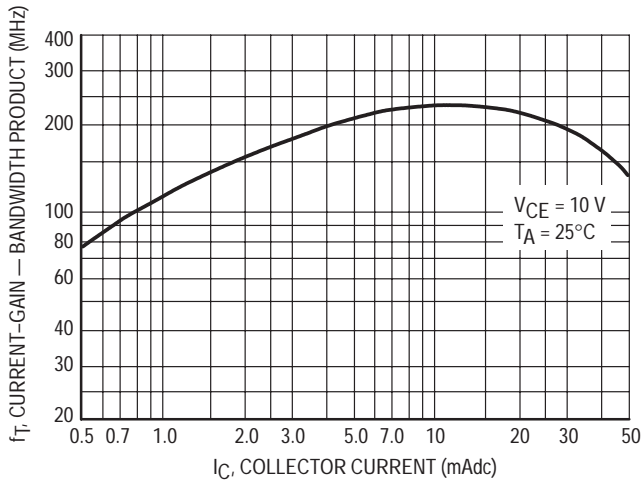


Figure 3. Current-Gain — Bandwidth Product

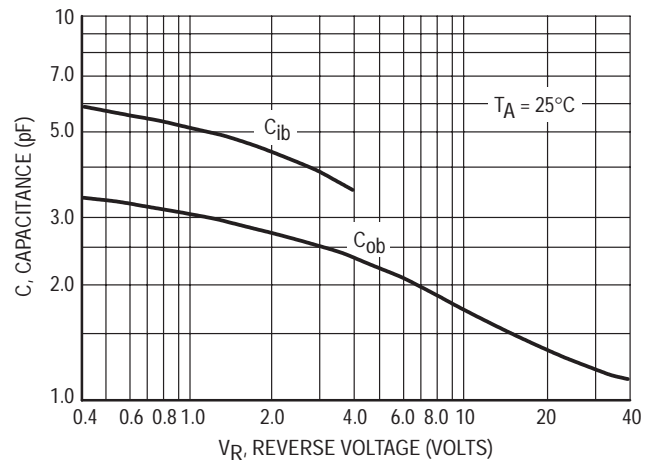


Figure 4. Capacitances

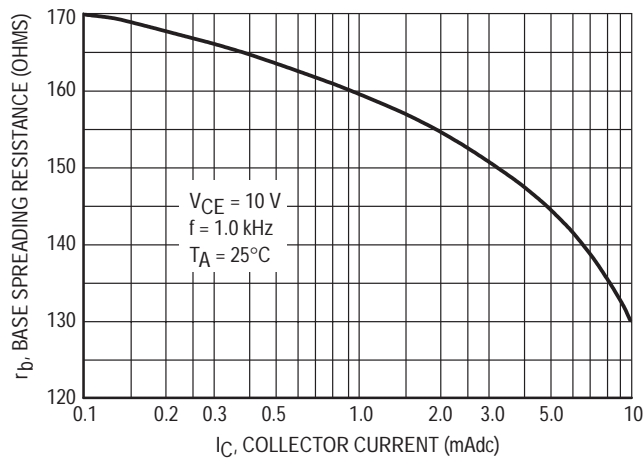
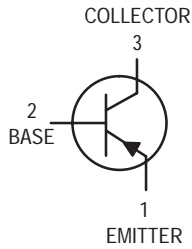


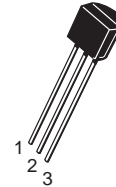
Figure 5. Base Spreading Resistance

Amplifier Transistors

PNP Silicon



BC212,B
BC213
BC214



CASE 29-04, STYLE 17
TO-92 (TO-226AA)

MAXIMUM RATINGS

Rating	Symbol	BC212	BC213	BC214	Unit
Collector–Emitter Voltage	V_{CEO}	-50	-30	-30	Vdc
Collector–Base Voltage	V_{CBO}	-60	-45	-45	Vdc
Emitter–Base Voltage	V_{EBO}	-5.0			Vdc
Collector Current — Continuous	I_C	-100			mAdc
Total Device Dissipation @ $T_A = 25^\circ\text{C}$ Derate above 25°C	P_D	350 2.8			mW mW/ $^\circ\text{C}$
Total Device Dissipation @ $T_C = 25^\circ\text{C}$ Derate above 25°C	P_D	1.0 8.0			Watts mW/ $^\circ\text{C}$
Operating and Storage Junction Temperature Range	T_J, T_{stg}	-55 to +150			$^\circ\text{C}$

THERMAL CHARACTERISTICS

Characteristic	Symbol	Max	Unit
Thermal Resistance, Junction to Ambient	$R_{\theta JA}$	357	$^\circ\text{C}/\text{W}$
Thermal Resistance, Junction to Case	$R_{\theta JC}$	125	$^\circ\text{C}/\text{W}$

ELECTRICAL CHARACTERISTICS ($T_A = 25^\circ\text{C}$ unless otherwise noted)

Characteristic	Symbol	Min	Typ	Max	Unit
Collector–Emitter Breakdown Voltage ($I_C = -2.0 \text{ mAdc}, I_B = 0$)	$V_{(BR)CEO}$	-50 -30 -30	— — —	— — —	Vdc
Collector–Base Breakdown Voltage ($I_C = -10 \mu\text{A}, I_E = 0$)	$V_{(BR)CBO}$	-60 -45 -45	— — —	— — —	Vdc
Emitter–Base Breakdown Voltage ($I_E = -10 \mu\text{A}, I_C = 0$)	$V_{(BR)EBO}$	-5 -5 -5	— — —	— — —	Vdc
Collector–Emitter Leakage Current ($V_{CB} = -30 \text{ V}$)	I_{CBO}	— — —	— — —	-15 -15 -15	nAdc
Emitter–Base Leakage Current ($V_{EB} = -4.0 \text{ V}, I_C = 0$)	I_{EBO}	— — —	— — —	-15 -15 -15	nAdc

ELECTRICAL CHARACTERISTICS ($T_A = 25^\circ\text{C}$ unless otherwise noted) (Continued)

Characteristic		Symbol	Min	Typ	Max	Unit
ON CHARACTERISTICS						
DC Current Gain ($I_C = -10 \mu\text{A}$, $V_{CE} = -5.0 \text{ Vdc}$)	BC212	h_{FE}	40	—	—	—
	BC213		40	—	—	—
	BC214		100	—	—	—
($I_C = -2.0 \text{ mA}$, $V_{CE} = -5.0 \text{ Vdc}$)	BC212		60	—	—	—
	BC213		80	—	—	—
	BC214		140	—	600	—
($I_C = -100 \text{ mA}$, $V_{CE} = -5.0 \text{ Vdc}$) ⁽¹⁾	BC212, BC214		—	120	—	—
	BC213		—	140	—	—
Collector–Emitter Saturation Voltage ($I_C = -10 \text{ mA}$, $I_B = -0.5 \text{ mA}$) ($I_C = -100 \text{ mA}$, $I_B = -5.0 \text{ mA}$) ⁽¹⁾		$V_{CE(\text{sat})}$	—	-0.10 -0.25	— -0.6	Vdc
Base–Emitter Saturation Voltage ($I_C = -100 \text{ mA}$, $I_B = -5.0 \text{ mA}$)		$V_{BE(\text{sat})}$	—	-1.0	-1.4	Vdc
Base–Emitter On Voltage ($I_C = -2.0 \text{ mA}$, $V_{CE} = -5.0 \text{ Vdc}$)		$V_{BE(\text{on})}$	-0.6	-0.62	-0.72	Vdc

DYNAMIC CHARACTERISTICS

Current–Gain — Bandwidth Product ($I_C = -10 \text{ mA}$, $V_{CE} = -5.0 \text{ Vdc}$, $f = 100 \text{ MHz}$)	BC212 BC214 BC213	f_T	— — —	280 320 360	— — —	MHz
Common–Base Output Capacitance ($V_{CB} = -10 \text{ Vdc}$, $I_C = 0$, $f = 1.0 \text{ MHz}$)		C_{ob}	—	—	6.0	pF
Noise Figure ($I_C = -0.2 \text{ mA}$, $V_{CE} = -5.0 \text{ Vdc}$, $R_S = 2.0 \text{ k}\Omega$, $f = 1.0 \text{ kHz}$)	BC214	NF	—	—	2	dB
	BC212, BC213		—	—	10	
Small–Signal Current Gain ($I_C = -2.0 \text{ mA}$, $V_{CE} = -5.0 \text{ Vdc}$, $f = 1.0 \text{ kHz}$)	BC212 BC213 BC214 BC212B	h_{fe}	60 80 140 200	— — — —	— — — 400	—

 1. Pulse Test: $T_p = 300 \text{ s}$, Duty Cycle 2.0%.

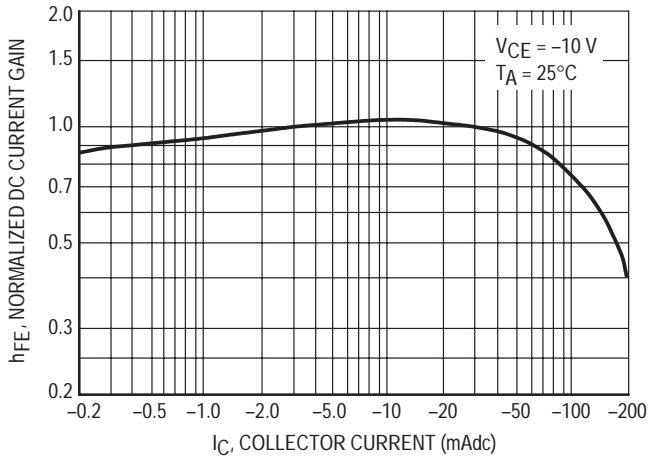


Figure 1. Normalized DC Current Gain

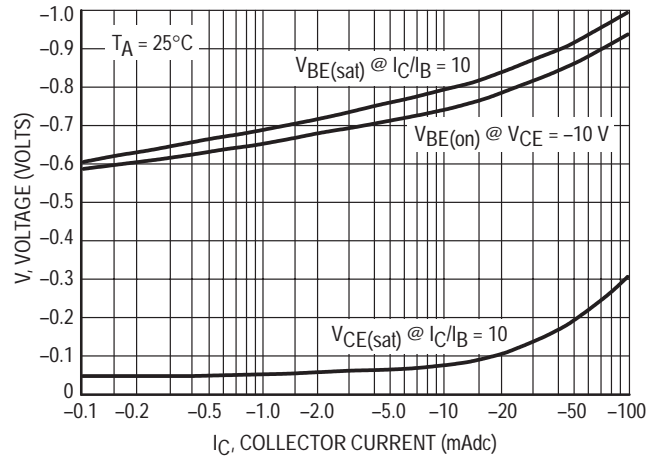


Figure 2. "Saturation" and "On" Voltages

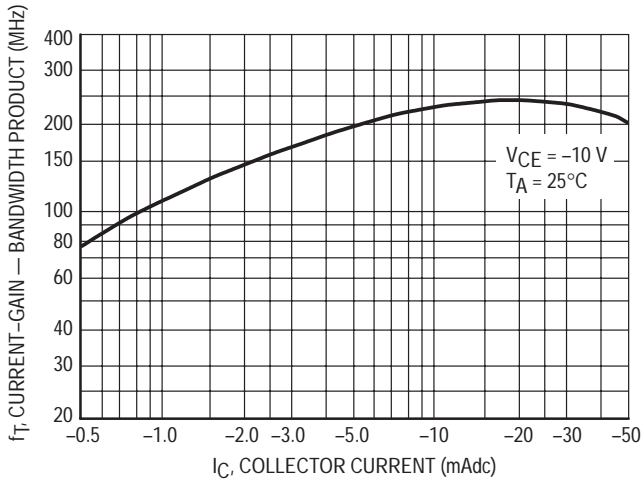


Figure 3. Current-Gain — Bandwidth Product

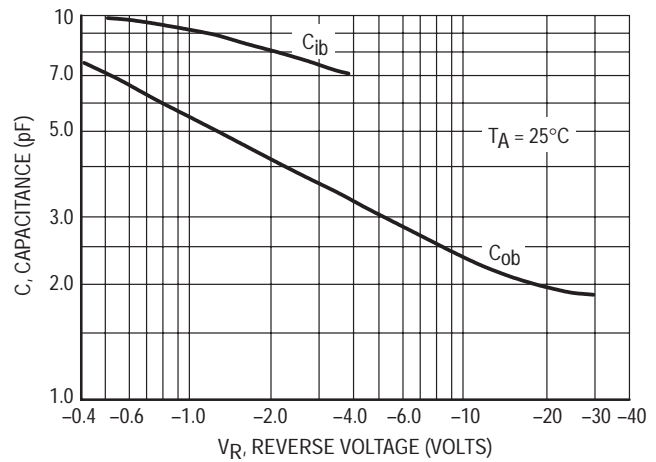


Figure 4. Capacitances

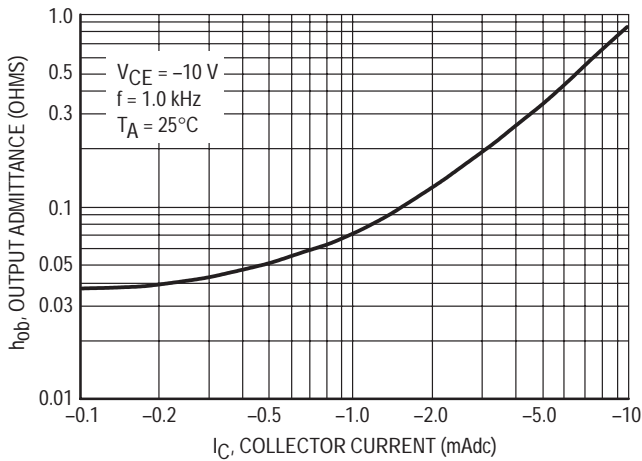


Figure 5. Output Admittance

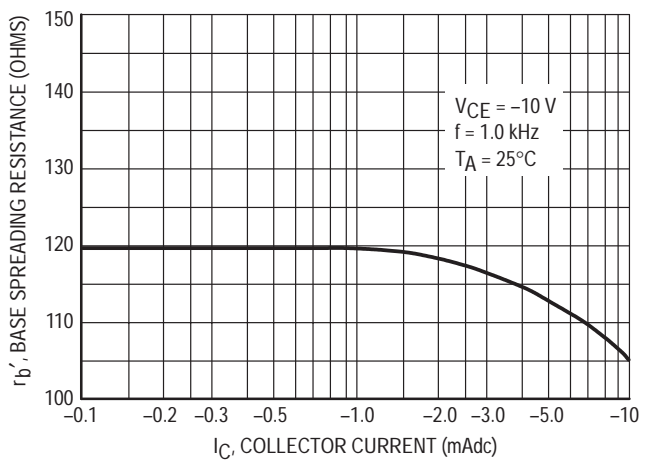
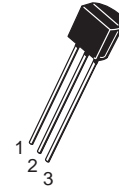
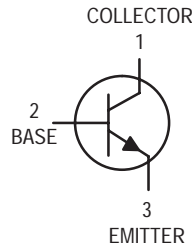


Figure 6. Base Spreading Resistance

Amplifier Transistors

NPN Silicon

BC237,A,B,C
BC238B,C
BC239,C



CASE 29-04, STYLE 17
TO-92 (TO-226AA)

MAXIMUM RATINGS

Rating	Symbol	BC237	BC238	BC239	Unit
Collector–Emitter Voltage	V_{CEO}	45	25	25	Vdc
Collector–Emitter Voltage	V_{CES}	50	30	30	Vdc
Emitter–Base Voltage	V_{EBO}	6.0	5.0	5.0	Vdc
Collector Current — Continuous	I_C	100			mAdc
Total Device Dissipation @ $T_A = 25^\circ\text{C}$ Derate above 25°C	P_D	350 2.8			mW mW/°C
Total Device Dissipation @ $T_C = 25^\circ\text{C}$ Derate above 25°C	P_D	1.0 8.0			Watts mW/°C
Operating and Storage Junction Temperature Range	T_J, T_{stg}	–55 to +150			°C

THERMAL CHARACTERISTICS

Characteristic	Symbol	Max	Unit
Thermal Resistance, Junction to Ambient	$R_{\theta JA}$	357	°C/W
Thermal Resistance, Junction to Case	$R_{\theta JC}$	125	°C/W

ELECTRICAL CHARACTERISTICS ($T_A = 25^\circ\text{C}$ unless otherwise noted)

Characteristic	Symbol	Min	Typ	Max	Unit
----------------	--------	-----	-----	-----	------

OFF CHARACTERISTICS

Collector–Emitter Breakdown Voltage ($I_C = 2.0\text{ mA}, I_B = 0$)	BC237 BC238 BC239	$V_{(BR)CEO}$	45 25 25	— — —	— — —	V
Emitter–Base Breakdown Voltage ($I_E = 100\ \mu\text{A}, I_C = 0$)	BC237 BC238 BC239	$V_{(BR)EBO}$	6.0 5.0 5.0	— — —	— — —	V
Collector Cutoff Current ($V_{CE} = 30\text{ V}, V_{BE} = 0$)	BC238 BC239	I_{CES}	— —	0.2 0.2	15 15	nA
($V_{CE} = 50\text{ V}, V_{BE} = 0$)	BC237		—	0.2	15	
($V_{CE} = 30\text{ V}, V_{BE} = 0$) $T_A = 125^\circ\text{C}$	BC238 BC239		— —	0.2 0.2	4.0 4.0	μA
($V_{CE} = 50\text{ V}, V_{BE} = 0$) $T_A = 125^\circ\text{C}$	BC237	—	0.2	4.0		

BC237,A,B,C BC238B,C BC239,C
ELECTRICAL CHARACTERISTICS ($T_A = 25^\circ\text{C}$ unless otherwise noted) (Continued)

Characteristic	Symbol	Min	Typ	Max	Unit
ON CHARACTERISTICS					
DC Current Gain ($I_C = 10\ \mu\text{A}$, $V_{CE} = 5.0\ \text{V}$)	BC237A BC237B/238B BC237C/238C/239C	h_{FE}	— 90 150 270	— — —	—
($I_C = 2.0\ \text{mA}$, $V_{CE} = 5.0\ \text{V}$)	BC237 BC239 BC237A BC237B/238B BC237C/238C/239C		120 120 120 200 380	— — 170 290 500	800 800 220 460 800
($I_C = 100\ \text{mA}$, $V_{CE} = 5.0\ \text{V}$)	BC237A BC237B/238B BC237C/238C/239C		— — —	120 180 300	— — —
Collector–Emitter On Voltage ($I_C = 10\ \text{mA}$, $I_B = 0.5\ \text{mA}$) ($I_C = 100\ \text{mA}$, $I_B = 5.0\ \text{mA}$)	BC237/BC238/BC239 BC237/BC239 BC238	$V_{CE(sat)}$	— —	0.07 0.2	0.2 0.6 0.8
Base–Emitter Saturation Voltage ($I_C = 10\ \text{mA}$, $I_B = 0.5\ \text{mA}$) ($I_C = 100\ \text{mA}$, $I_B = 5.0\ \text{mA}$)		$V_{BE(sat)}$	— —	0.6 —	0.83 1.05
Base–Emitter On Voltage ($I_C = 100\ \mu\text{A}$, $V_{CE} = 5.0\ \text{V}$) ($I_C = 2.0\ \text{mA}$, $V_{CE} = 5.0\ \text{V}$) ($I_C = 100\ \text{mA}$, $V_{CE} = 5.0\ \text{V}$)		$V_{BE(on)}$	— 0.55 —	0.5 0.62 0.83	— 0.7 —
DYNAMIC CHARACTERISTICS					
Current–Gain — Bandwidth Product ($I_C = 0.5\ \text{mA}$, $V_{CE} = 3.0\ \text{V}$, $f = 100\ \text{MHz}$)	BC237 BC238 BC239	f_T	— — —	100 120 140	— — —
($I_C = 10\ \text{mA}$, $V_{CE} = 5.0\ \text{V}$, $f = 100\ \text{MHz}$)	BC237 BC238 BC239		150 150 150	200 240 280	— — —
Collector–Base Capacitance ($V_{CB} = 10\ \text{V}$, $I_C = 0$, $f = 1.0\ \text{MHz}$)		C_{obo}	—	—	4.5
Emitter–Base Capacitance ($V_{EB} = 0.5\ \text{V}$, $I_C = 0$, $f = 1.0\ \text{MHz}$)		C_{ibo}	—	8.0	—
Noise Figure ($I_C = 0.2\ \text{mA}$, $V_{CE} = 5.0\ \text{V}$, $R_S = 2.0\ \text{k}\Omega$, $f = 1.0\ \text{kHz}$)	BC239	NF	—	2.0	4.0
($I_C = 0.2\ \text{mA}$, $V_{CE} = 5.0\ \text{V}$, $R_S = 2.0\ \text{k}\Omega$, $f = 1.0\ \text{kHz}$, $\Delta f = 200\ \text{Hz}$)	BC237 BC238 BC239		— — —	2.0 2.0 2.0	10 10 4.0

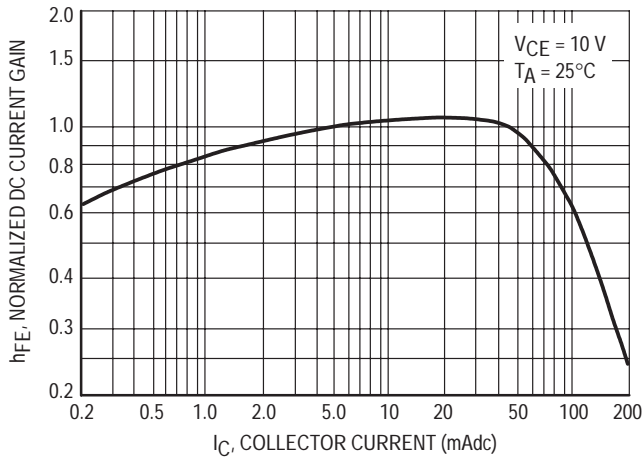


Figure 1. Normalized DC Current Gain

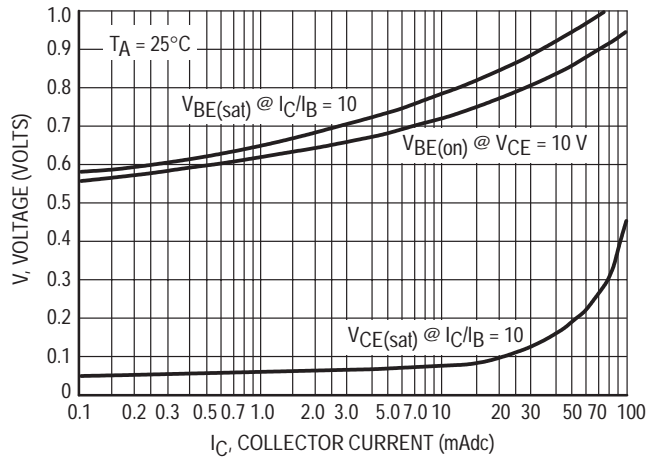


Figure 2. "Saturation" and "On" Voltages

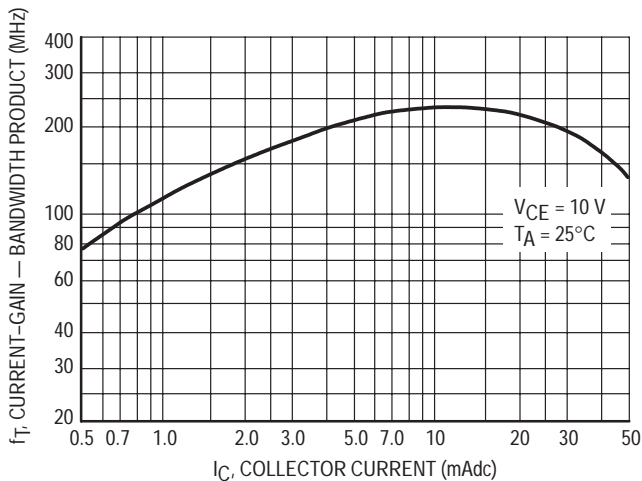


Figure 3. Current-Gain — Bandwidth Product

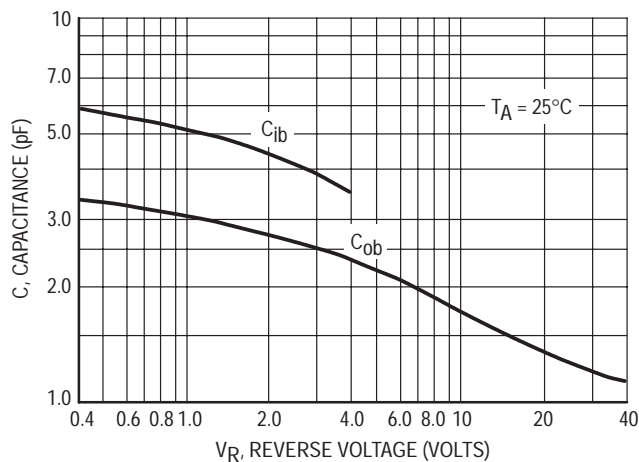


Figure 4. Capacitances

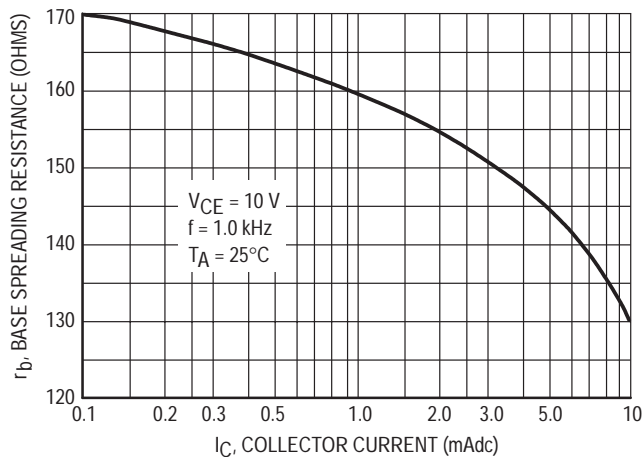
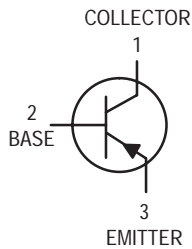


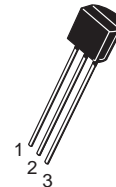
Figure 5. Base Spreading Resistance

Amplifier Transistors

PNP Silicon



BC307
BC307B
BC307C
BC308C



CASE 29-04, STYLE 17
TO-92 (TO-226AA)

MAXIMUM RATINGS

Rating	Symbol	BC307, B, C	BC308C	Unit
Collector–Emitter Voltage	V_{CEO}	-45	-25	Vdc
Collector–Base Voltage	V_{CBO}	-50	-30	Vdc
Emitter–Base Voltage	V_{EBO}	-5.0		Vdc
Collector Current — Continuous	I_C	-100		mAdc
Total Device Dissipation @ $T_A = 25^\circ\text{C}$ Derate above 25°C	P_D	350	2.8	mW mW/ $^\circ\text{C}$
Total Device Dissipation @ $T_C = 25^\circ\text{C}$ Derate above 25°C	P_D	1.0	8.0	Watts mW/ $^\circ\text{C}$
Operating and Storage Junction Temperature Range	T_J, T_{stg}	-55 to +150		$^\circ\text{C}$

THERMAL CHARACTERISTICS

Characteristic	Symbol	Max	Unit
Thermal Resistance, Junction to Ambient	$R_{\theta JA}$	357	$^\circ\text{C}/\text{W}$
Thermal Resistance, Junction to Case	$R_{\theta JC}$	125	$^\circ\text{C}/\text{W}$

ELECTRICAL CHARACTERISTICS ($T_A = 25^\circ\text{C}$ unless otherwise noted)

Characteristic	Symbol	Min	Typ	Max	Unit
----------------	--------	-----	-----	-----	------

OFF CHARACTERISTICS

Collector–Emitter Breakdown Voltage ($I_C = -2.0$ mAdc, $I_B = 0$)	BC307,B,C BC308C	$V_{(BR)CEO}$	-45 -25	— —	— —	Vdc
Emitter–Base Breakdown Voltage ($I_E = -100$ μAdc , $I_C = 0$)	BC307,B,C BC308C	$V_{(BR)EBO}$	-5.0 -5.0	— —	— —	Vdc
Collector–Emitter Leakage Current ($V_{CES} = -50$ V, $V_{BE} = 0$)	BC307,B,C	I_{CES}	—	-0.2	-15	nAdc
($V_{CES} = -30$ V, $V_{BE} = 0$)	BC308C		—	-0.2	-15	
($V_{CES} = -50$ V, $V_{BE} = 0$) $T_A = 125^\circ\text{C}$	BC307,B,C		—	-0.2	-4.0	μA
($V_{CES} = -30$ V, $V_{BE} = 0$) $T_A = 125^\circ\text{C}$	BC308C		—	-0.2	-4.0	

ELECTRICAL CHARACTERISTICS ($T_A = 25^\circ\text{C}$ unless otherwise noted) (Continued)

Characteristic		Symbol	Min	Typ	Max	Unit
ON CHARACTERISTICS						
DC Current Gain ($I_C = -10\ \mu\text{Adc}$, $V_{CE} = -5.0\ \text{Vdc}$)	BC307B	h_{FE}	—	150	—	—
	BC307C/308C		—	270	—	—
($I_C = -2.0\ \text{mAdc}$, $V_{CE} = -5.0\ \text{Vdc}$)	BC307	120	—	800		
	BC307B/308B	200	290	460		
	BC307C/308C	420	500	800		
($I_C = -100\ \text{mAdc}$, $V_{CE} = -5.0\ \text{Vdc}$)	BC307B	—	180	—		
	BC307C/308C	—	300	—		
Collector–Emitter Saturation Voltage ($I_C = -10\ \text{mAdc}$, $I_B = -0.5\ \text{mAdc}$) ($I_C = -10\ \text{mAdc}$, $I_B = \text{see Note 1}$) ($I_C = -100\ \text{mAdc}$, $I_B = -5.0\ \text{mAdc}$)		$V_{CE(\text{sat})}$	—	-0.10	-0.3	Vdc
			—	-0.30	-0.6	
			—	-0.25	—	
Base–Emitter Saturation Voltage ($I_C = -10\ \text{mAdc}$, $I_B = -0.5\ \text{mAdc}$) ($I_C = -100\ \text{mAdc}$, $I_B = -5.0\ \text{mAdc}$)		$V_{BE(\text{sat})}$	—	-0.7	—	Vdc
			—	-1.0	—	
Base–Emitter On Voltage ($I_C = -2.0\ \text{mAdc}$, $V_{CE} = -5.0\ \text{Vdc}$)		$V_{BE(\text{on})}$	-0.55	-0.62	-0.7	Vdc
DYNAMIC CHARACTERISTICS						
Current–Gain — Bandwidth Product ($I_C = -10\ \text{mAdc}$, $V_{CE} = -5.0\ \text{Vdc}$, $f = 100\ \text{MHz}$)	BC307,B,C BC308C	f_T	—	280	—	MHz
			—	320	—	
Common Base Capacitance ($V_{CB} = -10\ \text{Vdc}$, $I_C = 0$, $f = 1.0\ \text{MHz}$)		C_{cbo}	—	—	6.0	pF
Noise Figure ($I_C = -0.2\ \text{mAdc}$, $V_{CE} = -5.0\ \text{Vdc}$, $R_S = 2.0\ \text{k}\Omega$, $f = 1.0\ \text{kHz}$)	BC307,B,C	NF	—	2.0	10	dB
($I_C = -0.2\ \text{mAdc}$, $V_{CE} = -5.0\ \text{Vdc}$, $R_S = 2.0\ \text{k}\Omega$, $f = 1.0\ \text{kHz}$, $f = 200\ \text{Hz}$)	BC308C		—	2.0	10	

1. $I_C = -10\ \text{mAdc}$ on the constant base current characteristic, which yields the point $I_C = -11\ \text{mAdc}$, $V_{CE} = -1.0\ \text{V}$.

TYPICAL CHARACTERISTICS

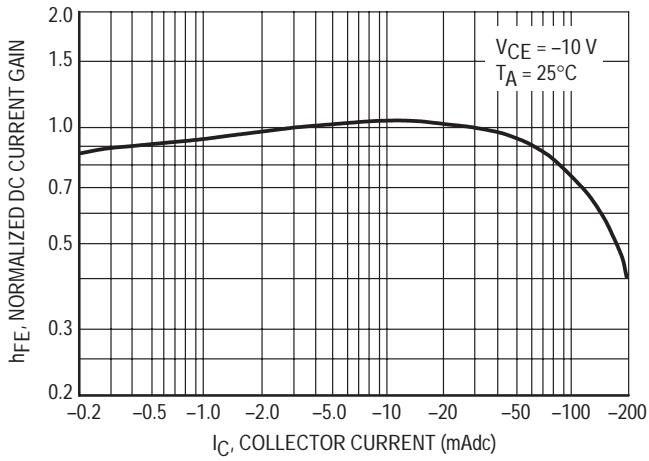


Figure 1. Normalized DC Current Gain

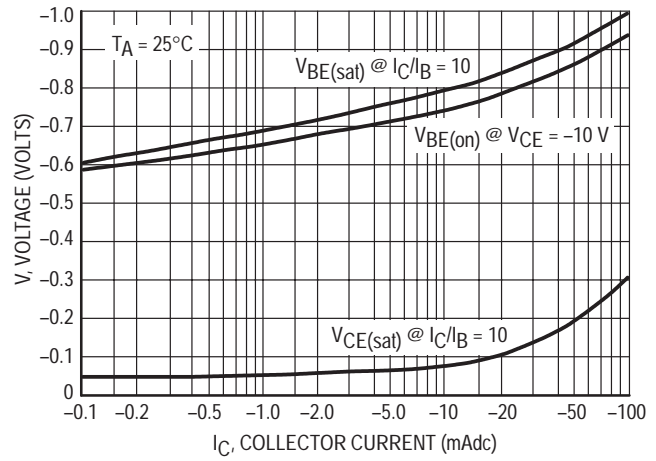


Figure 2. "Saturation" and "On" Voltages

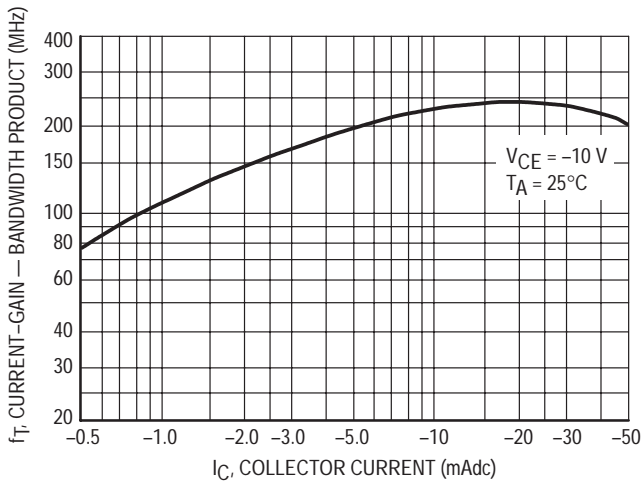


Figure 3. Current-Gain — Bandwidth Product

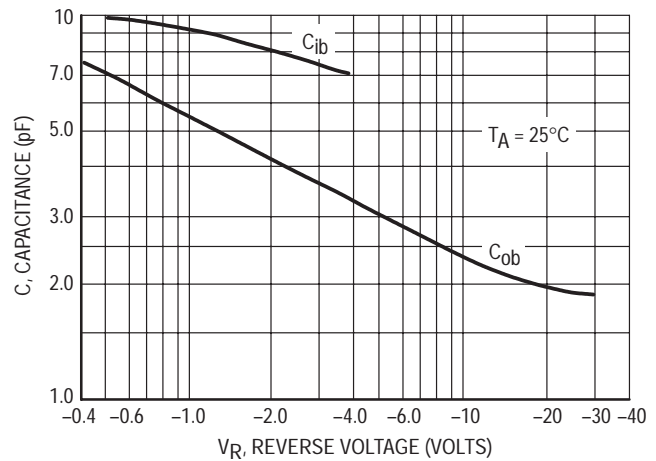


Figure 4. Capacitances

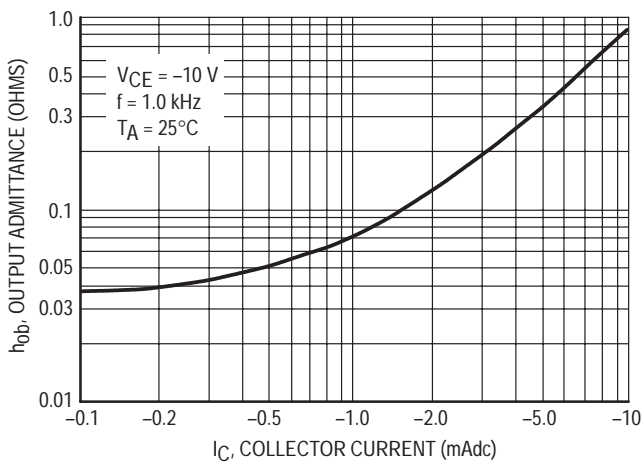


Figure 5. Output Admittance

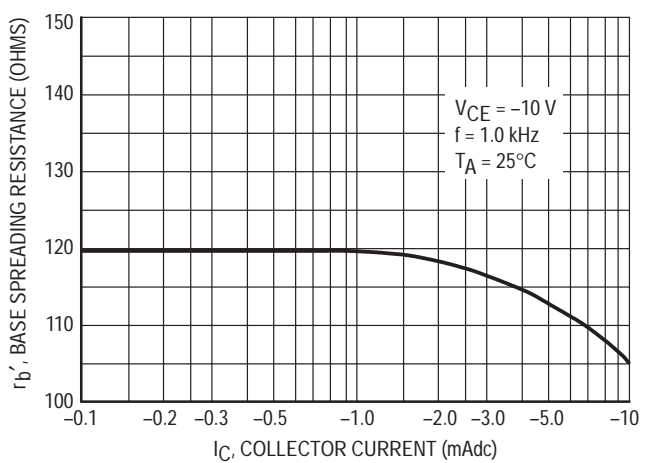
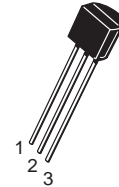
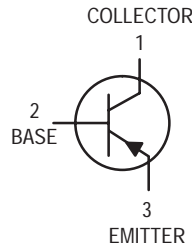


Figure 6. Base Spreading Resistance

Amplifier Transistors

PNP Silicon

BC327,-16,-25
BC328,-16,-25



CASE 29-04, STYLE 17
TO-92 (TO-226AA)

MAXIMUM RATINGS

Rating	Symbol	BC327	BC328	Unit
Collector–Emitter Voltage	V_{CEO}	-45	-25	Vdc
Collector–Base Voltage	V_{CBO}	-50	-30	Vdc
Emitter–Base Voltage	V_{EBO}	-5.0		Vdc
Collector Current — Continuous	I_C	-800		mAdc
Total Device Dissipation @ $T_A = 25^\circ\text{C}$ Derate above 25°C	P_D	625	5.0	mW mW/ $^\circ\text{C}$
Total Device Dissipation @ $T_C = 25^\circ\text{C}$ Derate above 25°C	P_D	1.5	12	Watt mW/ $^\circ\text{C}$
Operating and Storage Junction Temperature Range	T_J, T_{stg}	-55 to +150		$^\circ\text{C}$

THERMAL CHARACTERISTICS

Characteristic	Symbol	Max	Unit
Thermal Resistance, Junction to Ambient	$R_{\theta JA}$	200	$^\circ\text{C}/\text{W}$
Thermal Resistance, Junction to Case	$R_{\theta JC}$	83.3	$^\circ\text{C}/\text{W}$

ELECTRICAL CHARACTERISTICS ($T_A = 25^\circ\text{C}$ unless otherwise noted)

Characteristic	Symbol	Min	Typ	Max	Unit
----------------	--------	-----	-----	-----	------

OFF CHARACTERISTICS

Collector–Emitter Breakdown Voltage ($I_C = -10\text{ mA}, I_B = 0$)	BC327 BC328	$V_{(BR)CEO}$	-45 -25	— —	— —	Vdc
Collector–Emitter Breakdown Voltage ($I_C = -100\ \mu\text{A}, I_E = 0$)	BC327 BC328	$V_{(BR)CES}$	-50 -30	— —	— —	Vdc
Emitter–Base Breakdown Voltage ($I_E = -10\ \mu\text{A}, I_C = 0$)		$V_{(BR)EBO}$	-5.0	—	—	Vdc
Collector Cutoff Current ($V_{CB} = -30\text{ V}, I_E = 0$) ($V_{CB} = -20\text{ V}, I_E = 0$)	BC327 BC328	I_{CBO}	— —	— —	-100 -100	nAdc
Collector Cutoff Current ($V_{CE} = -45\text{ V}, V_{BE} = 0$) ($V_{CE} = -25\text{ V}, V_{BE} = 0$)	BC327 BC328	I_{CES}	— —	— —	-100 -100	nAdc
Emitter Cutoff Current ($V_{EB} = -4.0\text{ V}, I_C = 0$)		I_{EBO}	—	—	-100	nAdc

BC327,-16,-25 BC328,-16,-25

ELECTRICAL CHARACTERISTICS ($T_A = 25^\circ\text{C}$ unless otherwise noted) (Continued)

Characteristic	Symbol	Min	Typ	Max	Unit
ON CHARACTERISTICS					
DC Current Gain ($I_C = -100\text{ mA}$, $V_{CE} = -1.0\text{ V}$)	h_{FE}	BC327/BC328	100	—	630
		BC327-16/BC328-16	100	—	250
		BC327-25/BC328-25	160	—	400
($I_C = -300\text{ mA}$, $V_{CE} = -1.0\text{ V}$)		40	—	—	
Base-Emitter On Voltage ($I_C = -300\text{ mA}$, $V_{CE} = -1.0\text{ V}$)	$V_{BE(on)}$	—	—	-1.2	Vdc
Collector-Emitter Saturation Voltage ($I_C = -500\text{ mA}$, $I_B = -50\text{ mA}$)	$V_{CE(sat)}$	—	—	-0.7	Vdc
SMALL-SIGNAL CHARACTERISTICS					
Output Capacitance ($V_{CB} = -10\text{ V}$, $I_E = 0$, $f = 1.0\text{ MHz}$)	C_{ob}	—	11	—	pF
Current-Gain — Bandwidth Product ($I_C = -10\text{ mA}$, $V_{CE} = -5.0\text{ V}$, $f = 100\text{ MHz}$)	f_T	—	260	—	MHz

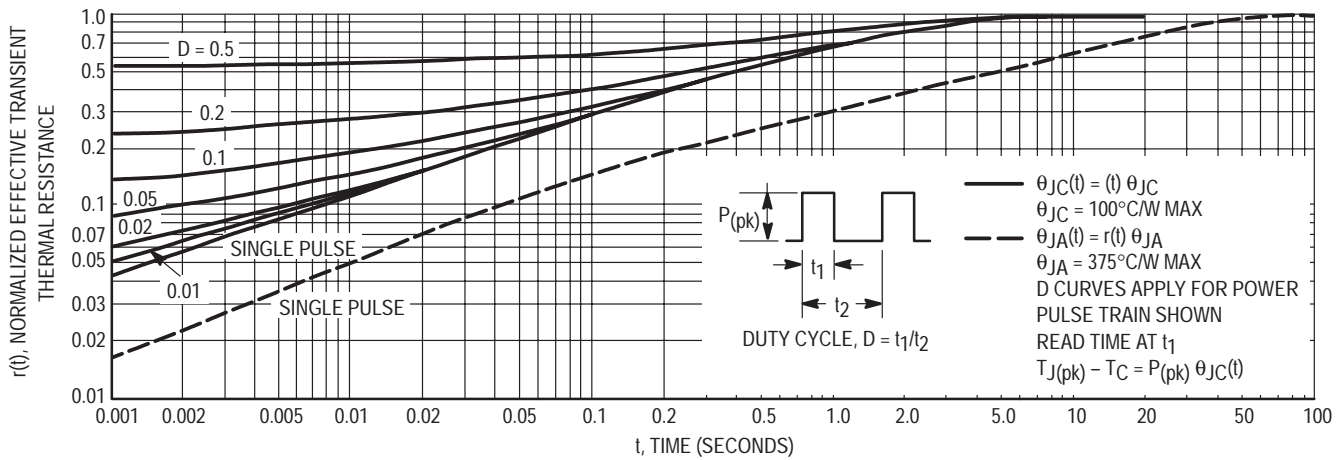


Figure 1. Thermal Response

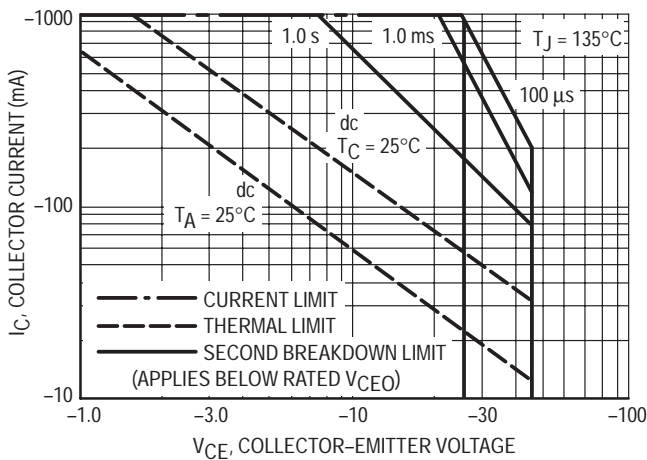


Figure 2. Active Region — Safe Operating Area

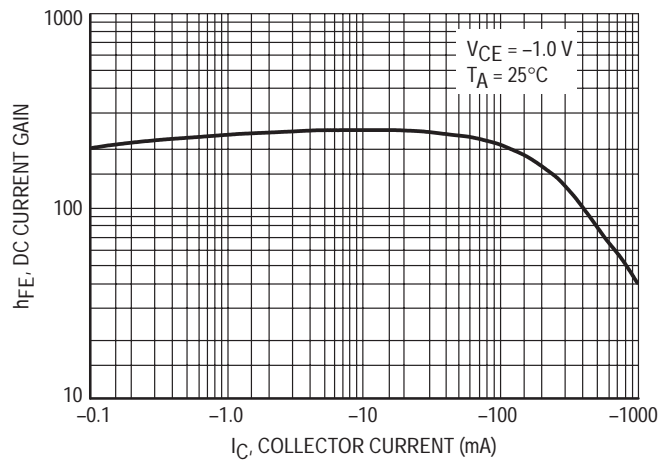


Figure 3. DC Current Gain

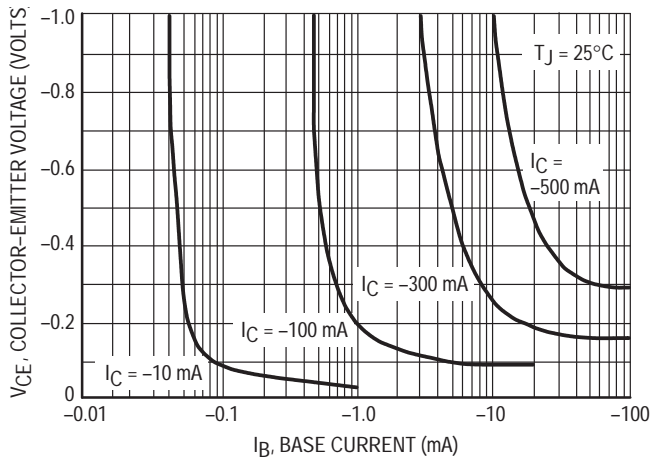


Figure 4. Saturation Region

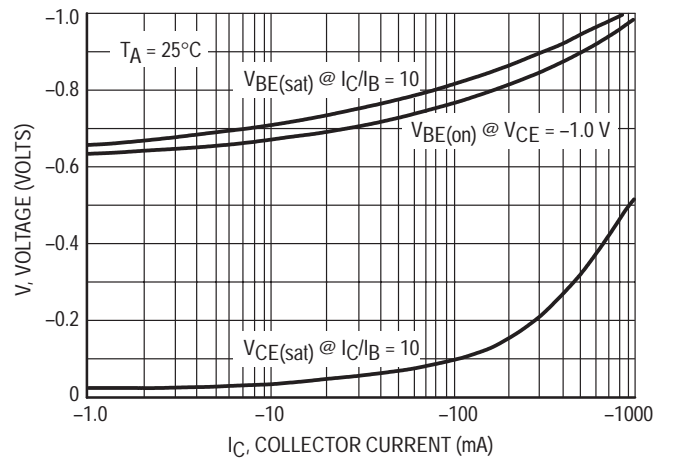


Figure 5. "On" Voltages

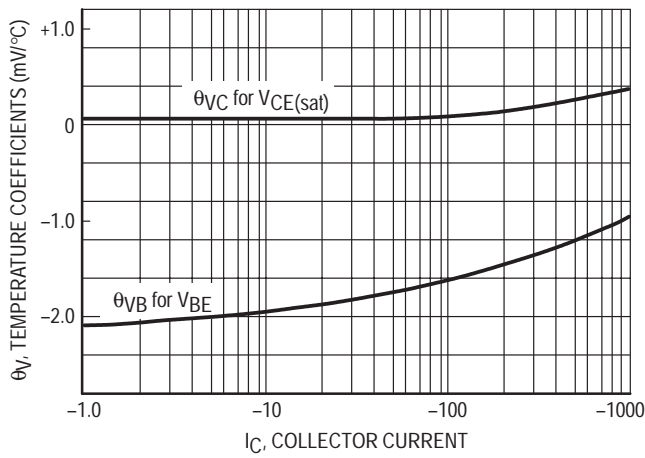


Figure 6. Temperature Coefficients

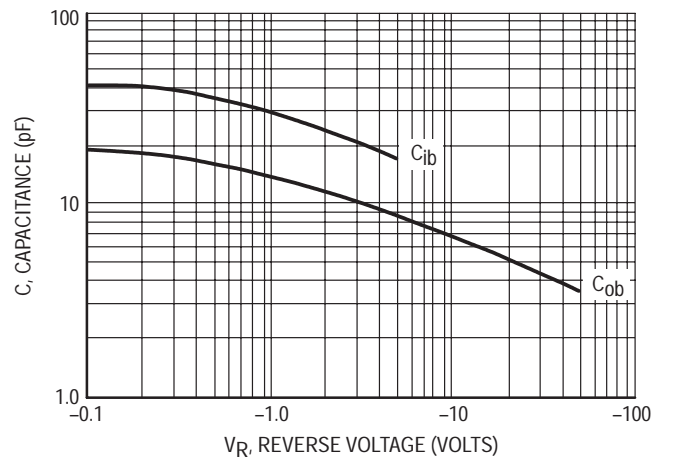
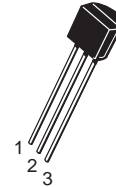
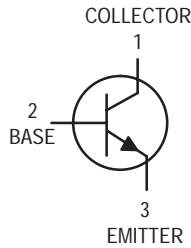


Figure 7. Capacitances

Amplifier Transistors

NPN Silicon

BC337,-16,-25,-40
BC338,-16,-25,-40



CASE 29-04, STYLE 17
TO-92 (TO-226AA)

MAXIMUM RATINGS

Rating	Symbol	BC337	BC338	Unit
Collector–Emitter Voltage	V_{CEO}	45	25	Vdc
Collector–Base Voltage	V_{CBO}	50	30	Vdc
Emitter–Base Voltage	V_{EBO}	5.0		Vdc
Collector Current — Continuous	I_C	800		mAdc
Total Device Dissipation @ $T_A = 25^\circ\text{C}$ Derate above 25°C	P_D	625	5.0	mW mW/ $^\circ\text{C}$
Total Device Dissipation @ $T_C = 25^\circ\text{C}$ Derate above 25°C	P_D	1.5	12	Watt mW/ $^\circ\text{C}$
Operating and Storage Junction Temperature Range	T_J, T_{stg}	–55 to +150		$^\circ\text{C}$

THERMAL CHARACTERISTICS

Characteristic	Symbol	Max	Unit
Thermal Resistance, Junction to Ambient	$R_{\theta JA}$	200	$^\circ\text{C}/\text{W}$
Thermal Resistance, Junction to Case	$R_{\theta JC}$	83.3	$^\circ\text{C}/\text{W}$

ELECTRICAL CHARACTERISTICS ($T_A = 25^\circ\text{C}$ unless otherwise noted)

Characteristic	Symbol	Min	Typ	Max	Unit
----------------	--------	-----	-----	-----	------

OFF CHARACTERISTICS

Collector–Emitter Breakdown Voltage ($I_C = 10\text{ mA}, I_B = 0$)	BC337 BC338	$V_{(BR)CEO}$	45 25	— —	— —	Vdc
Collector–Emitter Breakdown Voltage ($I_C = 100\ \mu\text{A}, I_E = 0$)	BC337 BC338	$V_{(BR)CES}$	50 30	— —	— —	Vdc
Emitter–Base Breakdown Voltage ($I_E = 10\ \mu\text{A}, I_C = 0$)		$V_{(BR)EBO}$	5.0	—	—	Vdc
Collector Cutoff Current ($V_{CB} = 30\text{ V}, I_E = 0$) ($V_{CB} = 20\text{ V}, I_E = 0$)	BC337 BC338	I_{CBO}	— —	— —	100 100	nAdc
Collector Cutoff Current ($V_{CE} = 45\text{ V}, V_{BE} = 0$) ($V_{CE} = 25\text{ V}, V_{BE} = 0$)	BC337 BC338	I_{CES}	— —	— —	100 100	nAdc
Emitter Cutoff Current ($V_{EB} = 4.0\text{ V}, I_C = 0$)		I_{EBO}	—	—	100	nAdc

ELECTRICAL CHARACTERISTICS (T_A = 25°C unless otherwise noted) (Continued)

Characteristic	Symbol	Min	Typ	Max	Unit	
ON CHARACTERISTICS						
DC Current Gain (I _C = 100 mA, V _{CE} = 1.0 V)	h _{FE}	BC337/BC338	100	—	630	—
		BC337-16/BC338-16	100	—	250	—
		BC337-25/BC338-25	160	—	400	—
		BC337-40/BC338-40	250	—	630	—
			60	—	—	—
(I _C = 300 mA, V _{CE} = 1.0 V)						
Base-Emitter On Voltage (I _C = 300 mA, V _{CE} = 1.0 V)	V _{BE(on)}	—	—	1.2	Vdc	
Collector-Emitter Saturation Voltage (I _C = 500 mA, I _B = 50 mA)	V _{CE(sat)}	—	—	0.7	Vdc	

SMALL-SIGNAL CHARACTERISTICS

Output Capacitance (V _{CB} = 10 V, I _E = 0, f = 1.0 MHz)	C _{ob}	—	15	—	pF
Current-Gain — Bandwidth Product (I _C = 10 mA, V _{CE} = 5.0 V, f = 100 MHz)	f _T	—	210	—	MHz

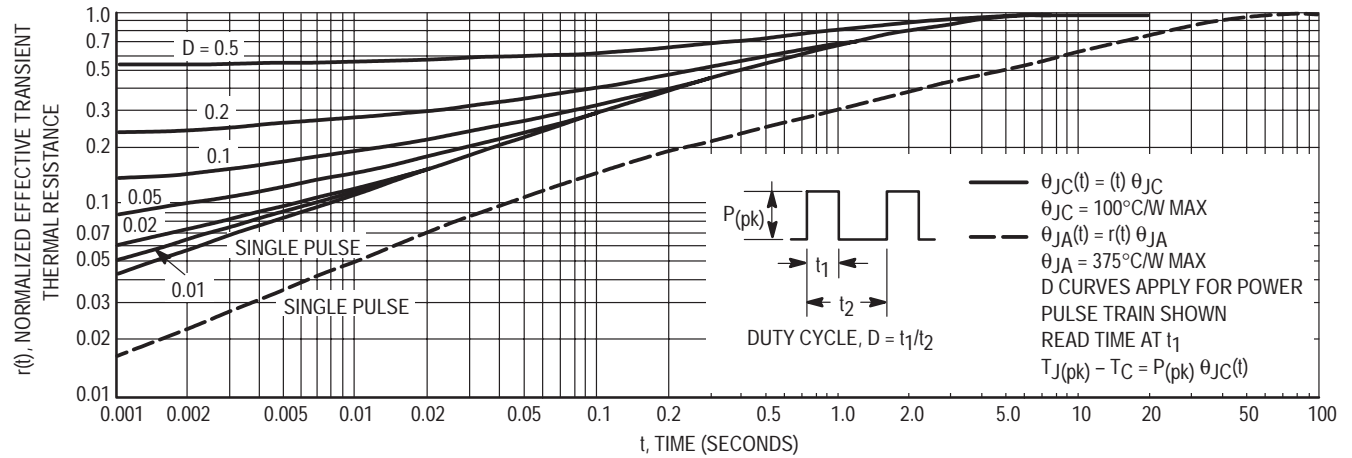


Figure 1. Thermal Response

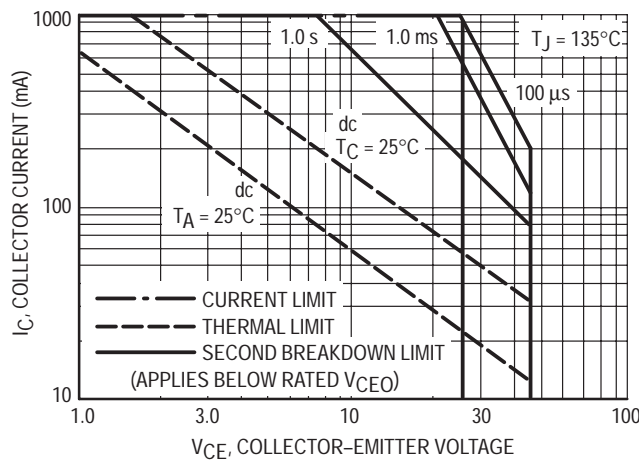


Figure 2. Active Region — Safe Operating Area

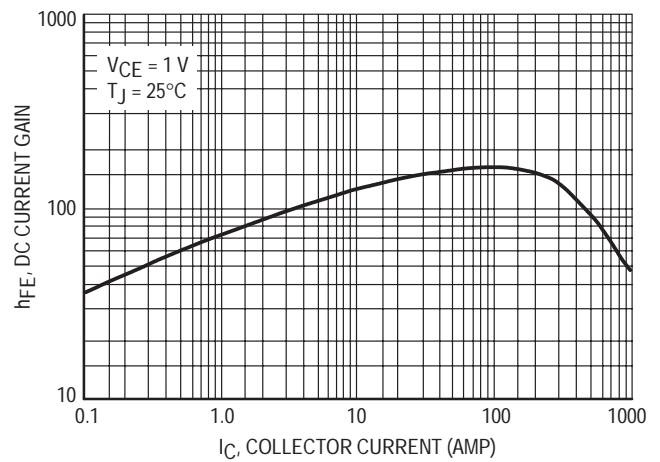


Figure 3. DC Current Gain

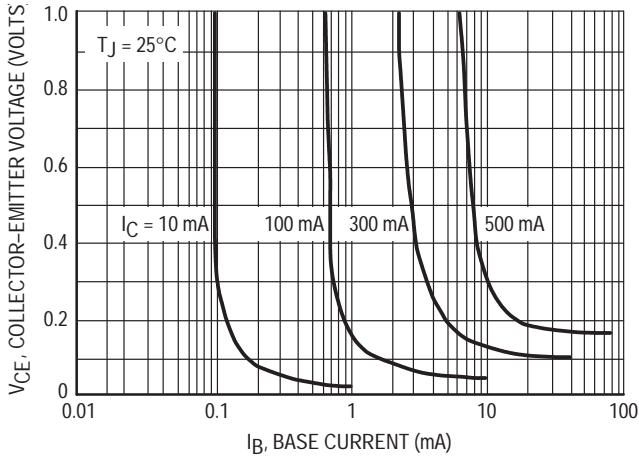


Figure 4. Saturation Region

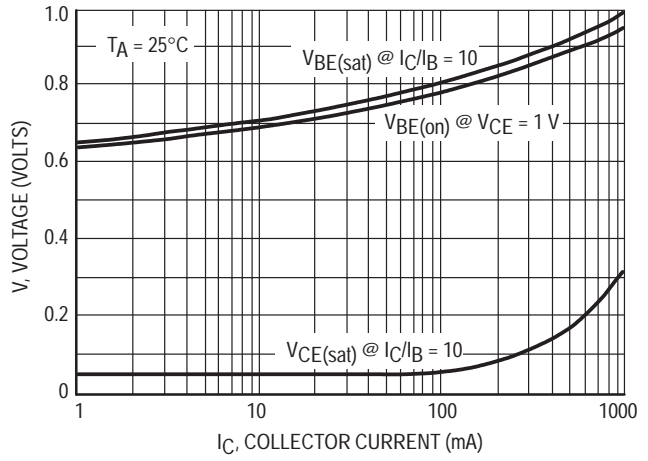


Figure 5. "On" Voltages

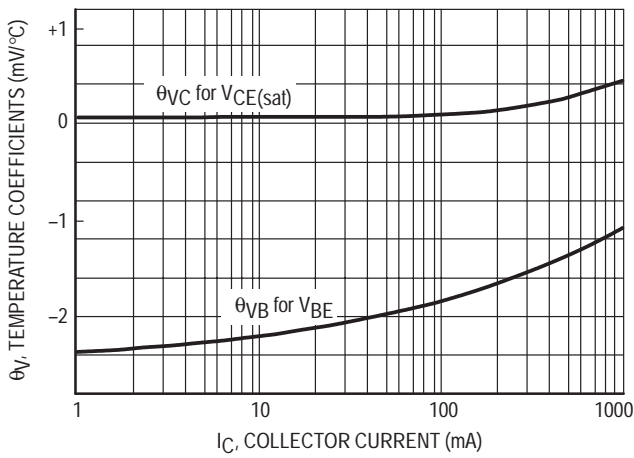


Figure 6. Temperature Coefficients

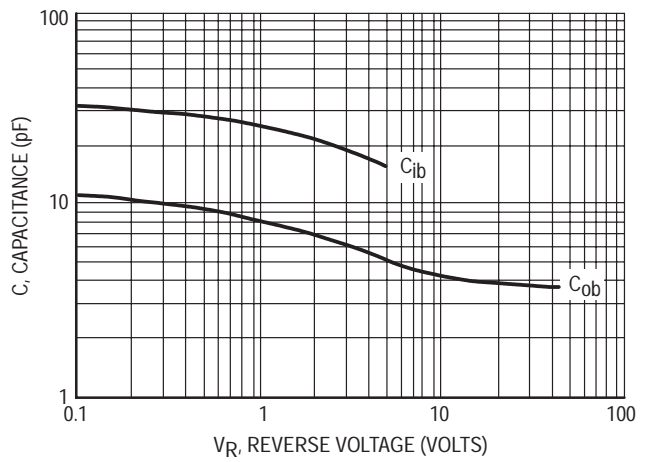
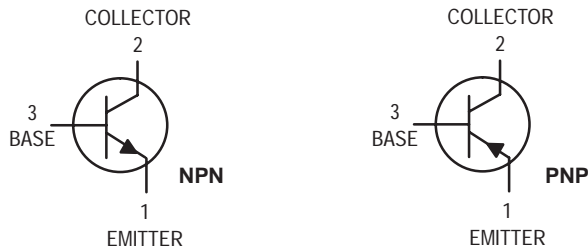


Figure 7. Capacitances

Amplifier Transistors

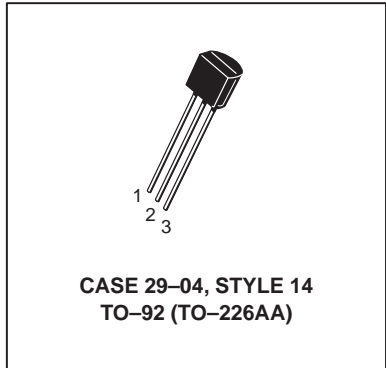


NPN
BC368
PNP
BC369

Voltage and current are negative
for PNP transistors

MAXIMUM RATINGS

Rating	Symbol	Value	Unit
Collector–Emitter Voltage	V_{CEO}	20	Vdc
Collector–Emitter Voltage	V_{CES}	25	Vdc
Emitter–Base Voltage	V_{EBO}	5.0	Vdc
Collector Current — Continuous	I_C	1.0	Adc
Total Device Dissipation @ $T_A = 25^\circ\text{C}$ Derate above 25°C	P_D	625 5.0	mW mW/ $^\circ\text{C}$
Total Device Dissipation @ $T_C = 25^\circ\text{C}$ Derate above 25°C	P_D	1.5 12	Watt mW/ $^\circ\text{C}$
Operating and Storage Junction Temperature Range	T_J, T_{stg}	-55 to +150	$^\circ\text{C}$



THERMAL CHARACTERISTICS

Characteristic	Symbol	Max	Unit
Thermal Resistance, Junction to Ambient	$R_{\theta JA}$	200	$^\circ\text{C}/\text{W}$
Thermal Resistance, Junction to Case	$R_{\theta JC}$	83.3	$^\circ\text{C}/\text{W}$

ELECTRICAL CHARACTERISTICS ($T_A = 25^\circ\text{C}$ unless otherwise noted)

Characteristic	Symbol	Min	Typ	Max	Unit
----------------	--------	-----	-----	-----	------

OFF CHARACTERISTICS

Collector–Emitter Breakdown Voltage ($I_C = 10\text{ mA}, I_B = 0$)	$V_{(BR)CEO}$	20	—	—	Vdc
Collector–Base Breakdown Voltage ($I_C = 100\ \mu\text{A}, I_E = 0$)	$V_{(BR)CBO}$	25	—	—	Vdc
Emitter–Base Breakdown Voltage ($I_E = 100\ \mu\text{A}, I_C = 0$)	$V_{(BR)EBO}$	5.0	—	—	Vdc
Collector Cutoff Current ($V_{CB} = 25\text{ V}, I_E = 0$) ($V_{CB} = 25\text{ V}, I_E = 0, T_J = 150^\circ\text{C}$)	I_{CBO}	— —	— —	10 1.0	μAdc mAdc
Emitter Cutoff Current ($V_{EB} = 5.0\text{ V}, I_C = 0$)	I_{EBO}	—	—	10	μAdc

ON CHARACTERISTICS

DC Current Gain ($V_{CE} = 10\text{ V}, I_C = 5.0\text{ mA}$) ($V_{CE} = 1.0\text{ V}, I_C = 0.5\text{ A}$) ($V_{CE} = 1.0\text{ V}, I_C = 1.0\text{ A}$)	h_{FE}	50 85 60	— — —	— 375 —	—
Bandwidth Product ($I_C = 10\text{ mA}, V_{CE} = 5.0\text{ V}, f = 20\text{ MHz}$)	f_T	65	—	—	MHz
Collector–Emitter Saturation Voltage ($I_C = 1.0\text{ A}, I_B = 100\text{ mA}$)	$V_{CE(sat)}$	—	—	0.5	V
Base–Emitter On Voltage ($I_C = 1.0\text{ A}, V_{CE} = 1.0\text{ V}$)	$V_{BE(on)}$	—	—	1.0	V

NPN BC368 PNP BC369

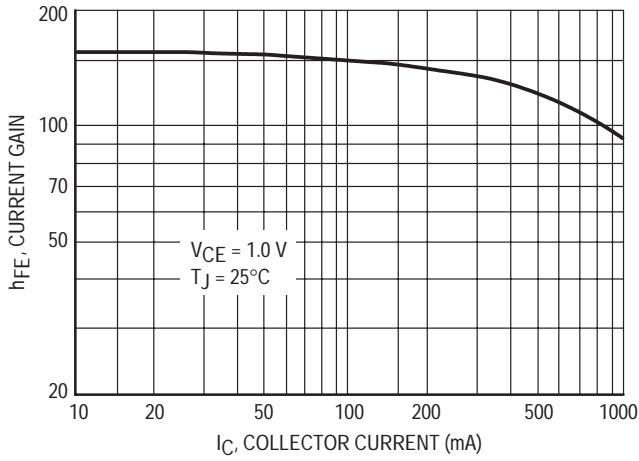


Figure 1. DC Current Gain

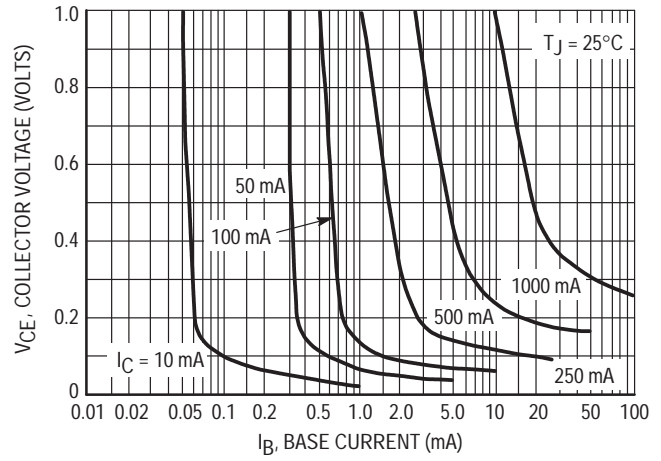


Figure 2. Collector Saturation Region

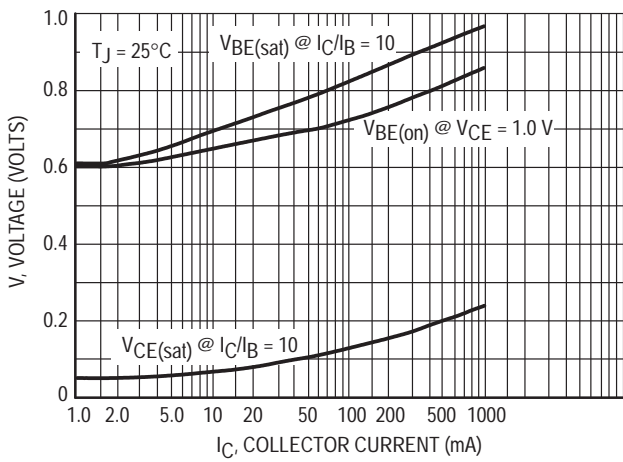


Figure 3. "On" Voltages

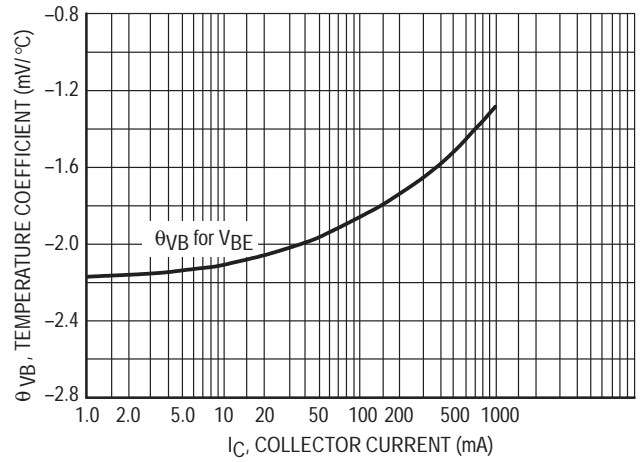


Figure 4. Temperature Coefficient

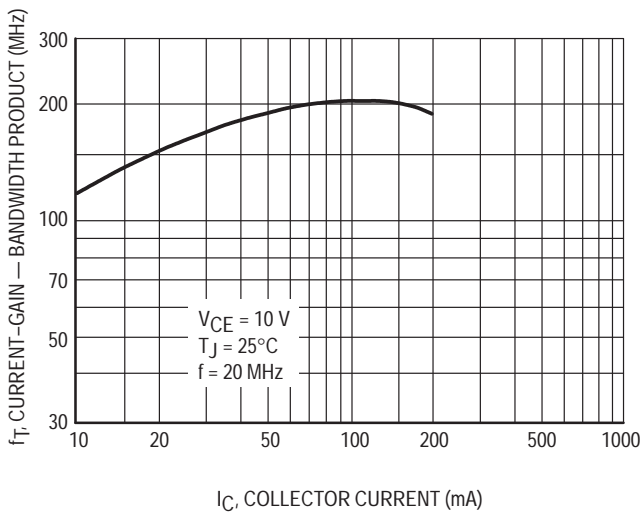


Figure 5. Current-Gain — Bandwidth Product

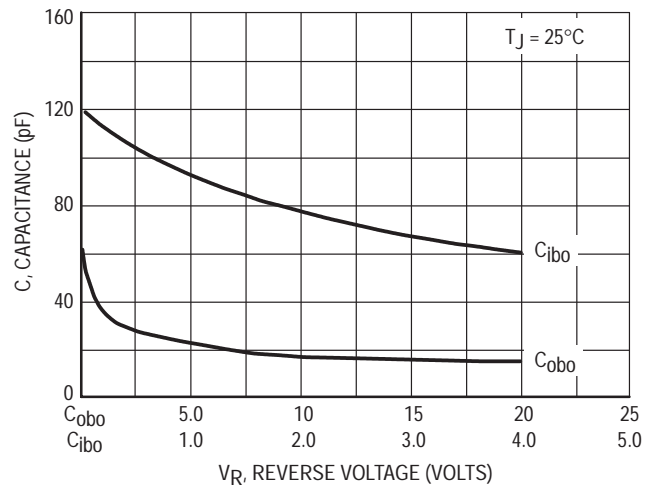
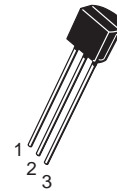
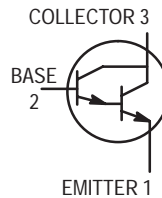


Figure 6. Capacitance

High Voltage Darlington Transistors

NPN Silicon

BC372
BC373



CASE 29-04, STYLE 1
TO-92 (TO-226AA)

MAXIMUM RATINGS

Rating	Symbol	BC372	BC373	Unit
Collector–Emitter Voltage	V_{CES}	100	80	Vdc
Collector–Base Voltage	V_{CBO}	100	80	Vdc
Emitter–Base Voltage	V_{EBO}	12		Vdc
Collector Current — Continuous	I_C	1.0		Adc
Total Device Dissipation @ $T_A = 25^\circ\text{C}$ Derate above 25°C	P_D	625	5.0	mW mW/ $^\circ\text{C}$
Total Device Dissipation @ $T_C = 25^\circ\text{C}$ Derate above 25°C	P_D	1.5	12	Watt mW/ $^\circ\text{C}$
Operating and Storage Junction Temperature Range	T_J, T_{stg}	–55 to +150		$^\circ\text{C}$

THERMAL CHARACTERISTICS

Characteristic	Symbol	Max	Unit
Thermal Resistance, Junction to Ambient	$R_{\theta JA}$	200	$^\circ\text{C}/\text{W}$
Thermal Resistance, Junction to Case	$R_{\theta JC}$	83.3	$^\circ\text{C}/\text{W}$

ELECTRICAL CHARACTERISTICS ($T_A = 25^\circ\text{C}$ unless otherwise noted)

Characteristic	Symbol	Min	Typ	Max	Unit
----------------	--------	-----	-----	-----	------

OFF CHARACTERISTICS

Collector–Emitter Breakdown Voltage ⁽¹⁾ ($I_C = 100 \mu\text{Adc}, I_B = 0$)	BC372 BC373	$V_{(BR)CES}$	100 80	— —	— —	Vdc
Collector–Base Breakdown Voltage ($I_C = 100 \mu\text{Adc}, I_E = 0$)	BC372 BC373	$V_{(BR)CBO}$	100 80	— —	— —	Vdc
Emitter–Base Breakdown Voltage ($I_E = 10 \mu\text{Adc}, I_C = 0$)		$V_{(BR)EBO}$	12	—	—	Vdc
Collector Cutoff Current ($V_{CB} = 80 \text{Vdc}, I_E = 0$) ($V_{CB} = 60 \text{Vdc}, I_E = 0$)	BC372 BC373	I_{CBO}	— —	— —	100 100	nAdc
Emitter Cutoff Current ($V_{EB} = 10 \text{V}, I_C = 0$)		I_{EBO}	—	—	100	nAdc

1. Pulse Test: Pulse Width = 300 μs , Duty Cycle 2.0%.

ELECTRICAL CHARACTERISTICS ($T_A = 25^\circ\text{C}$ unless otherwise noted) (Continued)

Characteristic	Symbol	Min	Typ	Max	Unit
ON CHARACTERISTICS(1)					
DC Current Gain ($I_C = 250 \text{ mAdc}$, $V_{CE} = 5.0 \text{ Vdc}$) ($I_C = 100 \text{ mAdc}$, $V_{CE} = 5.0 \text{ Vdc}$)	h_{FE}	8.0 10	— —	— 160	K
Collector–Emitter Saturation Voltage ($I_C = 250 \text{ mAdc}$, $I_B = 0.25 \text{ mAdc}$)	$V_{CE(sat)}$	—	1.0	1.1	Vdc
Base–Emitter Saturation Voltage ($I_C = 250 \text{ mAdc}$, $I_B = 0.25 \text{ mAdc}$)	$V_{BE(sat)}$	—	1.4	2.0	Vdc

DYNAMIC CHARACTERISTICS

Current–Gain Bandwidth Product ($I_C = 100 \text{ mAdc}$, $V_{CE} = 5.0 \text{ Vdc}$, $f = 100 \text{ MHz}$)	f_T	100	200	—	MHz
Output Capacitance ($V_{CB} = 10 \text{ Vdc}$, $I_E = 0$, $f = 1.0 \text{ MHz}$)	C_{ob}	—	10	25	pF
Noise Figure ($I_C = 1.0 \text{ mAdc}$, $V_{CE} = 5.0 \text{ Vdc}$, $R_g = 100 \text{ k ohm}$, $f = 1.0 \text{ kHz}$)	NF	—	2.0	—	dB

1. Pulse Test: Pulse Width = 300 μs , Duty Cycle 2.0%.

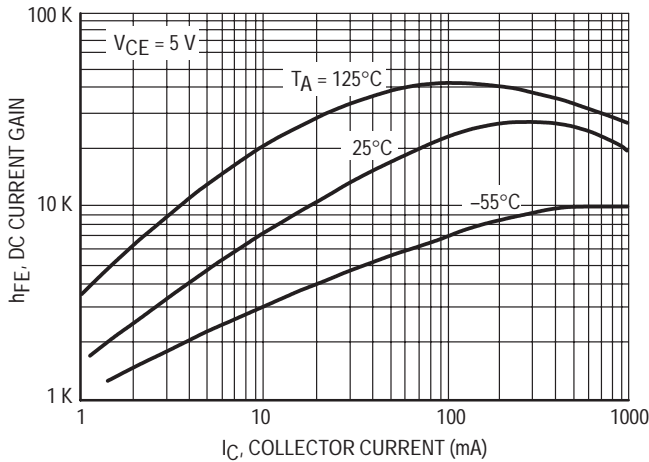


Figure 1. DC Current Gain

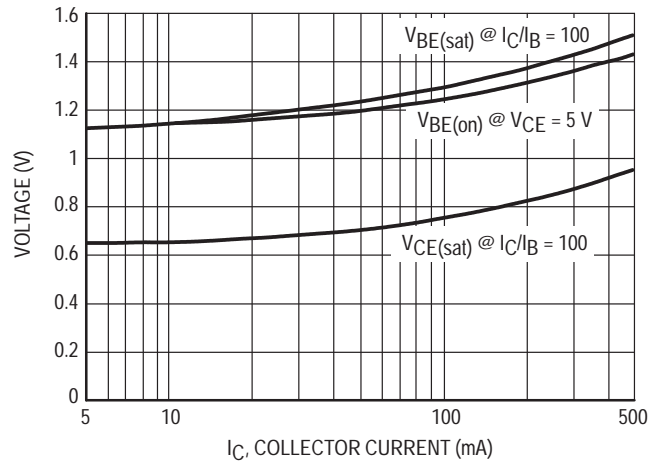


Figure 2. "Saturation" and "On" Voltages

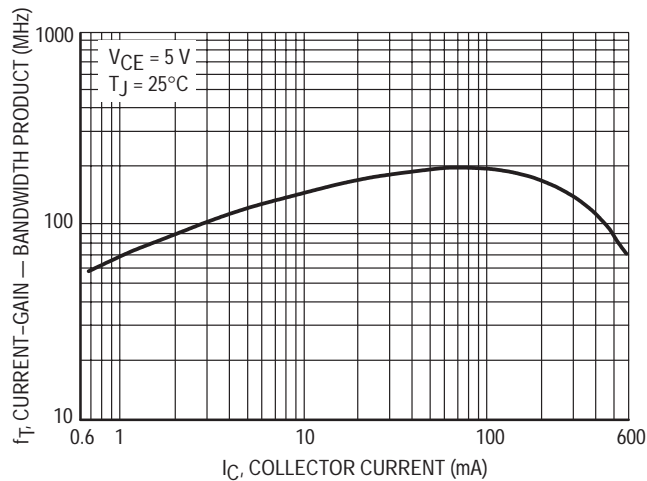


Figure 3. Current–Gain — Bandwidth Product

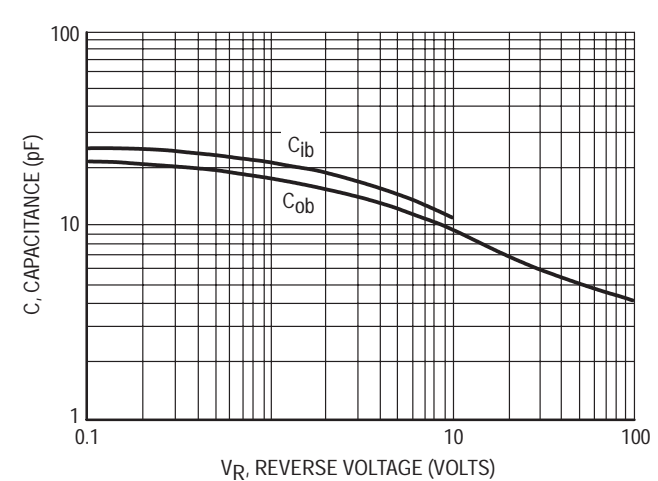
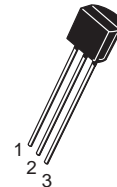
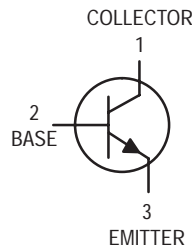


Figure 4. Capacitances

High Current Transistors

NPN Silicon

BC489,A,B



CASE 29-04, STYLE 17
TO-92 (TO-226AA)

MAXIMUM RATINGS

Rating	Symbol	Value	Unit
Collector–Emitter Voltage	V_{CE0}	80	Vdc
Collector–Base Voltage	V_{CBO}	80	Vdc
Emitter–Base Voltage	V_{EBO}	5.0	Vdc
Collector Current — Continuous	I_C	0.5	Adc
Total Device Dissipation @ $T_A = 25^\circ\text{C}$ Derate above 25°C	P_D	625 5.0	mW mW/ $^\circ\text{C}$
Total Device Dissipation @ $T_C = 25^\circ\text{C}$ Derate above 25°C	P_D	1.5 12	Watt mW/ $^\circ\text{C}$
Operating and Storage Junction Temperature Range	T_J, T_{stg}	-55 to +150	$^\circ\text{C}$

THERMAL CHARACTERISTICS

Characteristic	Symbol	Max	Unit
Thermal Resistance, Junction to Ambient	$R_{\theta JA}$	200	$^\circ\text{C}/\text{W}$
Thermal Resistance, Junction to Case	$R_{\theta JC}$	83.3	$^\circ\text{C}/\text{W}$

ELECTRICAL CHARACTERISTICS ($T_A = 25^\circ\text{C}$ unless otherwise noted)

Characteristic	Symbol	Min	Typ	Max	Unit
----------------	--------	-----	-----	-----	------

OFF CHARACTERISTICS

Collector–Emitter Breakdown Voltage ⁽¹⁾ ($I_C = 10 \text{ mAdc}, I_B = 0$)	$V_{(BR)CEO}$	80	—	—	Vdc
Collector–Base Breakdown Voltage ($I_C = 100 \mu\text{Adc}, I_E = 0$)	$V_{(BR)CBO}$	80	—	—	Vdc
Emitter–Base Breakdown Voltage ($I_E = 10 \mu\text{Adc}, I_C = 0$)	$V_{(BR)EBO}$	5.0	—	—	Vdc
Collector Cutoff Current ($V_{CB} = 60 \text{ Vdc}, I_E = 0$)	I_{CBO}	—	—	100	nAdc

ON CHARACTERISTICS*

DC Current Gain ($I_C = 10 \text{ mAdc}, V_{CE} = 2.0 \text{ Vdc}$) ($I_C = 100 \text{ mAdc}, V_{CE} = 2.0 \text{ Vdc}$)	h_{FE}	40 60	— —	— 400	—
	BC489	100	160	250	
	BC489A	160	260	400	
($I_C = 1.0 \text{ Adc}, V_{CE} = 5.0 \text{ Vdc}$)*	BC489B	15	—	—	

1. Pulse Test: Pulse Width = 300 μs , Duty Cycle 2%.

BC489,A,B

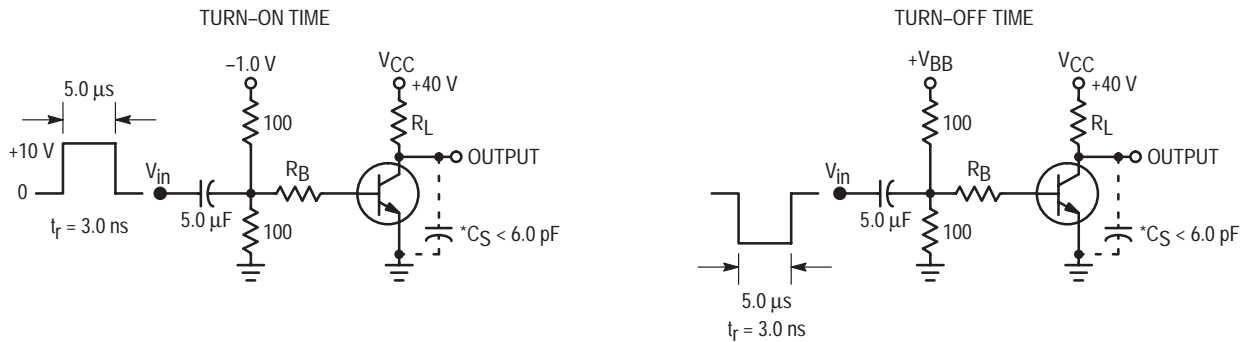
ELECTRICAL CHARACTERISTICS (T_A = 25°C unless otherwise noted) (Continued)

Characteristic	Symbol	Min	Typ	Max	Unit
ON CHARACTERISTICS* (Continued)					
Collector–Emitter Saturation Voltage (I _C = 500 mA _{dc} , I _B = 50 mA _{dc}) (I _C = 1.0 A _{dc} , I _B = 100 mA _{dc})	V _{CE(sat)}	—	0.2 0.3	0.5 —	V _{dc}
Base–Emitter Saturation Voltage (I _C = 500 mA _{dc} , I _B = 50 mA _{dc}) (I _C = 1.0 A _{dc} , I _B = 100 mA _{dc}) ⁽¹⁾	V _{BE(sat)}	—	0.85 0.9	1.2 —	V _{dc}

DYNAMIC CHARACTERISTICS

Current–Gain — Bandwidth Product (I _C = 50 mA _{dc} , V _{CE} = 2.0 V _{dc} , f = 100 MHz)	f _T	—	200	—	MHz
Output Capacitance (V _{CB} = 10 V _{dc} , I _E = 0, f = 1.0 MHz)	C _{ob}	—	7.0	—	pF
Input Capacitance (V _{EB} = 0.5 V _{dc} , I _C = 0, f = 1.0 MHz)	C _{ib}	—	50	—	pF

1. Pulse Test: Pulse Width = 300 μs, Duty Cycle 2.0%.



* Total Shunt Capacitance of Test Jig and Connectors
For PNP Test Circuits, Reverse All Voltage Polarities

Figure 1. Switching Time Test Circuits

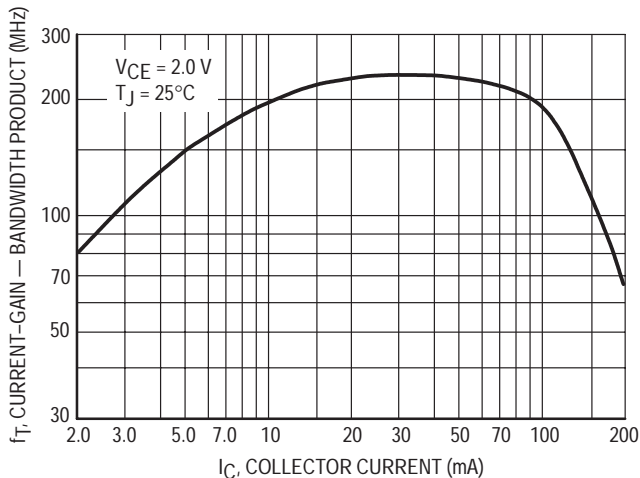


Figure 2. Current-Gain — Bandwidth Product

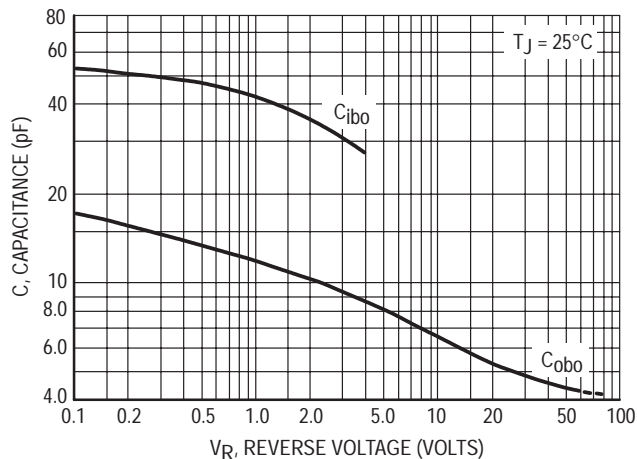


Figure 3. Capacitance

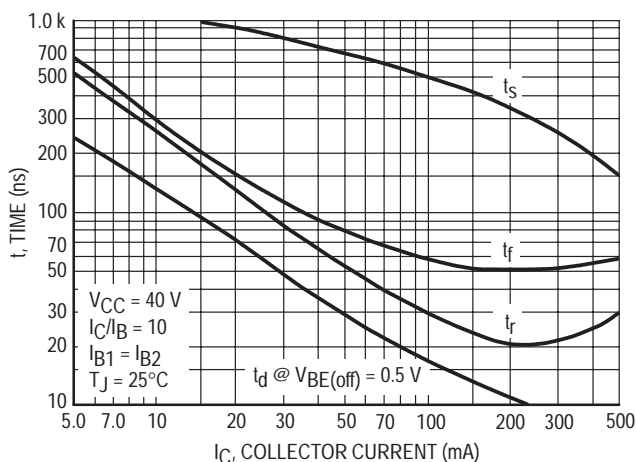


Figure 4. Switching Time

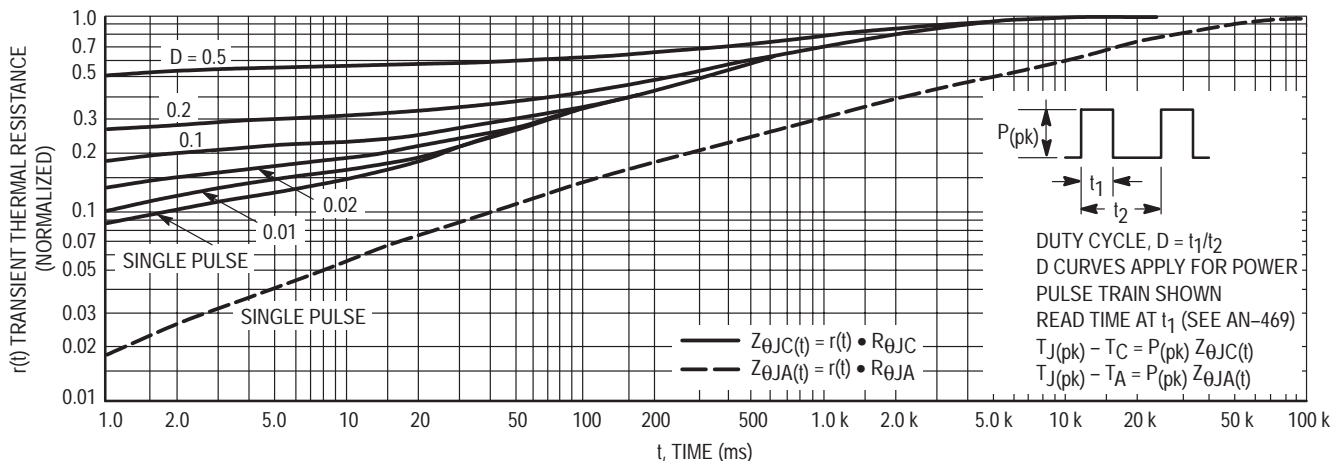


Figure 5. Thermal Response

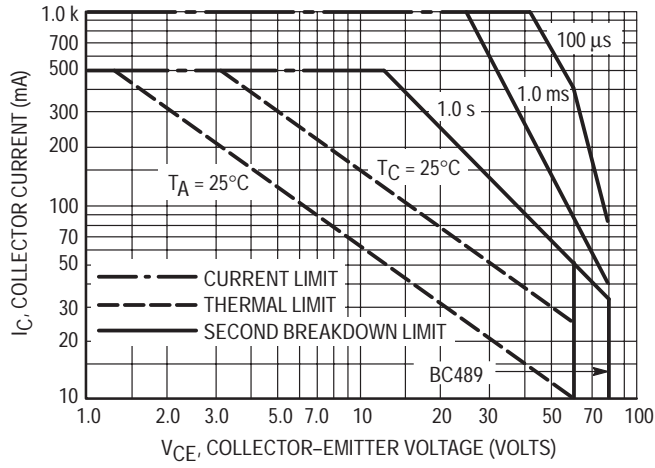


Figure 6. Active Region — Safe Operating Area

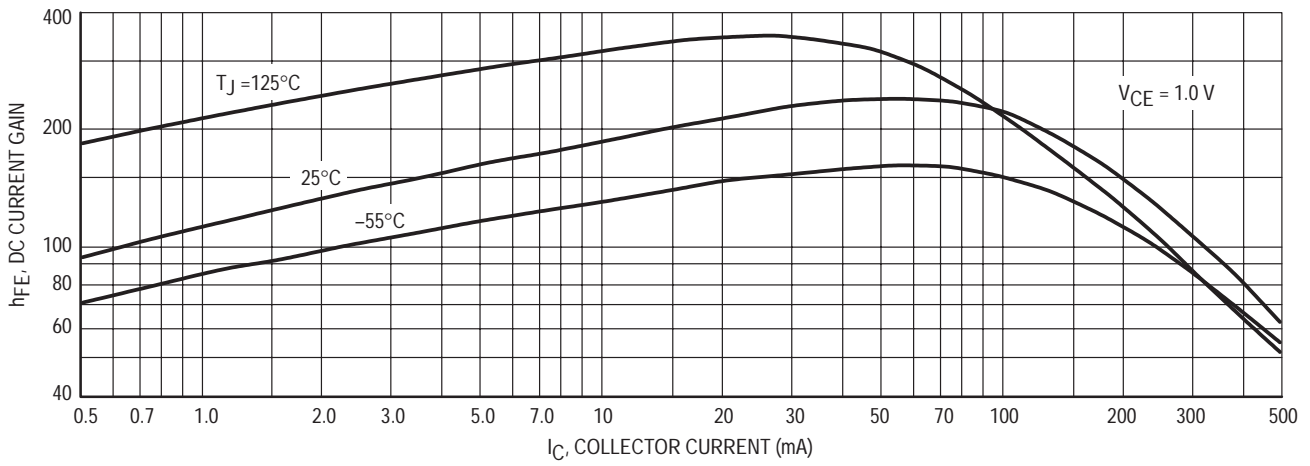


Figure 7. DC Current Gain

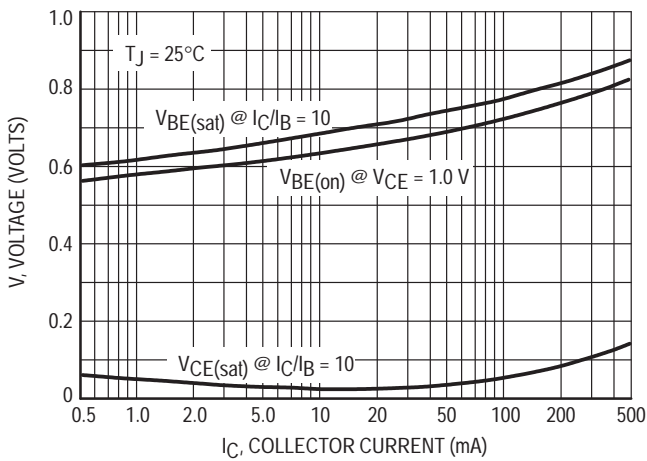


Figure 8. "On" Voltages

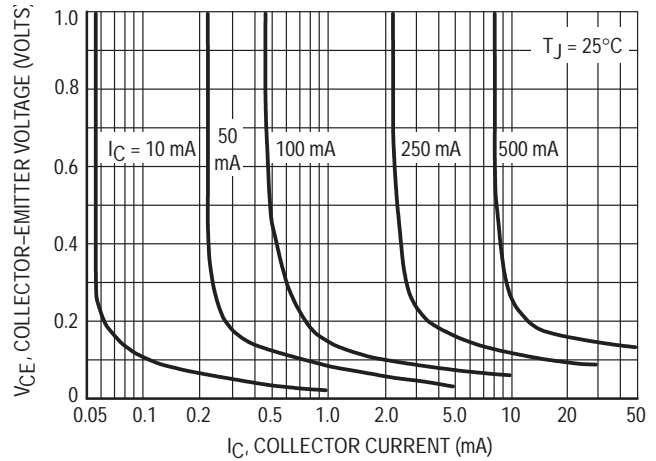


Figure 9. Collector Saturation Region

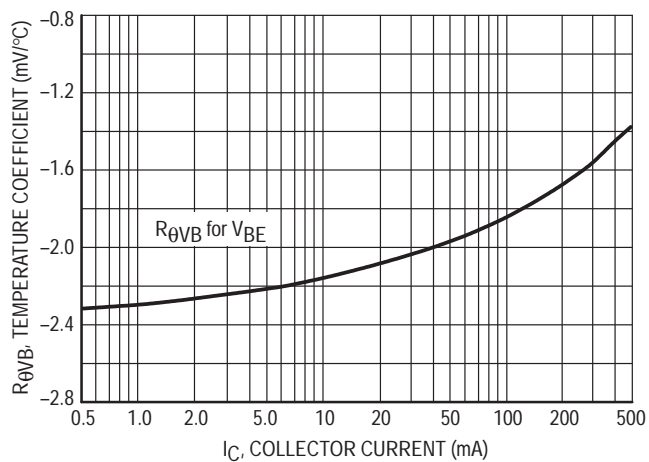


Figure 10. Base-Emitter Temperature Coefficient

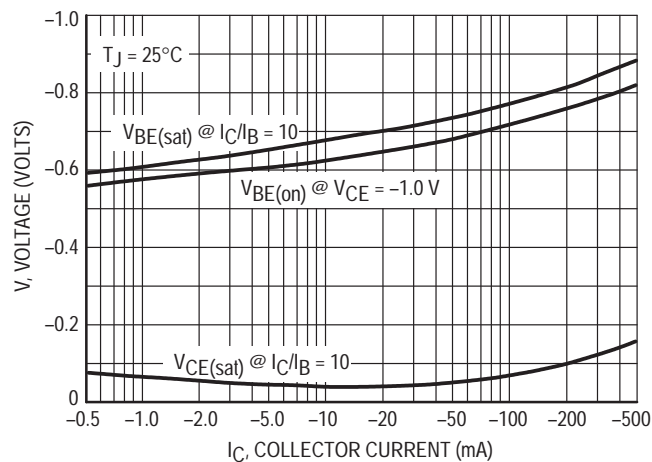


Figure 11. "On" Voltages

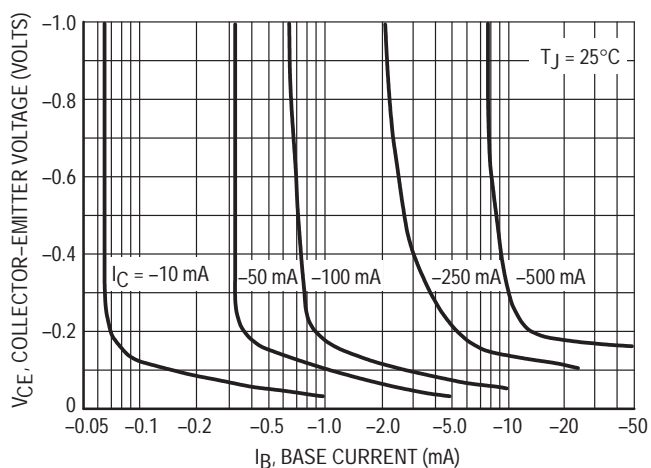


Figure 12. Collector Saturation Region

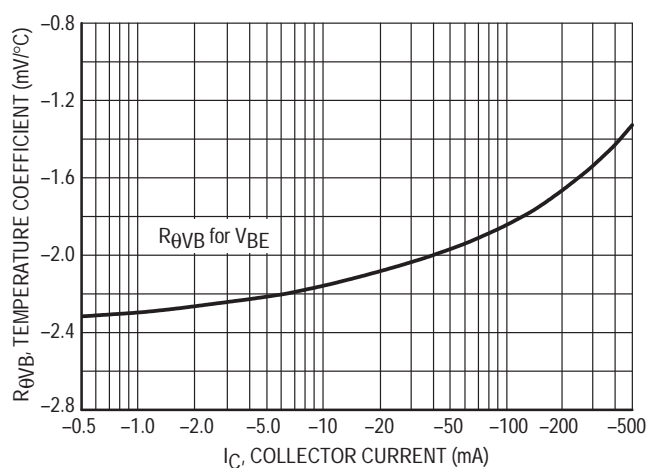
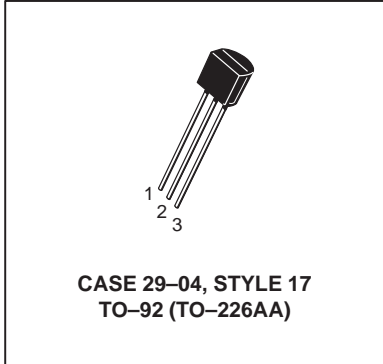
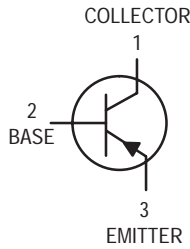


Figure 13. Base-Emitter Temperature Coefficient

High Current Transistors

PNP Silicon

BC490,A



MAXIMUM RATINGS

Rating	Symbol	Value	Unit
Collector–Emitter Voltage	V_{CEO}	–80	Vdc
Collector–Base Voltage	V_{CBO}	–80	Vdc
Emitter–Base Voltage	V_{EBO}	–4.0	Vdc
Collector Current — Continuous	I_C	–0.5	Adc
Total Device Dissipation @ $T_A = 25^\circ\text{C}$ Derate above 25°C	P_D	625 5.0	mW mW/ $^\circ\text{C}$
Total Device Dissipation @ $T_C = 25^\circ\text{C}$ Derate above 25°C	P_D	1.5 12	Watt mW/ $^\circ\text{C}$
Operating and Storage Junction Temperature Range	T_J, T_{stg}	–55 to +150	$^\circ\text{C}$

THERMAL CHARACTERISTICS

Characteristic	Symbol	Max	Unit
Thermal Resistance, Junction to Ambient	$R_{\theta JA}$	200	$^\circ\text{C}/\text{W}$
Thermal Resistance, Junction to Case	$R_{\theta JC}$	83.3	$^\circ\text{C}/\text{W}$

ELECTRICAL CHARACTERISTICS ($T_A = 25^\circ\text{C}$ unless otherwise noted)

Characteristic	Symbol	Min	Typ	Max	Unit
----------------	--------	-----	-----	-----	------

OFF CHARACTERISTICS

Collector–Emitter Breakdown Voltage ⁽¹⁾ ($I_C = -10 \text{ mAdc}, I_B = 0$)	$V_{(BR)CEO}$	–80	—	—	Vdc
Collector–Base Breakdown Voltage ($I_C = -100 \mu\text{Adc}, I_E = 0$)	$V_{(BR)CBO}$	–80	—	—	Vdc
Emitter–Base Breakdown Voltage ($I_E = -10 \mu\text{Adc}, I_C = 0$)	$V_{(BR)EBO}$	–4.0	—	—	Vdc
Collector Cutoff Current ($V_{CB} = -60 \text{ Vdc}, I_E = 0$)	I_{CBO}	—	—	–100	nAdc

ON CHARACTERISTICS*

DC Current Gain ($I_C = -10 \text{ mAdc}, V_{CE} = -2.0 \text{ Vdc}$) ($I_C = -100 \text{ mAdc}, V_{CE} = -2.0 \text{ Vdc}$) ($I_C = -1.0 \text{ Adc}, V_{CE} = -5.0 \text{ Vdc}$)	h_{FE}	40 60 100 15	— — 140 —	— 400 250 —	—
	BC490				
	BC490A				

1. Pulse Test: Pulse Width = 300 μs , Duty Cycle 2%.

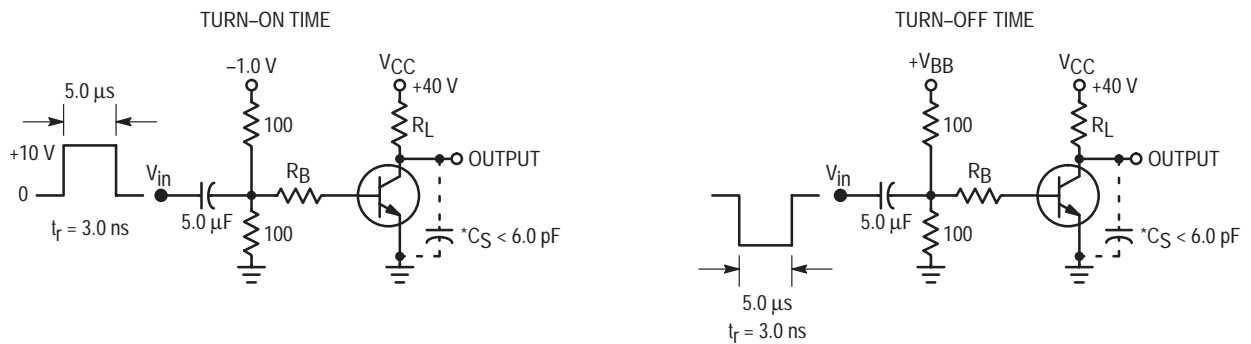
ELECTRICAL CHARACTERISTICS ($T_A = 25^\circ\text{C}$ unless otherwise noted) (Continued)

Characteristic	Symbol	Min	Min	Max	Unit
ON CHARACTERISTICS(1) (Continued)					
Collector–Emitter Saturation Voltage ($I_C = -500\text{ mA dc}$, $I_B = -50\text{ mA dc}$) ($I_C = -1.0\text{ A dc}$, $I_B = -100\text{ mA dc}$)	$V_{CE(sat)}$	—	-0.25	-0.5	Vdc
Base–Emitter Saturation Voltage ($I_C = -500\text{ mA dc}$, $I_B = -50\text{ mA dc}$) ($I_C = -1.0\text{ A dc}$, $I_B = -100\text{ mA dc}$)	$V_{BE(sat)}$	—	-0.9	-1.2	Vdc

DYNAMIC CHARACTERISTICS

Current–Gain — Bandwidth Product ($I_C = -50\text{ mA dc}$, $V_{CE} = -2.0\text{ Vdc}$, $f = 100\text{ MHz}$)	f_T	—	150	—	MHz
Output Capacitance ($V_{CB} = -10\text{ Vdc}$, $I_E = 0$, $f = 1.0\text{ MHz}$)	C_{ob}	—	9.0	—	pF
Input Capacitance ($V_{EB} = -0.5\text{ Vdc}$, $I_C = 0$, $f = 1.0\text{ MHz}$)	C_{ib}	—	110	—	pF

1. Pulse Test: Pulse Width = 300 μs , Duty Cycle 2%.



* Total Shunt Capacitance of Test Jig and Connectors
For PNP Test Circuits, Reverse All Voltage Polarities

Figure 1. Switching Time Test Circuits

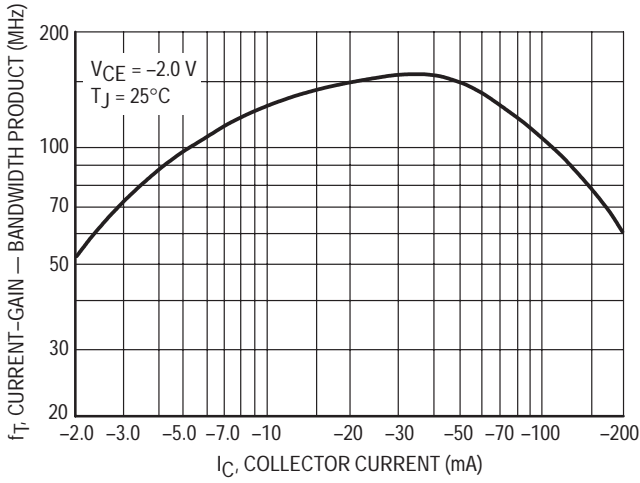


Figure 2. Current-Gain — Bandwidth Product

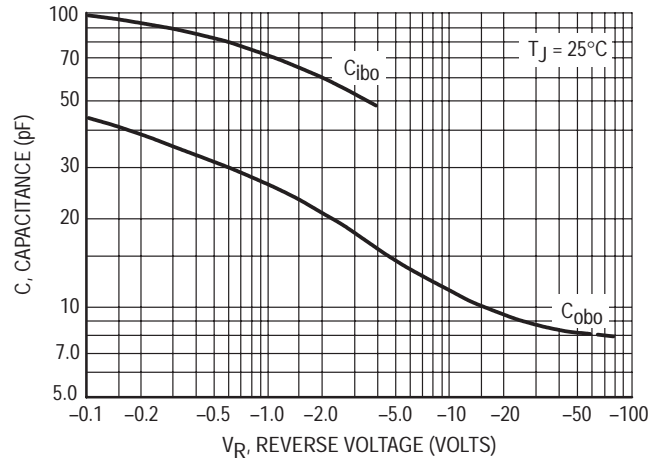


Figure 3. Capacitance

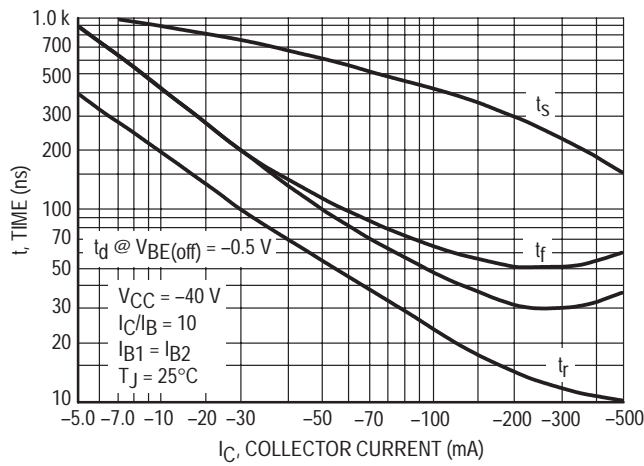


Figure 4. Switching Time

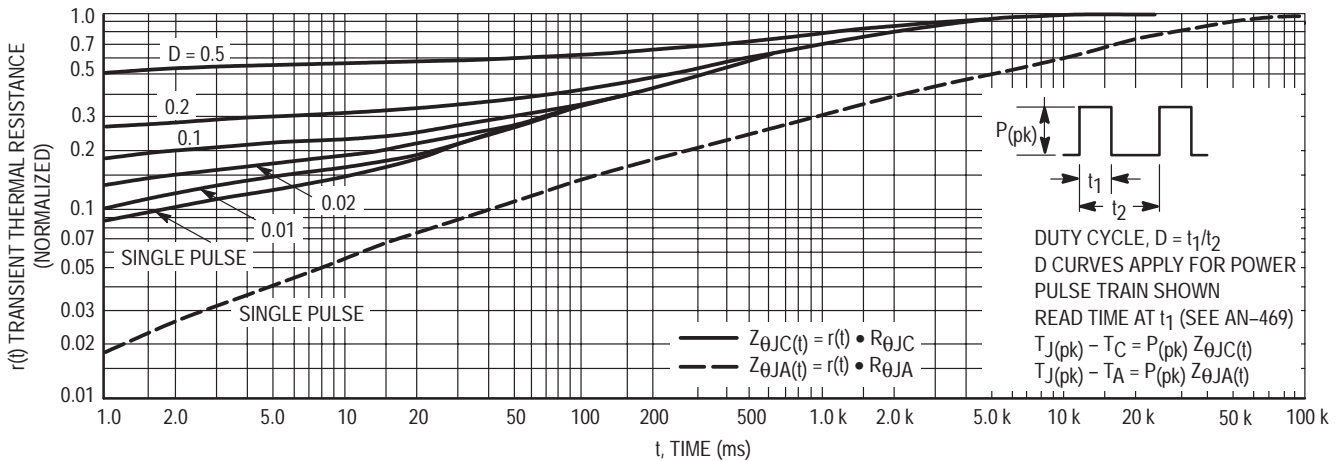


Figure 5. Thermal Response

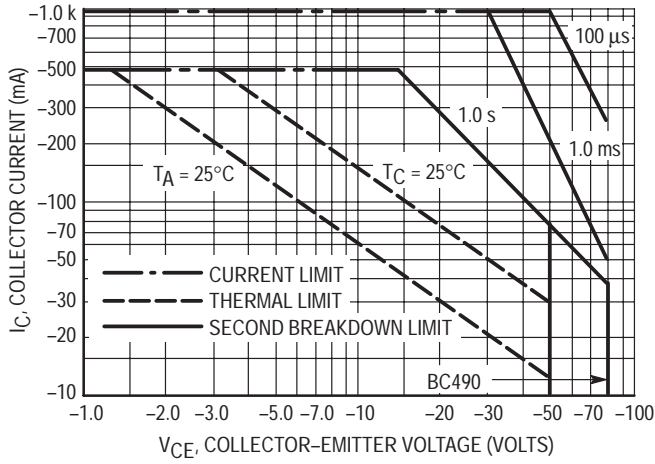


Figure 6. Active Region, Safe Operating Area

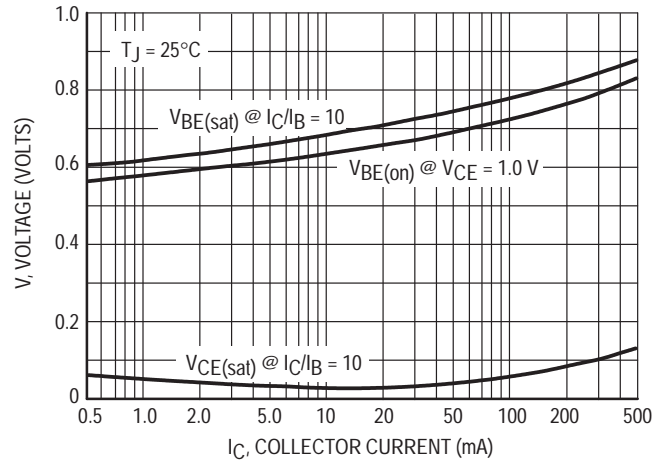


Figure 7. "On" Voltages

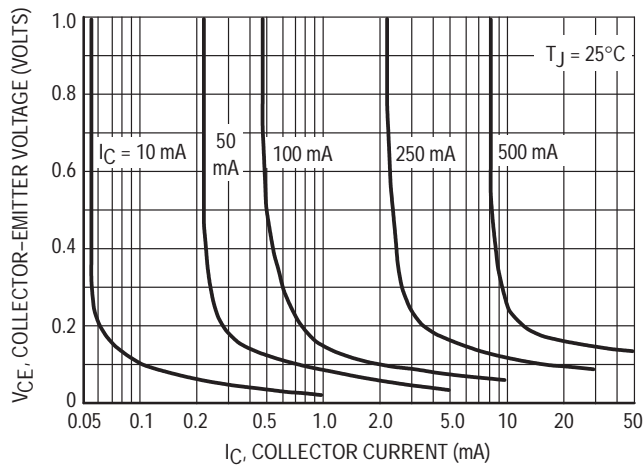


Figure 8. Collector Saturation Region

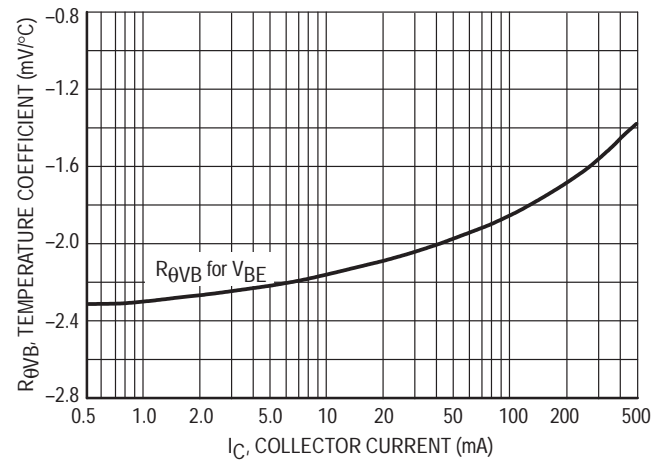


Figure 9. Base-Emitter Temperature Coefficient

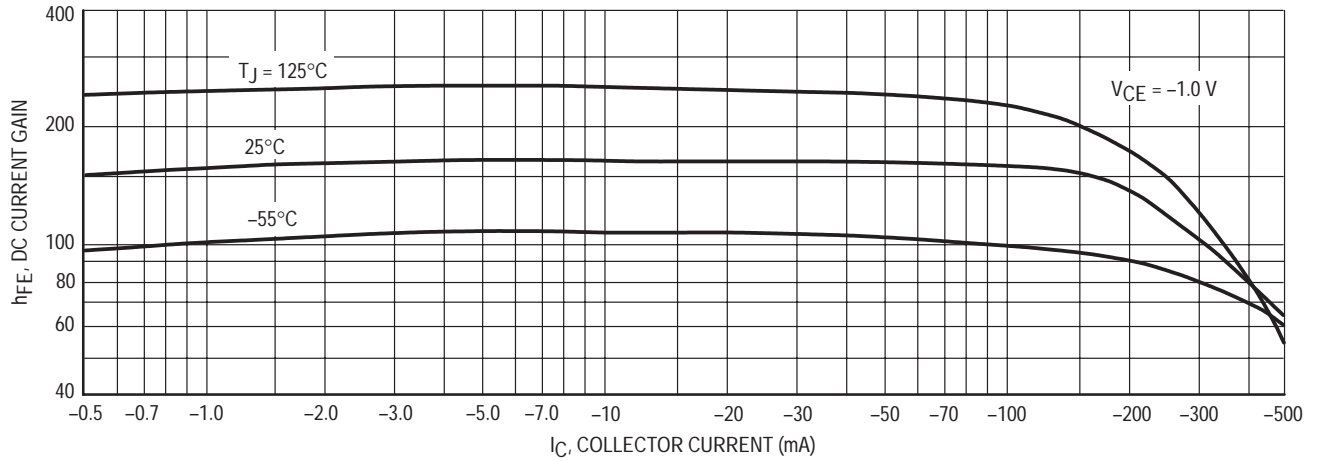


Figure 10. DC Current Gain

BC490,A

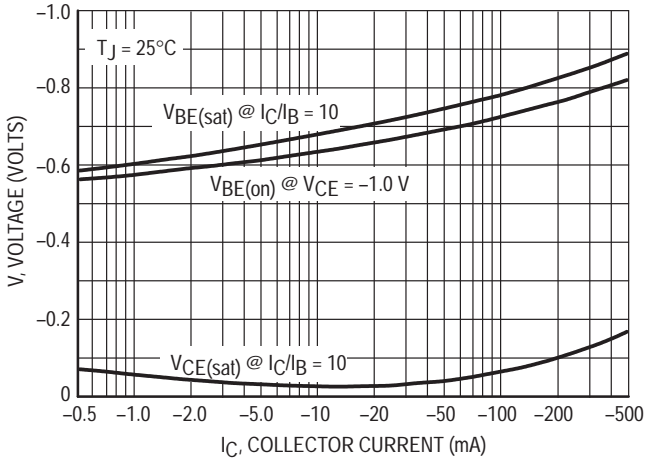


Figure 11. "On" Voltages

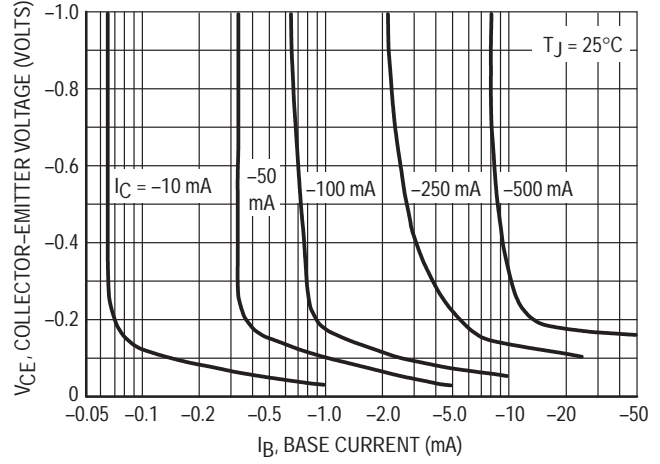


Figure 12. Collector Saturation Region

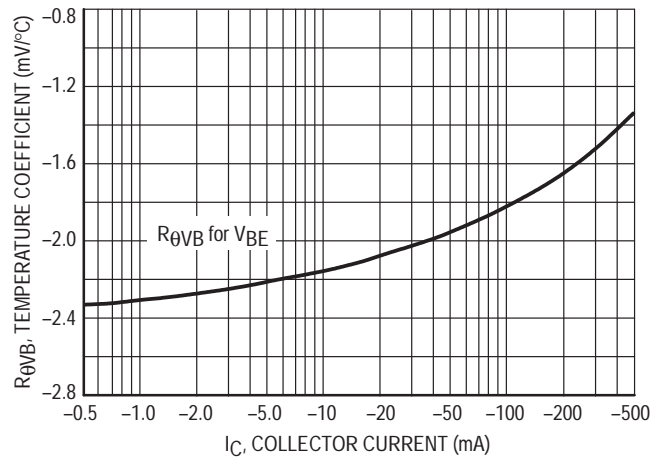
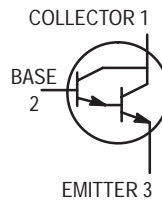


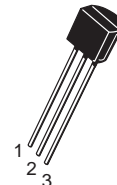
Figure 13. Base-Emitter Temperature Coefficient

Darlington Transistors

NPN Silicon



BC517



CASE 29-04, STYLE 17
TO-92 (TO-226AA)

MAXIMUM RATINGS

Rating	Symbol	Value	Unit
Collector–Emitter Voltage	V_{CES}	30	Vdc
Collector–Base Voltage	V_{CB}	40	Vdc
Emitter–Base Voltage	V_{EB}	10	Vdc
Collector Current — Continuous	I_C	1.0	Adc
Total Power Dissipation @ $T_A = 25^\circ\text{C}$ Derate above 25°C	P_D	625 12	mW mW/ $^\circ\text{C}$
Total Power Dissipation @ $T_C = 25^\circ\text{C}$ Derate above 25°C	P_D	1.5 12	Watts mW/ $^\circ\text{C}$
Operating and Storage Junction Temperature Range	T_J, T_{stg}	-55 to +150	$^\circ\text{C}$

THERMAL CHARACTERISTICS

Characteristic	Symbol	Max	Unit
Thermal Resistance, Junction to Ambient	$R_{\theta JA}$	200	$^\circ\text{C}/\text{W}$
Thermal Resistance, Junction to Case	$R_{\theta JC}$	83.3	$^\circ\text{C}/\text{W}$

ELECTRICAL CHARACTERISTICS ($T_A = 25^\circ\text{C}$ unless otherwise noted)

Characteristic	Symbol	Min	Typ	Max	Unit
----------------	--------	-----	-----	-----	------

OFF CHARACTERISTICS

Collector–Emitter Breakdown Voltage ($I_C = 2.0 \text{ mAdc}, V_{BE} = 0$)	$V_{(BR)CES}$	30	—	—	Vdc
Collector–Base Breakdown Voltage ($I_C = 10 \mu\text{Adc}, I_E = 0$)	$V_{(BR)CBO}$	40	—	—	Vdc
Emitter–Base Breakdown Voltage ($I_E = 100 \text{ nAdc}, I_C = 0$)	$V_{(BR)EBO}$	10	—	—	Vdc
Collector Cutoff Current ($V_{CE} = 30 \text{ Vdc}$)	I_{CES}	—	—	500	nAdc
Collector Cutoff Current ($V_{CB} = 30 \text{ Vdc}, I_E = 0$)	I_{CBO}	—	—	100	nAdc
Emitter Cutoff Current ($V_{EB} = 10 \text{ Vdc}, I_C = 0$)	I_{EBO}	—	—	100	nAdc

BC517

ELECTRICAL CHARACTERISTICS ($T_A = 25^\circ\text{C}$ unless otherwise noted) (Continued)

Characteristic	Symbol	Min	Typ	Max	Unit
ON CHARACTERISTICS(1)					
DC Current Gain ($I_C = 20 \text{ mA dc}$, $V_{CE} = 2.0 \text{ V dc}$)	h_{FE}	30,000	—	—	—
Collector–Emitter Saturation Voltage ($I_C = 100 \text{ mA dc}$, $I_B = 0.1 \text{ mA dc}$)	$V_{CE(sat)}$	—	—	1.0	Vdc
Base–Emitter On Voltage ($I_C = 10 \text{ mA dc}$, $V_{CE} = 5.0 \text{ V dc}$)	$V_{BE(on)}$	—	—	1.4	Vdc

SMALL–SIGNAL CHARACTERISTICS

Current–Gain — Bandwidth Product ⁽²⁾ ($I_C = 10 \text{ mA dc}$, $V_{CE} = 5.0 \text{ V dc}$, $f = 100 \text{ MHz}$)	f_T	—	200	—	MHz
---------------------------------------------------------------------------------------------------------------------------------------	-------	---	-----	---	-----

1. Pulse Test: Pulse Width $\leq 2.0\%$.
2. $f_T = |h_{fe}| \cdot f_{test}$

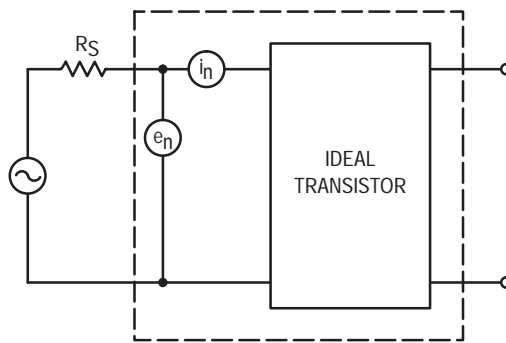


Figure 1. Transistor Noise Model

NOISE CHARACTERISTICS

($V_{CE} = 5.0 \text{ Vdc}$, $T_A = 25^\circ\text{C}$)

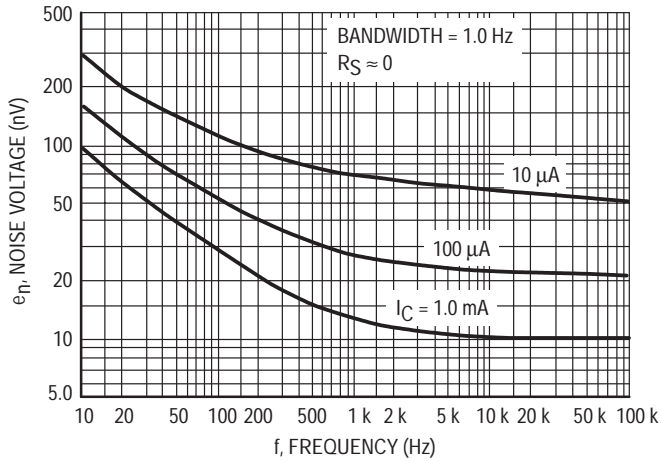


Figure 2. Noise Voltage

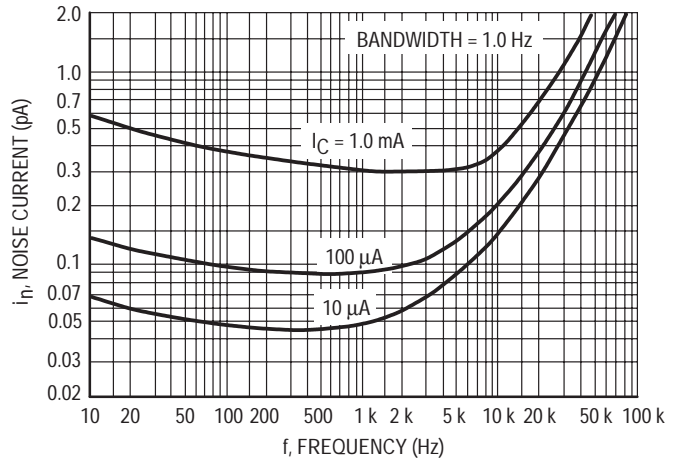


Figure 3. Noise Current

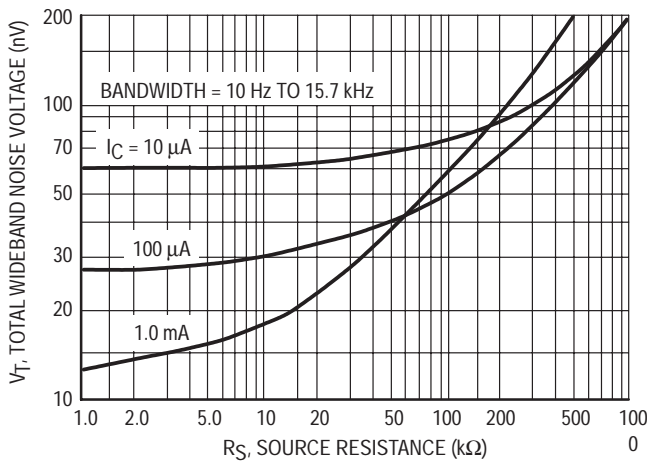


Figure 4. Total Wideband Noise Voltage

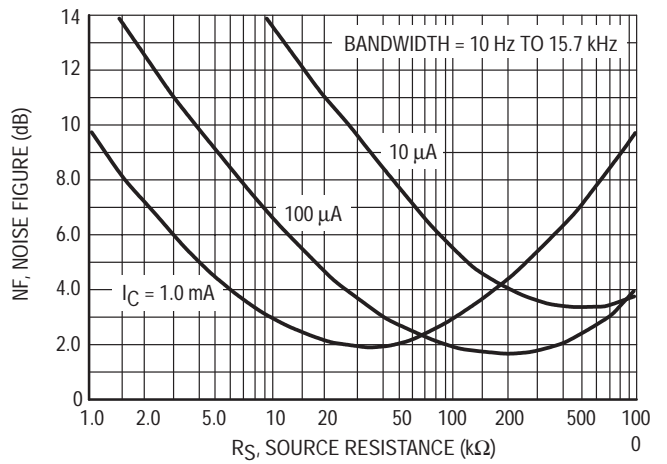


Figure 5. Wideband Noise Figure

SMALL-SIGNAL CHARACTERISTICS

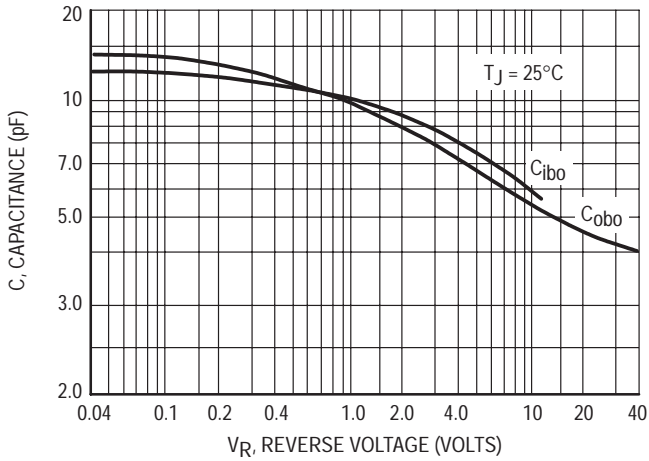


Figure 6. Capacitance

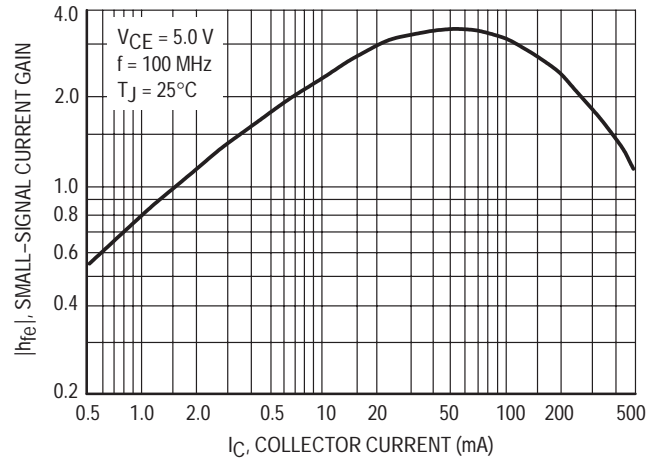


Figure 7. High Frequency Current Gain

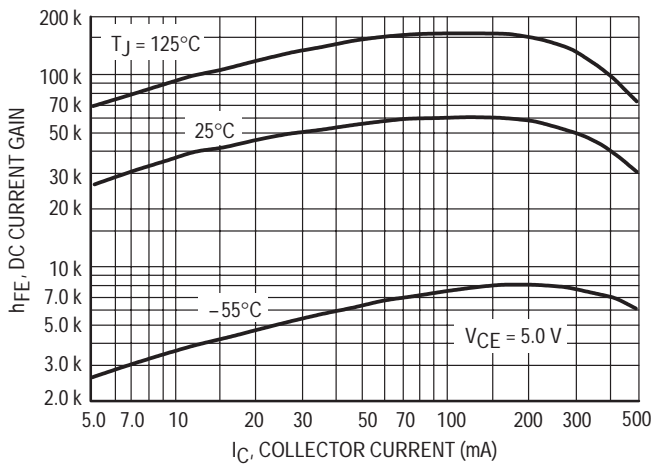


Figure 8. DC Current Gain

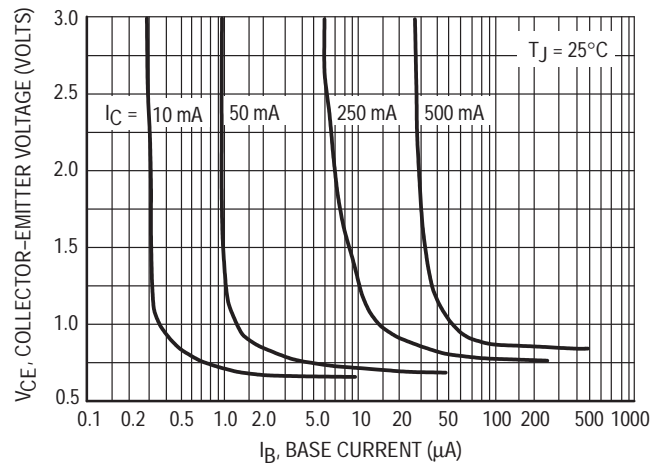


Figure 9. Collector Saturation Region

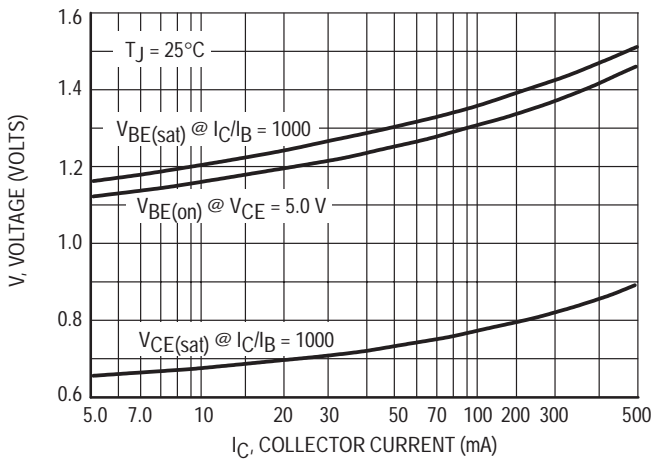


Figure 10. "On" Voltages

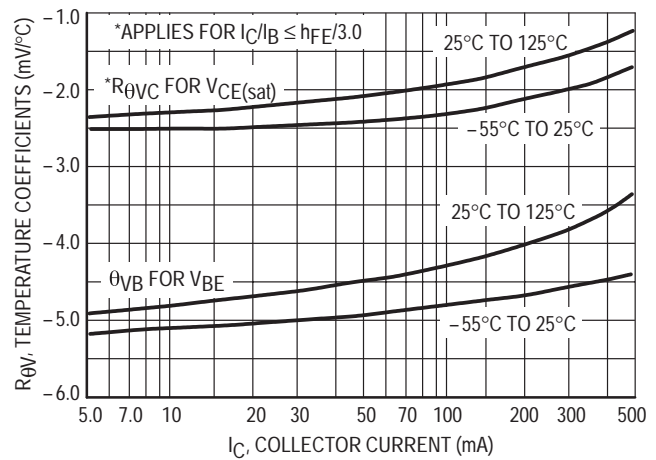


Figure 11. Temperature Coefficients

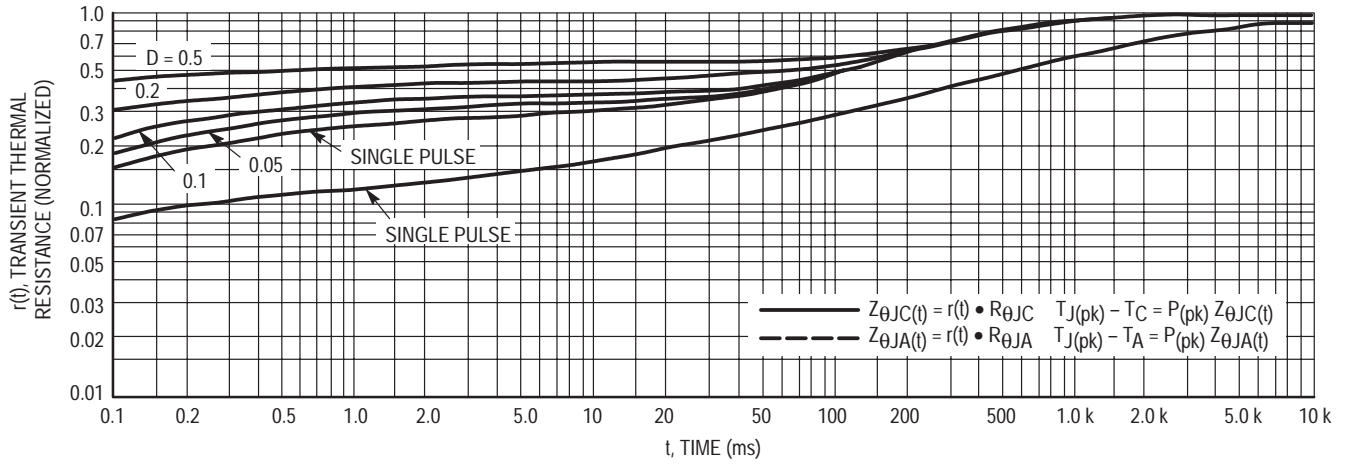


Figure 12. Thermal Response

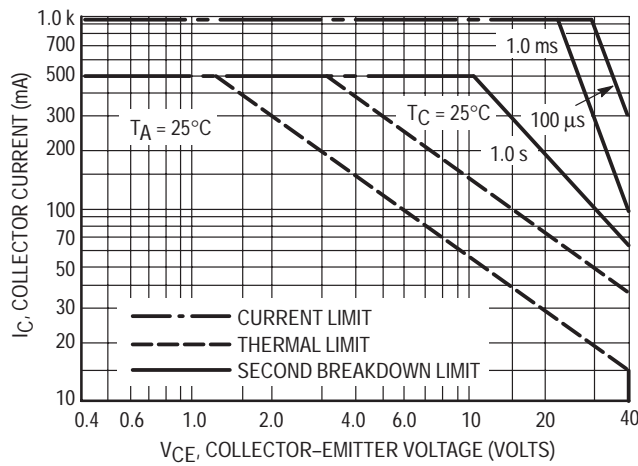
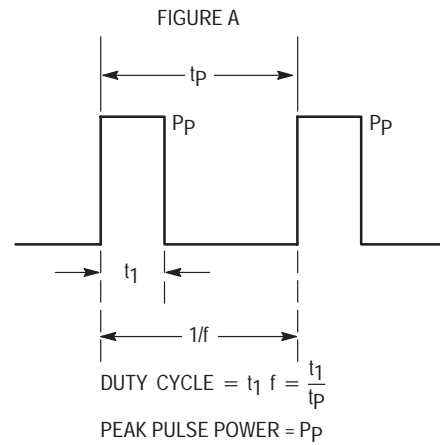


Figure 13. Active Region Safe Operating Area

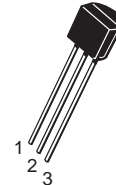
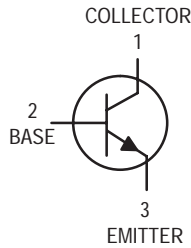


Design Note: Use of Transient Thermal Resistance Data

Amplifier Transistors

NPN Silicon

BC546, B
BC547, A, B, C
BC548, A, B, C



CASE 29-04, STYLE 17
TO-92 (TO-226AA)

MAXIMUM RATINGS

Rating	Symbol	BC546	BC547	BC548	Unit
Collector–Emitter Voltage	V_{CEO}	65	45	30	Vdc
Collector–Base Voltage	V_{CBO}	80	50	30	Vdc
Emitter–Base Voltage	V_{EBO}	6.0			Vdc
Collector Current — Continuous	I_C	100			mAdc
Total Device Dissipation @ $T_A = 25^\circ\text{C}$ Derate above 25°C	P_D	625			mW
		5.0			mW/ $^\circ\text{C}$
Total Device Dissipation @ $T_C = 25^\circ\text{C}$ Derate above 25°C	P_D	1.5			Watt
		12			mW/ $^\circ\text{C}$
Operating and Storage Junction Temperature Range	T_J, T_{stg}	–55 to +150			$^\circ\text{C}$

THERMAL CHARACTERISTICS

Characteristic	Symbol	Max	Unit
Thermal Resistance, Junction to Ambient	$R_{\theta JA}$	200	$^\circ\text{C}/\text{W}$
Thermal Resistance, Junction to Case	$R_{\theta JC}$	83.3	$^\circ\text{C}/\text{W}$

ELECTRICAL CHARACTERISTICS ($T_A = 25^\circ\text{C}$ unless otherwise noted)

Characteristic	Symbol	Min	Typ	Max	Unit
----------------	--------	-----	-----	-----	------

OFF CHARACTERISTICS

Collector–Emitter Breakdown Voltage ($I_C = 1.0 \text{ mA}, I_B = 0$)	BC546 BC547 BC548	$V_{(BR)CEO}$	65 45 30	— — —	— — —	V
Collector–Base Breakdown Voltage ($I_C = 100 \mu\text{Adc}$)	BC546 BC547 BC548	$V_{(BR)CBO}$	80 50 30	— — —	— — —	V
Emitter–Base Breakdown Voltage ($I_E = 10 \mu\text{A}, I_C = 0$)	BC546 BC547 BC548	$V_{(BR)EBO}$	6.0 6.0 6.0	— — —	— — —	V
Collector Cutoff Current ($V_{CE} = 70 \text{ V}, V_{BE} = 0$) ($V_{CE} = 50 \text{ V}, V_{BE} = 0$) ($V_{CE} = 35 \text{ V}, V_{BE} = 0$) ($V_{CE} = 30 \text{ V}, T_A = 125^\circ\text{C}$)	BC546 BC547 BC548 BC546/547/548	I_{CES}	— — — —	0.2 0.2 0.2 —	15 15 15 4.0	nA μA

ELECTRICAL CHARACTERISTICS ($T_A = 25^\circ\text{C}$ unless otherwise noted) (Continued)

Characteristic	Symbol	Min	Typ	Max	Unit
ON CHARACTERISTICS					
DC Current Gain ($I_C = 10\ \mu\text{A}$, $V_{CE} = 5.0\ \text{V}$)	BC547A/548A BC546B/547B/548B BC548C	h_{FE}	— — —	90 150 270	— — —
($I_C = 2.0\ \text{mA}$, $V_{CE} = 5.0\ \text{V}$)	BC546 BC547 BC548 BC547A/548A BC546B/547B/548B BC547C/BC548C		110 110 110 110 200 420	— — — 180 290 520	450 800 800 220 450 800
($I_C = 100\ \text{mA}$, $V_{CE} = 5.0\ \text{V}$)	BC547A/548A BC546B/547B/548B BC548C		— — —	120 180 300	— — —
Collector–Emitter Saturation Voltage ($I_C = 10\ \text{mA}$, $I_B = 0.5\ \text{mA}$) ($I_C = 100\ \text{mA}$, $I_B = 5.0\ \text{mA}$) ($I_C = 10\ \text{mA}$, $I_B = \text{See Note 1}$)	$V_{CE(\text{sat})}$		— — —	0.09 0.2 0.3	0.25 0.6 0.6
Base–Emitter Saturation Voltage ($I_C = 10\ \text{mA}$, $I_B = 0.5\ \text{mA}$)	$V_{BE(\text{sat})}$		—	0.7	—
Base–Emitter On Voltage ($I_C = 2.0\ \text{mA}$, $V_{CE} = 5.0\ \text{V}$) ($I_C = 10\ \text{mA}$, $V_{CE} = 5.0\ \text{V}$)	$V_{BE(\text{on})}$		0.55 —	— —	0.7 0.77

SMALL–SIGNAL CHARACTERISTICS

Current–Gain — Bandwidth Product ($I_C = 10\ \text{mA}$, $V_{CE} = 5.0\ \text{V}$, $f = 100\ \text{MHz}$)	BC546 BC547 BC548	f_T	150 150 150	300 300 300	— — —	MHz
Output Capacitance ($V_{CB} = 10\ \text{V}$, $I_C = 0$, $f = 1.0\ \text{MHz}$)		C_{obo}	—	1.7	4.5	pF
Input Capacitance ($V_{EB} = 0.5\ \text{V}$, $I_C = 0$, $f = 1.0\ \text{MHz}$)		C_{ibo}	—	10	—	pF
Small–Signal Current Gain ($I_C = 2.0\ \text{mA}$, $V_{CE} = 5.0\ \text{V}$, $f = 1.0\ \text{kHz}$)	BC546 BC547/548 BC547A/548A BC546B/547B/548B BC547C/548C	h_{fe}	125 125 125 240 450	— — 220 330 600	500 900 260 500 900	—
Noise Figure ($I_C = 0.2\ \text{mA}$, $V_{CE} = 5.0\ \text{V}$, $R_S = 2\ \text{k}\Omega$, $f = 1.0\ \text{kHz}$, $\Delta f = 200\ \text{Hz}$)	BC546 BC547 BC548	NF	— — —	2.0 2.0 2.0	10 10 10	dB

 Note 1: I_B is value for which $I_C = 11\ \text{mA}$ at $V_{CE} = 1.0\ \text{V}$.

BC546, B BC547, A, B, C BC548, A, B, C

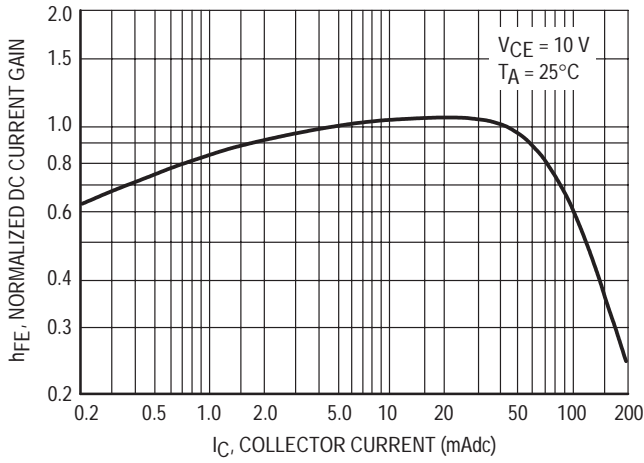


Figure 1. Normalized DC Current Gain

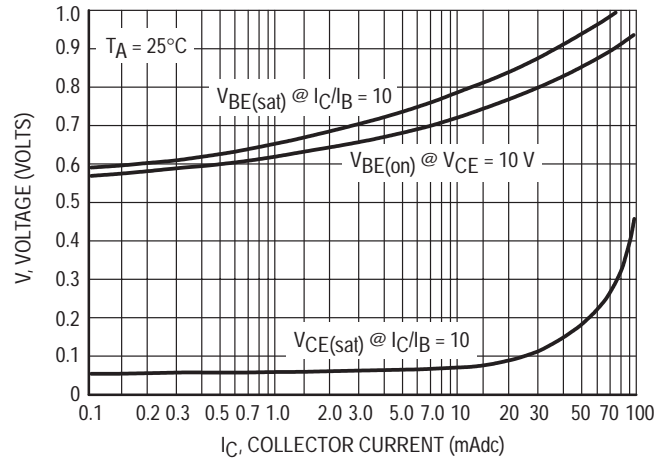


Figure 2. "Saturation" and "On" Voltages

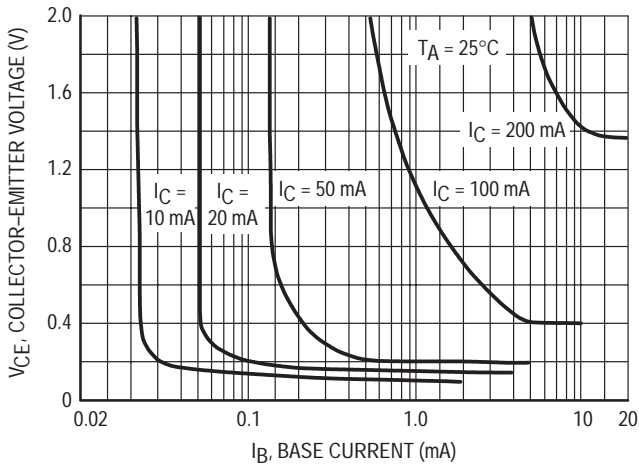


Figure 3. Collector Saturation Region

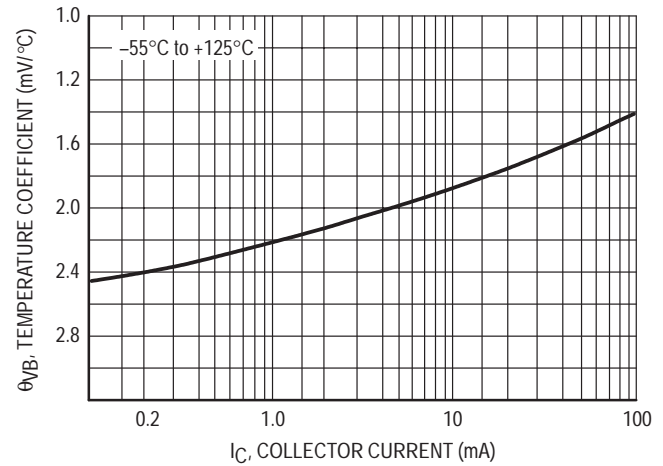


Figure 4. Base-Emitter Temperature Coefficient

BC547/BC548

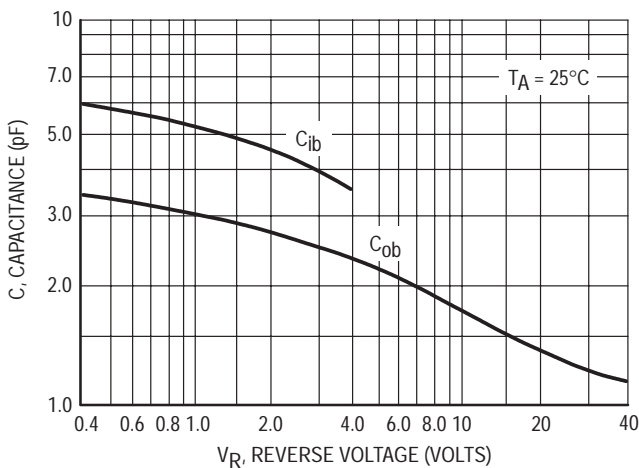


Figure 5. Capacitances

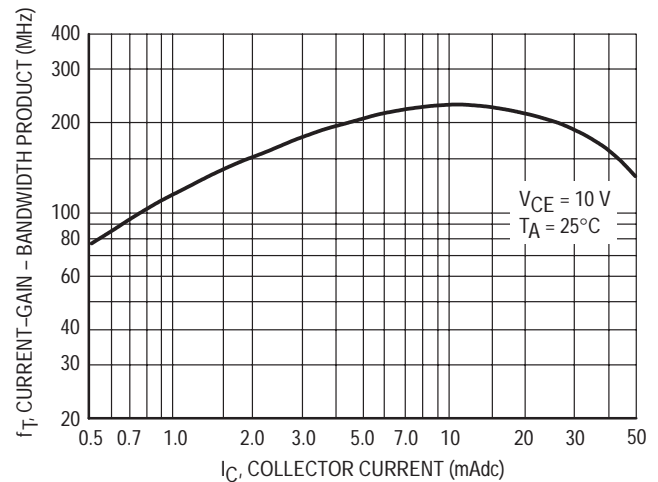


Figure 6. Current-Gain - Bandwidth Product

BC547/BC548

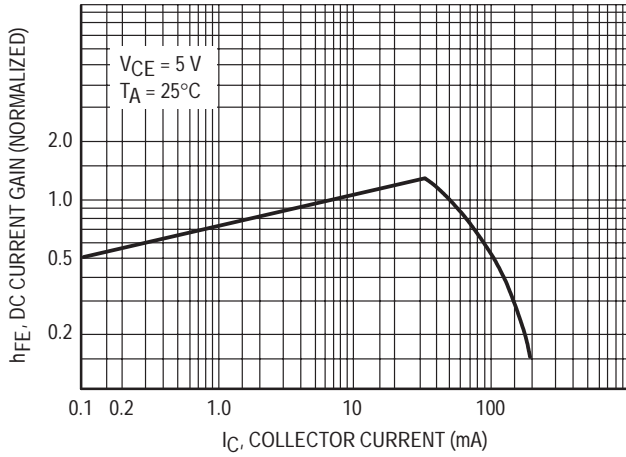


Figure 7. DC Current Gain

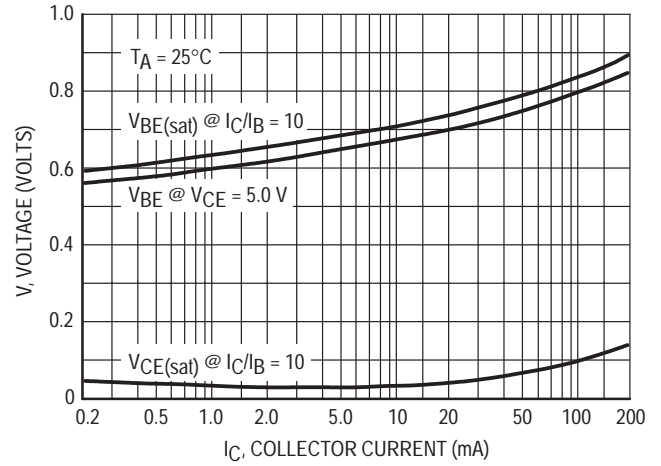


Figure 8. "On" Voltage

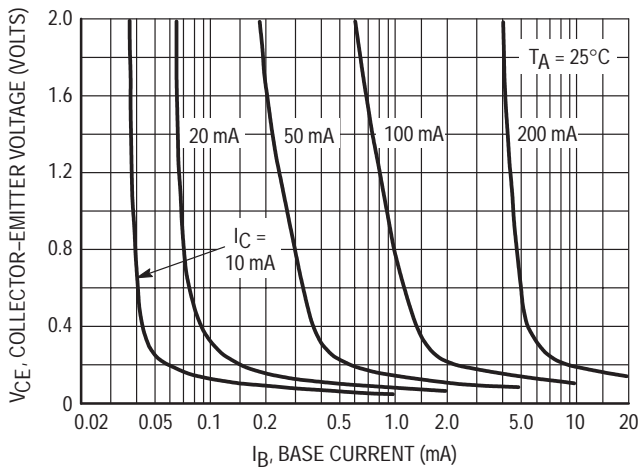


Figure 9. Collector Saturation Region

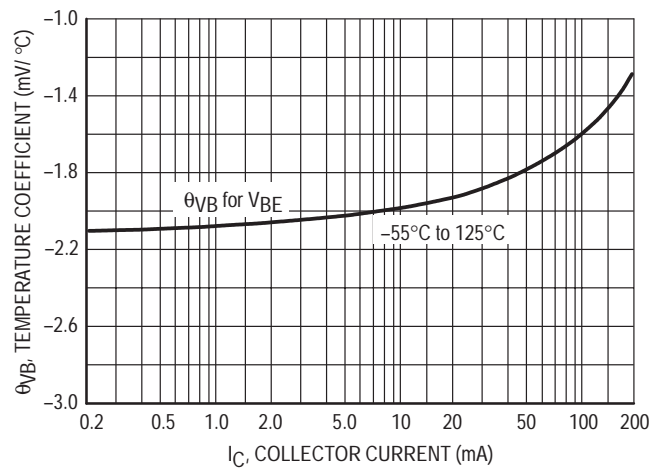


Figure 10. Base-Emitter Temperature Coefficient

BC546

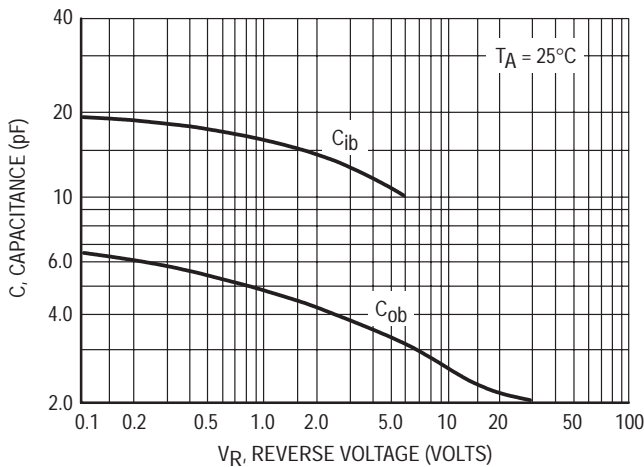


Figure 11. Capacitance

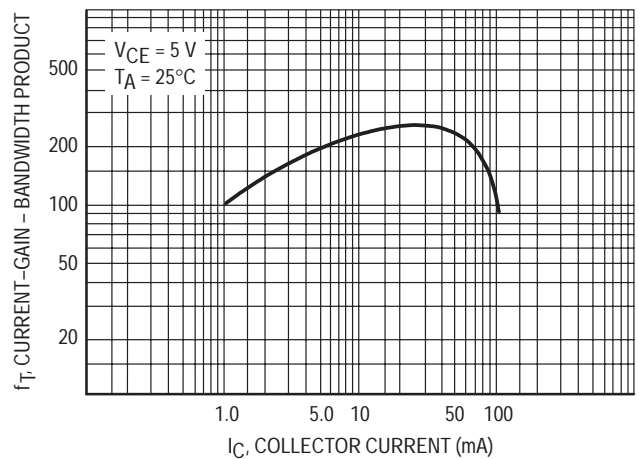
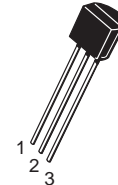
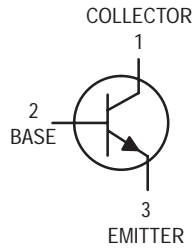


Figure 12. Current-Gain - Bandwidth Product

Low Noise Transistors

NPN Silicon

BC549B,C
BC550B,C



CASE 29-04, STYLE 17
TO-92 (TO-226AA)

MAXIMUM RATINGS

Rating	Symbol	BC549	BC550	Unit
Collector–Emitter Voltage	V_{CEO}	30	45	Vdc
Collector–Base Voltage	V_{CBO}	30	50	Vdc
Emitter–Base Voltage	V_{EBO}	5.0		Vdc
Collector Current — Continuous	I_C	100		mAdc
Total Device Dissipation @ $T_A = 25^\circ\text{C}$ Derate above 25°C	P_D	625	5.0	mW mW/°C
Total Device Dissipation @ $T_C = 25^\circ\text{C}$ Derate above 25°C	P_D	1.5	12	Watt mW/°C
Operating and Storage Junction Temperature Range	T_J, T_{stg}	–55 to +150		°C

THERMAL CHARACTERISTICS

Characteristic	Symbol	Max	Unit
Thermal Resistance, Junction to Ambient	$R_{\theta JA}$	200	°C/W
Thermal Resistance, Junction to Case	$R_{\theta JC}$	83.3	°C/W

ELECTRICAL CHARACTERISTICS ($T_A = 25^\circ\text{C}$ unless otherwise noted)

Characteristic	Symbol	Min	Typ	Max	Unit
----------------	--------	-----	-----	-----	------

OFF CHARACTERISTICS

Collector–Emitter Breakdown Voltage ($I_C = 10\text{ mAdc}, I_B = 0$)	BC549B,C BC550B,C	$V_{(BR)CEO}$	30 45	— —	— —	Vdc
Collector–Base Breakdown Voltage ($I_C = 10\text{ }\mu\text{Adc}, I_E = 0$)	BC549B,C BC550B,C	$V_{(BR)CBO}$	30 50	— —	— —	Vdc
Emitter–Base Breakdown Voltage ($I_E = 10\text{ }\mu\text{Adc}, I_C = 0$)		$V_{(BR)EBO}$	5.0	—	—	Vdc
Collector Cutoff Current ($V_{CB} = 30\text{ V}, I_E = 0$) ($V_{CB} = 30\text{ V}, I_E = 0, T_A = +125^\circ\text{C}$)		I_{CBO}	— —	— —	15 5.0	nAdc μAdc
Emitter Cutoff Current ($V_{EB} = 4.0\text{ Vdc}, I_C = 0$)		I_{EBO}	—	—	15	nAdc

ELECTRICAL CHARACTERISTICS ($T_A = 25^\circ\text{C}$ unless otherwise noted) (Continued)

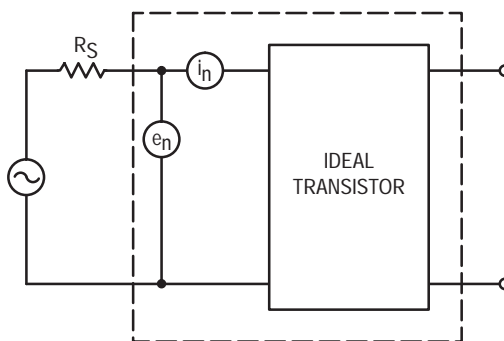
Characteristic	Symbol	Min	Typ	Max	Unit
ON CHARACTERISTICS					
DC Current Gain ($I_C = 10\ \mu\text{A}$, $V_{CE} = 5.0\ \text{Vdc}$)	h_{FE}	100	150	—	—
BC549B/550B		100	270	—	—
($I_C = 2.0\ \text{mA}$, $V_{CE} = 5.0\ \text{Vdc}$)		200	290	450	—
BC549B/550B		420	500	800	—
BC549C/550C					
Collector–Emitter Saturation Voltage ($I_C = 10\ \text{mA}$, $I_B = 0.5\ \text{mA}$)	$V_{CE(\text{sat})}$	—	0.075	0.25	Vdc
($I_C = 10\ \text{mA}$, $I_B = \text{see note 1}$)		—	0.3	0.6	
($I_C = 100\ \text{mA}$, $I_B = 5.0\ \text{mA}$, see note 2)		—	0.25	0.6	
Base–Emitter Saturation Voltage ($I_C = 100\ \text{mA}$, $I_B = 5.0\ \text{mA}$)	$V_{BE(\text{sat})}$	—	1.1	—	Vdc
Base–Emitter On Voltage ($I_C = 10\ \mu\text{A}$, $V_{CE} = 5.0\ \text{Vdc}$)	$V_{BE(\text{on})}$	—	0.52	—	Vdc
($I_C = 100\ \mu\text{A}$, $V_{CE} = 5.0\ \text{Vdc}$)		—	0.55	—	
($I_C = 2.0\ \text{mA}$, $V_{CE} = 5.0\ \text{Vdc}$)		0.55	0.62	0.7	

SMALL–SIGNAL CHARACTERISTICS

Current–Gain — Bandwidth Product ($I_C = 10\ \text{mA}$, $V_{CE} = 5.0\ \text{Vdc}$, $f = 100\ \text{MHz}$)	f_T	—	250	—	MHz
Collector–Base Capacitance ($V_{CB} = 10\ \text{Vdc}$, $I_E = 0$, $f = 1.0\ \text{MHz}$)	C_{cbo}	—	2.5	—	pF
Small–Signal Current Gain ($I_C = 2.0\ \text{mA}$, $V_{CE} = 5.0\ \text{V}$, $f = 1.0\ \text{kHz}$)	h_{fe}	240	330	500	—
BC549B/BC550B		450	600	900	—
BC549C/BC550C					
Noise Figure ($I_C = 200\ \mu\text{A}$, $V_{CE} = 5.0\ \text{Vdc}$, $R_S = 2.0\ \text{k}\Omega$, $f = 1.0\ \text{kHz}$)	NF_1 NF_2	—	0.6	2.5	dB
($I_C = 200\ \mu\text{A}$, $V_{CE} = 5.0\ \text{Vdc}$, $R_S = 100\ \text{k}\Omega$, $f = 1.0\ \text{kHz}$)		—	—	10	

NOTES:

- I_B is value for which $I_C = 11\ \text{mA}$ at $V_{CE} = 1.0\ \text{V}$.
- Pulse test = $300\ \mu\text{s}$ – Duty cycle = 2%.


Figure 1. Transistor Noise Model

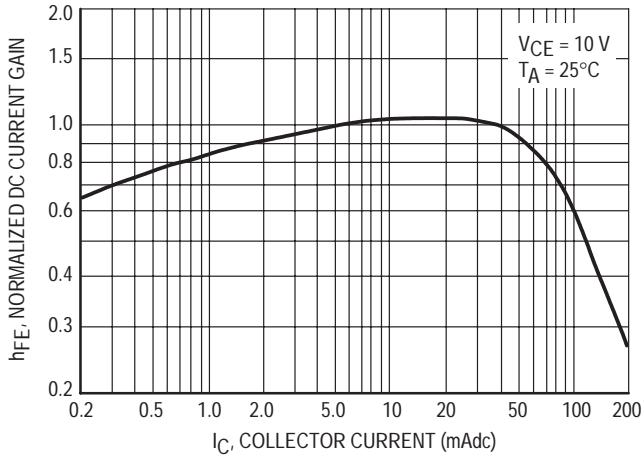


Figure 2. Normalized DC Current Gain

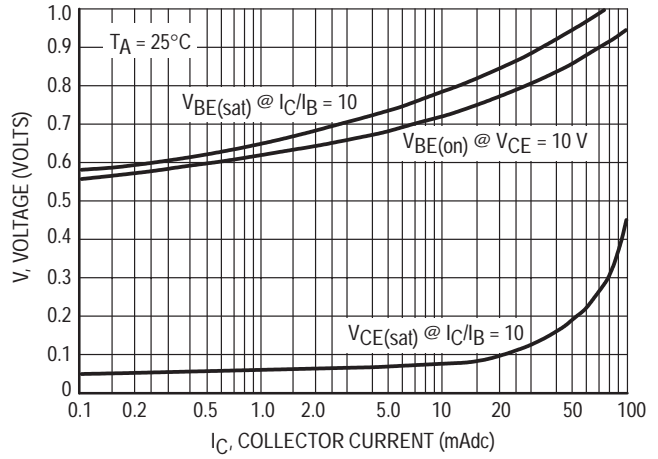


Figure 3. "Saturation" and "On" Voltages

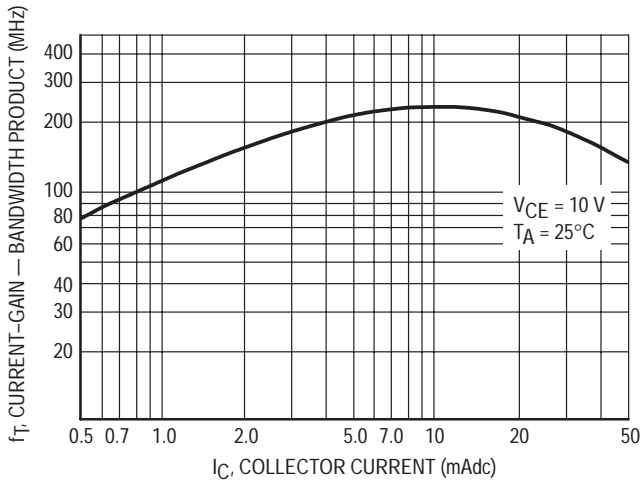


Figure 4. Current-Gain — Bandwidth Product

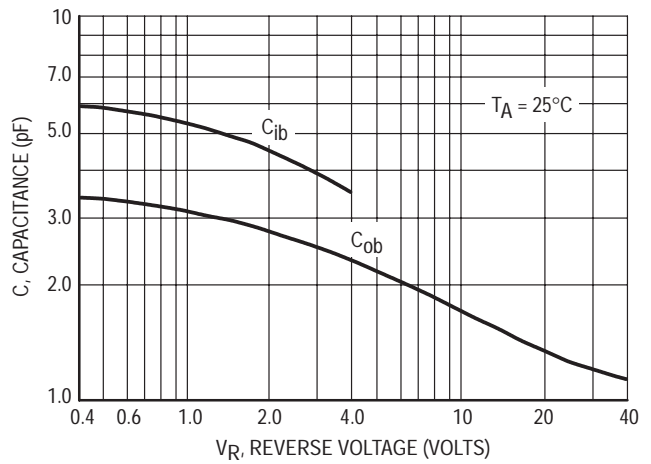


Figure 5. Capacitance

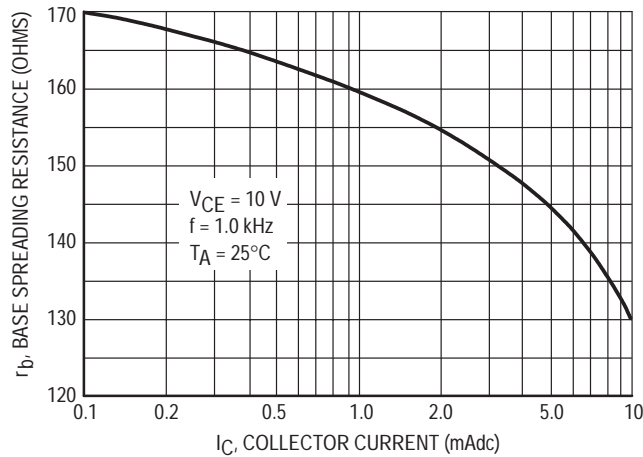
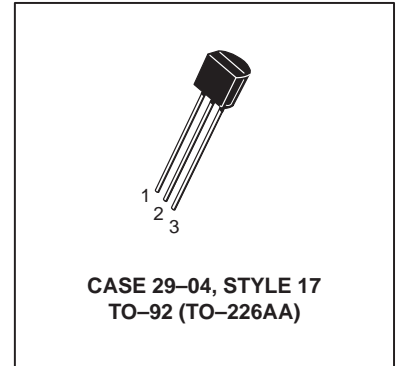
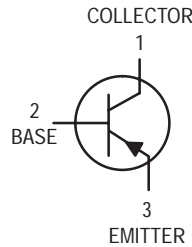


Figure 6. Base Spreading Resistance

Amplifier Transistors

PNP Silicon

BC556,B
BC557,A,B,C
BC558B



MAXIMUM RATINGS

Rating	Symbol	BC556	BC557	BC558	Unit
Collector–Emitter Voltage	V_{CEO}	-65	-45	-30	Vdc
Collector–Base Voltage	V_{CBO}	-80	-50	-30	Vdc
Emitter–Base Voltage	V_{EBO}	-5.0			Vdc
Collector Current — Continuous	I_C	-100			mAdc
Total Device Dissipation @ $T_A = 25^\circ\text{C}$ Derate above 25°C	P_D	625 5.0			mW mW/ $^\circ\text{C}$
Total Device Dissipation @ $T_C = 25^\circ\text{C}$ Derate above 25°C	P_D	1.5 12			Watt mW/ $^\circ\text{C}$
Operating and Storage Junction Temperature Range	T_J, T_{stg}	-55 to +150			$^\circ\text{C}$

THERMAL CHARACTERISTICS

Characteristic	Symbol	Max	Unit
Thermal Resistance, Junction to Ambient	$R_{\theta JA}$	200	$^\circ\text{C}/\text{W}$
Thermal Resistance, Junction to Case	$R_{\theta JC}$	83.3	$^\circ\text{C}/\text{W}$

ELECTRICAL CHARACTERISTICS ($T_A = 25^\circ\text{C}$ unless otherwise noted)

Characteristic	Symbol	Min	Typ	Max	Unit
----------------	--------	-----	-----	-----	------

OFF CHARACTERISTICS

Collector–Emitter Breakdown Voltage ($I_C = -2.0$ mAdc, $I_B = 0$)	BC556 BC557 BC558	$V_{(BR)CEO}$	-65 -45 -30	— — —	— — —	V
Collector–Base Breakdown Voltage ($I_C = -100$ μ Adc)	BC556 BC557 BC558	$V_{(BR)CBO}$	-80 -50 -30	— — —	— — —	V
Emitter–Base Breakdown Voltage ($I_E = -100$ μ Adc, $I_C = 0$)	BC556 BC557 BC558	$V_{(BR)EBO}$	-5.0 -5.0 -5.0	— — —	— — —	V
Collector–Emitter Leakage Current ($V_{CES} = -40$ V) ($V_{CES} = -20$ V)	BC556 BC557 BC558	I_{CES}	— — —	-2.0 -2.0 -2.0	-100 -100 -100	nA
($V_{CES} = -20$ V, $T_A = 125^\circ\text{C}$)	BC556 BC557 BC558		— — —	— — —	-4.0 -4.0 -4.0	μ A

BC556,B BC557,A,B,C BC558B
ELECTRICAL CHARACTERISTICS ($T_A = 25^\circ\text{C}$ unless otherwise noted) (Continued)

Characteristic	Symbol	Min	Typ	Max	Unit
ON CHARACTERISTICS					
DC Current Gain ($I_C = -10 \mu\text{Adc}$, $V_{CE} = -5.0 \text{ V}$)	h_{FE}	—	90	—	—
BC557A		—	150	—	—
BC556B/557B/558B BC557C		—	270	—	—
($I_C = -2.0 \text{ mAdc}$, $V_{CE} = -5.0 \text{ V}$)	h_{FE}	120	—	500	—
BC556		120	—	800	—
BC557		120	—	800	—
BC558		120	170	220	—
BC557A		180	290	460	—
BC556B/557B/558B BC557C		420	500	800	—
($I_C = -100 \text{ mAdc}$, $V_{CE} = -5.0 \text{ V}$)	h_{FE}	—	120	—	—
BC557A		—	180	—	—
BC556B/557B/558B		—	300	—	—
BC557C		—	—	—	—
Collector–Emitter Saturation Voltage ($I_C = -10 \text{ mAdc}$, $I_B = -0.5 \text{ mAdc}$) ($I_C = -10 \text{ mAdc}$, $I_B = \text{see Note 1}$) ($I_C = -100 \text{ mAdc}$, $I_B = -5.0 \text{ mAdc}$)	$V_{CE(\text{sat})}$	—	-0.075	-0.3	V
		—	-0.3	-0.6	
		—	-0.25	-0.65	
Base–Emitter Saturation Voltage ($I_C = -10 \text{ mAdc}$, $I_B = -0.5 \text{ mAdc}$) ($I_C = -100 \text{ mAdc}$, $I_B = -5.0 \text{ mAdc}$)	$V_{BE(\text{sat})}$	—	-0.7	—	V
		—	-1.0	—	
Base–Emitter On Voltage ($I_C = -2.0 \text{ mAdc}$, $V_{CE} = -5.0 \text{ Vdc}$) ($I_C = -10 \text{ mAdc}$, $V_{CE} = -5.0 \text{ Vdc}$)	$V_{BE(\text{on})}$	-0.55	-0.62	-0.7	V
		—	-0.7	-0.82	

SMALL–SIGNAL CHARACTERISTICS

Current–Gain — Bandwidth Product ($I_C = -10 \text{ mA}$, $V_{CE} = -5.0 \text{ V}$, $f = 100 \text{ MHz}$)	f_T	—	280	—	MHz
BC556		—	320	—	
BC557 BC558		—	360	—	
Output Capacitance ($V_{CB} = -10 \text{ V}$, $I_C = 0$, $f = 1.0 \text{ MHz}$)	C_{ob}	—	3.0	6.0	pF
Noise Figure ($I_C = -0.2 \text{ mAdc}$, $V_{CE} = -5.0 \text{ V}$, $R_S = 2.0 \text{ k}\Omega$, $f = 1.0 \text{ kHz}$, $\Delta f = 200 \text{ Hz}$)	NF	—	2.0	10	dB
BC556		—	2.0	10	
BC557 BC558		—	2.0	10	
Small–Signal Current Gain ($I_C = -2.0 \text{ mAdc}$, $V_{CE} = -5.0 \text{ V}$, $f = 1.0 \text{ kHz}$)	h_{fe}	125	—	500	—
BC556		125	—	900	
BC557/558		125	220	260	
BC557A		240	330	500	
BC556B/557B/558B BC557C		450	600	900	

Note 1: $I_C = -10 \text{ mAdc}$ on the constant base current characteristics, which yields the point $I_C = -11 \text{ mAdc}$, $V_{CE} = -1.0 \text{ V}$.

BC557/BC558

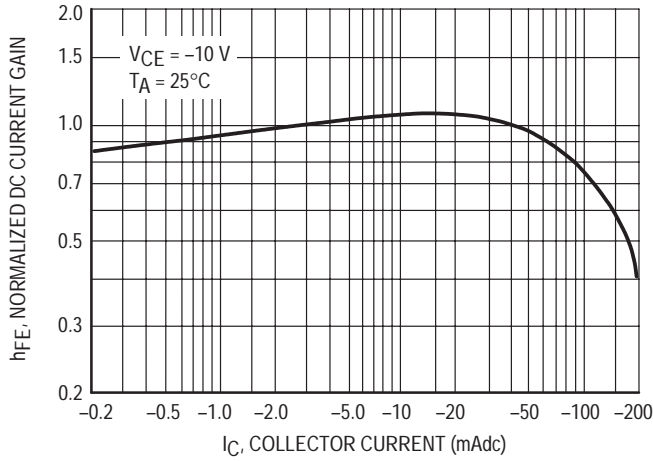


Figure 1. Normalized DC Current Gain

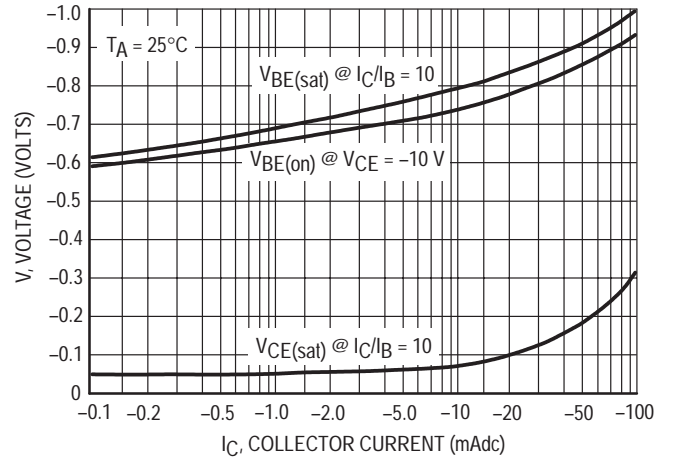


Figure 2. "Saturation" and "On" Voltages

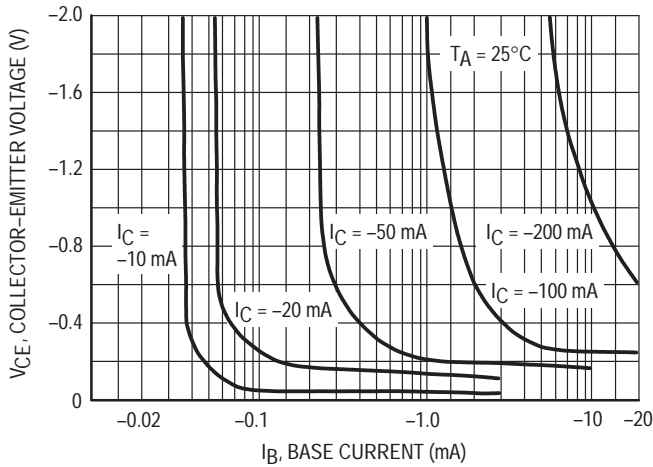


Figure 3. Collector Saturation Region

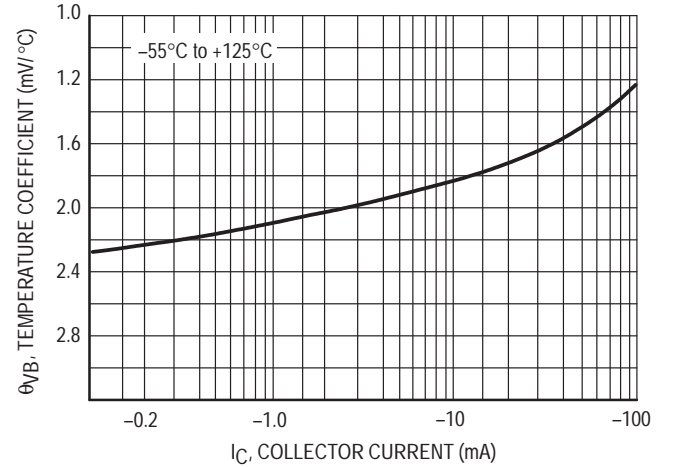


Figure 4. Base-Emitter Temperature Coefficient

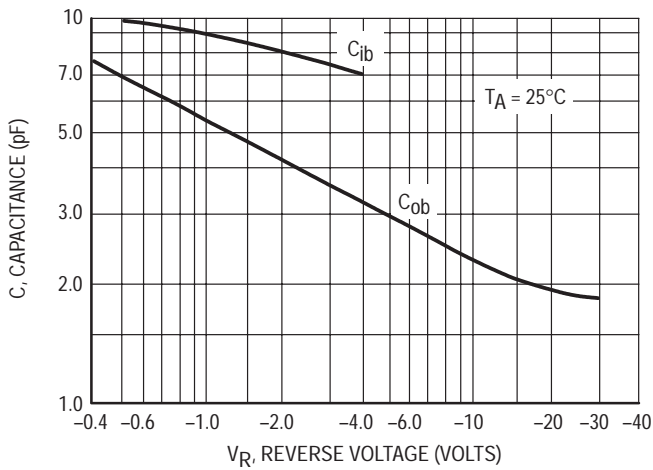


Figure 5. Capacitances

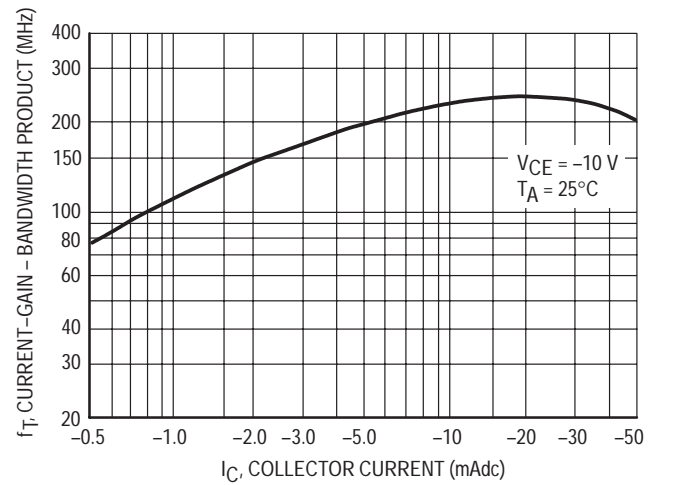


Figure 6. Current-Gain - Bandwidth Product

BC556

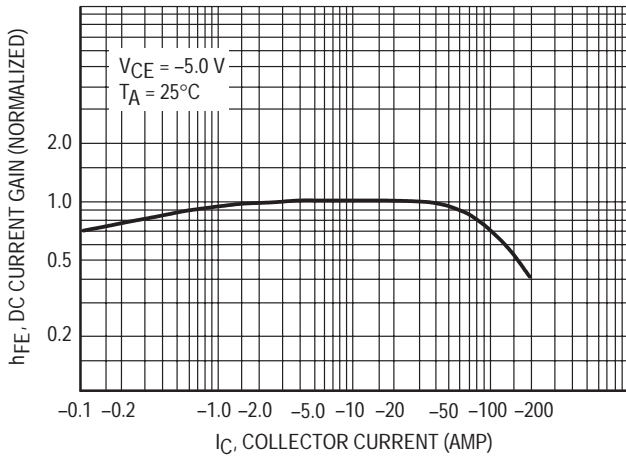


Figure 7. DC Current Gain

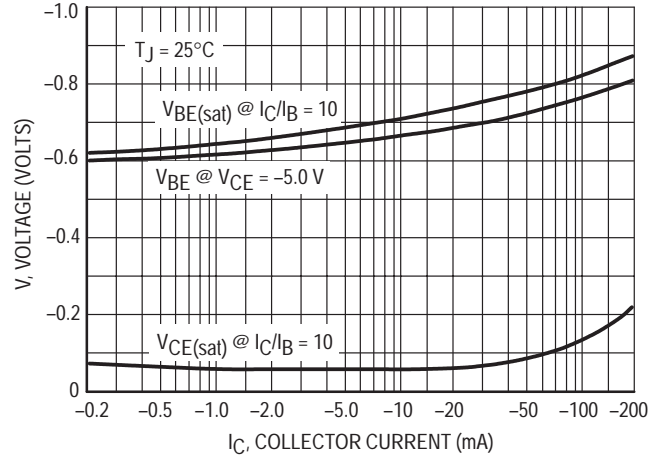


Figure 8. "On" Voltage

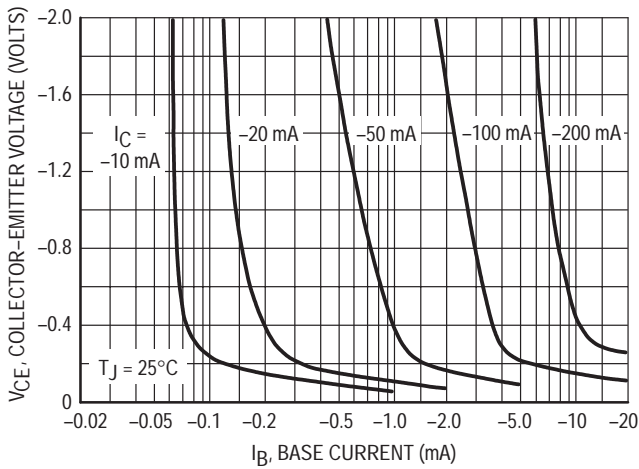


Figure 9. Collector Saturation Region

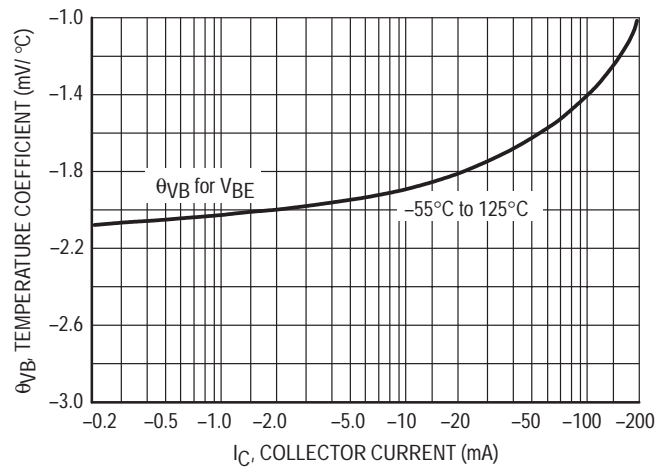


Figure 10. Base-Emitter Temperature Coefficient

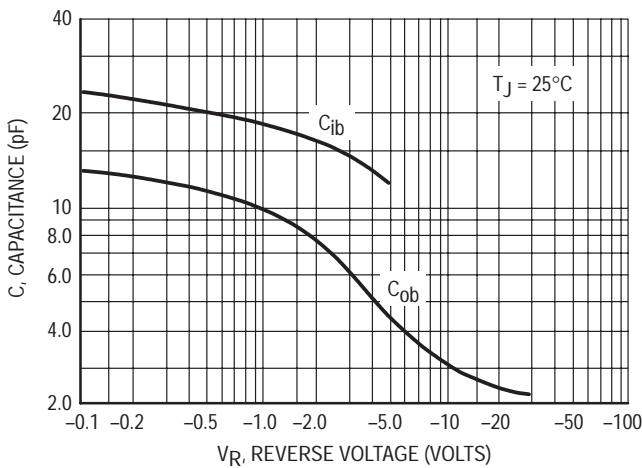


Figure 11. Capacitance

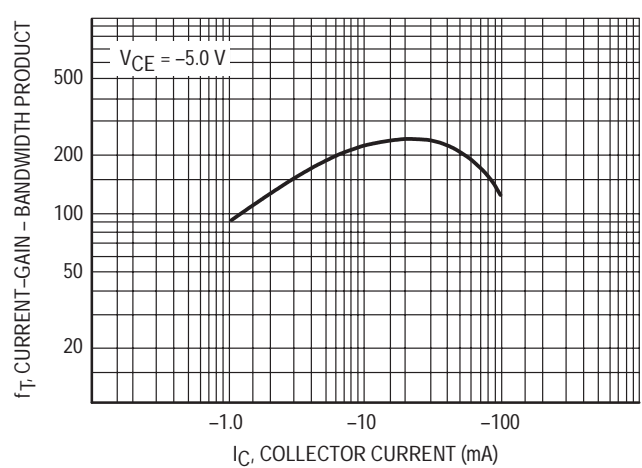


Figure 12. Current-Gain - Bandwidth Product

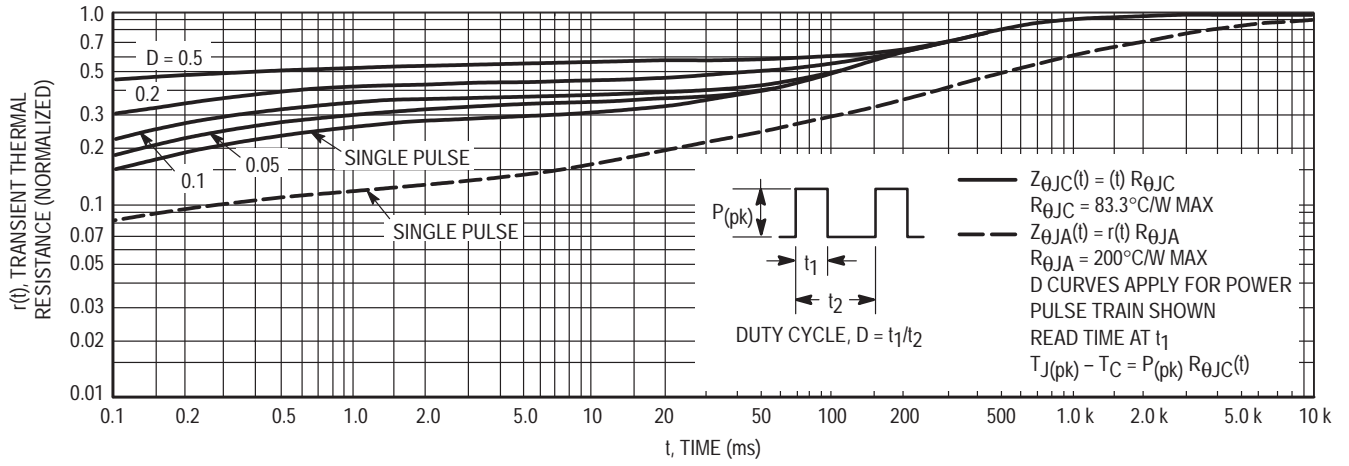


Figure 13. Thermal Response

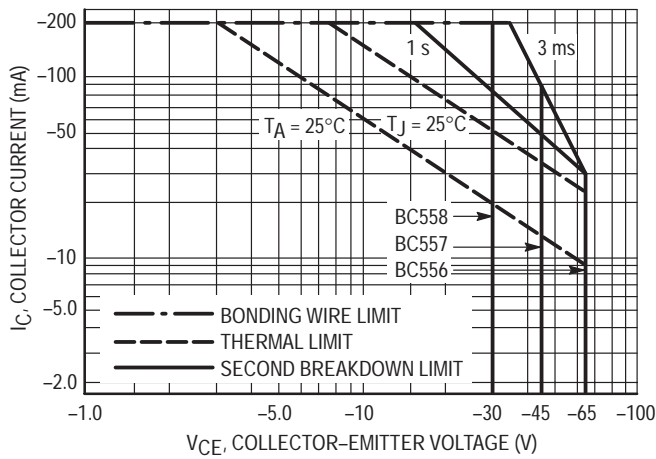


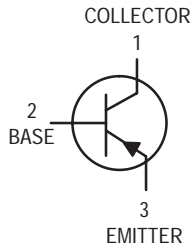
Figure 14. Active Region — Safe Operating Area

The safe operating area curves indicate I_C - V_{CE} limits of the transistor that must be observed for reliable operation. Collector load lines for specific circuits must fall below the limits indicated by the applicable curve.

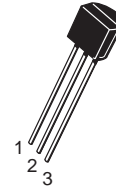
The data of Figure 14 is based upon $T_{J(pk)} = 150^\circ\text{C}$; T_C or T_A is variable depending upon conditions. Pulse curves are valid for duty cycles to 10% provided $T_{J(pk)} \leq 150^\circ\text{C}$. $T_{J(pk)}$ may be calculated from the data in Figure 13. At high case or ambient temperatures, thermal limitations will reduce the power than can be handled to values less than the limitations imposed by second breakdown.

Low Noise Transistors

PNP Silicon



BC559B
BC559C
BC560C



CASE 29-04, STYLE 17
TO-92 (TO-226AA)

MAXIMUM RATINGS

Rating	Symbol	BC559x	BC560C	Unit
Collector–Emitter Voltage	V_{CEO}	-30	-45	Vdc
Collector–Base Voltage	V_{CBO}	-30	-50	Vdc
Emitter–Base Voltage	V_{EBO}	-5.0		Vdc
Collector Current — Continuous	I_C	-100		mAdc
Total Device Dissipation @ $T_A = 25^\circ\text{C}$ Derate above 25°C	P_D	625	5.0	mW mW/ $^\circ\text{C}$
Total Device Dissipation @ $T_C = 25^\circ\text{C}$ Derate above 25°C	P_D	1.5	12	Watt mW/ $^\circ\text{C}$
Operating and Storage Junction Temperature Range	T_J, T_{stg}	-55 to +150		$^\circ\text{C}$

THERMAL CHARACTERISTICS

Characteristic	Symbol	Max	Unit
Thermal Resistance, Junction to Ambient	$R_{\theta JA}$	200	$^\circ\text{C}/\text{W}$
Thermal Resistance, Junction to Case	$R_{\theta JC}$	83.3	$^\circ\text{C}/\text{W}$

ELECTRICAL CHARACTERISTICS ($T_A = 25^\circ\text{C}$ unless otherwise noted)

Characteristic	Symbol	Min	Typ	Max	Unit
----------------	--------	-----	-----	-----	------

OFF CHARACTERISTICS

Collector–Emitter Breakdown Voltage ($I_C = -10 \text{ mAdc}, I_B = 0$)	BC559B, C BC560C	$V_{(BR)CEO}$	-30 -45	— —	— —	Vdc
Collector–Base Breakdown Voltage ($I_C = -10 \mu\text{Adc}, I_E = 0$)	BC559B, C BC560C	$V_{(BR)CBO}$	-30 -50	— —	— —	Vdc
Emitter–Base Breakdown Voltage ($I_E = -10 \mu\text{Adc}, I_C = 0$)		$V_{(BR)EBO}$	-5.0	—	—	Vdc
Collector Cutoff Current ($V_{CB} = -30 \text{ Vdc}, I_E = 0$) ($V_{CB} = -30 \text{ Vdc}, I_E = 0, T_A = +125^\circ\text{C}$)		I_{CBO}	— —	— —	-15 -5.0	nAdc μAdc
Emitter Cutoff Current ($V_{EB} = -4.0 \text{ Vdc}, I_C = 0$)		I_{EBO}	—	—	-15	nAdc

replaces BC559/D

ELECTRICAL CHARACTERISTICS ($T_A = 25^\circ\text{C}$ unless otherwise noted) (Continued)

Characteristic	Symbol	Min	Typ	Max	Unit
ON CHARACTERISTICS					
DC Current Gain ($I_C = -10\ \mu\text{Adc}$, $V_{CE} = -5.0\ \text{Vdc}$) ($I_C = -2.0\ \text{mAdc}$, $V_{CE} = -5.0\ \text{Vdc}$)	h_{FE}	100 100 180 380	150 270 290 500	— — 460 800	—
Collector–Emitter Saturation Voltage ($I_C = -10\ \text{mAdc}$, $I_B = -0.5\ \text{mAdc}$) ($I_C = -10\ \text{mAdc}$, $I_B = \text{see note 1}$) ($I_C = -100\ \text{mAdc}$, $I_B = -5.0\ \text{mAdc}$, see note 2)	$V_{CE(sat)}$	— — —	-0.075 -0.3 -0.25	-0.25 -0.6 —	Vdc
Base–Emitter Saturation Voltage ($I_C = -100\ \text{mAdc}$, $I_B = -5.0\ \text{mAdc}$)	$V_{BE(sat)}$	—	-1.1	—	Vdc
Base–Emitter On Voltage ($I_C = -10\ \mu\text{Adc}$, $V_{CE} = -5.0\ \text{Vdc}$) ($I_C = -100\ \mu\text{Adc}$, $V_{CE} = -5.0\ \text{Vdc}$) ($I_C = -2.0\ \text{mAdc}$, $V_{CE} = -5.0\ \text{Vdc}$)	$V_{BE(on)}$	— — -0.55	-0.52 -0.55 -0.62	— — -0.7	Vdc

SMALL–SIGNAL CHARACTERISTICS

Current–Gain — Bandwidth Product ($I_C = -10\ \text{mAdc}$, $V_{CE} = -5.0\ \text{Vdc}$, $f = 100\ \text{MHz}$)	f_T	—	250	—	MHz
Collector–Base Capacitance ($V_{CB} = -10\ \text{Vdc}$, $I_E = 0$, $f = 1.0\ \text{MHz}$)	C_{cbo}	—	2.5	—	pF
Small–Signal Current Gain ($I_C = -2.0\ \text{mAdc}$, $V_{CE} = -5.0\ \text{V}$, $f = 1.0\ \text{kHz}$)	h_{fe}	240 450	330 600	500 900	—
Noise Figure ($I_C = -200\ \mu\text{Adc}$, $V_{CE} = -5.0\ \text{Vdc}$, $R_S = 2.0\ \text{k}\Omega$, $f = 1.0\ \text{kHz}$) ($I_C = -200\ \mu\text{Adc}$, $V_{CE} = -5.0\ \text{Vdc}$, $R_S = 100\ \text{k}\Omega$, $f = 1.0\ \text{kHz}$, $\Delta f = 200\ \text{kHz}$)	NF_1 NF_2	— —	0.5 —	2.0 10	dB

NOTES:

- I_B is value for which $I_C = -11\ \text{mA}$ at $V_{CE} = -1.0\ \text{V}$.
- Pulse test = $300\ \mu\text{s}$ – Duty cycle = 2%.

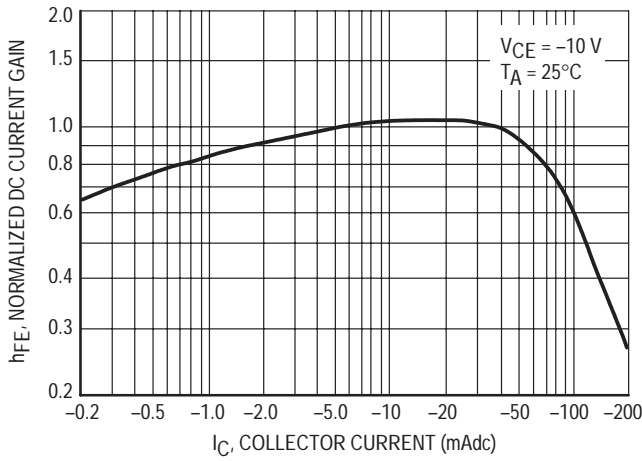


Figure 1. Normalized DC Current Gain

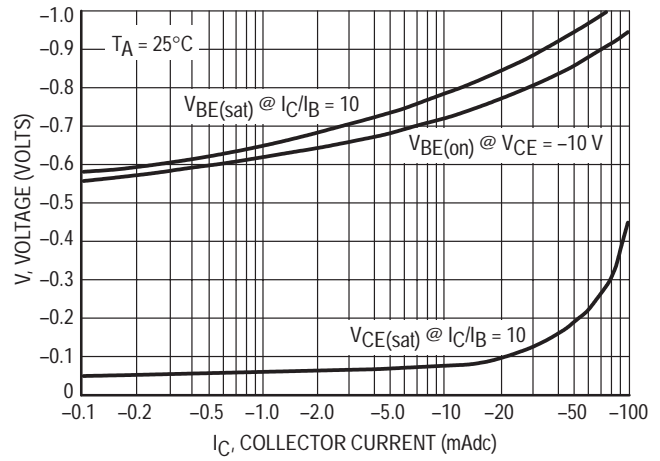


Figure 2. "Saturation" and "On" Voltages

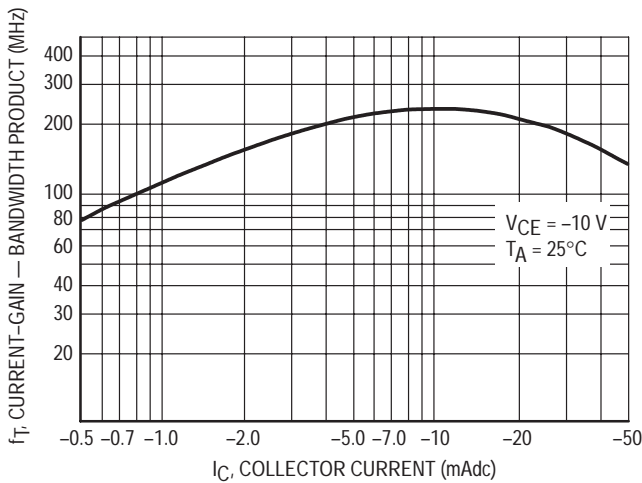


Figure 3. Current-Gain — Bandwidth Product

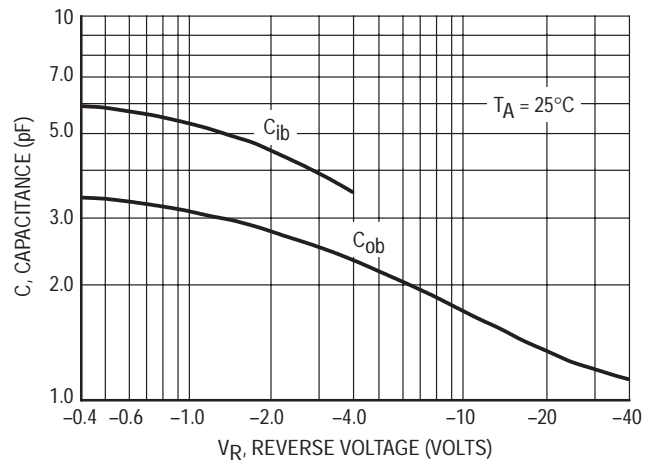


Figure 4. Capacitance

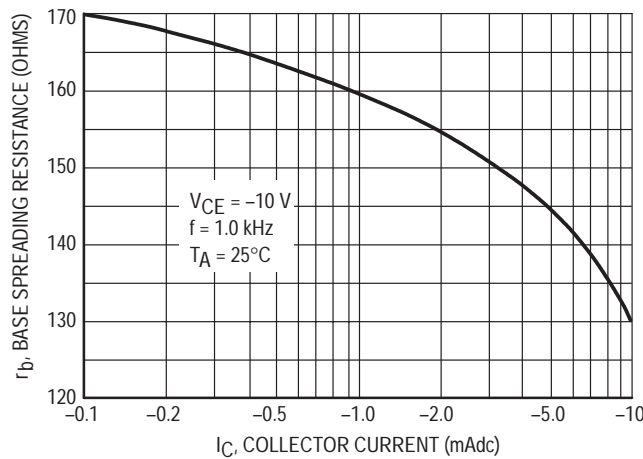
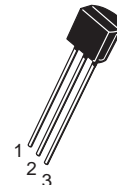
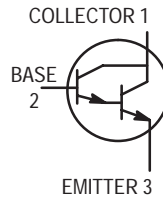


Figure 5. Base Spreading Resistance

Darlington Transistors

NPN Silicon

BC618



CASE 29-04, STYLE 17
TO-92 (TO-226AA)

MAXIMUM RATINGS

Rating	Symbol	Value	Unit
Collector–Emitter Voltage	V_{CEO}	55	Vdc
Collector–Base Voltage	V_{CBO}	80	Vdc
Emitter–Base Voltage	V_{EBO}	12	Vdc
Collector Current — Continuous	I_C	1.0	Adc
Total Device Dissipation @ $T_A = 25^\circ\text{C}$ Derate above 25°C	P_D	625 5.0	mW mW/ $^\circ\text{C}$
Total Device Dissipation @ $T_C = 25^\circ\text{C}$ Derate above 25°C	P_D	1.5 12	Watts mW/ $^\circ\text{C}$
Operating and Storage Junction Temperature Range	T_J, T_{stg}	-55 to +150	$^\circ\text{C}$

THERMAL CHARACTERISTICS

Characteristic	Symbol	Max	Unit
Thermal Resistance, Junction to Ambient	$R_{\theta JA}$	200	$^\circ\text{C}/\text{W}$
Thermal Resistance, Junction to Case	$R_{\theta JC}$	83.3	$^\circ\text{C}/\text{W}$

ELECTRICAL CHARACTERISTICS ($T_A = 25^\circ\text{C}$ unless otherwise noted)

Characteristic	Symbol	Min	Typ	Max	Unit
----------------	--------	-----	-----	-----	------

OFF CHARACTERISTICS

Collector–Emitter Breakdown Voltage ($I_C = 10 \text{ mAdc}, V_{BE} = 0$)	$V_{(BR)CEO}$	55	—	—	Vdc
Collector–Base Breakdown Voltage ($I_C = 100 \mu\text{Adc}, I_E = 0$)	$V_{(BR)CBO}$	80	—	—	Vdc
Emitter–Base Breakdown Voltage ($I_E = 10 \mu\text{Adc}, I_C = 0$)	$V_{(BR)EBO}$	12	—	—	Vdc
Collector Cutoff Current ($V_{CE} = 60 \text{ Vdc}, V_{BE} = 0$)	I_{CES}	—	—	50	nAdc
Collector Cutoff Current ($V_{CB} = 60 \text{ Vdc}, I_E = 0$)	I_{CBO}	—	—	50	nAdc
Emitter Cutoff Current ($V_{EB} = 10 \text{ Vdc}, I_C = 0$)	I_{EBO}	—	—	50	nAdc

BC618

ELECTRICAL CHARACTERISTICS ($T_A = 25^\circ\text{C}$ unless otherwise noted) (Continued)

Characteristic	Symbol	Min	Typ	Max	Unit
ON CHARACTERISTICS					
Collector–Emitter Saturation Voltage ($I_C = 200\text{ mA}$, $I_B = 0.2\text{ mA}$)	$V_{CE(sat)}$	—	—	1.1	Vdc
Base–Emitter Saturation Voltage ($I_C = 200\text{ mA}$, $I_B = 0.2\text{ mA}$)	$V_{BE(sat)}$	—	—	1.6	Vdc
DC Current Gain ($I_C = 100\ \mu\text{A}$, $V_{CE} = 5.0\text{ Vdc}$) ($I_C = 10\text{ mA}$, $V_{CE} = 5.0\text{ Vdc}$) ($I_C = 200\text{ mA}$, $V_{CE} = 5.0\text{ Vdc}$) ($I_C = 1.0\text{ A}$, $V_{CE} = 5.0\text{ Vdc}$)	h_{FE}	2000 4000 10000 4000	— — — —	— — 50000 —	—

DYNAMIC CHARACTERISTICS

Current–Gain — Bandwidth Product ($I_C = 500\text{ mA}$, $V_{CE} = 5.0\text{ Vdc}$, $P = 100\text{ MHz}$)	f_T	150	—	—	MHz
Output Capacitance ($V_{CB} = 10\text{ V}$, $I_E = 0$, $f = 1.0\text{ MHz}$)	C_{ob}	—	4.5	7.0	pF
Input Capacitance ($V_{EB} = 5.0\text{ V}$, $I_E = 0$, $f = 1.0\text{ MHz}$)	C_{ib}	—	5.0	9.0	pF

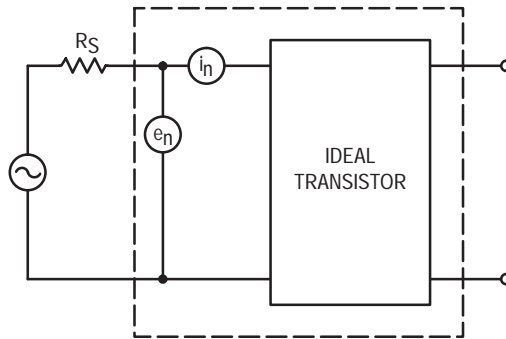


Figure 1. Transistor Noise Model

NOISE CHARACTERISTICS

($V_{CE} = 5.0 \text{ Vdc}$, $T_A = 25^\circ\text{C}$)

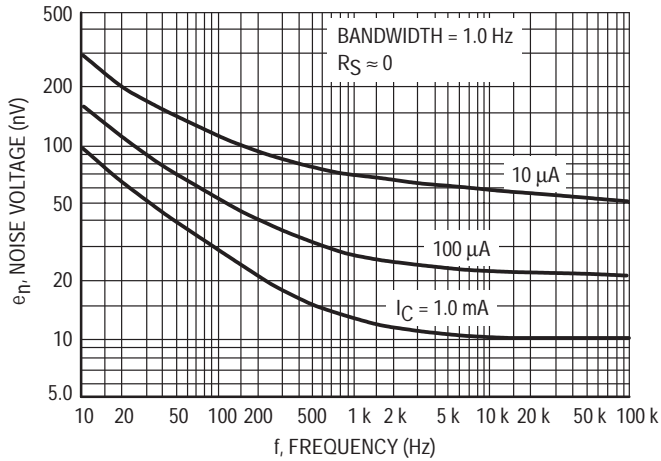


Figure 2. Noise Voltage

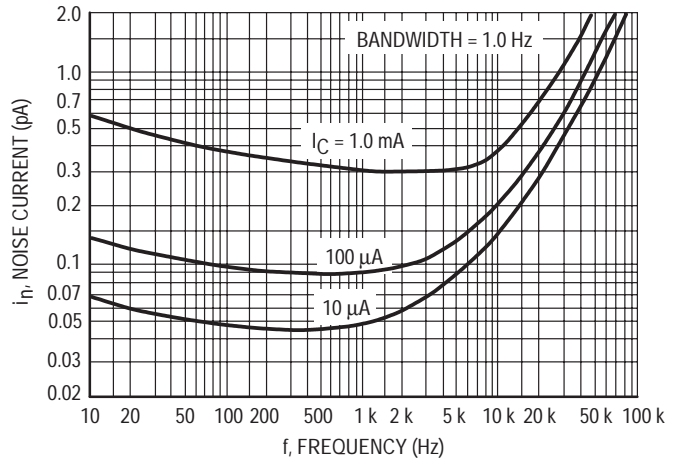


Figure 3. Noise Current

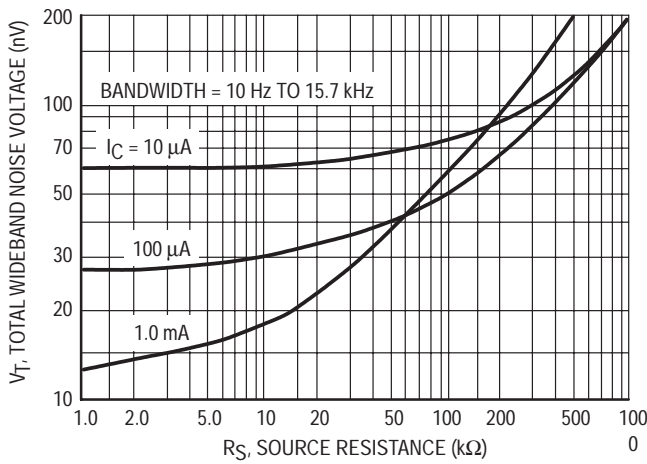


Figure 4. Total Wideband Noise Voltage

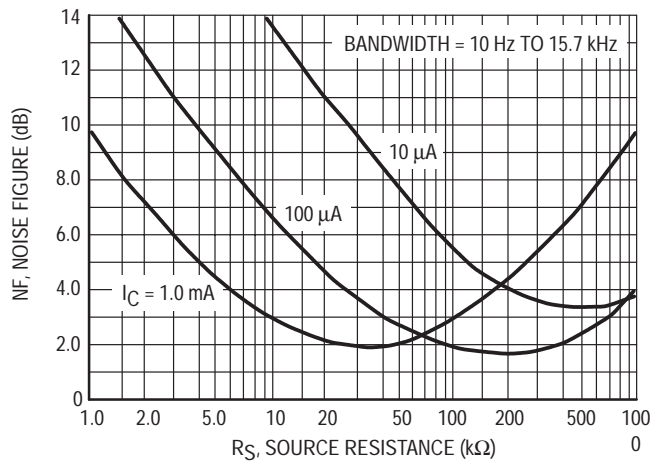


Figure 5. Wideband Noise Figure

SMALL-SIGNAL CHARACTERISTICS

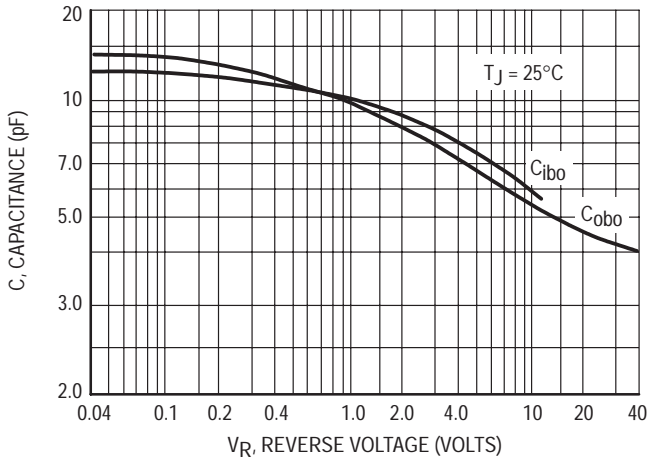


Figure 6. Capacitance

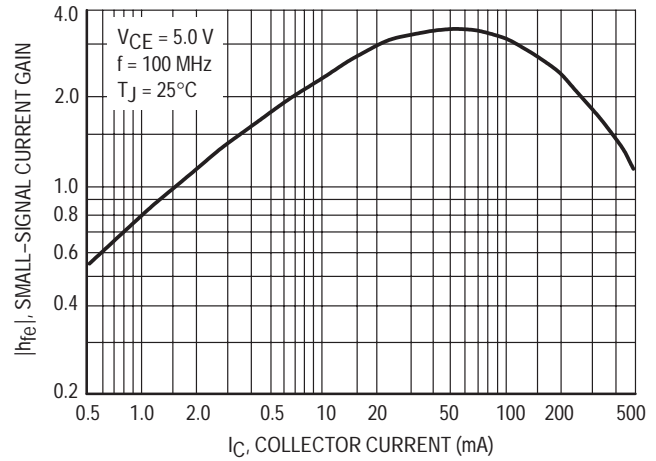


Figure 7. High Frequency Current Gain

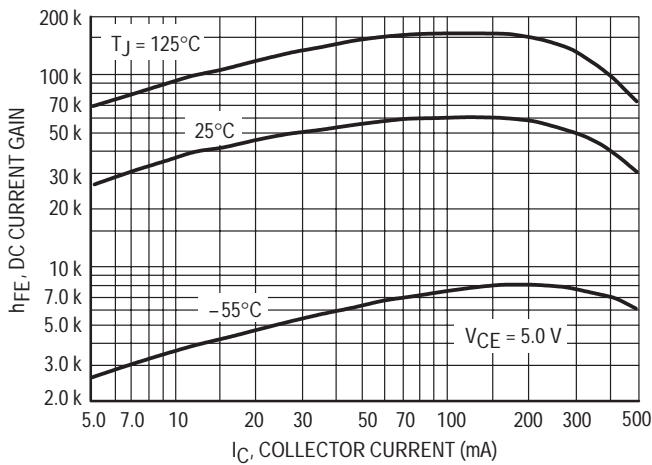


Figure 8. DC Current Gain

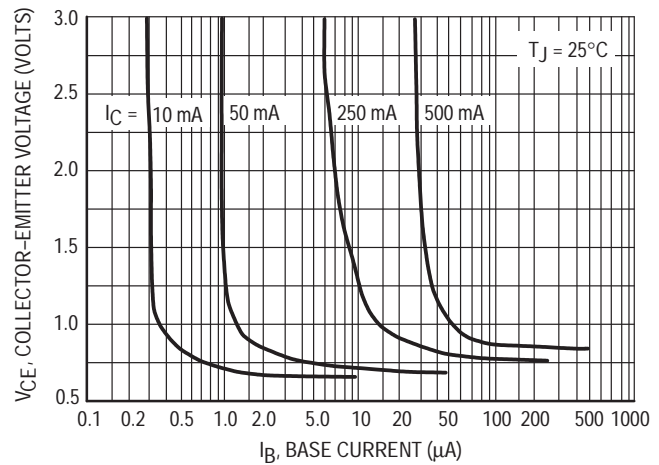


Figure 9. Collector Saturation Region

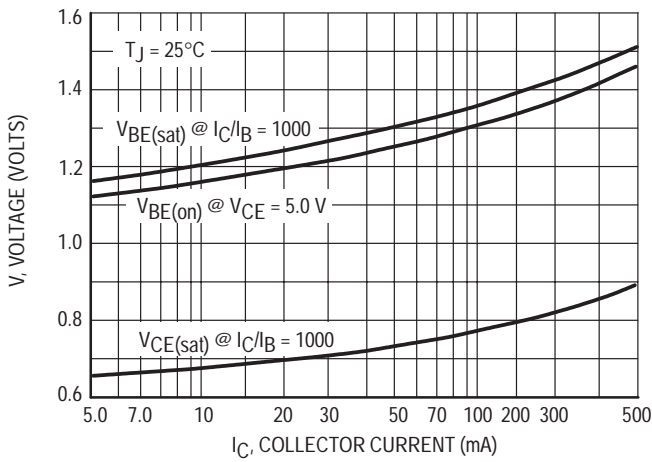


Figure 10. "On" Voltages

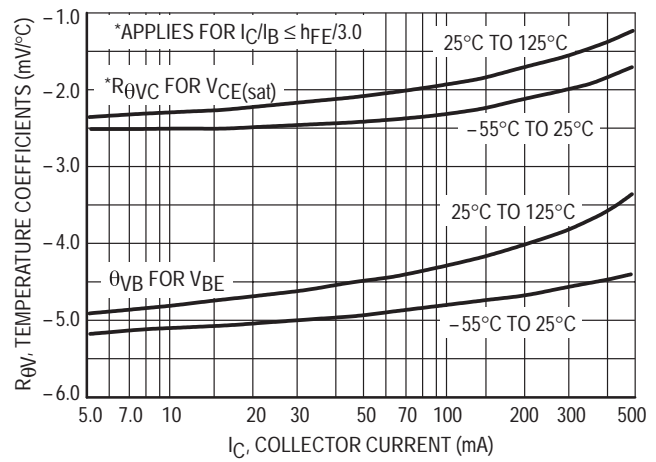


Figure 11. Temperature Coefficients

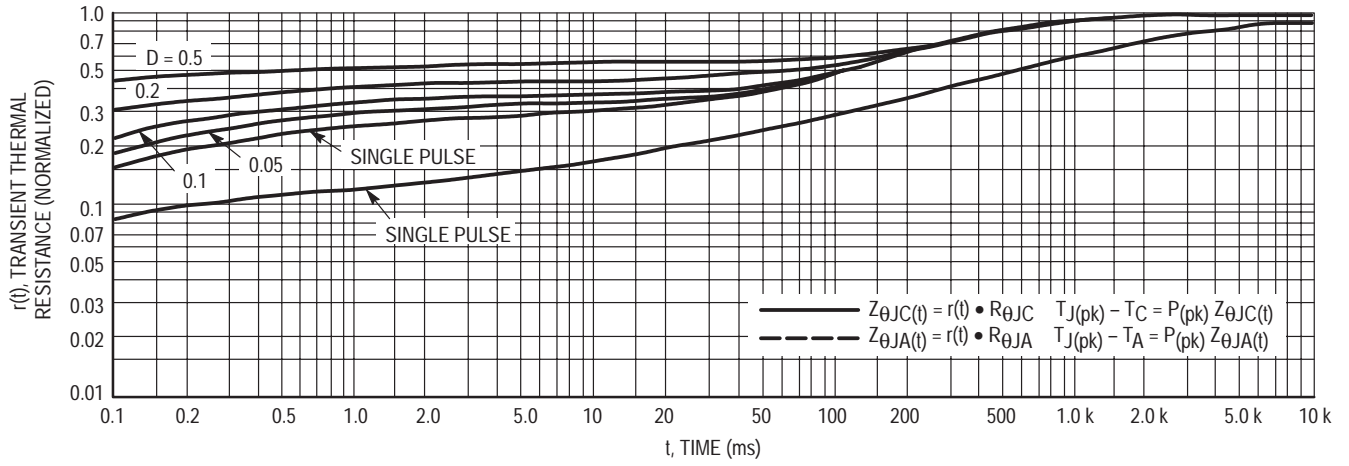


Figure 12. Thermal Response

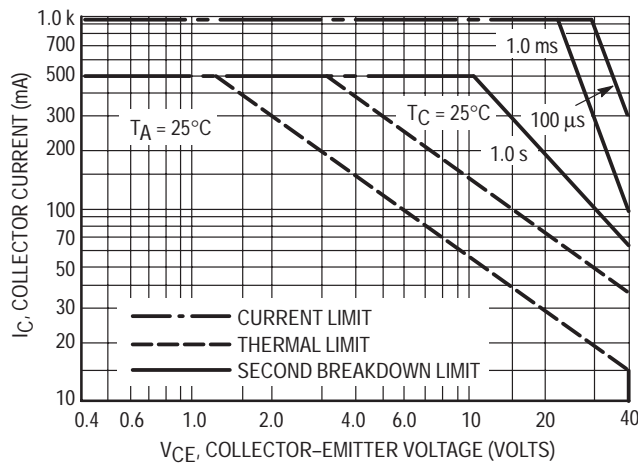
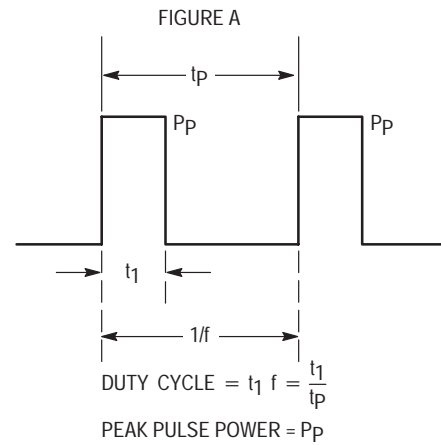


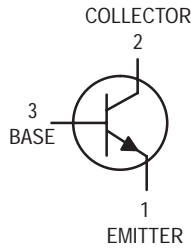
Figure 13. Active Region Safe Operating Area



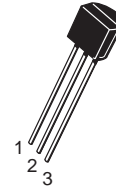
Design Note: Use of Transient Thermal Resistance Data

High Current Transistors

NPN Silicon



BC635
BC637
BC639



CASE 29-04, STYLE 14
TO-92 (TO-226AA)

MAXIMUM RATINGS

Rating	Symbol	BC635	BC637	BC639	Unit
Collector–Emitter Voltage	V_{CEO}	45	60	80	Vdc
Collector–Base Voltage	V_{CBO}	45	60	80	Vdc
Emitter–Base Voltage	V_{EBO}	5.0			Vdc
Collector Current — Continuous	I_C	0.5			Adc
Total Device Dissipation @ $T_A = 25^\circ\text{C}$ Derate above 25°C	P_D	625 5.0			mW mW/ $^\circ\text{C}$
Total Device Dissipation @ $T_C = 25^\circ\text{C}$ Derate above 25°C	P_D	1.5 12			Watt mW/ $^\circ\text{C}$
Operating and Storage Junction Temperature Range	T_J, T_{stg}	–55 to +150			$^\circ\text{C}$

THERMAL CHARACTERISTICS

Characteristic	Symbol	Max	Unit
Thermal Resistance, Junction to Ambient	$R_{\theta JA}$	200	$^\circ\text{C}/\text{W}$
Thermal Resistance, Junction to Case	$R_{\theta JC}$	83.3	$^\circ\text{C}/\text{W}$

ELECTRICAL CHARACTERISTICS ($T_A = 25^\circ\text{C}$ unless otherwise noted)

Characteristic	Symbol	Min	Typ	Max	Unit
----------------	--------	-----	-----	-----	------

OFF CHARACTERISTICS

Collector–Emitter Breakdown Voltage ⁽¹⁾ ($I_C = 10 \text{ mAdc}, I_E = 0$)	BC635 BC637 BC639	$V_{(BR)CEO}$	45 60 80	— — —	— — —	Vdc
Collector–Base Breakdown Voltage ($I_C = 100 \mu\text{Adc}, I_E = 0$)	BC635 BC637 BC639	$V_{(BR)CBO}$	45 60 80	— — —	— — —	Vdc
Emitter–Base Breakdown Voltage ($I_E = 10 \mu\text{Adc}, I_C = 0$)		$V_{(BR)EBO}$	5.0	—	—	Vdc
Collector Cutoff Current ($V_{CB} = 30 \text{ Vdc}, I_E = 0$) ($V_{CB} = 30 \text{ Vdc}, I_E = 0, T_A = 125^\circ\text{C}$)		I_{CBO}	— —	— —	100 10	nAdc μAdc

1. Pulse Test: Pulse Width $\leq 300 \mu\text{s}$, Duty Cycle 2.0%.

ELECTRICAL CHARACTERISTICS ($T_A = 25^\circ\text{C}$ unless otherwise noted) (Continued)

Characteristic	Symbol	Min	Typ	Max	Unit
ON CHARACTERISTICS(1)					
DC Current Gain ($I_C = 5.0 \text{ mAdc}$, $V_{CE} = 2.0 \text{ Vdc}$) ($I_C = 150 \text{ mAdc}$, $V_{CE} = 2.0 \text{ Vdc}$) ($I_C = 500 \text{ mA}$, $V_{CE} = 2.0 \text{ V}$)	h_{FE}	25 40 40 40 25	— — — — —	— 250 160 160 —	—
Collector–Emitter Saturation Voltage ($I_C = 500 \text{ mAdc}$, $I_B = 50 \text{ mAdc}$)	$V_{CE(sat)}$	—	—	0.5	Vdc
Base–Emitter On Voltage ($I_C = 500 \text{ mAdc}$, $V_{CE} = 2.0 \text{ Vdc}$)	$V_{BE(on)}$	—	—	1.0	Vdc

DYNAMIC CHARACTERISTICS

Current–Gain — Bandwidth Product ($I_C = 50 \text{ mAdc}$, $V_{CE} = 2.0 \text{ Vdc}$, $f = 100 \text{ MHz}$)	f_T	—	200	—	MHz
Output Capacitance ($V_{CB} = 10 \text{ Vdc}$, $I_E = 0$, $f = 1.0 \text{ MHz}$)	C_{ob}	—	7.0	—	pF
Input Capacitance ($V_{EB} = 0.5 \text{ Vdc}$, $I_C = 0$, $f = 1.0 \text{ MHz}$)	C_{ib}	—	50	—	pF

 1. Pulse Test: Pulse Width $\leq 300 \mu\text{s}$, Duty Cycle 2.0%.

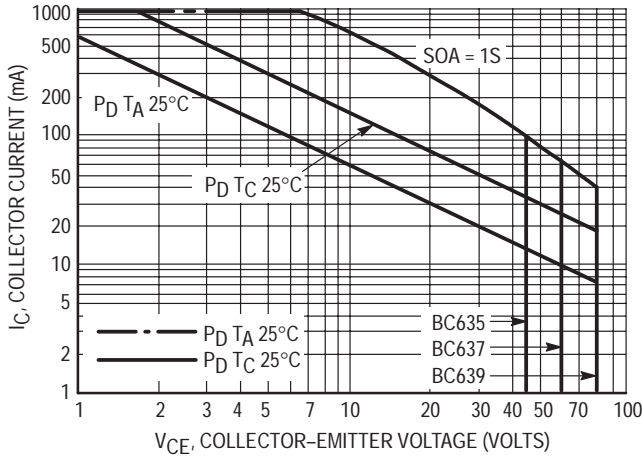


Figure 1. Active Region Safe Operating Area

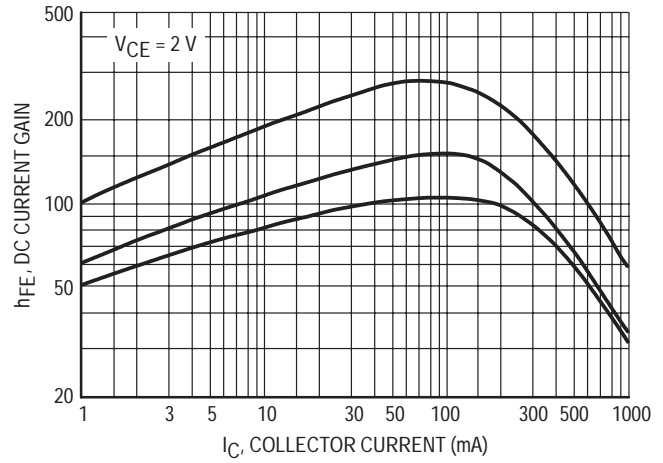


Figure 2. DC Current Gain

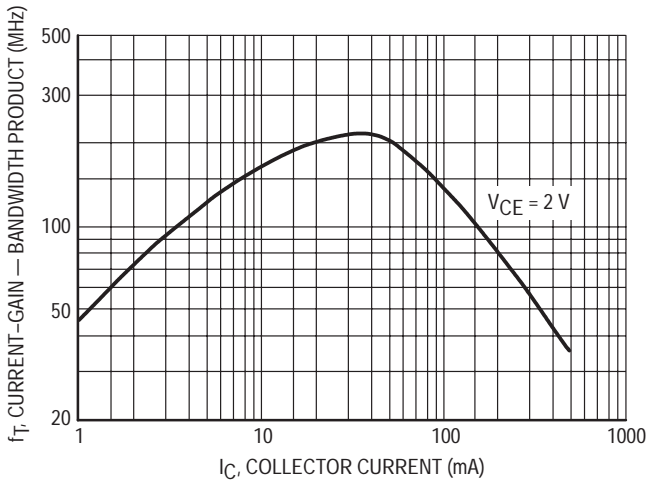


Figure 3. Current-Gain — Bandwidth Product

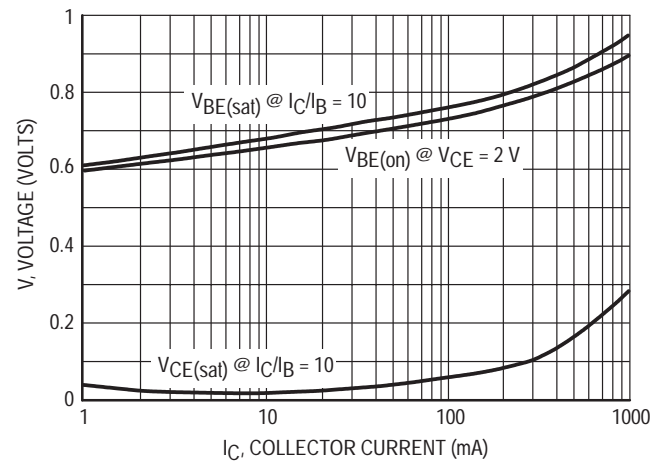


Figure 4. "Saturation" and "On" Voltages

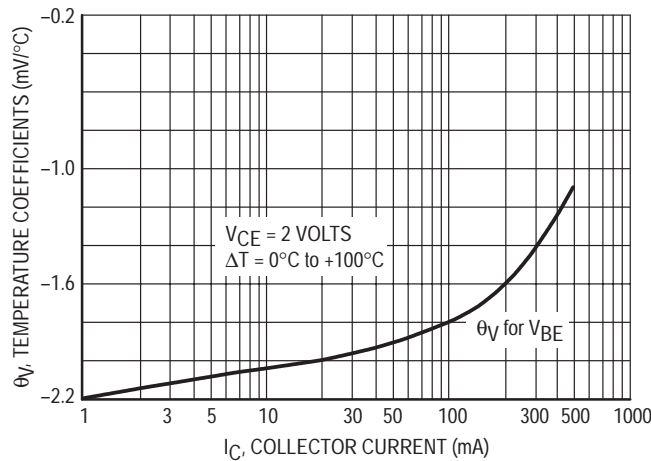
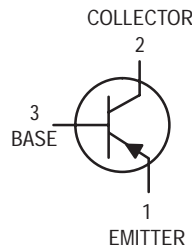


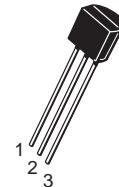
Figure 5. Temperature Coefficients

High Current Transistors

PNP Silicon



BC636
BC638
BC640



CASE 29-04, STYLE 14
TO-92 (TO-226AA)

MAXIMUM RATINGS

Rating	Symbol	BC636	BC638	BC640	Unit
Collector–Emitter Voltage	V_{CEO}	-45	-60	-80	Vdc
Collector–Base Voltage	V_{CBO}	-45	-60	-80	Vdc
Emitter–Base Voltage	V_{EBO}	-5.0			Vdc
Collector Current — Continuous	I_C	-0.5			Adc
Total Device Dissipation @ $T_A = 25^\circ\text{C}$ Derate above 25°C	P_D	625 5.0			mW mW/°C
Total Device Dissipation @ $T_C = 25^\circ\text{C}$ Derate above 25°C	P_D	1.5 12			Watt mW/°C
Operating and Storage Junction Temperature Range	T_J, T_{stg}	-55 to +150			°C

THERMAL CHARACTERISTICS

Characteristic	Symbol	Max	Unit
Thermal Resistance, Junction to Ambient	$R_{\theta JA}$	200	°C/W
Thermal Resistance, Junction to Case	$R_{\theta JC}$	83.3	°C/W

ELECTRICAL CHARACTERISTICS ($T_A = 25^\circ\text{C}$ unless otherwise noted)

Characteristic	Symbol	Min	Typ	Max	Unit
----------------	--------	-----	-----	-----	------

OFF CHARACTERISTICS

Collector–Emitter Breakdown Voltage* ($I_C = -10 \text{ mAdc}$, $I_E = 0$)	BC636 BC638 BC640	$V_{(BR)CEO}$	-45 -60 -80	— — —	— — —	Vdc
Collector–Base Breakdown Voltage ($I_C = -100 \mu\text{Adc}$, $I_E = 0$)	BC636 BC638 BC640	$V_{(BR)CBO}$	-45 -60 -80	— — —	— — —	Vdc
Emitter–Base Breakdown Voltage ($I_E = -10 \mu\text{Adc}$, $I_C = 0$)		$V_{(BR)EBO}$	-5.0	—	—	Vdc
Collector Cutoff Current ($V_{CB} = -30 \text{ Vdc}$, $I_E = 0$) ($V_{CB} = -30 \text{ Vdc}$, $I_E = 0$, $T_A = 125^\circ\text{C}$)		I_{CBO}	— —	— —	-100 -10	nAdc μAdc

1. Pulse Test: Pulse Width $\leq 300 \mu\text{s}$, Duty Cycle 2.0%.

BC636 BC638 BC640**ELECTRICAL CHARACTERISTICS** ($T_A = 25^\circ\text{C}$ unless otherwise noted) (Continued)

Characteristic	Symbol	Min	Typ	Max	Unit
ON CHARACTERISTICS(1)					
DC Current Gain ($I_C = -5.0 \text{ mAdc}$, $V_{CE} = -2.0 \text{ Vdc}$) ($I_C = -150 \text{ mAdc}$, $V_{CE} = -2.0 \text{ Vdc}$)	h_{FE}	25	—	—	—
BC636		40	—	250	
BC638		40	—	160	
BC640		40	—	160	
($I_C = -500 \text{ mA}$, $V_{CE} = -2.0 \text{ V}$)		25	—	—	
Collector–Emitter Saturation Voltage ($I_C = -500 \text{ mAdc}$, $I_B = -50 \text{ mAdc}$)	$V_{CE(sat)}$	—	-0.25	-0.5	Vdc
		—	-0.5	—	
Base–Emitter On Voltage ($I_C = -500 \text{ mAdc}$, $V_{CE} = -2.0 \text{ Vdc}$)	$V_{BE(on)}$	—	—	-1.0	Vdc

DYNAMIC CHARACTERISTICS

Current–Gain — Bandwidth Product ($I_C = -50 \text{ mAdc}$, $V_{CE} = -2.0 \text{ Vdc}$, $f = 100 \text{ MHz}$)	f_T	—	150	—	MHz
Output Capacitance ($V_{CB} = -10 \text{ Vdc}$, $I_E = 0$, $f = 1.0 \text{ MHz}$)	C_{ob}	—	9.0	—	pF
Input Capacitance ($V_{EB} = -0.5 \text{ Vdc}$, $I_C = 0$, $f = 1.0 \text{ MHz}$)	C_{ib}	—	110	—	pF

1. Pulse Test: Pulse Width $\leq 300 \mu\text{s}$, Duty Cycle 2.0%.

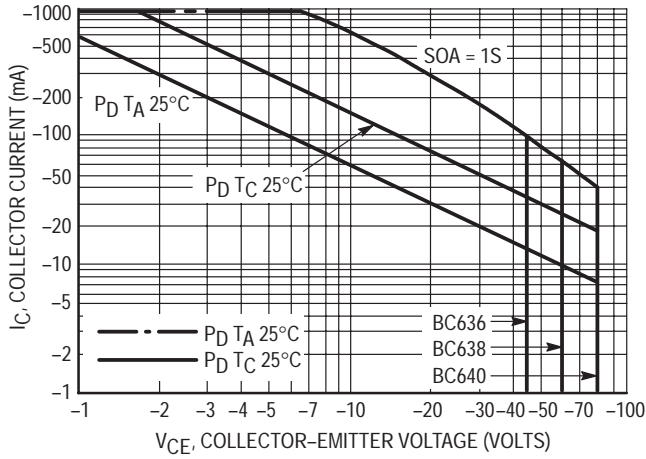


Figure 1. Active Region Safe Operating Area

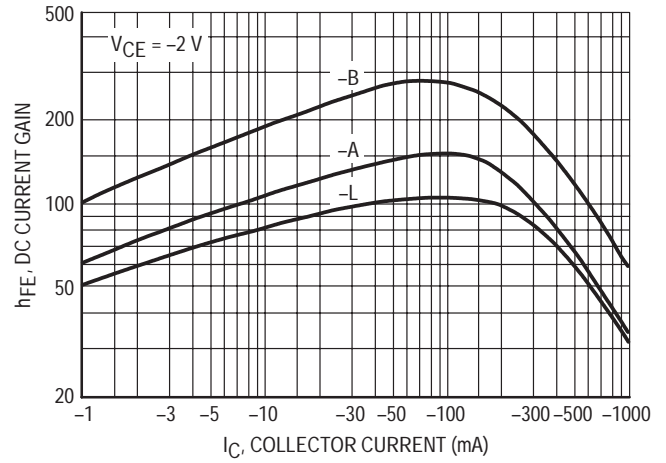


Figure 2. DC Current Gain

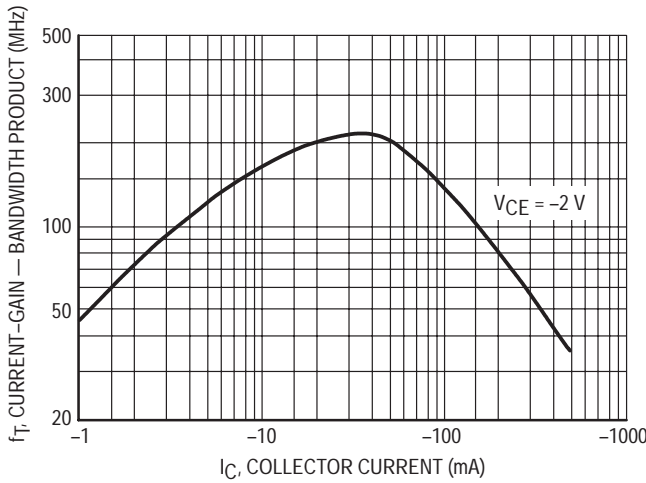


Figure 3. Current Gain Bandwidth Product

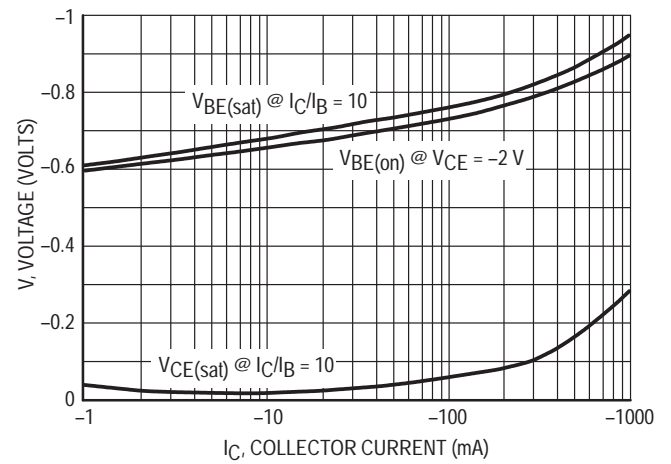


Figure 4. "Saturation" and "On" Voltages

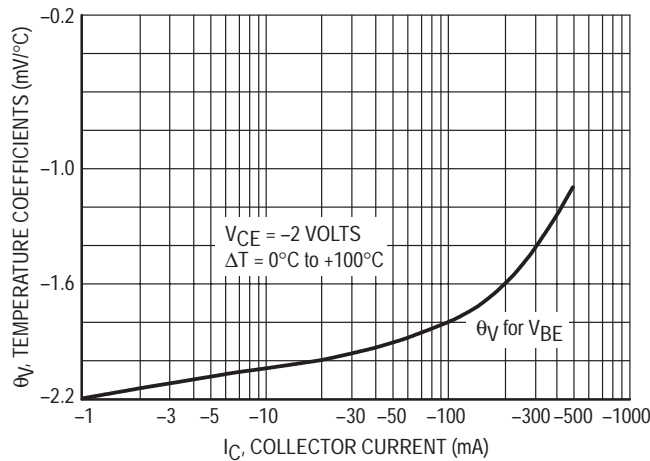
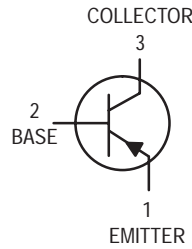


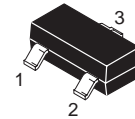
Figure 5. Temperature Coefficients

General Purpose Transistors

PNP Silicon



BC807-16LT1
BC807-25LT1
BC807-40LT1



CASE 318-08, STYLE 6
SOT-23 (TO-236AB)

MAXIMUM RATINGS

Rating	Symbol	Value	Unit
Collector-Emitter Voltage	V_{CEO}	-45	V
Collector-Base Voltage	V_{CBO}	-50	V
Emitter-Base Voltage	V_{EBO}	-5.0	V
Collector Current — Continuous	I_C	-500	mAdc

THERMAL CHARACTERISTICS

Characteristic	Symbol	Max	Unit
Total Device Dissipation FR-5 Board, (1) $T_A = 25^\circ\text{C}$ Derate above 25°C	P_D	225 1.8	mW mW/ $^\circ\text{C}$
Thermal Resistance, Junction to Ambient	$R_{\theta JA}$	556	$^\circ\text{C}/\text{W}$
Total Device Dissipation Alumina Substrate, (2) $T_A = 25^\circ\text{C}$ Derate above 25°C	P_D	300 2.4	mW mW/ $^\circ\text{C}$
Thermal Resistance, Junction to Ambient	$R_{\theta JA}$	417	$^\circ\text{C}/\text{W}$
Junction and Storage Temperature	T_J, T_{stg}	-55 to +150	$^\circ\text{C}$

DEVICE MARKING

BC807-16LT1 = 5A; BC807-25LT1 = 5B; BC807-40LT1 = 5C

ELECTRICAL CHARACTERISTICS ($T_A = 25^\circ\text{C}$ unless otherwise noted.)

Characteristic	Symbol	Min	Typ	Max	Unit
----------------	--------	-----	-----	-----	------

OFF CHARACTERISTICS

Collector-Emitter Breakdown Voltage ($I_C = -10\text{ mA}$)	$V_{(BR)CEO}$	-45	—	—	V
Collector-Emitter Breakdown Voltage ($V_{EB} = 0, I_C = -10\ \mu\text{A}$)	$V_{(BR)CES}$	-50	—	—	V
Emitter-Base Breakdown Voltage ($I_E = -1.0\ \mu\text{A}$)	$V_{(BR)EBO}$	-5.0	—	—	V
Collector Cutoff Current ($V_{CB} = -20\text{ V}$) ($V_{CB} = -20\text{ V}, T_J = 150^\circ\text{C}$)	I_{CBO}	— —	— —	-100 -5.0	nA μA

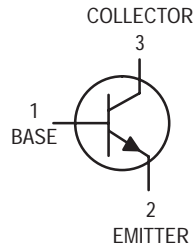
- FR-5 = 1.0 x 0.75 x 0.062 in.
- Alumina = 0.4 x 0.3 x 0.024 in. 99.5% alumina.

ELECTRICAL CHARACTERISTICS ($T_A = 25^\circ\text{C}$ unless otherwise noted) (Continued)

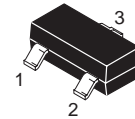
Characteristic	Symbol	Min	Typ	Max	Unit
ON CHARACTERISTICS					
DC Current Gain ($I_C = -100\text{ mA}$, $V_{CE} = -1.0\text{ V}$) ($I_C = -500\text{ mA}$, $V_{CE} = -1.0\text{ V}$)	h_{FE} BC807-16 BC807-25 BC807-40	100 160 250 40	— — — —	250 400 600 —	—
Collector-Emitter Saturation Voltage ($I_C = -500\text{ mA}$, $I_B = -50\text{ mA}$)	$V_{CE(sat)}$	—	—	-0.7	V
Base-Emitter On Voltage ($I_C = -500\text{ mA}$, $I_B = -1.0\text{ V}$)	$V_{BE(on)}$	—	—	-1.2	V
SMALL-SIGNAL CHARACTERISTICS					
Current-Gain — Bandwidth Product ($I_C = -10\text{ mA}$, $V_{CE} = -5.0\text{ Vdc}$, $f = 100\text{ MHz}$)	f_T	100	—	—	MHz
Output Capacitance ($V_{CB} = -10\text{ V}$, $f = 1.0\text{ MHz}$)	C_{obo}	—	10	—	pF

General Purpose Transistors

NPN Silicon



BC817-16LT1
BC817-25LT1
BC817-40LT1



CASE 318-08, STYLE 6
SOT-23 (TO-236AB)

MAXIMUM RATINGS

Rating	Symbol	Value	Unit
Collector-Emitter Voltage	V_{CEO}	45	V
Collector-Base Voltage	V_{CBO}	50	V
Emitter-Base Voltage	V_{EBO}	5.0	V
Collector Current — Continuous	I_C	500	mAdc

THERMAL CHARACTERISTICS

Characteristic	Symbol	Max	Unit
Total Device Dissipation FR-5 Board, (1) $T_A = 25^\circ\text{C}$ Derate above 25°C	P_D	225 1.8	mW mW/ $^\circ\text{C}$
Thermal Resistance, Junction to Ambient	$R_{\theta JA}$	556	$^\circ\text{C}/\text{W}$
Total Device Dissipation Alumina Substrate, (2) $T_A = 25^\circ\text{C}$ Derate above 25°C	P_D	300 2.4	mW mW/ $^\circ\text{C}$
Thermal Resistance, Junction to Ambient	$R_{\theta JA}$	417	$^\circ\text{C}/\text{W}$
Junction and Storage Temperature	T_J, T_{stg}	-55 to +150	$^\circ\text{C}$

DEVICE MARKING

BC817-16LT1 = 6A; BC817-25LT1 = 6B; BC817-40LT1 = 6C

ELECTRICAL CHARACTERISTICS ($T_A = 25^\circ\text{C}$ unless otherwise noted)

Characteristic	Symbol	Min	Typ	Max	Unit
----------------	--------	-----	-----	-----	------

OFF CHARACTERISTICS

Collector-Emitter Breakdown Voltage ($I_C = -10\text{ mA}$)	$V_{(BR)CEO}$	45	—	—	V
Collector-Emitter Breakdown Voltage ($V_{EB} = 0, I_C = -10\ \mu\text{A}$)	$V_{(BR)CES}$	50	—	—	V
Emitter-Base Breakdown Voltage ($I_E = -1.0\ \mu\text{A}$)	$V_{(BR)EBO}$	5.0	—	—	V
Collector Cutoff Current ($V_{CB} = 20\text{ V}$) ($V_{CB} = 20\text{ V}, T_A = 150^\circ\text{C}$)	I_{CBO}	— —	— —	100 5.0	nA μA

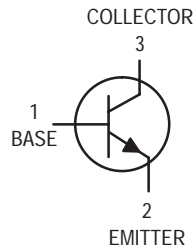
- FR-5 = 1.0 x 0.75 x 0.062 in.
- Alumina = 0.4 x 0.3 x 0.024 in. 99.5% alumina.

ELECTRICAL CHARACTERISTICS ($T_A = 25^\circ\text{C}$ unless otherwise noted) (Continued)

Characteristic	Symbol	Min	Typ	Max	Unit
ON CHARACTERISTICS					
DC Current Gain ($I_C = 100\text{ mA}$, $V_{CE} = 1.0\text{ V}$) ($I_C = 500\text{ mA}$, $V_{CE} = 1.0\text{ V}$)	h_{FE} BC817-16 BC817-25 BC817-40	100 160 250 40	— — — —	250 400 600 —	—
Collector-Emitter Saturation Voltage ($I_C = 500\text{ mA}$, $I_B = 50\text{ mA}$)	$V_{CE(sat)}$	—	—	0.7	V
Base-Emitter On Voltage ($I_C = 500\text{ mA}$, $V_{CE} = 1.0\text{ V}$)	$V_{BE(on)}$	—	—	1.2	V
SMALL-SIGNAL CHARACTERISTICS					
Current-Gain — Bandwidth Product ($I_C = 10\text{ mA}$, $V_{CE} = 5.0\text{ Vdc}$, $f = 100\text{ MHz}$)	f_T	100	—	—	MHz
Output Capacitance ($V_{CB} = 10\text{ V}$, $f = 1.0\text{ MHz}$)	C_{obo}	—	10	—	pF

General Purpose Transistors

NPN Silicon



**BC846ALT1,BLT1
BC847ALT1,
BLT1,CLT1 thru
BC850BLT1,CLT1**

BC846, BC847 and BC848 are
Motorola Preferred Devices

MAXIMUM RATINGS

Rating	Symbol	BC846	BC847 BC850	BC848 BC849	Unit
Collector–Emitter Voltage	V_{CEO}	65	45	30	V
Collector–Base Voltage	V_{CBO}	80	50	30	V
Emitter–Base Voltage	V_{EBO}	6.0	6.0	5.0	V
Collector Current — Continuous	I_C	100	100	100	mAdc

THERMAL CHARACTERISTICS

Characteristic	Symbol	Max	Unit
Total Device Dissipation FR–5 Board, (1) $T_A = 25^\circ\text{C}$ Derate above 25°C	P_D	225 1.8	mW mW/ $^\circ\text{C}$
Thermal Resistance, Junction to Ambient	$R_{\theta JA}$	556	$^\circ\text{C/W}$
Total Device Dissipation Alumina Substrate, (2) $T_A = 25^\circ\text{C}$ Derate above 25°C	P_D	300 2.4	mW mW/ $^\circ\text{C}$
Thermal Resistance, Junction to Ambient	$R_{\theta JA}$	417	$^\circ\text{C/W}$
Junction and Storage Temperature	T_J, T_{stg}	–55 to +150	$^\circ\text{C}$

DEVICE MARKING

BC846ALT1 = 1A; BC846BLT1 = 1B; BC847ALT1 = 1E; BC847BLT1 = 1F;
BC847CLT1 = 1G; BC848ALT1 = 1J; BC848BLT1 = 1K; BC848CLT1 = 1L

ELECTRICAL CHARACTERISTICS ($T_A = 25^\circ\text{C}$ unless otherwise noted)

Characteristic	Symbol	Min	Typ	Max	Unit
----------------	--------	-----	-----	-----	------

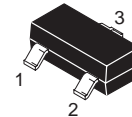
OFF CHARACTERISTICS

Collector–Emitter Breakdown Voltage ($I_C = 10\text{ mA}$)	BC846A,B BC847A,B,C, BC850B,C BC848A,B,C, BC849B,C	$V_{(BR)CEO}$	65 45 30	— — —	— — —	V
Collector–Emitter Breakdown Voltage ($I_C = 10\ \mu\text{A}$, $V_{EB} = 0$)	BC846A,B BC847A,B,C, BC850B,C BC848A,B,C, BC849B,C	$V_{(BR)CES}$	80 50 30	— — —	— — —	V
Collector–Base Breakdown Voltage ($I_C = 10\ \mu\text{A}$)	BC846A,B BC847A,B,C, BC850B,C BC848A,B,C, BC849B,C	$V_{(BR)CBO}$	80 50 30	— — —	— — —	V
Emitter–Base Breakdown Voltage ($I_E = 1.0\ \mu\text{A}$)	BC846A,B BC847A,B,C BC848A,B,C, BC849B,C, BC850B,C	$V_{(BR)EBO}$	6.0 6.0 5.0	— — —	— — —	V
Collector Cutoff Current ($V_{CB} = 30\text{ V}$) ($V_{CB} = 30\text{ V}$, $T_A = 150^\circ\text{C}$)		I_{CBO}	— —	— —	15 5.0	nA μA

1. FR–5 = 1.0 x 0.75 x 0.062 in 2. Alumina = 0.4 x 0.3 x 0.024 in. 99.5% alumina.

Preferred devices are Motorola recommended choices for future use and best overall value.

REV 1



CASE 318–08, STYLE 6
SOT–23 (TO–236AB)

BC846ALT1,BLT1 BC847ALT1, BLT1,CLT1 thru BC850BLT1,CLT1

ELECTRICAL CHARACTERISTICS (T_A = 25°C unless otherwise noted) (Continued)

Characteristic	Symbol	Min	Typ	Max	Unit
ON CHARACTERISTICS					
DC Current Gain (I _C = 10 μA, V _{CE} = 5.0 V)	BC846A, BC847A, BC848A	—	90	—	—
	BC846B, BC847B, BC848B BC847C, BC848C	—	150 270	—	—
(I _C = 2.0 mA, V _{CE} = 5.0 V)	BC846A, BC847A, BC848A BC846B, BC847B, BC848B, BC849B, BC850B BC847C, BC848C, BC849C, BC850C	110 200 420	180 290 520	220 450 800	—
Collector–Emitter Saturation Voltage (I _C = 10 mA, I _B = 0.5 mA) (I _C = 100 mA, I _B = 5.0 mA)	V _{CE(sat)}	— —	— —	0.25 0.6	V
Base–Emitter Saturation Voltage (I _C = 10 mA, I _B = 0.5 mA) (I _C = 100 mA, I _B = 5.0 mA)	V _{BE(sat)}	— —	0.7 0.9	— —	V
Base–Emitter Voltage (I _C = 2.0 mA, V _{CE} = 5.0 V) (I _C = 10 mA, V _{CE} = 5.0 V)	V _{BE(on)}	580 —	660 —	700 770	mV
SMALL–SIGNAL CHARACTERISTICS					
Current–Gain — Bandwidth Product (I _C = 10 mA, V _{CE} = 5.0 Vdc, f = 100 MHz)	f _T	100	—	—	MHz
Output Capacitance (V _{CB} = 10 V, f = 1.0 MHz)	C _{obo}	—	—	4.5	pF
Noise Figure (I _C = 0.2 mA, V _{CE} = 5.0 Vdc, R _S = 2.0 kΩ, f = 1.0 kHz, BW = 200 Hz)	BC846A, BC847A, BC848A BC846B, BC847B, BC848B BC847C, BC848C BC849B,C, BC850B,C	NF	— —	10 4.0	dB

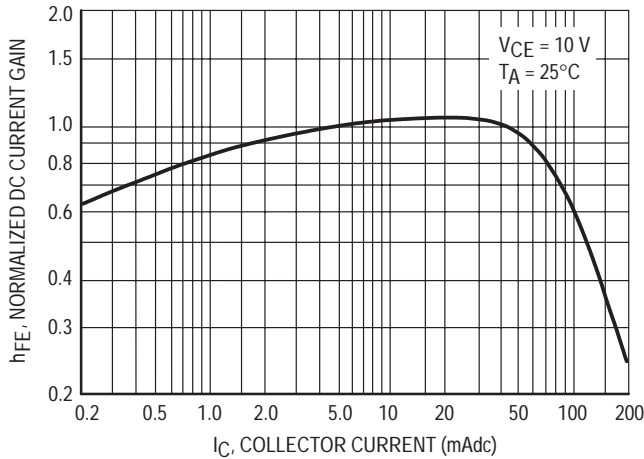


Figure 1. Normalized DC Current Gain

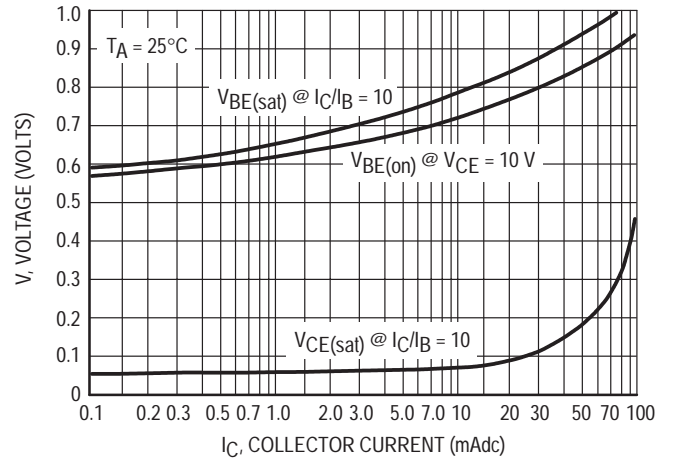


Figure 2. "Saturation" and "On" Voltages

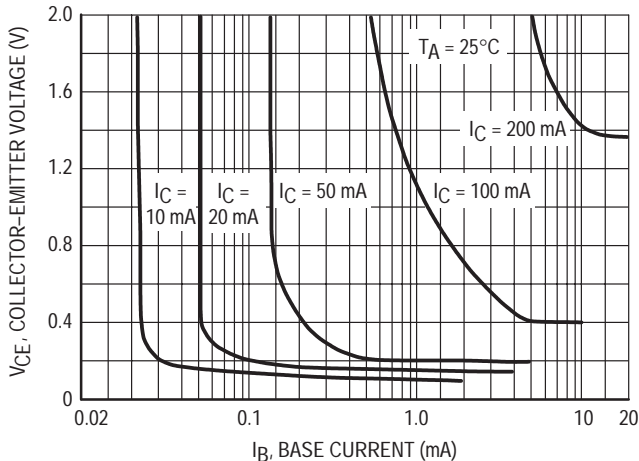


Figure 3. Collector Saturation Region

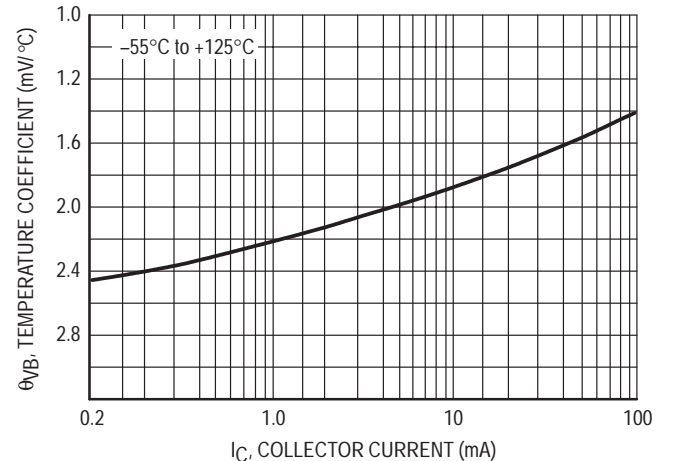


Figure 4. Base–Emitter Temperature Coefficient

BC847/BC848

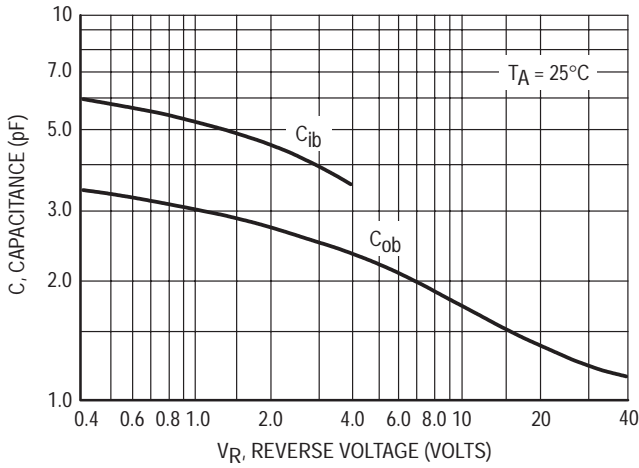


Figure 5. Capacitances

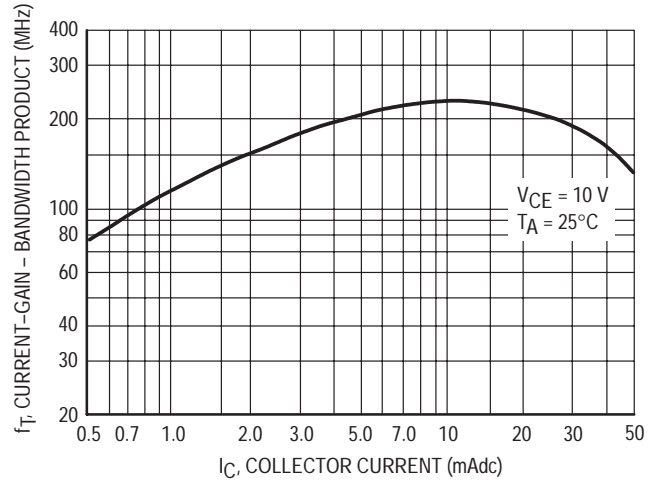


Figure 6. Current-Gain - Bandwidth Product

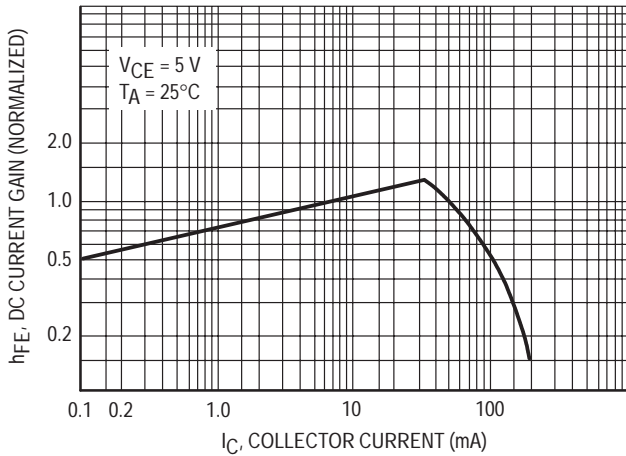


Figure 7. DC Current Gain

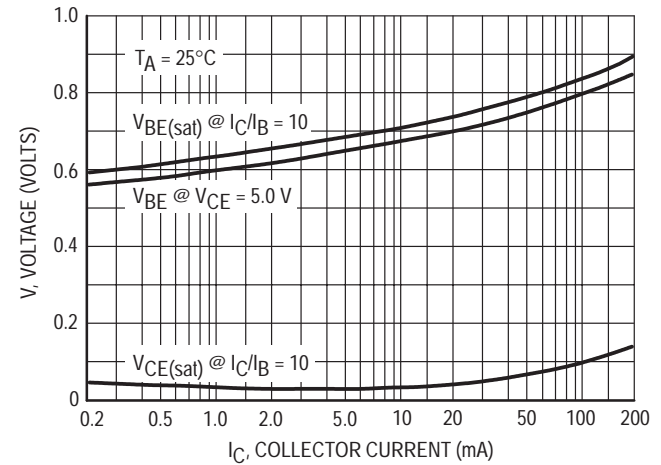


Figure 8. "On" Voltage

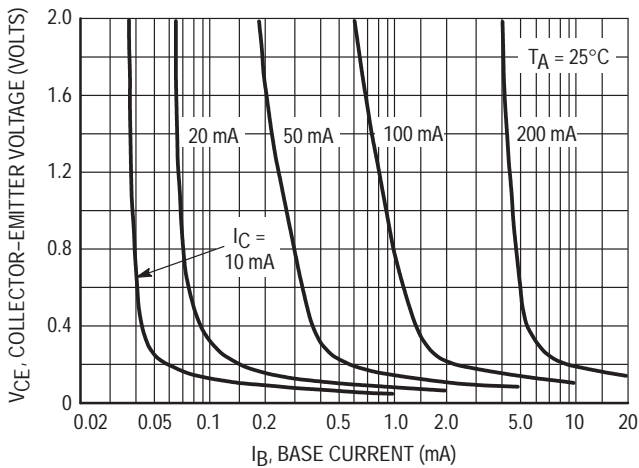


Figure 9. Collector Saturation Region

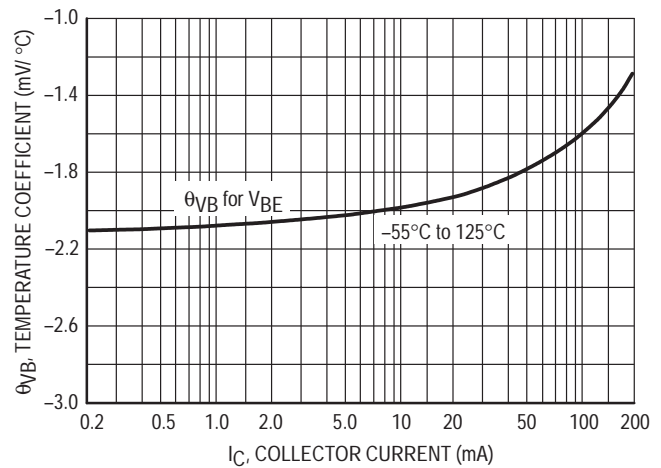


Figure 10. Base-Emitter Temperature Coefficient

BC846

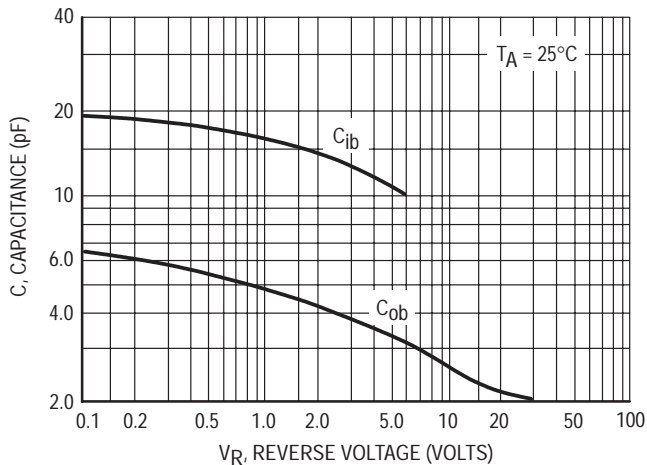


Figure 11. Capacitance

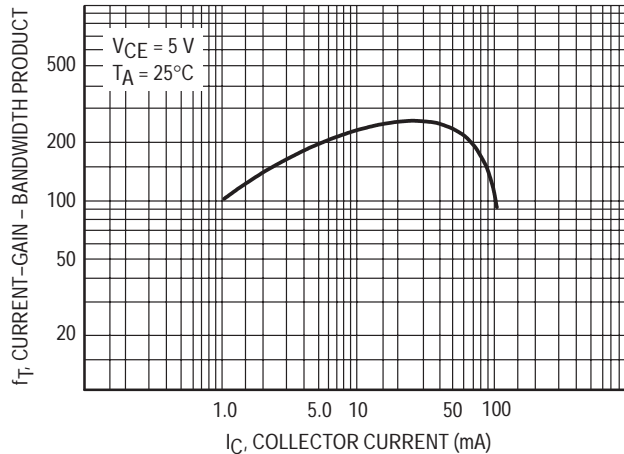
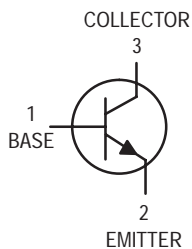


Figure 12. Current-Gain - Bandwidth Product

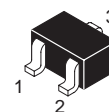
General Purpose Transistors

NPN Silicon

These transistors are designed for general purpose amplifier applications. They are housed in the SOT-323/SC-70 which is designed for low power surface mount applications.



BC846AWT1,BWT1
BC847AWT1,BWT1,
CWT1
BC848AWT1,BWT1,
CWT1



CASE 419-02, STYLE 3
SOT-323/SC-70

MAXIMUM RATINGS

Rating	Symbol	BC846	BC847	BC848	Unit
Collector–Emitter Voltage	V_{CEO}	65	45	30	V
Collector–Base Voltage	V_{CBO}	80	50	30	V
Emitter–Base Voltage	V_{EBO}	6.0	6.0	5.0	V
Collector Current — Continuous	I_C	100	100	100	mAdc

THERMAL CHARACTERISTICS

Characteristic	Symbol	Max	Unit
Total Device Dissipation FR-5 Board, (1) $T_A = 25^\circ\text{C}$	P_D	150	mW
Thermal Resistance, Junction to Ambient	$R_{\theta JA}$	833	$^\circ\text{C/W}$
Total Device Dissipation	P_D	2.4	mW/ $^\circ\text{C}$
Junction and Storage Temperature	T_J, T_{stg}	-55 to +150	$^\circ\text{C}$

DEVICE MARKING

BC846AWT1 = 1A; BC846BWT1 = 1B; BC847AWT1 = 1E; BC847BWT1 = 1F;
BC847CWT1 = 1G; BC848AWT1 = 1J; BC848BWT1 = 1K; BC848CWT1 = 1L

ELECTRICAL CHARACTERISTICS ($T_A = 25^\circ\text{C}$ unless otherwise noted)

Characteristic	Symbol	Min	Typ	Max	Unit
----------------	--------	-----	-----	-----	------

OFF CHARACTERISTICS

Collector–Emitter Breakdown Voltage ($I_C = 10\text{ mA}$)	BC846 Series BC847 Series BC848 Series	$V_{(BR)CEO}$	65 45 30	— — —	— — —	V
Collector–Emitter Breakdown Voltage ($I_C = 10\ \mu\text{A}, V_{EB} = 0$)	BC846 Series BC847 Series BC848 Series	$V_{(BR)CES}$	80 50 30	— — —	— — —	V
Collector–Base Breakdown Voltage ($I_C = 10\ \mu\text{A}$)	BC846 Series BC847 Series BC848 Series	$V_{(BR)CBO}$	80 50 30	— — —	— — —	V
Emitter–Base Breakdown Voltage ($I_E = 1.0\ \mu\text{A}$)	BC846 Series BC847 Series BC848 Series	$V_{(BR)EBO}$	6.0 6.0 5.0	— — —	— — —	V
Collector Cutoff Current ($V_{CB} = 30\text{ V}$) ($V_{CB} = 30\text{ V}, T_A = 150^\circ\text{C}$)		I_{CBO}	— —	— —	15 5.0	nA μA

1. FR-5 = 1.0 x 0.75 x 0.062 in

ELECTRICAL CHARACTERISTICS (T_A = 25°C unless otherwise noted) (Continued)

Characteristic	Symbol	Min	Typ	Max	Unit
ON CHARACTERISTICS					
DC Current Gain (I _C = 10 μA, V _{CE} = 5.0 V)	BC846A, BC847A, BC848A	—	90	—	—
	BC846B, BC847B, BC848B BC847C, BC848C	—	150 270	—	—
(I _C = 2.0 mA, V _{CE} = 5.0 V)	BC846A, BC847A, BC848A	110	180	220	—
	BC846B, BC847B, BC848B BC847C, BC848C	200 420	290 520	450 800	—
Collector–Emitter Saturation Voltage (I _C = 10 mA, I _B = 0.5 mA) (I _C = 100 mA, I _B = 5.0 mA)	V _{CE(sat)}	—	—	0.25 0.6	V
Base–Emitter Saturation Voltage (I _C = 10 mA, I _B = 0.5 mA) (I _C = 100 mA, I _B = 5.0 mA)	V _{BE(sat)}	—	0.7 0.9	—	V
Base–Emitter Voltage (I _C = 2.0 mA, V _{CE} = 5.0 V) (I _C = 10 mA, V _{CE} = 5.0 V)	V _{BE(on)}	580	660	700 770	mV

SMALL-SIGNAL CHARACTERISTICS

Current–Gain — Bandwidth Product (I _C = 10 mA, V _{CE} = 5.0 Vdc, f = 100 MHz)	f _T	100	—	—	MHz
Output Capacitance (V _{CB} = 10 V, f = 1.0 MHz)	C _{obo}	—	—	4.5	pF
Noise Figure (I _C = 0.2 mA, V _{CE} = 5.0 Vdc, R _S = 2.0 kΩ, f = 1.0 kHz, BW = 200 Hz)	NF	—	—	10 4.0	dB

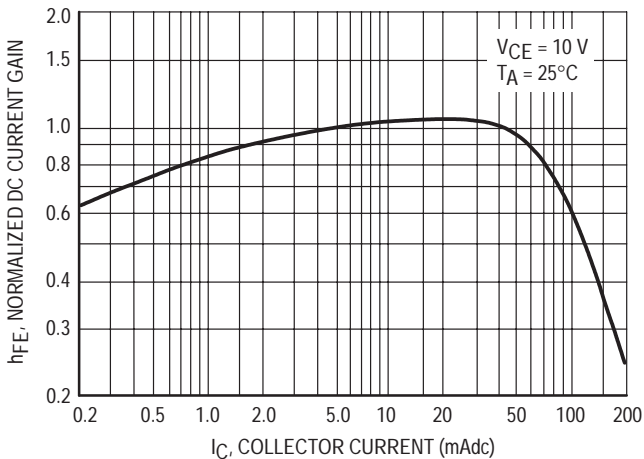


Figure 1. Normalized DC Current Gain

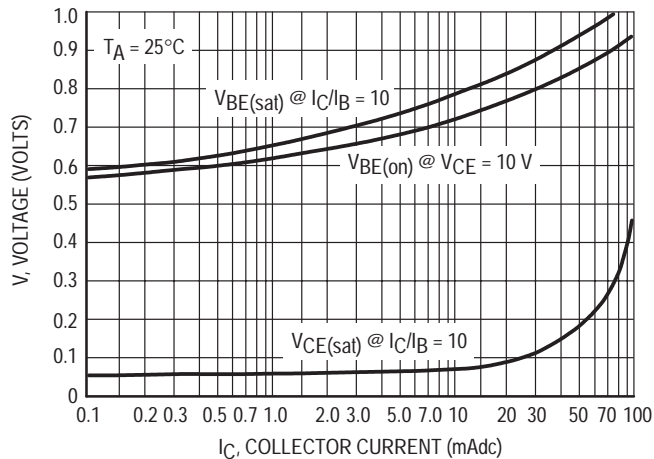


Figure 2. “Saturation” and “On” Voltages

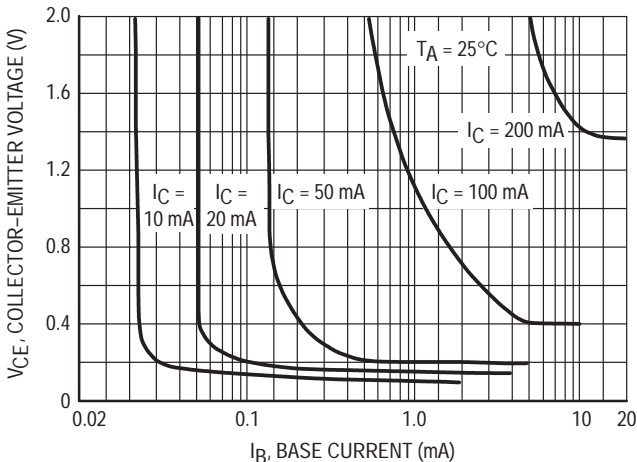


Figure 3. Collector Saturation Region

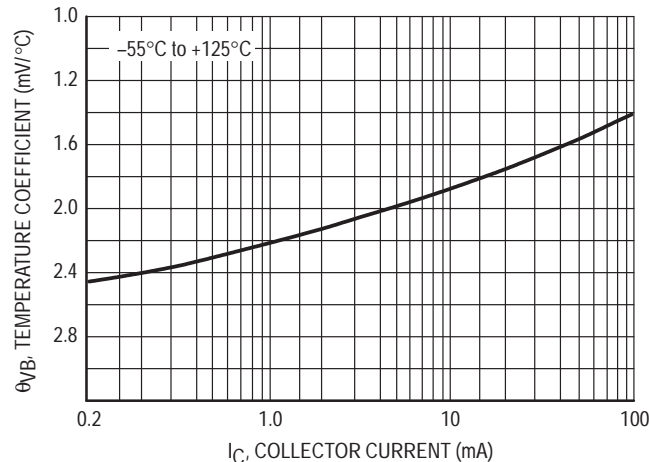


Figure 4. Base–Emitter Temperature Coefficient

BC847/BC848

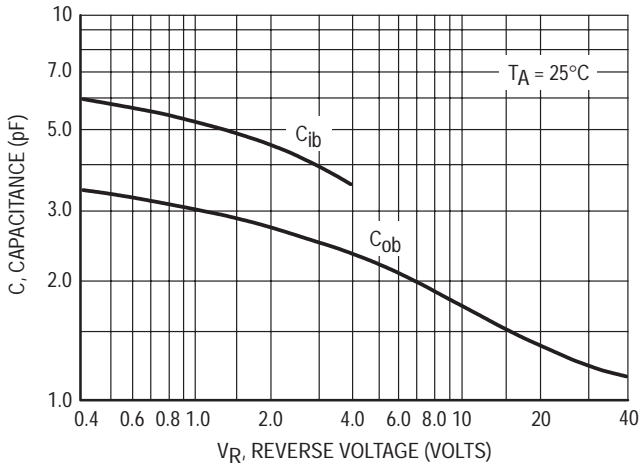


Figure 5. Capacitances

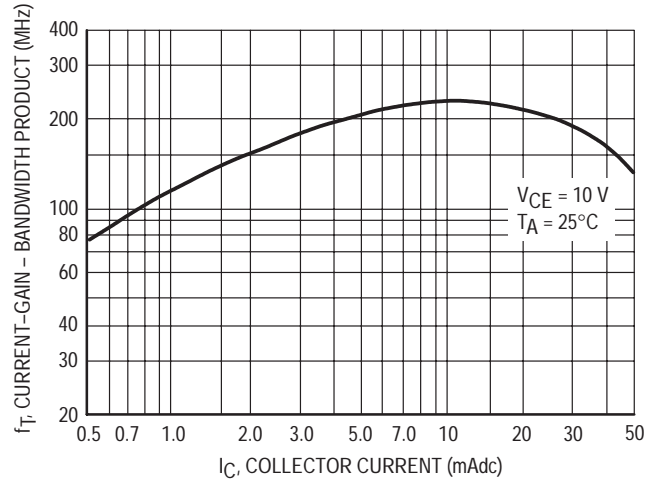


Figure 6. Current-Gain - Bandwidth Product

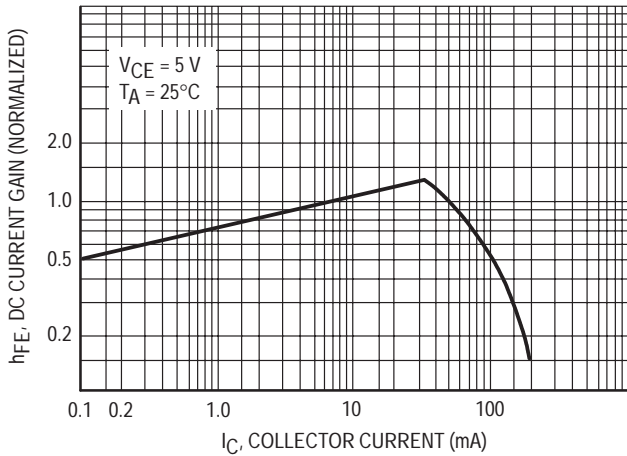


Figure 7. DC Current Gain

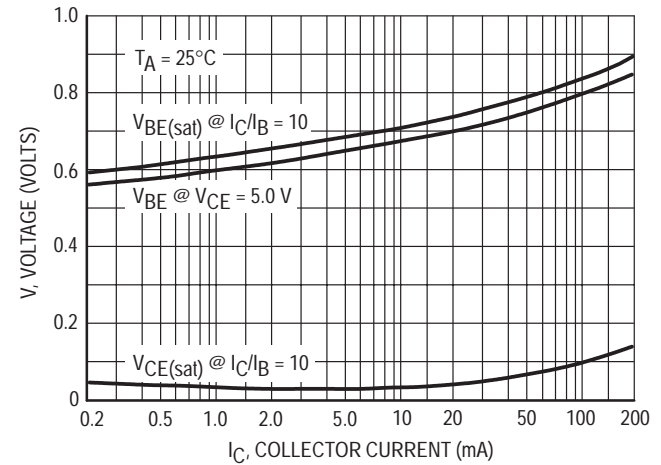


Figure 8. "On" Voltage

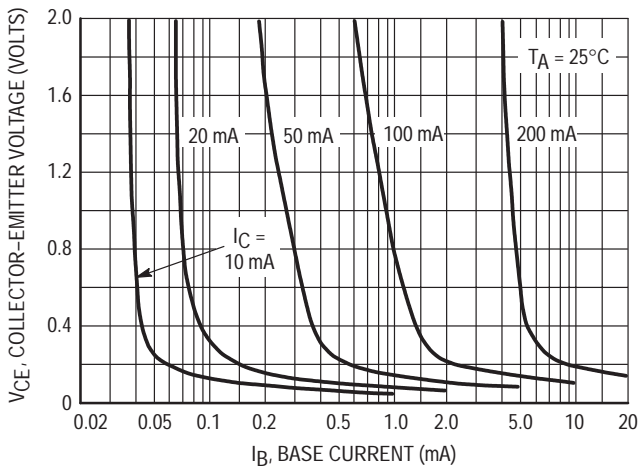


Figure 9. Collector Saturation Region

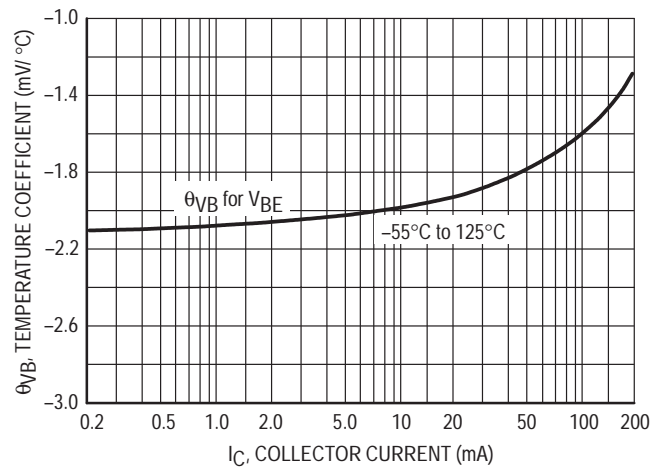


Figure 10. Base-Emitter Temperature Coefficient

BC846

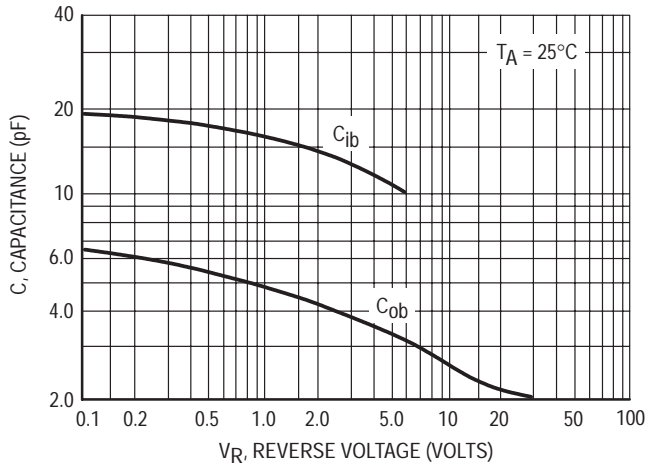


Figure 11. Capacitance

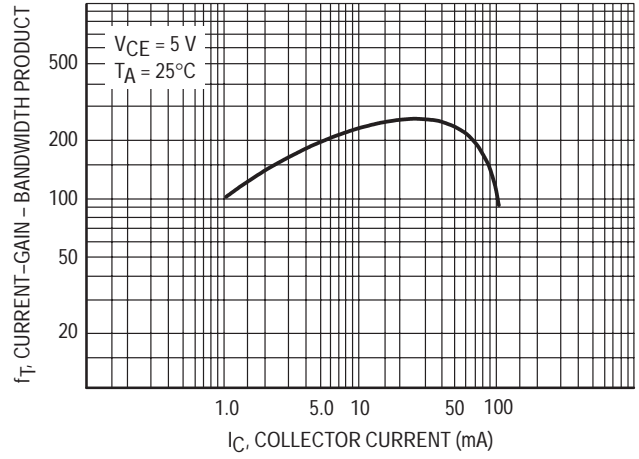
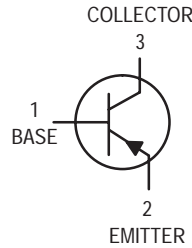


Figure 12. Current-Gain - Bandwidth Product

General Purpose Transistors

PNP Silicon

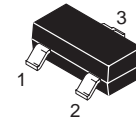


**BC856ALT1,BLT1
BC857ALT1,BLT1
BC858ALT1,BLT1,
CLT1**

Motorola Preferred Devices

MAXIMUM RATINGS

Rating	Symbol	BC856	BC857	BC858	Unit
Collector–Emitter Voltage	V_{CEO}	–65	–45	–30	V
Collector–Base Voltage	V_{CBO}	–80	–50	–30	V
Emitter–Base Voltage	V_{EBO}	–5.0	–5.0	–5.0	V
Collector Current — Continuous	I_C	–100	–100	–100	mAdc



CASE 318–08, STYLE 6
SOT–23 (TO–236AB)

THERMAL CHARACTERISTICS

Characteristic	Symbol	Max	Unit
Total Device Dissipation FR–5 Board, (1) $T_A = 25^\circ\text{C}$ Derate above 25°C	P_D	225 1.8	mW mW/ $^\circ\text{C}$
Thermal Resistance, Junction to Ambient	$R_{\theta JA}$	556	$^\circ\text{C}/\text{W}$
Total Device Dissipation Alumina Substrate, (2) $T_A = 25^\circ\text{C}$ Derate above 25°C	P_D	300 2.4	mW mW/ $^\circ\text{C}$
Thermal Resistance, Junction to Ambient	$R_{\theta JA}$	417	$^\circ\text{C}/\text{W}$
Junction and Storage Temperature	T_J, T_{stg}	–55 to +150	$^\circ\text{C}$

DEVICE MARKING

BC856ALT1 = 3A; BC856BLT1 = 3B; BC857ALT1 = 3E; BC857BLT1 = 3F;
BC858ALT1 = 3J; BC858BLT1 = 3K; BC858CLT1 = 3L

ELECTRICAL CHARACTERISTICS ($T_A = 25^\circ\text{C}$ unless otherwise noted)

Characteristic	Symbol	Min	Typ	Max	Unit
----------------	--------	-----	-----	-----	------

OFF CHARACTERISTICS

Collector–Emitter Breakdown Voltage ($I_C = -10\text{ mA}$)	BC856 Series BC857 Series BC858 Series	$V_{(BR)CEO}$	–65 –45 –30	— — —	— — —	V
Collector–Emitter Breakdown Voltage ($I_C = -10\ \mu\text{A}, V_{EB} = 0$)	BC856 Series BC857 Series BC858 Series	$V_{(BR)CES}$	–80 –50 –30	— — —	— — —	V
Collector–Base Breakdown Voltage ($I_C = -10\ \mu\text{A}$)	BC856 Series BC857 Series BC858 Series	$V_{(BR)CBO}$	–80 –50 –30	— — —	— — —	V
Emitter–Base Breakdown Voltage ($I_E = -1.0\ \mu\text{A}$)	BC856 Series BC857 Series BC858 Series	$V_{(BR)EBO}$	–5.0 –5.0 –5.0	— — —	— — —	V
Collector Cutoff Current ($V_{CB} = -30\text{ V}$) ($V_{CB} = -30\text{ V}, T_A = 150^\circ\text{C}$)		I_{CBO}	— —	— —	–15 –4.0	nA μA

1. FR–5 = 1.0 x 0.75 x 0.062 in 2. Alumina = 0.4 x 0.3 x 0.024 in. 99.5% alumina.

Preferred devices are Motorola recommended choices for future use and best overall value.

BC856ALT1,BLT1 BC857ALT1,BLT1 BC858ALT1,BLT1,CLT1

ELECTRICAL CHARACTERISTICS ($T_A = 25^\circ\text{C}$ unless otherwise noted) (Continued)

Characteristic	Symbol	Min	Typ	Max	Unit
ON CHARACTERISTICS					
DC Current Gain ($I_C = -10\ \mu\text{A}$, $V_{CE} = -5.0\ \text{V}$)	BC856A, BC857A, BC858A BC856A, BC857A, BC858A BC858C	h_{FE}	— — —	90 150 270	— — —
($I_C = -2.0\ \text{mA}$, $V_{CE} = -5.0\ \text{V}$)	BC856A, BC857A, BC858A BC856B, BC857B, BC858B BC858C		125 220 420	180 290 520	250 475 800
Collector–Emitter Saturation Voltage ($I_C = -10\ \text{mA}$, $I_B = -0.5\ \text{mA}$) ($I_C = -100\ \text{mA}$, $I_B = -5.0\ \text{mA}$)	$V_{CE(sat)}$	— —	— —	— —	—0.3 —0.65
Base–Emitter Saturation Voltage ($I_C = -10\ \text{mA}$, $I_B = -0.5\ \text{mA}$) ($I_C = -100\ \text{mA}$, $I_B = -5.0\ \text{mA}$)	$V_{BE(sat)}$	— —	—0.7 —0.9	— —	— —
Base–Emitter On Voltage ($I_C = -2.0\ \text{mA}$, $V_{CE} = -5.0\ \text{V}$) ($I_C = -10\ \text{mA}$, $V_{CE} = -5.0\ \text{V}$)	$V_{BE(on)}$	—0.6 —	— —	— —	—0.75 —0.82
SMALL–SIGNAL CHARACTERISTICS					
Current–Gain — Bandwidth Product ($I_C = -10\ \text{mA}$, $V_{CE} = -5.0\ \text{Vdc}$, $f = 100\ \text{MHz}$)	f_T	100	—	—	MHz
Output Capacitance ($V_{CB} = -10\ \text{V}$, $f = 1.0\ \text{MHz}$)	C_{ob}	—	—	4.5	pF
Noise Figure ($I_C = -0.2\ \text{mA}$, $V_{CE} = -5.0\ \text{Vdc}$, $R_S = 2.0\ \text{k}\Omega$, $f = 1.0\ \text{kHz}$, $BW = 200\ \text{Hz}$)	NF	—	—	10	dB

BC857/BC858

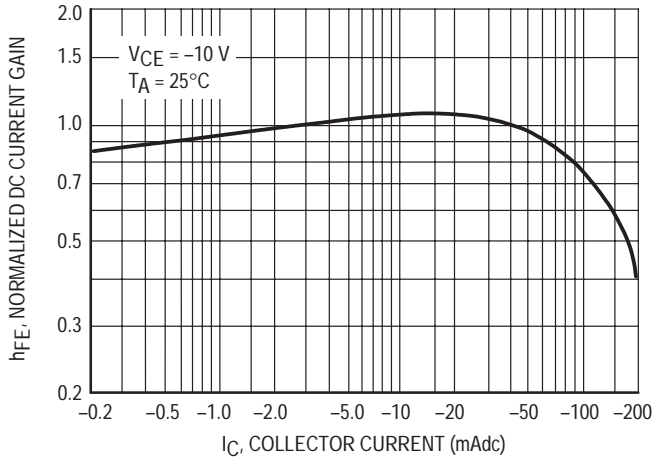


Figure 1. Normalized DC Current Gain

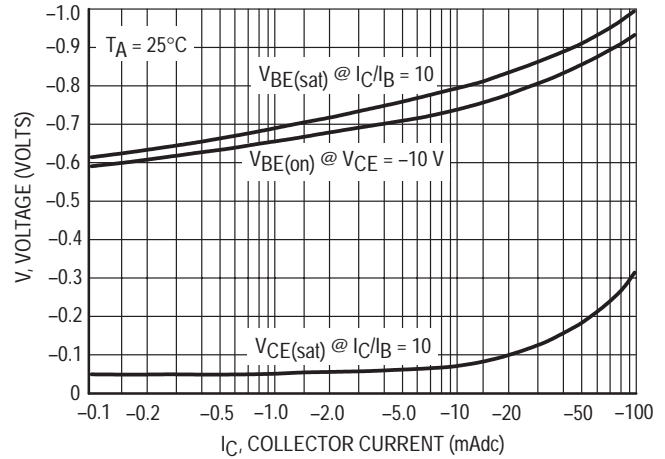


Figure 2. "Saturation" and "On" Voltages

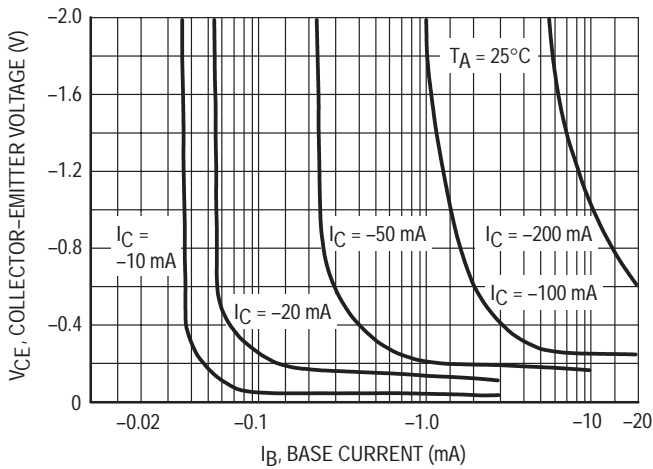


Figure 3. Collector Saturation Region

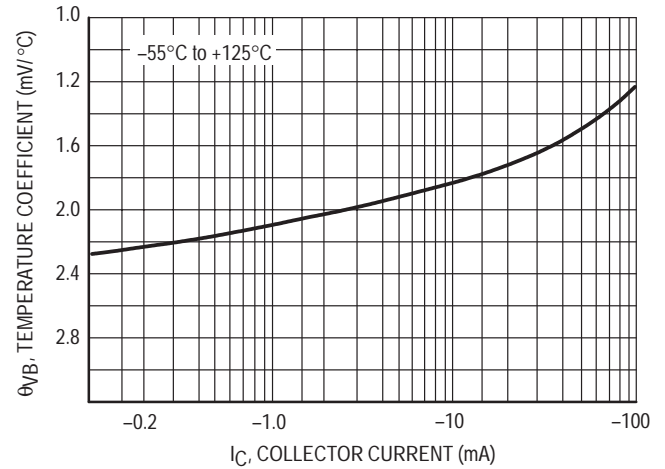


Figure 4. Base-Emitter Temperature Coefficient

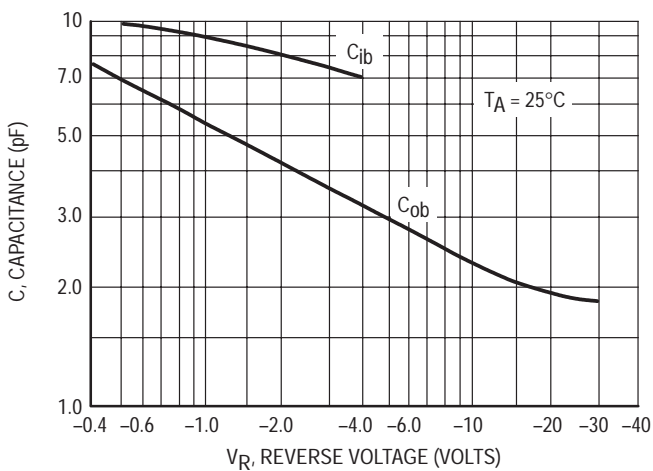


Figure 5. Capacitances

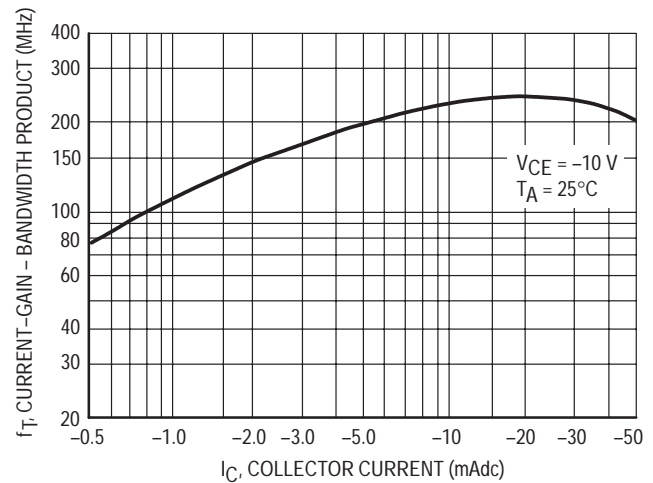


Figure 6. Current-Gain - Bandwidth Product

BC856

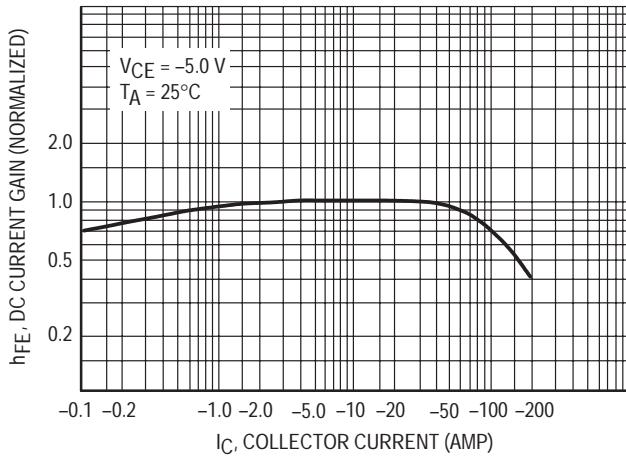


Figure 7. DC Current Gain

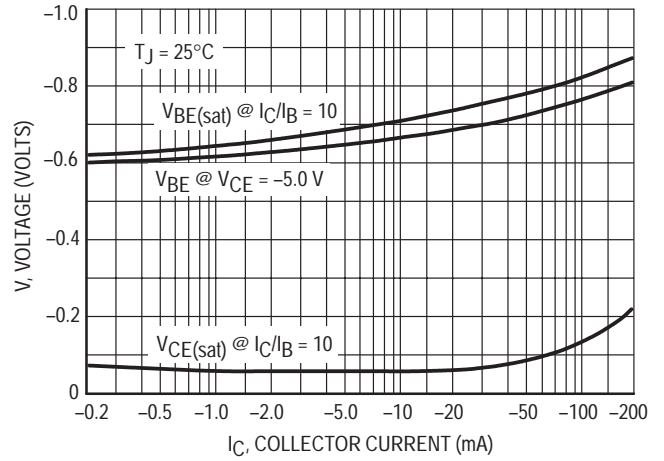


Figure 8. "On" Voltage

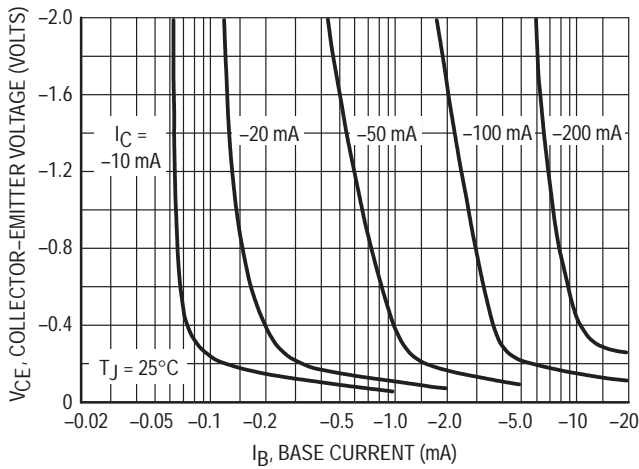


Figure 9. Collector Saturation Region

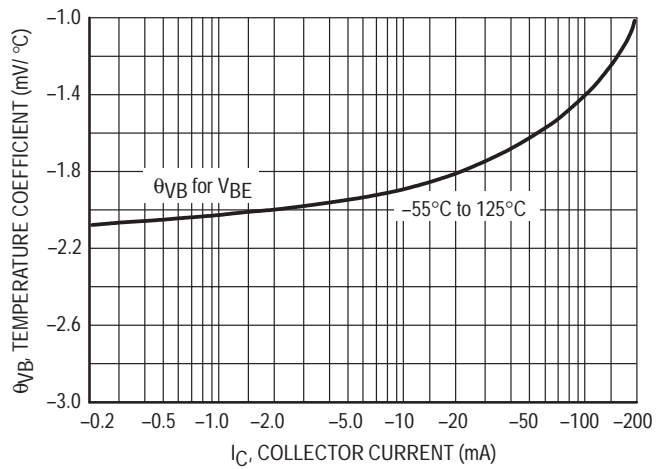


Figure 10. Base-Emitter Temperature Coefficient

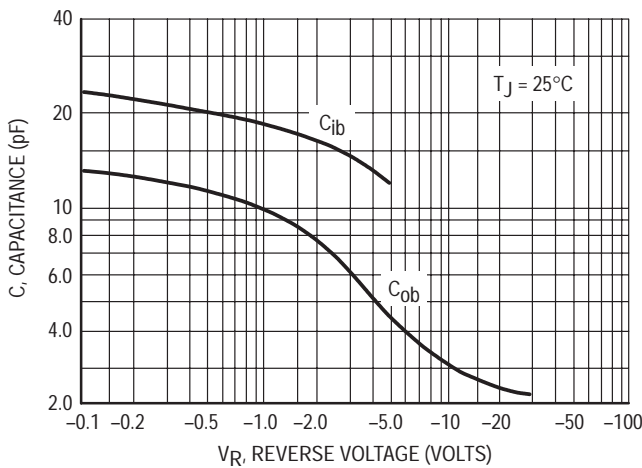


Figure 11. Capacitance

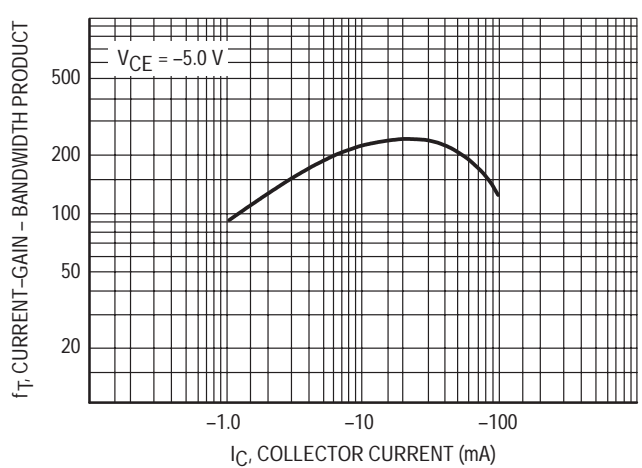


Figure 12. Current-Gain - Bandwidth Product

BC856ALT1,BLT1 BC857ALT1,BLT1 BC858ALT1,BLT1,CLT1

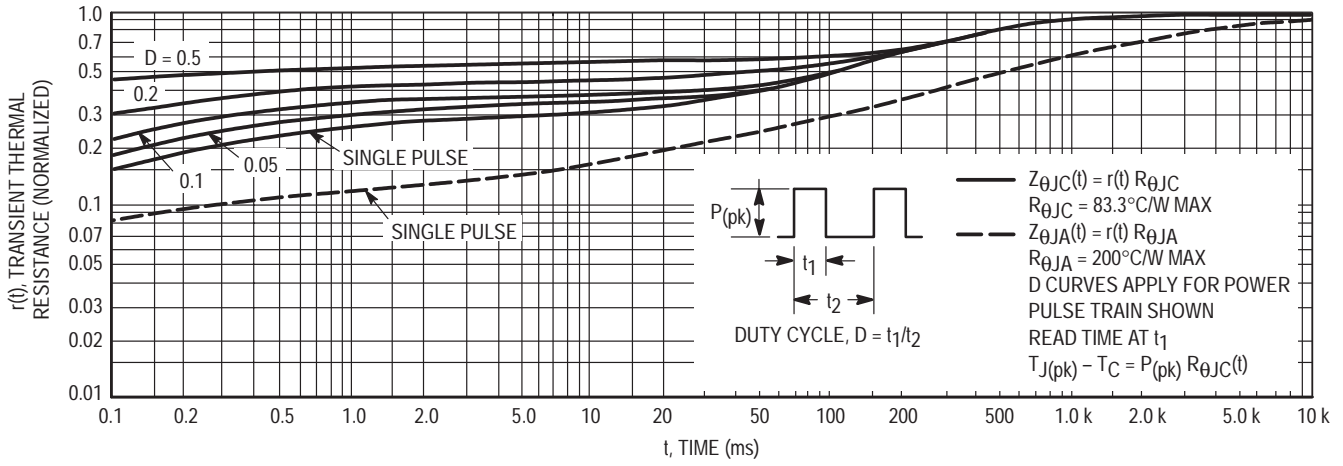


Figure 13. Thermal Response

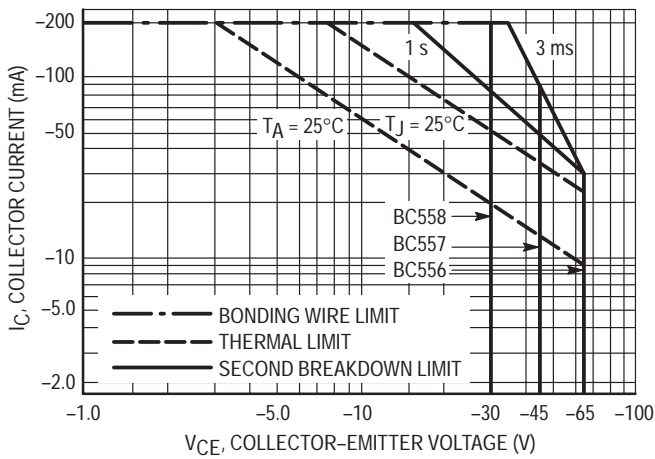


Figure 14. Active Region Safe Operating Area

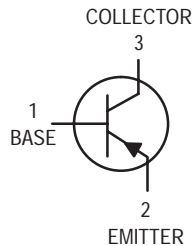
The safe operating area curves indicate I_C - V_{CE} limits of the transistor that must be observed for reliable operation. Collector load lines for specific circuits must fall below the limits indicated by the applicable curve.

The data of Figure 14 is based upon $T_{J(pk)} = 150^\circ\text{C}$; T_C or T_A is variable depending upon conditions. Pulse curves are valid for duty cycles to 10% provided $T_{J(pk)} \leq 150^\circ\text{C}$. $T_{J(pk)}$ may be calculated from the data in Figure 13. At high case or ambient temperatures, thermal limitations will reduce the power that can be handled to values less than the limitations imposed by the secondary breakdown.

General Purpose Transistors

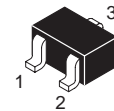
PNP Silicon

These transistors are designed for general purpose amplifier applications. They are housed in the SOT-323/SC-70 which is designed for low power surface mount applications.



BC856AWT1,BWT1
BC857AWT1,BWT1
BC858AWT1,BWT1,
CWT1

Motorola Preferred Devices



CASE 419-02, STYLE 3
SOT-323/SC-70

MAXIMUM RATINGS

Rating	Symbol	BC856	BC857	BC858	Unit
Collector–Emitter Voltage	V_{CEO}	-65	-45	-30	V
Collector–Base Voltage	V_{CBO}	-80	-50	-30	V
Emitter–Base Voltage	V_{EBO}	-5.0	-5.0	-5.0	V
Collector Current — Continuous	I_C	-100	-100	-100	mAdc

THERMAL CHARACTERISTICS

Characteristic	Symbol	Max	Unit
Total Device Dissipation FR-5 Board, (1) $T_A = 25^\circ\text{C}$	P_D	150	mW
Thermal Resistance, Junction to Ambient	$R_{\theta JA}$	833	$^\circ\text{C}/\text{W}$
Junction and Storage Temperature	T_J, T_{stg}	-55 to +150	$^\circ\text{C}$

DEVICE MARKING

BC856AWT1 = 3A; BC856BWT1 = 3B; BC857AWT1 = 3E; BC857BWT1 = 3F;
BC858AWT1 = 3J; BC858BWT1 = 3K; BC858CWT1 = 3L

ELECTRICAL CHARACTERISTICS ($T_A = 25^\circ\text{C}$ unless otherwise noted)

Characteristic	Symbol	Min	Typ	Max	Unit
----------------	--------	-----	-----	-----	------

OFF CHARACTERISTICS

Collector–Emitter Breakdown Voltage ($I_C = -10\text{ mA}$)	BC856 Series BC857 Series BC858 Series	$V_{(BR)CEO}$	-65 -45 -30	— — —	— — —	V
Collector–Emitter Breakdown Voltage ($I_C = -10\ \mu\text{A}, V_{EB} = 0$)	BC856 Series BC857 Series BC858 Series	$V_{(BR)CES}$	-80 -50 -30	— — —	— — —	V
Collector–Base Breakdown Voltage ($I_C = -10\ \mu\text{A}$)	BC856 Series BC857 Series BC858 Series	$V_{(BR)CBO}$	-80 -50 -30	— — —	— — —	V
Emitter–Base Breakdown Voltage ($I_E = -1.0\ \mu\text{A}$)	BC856 Series BC857 Series BC858 Series	$V_{(BR)EBO}$	-5.0 -5.0 -5.0	— — —	— — —	V
Collector Cutoff Current ($V_{CB} = -30\text{ V}$) ($V_{CB} = -30\text{ V}, T_A = 150^\circ\text{C}$)		I_{CBO}	— —	— —	-15 -4.0	nA μA

1. FR-5 = 1.0 x 0.75 x 0.062 in

Preferred devices are Motorola recommended choices for future use and best overall value.

BC856AWT1,BWT1 BC857AWT1,BWT1 BC858AWT1,BWT1,CWT1
ELECTRICAL CHARACTERISTICS ($T_A = 25^\circ\text{C}$ unless otherwise noted) (Continued)

Characteristic	Symbol	Min	Typ	Max	Unit
ON CHARACTERISTICS					
DC Current Gain ($I_C = -10\ \mu\text{A}$, $V_{CE} = -5.0\ \text{V}$)	BC856A, BC857A, BC585A BC856A, BC857A, BC858A BC858C	h_{FE}	— — —	90 150 270	— — —
($I_C = -2.0\ \text{mA}$, $V_{CE} = -5.0\ \text{V}$)	BC856A, BC857A, BC858A BC856B, BC857B, BC858B BC858C		125 220 420	180 290 520	250 475 800
Collector–Emitter Saturation Voltage ($I_C = -10\ \text{mA}$, $I_B = -0.5\ \text{mA}$) ($I_C = -100\ \text{mA}$, $I_B = -5.0\ \text{mA}$)	$V_{CE(\text{sat})}$	— —	— —	—0.3 —0.65	V
Base–Emitter Saturation Voltage ($I_C = -10\ \text{mA}$, $I_B = -0.5\ \text{mA}$) ($I_C = -100\ \text{mA}$, $I_B = -5.0\ \text{mA}$)	$V_{BE(\text{sat})}$	— —	—0.7 —0.9	— —	V
Base–Emitter On Voltage ($I_C = -2.0\ \text{mA}$, $V_{CE} = -5.0\ \text{V}$) ($I_C = -10\ \text{mA}$, $V_{CE} = -5.0\ \text{V}$)	$V_{BE(\text{on})}$	—0.6 —	— —	—0.75 —0.82	V
SMALL–SIGNAL CHARACTERISTICS					
Current–Gain — Bandwidth Product ($I_C = -10\ \text{mA}$, $V_{CE} = -5.0\ \text{Vdc}$, $f = 100\ \text{MHz}$)	f_T	100	—	—	MHz
Output Capacitance ($V_{CB} = -10\ \text{V}$, $f = 1.0\ \text{MHz}$)	C_{ob}	—	—	4.5	pF
Noise Figure ($I_C = -0.2\ \text{mA}$, $V_{CE} = -5.0\ \text{Vdc}$, $R_S = 2.0\ \text{k}\Omega$, $f = 1.0\ \text{kHz}$, $BW = 200\ \text{Hz}$)	NF	—	—	10	dB

BC857/BC858

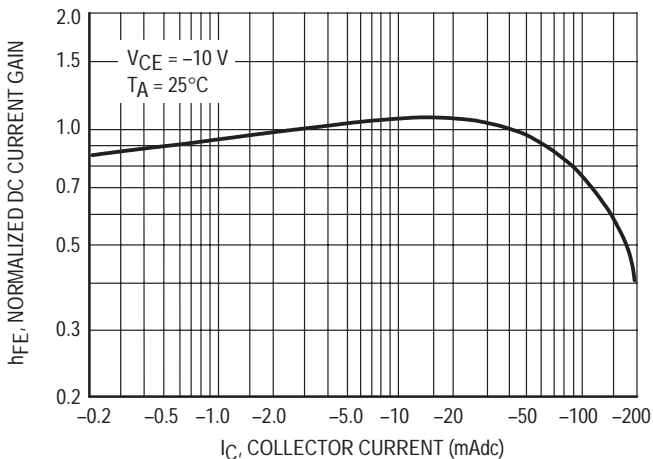


Figure 1. Normalized DC Current Gain

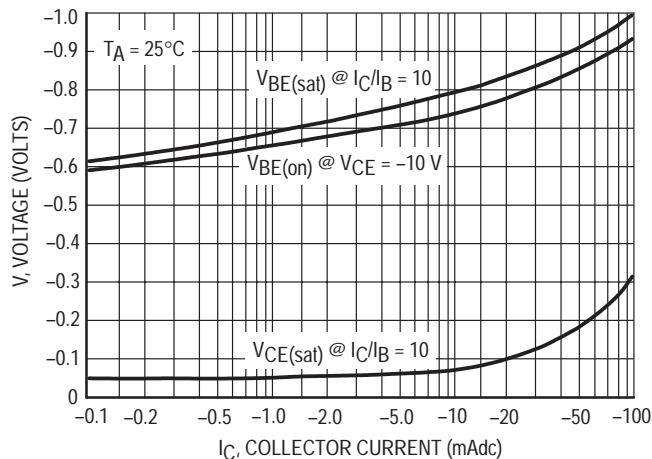


Figure 2. "Saturation" and "On" Voltages

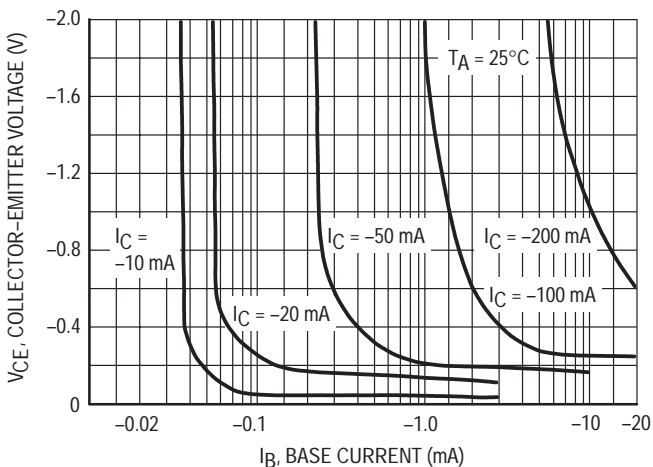


Figure 3. Collector Saturation Region

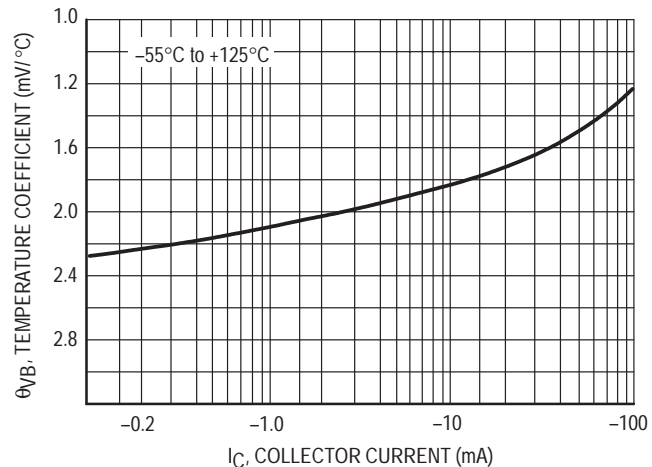


Figure 4. Base-Emitter Temperature Coefficient

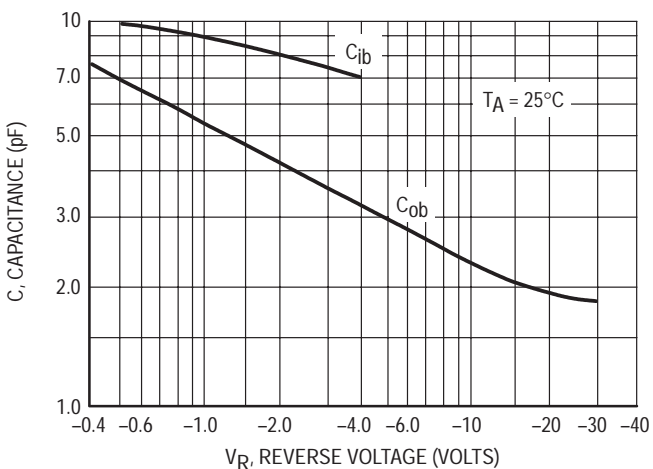


Figure 5. Capacitances

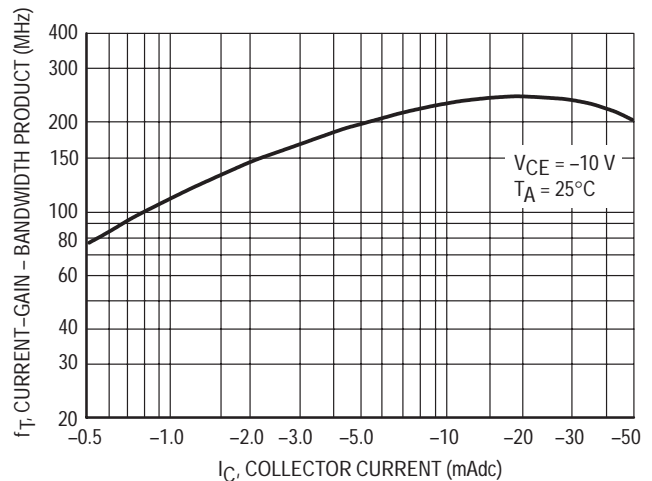


Figure 6. Current-Gain - Bandwidth Product

BC856

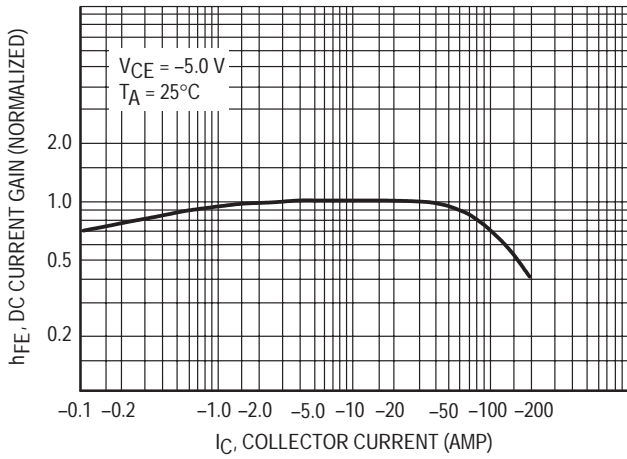


Figure 7. DC Current Gain

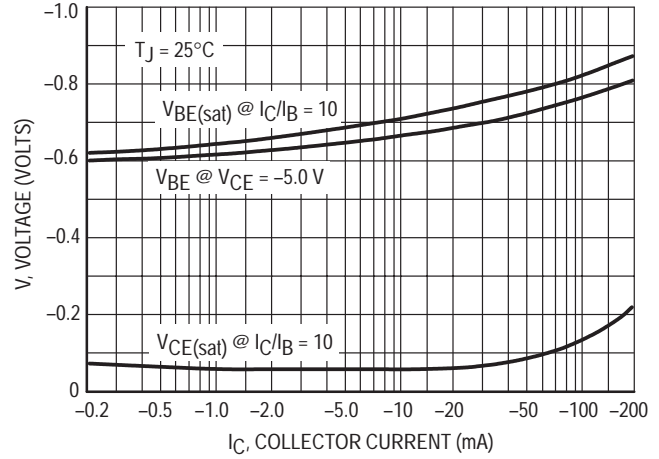


Figure 8. "On" Voltage

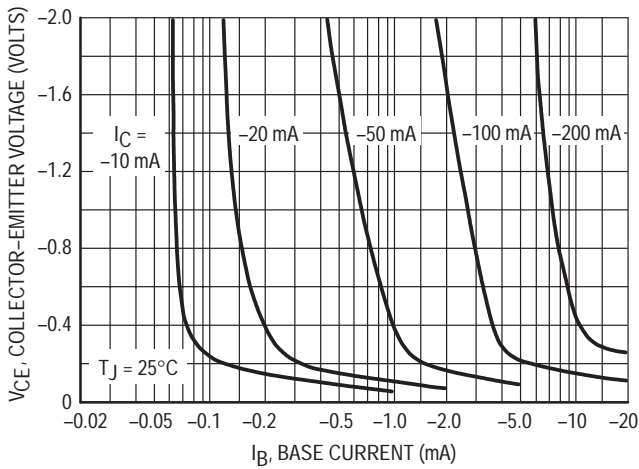


Figure 9. Collector Saturation Region

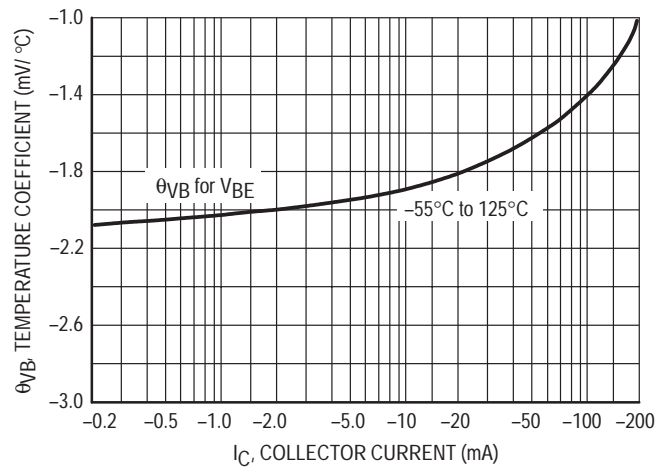


Figure 10. Base-Emitter Temperature Coefficient

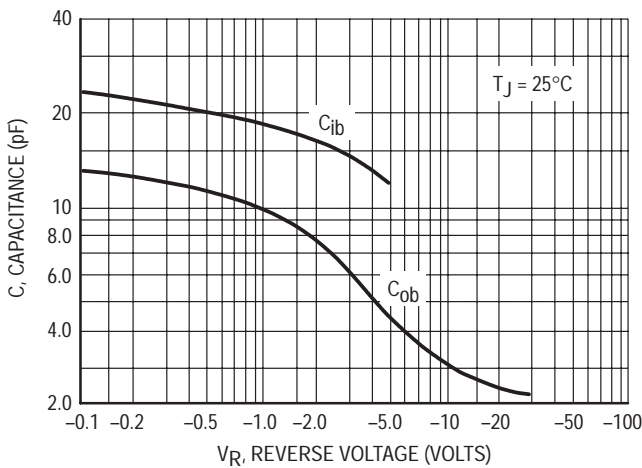


Figure 11. Capacitance

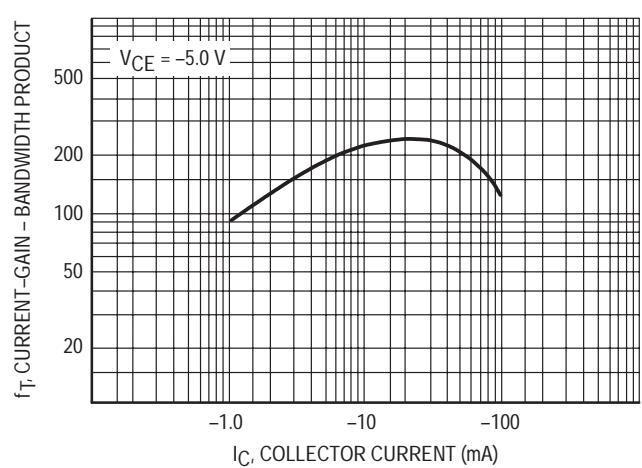


Figure 12. Current-Gain - Bandwidth Product

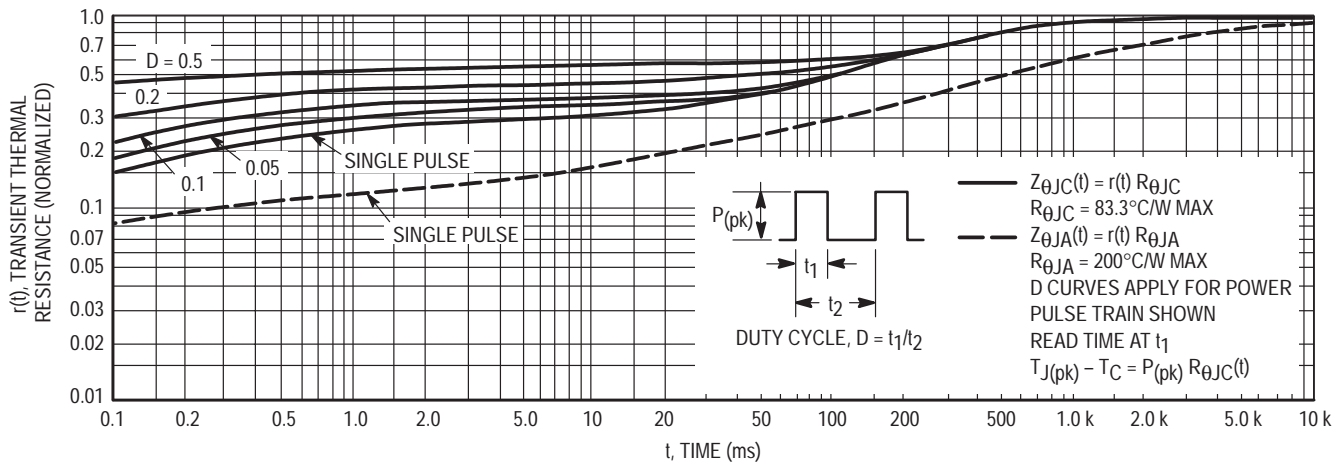


Figure 13. Thermal Response

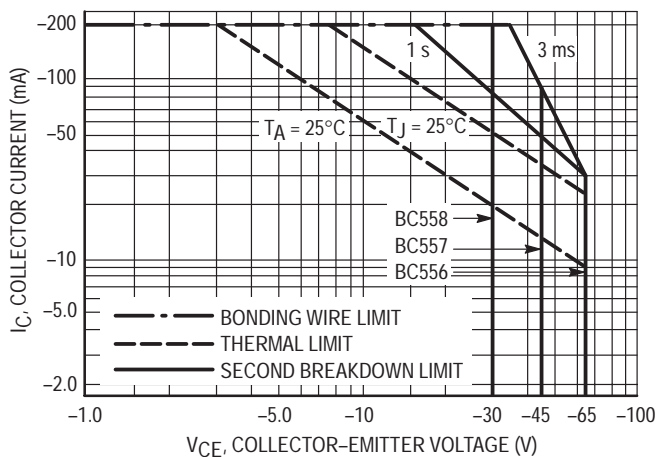


Figure 14. Active Region Safe Operating Area

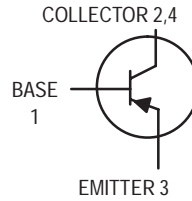
The safe operating area curves indicate I_C - V_{CE} limits of the transistor that must be observed for reliable operation. Collector load lines for specific circuits must fall below the limits indicated by the applicable curve.

The data of Figure 14 is based upon $T_{J(pk)} = 150^{\circ}\text{C}$; T_C or T_A is variable depending upon conditions. Pulse curves are valid for duty cycles to 10% provided $T_{J(pk)} \leq 150^{\circ}\text{C}$. $T_{J(pk)}$ may be calculated from the data in Figure 13. At high case or ambient temperatures, thermal limitations will reduce the power that can be handled to values less than the limitations imposed by the secondary breakdown.

PNP Silicon Epitaxial Transistor

This PNP Silicon Epitaxial transistor is designed for use in audio amplifier applications. The device is housed in the SOT-223 package which is designed for medium power surface mount applications.

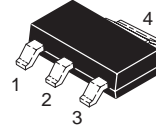
- High Current: 1.5 Amps
- NPN Complement is BCP56
- The SOT-223 Package can be soldered using wave or reflow. The formed leads absorb thermal stress during soldering, eliminating the possibility of damage to the die
- Available in 12 mm Tape and Reel
Use BCP53T1 to order the 7 inch/1000 unit reel.
Use BCP53T3 to order the 13 inch/4000 unit reel.



BCP53T1

Motorola Preferred Device

**MEDIUM POWER
PNP SILICON
HIGH CURRENT
TRANSISTOR
SURFACE MOUNT**



**CASE 318E-04, STYLE 1
TO-261AA**

MAXIMUM RATINGS (T_C = 25°C unless otherwise noted)

Rating	Symbol	Value	Unit
Collector-Emitter Voltage	V _{CEO}	-80	Vdc
Collector-Base Voltage	V _{CBO}	-100	Vdc
Emitter-Base Voltage	V _{EBO}	-5.0	Vdc
Collector Current	I _C	1.5	Adc
Total Power Dissipation @ T _A = 25°C ⁽¹⁾ Derate above 25°C	P _D	1.5 12	Watts mW/°C
Operating and Storage Temperature Range	T _J , T _{stg}	-65 to 150	°C

DEVICE MARKING

AH

THERMAL CHARACTERISTICS

Characteristic	Symbol	Max	Unit
Thermal Resistance — Junction-to-Ambient (surface mounted)	R _{θJA}	83.3	°C/W
Lead Temperature for Soldering, 0.0625" from case Time in Solder Bath	T _L	260 10	°C Sec

1. Device mounted on a glass epoxy printed circuit board 1.575 in. x 1.575 in. x 0.059 in.; mounting pad for the collector lead min. 0.93 sq. in.

Preferred devices are Motorola recommended choices for future use and best overall value.

ELECTRICAL CHARACTERISTICS ($T_A = 25^\circ\text{C}$ unless otherwise noted)

Characteristics	Symbol	Min	Typ	Max	Unit
OFF CHARACTERISTICS					
Collector-Base Breakdown Voltage ($I_C = -100 \mu\text{Adc}$, $I_E = 0$)	$V_{(BR)CBO}$	-100	—	—	Vdc
Collector-Emitter Breakdown Voltage ($I_C = -1.0 \text{ mAdc}$, $I_B = 0$)	$V_{(BR)CEO}$	-80	—	—	Vdc
Collector-Emitter Breakdown Voltage ($I_C = -100 \mu\text{Adc}$, $R_{BE} = 1.0 \text{ kohm}$)	$V_{(BR)CER}$	-100	—	—	Vdc
Emitter-Base Breakdown Voltage ($I_E = -10 \mu\text{Adc}$, $I_C = 0$)	$V_{(BR)EBO}$	-5.0	—	—	Vdc
Collector-Base Cutoff Current ($V_{CB} = -30 \text{ Vdc}$, $I_E = 0$)	I_{CBO}	—	—	-100	nAdc
Emitter-Base Cutoff Current ($V_{EB} = -5.0 \text{ Vdc}$, $I_C = 0$)	I_{EBO}	—	—	-10	μAdc
ON CHARACTERISTICS					
DC Current Gain ($I_C = -5.0 \text{ mAdc}$, $V_{CE} = -2.0 \text{ Vdc}$) ($I_C = -150 \text{ mAdc}$, $V_{CE} = -2.0 \text{ Vdc}$) ($I_C = -500 \text{ mAdc}$, $V_{CE} = -2.0 \text{ Vdc}$)	h_{FE}	25 40 25	— — —	— 250 —	—
Collector-Emitter Saturation Voltage ($I_C = -500 \text{ mAdc}$, $I_B = -50 \text{ mAdc}$)	$V_{CE(sat)}$	—	—	-0.5	Vdc
Base-Emitter On Voltage ($I_C = -500 \text{ mAdc}$, $V_{CE} = -2.0 \text{ Vdc}$)	$V_{BE(on)}$	—	—	-1.0	Vdc
DYNAMIC CHARACTERISTICS					
Current-Gain — Bandwidth Product ($I_C = -10 \text{ mAdc}$, $V_{CE} = -5.0 \text{ Vdc}$, $f = 35 \text{ MHz}$)	f_T	—	50	—	MHz

TYPICAL ELECTRICAL CHARACTERISTICS

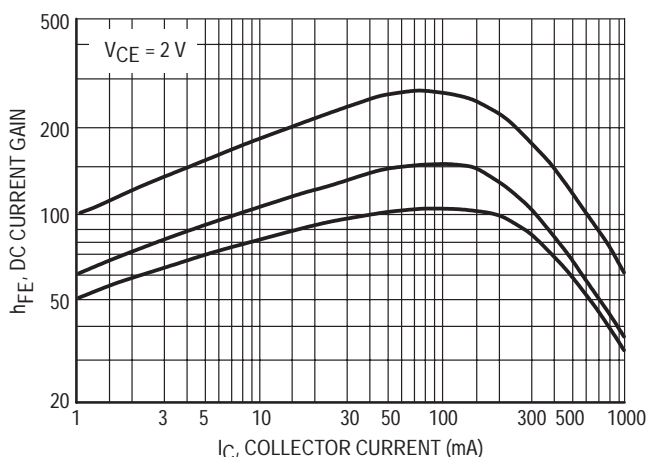


Figure 1. DC Current Gain

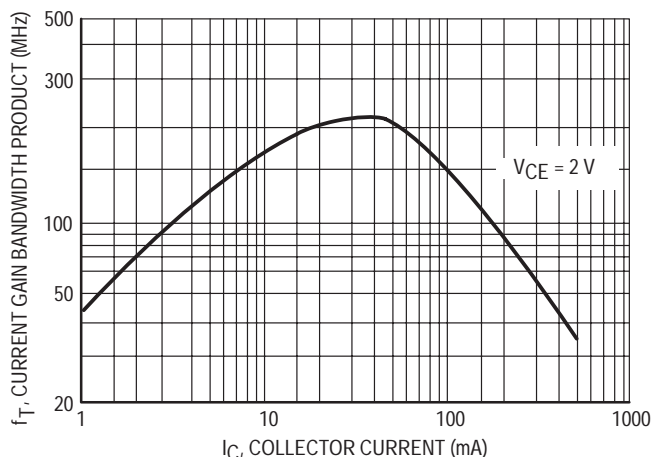


Figure 2. Current Gain Bandwidth Product

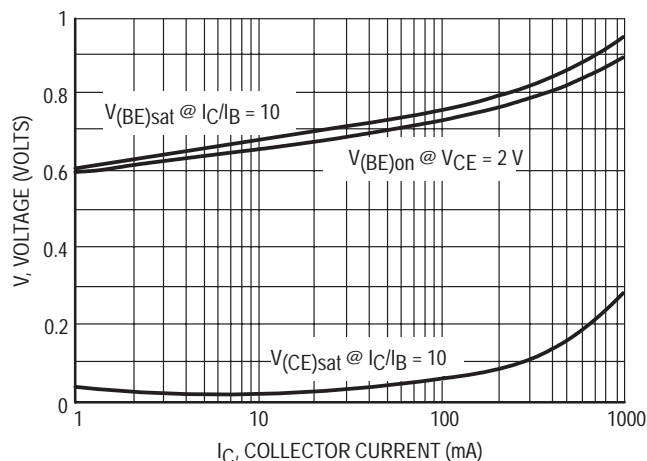


Figure 3. Saturation and "ON" Voltages

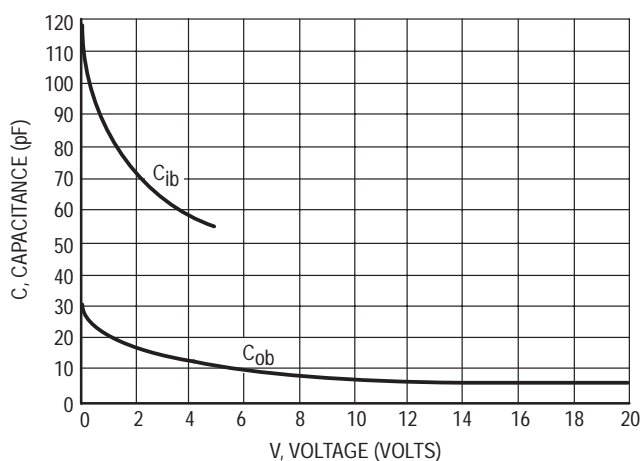
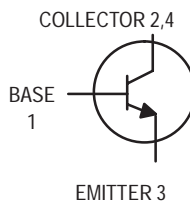


Figure 4. Capacitances

NPN Silicon Epitaxial Transistor

These NPN Silicon Epitaxial transistors are designed for use in audio amplifier applications. The device is housed in the SOT-223 package, which is designed for medium power surface mount applications.

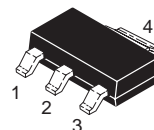
- High Current: 1.0 Amp
- The SOT-223 package can be soldered using wave or reflow. The formed leads absorb thermal stress during soldering, eliminating the possibility of damage to the die
- Available in 12 mm Tape and Reel
Use BCP56T1 to order the 7 inch/1000 unit reel
Use BCP56T3 to order the 13 inch/4000 unit reel
- PNP Complement is BCP53T1



BCP56T1 SERIES

Motorola Preferred Device

**MEDIUM POWER
NPN SILICON
HIGH CURRENT
TRANSISTOR
SURFACE MOUNT**



**CASE 318E-04, STYLE 1
TO-261AA**

MAXIMUM RATINGS ($T_C = 25^\circ\text{C}$ unless otherwise noted)

Rating	Symbol	Value	Unit
Collector-Emitter Voltage	V_{CEO}	80	Vdc
Collector-Base Voltage	V_{CBO}	100	Vdc
Emitter-Base Voltage	V_{EBO}	5	Vdc
Collector Current	I_C	1	Adc
Total Power Dissipation @ $T_A = 25^\circ\text{C}$ (1) Derate above 25°C	P_D	1.5 12	Watts mW/ $^\circ\text{C}$
Operating and Storage Temperature Range	T_J, T_{stg}	-65 to 150	$^\circ\text{C}$

DEVICE MARKING

BCP56T1 = BH
BCP56-10T1 = BK
BCP56-16T1 = BL

THERMAL CHARACTERISTICS

Characteristic	Symbol	Max	Unit
Thermal Resistance Junction-to-Ambient (surface mounted)	$R_{\theta JA}$	83.3	$^\circ\text{C}/\text{W}$
Maximum Temperature for Soldering Purposes Time in Solder Bath	T_L	260 10	$^\circ\text{C}$ Sec

1. Device mounted on a FR-4 glass epoxy printed circuit board 1.575 in. x 1.575 in. x 0.0625 in.; mounting pad for the collector lead = 0.93 sq. in.

Preferred devices are Motorola recommended choices for future use and best overall value.

ELECTRICAL CHARACTERISTICS ($T_A = 25^\circ\text{C}$ unless otherwise noted)

Characteristics	Symbol	Min	Typ	Max	Unit
OFF CHARACTERISTICS					
Collector-Base Breakdown Voltage ($I_C = 100\ \mu\text{Adc}$, $I_E = 0$)	$V_{(BR)CBO}$	100	—	—	Vdc
Collector-Emitter Breakdown Voltage ($I_C = 1.0\ \text{mAdc}$, $I_B = 0$)	$V_{(BR)CEO}$	80	—	—	Vdc
Emitter-Base Breakdown Voltage ($I_E = 10\ \mu\text{Adc}$, $I_C = 0$)	$V_{(BR)EBO}$	5.0	—	—	Vdc
Collector-Base Cutoff Current ($V_{CB} = 30\ \text{Vdc}$, $I_E = 0$)	I_{CBO}	—	—	100	nAdc
Emitter-Base Cutoff Current ($V_{EB} = 5.0\ \text{Vdc}$, $I_C = 0$)	I_{EBO}	—	—	10	μAdc
ON CHARACTERISTICS (2)					
DC Current Gain ($I_C = 5.0\ \text{mA}$, $V_{CE} = 2.0\ \text{V}$) ($I_C = 150\ \text{mA}$, $V_{CE} = 2.0\ \text{V}$) ($I_C = 500\ \text{mA}$, $V_{CE} = 2.0\ \text{V}$)	h_{FE}	25 40 63 100 25	— — — — —	— 250 160 250 —	—
Collector-Emitter Saturation Voltage ($I_C = 500\ \text{mAdc}$, $I_B = 50\ \text{mAdc}$)	$V_{CE(sat)}$	—	—	0.5	Vdc
Base-Emitter On Voltage ($I_C = 500\ \text{mAdc}$, $V_{CE} = 2.0\ \text{Vdc}$)	$V_{BE(on)}$	—	—	1.0	Vdc
DYNAMIC CHARACTERISTICS					
Current-Gain — Bandwidth Product ($I_C = 10\ \text{mAdc}$, $V_{CE} = 5.0\ \text{Vdc}$, $f = 35\ \text{MHz}$)	f_T	—	130	—	MHz

2. Pulse Test: Pulse Width $\leq 300\ \mu\text{s}$, Duty Cycle $\leq 2.0\%$

TYPICAL ELECTRICAL CHARACTERISTICS

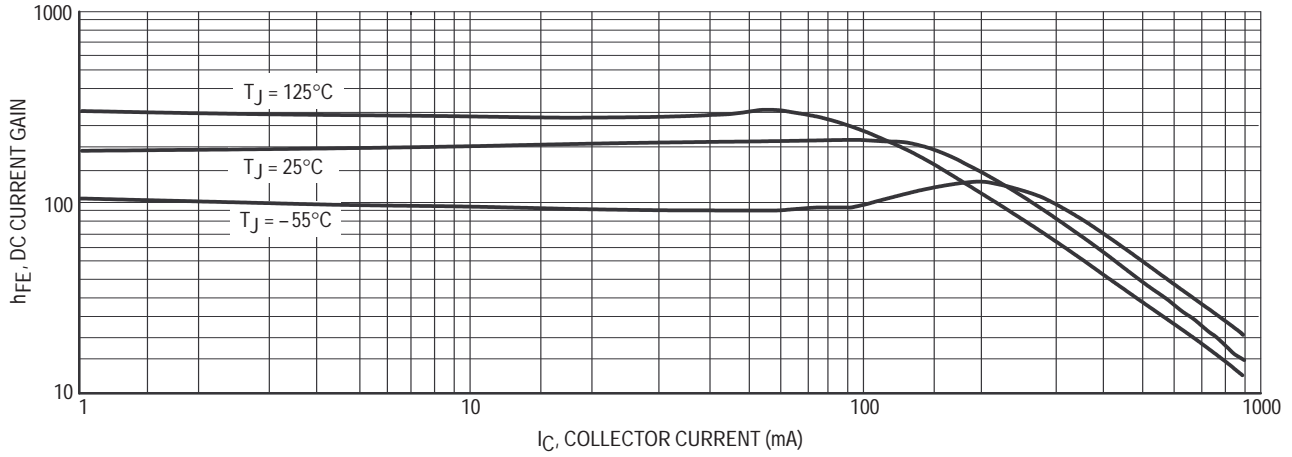


Figure 1. DC Current Gain

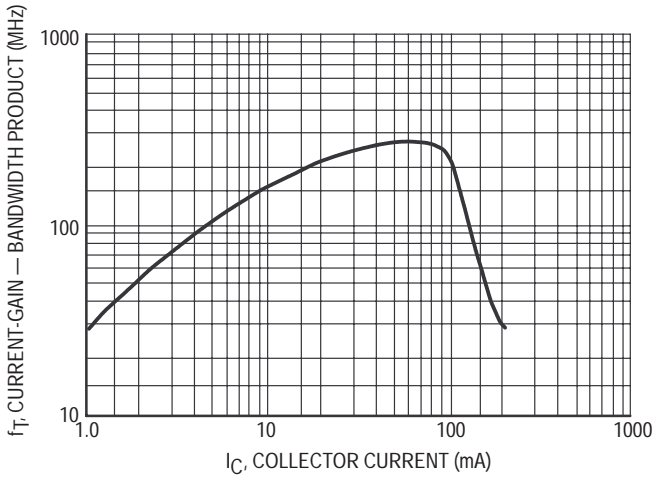


Figure 2. Current-Gain — Bandwidth Product

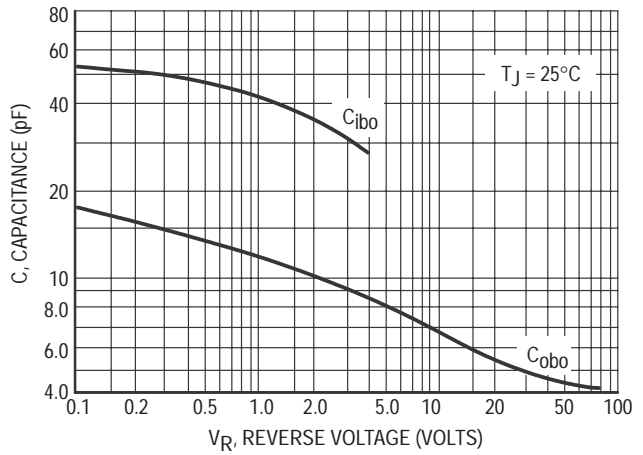


Figure 3. Capacitance

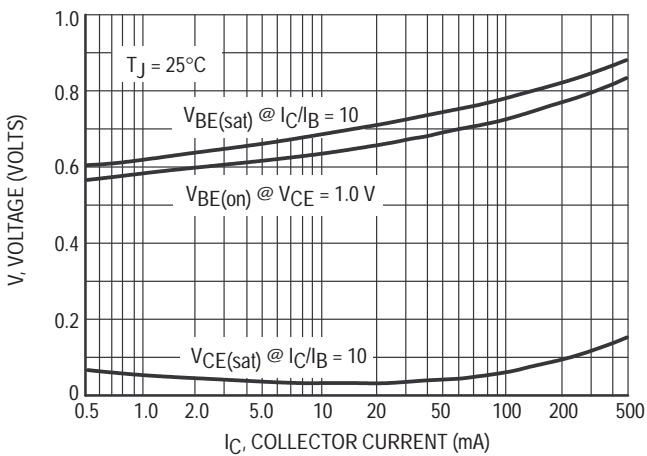


Figure 4. "On" Voltages

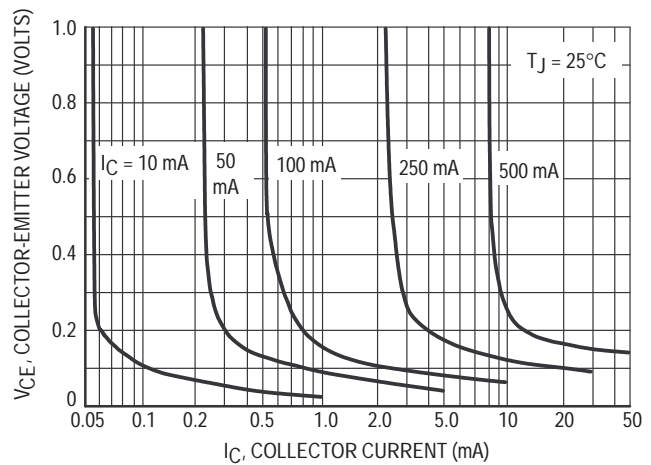
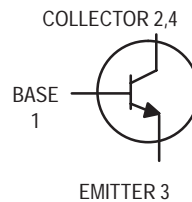


Figure 5. Collector Saturation Region

NPN Silicon Epitaxial Transistor

This NPN Silicon Epitaxial Transistor is designed for use in low voltage, high current applications. The device is housed in the SOT-223 package, which is designed for medium power surface mount applications.

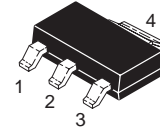
- High Current: $I_C = 1.0$ Amp
- The SOT-223 Package can be soldered using wave or reflow.
- SOT-223 package ensures level mounting, resulting in improved thermal conduction, and allows visual inspection of soldered joints. The formed leads absorb thermal stress during soldering, eliminating the possibility of damage to the die
- Available in 12 mm Tape and Reel
Use BCP68T1 to order the 7 inch/1000 unit reel.
Use BCP68T3 to order the 13 inch/4000 unit reel.
- The PNP Complement is BCP69T1



BCP68T1

Motorola Preferred Device

**MEDIUM POWER
NPN SILICON
HIGH CURRENT
TRANSISTOR
SURFACE MOUNT**



**CASE 318E-04, STYLE 1
TO-261AA**

MAXIMUM RATINGS ($T_C = 25^\circ\text{C}$ unless otherwise noted)

Rating	Symbol	Value	Unit
Collector-Emitter Voltage	V_{CEO}	25	Vdc
Collector-Base Voltage	V_{CBO}	20	Vdc
Emitter-Base Voltage	V_{EBO}	5	Vdc
Collector Current	I_C	1	Adc
Total Power Dissipation @ $T_A = 25^\circ\text{C}$ (1) Derate above 25°C	P_D	1.5 12	Watts mW/ $^\circ\text{C}$
Operating and Storage Temperature Range	T_J, T_{stg}	-65 to 150	$^\circ\text{C}$

DEVICE MARKING

CA

THERMAL CHARACTERISTICS

Characteristic	Symbol	Max	Unit
Thermal Resistance — Junction-to-Ambient (surface mounted)	$R_{\theta JA}$	83.3	$^\circ\text{C}/\text{W}$
Maximum Temperature for Soldering Purposes Time in Solder Bath	T_L	260 10	$^\circ\text{C}$ Sec

1. Device mounted on a FR-4 glass epoxy printed circuit board 1.575 in. x 1.575 in. x 0.0625 in.; mounting pad for the collector lead = 0.93 sq. in.

Preferred devices are Motorola recommended choices for future use and best overall value.

BCP68T1

ELECTRICAL CHARACTERISTICS ($T_A = 25^\circ\text{C}$ unless otherwise noted)

Characteristics	Symbol	Min	Typ	Max	Unit
OFF CHARACTERISTICS					
Collector-Emitter Breakdown Voltage ($I_C = 100 \mu\text{Adc}$, $I_E = 0$)	$V_{(BR)CES}$	25	—	—	Vdc
Collector-Emitter Breakdown Voltage ($I_C = 1.0 \text{ mAdc}$, $I_B = 0$)	$V_{(BR)CEO}$	20	—	—	Vdc
Emitter-Base Breakdown Voltage ($I_E = 10 \mu\text{Adc}$, $I_C = 0$)	$V_{(BR)EBO}$	5.0	—	—	Vdc
Collector-Base Cutoff Current ($V_{CB} = 25 \text{ Vdc}$, $I_E = 0$)	I_{CBO}	—	—	10	μAdc
Emitter-Base Cutoff Current ($V_{EB} = 5.0 \text{ Vdc}$, $I_C = 0$)	I_{EBO}	—	—	10	μAdc

ON CHARACTERISTICS (2)

DC Current Gain ($I_C = 5.0 \text{ mAdc}$, $V_{CE} = 10 \text{ Vdc}$) ($I_C = 500 \text{ mAdc}$, $V_{CE} = 1.0 \text{ Vdc}$) ($I_C = 1.0 \text{ Adc}$, $V_{CE} = 1.0 \text{ Vdc}$)	h_{FE}	50 85 60	— — —	— 375 —	—
Collector-Emitter Saturation Voltage ($I_C = 1.0 \text{ Adc}$, $I_B = 100 \text{ mAdc}$)	$V_{CE(sat)}$	—	—	0.5	Vdc
Base-Emitter On Voltage ($I_C = 1.0 \text{ Adc}$, $V_{CE} = 1.0 \text{ Vdc}$)	$V_{BE(on)}$	—	—	1.0	Vdc

DYNAMIC CHARACTERISTICS

Current-Gain — Bandwidth Product ($I_C = 10 \text{ mAdc}$, $V_{CE} = 5.0 \text{ Vdc}$)	f_T	—	60	—	MHz
----------------------------------------------------------------------------------------------	-------	---	----	---	-----

2. Pulse Test: Pulse Width $\leq 300 \mu\text{s}$, Duty Cycle $\leq 2.0\%$

TYPICAL ELECTRICAL CHARACTERISTICS

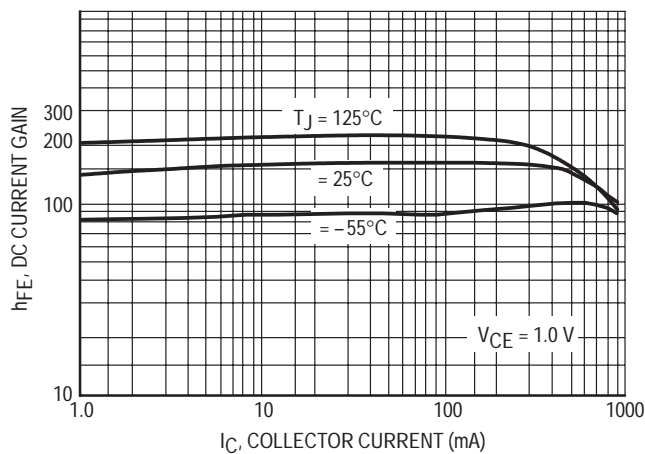


Figure 1. DC Current Gain

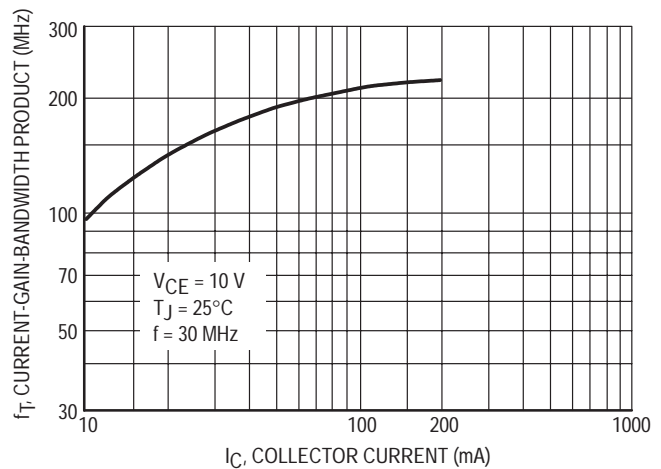


Figure 2. Current-Gain-Bandwidth Product

TYPICAL ELECTRICAL CHARACTERISTICS

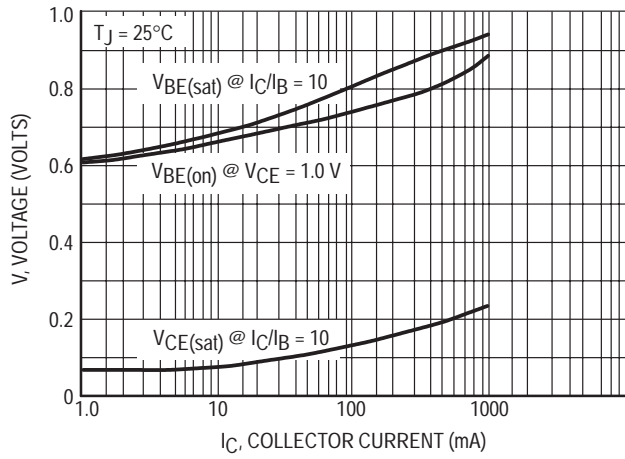


Figure 3. "On" Voltage

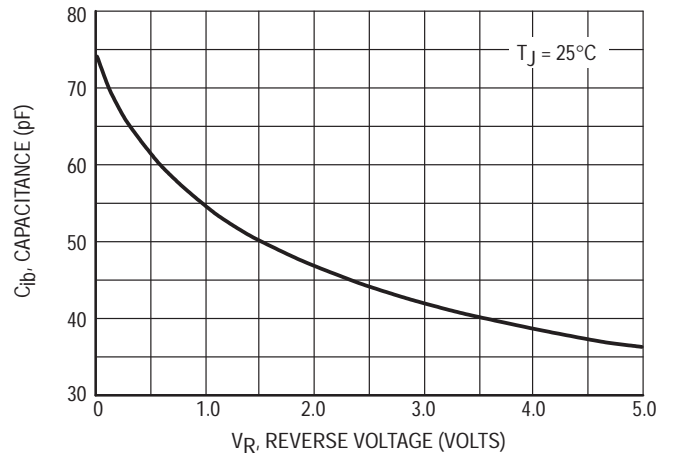


Figure 4. Capacitance

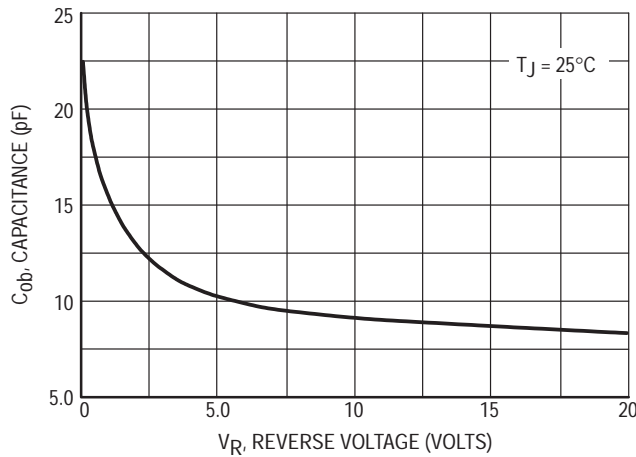


Figure 5. Capacitance

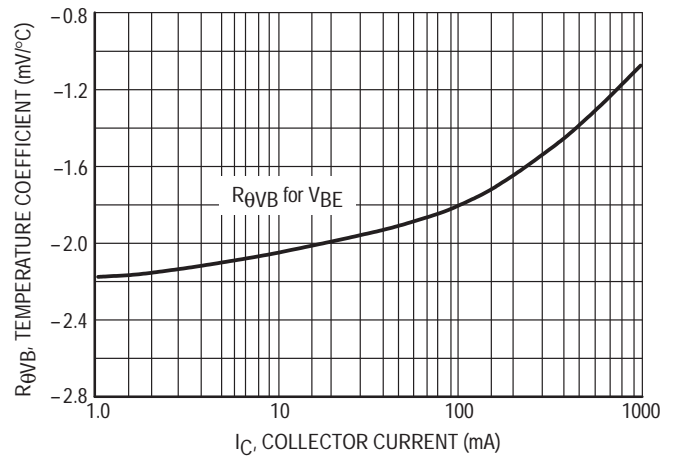


Figure 6. Base-Emitter Temperature Coefficient

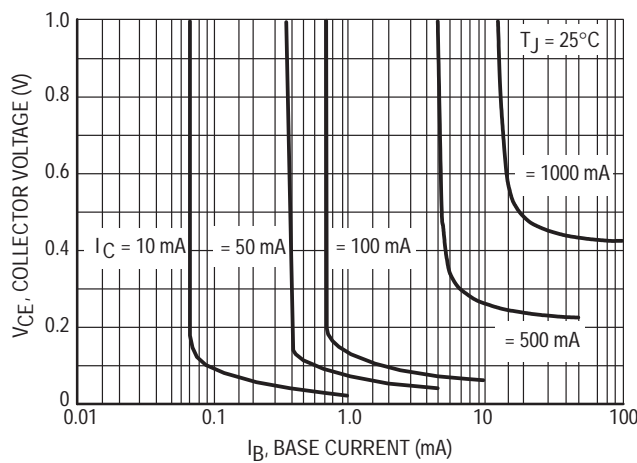
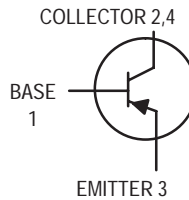


Figure 7. Saturation Region

PNP Silicon Epitaxial Transistor

This PNP Silicon Epitaxial Transistor is designed for use in low voltage, high current applications. The device is housed in the SOT-223 package, which is designed for medium power surface mount applications.

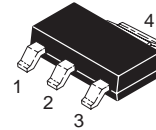
- High Current: $I_C = -1.0$ Amp
- The SOT-223 Package can be soldered using wave or reflow.
- SOT-223 package ensures level mounting, resulting in improved thermal conduction, and allows visual inspection of soldered joints. The formed leads absorb thermal stress during soldering, eliminating the possibility of damage to the die.
- Available in 12 mm Tape and Reel
Use BCP69T1 to order the 7 inch/1000 unit reel.
Use BCP69T3 to order the 13 inch/4000 unit reel.
- NPN Complement is BCP68



BCP69T1

Motorola Preferred Device

**MEDIUM POWER
PNP SILICON
HIGH CURRENT
TRANSISTOR
SURFACE MOUNT**



**CASE 318E-04, STYLE 1
TO-261AA**

MAXIMUM RATINGS ($T_C = 25^\circ\text{C}$ unless otherwise noted)

Rating	Symbol	Value	Unit
Collector-Emitter Voltage	V_{CEO}	-25	Vdc
Collector-Base Voltage	V_{CBO}	-20	Vdc
Emitter-Base Voltage	V_{EBO}	-5.0	Vdc
Collector Current	I_C	-1.0	Adc
Total Power Dissipation @ $T_A = 25^\circ\text{C}$ (1) Derate above 25°C	P_D	1.5 12	Watts $\text{mW}/^\circ\text{C}$
Operating and Storage Temperature Range	T_J, T_{stg}	-65 to 150	$^\circ\text{C}$

DEVICE MARKING

CE

THERMAL CHARACTERISTICS

Characteristic	Symbol	Max	Unit
Thermal Resistance — Junction-to-Ambient (surface mounted)	$R_{\theta JA}$	83.3	$^\circ\text{C}/\text{W}$
Lead Temperature for Soldering, 0.0625" from case Time in Solder Bath	T_L	260 10	$^\circ\text{C}$ Sec

1. Device mounted on a glass epoxy printed circuit board 1.575 in. x 1.575 in. x 0.059 in.; mounting pad for the collector lead min. 0.93 sq. in.

Preferred devices are Motorola recommended choices for future use and best overall value.

ELECTRICAL CHARACTERISTICS ($T_A = 25^\circ\text{C}$ unless otherwise noted)

Characteristics	Symbol	Min	Typ	Max	Unit
OFF CHARACTERISTICS					
Collector-Emitter Breakdown Voltage ($I_C = -100 \mu\text{Adc}$, $I_E = 0$)	$V_{(BR)CES}$	-25	—	—	Vdc
Collector-Emitter Breakdown Voltage ($I_C = -1.0 \text{ mAdc}$, $I_B = 0$)	$V_{(BR)CEO}$	-20	—	—	Vdc
Emitter-Base Breakdown Voltage ($I_E = -10 \mu\text{Adc}$, $I_C = 0$)	$V_{(BR)EBO}$	-5.0	—	—	Vdc
Collector-Base Cutoff Current ($V_{CB} = -25 \text{ Vdc}$, $I_E = 0$)	I_{CBO}	—	—	-10	μAdc
Emitter-Base Cutoff Current ($V_{EB} = -5.0 \text{ Vdc}$, $I_C = 0$)	I_{EBO}	—	—	-10	μAdc
ON CHARACTERISTICS					
DC Current Gain ($I_C = -5.0 \text{ mAdc}$, $V_{CE} = -10 \text{ Vdc}$) ($I_C = -500 \text{ mAdc}$, $V_{CE} = -1.0 \text{ Vdc}$) ($I_C = -1.0 \text{ Adc}$, $V_{CE} = -1.0 \text{ Vdc}$)	h_{FE}	50 85 60	— — —	— 375 —	—
Collector-Emitter Saturation Voltage ($I_C = -1.0 \text{ Adc}$, $I_B = -100 \text{ mAdc}$)	$V_{CE(sat)}$	—	—	-0.5	Vdc
Base-Emitter On Voltage ($I_C = -1.0 \text{ Adc}$, $V_{CE} = -1.0 \text{ Vdc}$)	$V_{BE(on)}$	—	—	-1.0	Vdc
DYNAMIC CHARACTERISTICS					
Current-Gain — Bandwidth Product ($I_C = -10 \text{ mAdc}$, $V_{CE} = -5.0 \text{ Vdc}$)	f_T	—	60	—	MHz

TYPICAL ELECTRICAL CHARACTERISTICS

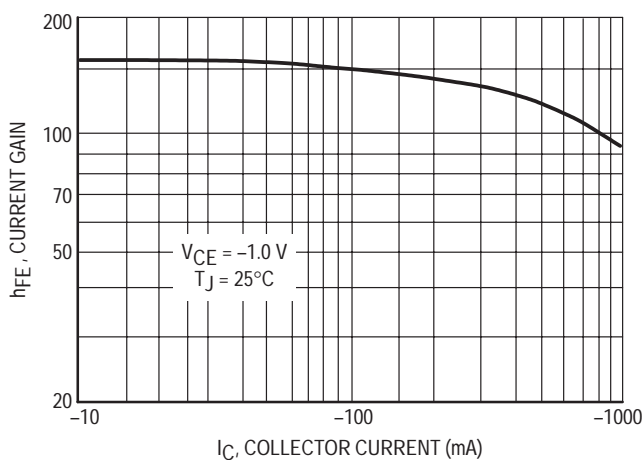


Figure 1. DC Current Gain

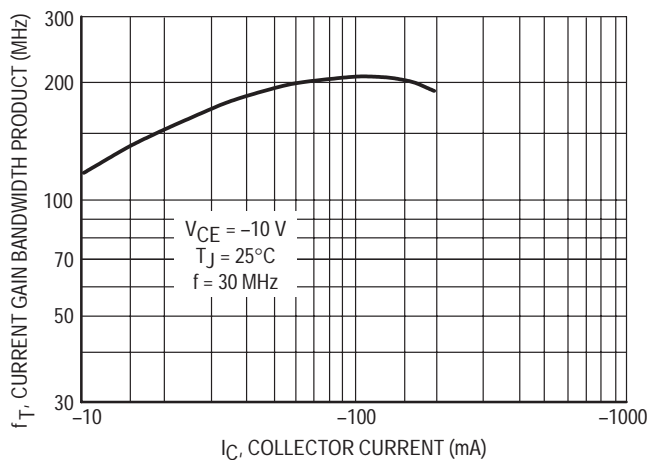


Figure 2. Current Gain Bandwidth Product

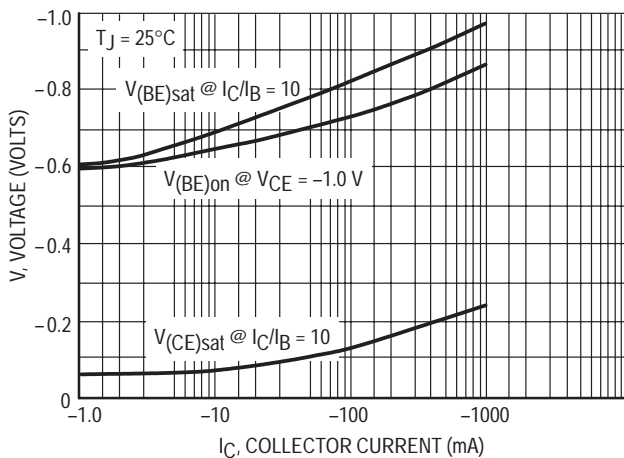


Figure 3. Saturation and "ON" Voltages

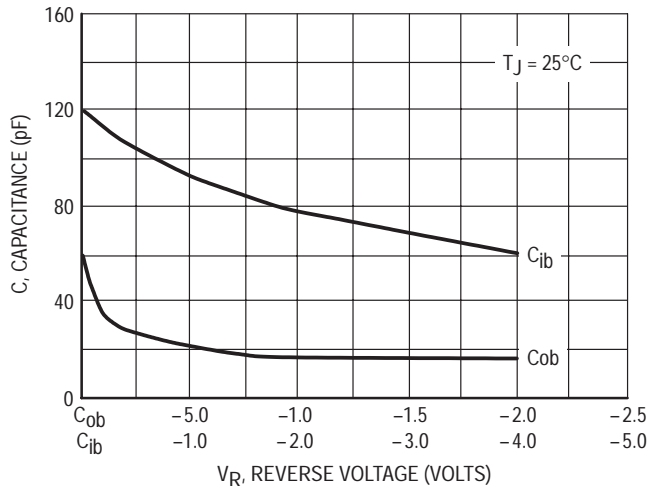
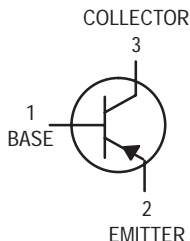


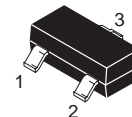
Figure 4. Capacitances

General Purpose Transistors

PNP Silicon



BCW29LT1
BCW30LT1



CASE 318-08, STYLE 6
SOT-23 (TO-236AB)

MAXIMUM RATINGS

Rating	Symbol	Value	Unit
Collector-Emitter Voltage	V_{CEO}	-32	Vdc
Collector-Base Voltage	V_{CB0}	-32	Vdc
Emitter-Base Voltage	V_{EBO}	-5.0	Vdc
Collector Current - Continuous	I_C	-100	mAdc

THERMAL CHARACTERISTICS

Characteristic	Symbol	Max	Unit
Total Device Dissipation FR-5 Board (1) $T_A = 25^\circ\text{C}$ Derate above 25°C	P_D	225	mW
Thermal Resistance, Junction to Ambient	$R_{\theta JA}$	1.8	$^\circ\text{C}/\text{W}$
Total Device Dissipation Alumina Substrate, (2) $T_A = 25^\circ\text{C}$ Derate above 25°C	P_D	300	mW
Thermal Resistance, Junction to Ambient	$R_{\theta JA}$	2.4	$^\circ\text{C}/\text{W}$
Junction and Storage Temperature	T_J, T_{stg}	-55 to +150	$^\circ\text{C}$

DEVICE MARKING

BCW29LT1 = C1; BCW30LT1 = C2

ELECTRICAL CHARACTERISTICS ($T_A = 25^\circ\text{C}$ unless otherwise noted)

Characteristic	Symbol	Min	Max	Unit
----------------	--------	-----	-----	------

OFF CHARACTERISTICS

Collector-Emitter Breakdown Voltage ($I_C = -2.0 \text{ mAdc}, I_E = 0$)	$V_{(BR)CEO}$	-32	—	Vdc
Collector-Emitter Breakdown Voltage ($I_C = -100 \mu\text{Adc}, V_{EB} = 0$)	$V_{(BR)CES}$	-32	—	Vdc
Collector-Base Breakdown Voltage ($I_C = -10 \mu\text{Adc}, I_C = 0$)	$V_{(BR)CBO}$	-32	—	Vdc
Emitter-Base Breakdown Voltage ($I_E = -10 \mu\text{Adc}, I_C = 0$)	$V_{(BR)EBO}$	-5.0	—	Vdc
Collector Cutoff Current ($V_{CB} = -32 \text{ Vdc}, I_E = 0$) ($V_{CB} = -32 \text{ Vdc}, I_E = 0, T_A = 100^\circ\text{C}$)	I_{CBO}	—	-100 -10	nAdc μAdc

1. FR-5 = $1.0 \times 0.75 \times 0.062$ in.

2. Alumina = $0.4 \times 0.3 \times 0.024$ in. 99.5% alumina.

ELECTRICAL CHARACTERISTICS ($T_A = 25^\circ\text{C}$ unless otherwise noted)

Characteristic	Symbol	Min	Max	Unit
ON CHARACTERISTICS				
DC Current Gain ($I_C = -2.0\text{ mAdc}$, $V_{CE} = -5.0\text{ Vdc}$)	h_{FE}	120	260	—
	BCW29	215	500	—
	BCW30			
Collector–Emitter Saturation Voltage ($I_C = -10\text{ mAdc}$, $I_B = -0.5\text{ mAdc}$)	$V_{CE(sat)}$	—	-0.3	Vdc
Base–Emitter On Voltage ($I_C = -2.0\text{ mAdc}$, $V_{CE} = -5.0\text{ Vdc}$)	$V_{BE(on)}$	-0.6	-0.75	Vdc
SMALL–SIGNAL CHARACTERISTICS				
Output Capacitance ($I_E = 0$, $V_{CB} = -10\text{ Vdc}$, $f = 1.0\text{ MHz}$)	C_{obo}	—	7.0	pF
Noise Figure ($I_C = -0.2\text{ mAdc}$, $V_{CE} = -5.0\text{ Vdc}$, $R_S = 2.0\text{ k}\Omega$, $f = 1.0\text{ kHz}$, $BW = 200\text{ Hz}$)	NF	—	10	dB

TYPICAL NOISE CHARACTERISTICS

($V_{CE} = -5.0$ Vdc, $T_A = 25^\circ\text{C}$)

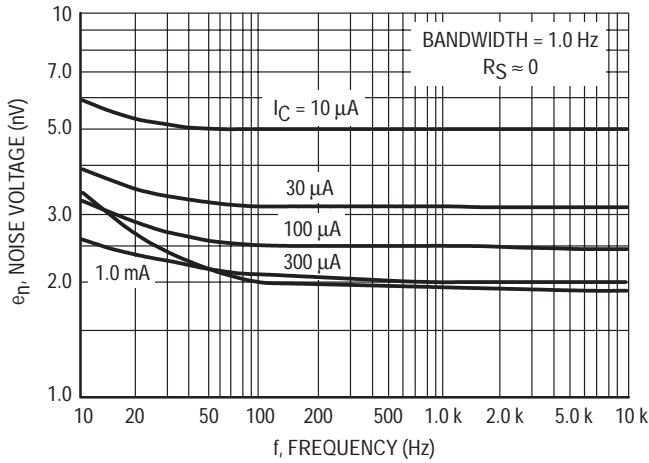


Figure 1. Noise Voltage

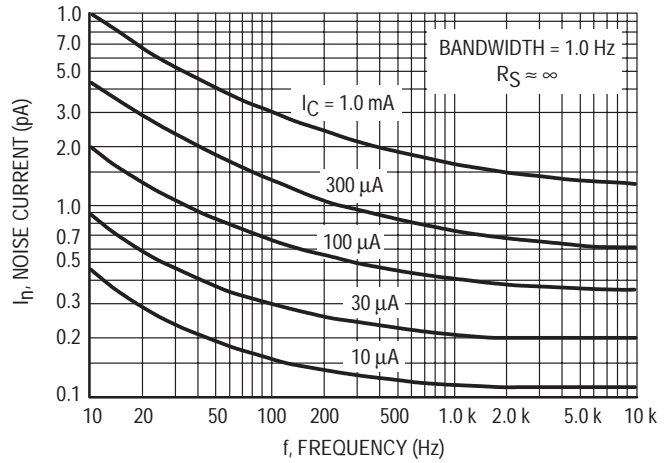


Figure 2. Noise Current

NOISE FIGURE CONTOURS

($V_{CE} = -5.0$ Vdc, $T_A = 25^\circ\text{C}$)

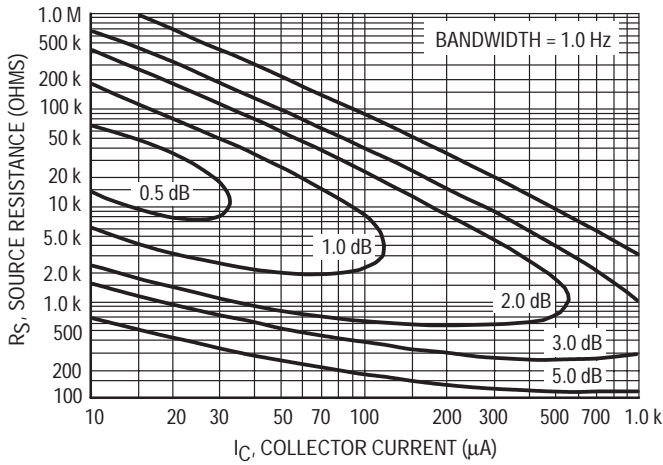


Figure 3. Narrow Band, 100 Hz

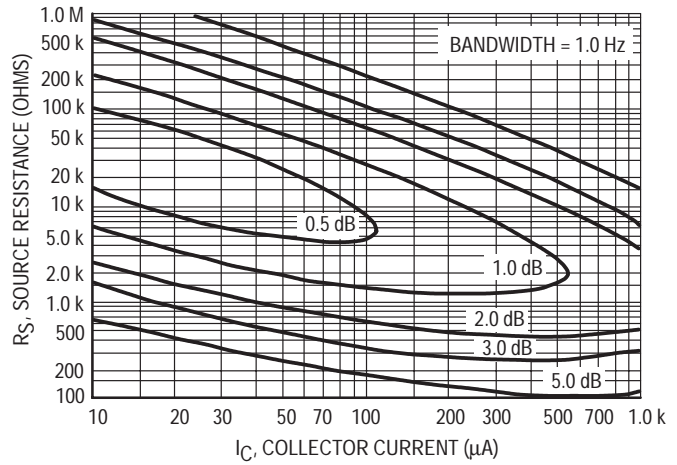


Figure 4. Narrow Band, 1.0 kHz

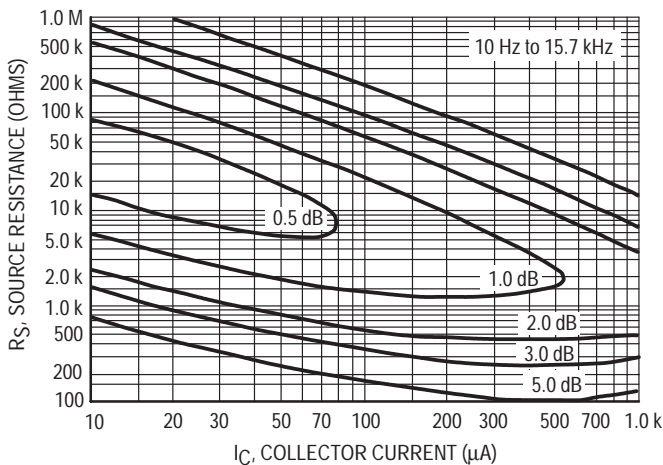


Figure 5. Wideband

Noise Figure is Defined as:

$$NF = 20 \log_{10} \left[\frac{e_n^2 + 4KTR_S + I_n^2 R_S^2}{4KTR_S} \right]^{1/2}$$

- e_n = Noise Voltage of the Transistor referred to the input. (Figure 3)
- I_n = Noise Current of the Transistor referred to the input. (Figure 4)
- K = Boltzman's Constant (1.38×10^{-23} j/ $^\circ\text{K}$)
- T = Temperature of the Source Resistance ($^\circ\text{K}$)
- R_S = Source Resistance (Ohms)

TYPICAL STATIC CHARACTERISTICS

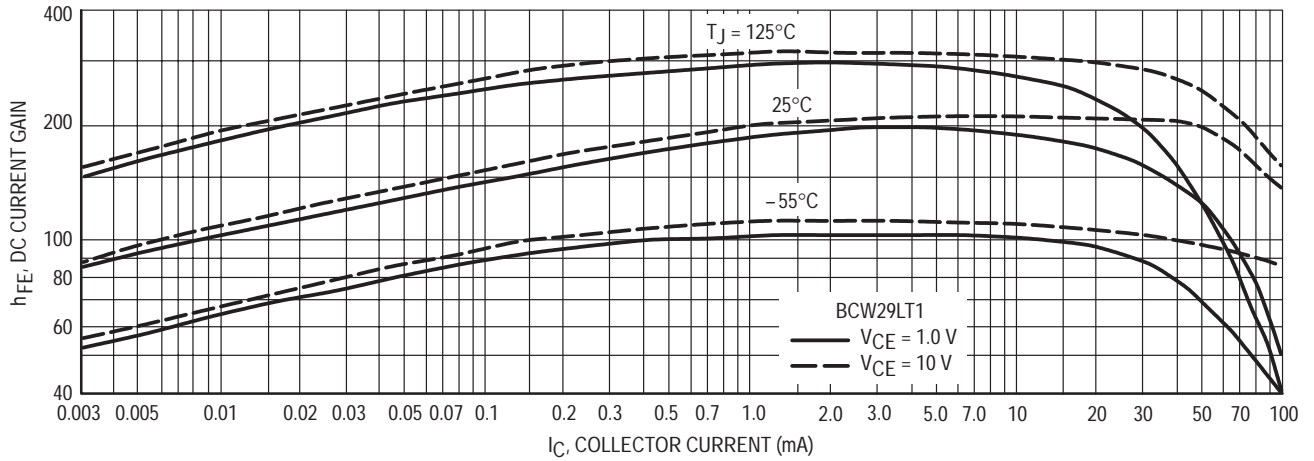


Figure 6. DC Current Gain

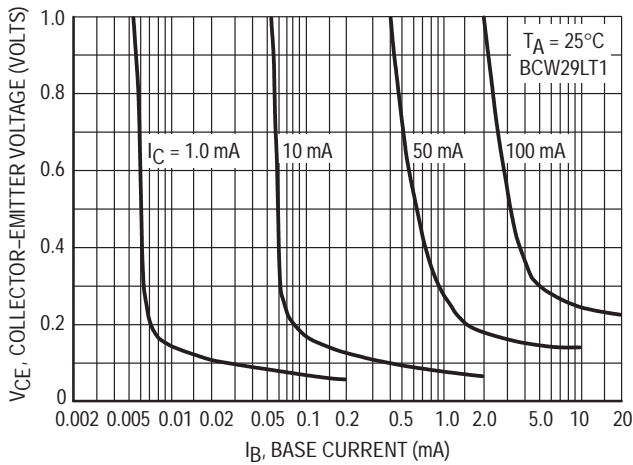


Figure 7. Collector Saturation Region

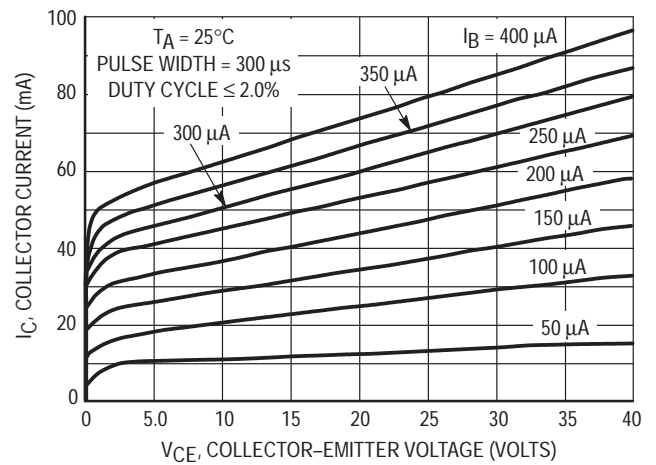


Figure 8. Collector Characteristics

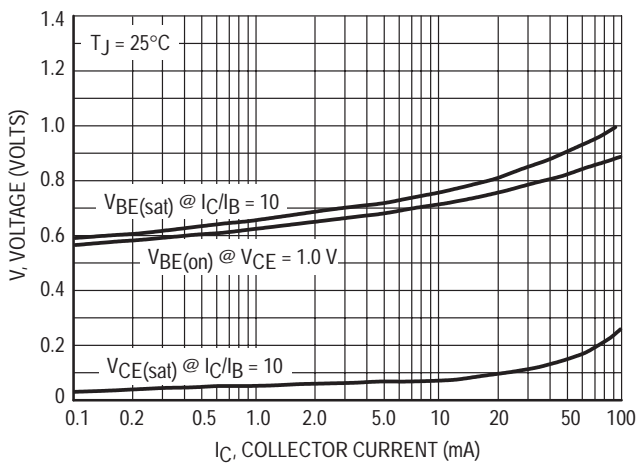


Figure 9. "On" Voltages

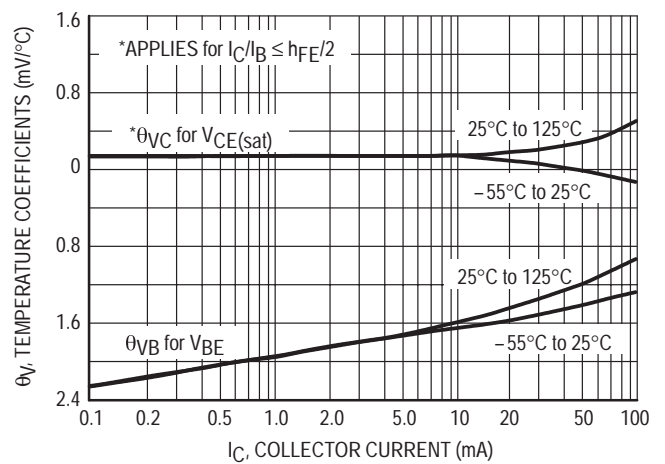


Figure 10. Temperature Coefficients

TYPICAL DYNAMIC CHARACTERISTICS

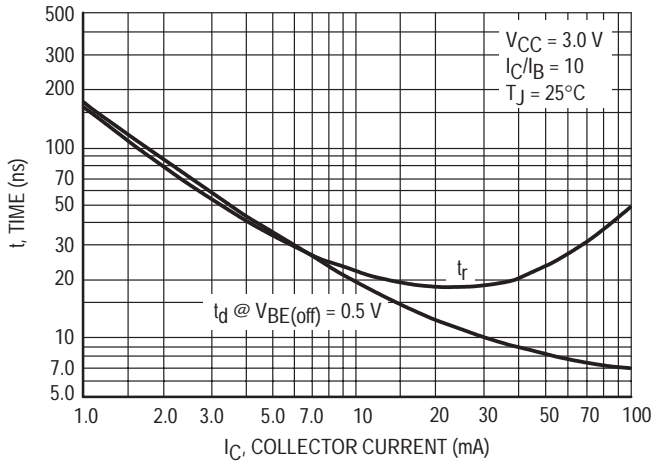


Figure 11. Turn-On Time

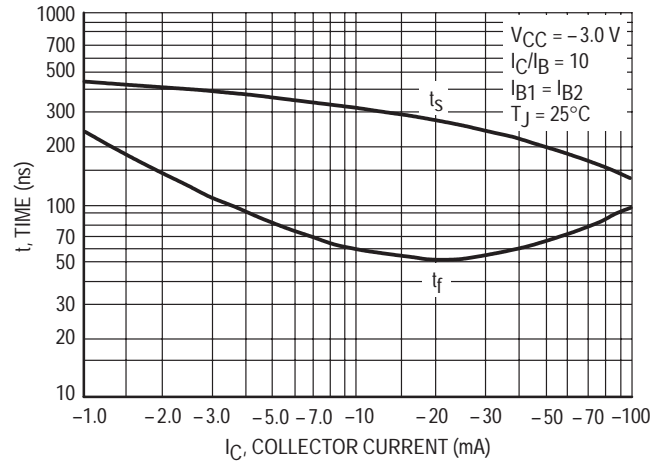


Figure 12. Turn-Off Time

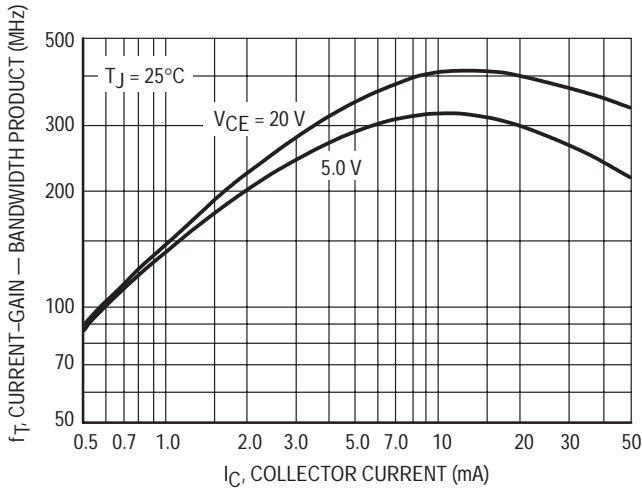


Figure 13. Current-Gain — Bandwidth Product

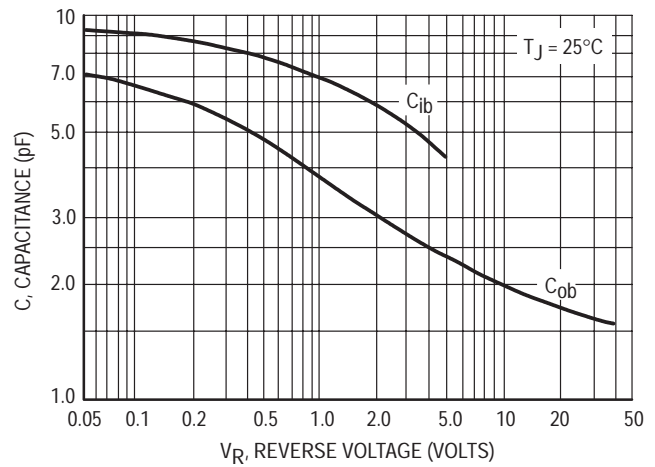


Figure 14. Capacitance

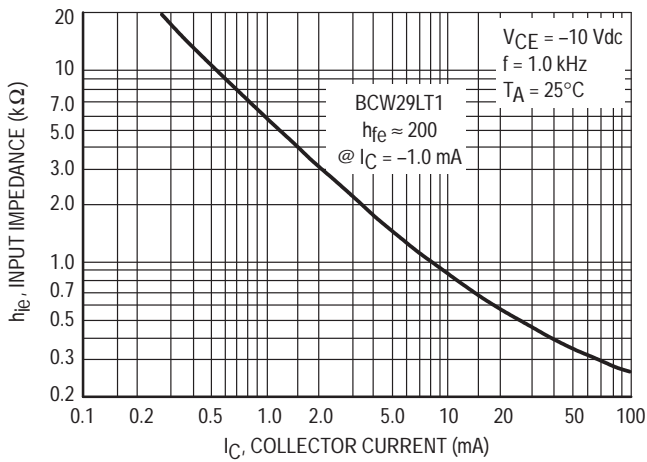


Figure 15. Input Impedance

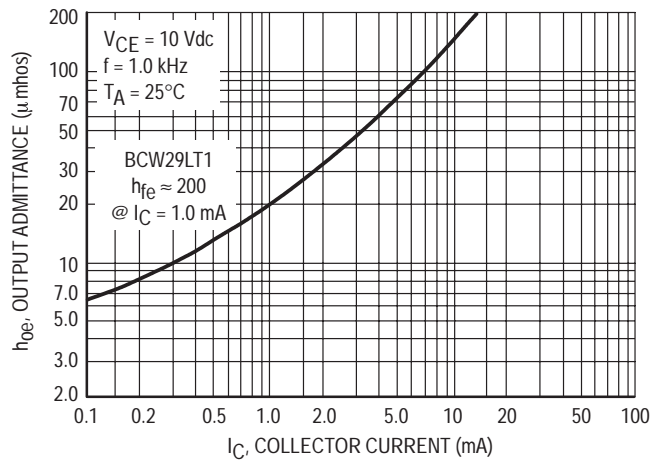


Figure 16. Output Admittance

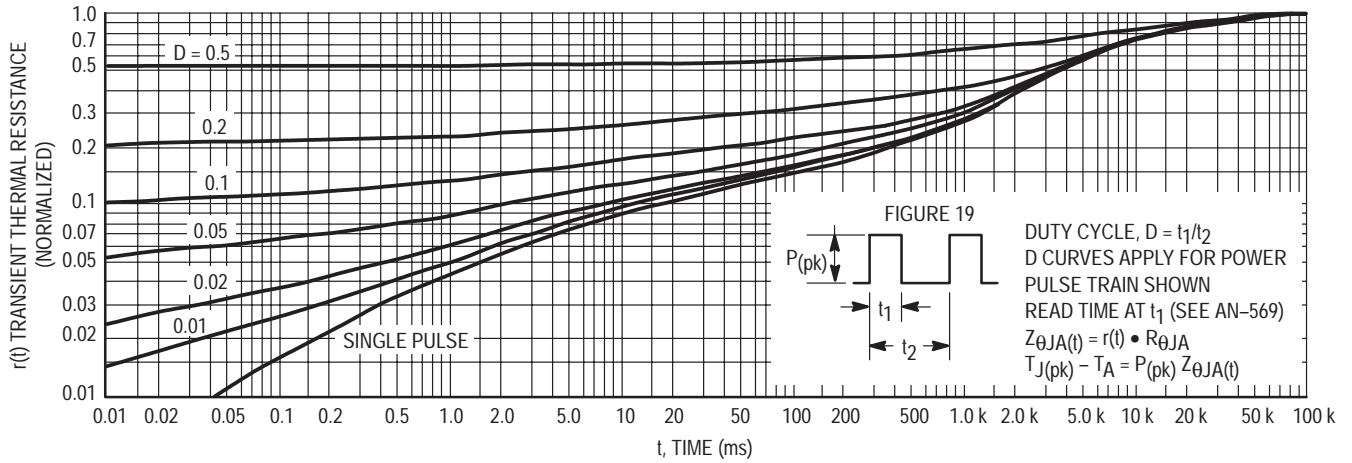


Figure 17. Thermal Response

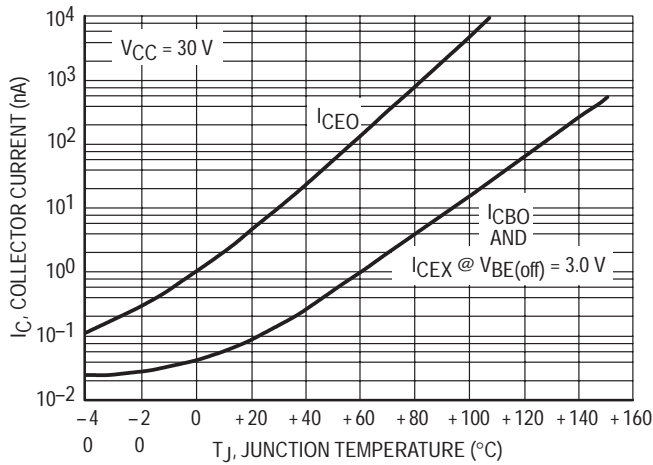


Figure 18. Typical Collector Leakage Current

DESIGN NOTE: USE OF THERMAL RESPONSE DATA

A train of periodical power pulses can be represented by the model as shown in Figure 19. Using the model and the device thermal response the normalized effective transient thermal resistance of Figure 17 was calculated for various duty cycles.

To find $Z_{\theta JA}(t)$, multiply the value obtained from Figure 17 by the steady state value $R_{\theta JA}$.

Example:

The BCW29LT1 is dissipating 2.0 watts peak under the following conditions:

$$t_1 = 1.0 \text{ ms}, t_2 = 5.0 \text{ ms} (D = 0.2)$$

Using Figure 17 at a pulse width of 1.0 ms and $D = 0.2$, the reading of $r(t)$ is 0.22.

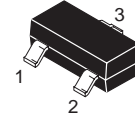
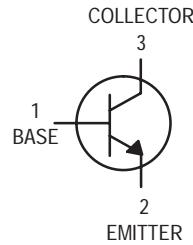
The peak rise in junction temperature is therefore $\Delta T = r(t) \times P_{(pk)} \times R_{\theta JA} = 0.22 \times 2.0 \times 200 = 88^\circ\text{C}$.

For more information, see AN-569.

General Purpose Transistor

NPN Silicon

BCW33LT1



CASE 318-08, STYLE 6
SOT-23 (TO-236AB)

MAXIMUM RATINGS

Rating	Symbol	Value	Unit
Collector-Emitter Voltage	V_{CEO}	20	Vdc
Collector-Base Voltage	V_{CBO}	30	Vdc
Emitter-Base Voltage	V_{EBO}	5.0	Vdc
Collector Current — Continuous	I_C	100	mAdc

THERMAL CHARACTERISTICS

Characteristic	Symbol	Max	Unit
Total Device Dissipation FR-5 Board ⁽¹⁾ $T_A = 25^\circ\text{C}$ Derate above 25°C	P_D	225	mW
		1.8	mW/ $^\circ\text{C}$
Thermal Resistance, Junction to Ambient	$R_{\theta JA}$	556	$^\circ\text{C}/\text{W}$
Total Device Dissipation Alumina Substrate, ⁽²⁾ $T_A = 25^\circ\text{C}$ Derate above 25°C	P_D	300	mW
		2.4	mW/ $^\circ\text{C}$
Thermal Resistance, Junction to Ambient	$R_{\theta JA}$	417	$^\circ\text{C}/\text{W}$
Junction and Storage Temperature	T_J, T_{stg}	-55 to +150	$^\circ\text{C}$

DEVICE MARKING

BCW33LT1 = D3

ELECTRICAL CHARACTERISTICS ($T_A = 25^\circ\text{C}$ unless otherwise noted)

Characteristic	Symbol	Min	Max	Unit
----------------	--------	-----	-----	------

OFF CHARACTERISTICS

Collector-Emitter Breakdown Voltage ($I_C = 2.0 \text{ mAdc}, I_B = 0$)	$V_{(BR)CEO}$	32	—	Vdc
Collector-Base Breakdown Voltage ($I_C = 10 \mu\text{Adc}, I_B = 0$)	$V_{(BR)CBO}$	32	—	Vdc
Emitter-Base Breakdown Voltage ($I_E = 10 \mu\text{Adc}, I_C = 0$)	$V_{(BR)EBO}$	5.0	—	Vdc
Collector Cutoff Current ($V_{CB} = 32 \text{ Vdc}, I_E = 0$) ($V_{CB} = 32 \text{ Vdc}, I_E = 0, T_A = 100^\circ\text{C}$)	I_{CBO}	—	100 10	nAdc μAdc

1. FR-5 = $1.0 \times 0.75 \times 0.062 \text{ in.}$

2. Alumina = $0.4 \times 0.3 \times 0.024 \text{ in. } 99.5\% \text{ alumina.}$

ELECTRICAL CHARACTERISTICS ($T_A = 25^\circ\text{C}$ unless otherwise noted) (Continued)

Characteristic	Symbol	Min	Max	Unit
ON CHARACTERISTICS				
DC Current Gain ($I_C = 2.0\text{ mAdc}$, $V_{CE} = 5.0\text{ Vdc}$)	hFE	420	800	—
Collector–Emitter Saturation Voltage ($I_C = 10\text{ mAdc}$, $I_B = 0.5\text{ mAdc}$)	$V_{CE(sat)}$	—	0.25	Vdc
Base–Emitter On Voltage ($I_C = 2.0\text{ mAdc}$, $V_{CE} = 5.0\text{ Vdc}$)	$V_{BE(on)}$	0.55	0.70	Vdc
SMALL–SIGNAL CHARACTERISTICS				
Output Capacitance ($V_{CB} = 10\text{ Vdc}$, $I_E = 0$, $f = 1.0\text{ MHz}$)	C_{obo}	—	4.0	pF
Noise Figure ($V_{CE} = 5.0\text{ Vdc}$, $I_C = 0.2\text{ mAdc}$, $R_S = 2.0\text{ k}\Omega$, $f = 1.0\text{ kHz}$, $BW = 200\text{ Hz}$)	NF	—	10	dB

EQUIVALENT SWITCHING TIME TEST CIRCUITS

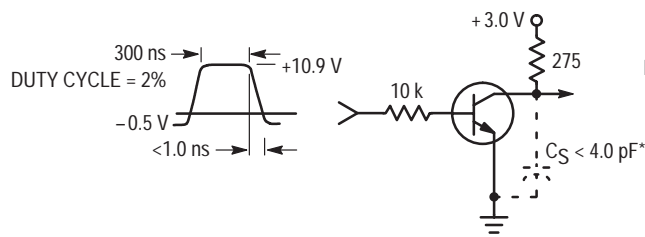


Figure 1. Turn–On Time

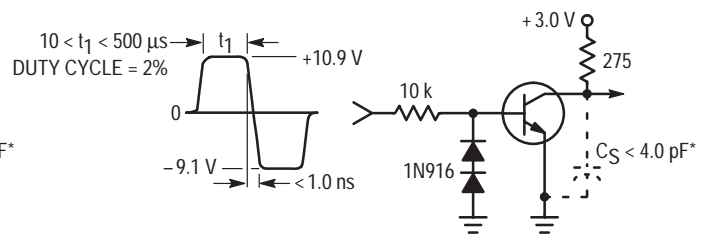


Figure 2. Turn–Off Time

*Total shunt capacitance of test jig and connectors

TYPICAL NOISE CHARACTERISTICS

($V_{CE} = 5.0 \text{ Vdc}$, $T_A = 25^\circ\text{C}$)

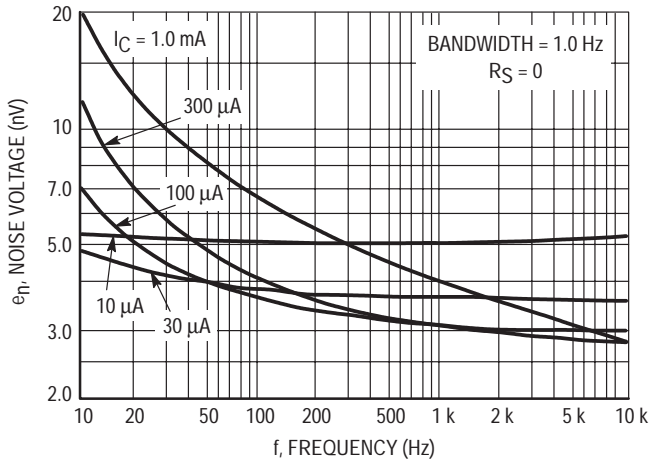


Figure 3. Noise Voltage

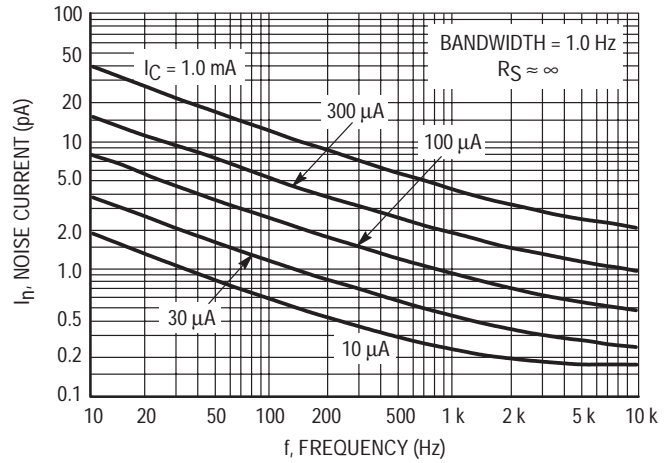


Figure 4. Noise Current

NOISE FIGURE CONTOURS

($V_{CE} = 5.0 \text{ Vdc}$, $T_A = 25^\circ\text{C}$)

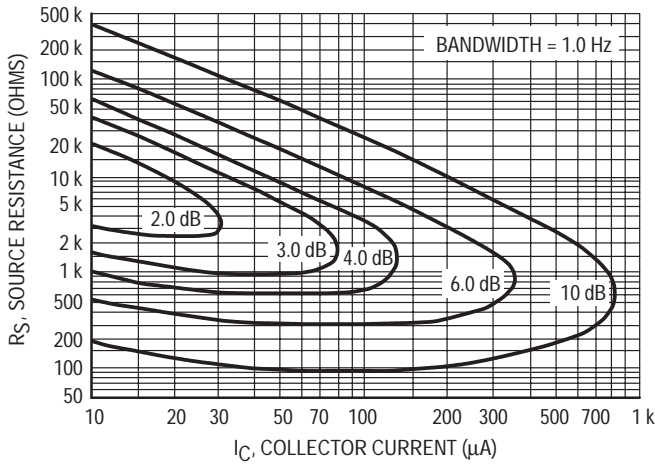


Figure 5. Narrow Band, 100 Hz

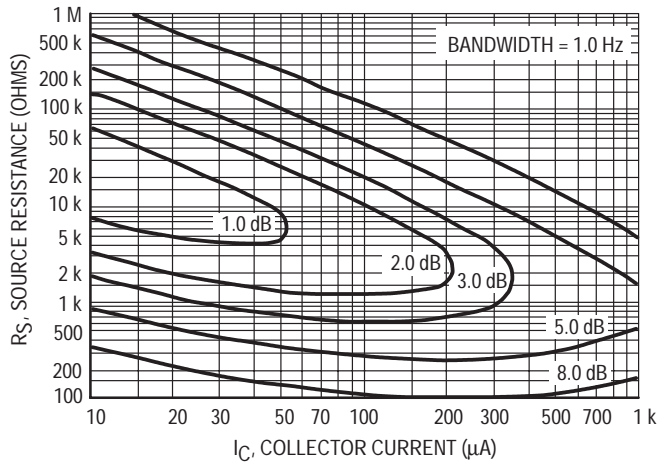


Figure 6. Narrow Band, 1.0 kHz

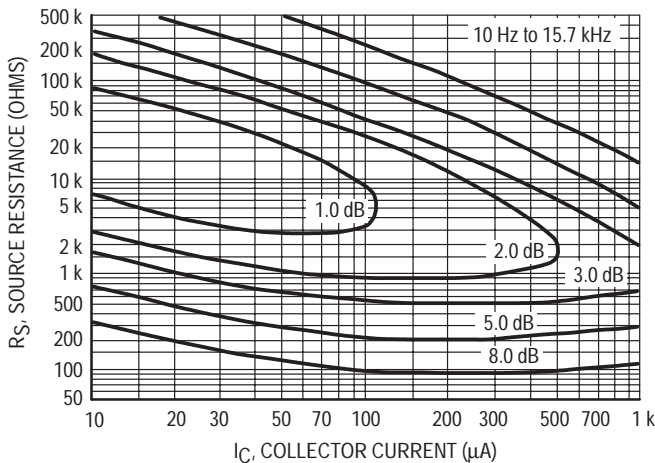


Figure 7. Wideband

Noise Figure is defined as:

$$NF = 20 \log_{10} \left(\frac{e_n^2 + 4KTR_S + I_n^2 R_S^2}{4KTR_S} \right)^{1/2}$$

e_n = Noise Voltage of the Transistor referred to the input. (Figure 3)

I_n = Noise Current of the Transistor referred to the input. (Figure 4)

K = Boltzman's Constant ($1.38 \times 10^{-23} \text{ J/}^\circ\text{K}$)

T = Temperature of the Source Resistance ($^\circ\text{K}$)

R_S = Source Resistance (Ohms)

TYPICAL STATIC CHARACTERISTICS

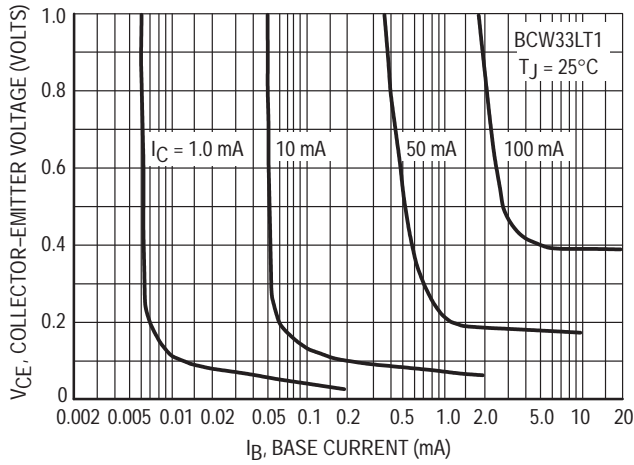


Figure 8. Collector Saturation Region

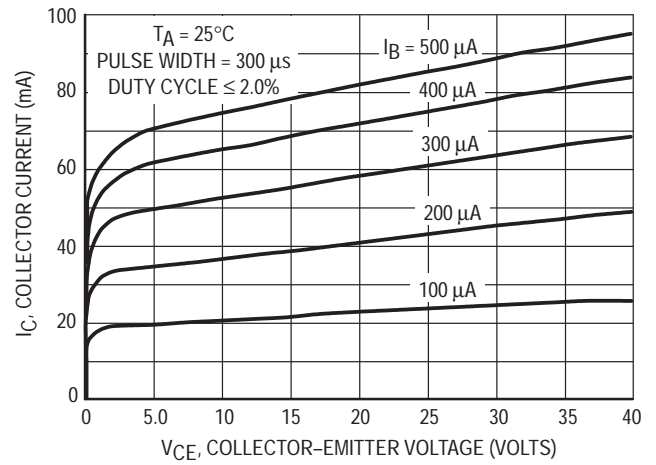


Figure 9. Collector Characteristics

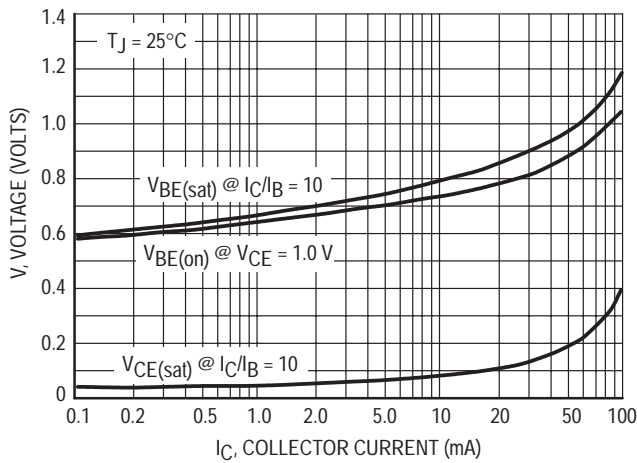


Figure 10. "On" Voltages

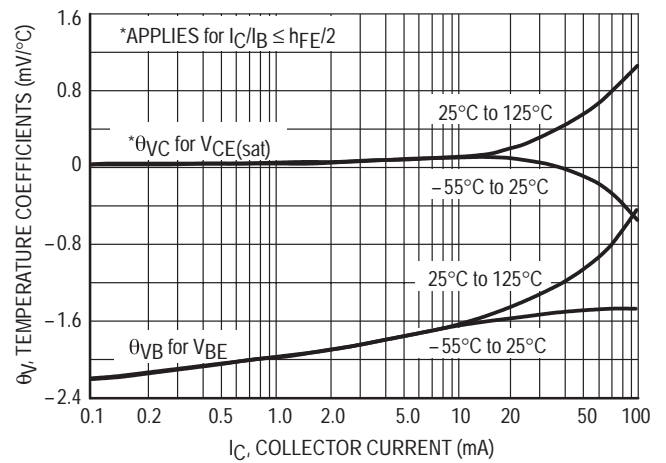


Figure 11. Temperature Coefficients

TYPICAL DYNAMIC CHARACTERISTICS

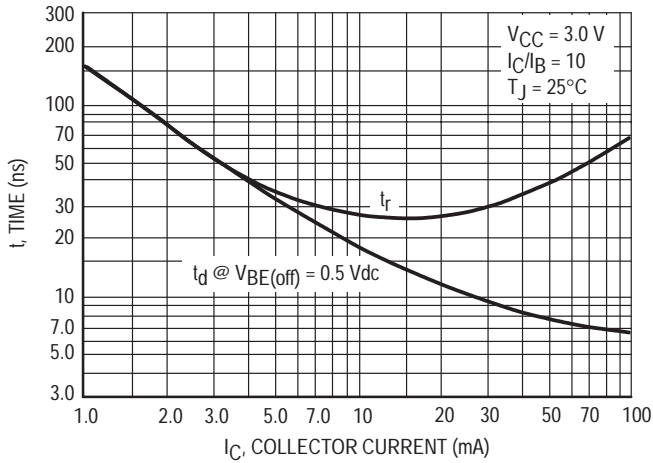


Figure 12. Turn-On Time

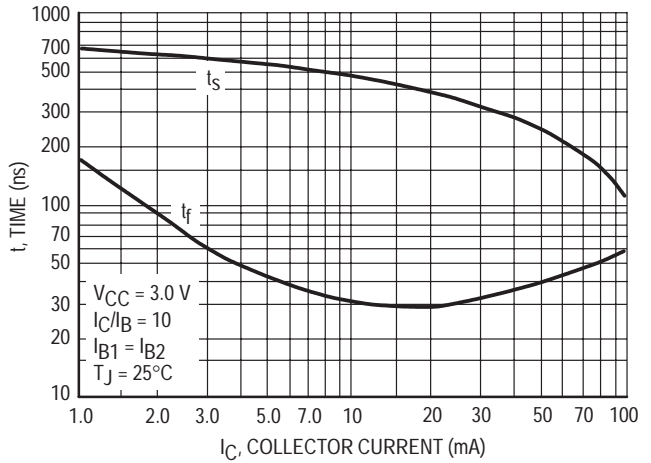


Figure 13. Turn-Off Time

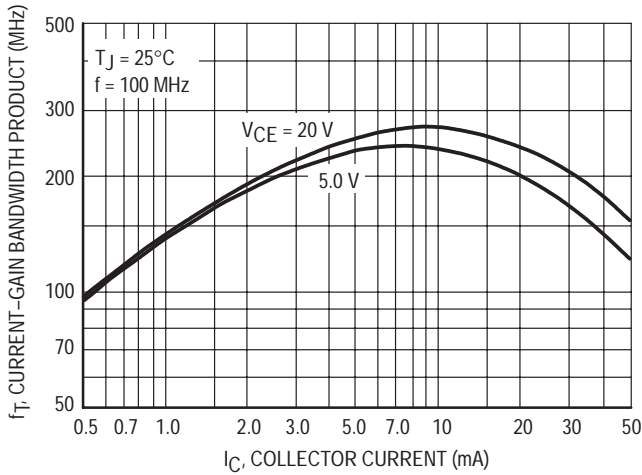


Figure 14. Current-Gain — Bandwidth Product

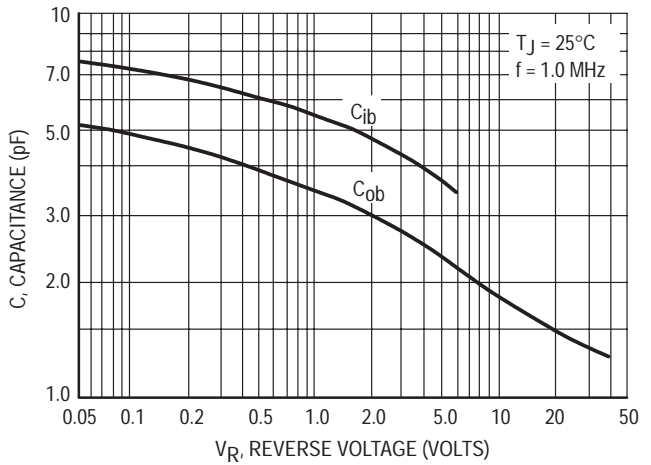


Figure 15. Capacitance

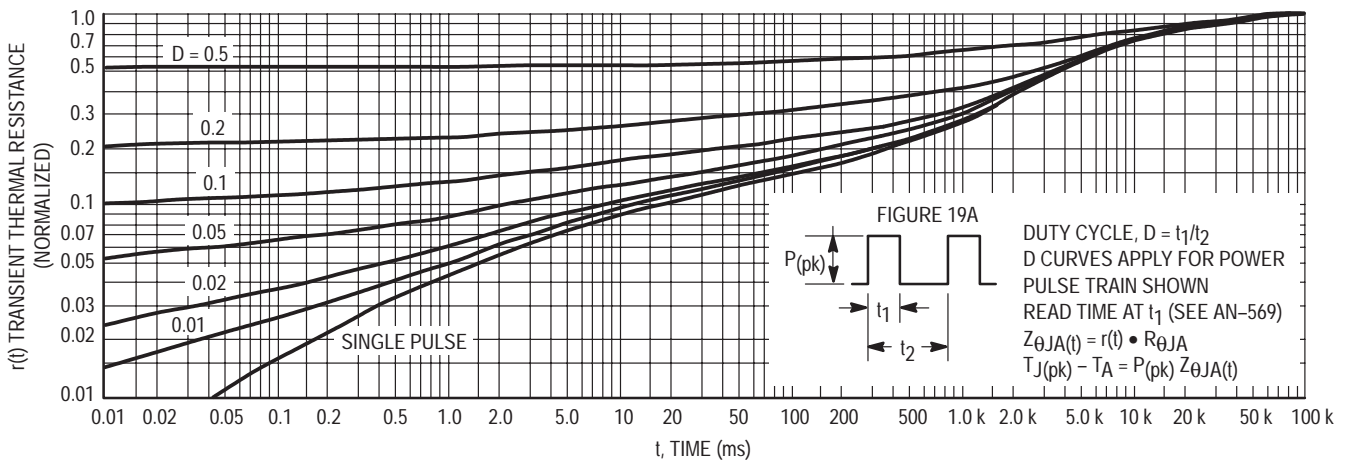


Figure 16. Thermal Response

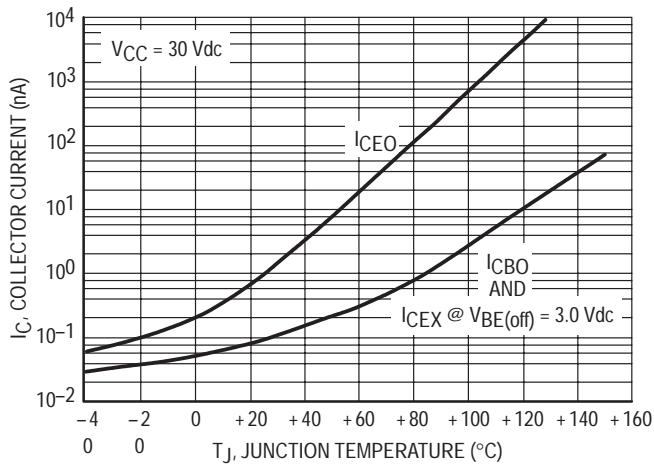


Figure 16A.

DESIGN NOTE: USE OF THERMAL RESPONSE DATA

A train of periodical power pulses can be represented by the model as shown in Figure 16A. Using the model and the device thermal response the normalized effective transient thermal resistance of Figure 16 was calculated for various duty cycles.

To find $Z_{\theta JA}(t)$, multiply the value obtained from Figure 16 by the steady state value $R_{\theta JA}$.

Example:

The MPS3904 is dissipating 2.0 watts peak under the following conditions:

$$t_1 = 1.0 \text{ ms}, t_2 = 5.0 \text{ ms. (D = 0.2)}$$

Using Figure 16 at a pulse width of 1.0 ms and $D = 0.2$, the reading of $r(t)$ is 0.22.

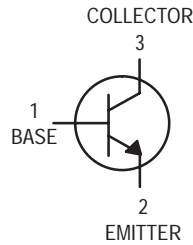
The peak rise in junction temperature is therefore

$$\Delta T = r(t) \times P_{(pk)} \times R_{\theta JA} = 0.22 \times 2.0 \times 200 = 88^{\circ}\text{C}.$$

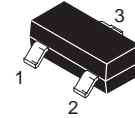
For more information, see AN-569.

General Purpose Transistors

NPN Silicon



BCW60ALT1
BCW60BLT1
BCW60DLT1



CASE 318-08, STYLE 6
SOT-23 (TO-236AB)

MAXIMUM RATINGS

Rating	Symbol	Value	Unit
Collector-Emitter Voltage	V_{CEO}	32	Vdc
Collector-Base Voltage	V_{CBO}	32	Vdc
Emitter-Base Voltage	V_{EBO}	5.0	Vdc
Collector Current — Continuous	I_C	100	mAdc

THERMAL CHARACTERISTICS

Characteristic	Symbol	Max	Unit
Total Device Dissipation FR-5 Board ⁽¹⁾ $T_A = 25^\circ\text{C}$ Derate above 25°C	P_D	225	mW
		1.8	mW/ $^\circ\text{C}$
Thermal Resistance Junction to Ambient	$R_{\theta JA}$	556	$^\circ\text{C}/\text{W}$
Total Device Dissipation Alumina Substrate, ⁽²⁾ $T_A = 25^\circ\text{C}$ Derate above 25°C	P_D	300	mW
		2.4	mW/ $^\circ\text{C}$
Thermal Resistance Junction to Ambient	$R_{\theta JA}$	417	$^\circ\text{C}/\text{W}$
Junction and Storage Temperature	T_J, T_{stg}	-55 to +150	$^\circ\text{C}$

DEVICE MARKING

BCW60ALT1 = AA, BCW60BLT1 = AB, BCW60DLT1 = AD

ELECTRICAL CHARACTERISTICS ($T_A = 25^\circ\text{C}$ unless otherwise noted)

Characteristic	Symbol	Min	Max	Unit
----------------	--------	-----	-----	------

OFF CHARACTERISTICS

Collector-Emitter Breakdown Voltage ($I_C = 2.0 \text{ mAdc}, I_E = 0$)	$V_{(BR)CEO}$	32	—	Vdc
Emitter-Base Breakdown Voltage ($I_E = 1.0 \mu\text{Adc}, I_C = 0$)	$V_{(BR)EBO}$	5.0	—	Vdc
Collector Cutoff Current ($V_{CE} = 32 \text{ Vdc}$) ($V_{CE} = 32 \text{ Vdc}, T_A = 150^\circ\text{C}$)	I_{CES}	—	20	nAdc μAdc
Emitter Cutoff Current ($V_{EB} = 4.0 \text{ Vdc}, I_C = 0$)	I_{EBO}	—	20	nAdc

1. FR-5 = $1.0 \times 0.75 \times 0.062 \text{ in.}$

2. Alumina = $0.4 \times 0.3 \times 0.024 \text{ in. 99.5\% alumina.}$

ELECTRICAL CHARACTERISTICS (T_A = 25°C unless otherwise noted) (Continued)

Characteristic	Symbol	Min	Max	Unit	
ON CHARACTERISTICS					
DC Current Gain (I _C = 10 μAdc, V _{CE} = 5.0 Vdc) (I _C = 2.0 mAdc, V _{CE} = 5.0 Vdc) (I _C = 50 mAdc, V _{CE} = 1.0 Vdc)	BCW60A BCW60B BCW60D	h _{FE}	20	—	—
			30	—	—
			100	—	—
	BCW60A BCW60B BCW60D	h _{FE}	120	220	—
			175	310	—
			380	630	—
	BCW60A BCW60B BCW60D	h _{FE}	60	—	—
			70	—	—
			100	—	—
AC Current Gain (V _{CE} = 5.0 Vdc, I _C = 2.0 mAdc, f = 1.0 kHz)	BCW60A BCW60B BCW60D	h _{fe}	125 175 350	250 350 700	—
Collector–Emitter Saturation Voltage (I _C = 50 mAdc, I _B = 1.25 mAdc) (I _C = 10 mAdc, I _B = 0.25 mAdc)		V _{CE(sat)}	— —	0.55 0.35	Vdc
Base–Emitter Saturation Voltage (I _C = 50 mAdc, I _B = 1.25 mAdc) (I _C = 50 mAdc, I _B = 0.25 mAdc)		V _{BE(sat)}	0.7 0.6	1.05 0.85	Vdc
Base–Emitter On Voltage (I _C = 2.0 mAdc, V _{CE} = 5.0 Vdc)		V _{BE(on)}	0.6	0.75	Vdc

SMALL–SIGNAL CHARACTERISTICS

Current–Gain — Bandwidth Product (I _C = 10 mAdc, V _{CE} = 5.0 Vdc, f = 100 MHz)	f _T	125	—	MHz
Output Capacitance (V _{CE} = 10 Vdc, I _C = 0, f = 1.0 MHz)	C _{obo}	—	4.5	pF
Noise Figure (V _{CE} = 5.0 Vdc, I _C = 0.2 mAdc, R _S = 2.0 kΩ, f = 1.0 kHz, BW = 200 Hz)	NF	—	6.0	dB

SWITCHING CHARACTERISTICS

Turn–On Time (I _C = 10 mAdc, I _{B1} = 1.0 mAdc)	t _{on}	—	150	ns
Turn–Off Time (I _{B2} = 1.0 mAdc, V _{BB} = 3.6 Vdc, R ₁ = R ₂ = 5.0 kΩ, R _L = 990 Ω)	t _{off}	—	800	ns

EQUIVALENT SWITCHING TIME TEST CIRCUITS

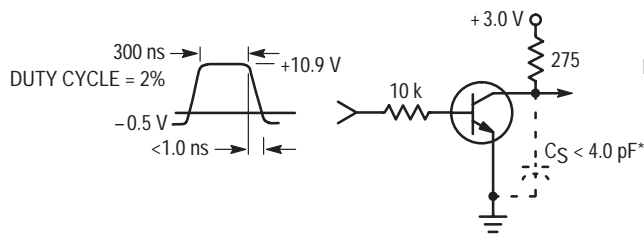


Figure 1. Turn–On Time

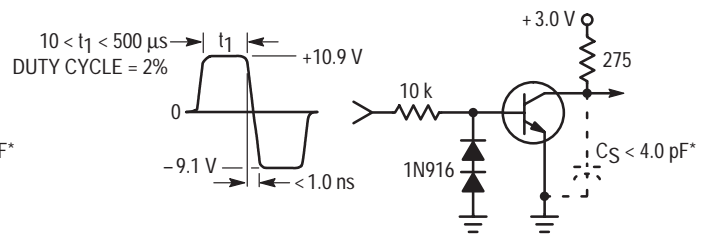


Figure 2. Turn–Off Time

*Total shunt capacitance of test jig and connectors

TYPICAL NOISE CHARACTERISTICS

($V_{CE} = 5.0 \text{ Vdc}$, $T_A = 25^\circ\text{C}$)

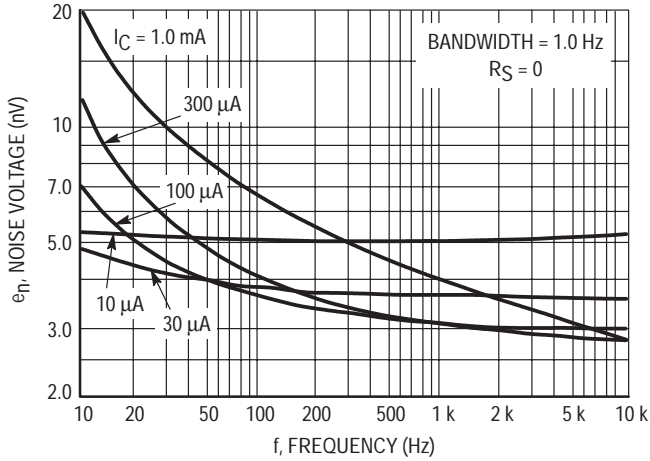


Figure 3. Noise Voltage

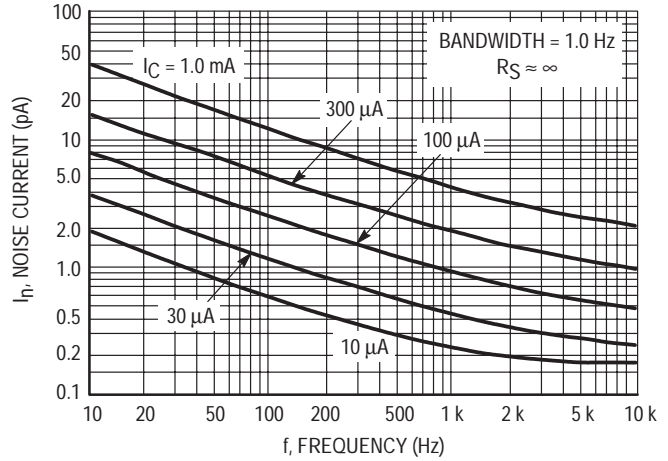


Figure 4. Noise Current

NOISE FIGURE CONTOURS

($V_{CE} = 5.0 \text{ Vdc}$, $T_A = 25^\circ\text{C}$)

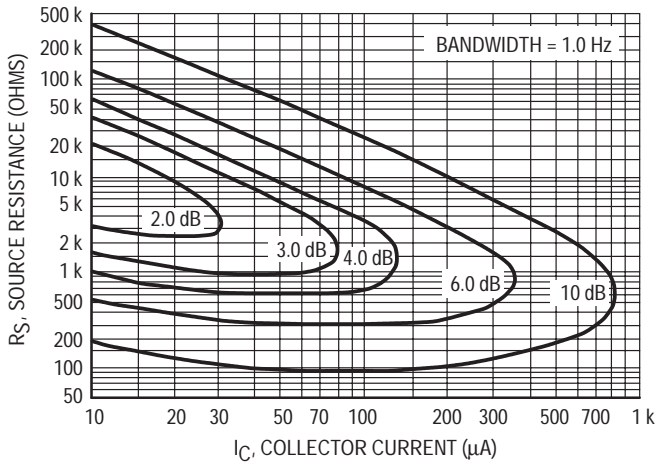


Figure 5. Narrow Band, 100 Hz

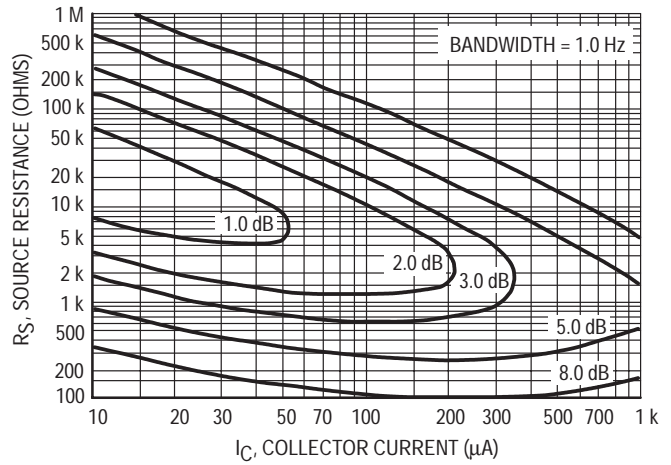


Figure 6. Narrow Band, 1.0 kHz

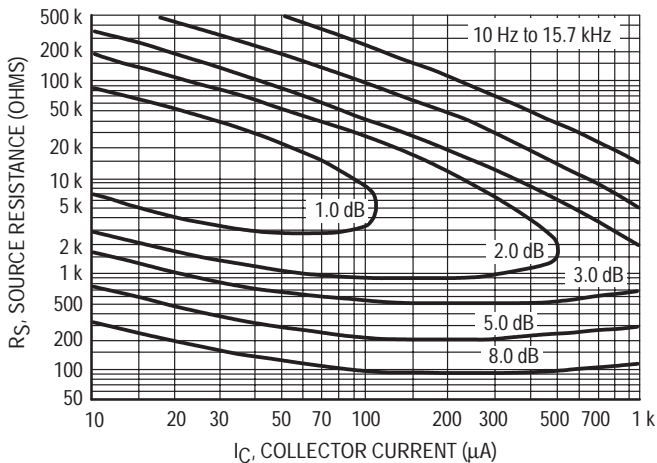


Figure 7. Wideband

Noise Figure is defined as:

$$NF = 20 \log_{10} \left(\frac{e_n^2 + 4KTR_S + I_n^2 R_S^2}{4KTR_S} \right)^{1/2}$$

e_n = Noise Voltage of the Transistor referred to the input. (Figure 3)

I_n = Noise Current of the Transistor referred to the input. (Figure 4)

K = Boltzman's Constant ($1.38 \times 10^{-23} \text{ J/}^\circ\text{K}$)

T = Temperature of the Source Resistance ($^\circ\text{K}$)

R_S = Source Resistance (Ohms)

TYPICAL STATIC CHARACTERISTICS

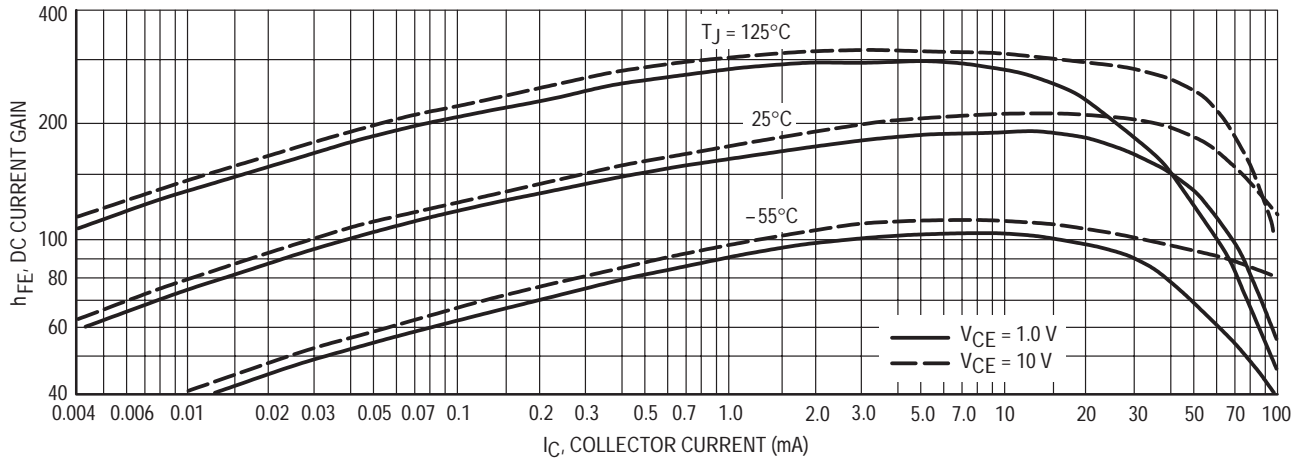


Figure 8. DC Current Gain

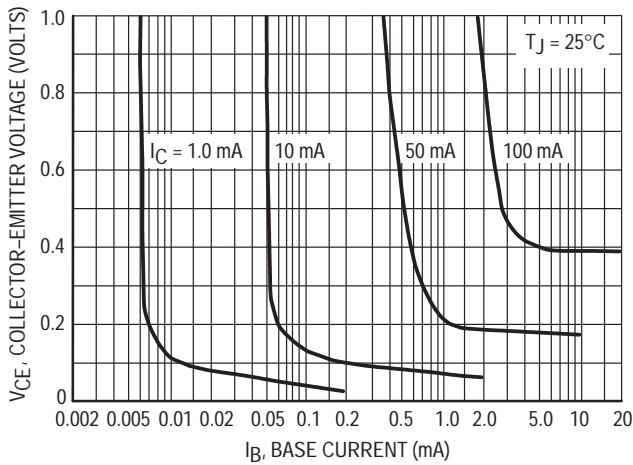


Figure 9. Collector Saturation Region

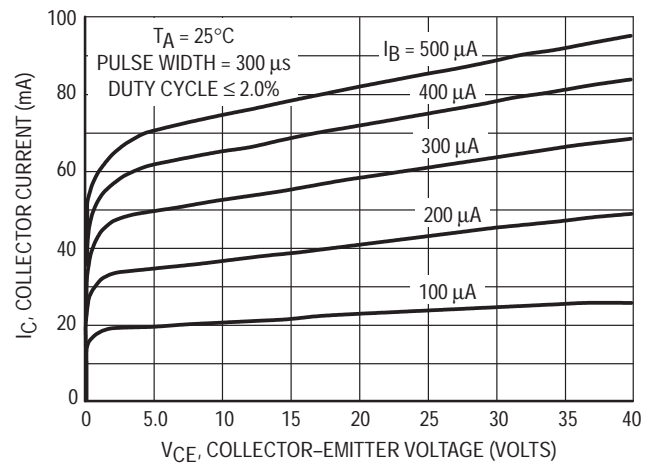


Figure 10. Collector Characteristics

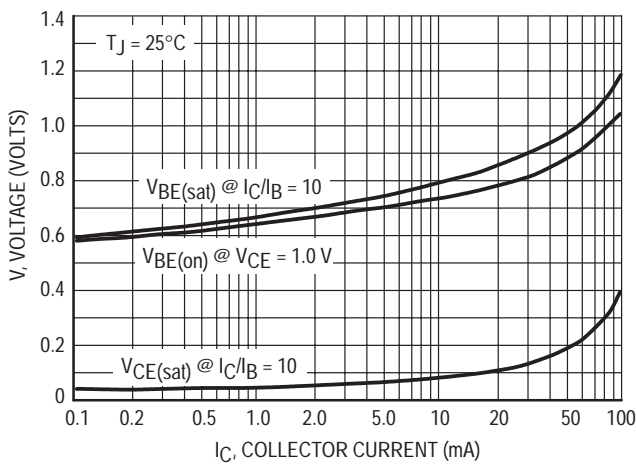


Figure 11. "On" Voltages

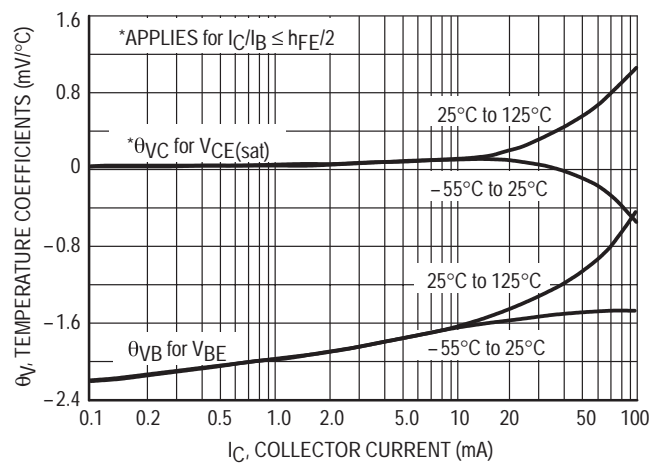


Figure 12. Temperature Coefficients

TYPICAL DYNAMIC CHARACTERISTICS

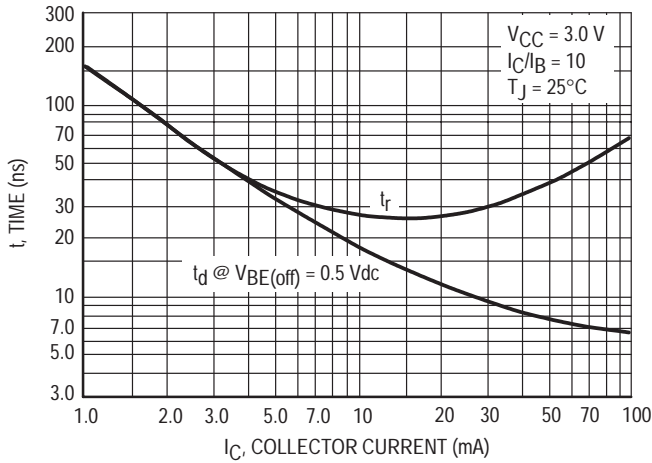


Figure 13. Turn-On Time

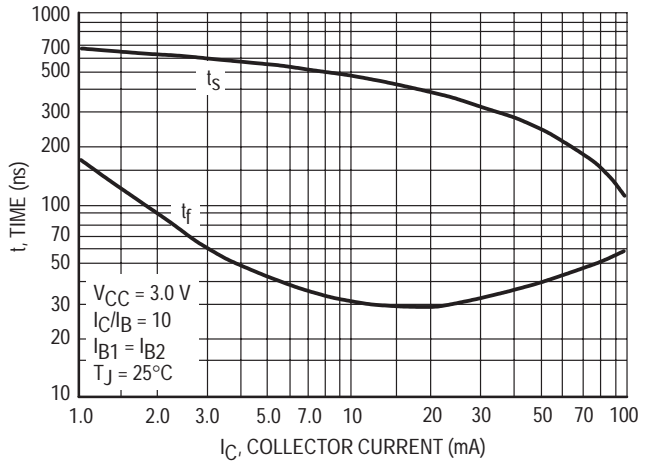


Figure 14. Turn-Off Time

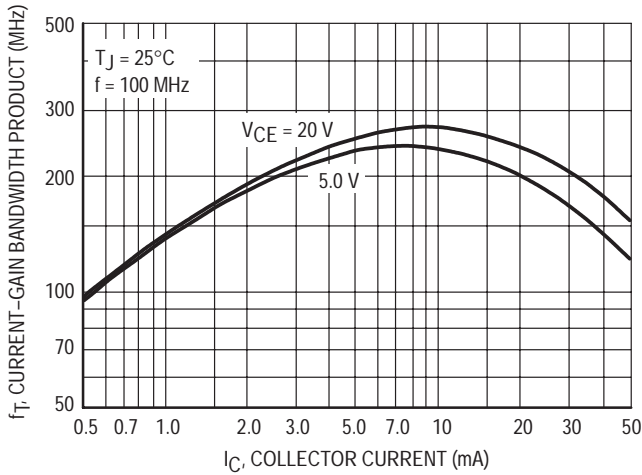


Figure 15. Current-Gain — Bandwidth Product

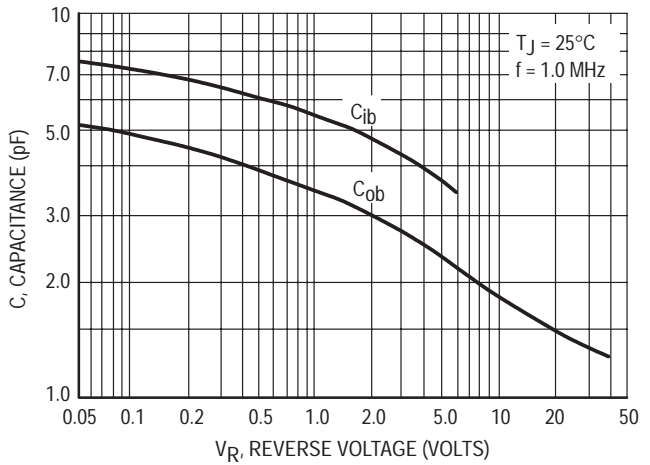


Figure 16. Capacitance

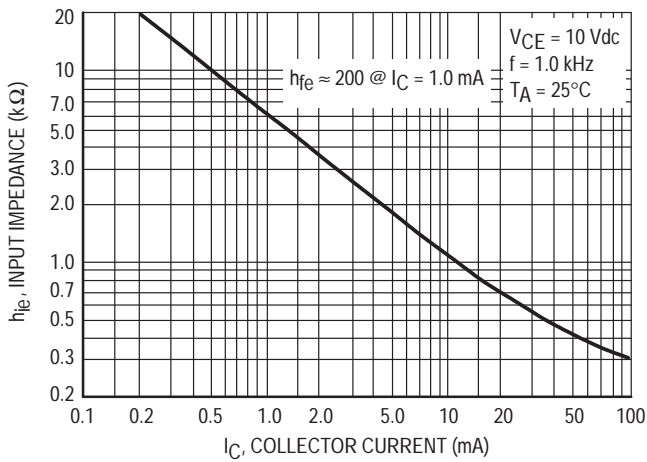


Figure 17. Input Impedance

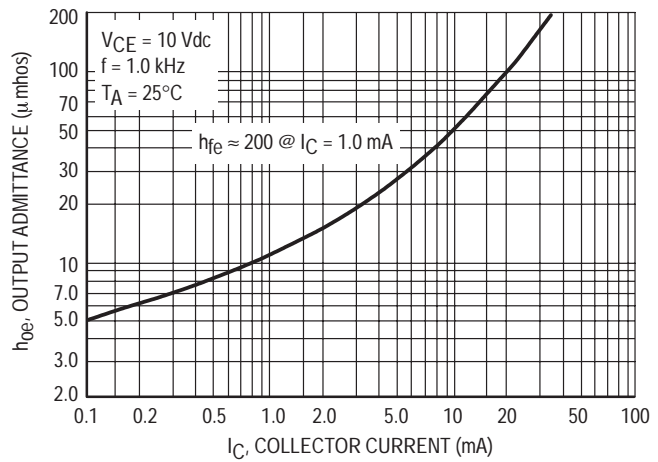


Figure 18. Output Admittance

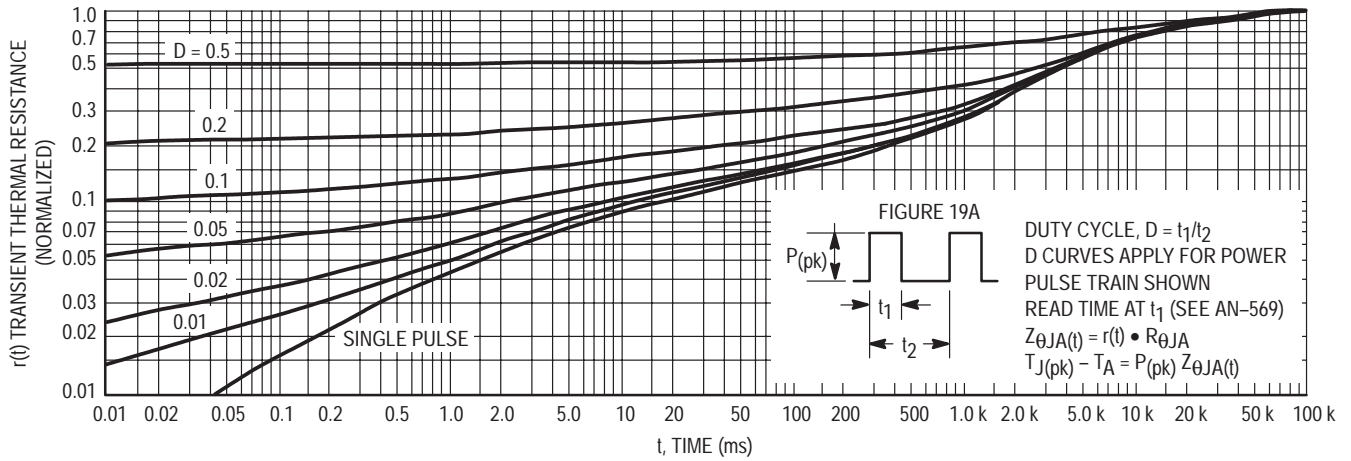


Figure 19. Thermal Response

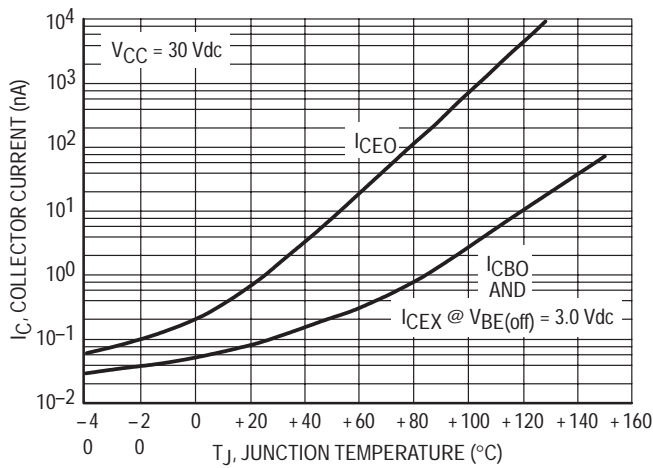


Figure 19A.

DESIGN NOTE: USE OF THERMAL RESPONSE DATA

A train of periodical power pulses can be represented by the model as shown in Figure 19A. Using the model and the device thermal response the normalized effective transient thermal resistance of Figure 19 was calculated for various duty cycles.

To find $Z_{\theta JA}(t)$, multiply the value obtained from Figure 19 by the steady state value $R_{\theta JA}$.

Example:

The MPS3904 is dissipating 2.0 watts peak under the following conditions:

$$t_1 = 1.0 \text{ ms}, t_2 = 5.0 \text{ ms. (D = 0.2)}$$

Using Figure 19 at a pulse width of 1.0 ms and D = 0.2, the reading of $r(t)$ is 0.22.

The peak rise in junction temperature is therefore

$$\Delta T = r(t) \times P_{(pk)} \times R_{\theta JA} = 0.22 \times 2.0 \times 200 = 88^\circ\text{C}.$$

For more information, see AN-569.

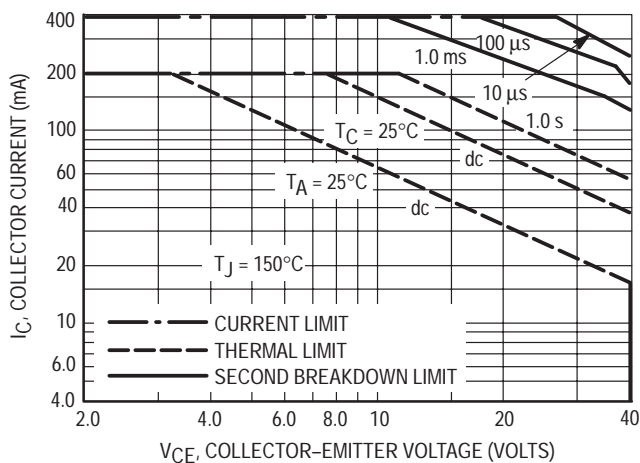


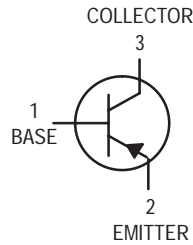
Figure 20.

The safe operating area curves indicate I_C - V_{CE} limits of the transistor that must be observed for reliable operation. Collector load lines for specific circuits must fall below the limits indicated by the applicable curve.

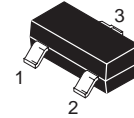
The data of Figure 20 is based upon $T_{J(pk)} = 150^\circ\text{C}$; T_C or T_A is variable depending upon conditions. Pulse curves are valid for duty cycles to 10% provided $T_{J(pk)} \leq 150^\circ\text{C}$. $T_{J(pk)}$ may be calculated from the data in Figure 19. At high case or ambient temperatures, thermal limitations will reduce the power that can be handled to values less than the limitations imposed by second breakdown.

General Purpose Transistors

PNP Silicon



BCW61BLT1
BCW61CLT1
BCW61DLT1



CASE 318-08, STYLE 6
SOT-23 (TO-236AB)

MAXIMUM RATINGS

Rating	Symbol	Value	Unit
Collector-Emitter Voltage	V_{CEO}	-32	Vdc
Collector-Base Voltage	V_{CBO}	-32	Vdc
Emitter-Base Voltage	V_{EBO}	-5.0	Vdc
Collector Current — Continuous	I_C	-100	mAdc

THERMAL CHARACTERISTICS

Characteristic	Symbol	Max	Unit
Total Device Dissipation FR-5 Board ⁽¹⁾ $T_A = 25^\circ\text{C}$ Derate above 25°C	P_D	225	mW
		1.8	mW/ $^\circ\text{C}$
Thermal Resistance Junction to Ambient	$R_{\theta JA}$	556	$^\circ\text{C}/\text{W}$
Total Device Dissipation Alumina Substrate, ⁽²⁾ $T_A = 25^\circ\text{C}$ Derate above 25°C	P_D	300	mW
		2.4	mW/ $^\circ\text{C}$
Thermal Resistance Junction to Ambient	$R_{\theta JA}$	417	$^\circ\text{C}/\text{W}$
Junction and Storage Temperature	T_J, T_{stg}	-55 to +150	$^\circ\text{C}$

DEVICE MARKING

BCW61BLT1 = BB, BCW61CLT1 = BC, BCW61DLT1 = BD

ELECTRICAL CHARACTERISTICS ($T_A = 25^\circ\text{C}$ unless otherwise noted)

Characteristic	Symbol	Min	Max	Unit
----------------	--------	-----	-----	------

OFF CHARACTERISTICS

Collector-Emitter Breakdown Voltage ($I_C = -2.0$ mAdc, $I_B = 0$)	$V_{(BR)CEO}$	-32	—	Vdc
Emitter-Base Breakdown Voltage ($I_E = -1.0$ μ Adc, $I_C = 0$)	$V_{(BR)EBO}$	-5.0	—	Vdc
Collector Cutoff Current ($V_{CE} = -32$ Vdc) ($V_{CE} = -32$ Vdc, $T_A = 150^\circ\text{C}$)	I_{CES}	—	-20 -20	nAdc μ Adc

1. FR-5 = $1.0 \times 0.75 \times 0.062$ in.

2. Alumina = $0.4 \times 0.3 \times 0.024$ in. 99.5% alumina.

ELECTRICAL CHARACTERISTICS ($T_A = 25^\circ\text{C}$ unless otherwise noted) (Continued)

Characteristic	Symbol	Min	Max	Unit	
ON CHARACTERISTICS					
DC Current Gain ($I_C = -10\ \mu\text{Adc}$, $V_{CE} = -5.0\ \text{Vdc}$) ($I_C = -2.0\ \text{mAdc}$, $V_{CE} = -5.0\ \text{Vdc}$) ($I_C = -50\ \text{mAdc}$, $V_{CE} = -1.0\ \text{Vdc}$)	BCW61B	h_{FE}	30	—	—
	BCW61C		40	—	
	BCW61D		100	—	
	BCW61B		140	310	
	BCW61C		250	460	
	BCW61D		380	630	
	BCW61B		80	—	
	BCW61C		100	—	
	BCW61D		100	—	
AC Current Gain ($V_{CE} = -5.0\ \text{Vdc}$, $I_C = -2.0\ \text{mAdc}$, $f = 1.0\ \text{kHz}$)	BCW61B BCW61C BCW61D	h_{fe}	175 250 350	350 500 700	—
Collector–Emitter Saturation Voltage ($I_C = -50\ \text{mAdc}$, $I_B = -1.25\ \text{mAdc}$) ($I_C = -10\ \text{mAdc}$, $I_B = -0.25\ \text{mAdc}$)		$V_{CE(\text{sat})}$	— —	-0.55 -0.25	Vdc
Base–Emitter Saturation Voltage ($I_C = -50\ \text{mAdc}$, $I_B = -1.25\ \text{mAdc}$) ($I_C = -10\ \text{mAdc}$, $I_B = -0.25\ \text{mAdc}$)		$V_{BE(\text{sat})}$	-0.68 -0.6	-1.05 -0.85	Vdc
Base–Emitter On Voltage ($I_C = -2.0\ \text{mAdc}$, $V_{CE} = -5.0\ \text{Vdc}$)		$V_{BE(\text{on})}$	-0.6	-0.75	Vdc
SMALL–SIGNAL CHARACTERISTICS					
Output Capacitance ($V_{CE} = -10\ \text{Vdc}$, $I_C = 0$, $f = 1.0\ \text{MHz}$)		C_{obo}	—	6.0	pF
Noise Figure ($V_{CE} = -5.0\ \text{Vdc}$, $I_C = -0.2\ \text{mAdc}$, $R_S = 2.0\ \text{k}\Omega$, $f = 1.0\ \text{kHz}$, $BW = 200\ \text{Hz}$)		NF	—	6.0	dB
SWITCHING CHARACTERISTICS					
Turn–On Time ($I_C = -10\ \text{mAdc}$, $I_{B1} = -1.0\ \text{mAdc}$)		t_{on}	—	150	ns
Turn–Off Time ($I_{B2} = -1.0\ \text{mAdc}$, $V_{BB} = -3.6\ \text{Vdc}$, $R_1 = R_2 = 5.0\ \text{k}\Omega$, $R_L = 990\ \Omega$)		t_{off}	—	800	ns

TYPICAL NOISE CHARACTERISTICS

($V_{CE} = -5.0$ Vdc, $T_A = 25^\circ\text{C}$)

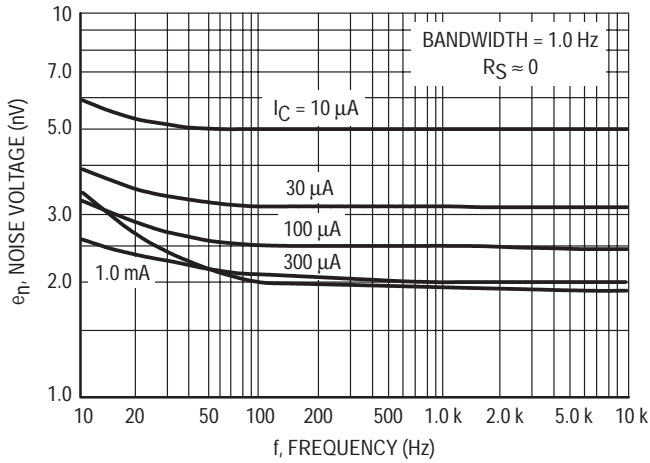


Figure 1. Noise Voltage

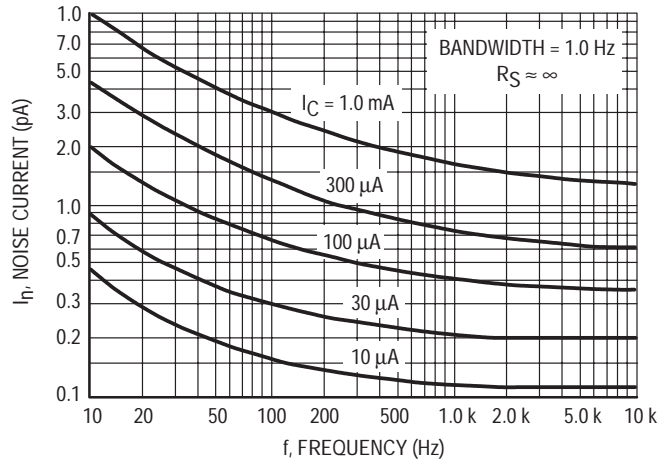


Figure 2. Noise Current

NOISE FIGURE CONTOURS

($V_{CE} = -5.0$ Vdc, $T_A = 25^\circ\text{C}$)

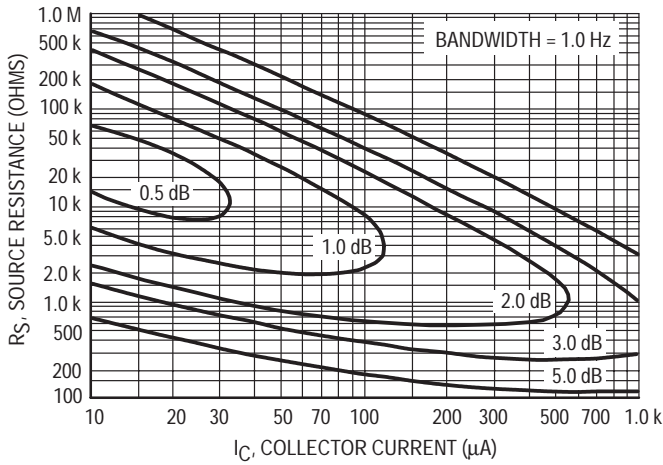


Figure 3. Narrow Band, 100 Hz

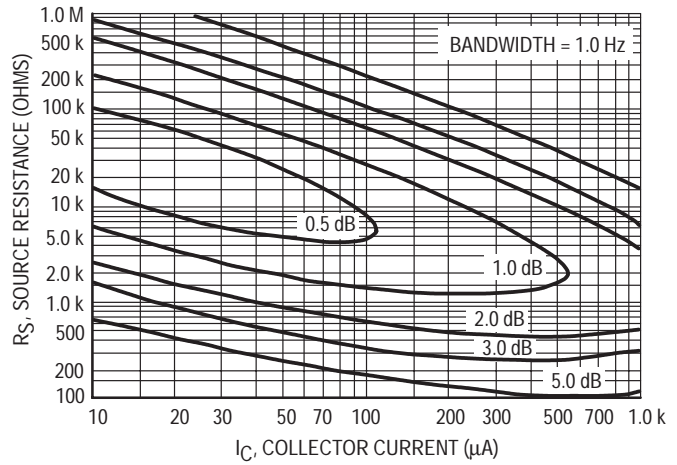


Figure 4. Narrow Band, 1.0 kHz

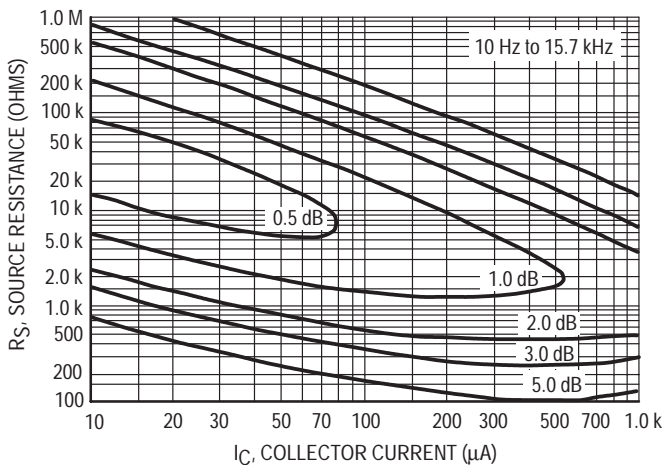


Figure 5. Wideband

Noise Figure is Defined as:

$$NF = 20 \log_{10} \left[\frac{e_n^2 + 4KTR_S + I_n^2 R_S^2}{4KTR_S} \right]^{1/2}$$

- e_n = Noise Voltage of the Transistor referred to the input. (Figure 3)
- I_n = Noise Current of the Transistor referred to the input. (Figure 4)
- K = Boltzman's Constant (1.38×10^{-23} j/°K)
- T = Temperature of the Source Resistance (°K)
- R_S = Source Resistance (Ohms)

TYPICAL STATIC CHARACTERISTICS

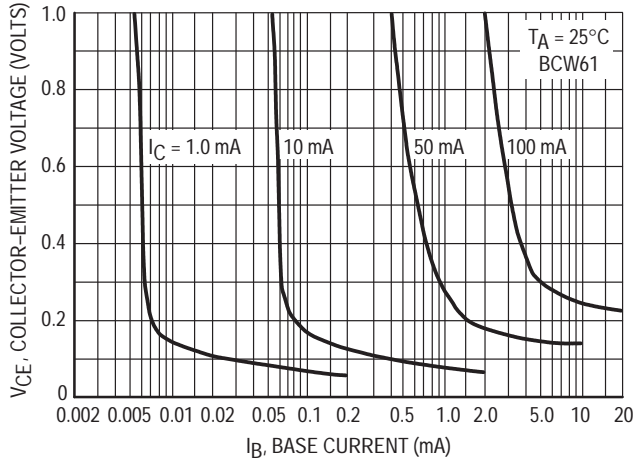


Figure 6. Collector Saturation Region

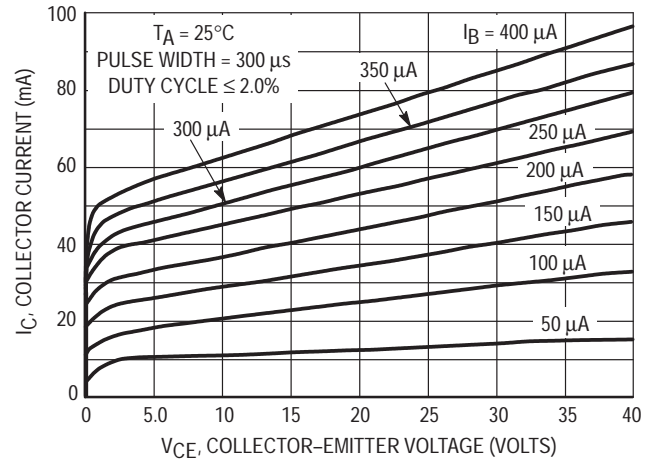


Figure 7. Collector Characteristics

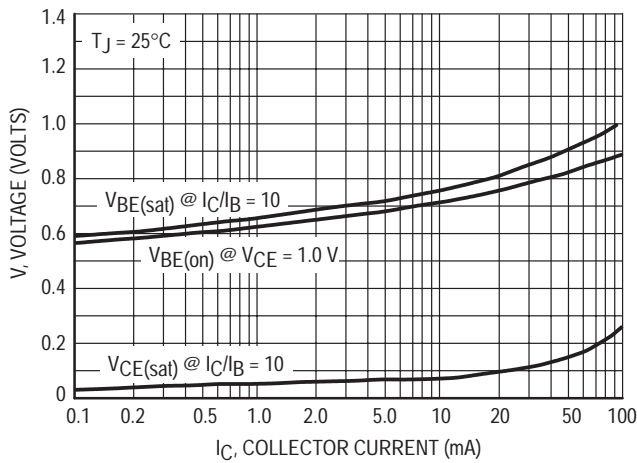


Figure 8. "On" Voltages

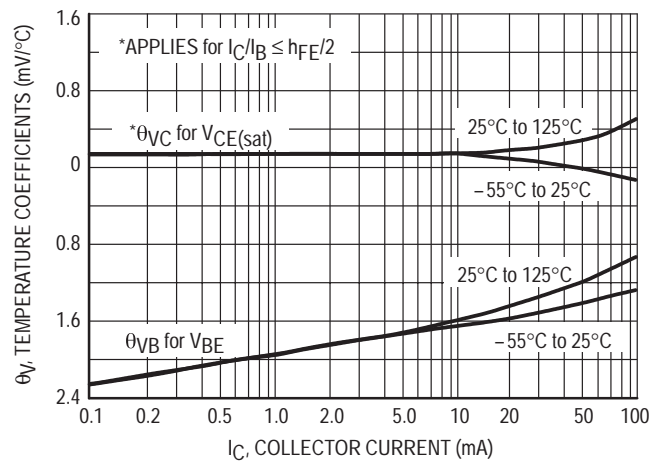


Figure 9. Temperature Coefficients

TYPICAL DYNAMIC CHARACTERISTICS

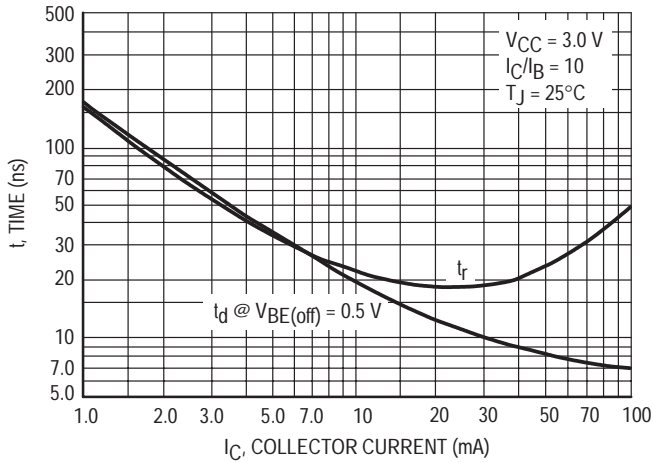


Figure 10. Turn-On Time

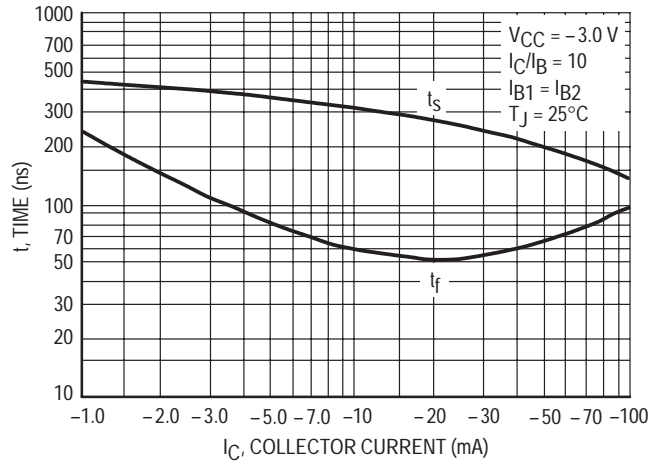


Figure 11. Turn-Off Time

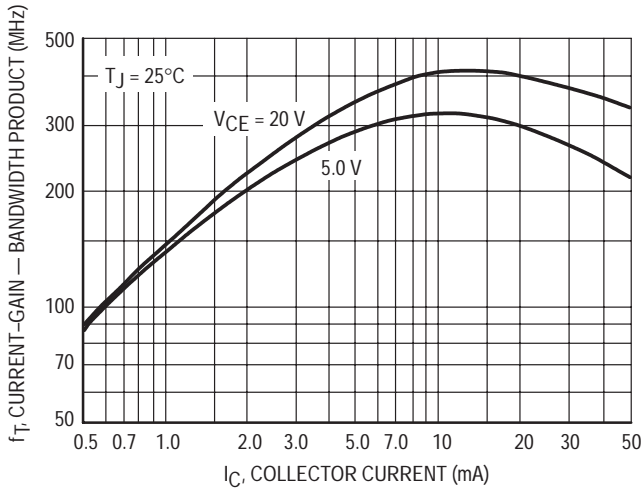


Figure 12. Current-Gain — Bandwidth Product

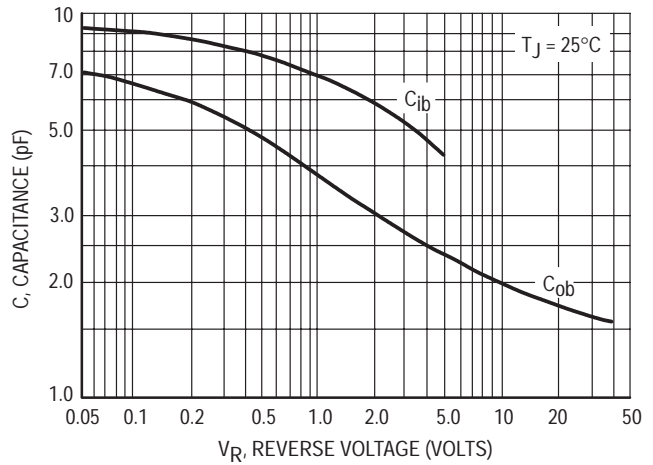


Figure 13. Capacitance

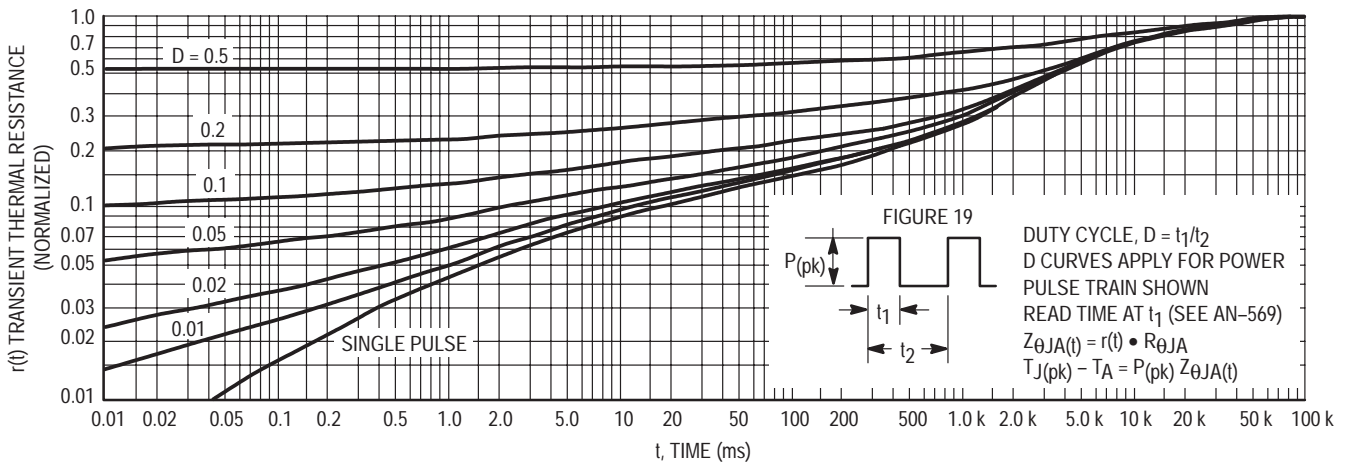


Figure 14. Thermal Response

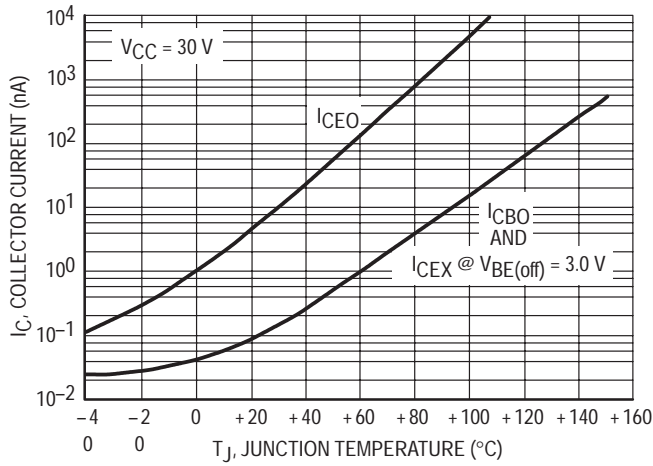


Figure 15. Typical Collector Leakage Current

DESIGN NOTE: USE OF THERMAL RESPONSE DATA

A train of periodical power pulses can be represented by the model as shown in Figure 15. Using the model and the device thermal response the normalized effective transient thermal resistance of Figure 14 was calculated for various duty cycles.

To find $Z_{\theta JA}(t)$, multiply the value obtained from Figure 14 by the steady state value $R_{\theta JA}$.

Example:

The MPS3905 is dissipating 2.0 watts peak under the following conditions:

$$t_1 = 1.0 \text{ ms}, t_2 = 5.0 \text{ ms} (D = 0.2)$$

Using Figure 14 at a pulse width of 1.0 ms and $D = 0.2$, the reading of $r(t)$ is 0.22.

The peak rise in junction temperature is therefore

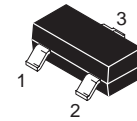
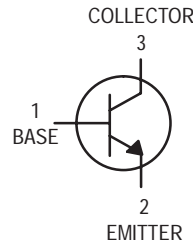
$$\Delta T = r(t) \times P_{(pk)} \times R_{\theta JA} = 0.22 \times 2.0 \times 200 = 88^\circ\text{C}.$$

For more information, see AN-569.

General Purpose Transistor

NPN Silicon

BCW65ALT1



CASE 318-08, STYLE 6
SOT-23 (TO-236AB)

MAXIMUM RATINGS

Rating	Symbol	Value	Unit
Collector–Emitter Voltage	V_{CEO}	32	Vdc
Collector–Base Voltage	V_{CBO}	60	Vdc
Emitter–Base Voltage	V_{EBO}	5.0	Vdc
Collector Current — Continuous	I_C	800	mAdc

THERMAL CHARACTERISTICS

Characteristic	Symbol	Max	Unit
Total Device Dissipation FR-5 Board ⁽¹⁾ $T_A = 25^\circ\text{C}$ Derate above 25°C	P_D	225	mW
		1.8	mW/ $^\circ\text{C}$
Thermal Resistance, Junction to Ambient	$R_{\theta JA}$	556	$^\circ\text{C}/\text{W}$
Total Device Dissipation Alumina Substrate, ⁽²⁾ $T_A = 25^\circ\text{C}$ Derate above 25°C	P_D	300	mW
		2.4	mW/ $^\circ\text{C}$
Thermal Resistance, Junction to Ambient	$R_{\theta JA}$	417	$^\circ\text{C}/\text{W}$
Junction and Storage Temperature	T_J, T_{stg}	-55 to +150	$^\circ\text{C}$

DEVICE MARKING

BCW65ALT1 = EA

ELECTRICAL CHARACTERISTICS ($T_A = 25^\circ\text{C}$ unless otherwise noted)

Characteristic	Symbol	Min	Typ	Max	Unit
----------------	--------	-----	-----	-----	------

OFF CHARACTERISTICS

Collector–Emitter Breakdown Voltage ($I_C = 10 \text{ mAdc}, I_B = 0$)	$V_{(BR)CEO}$	32	—	—	Vdc
Collector–Emitter Breakdown Voltage ($I_C = 10 \mu\text{Adc}, V_{EB} = 0$)	$V_{(BR)CES}$	60	—	—	Vdc
Emitter–Base Breakdown Voltage ($I_E = 10 \mu\text{Adc}, I_C = 0$)	$V_{(BR)EBO}$	5.0	—	—	Vdc
Collector Cutoff Current ($V_{CE} = 32 \text{ Vdc}, I_E = 0$) ($V_{CE} = 32 \text{ Vdc}, I_E = 0, T_A = 150^\circ\text{C}$)	I_{CES}	—	—	20	nAdc μAdc
Emitter Cutoff Current ($V_{EB} = 4.0 \text{ Vdc}, I_C = 0$)	I_{EBO}	—	—	20	nAdc

1. FR-5 = $1.0 \times 0.75 \times 0.062 \text{ in.}$

2. Alumina = $0.4 \times 0.3 \times 0.024 \text{ in. } 99.5\% \text{ alumina.}$

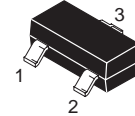
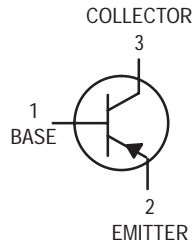
ELECTRICAL CHARACTERISTICS ($T_A = 25^\circ\text{C}$ unless otherwise noted) (Continued)

Characteristic	Symbol	Min	Typ	Max	Unit
ON CHARACTERISTICS					
DC Current Gain ($I_C = 100 \mu\text{Adc}$, $V_{CE} = 10 \text{ Vdc}$) ($I_C = 10 \text{ mAdc}$, $V_{CE} = 1.0 \text{ Vdc}$) ($I_C = 100 \text{ mAdc}$, $V_{CE} = 1.0 \text{ Vdc}$) ($I_C = 500 \text{ mAdc}$, $V_{CE} = 2.0 \text{ Vdc}$)	h_{FE}	35 75 100 35	— — — —	— 220 250 —	—
Collector–Emitter Saturation Voltage ($I_C = 500 \text{ mAdc}$, $I_B = 50 \text{ mAdc}$) ($I_C = 100 \text{ mAdc}$, $I_B = 10 \text{ mAdc}$)	$V_{CE(\text{sat})}$	— —	0.7 0.3	— —	Vdc
Base–Emitter Saturation Voltage ($I_C = 500 \text{ mAdc}$, $I_B = 50 \text{ mAdc}$)	$V_{BE(\text{sat})}$	—	—	2.0	Vdc
SMALL–SIGNAL CHARACTERISTICS					
Current–Gain — Bandwidth Product ($I_C = 20 \text{ mAdc}$, $V_{CE} = 10 \text{ Vdc}$, $f = 100 \text{ MHz}$)	f_T	100	—	—	MHz
Output Capacitance ($V_{CB} = 10 \text{ Vdc}$, $I_E = 0$, $f = 1.0 \text{ MHz}$)	C_{obo}	—	—	12	pF
Input Capacitance ($V_{EB} = 0.5 \text{ Vdc}$, $I_C = 0$, $f = 1.0 \text{ MHz}$)	C_{ibo}	—	—	80	pF
Noise Figure ($V_{CE} = 5.0 \text{ Vdc}$, $I_C = 0.2 \text{ mAdc}$, $R_S = 1.0 \text{ k}\Omega$, $f = 1.0 \text{ kHz}$, $BW = 200 \text{ Hz}$)	NF	—	—	10	dB
SWITCHING CHARACTERISTICS					
Turn–On Time ($I_{B1} = I_{B2} = 15 \text{ mAdc}$)	t_{on}	—	—	100	ns
Turn–Off Time ($I_C = 150 \text{ mAdc}$, $R_L = 150 \Omega$)	t_{off}	—	—	400	ns

General Purpose Transistor

PNP Silicon

BCW68GLT1



CASE 318-08, STYLE 6
SOT-23 (TO-236AB)

MAXIMUM RATINGS

Rating	Symbol	Value	Unit
Collector-Emitter Voltage	V_{CEO}	-45	Vdc
Collector-Base Voltage	V_{CBO}	-60	Vdc
Emitter-Base Voltage	V_{EBO}	-5.0	Vdc
Collector Current — Continuous	I_C	-800	mAdc

DEVICE MARKING

BCW68GLT1 = DH

THERMAL CHARACTERISTICS

Characteristic	Symbol	Max	Unit
Total Device Dissipation FR-5 Board (1) $T_A = 25^\circ\text{C}$ Derate above 25°C	P_D	225 1.8	mW mW/°C
Thermal Resistance, Junction to Ambient	$R_{\theta JA}$	556	°C/W
Total Device Dissipation Alumina Substrate, (2) $T_A = 25^\circ\text{C}$ Derate above 25°C	P_D	300 2.4	mW mW/°C
Thermal Resistance, Junction to Ambient	$R_{\theta JA}$	417	°C/W
Junction and Storage Temperature	T_J, T_{stg}	-55 to +150	°C

ELECTRICAL CHARACTERISTICS ($T_A = 25^\circ\text{C}$ unless otherwise noted)

Characteristic	Symbol	Min	Typ	Max	Unit
----------------	--------	-----	-----	-----	------

OFF CHARACTERISTICS

Collector-Emitter Breakdown Voltage ($I_C = -10$ mAdc, $I_B = 0$)	$V_{(BR)CEO}$	-45	—	—	Vdc
Collector-Emitter Breakdown Voltage ($I_C = -10$ μ Adc, $V_{EB} = 0$)	$V_{(BR)CES}$	-60	—	—	Vdc
Emitter-Base Breakdown Voltage ($I_E = -10$ μ Adc, $I_C = 0$)	$V_{(BR)EBO}$	-5.0	—	—	Vdc
Collector Cutoff Current ($V_{CE} = -45$ Vdc, $I_E = 0$) ($V_{CE} = -45$ Vdc, $I_B = 0$, $T_A = 150^\circ\text{C}$)	I_{CES}	—	—	-20 -10	nAdc μ Adc
Emitter Cutoff Current ($V_{EB} = -4.0$ Vdc, $I_C = 0$)	I_{EBO}	—	—	-20	nAdc

1. FR-5 = 1.0 x 0.75 x 0.062 in.

2. Alumina = 0.4 x 0.3 x 0.024 in. 99.5% alumina

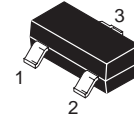
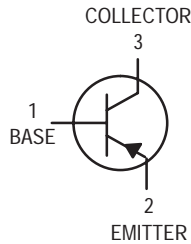
ELECTRICAL CHARACTERISTICS ($T_A = 25^\circ\text{C}$ unless otherwise noted) (Continued)

Characteristic	Symbol	Min	Typ	Max	Unit
ON CHARACTERISTICS					
DC Current Gain ($I_C = -10\text{ mAdc}$, $V_{CE} = -1.0\text{ Vdc}$) ($I_C = -100\text{ mAdc}$, $V_{CE} = -1.0\text{ Vdc}$) ($I_C = -300\text{ mAdc}$, $V_{CE} = -1.0\text{ Vdc}$)	h_{FE}	120 160 60	— — —	400 — —	—
Collector–Emitter Saturation Voltage ($I_C = -300\text{ mAdc}$, $I_B = -30\text{ mAdc}$)	$V_{CE(sat)}$	—	—	-1.5	Vdc
Base–Emitter Saturation Voltage ($I_C = -500\text{ mAdc}$, $I_B = -50\text{ mAdc}$)	$V_{BE(sat)}$	—	—	-2.0	Vdc
SMALL–SIGNAL CHARACTERISTICS					
Current–Gain — Bandwidth Product ($I_C = -20\text{ mAdc}$, $V_{CE} = -10\text{ Vdc}$, $f = 100\text{ MHz}$)	f_T	100	—	—	MHz
Output Capacitance ($V_{CB} = -10\text{ Vdc}$, $I_E = 0$, $f = 1.0\text{ MHz}$)	C_{obo}	—	—	18	pF
Input Capacitance ($V_{EB} = -0.5\text{ Vdc}$, $I_C = 0$, $f = 1.0\text{ MHz}$)	C_{ibo}	—	—	105	pF
Noise Figure ($I_C = -0.2\text{ mAdc}$, $V_{CE} = -5.0\text{ Vdc}$, $R_S = 1.0\text{ k}\Omega$, $f = 1.0\text{ kHz}$, BW = 200 Hz)	N _F	—	—	10	dB

General Purpose Transistors

PNP Silicon

BCW69LT1
BCW70LT1



CASE 318-08, STYLE 6
SOT-23 (TO-236AB)

MAXIMUM RATINGS

Rating	Symbol	Value	Unit
Collector-Emitter Voltage	V_{CEO}	-45	Vdc
Emitter-Base Voltage	V_{EBO}	-5.0	Vdc
Collector Current — Continuous	I_C	-100	mAdc

DEVICE MARKING

BCW69LT1 = H1; BCW70LT1 = H2

THERMAL CHARACTERISTICS

Characteristic	Symbol	Max	Unit
Total Device Dissipation FR-5 Board (1) $T_A = 25^\circ\text{C}$ Derate above 25°C	P_D	225	mW
		1.8	mW/ $^\circ\text{C}$
Thermal Resistance, Junction to Ambient	$R_{\theta JA}$	556	$^\circ\text{C/W}$
Total Device Dissipation Alumina Substrate, (2) $T_A = 25^\circ\text{C}$ Derate above 25°C	P_D	300	mW
		2.4	mW/ $^\circ\text{C}$
Thermal Resistance, Junction to Ambient	$R_{\theta JA}$	417	$^\circ\text{C/W}$
Junction and Storage Temperature	T_J, T_{stg}	-55 to +150	$^\circ\text{C}$

ELECTRICAL CHARACTERISTICS ($T_A = 25^\circ\text{C}$ unless otherwise noted)

Characteristic	Symbol	Min	Max	Unit
----------------	--------	-----	-----	------

OFF CHARACTERISTICS

Collector-Emitter Breakdown Voltage ($I_C = -2.0$ mAdc, $I_B = 0$)	$V_{(BR)CEO}$	-45	—	Vdc
Collector-Emitter Breakdown Voltage ($I_C = -100$ μAdc , $V_{EB} = 0$)	$V_{(BR)CES}$	-50	—	Vdc
Emitter-Base Breakdown Voltage ($I_E = -10$ μAdc , $I_C = 0$)	$V_{(BR)EBO}$	-5.0	—	Vdc
Collector Cutoff Current ($V_{CB} = -20$ Vdc, $I_E = 0$) ($V_{CB} = -20$ Vdc, $I_E = 0$, $T_A = 100^\circ\text{C}$)	I_{CBO}	—	-100 -10	nAdc μAdc

1. FR-5 = 1.0 x 0.75 x 0.062 in.

2. Alumina = 0.4 x 0.3 x 0.024 in. 99.5% alumina

ELECTRICAL CHARACTERISTICS ($T_A = 25^\circ\text{C}$ unless otherwise noted) (Continued)

Characteristic	Symbol	Min	Max	Unit
ON CHARACTERISTICS				
DC Current Gain ($I_C = -2.0\text{ mA dc}$, $V_{CE} = -5.0\text{ V dc}$)	h_{FE}	120	260	—
	BCW69	215	500	
	BCW70			
Collector–Emitter Saturation Voltage ($I_C = -10\text{ mA dc}$, $I_B = -0.5\text{ mA dc}$)	$V_{CE(sat)}$	—	–0.3	Vdc
Base–Emitter On Voltage ($I_C = -2.0\text{ mA dc}$, $V_{CE} = -5.0\text{ V dc}$)	$V_{BE(on)}$	–0.6	–0.75	Vdc
SMALL–SIGNAL CHARACTERISTICS				
Output Capacitance ($I_E = 0$, $V_{CB} = -10\text{ V dc}$, $f = 1.0\text{ MHz}$)	C_{obo}	—	7.0	pF
Noise Figure ($I_C = -0.2\text{ mA dc}$, $V_{CE} = -5.0\text{ V dc}$, $R_S = 2.0\text{ k}\Omega$, $f = 1.0\text{ kHz}$, $BW = 200\text{ Hz}$)	N_F	—	10	dB

TYPICAL NOISE CHARACTERISTICS

($V_{CE} = -5.0$ Vdc, $T_A = 25^\circ\text{C}$)

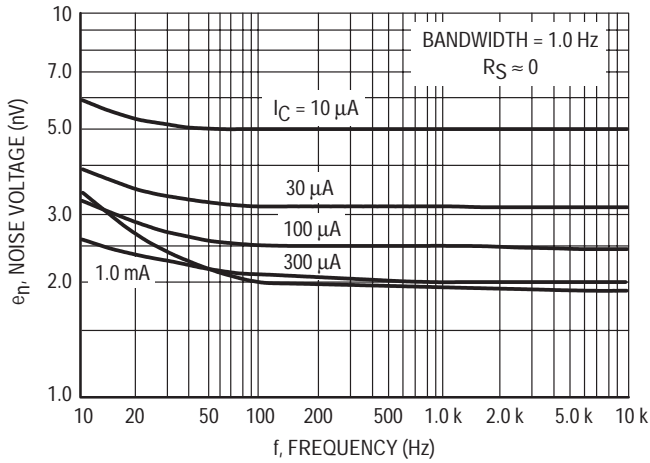


Figure 1. Noise Voltage

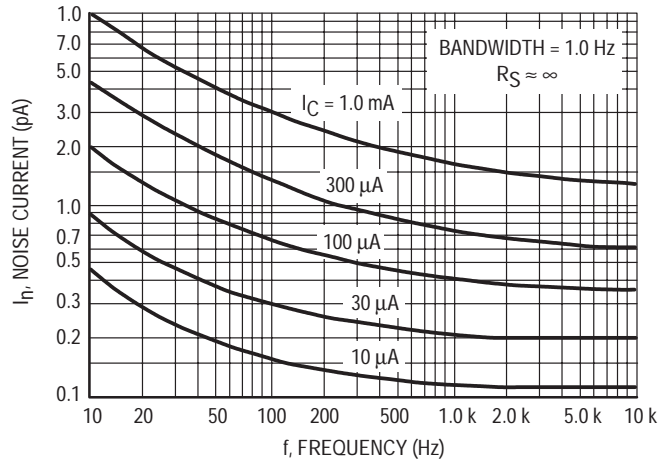


Figure 2. Noise Current

NOISE FIGURE CONTOURS

($V_{CE} = -5.0$ Vdc, $T_A = 25^\circ\text{C}$)

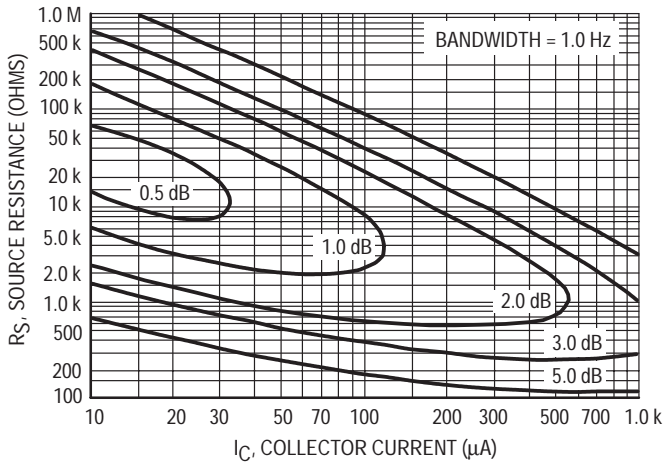


Figure 3. Narrow Band, 100 Hz

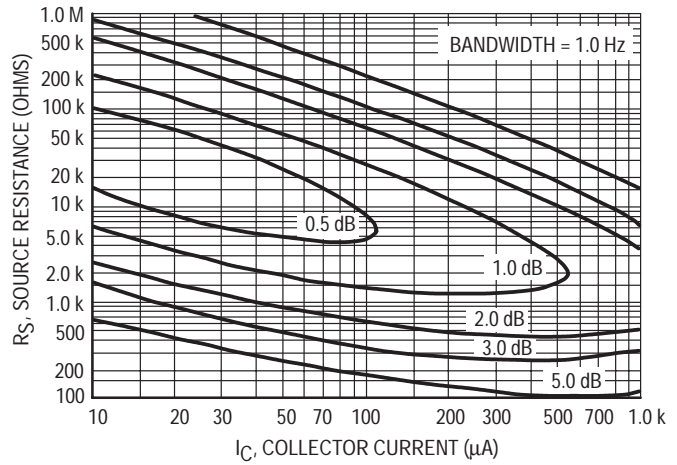


Figure 4. Narrow Band, 1.0 kHz

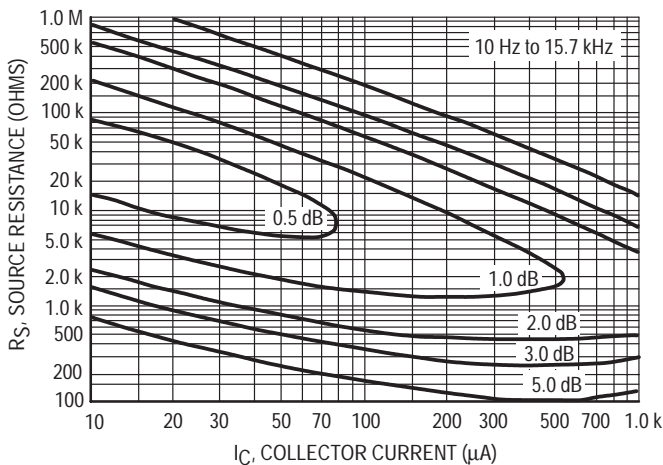


Figure 5. Wideband

Noise Figure is Defined as:

$$NF = 20 \log_{10} \left[\frac{e_n^2 + 4KTR_S + I_n^2 R_S^2}{4KTR_S} \right]^{1/2}$$

- e_n = Noise Voltage of the Transistor referred to the input. (Figure 3)
- I_n = Noise Current of the Transistor referred to the input. (Figure 4)
- K = Boltzman's Constant (1.38×10^{-23} j/ $^\circ\text{K}$)
- T = Temperature of the Source Resistance ($^\circ\text{K}$)
- R_S = Source Resistance (Ohms)

TYPICAL STATIC CHARACTERISTICS

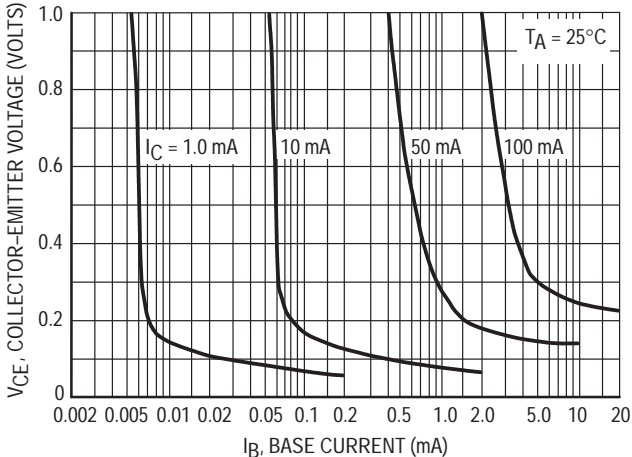


Figure 6. Collector Saturation Region

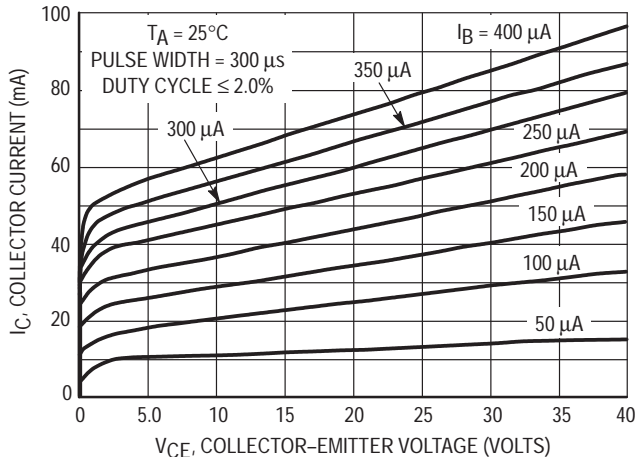


Figure 7. Collector Characteristics

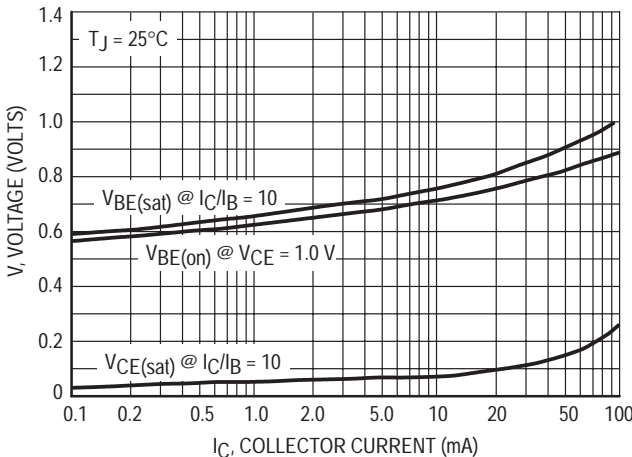


Figure 8. "On" Voltages

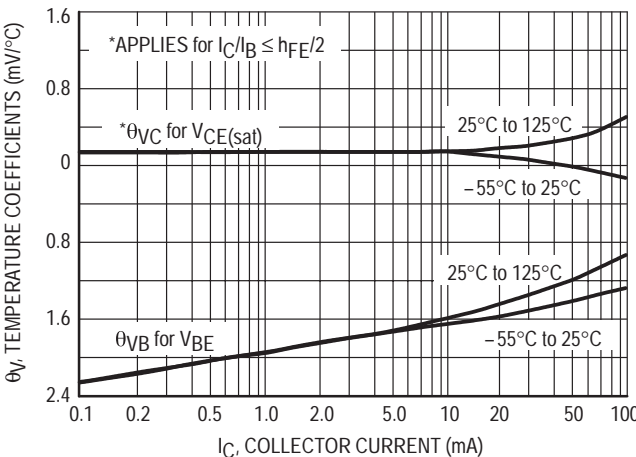


Figure 9. Temperature Coefficients

TYPICAL DYNAMIC CHARACTERISTICS

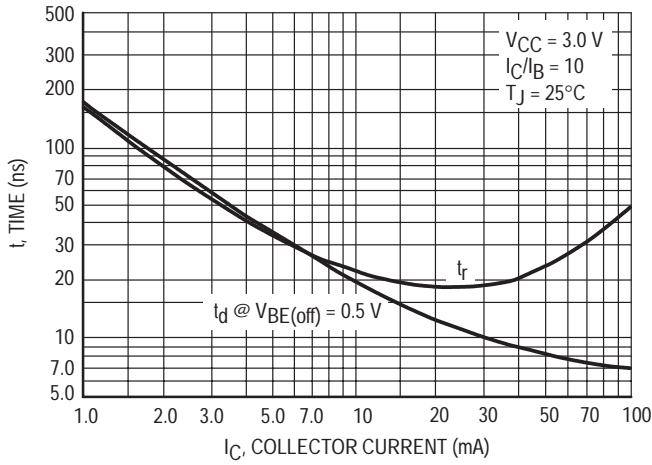


Figure 10. Turn-On Time

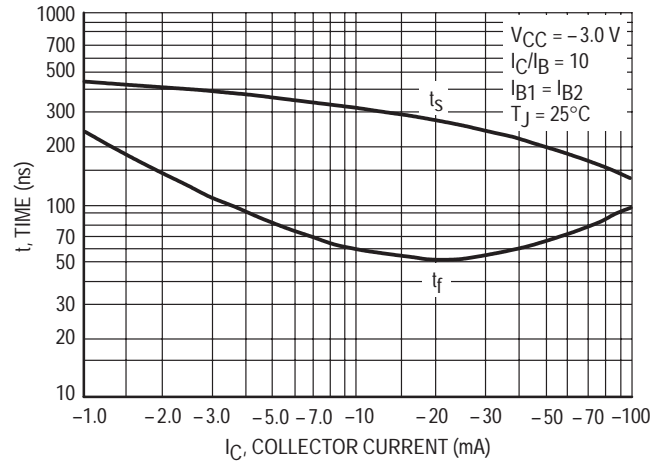


Figure 11. Turn-Off Time

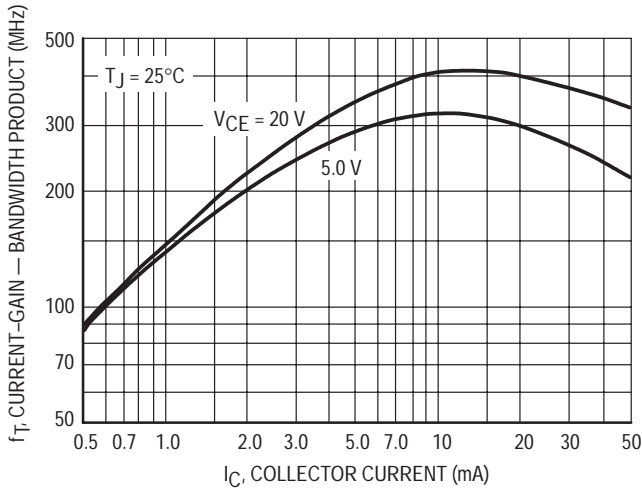


Figure 12. Current-Gain — Bandwidth Product

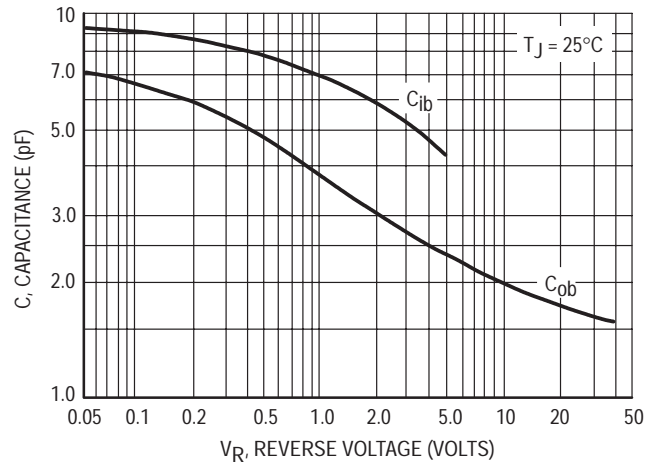


Figure 13. Capacitance

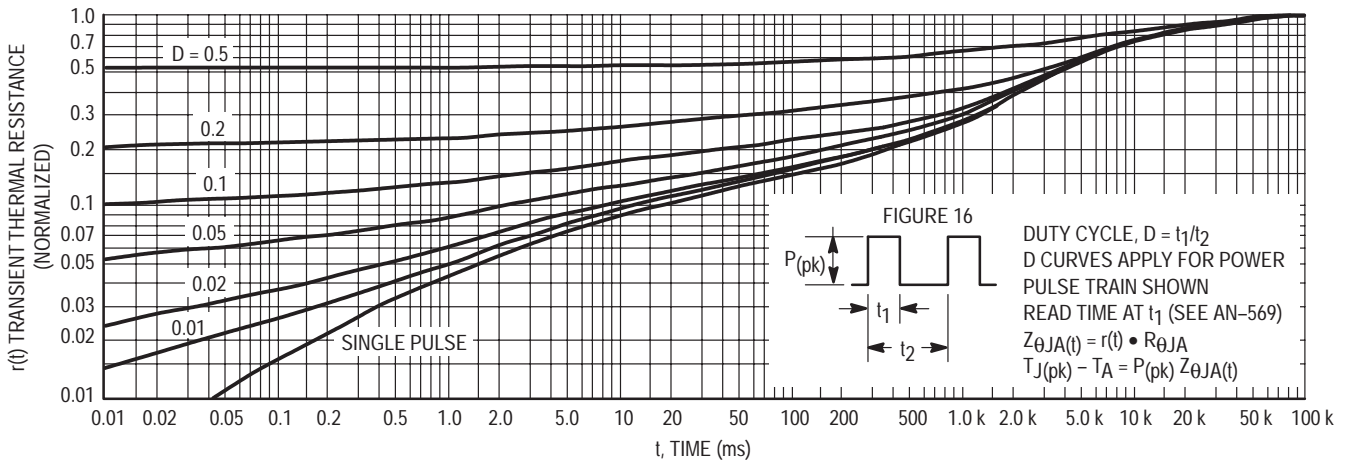


Figure 14. Thermal Response

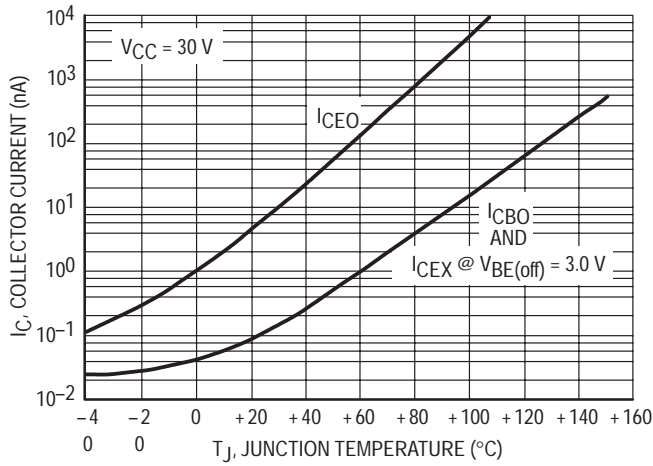


Figure 15. Typical Collector Leakage Current

DESIGN NOTE: USE OF THERMAL RESPONSE DATA

A train of periodical power pulses can be represented by the model as shown in Figure 16. Using the model and the device thermal response the normalized effective transient thermal resistance of Figure 14 was calculated for various duty cycles.

To find Z_{θJA}(t), multiply the value obtained from Figure 14 by the steady state value R_{θJA}.

Example:

Dissipating 2.0 watts peak under the following conditions:

$$t_1 = 1.0 \text{ ms}, t_2 = 5.0 \text{ ms} (D = 0.2)$$

Using Figure 14 at a pulse width of 1.0 ms and D = 0.2, the reading of r(t) is 0.22.

The peak rise in junction temperature is therefore

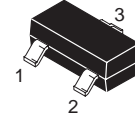
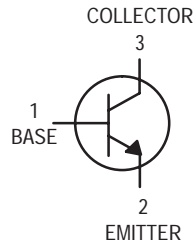
$$\Delta T = r(t) \times P(\text{pk}) \times R_{\theta JA} = 0.22 \times 2.0 \times 200 = 88^\circ\text{C}.$$

For more information, see AN-569.

General Purpose Transistor

NPN Silicon

BCW72LT1



CASE 318-08, STYLE 6
SOT-23 (TO-236AB)

MAXIMUM RATINGS

Rating	Symbol	Value	Unit
Collector-Emitter Voltage	V_{CEO}	45	Vdc
Collector-Base Voltage	V_{CBO}	50	Vdc
Emitter-Base Voltage	V_{EBO}	5.0	Vdc
Collector Current — Continuous	I_C	100	mAdc

THERMAL CHARACTERISTICS

Characteristic	Symbol	Max	Unit
Total Device Dissipation FR-5 Board ⁽¹⁾ $T_A = 25^\circ\text{C}$ Derate above 25°C	P_D	225	mW
		1.8	mW/ $^\circ\text{C}$
Thermal Resistance, Junction to Ambient	$R_{\theta JA}$	556	$^\circ\text{C/W}$
Total Device Dissipation Alumina Substrate, ⁽²⁾ $T_A = 25^\circ\text{C}$ Derate above 25°C	P_D	300	mW
		2.4	mW/ $^\circ\text{C}$
Thermal Resistance, Junction to Ambient	$R_{\theta JA}$	417	$^\circ\text{C/W}$
Junction and Storage Temperature	T_J, T_{stg}	-55 to +150	$^\circ\text{C}$

DEVICE MARKING

BCW72LT1 = K2

ELECTRICAL CHARACTERISTICS ($T_A = 25^\circ\text{C}$ unless otherwise noted)

Characteristic	Symbol	Min	Typ	Max	Unit
----------------	--------	-----	-----	-----	------

OFF CHARACTERISTICS

Collector-Emitter Breakdown Voltage ($I_C = 2.0 \text{ mAdc}, V_{EB} = 0$)	$V_{(BR)CEO}$	45	—	—	Vdc
Collector-Emitter Breakdown Voltage ($I_C = 2.0 \text{ mAdc}, V_{EB} = 0$)	$V_{(BR)CES}$	45	—	—	Vdc
Collector-Base Breakdown Voltage ($I_C = 10 \text{ }\mu\text{Adc}, I_E = 0$)	$V_{(BR)CBO}$	50	—	—	Vdc
Emitter-Base Breakdown Voltage ($I_E = 10 \text{ }\mu\text{Adc}, I_C = 0$)	$V_{(BR)EBO}$	5.0	—	—	Vdc
Collector Cutoff Current ($V_{CB} = 20 \text{ Vdc}, I_E = 0$) ($V_{CB} = 20 \text{ Vdc}, I_E = 0, T_A = 100^\circ\text{C}$)	I_{CBO}	—	—	100 10	nAdc μAdc

1. FR-5 = $1.0 \times 0.75 \times 0.062 \text{ in.}$

2. Alumina = $0.4 \times 0.3 \times 0.024 \text{ in. 99.5\% alumina.}$

ELECTRICAL CHARACTERISTICS ($T_A = 25^\circ\text{C}$ unless otherwise noted) (Continued)

Characteristic	Symbol	Min	Typ	Max	Unit
ON CHARACTERISTICS					
DC Current Gain ($I_C = 2.0\text{ mA}$, $V_{CE} = 5.0\text{ Vdc}$)	h_{FE}	200	—	450	—
Collector–Emitter Saturation Voltage ($I_C = 10\text{ mA}$, $I_B = 0.5\text{ mA}$) ($I_C = 50\text{ mA}$, $I_B = 2.5\text{ mA}$)	$V_{CE(sat)}$	—	— 0.21	0.25	Vdc
Base–Emitter Saturation Voltage ($I_C = 50\text{ mA}$, $I_B = 2.5\text{ mA}$)	$V_{BE(sat)}$	—	0.85	—	Vdc
Base–Emitter On Voltage ($I_C = 2.0\text{ mA}$, $V_{CE} = 5.0\text{ Vdc}$)	$V_{BE(on)}$	0.6	—	0.75	Vdc

SMALL–SIGNAL CHARACTERISTICS

Current–Gain — Bandwidth Product ($I_C = 10\text{ mA}$, $V_{CE} = 5.0\text{ Vdc}$, $f = 100\text{ MHz}$)	f_T	—	300	—	MHz
Output Capacitance ($I_E = 0$, $V_{CB} = 10\text{ Vdc}$, $f = 1.0\text{ MHz}$)	C_{obo}	—	—	4.0	pF
Input Capacitance ($I_E = 0$, $V_{CB} = 10\text{ Vdc}$, $f = 1.0\text{ MHz}$)	C_{ibo}	—	9.0	—	pF
Noise Figure ($I_C = 0.2\text{ mA}$, $V_{CE} = 5.0\text{ Vdc}$, $R_S = 2.0\text{ k}\Omega$, $f = 1.0\text{ kHz}$, $BW = 200\text{ Hz}$)	NF	—	—	10	dB

EQUIVALENT SWITCHING TIME TEST CIRCUITS

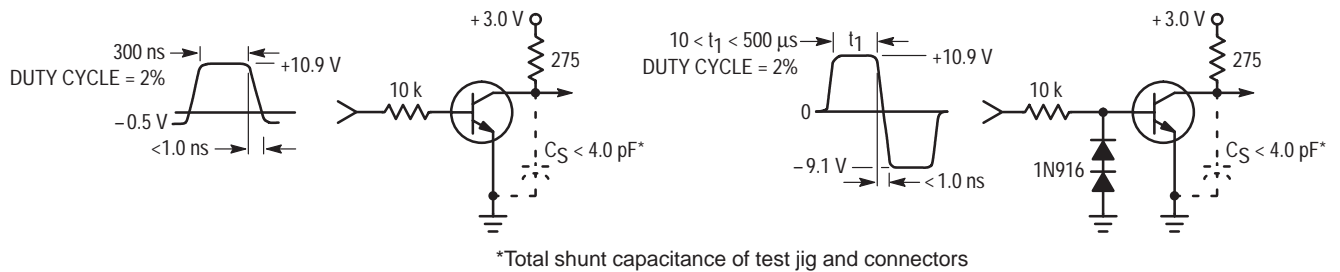


Figure 1. Turn–On Time

Figure 2. Turn–Off Time

TYPICAL NOISE CHARACTERISTICS

($V_{CE} = 5.0\text{ Vdc}$, $T_A = 25^\circ\text{C}$)

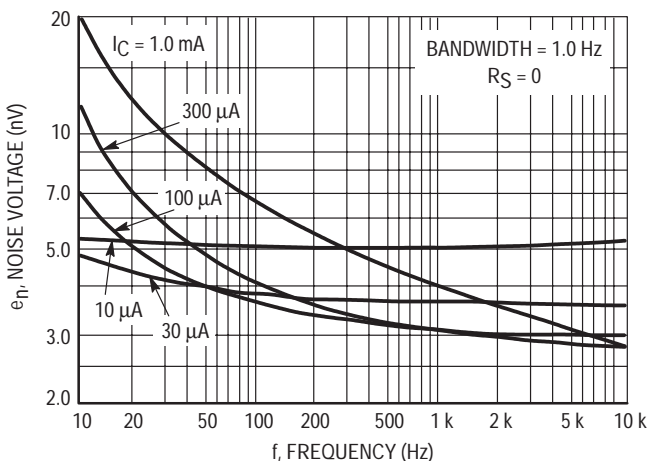


Figure 3. Noise Voltage

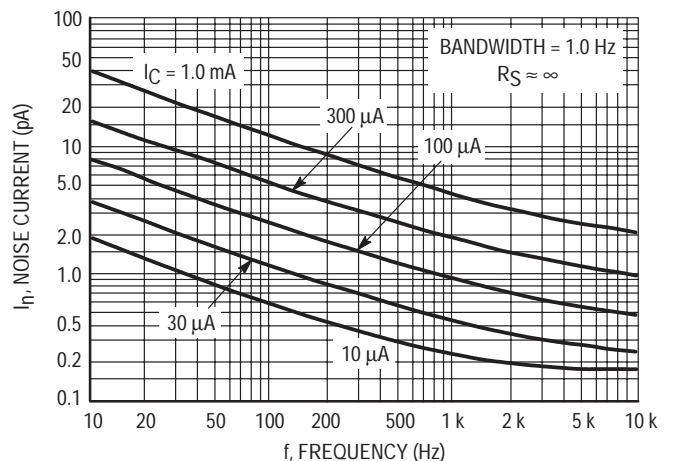


Figure 4. Noise Current

NOISE FIGURE CONTOURS

($V_{CE} = 5.0 \text{ Vdc}$, $T_A = 25^\circ\text{C}$)

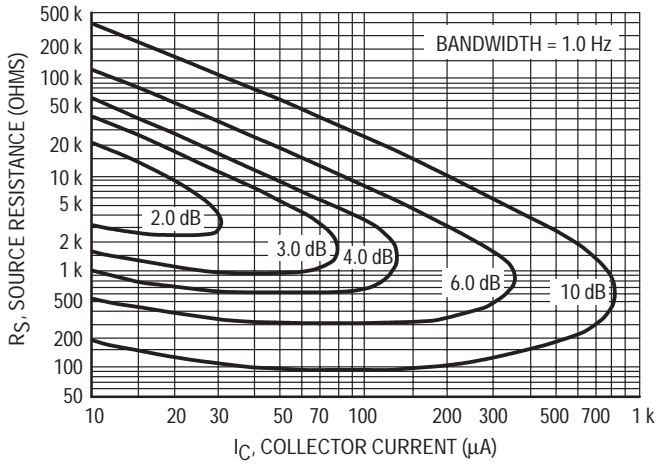


Figure 5. Narrow Band, 100 Hz

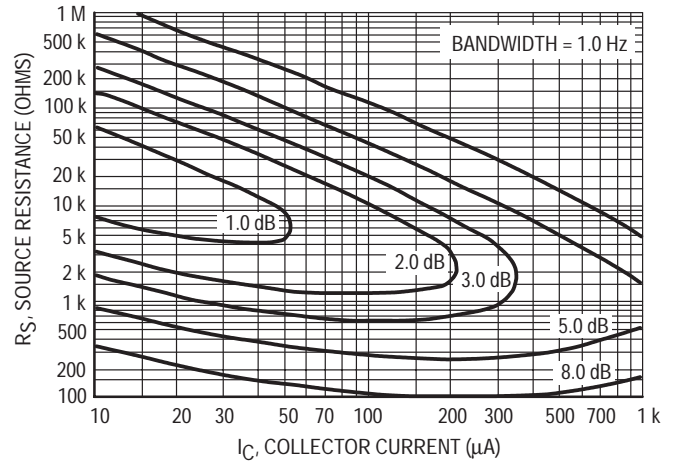


Figure 6. Narrow Band, 1.0 kHz

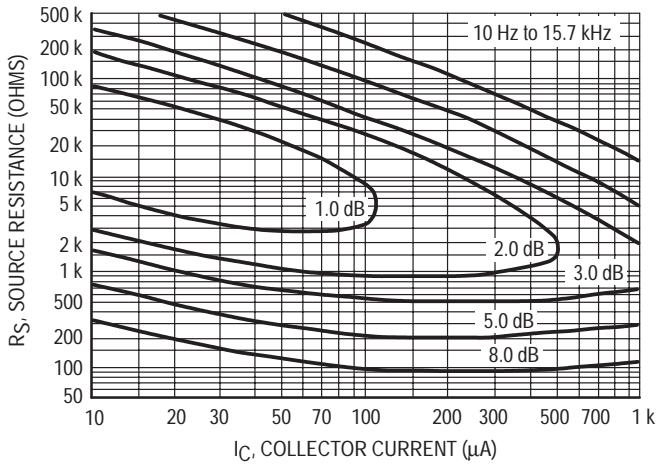


Figure 7. Wideband

Noise Figure is defined as:

$$NF = 20 \log_{10} \left(\frac{e_n^2 + 4KTR_S + I_n^2 R_S^2}{4KTR_S} \right)^{1/2}$$

e_n = Noise Voltage of the Transistor referred to the input. (Figure 3)

I_n = Noise Current of the Transistor referred to the input. (Figure 4)

K = Boltzman's Constant ($1.38 \times 10^{-23} \text{ J/}^\circ\text{K}$)

T = Temperature of the Source Resistance ($^\circ\text{K}$)

R_S = Source Resistance (Ohms)

TYPICAL STATIC CHARACTERISTICS

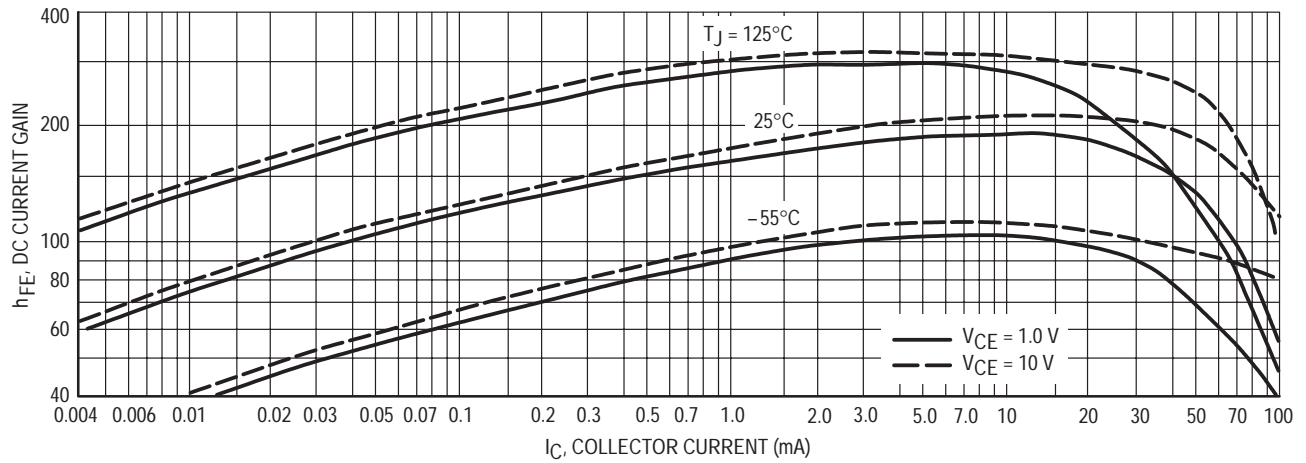


Figure 8. DC Current Gain

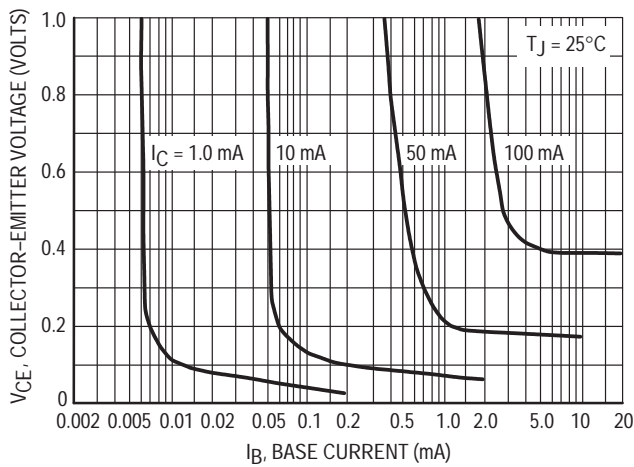


Figure 9. Collector Saturation Region

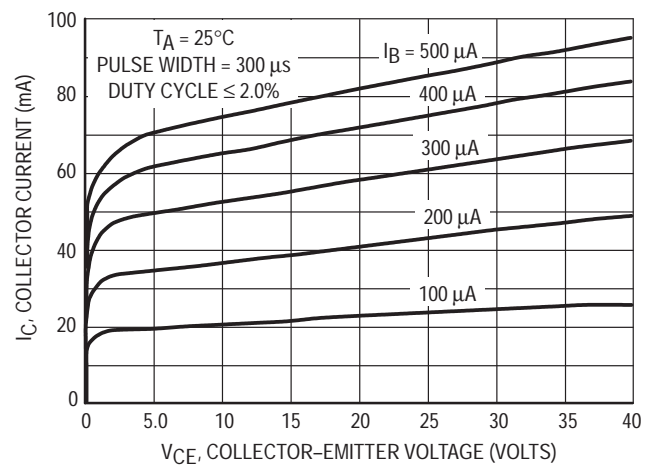


Figure 10. Collector Characteristics

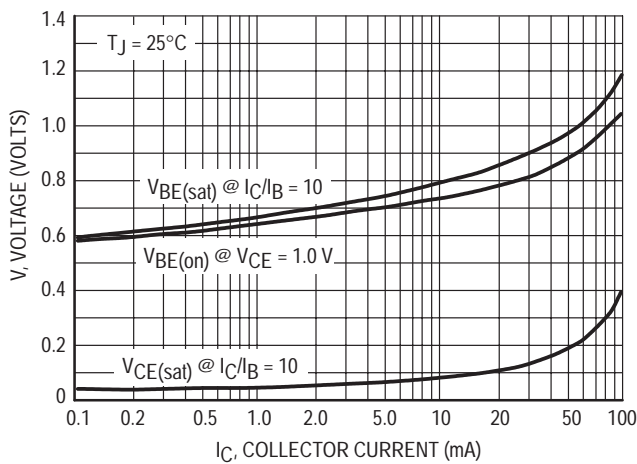


Figure 11. "On" Voltages

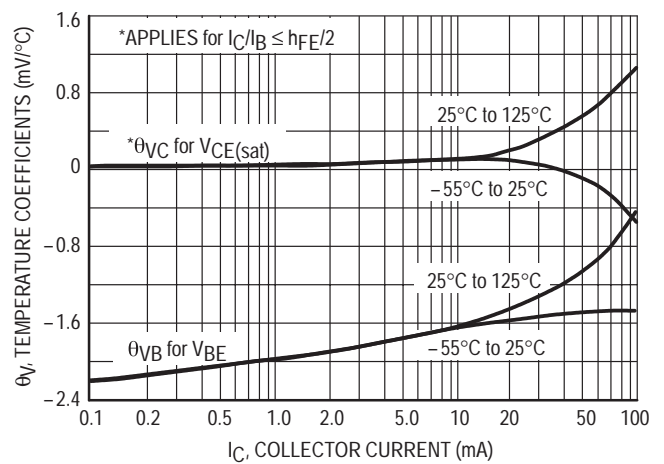


Figure 12. Temperature Coefficients

TYPICAL DYNAMIC CHARACTERISTICS

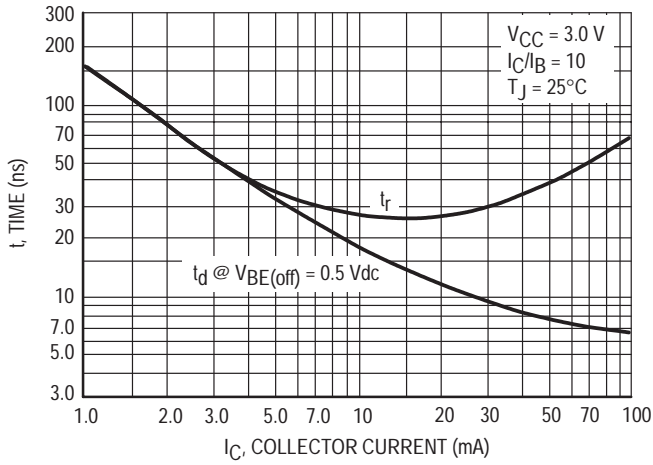


Figure 13. Turn-On Time

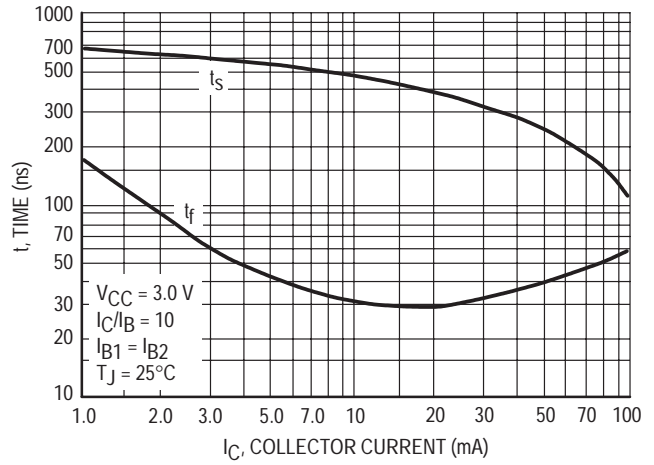


Figure 14. Turn-Off Time

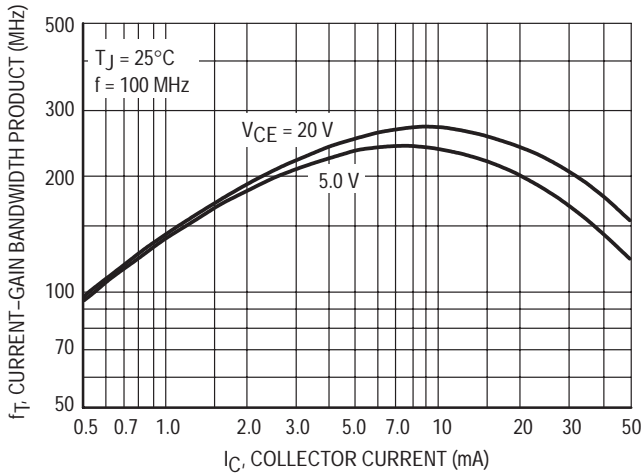


Figure 15. Current-Gain — Bandwidth Product

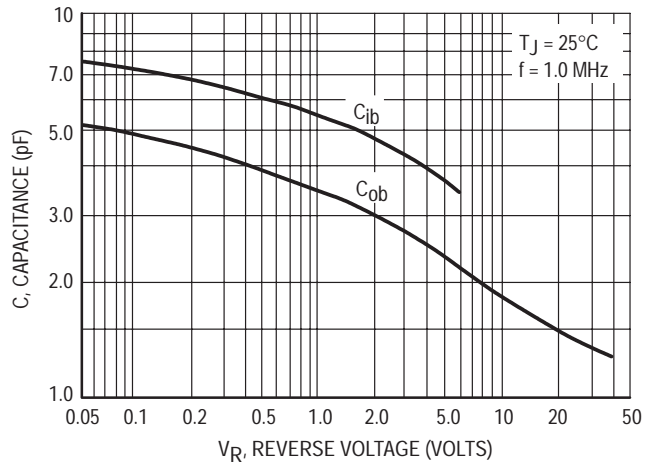


Figure 16. Capacitance

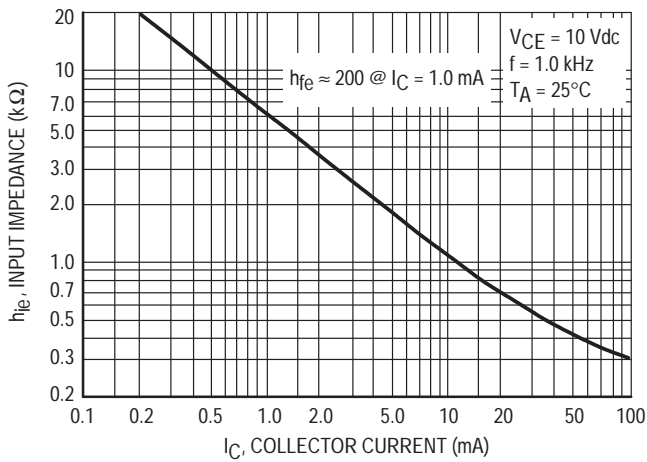


Figure 17. Input Impedance

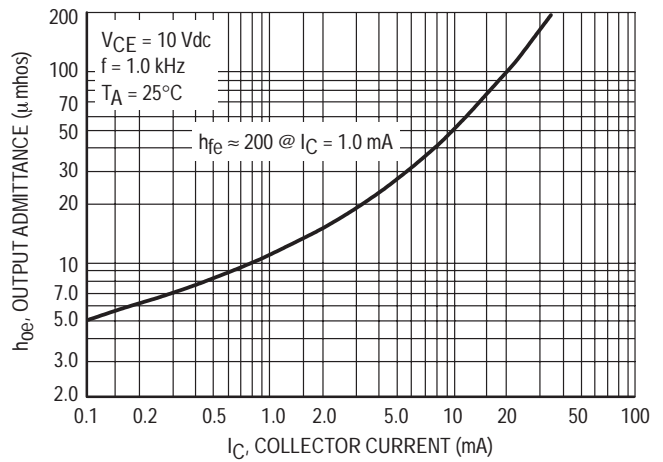


Figure 18. Output Admittance

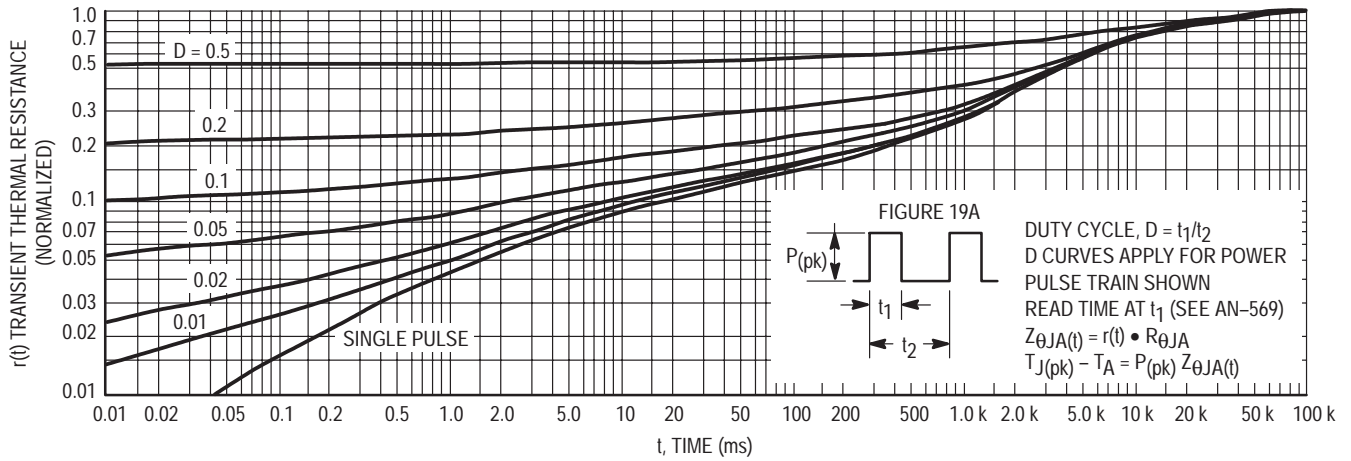


Figure 19. Thermal Response

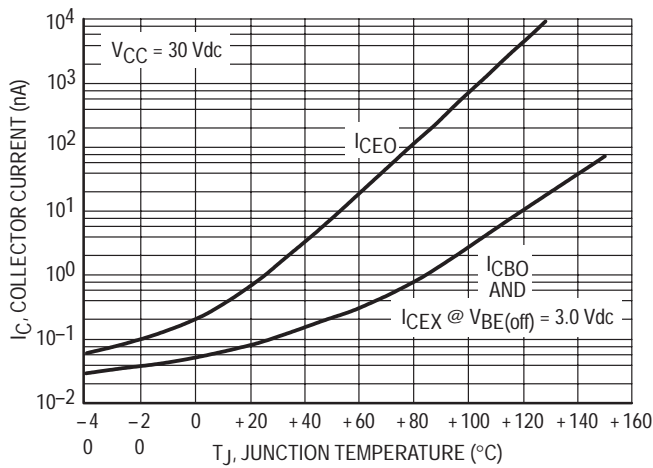


Figure 19A.

DESIGN NOTE: USE OF THERMAL RESPONSE DATA

A train of periodical power pulses can be represented by the model as shown in Figure 19A. Using the model and the device thermal response the normalized effective transient thermal resistance of Figure 19 was calculated for various duty cycles.

To find $Z_{\theta JA}(t)$, multiply the value obtained from Figure 19 by the steady state value $R_{\theta JA}$.

Example:

The MPS3904 is dissipating 2.0 watts peak under the following conditions:

$t_1 = 1.0$ ms, $t_2 = 5.0$ ms. ($D = 0.2$)

Using Figure 19 at a pulse width of 1.0 ms and $D = 0.2$, the reading of $r(t)$ is 0.22.

The peak rise in junction temperature is therefore

$\Delta T = r(t) \times P_{(pk)} \times R_{\theta JA} = 0.22 \times 2.0 \times 200 = 88^\circ\text{C}$.

For more information, see AN-569.

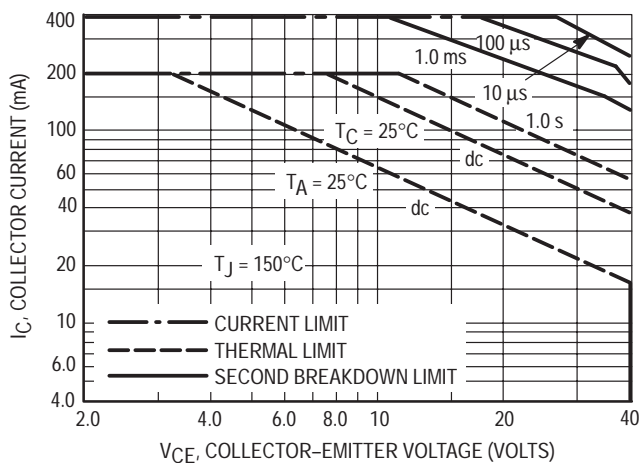
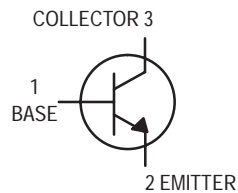
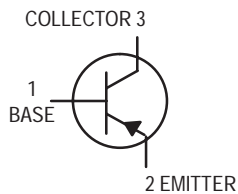


Figure 20.

The safe operating area curves indicate I_C - V_{CE} limits of the transistor that must be observed for reliable operation. Collector load lines for specific circuits must fall below the limits indicated by the applicable curve.

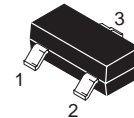
The data of Figure 20 is based upon $T_{J(pk)} = 150^\circ\text{C}$; T_C or T_A is variable depending upon conditions. Pulse curves are valid for duty cycles to 10% provided $T_{J(pk)} \leq 150^\circ\text{C}$. $T_{J(pk)}$ may be calculated from the data in Figure 19. At high case or ambient temperatures, thermal limitations will reduce the power that can be handled to values less than the limitations imposed by second breakdown.

General Purpose Transistors



PNP
BCX17LT1
BCX18LT1
NPN
BCX19LT1
BCX20LT1

Voltage and current are negative for PNP transistors



CASE 318-08, STYLE 6
SOT-23 (TO-236AB)

MAXIMUM RATINGS

Rating	Symbol	Value		Unit
		BCX17LT1 BCX19LT1	BCX18LT1 BCX20LT1	
Collector-Emitter Voltage	V_{CEO}	45	25	Vdc
Collector-Base Voltage	V_{CBO}	50	30	Vdc
Emitter-Base Voltage	V_{EBO}	5.0		Vdc
Collector Current — Continuous	I_C	500		mAdc

DEVICE MARKING

BCX17LT1 = T1; BCX18LT1 = T2; BCX19LT1 = U1; BCX20LT1 = U2

THERMAL CHARACTERISTICS

Characteristic	Symbol	Max	Unit
Total Device Dissipation FR-5 Board (1) $T_A = 25^\circ\text{C}$ Derate above 25°C	P_D	225	mW
Thermal Resistance, Junction to Ambient	$R_{\theta JA}$	1.8	$\text{mW}/^\circ\text{C}$
Total Device Dissipation Alumina Substrate, (2) $T_A = 25^\circ\text{C}$ Derate above 25°C	P_D	300	mW
Thermal Resistance, Junction to Ambient	$R_{\theta JA}$	2.4	$\text{mW}/^\circ\text{C}$
Junction and Storage Temperature	T_J, T_{stg}	-55 to +150	$^\circ\text{C}$

1. FR-5 = 1.0 x 0.75 x 0.062 in.

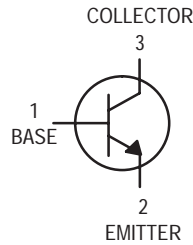
2. Alumina = 0.4 x 0.3 x 0.024 in. 99.5% alumina

ELECTRICAL CHARACTERISTICS ($T_A = 25^\circ\text{C}$ unless otherwise noted)

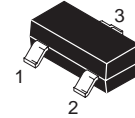
Characteristic	Symbol	Min	Typ	Max	Unit	
OFF CHARACTERISTICS						
Collector–Emitter Breakdown Voltage ($I_C = 10\text{ mA}$, $I_B = 0$)	BCX17, 19 BCX18, 20	$V_{(BR)CEO}$	45 25	— —	— —	Vdc
Collector–Emitter Breakdown Voltage ($I_C = 10\ \mu\text{A}$, $I_C = 0$)	BCX17, 19 BCX18, 20	$V_{(BR)CES}$	50 30	— —	— —	Vdc
Collector Cutoff Current ($V_{CB} = 20\text{ Vdc}$, $I_E = 0$) ($V_{CB} = 20\text{ Vdc}$, $I_E = 0$, $T_A = 150^\circ\text{C}$)		I_{CBO}	— —	— —	100 5.0	nAdc μAdc
Emitter Cutoff Current ($V_{EB} = 5.0\text{ Vdc}$, $I_C = 0$)		I_{EBO}	—	—	10	μAdc
ON CHARACTERISTICS						
DC Current Gain ($I_C = 100\text{ mA}$, $V_{CE} = 1.0\text{ Vdc}$) ($I_C = 300\text{ mA}$, $V_{CE} = 1.0\text{ Vdc}$) ($I_C = 500\text{ mA}$, $V_{CE} = 1.0\text{ Vdc}$)		h_{FE}	100 70 40	— — —	600 — —	—
Collector–Emitter Saturation Voltage ($I_C = 500\text{ mA}$, $I_B = 50\text{ mA}$)		$V_{CE(sat)}$	—	—	0.62	Vdc
Base–Emitter On Voltage ($I_C = 500\text{ mA}$, $V_{CE} = 1.0\text{ Vdc}$)		$V_{BE(on)}$	—	—	1.2	Vdc

General Purpose Transistors

NPN Silicon



BCX70GLT1
BCX70JLT1
BCX70KLT1



CASE 318-08, STYLE 6
SOT-23 (TO-236AB)

MAXIMUM RATINGS

Rating	Symbol	Value	Unit
Collector-Emitter Voltage	V_{CEO}	45	Vdc
Collector-Base Voltage	V_{CBO}	45	Vdc
Emitter-Base Voltage	V_{EBO}	5.0	Vdc
Collector Current — Continuous	I_C	200	mAdc

THERMAL CHARACTERISTICS

Characteristic	Symbol	Max	Unit
Total Device Dissipation FR-5 Board ⁽¹⁾ $T_A = 25^\circ\text{C}$ Derate above 25°C	P_D	225	mW
		1.8	mW/ $^\circ\text{C}$
Thermal Resistance, Junction to Ambient	$R_{\theta JA}$	556	$^\circ\text{C}/\text{W}$
Total Device Dissipation Alumina Substrate, ⁽²⁾ $T_A = 25^\circ\text{C}$ Derate above 25°C	P_D	300	mW
		2.4	mW/ $^\circ\text{C}$
Thermal Resistance, Junction to Ambient	$R_{\theta JA}$	417	$^\circ\text{C}/\text{W}$
Junction and Storage Temperature	T_J, T_{stg}	-55 to +150	$^\circ\text{C}$

DEVICE MARKING

BCX70GLT1 = AG; BCX70JLT1 = AJ; BCX70KLT1 = AK

ELECTRICAL CHARACTERISTICS ($T_A = 25^\circ\text{C}$ unless otherwise noted)

Characteristic	Symbol	Min	Max	Unit
----------------	--------	-----	-----	------

OFF CHARACTERISTICS

Collector-Emitter Breakdown Voltage ($I_C = 2.0 \text{ mAdc}, I_E = 0$)	$V_{(BR)CEO}$	45	—	Vdc
Emitter-Base Breakdown Voltage ($I_E = 1.0 \text{ }\mu\text{Adc}, I_C = 0$)	$V_{(BR)EBO}$	5.0	—	Vdc
Collector Cutoff Current ($V_{CE} = 32 \text{ Vdc}$) ($V_{CE} = 32 \text{ Vdc}, T_A = 150^\circ\text{C}$)	I_{CES}	—	20	nAdc μAdc
Emitter Cutoff Current ($V_{EB} = 4.0 \text{ Vdc}, I_C = 0$)	I_{EBO}	—	20	nAdc

1. FR-5 = $1.0 \times 0.75 \times 0.062 \text{ in.}$

2. Alumina = $0.4 \times 0.3 \times 0.024 \text{ in. } 99.5\% \text{ alumina.}$

ELECTRICAL CHARACTERISTICS ($T_A = 25^\circ\text{C}$ unless otherwise noted) (Continued)

Characteristic	Symbol	Min	Max	Unit
ON CHARACTERISTICS				
DC Current Gain ($I_C = 10 \mu\text{A}$, $V_{CE} = 5.0 \text{ Vdc}$) ($I_C = 2.0 \text{ mA}$, $V_{CE} = 5.0 \text{ Vdc}$) ($I_C = 50 \text{ mA}$, $V_{CE} = 1.0 \text{ Vdc}$)	BCX70G	—	—	—
	BCX70J	40	—	—
	BCX70K	100	—	—
	BCX70G	120	220	—
	BCX70J	250	460	—
	BCX70K	380	630	—
	BCX70G	60	—	—
	BCX70J	90	—	—
	BCX70K	100	—	—
Collector–Emitter Saturation Voltage ($I_C = 50 \text{ mA}$, $I_B = 1.25 \text{ mA}$) ($I_C = 10 \text{ mA}$, $I_B = 0.25 \text{ mA}$)	$V_{CE(sat)}$	—	0.55 0.35	Vdc
Base–Emitter Saturation Voltage ($I_C = 50 \text{ mA}$, $I_B = 1.25 \text{ mA}$) ($I_C = 50 \text{ mA}$, $I_B = 0.25 \text{ mA}$)	$V_{BE(sat)}$	0.7 0.6	1.05 0.85	Vdc
Base–Emitter On Voltage ($I_C = 2.0 \text{ mA}$, $V_{CE} = 5.0 \text{ Vdc}$)	$V_{BE(on)}$	0.55	0.75	Vdc

SMALL–SIGNAL CHARACTERISTICS

Current–Gain — Bandwidth Product ($I_C = 10 \text{ mA}$, $V_{CE} = 5.0 \text{ Vdc}$, $f = 100 \text{ MHz}$)	f_T	125	—	MHz
Output Capacitance ($V_{CB} = 10 \text{ Vdc}$, $I_C = 0$, $f = 1.0 \text{ MHz}$)	C_{obo}	—	4.5	pF
Small–Signal Current Gain ($I_C = 2.0 \text{ mA}$, $V_{CE} = 5.0 \text{ Vdc}$, $f = 1.0 \text{ kHz}$)	h_{fe}	BCX70G	125	250
		BCX70J	250	500
		BCX70K	350	700
Noise Figure ($I_C = 0.2 \text{ mA}$, $V_{CE} = 5.0 \text{ Vdc}$, $R_S = 2.0 \text{ k}\Omega$, $f = 1.0 \text{ kHz}$, $BW = 200 \text{ Hz}$)	NF	—	6.0	dB

SWITCHING CHARACTERISTICS

Turn–On Time ($I_C = 10 \text{ mA}$, $I_{B1} = 1.0 \text{ mA}$)	t_{on}	—	150	ns
Turn–Off Time ($I_{B2} = 1.0 \text{ mA}$, $V_{BB} = 3.6 \text{ Vdc}$, $R_1 = R_2 = 5.0 \text{ k}\Omega$, $R_L = 990\Omega$)	t_{off}	—	800	ns

EQUIVALENT SWITCHING TIME TEST CIRCUITS

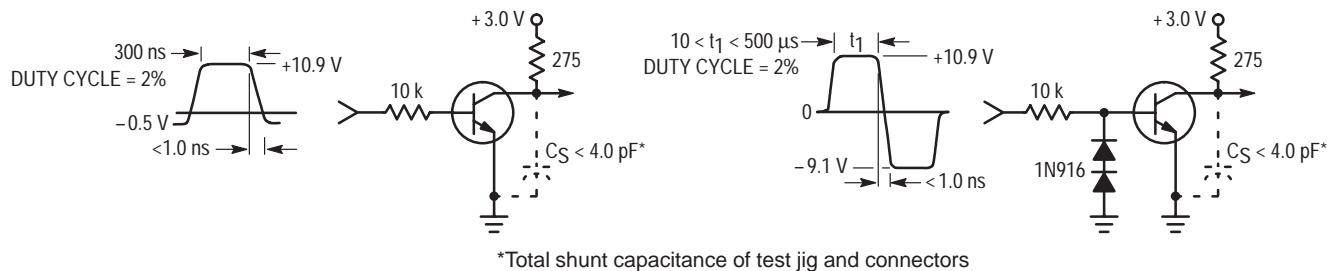


Figure 1. Turn–On Time

Figure 2. Turn–Off Time

TYPICAL NOISE CHARACTERISTICS

($V_{CE} = 5.0 \text{ Vdc}$, $T_A = 25^\circ\text{C}$)

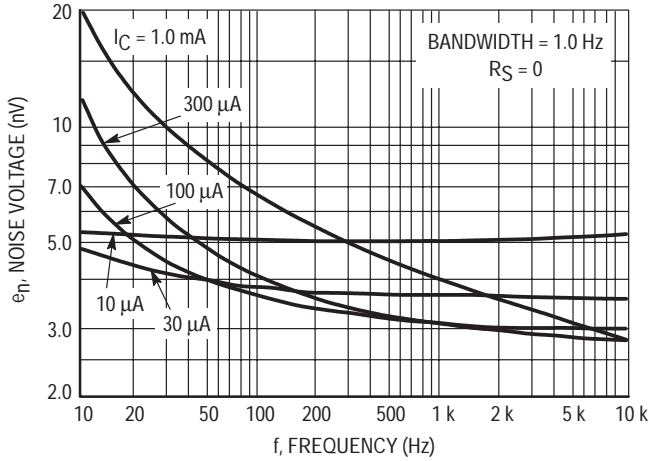


Figure 3. Noise Voltage

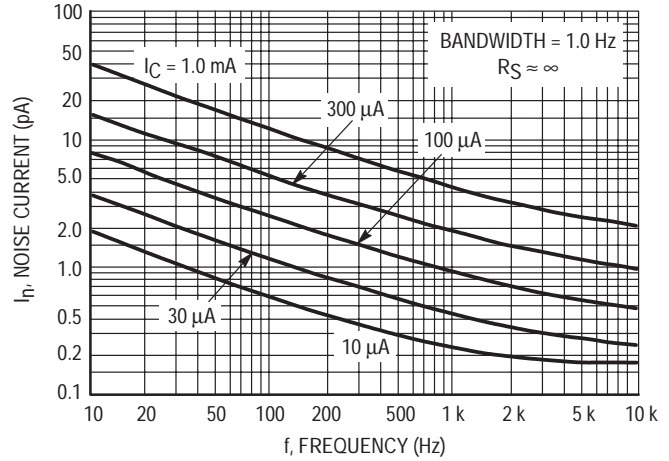


Figure 4. Noise Current

NOISE FIGURE CONTOURS

($V_{CE} = 5.0 \text{ Vdc}$, $T_A = 25^\circ\text{C}$)

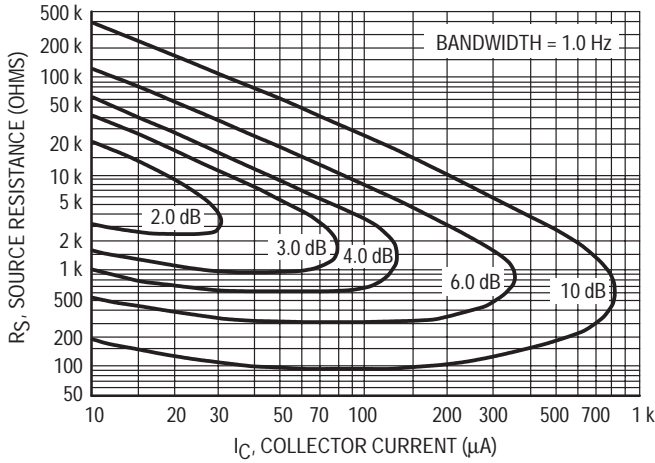


Figure 5. Narrow Band, 100 Hz

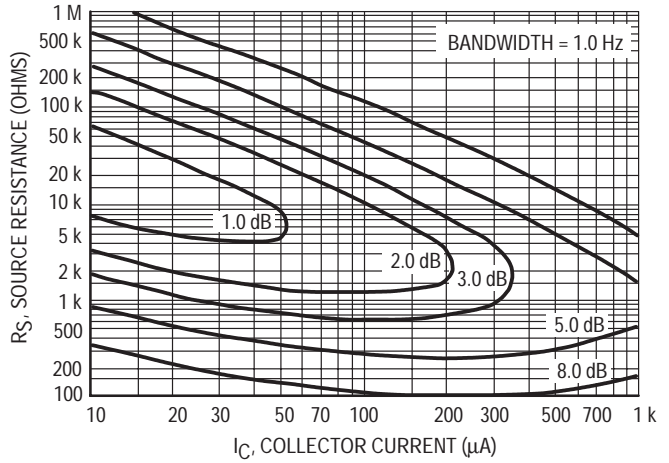


Figure 6. Narrow Band, 1.0 kHz

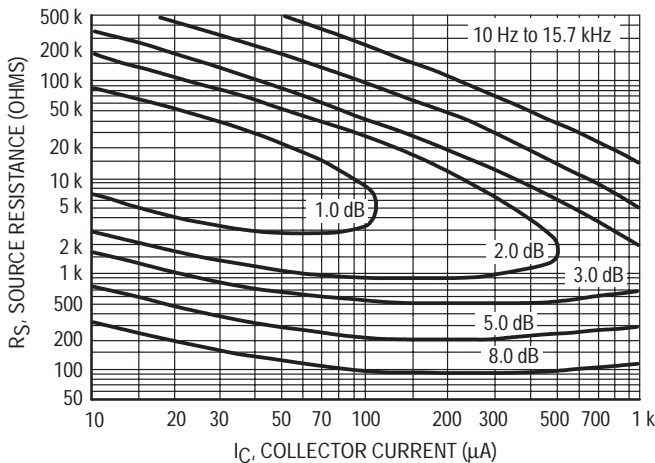


Figure 7. Wideband

Noise Figure is defined as:

$$NF = 20 \log_{10} \left(\frac{e_n^2 + 4KTR_S + I_n^2 R_S^2}{4KTR_S} \right)^{1/2}$$

e_n = Noise Voltage of the Transistor referred to the input. (Figure 3)

I_n = Noise Current of the Transistor referred to the input. (Figure 4)

K = Boltzman's Constant ($1.38 \times 10^{-23} \text{ J}/^\circ\text{K}$)

T = Temperature of the Source Resistance ($^\circ\text{K}$)

R_S = Source Resistance (Ohms)

TYPICAL STATIC CHARACTERISTICS

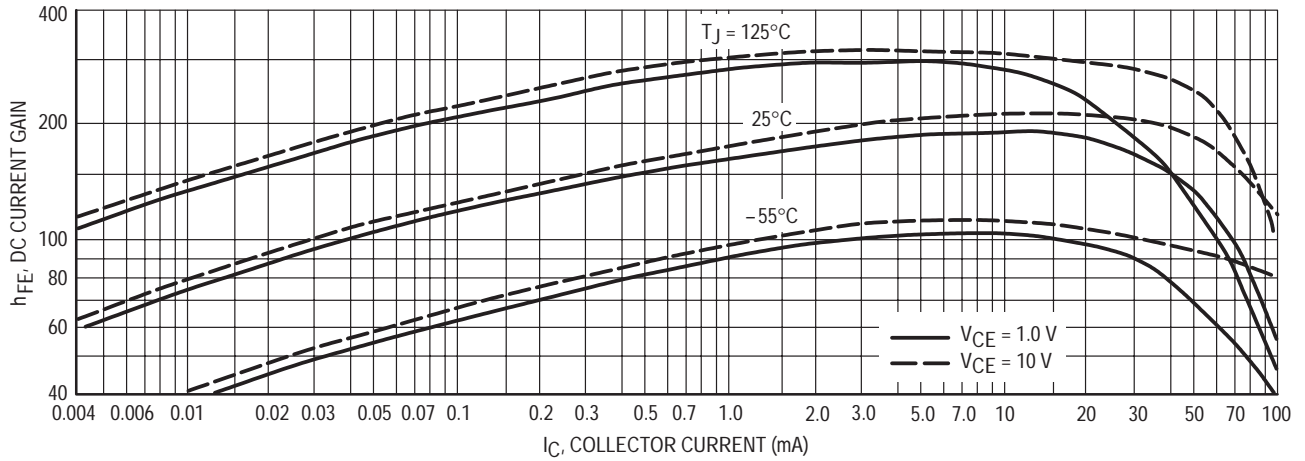


Figure 8. DC Current Gain

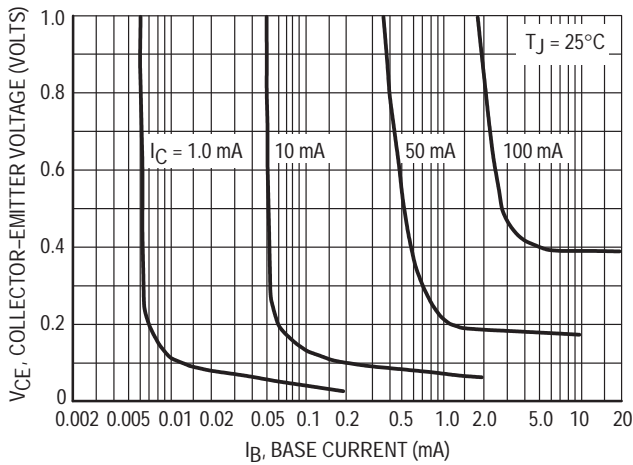


Figure 9. Collector Saturation Region

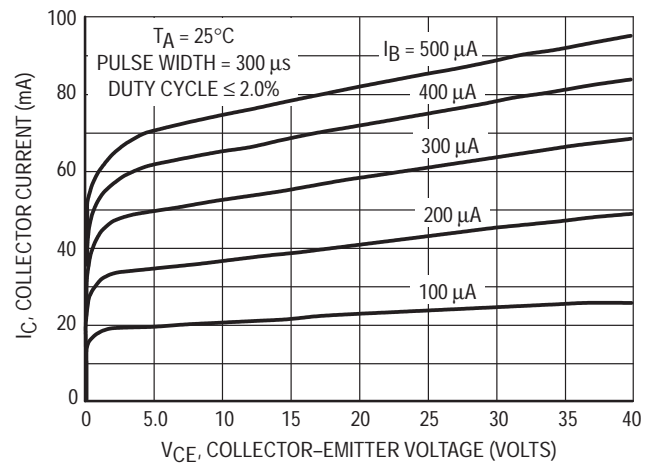


Figure 10. Collector Characteristics

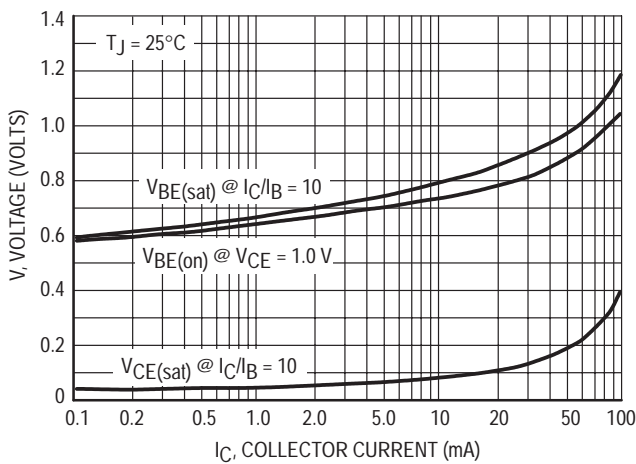


Figure 11. "On" Voltages

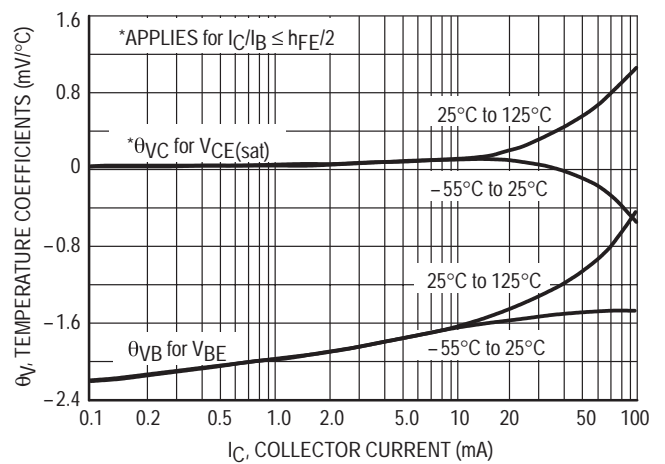


Figure 12. Temperature Coefficients

TYPICAL DYNAMIC CHARACTERISTICS

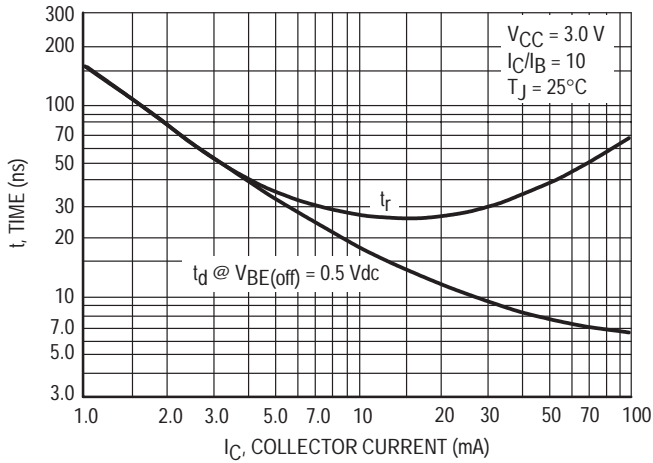


Figure 13. Turn-On Time

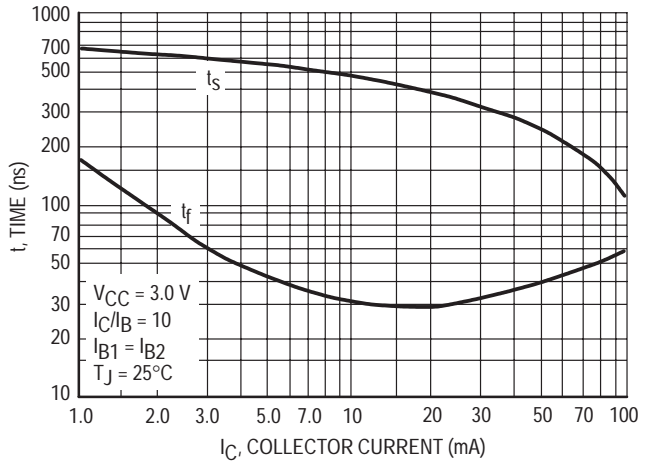


Figure 14. Turn-Off Time

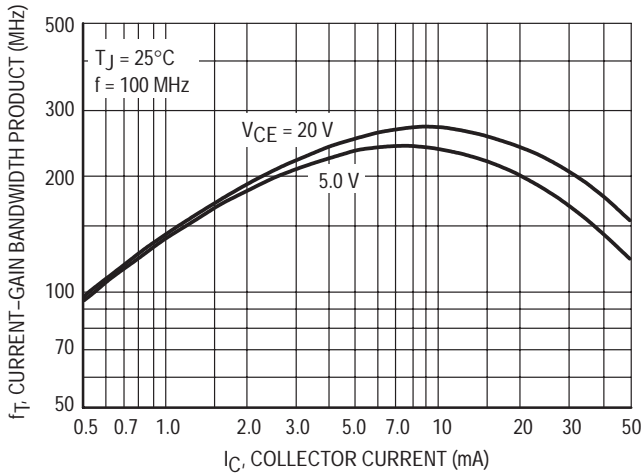


Figure 15. Current-Gain — Bandwidth Product

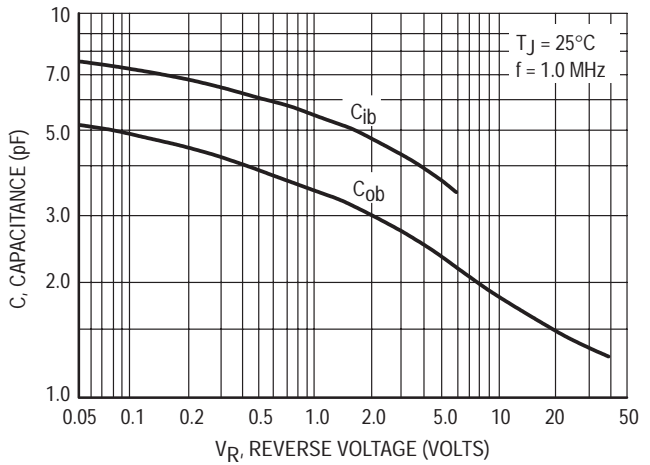


Figure 16. Capacitance

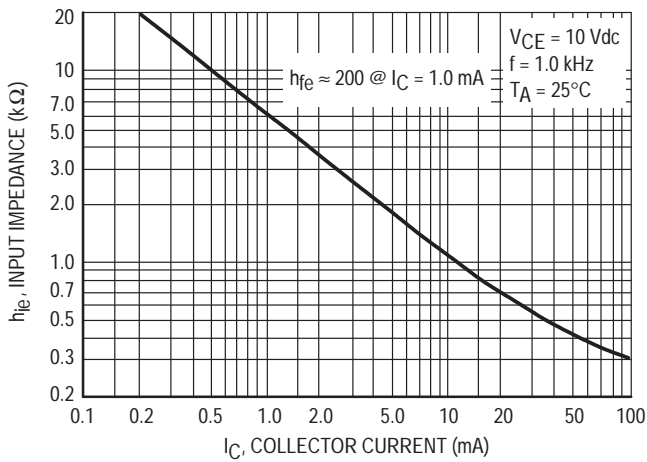


Figure 17. Input Impedance

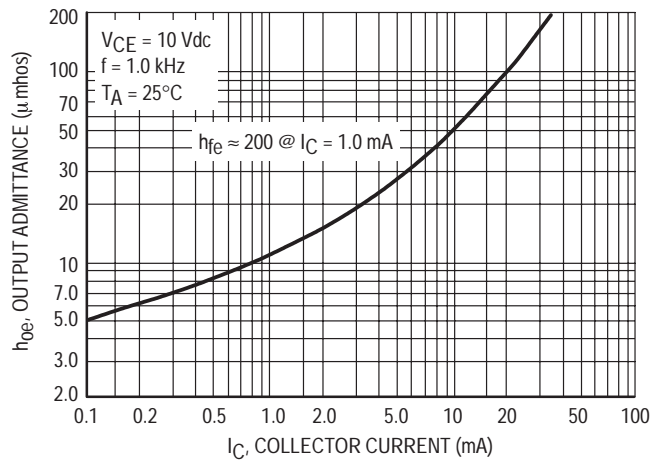


Figure 18. Output Admittance

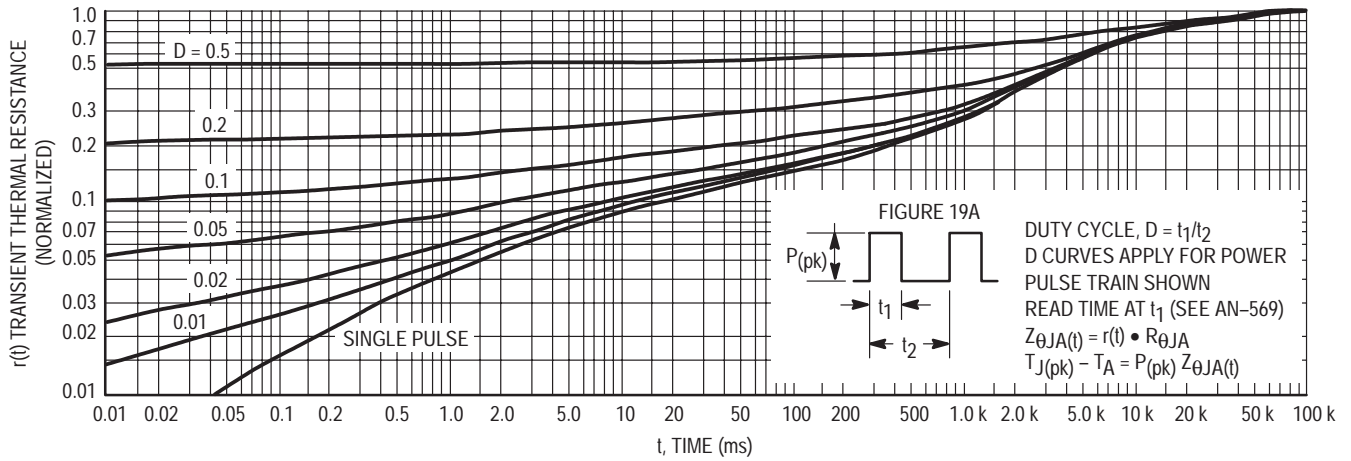


Figure 19. Thermal Response

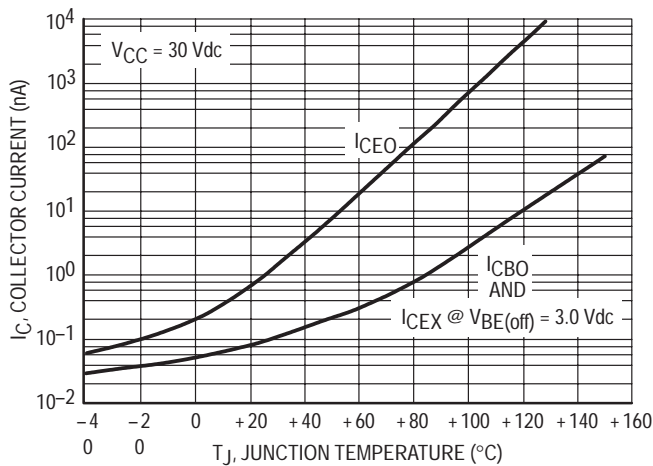


Figure 19A.

DESIGN NOTE: USE OF THERMAL RESPONSE DATA

A train of periodical power pulses can be represented by the model as shown in Figure 19A. Using the model and the device thermal response the normalized effective transient thermal resistance of Figure 19 was calculated for various duty cycles.

To find $Z_{\theta JA}(t)$, multiply the value obtained from Figure 19 by the steady state value $R_{\theta JA}$.

Example:

The MPS3904 is dissipating 2.0 watts peak under the following conditions:

$t_1 = 1.0 \text{ ms}, t_2 = 5.0 \text{ ms. (D = 0.2)}$

Using Figure 19 at a pulse width of 1.0 ms and D = 0.2, the reading of $r(t)$ is 0.22.

The peak rise in junction temperature is therefore

$\Delta T = r(t) \times P(pk) \times R_{\theta JA} = 0.22 \times 2.0 \times 200 = 88^\circ\text{C}.$

For more information, see AN-569.

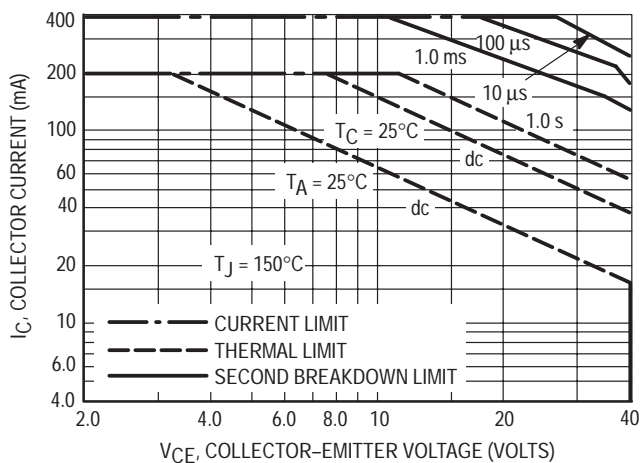


Figure 20.

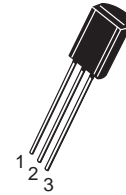
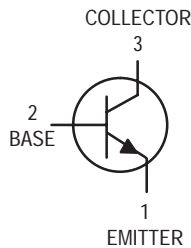
The safe operating area curves indicate I_C - V_{CE} limits of the transistor that must be observed for reliable operation. Collector load lines for specific circuits must fall below the limits indicated by the applicable curve.

The data of Figure 20 is based upon $T_{J(pk)} = 150^\circ\text{C}$; T_C or T_A is variable depending upon conditions. Pulse curves are valid for duty cycles to 10% provided $T_{J(pk)} \leq 150^\circ\text{C}$. $T_{J(pk)}$ may be calculated from the data in Figure 19. At high case or ambient temperatures, thermal limitations will reduce the power that can be handled to values less than the limitations imposed by second breakdown.

One Watt Amplifier Transistor

NPN Silicon

BDB01C



CASE 29-05, STYLE 1
TO-92 (TO-226AE)

MAXIMUM RATINGS

Rating	Symbol	Value	Unit
Collector–Emitter Voltage	V_{CEO}	80	Vdc
Collector–Base Voltage	V_{CES}	80	Vdc
Emitter–Base Voltage	V_{EBO}	5.0	Vdc
Collector Current — Continuous	I_C	0.5	Adc
Total Device Dissipation @ $T_A = 25^\circ\text{C}$ Derate above 25°C	P_D	1.0 8.0	Watt mW/ $^\circ\text{C}$
Total Device Dissipation @ $T_C = 25^\circ\text{C}$ Derate above 25°C	P_D	2.5 20	Watt mW/ $^\circ\text{C}$
Operating and Storage Junction Temperature Range	T_J, T_{stg}	-55 to +150	$^\circ\text{C}$

THERMAL CHARACTERISTICS

Characteristic	Symbol	Max	Unit
Thermal Resistance, Junction to Ambient	$R_{\theta JA}$	125	$^\circ\text{C}/\text{W}$
Thermal Resistance, Junction to Case	$R_{\theta JC}$	50	$^\circ\text{C}/\text{W}$

ELECTRICAL CHARACTERISTICS ($T_A = 25^\circ\text{C}$ unless otherwise noted)

Characteristic	Symbol	Min	Max	Unit
----------------	--------	-----	-----	------

OFF CHARACTERISTICS

Collector–Emitter Voltage ($I_C = 10\text{ mA}, I_B = 0$)	$V_{(BR)CEO}$	80	—	Vdc
Collector Cutoff Current ($V_{CB} = 80\text{ V}, I_E = 0$)	I_{CBO}	—	0.01	μAdc
Emitter Cutoff Current ($I_C = 0, V_{EB} = 5.0\text{ V}$)	I_{EBO}	—	100	nAdc

ELECTRICAL CHARACTERISTICS ($T_A = 25^\circ\text{C}$ unless otherwise noted) (Continued)

Characteristic	Symbol	Min	Max	Unit
ON CHARACTERISTICS				
DC Current Gain ($I_C = 100\text{ mA}$, $V_{CE} = 1.0\text{ V}$) ($I_C = 500\text{ mA}$, $V_{CE} = 2.0\text{ V}$)	h_{FE}	40 25	400 —	—
Collector–Emitter Saturation Voltage ⁽¹⁾ ($I_C = 1000\text{ mA}$, $I_B = 100\text{ mA}$)	$V_{CE(sat)}$	—	0.7	Vdc
Collector–Emitter On Voltage ⁽¹⁾ ($I_C = 1000\text{ mA}$, $V_{CE} = 1.0\text{ V}$)	$V_{BE(on)}$	—	1.2	Vdc

DYNAMIC CHARACTERISTICS

Current Gain Bandwidth Product ($I_C = 200\text{ mA}$, $V_{CE} = 5.0\text{ V}$, $f = 20\text{ MHz}$)	f_T	50	—	MHz
Output Capacitance ($V_{CB} = 10\text{ V}$, $I_E = 0$, $f = 1.0\text{ MHz}$)	C_{ob}	—	30	pF

1. Pulse Test: Pulse Width $\leq 300\ \mu\text{s}$, Duty Cycle 2.0%.

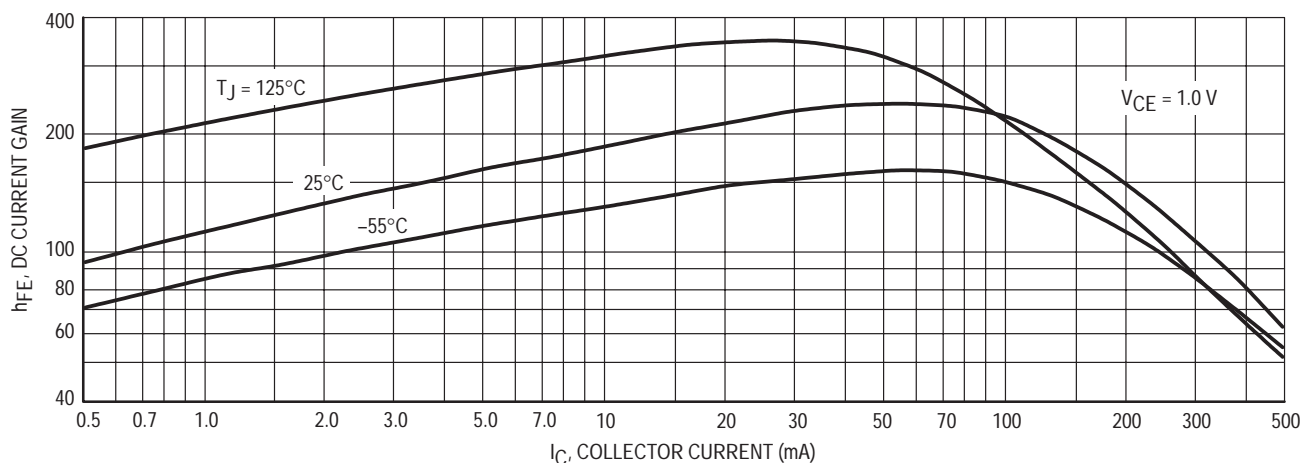


Figure 1. DC Current Gain

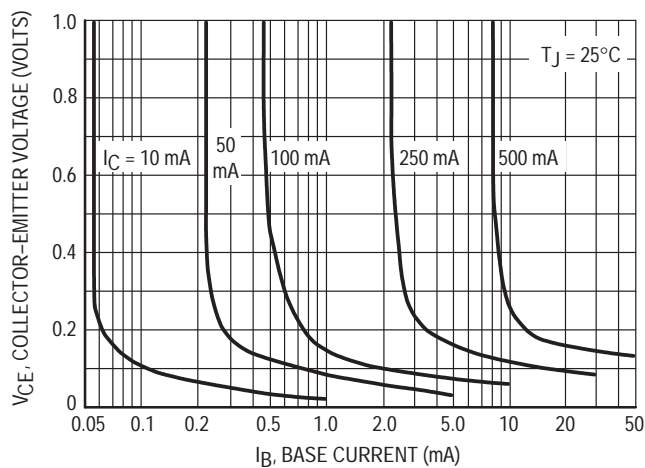


Figure 2. Collector Saturation Region

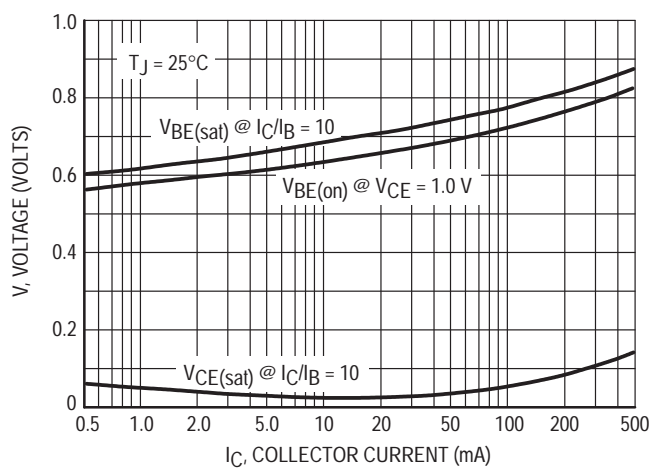


Figure 3. On Voltages

BDB01C

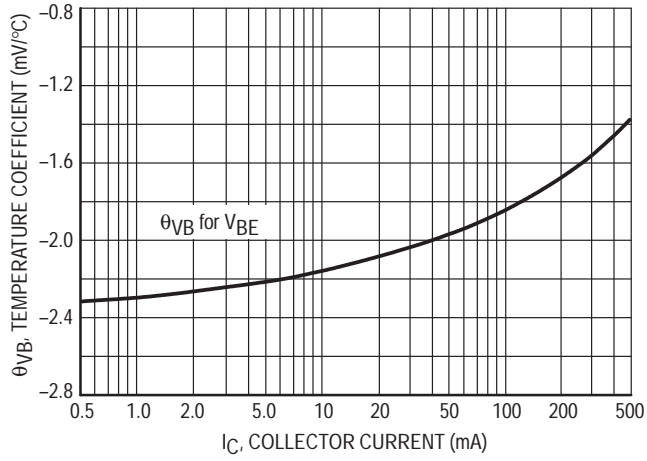


Figure 4. Base-Emitter Temperature Coefficient

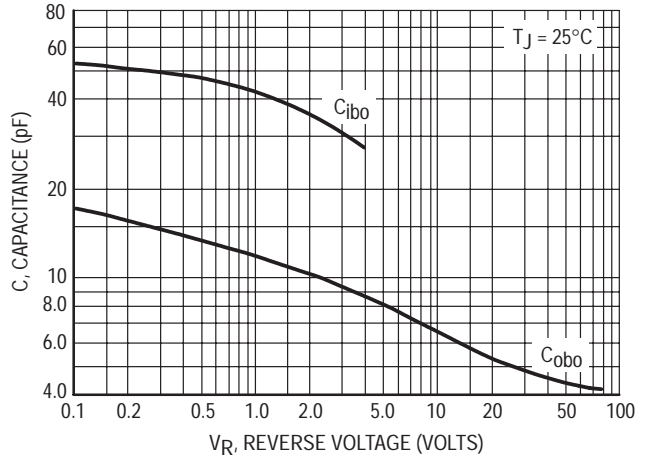


Figure 5. Capacitance

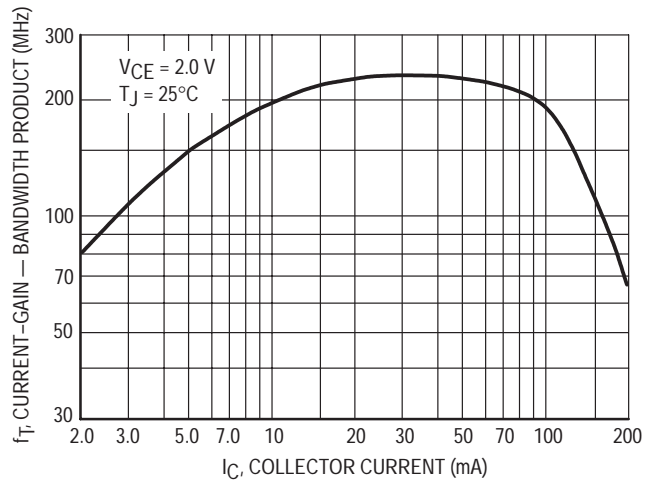


Figure 6. Current-Gain — Bandwidth Product

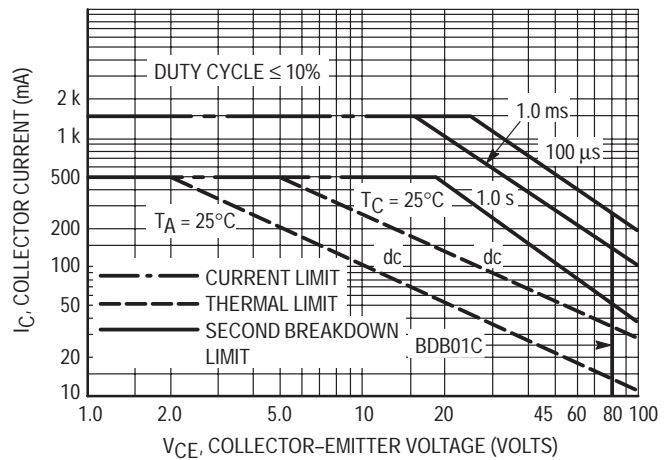
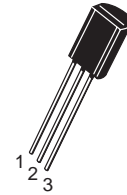
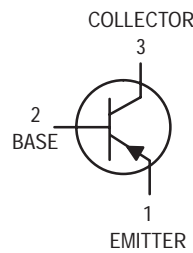


Figure 7. Active Region-Safe Operating Area

One Watt Amplifier Transistors

PNP Silicon

BDB02C



CASE 29-05, STYLE 1
TO-92 (TO-226AE)

MAXIMUM RATINGS

Rating	Symbol	Value	Unit
Collector–Emitter Voltage	V_{CEO}	–80	Vdc
Collector–Base Voltage	V_{CES}	–80	Vdc
Emitter–Base Voltage	V_{EBO}	–5.0	Vdc
Collector Current — Continuous	I_C	–0.5	Adc
Total Device Dissipation @ $T_A = 25^\circ\text{C}$ Derate above 25°C	P_D	1.0 8.0	Watt mW/ $^\circ\text{C}$
Total Device Dissipation @ $T_C = 25^\circ\text{C}$ Derate above 25°C	P_D	2.5 20	Watt mW/ $^\circ\text{C}$
Operating and Storage Junction Temperature Range	T_J, T_{stg}	–55 to +150	$^\circ\text{C}$

THERMAL CHARACTERISTICS

Characteristic	Symbol	Max	Unit
Thermal Resistance, Junction to Ambient	$R_{\theta JA}$	125	$^\circ\text{C}/\text{W}$
Thermal Resistance, Junction to Case	$R_{\theta JC}$	50	$^\circ\text{C}/\text{W}$

ELECTRICAL CHARACTERISTICS ($T_A = 25^\circ\text{C}$ unless otherwise noted)

Characteristic	Symbol	Min	Max	Unit
----------------	--------	-----	-----	------

OFF CHARACTERISTICS

Collector–Emitter Voltage ($I_C = -10\text{ mA}, I_B = 0$)	$V_{(BR)CEO}$	–80	—	Vdc
Collector Cutoff Current ($V_{CB} = -80\text{ V}, I_E = 0$)	I_{CBO}	—	–0.1	μAdc
Emitter Cutoff Current ($I_C = 0, V_{EB} = -5.0\text{ V}$)	I_{EBO}	—	–100	nAdc

ON CHARACTERISTICS

DC Current Gain ($I_C = -100\text{ mA}, V_{CE} = -1.0\text{ V}$) ($I_C = -500\text{ mA}, V_{CE} = -2.0\text{ V}$)	h_{FE}	40 25	400 —	—
Collector–Emitter Saturation Voltage ⁽¹⁾ ($I_C = -1000\text{ mA}, I_B = -100\text{ mA}$)	$V_{CE(sat)}$	—	–0.7	Vdc
Collector–Emitter On Voltage ⁽¹⁾ ($I_C = -1000\text{ mA}, V_{CE} = -1.0\text{ V}$)	$V_{BE(on)}$	—	–1.2	Vdc

DYNAMIC CHARACTERISTICS

Current–Gain — Bandwidth Product ($I_C = -200\text{ mA}, V_{CE} = -5.0\text{ V}, f = 20\text{ MHz}$)	f_T	50	—	MHz
Output Capacitance ($V_{CB} = -10\text{ V}, I_E = 0, f = 1.0\text{ MHz}$)	C_{ob}	—	30	pF

1. Pulse Test: Pulse Width $\leq 300\ \mu\text{s}$, Duty Cycle 2.0%.

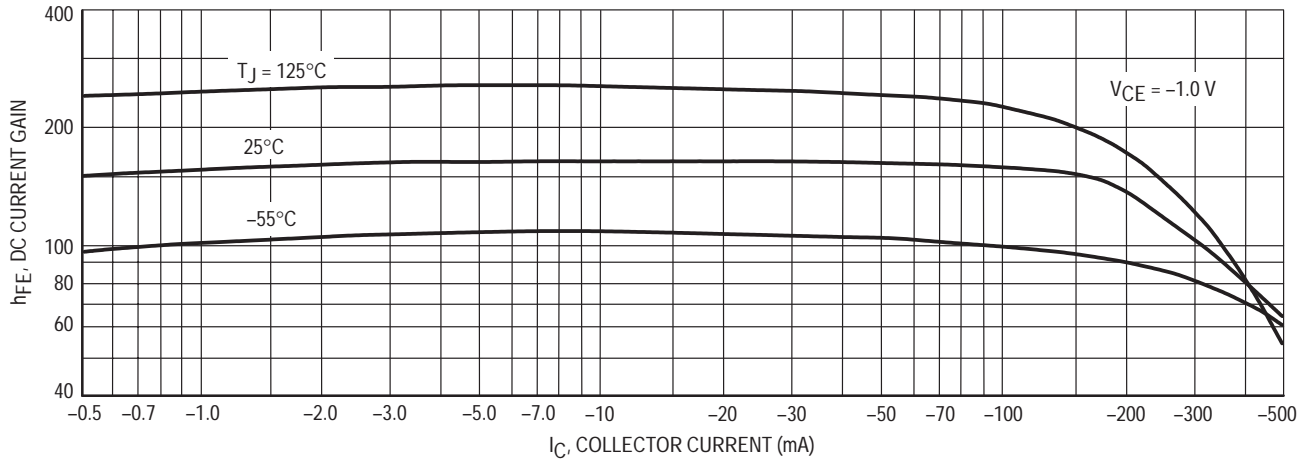


Figure 1. DC Current Gain

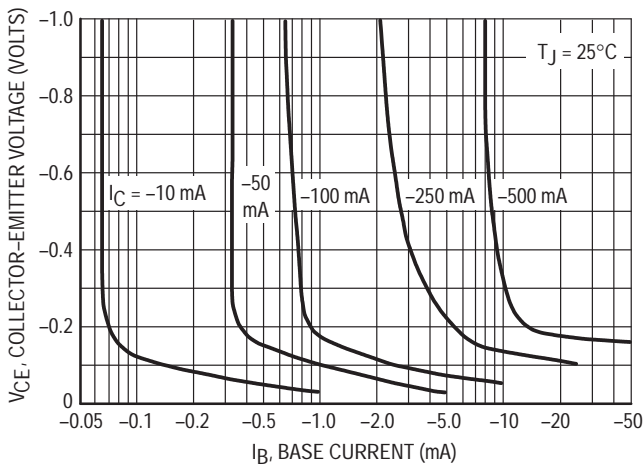


Figure 2. Collector Saturation Region

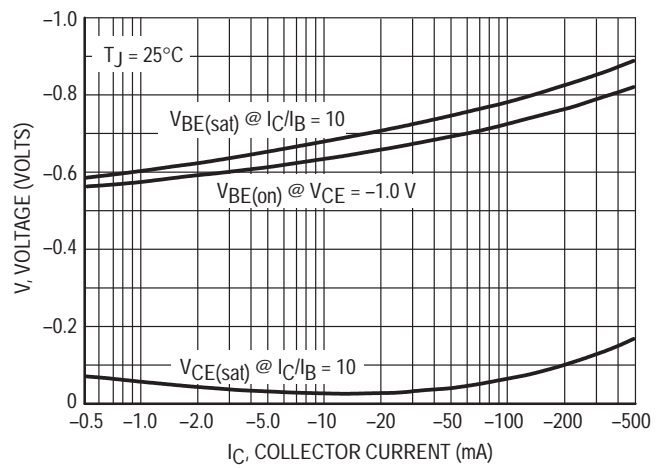


Figure 3. On Voltages

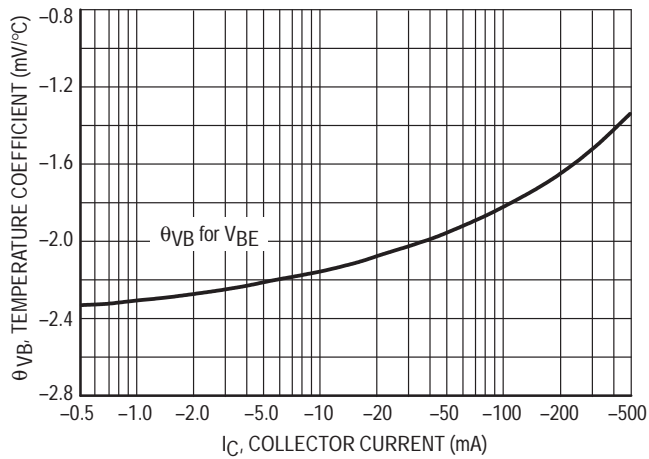


Figure 4. Base-Emitter Temperature Coefficient

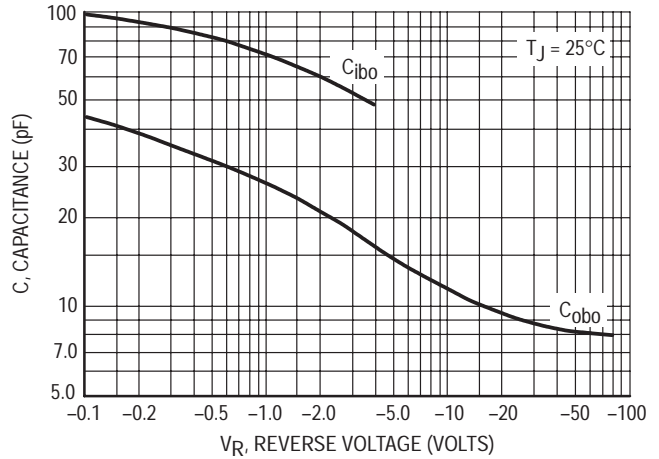


Figure 5. Capacitance

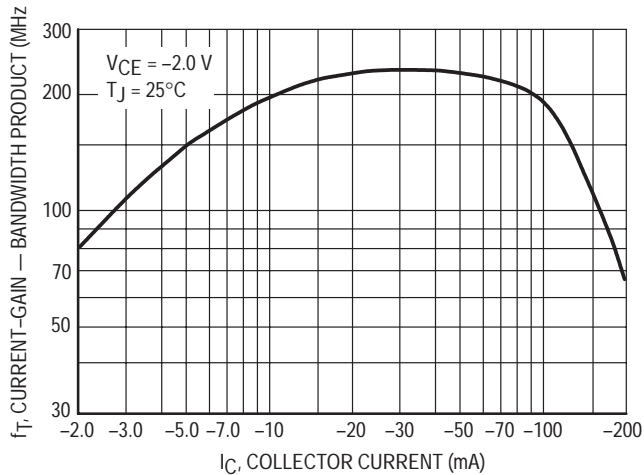


Figure 6. Current-Gain — Bandwidth Product

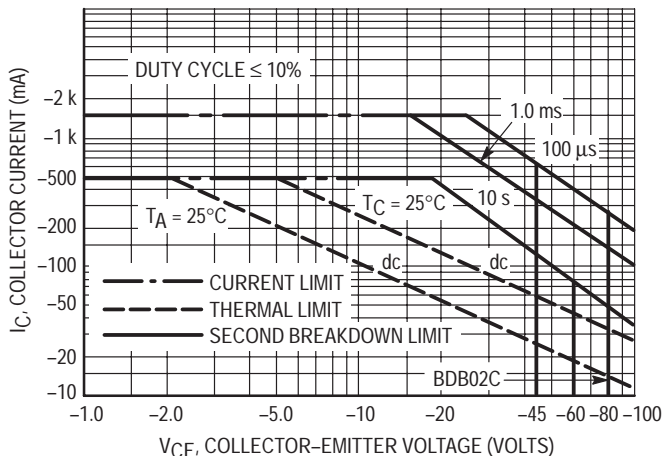
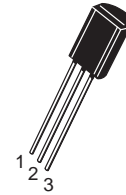
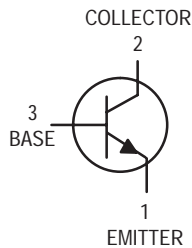


Figure 7. Active Region — Safe Operating Area

One Watt Amplifier Transistor

NPN Silicon

BDC01D



CASE 29-05, STYLE 14
TO-92 (TO-226AE)

MAXIMUM RATINGS

Rating	Symbol	BDC01D	Unit
Collector–Emitter Voltage	V_{CEO}	100	Vdc
Collector–Base Voltage	V_{CBO}	100	Vdc
Emitter–Base Voltage	V_{EBO}	5.0	Vdc
Collector Current — Continuous	I_C	0.5	Adc
Total Device Dissipation @ $T_A = 25^\circ\text{C}$ Derate above 25°C	P_D	1.0 8.0	Watts mW/ $^\circ\text{C}$
Total Device Dissipation @ $T_C = 25^\circ\text{C}$ Derate above 25°C	P_D	2.5 20	Watts mW/ $^\circ\text{C}$
Operating and Storage Junction Temperature Range	T_J, T_{stg}	-55 to +150	$^\circ\text{C}$

THERMAL CHARACTERISTICS

Characteristic	Symbol	Max	Unit
Thermal Resistance, Junction to Ambient	$R_{\theta JA}$	125	$^\circ\text{C}/\text{W}$
Thermal Resistance, Junction to Case	$R_{\theta JC}$	50	$^\circ\text{C}/\text{W}$

ELECTRICAL CHARACTERISTICS ($T_A = 25^\circ\text{C}$ unless otherwise noted)

Characteristic	Symbol	Min	Max	Unit
----------------	--------	-----	-----	------

OFF CHARACTERISTICS

Collector–Emitter Voltage ($I_C = 10\text{ mA}, I_B = 0$)	$V_{(BR)CEO}$	100	—	Vdc
Collector Cutoff Current ($V_{CB} = 100\text{ V}, I_E = 0$)	I_{CBO}	—	0.1	μAdc
Emitter Cutoff Current ($I_C = 0, V_{EB} = 5.0\text{ V}$)	I_{EBO}	—	100	nAdc

ELECTRICAL CHARACTERISTICS ($T_A = 25^\circ\text{C}$ unless otherwise noted) (Continued)

Characteristic	Symbol	Min	Max	Unit
ON CHARACTERISTICS				
DC Current Gain ($I_C = 100\text{ mA}$, $V_{CE} = 1.0\text{ V}$) ($I_C = 500\text{ mA}$, $V_{CE} = 2.0\text{ V}$)	h_{FE}	40 25	400 —	—
Collector–Emitter Saturation Voltage ⁽¹⁾ ($I_C = 1000\text{ mA}$, $I_B = 100\text{ mA}$)	$V_{CE(sat)}$	—	0.7	Vdc
Collector–Emitter On Voltage ⁽¹⁾ ($I_C = 1000\text{ mA}$, $V_{CE} = 1.0\text{ V}$)	$V_{BE(on)}$	—	1.2	Vdc

DYNAMIC CHARACTERISTICS

Current Gain Bandwidth Product ($I_C = 200\text{ mA}$, $V_{CE} = 5.0\text{ V}$, $f = 20\text{ MHz}$)	f_T	50	—	MHz
Output Capacitance ($V_{CB} = 10\text{ V}$, $I_E = 0$, $f = 1.0\text{ MHz}$)	C_{ob}	—	30	pF

1. Pulse Test: Pulse Width $\leq 300\ \mu\text{s}$; Duty Cycle 2.0%.

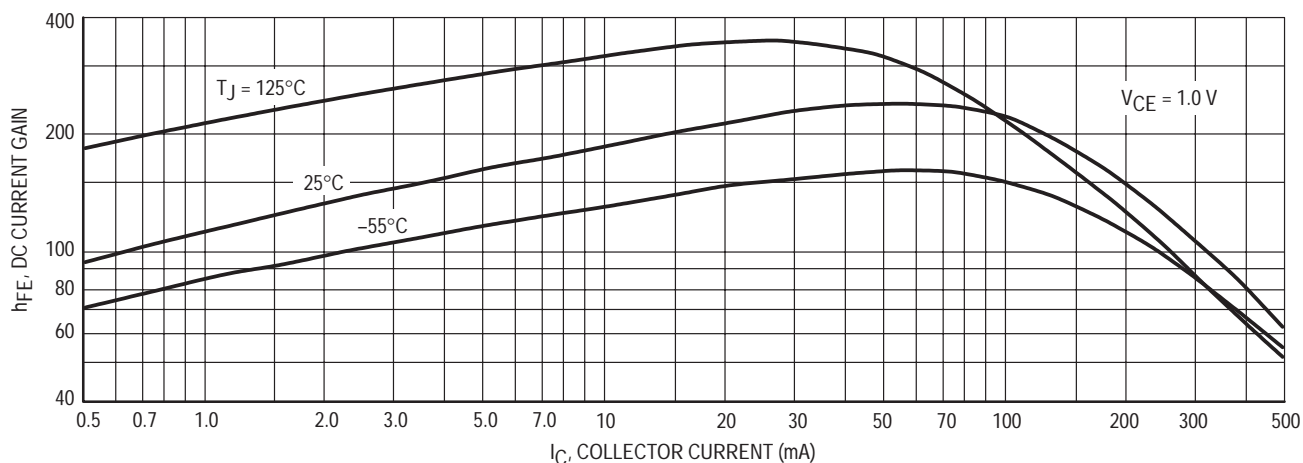


Figure 1. DC Current Gain

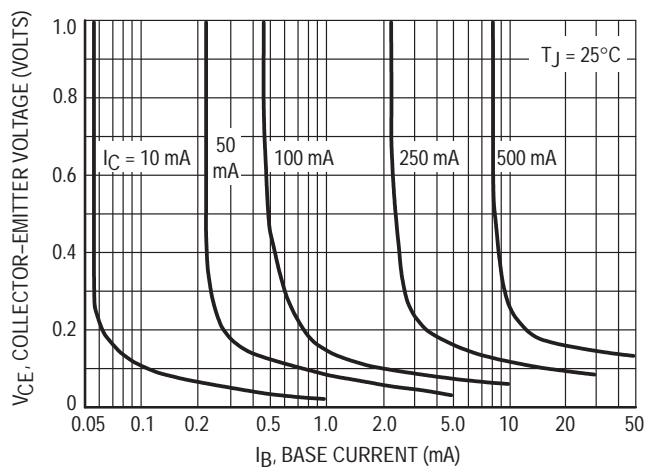


Figure 2. Collector Saturation Region

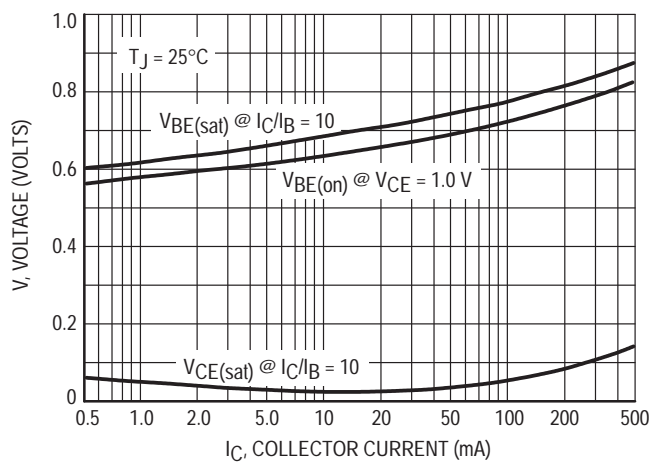


Figure 3. "On" Voltages

BDC01D

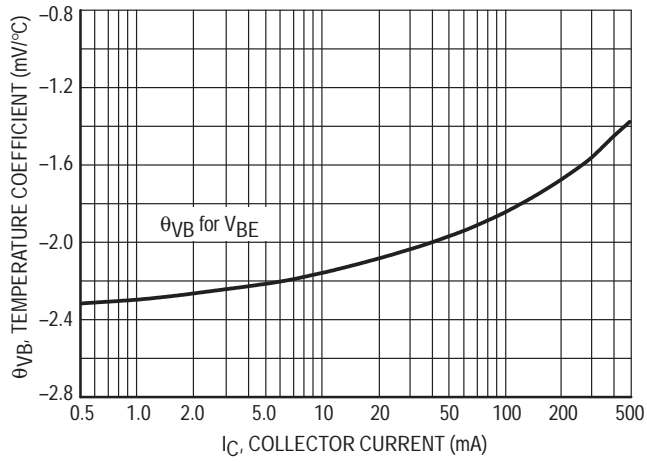


Figure 4. Base-Emitter Temperature Coefficient

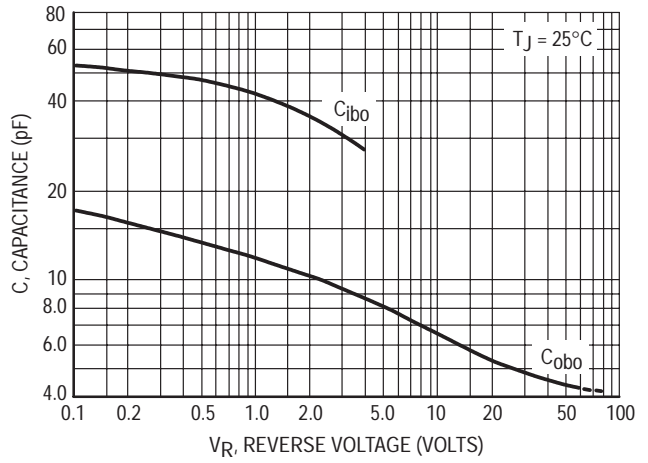


Figure 5. Capacitance

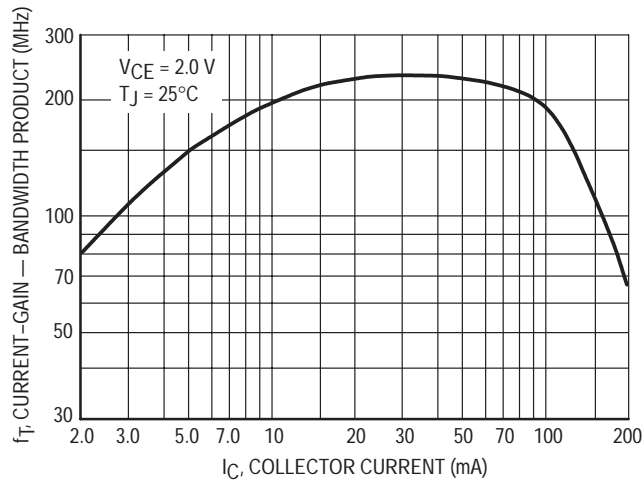


Figure 6. Current-Gain — Bandwidth Product

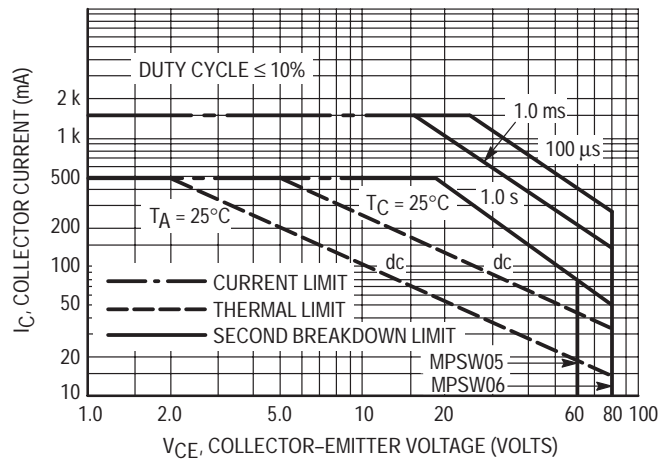
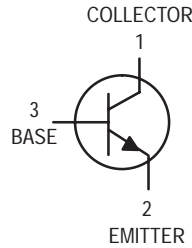
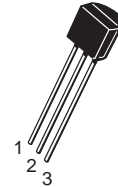


Figure 7. Active Region — Safe Operating Area

RF Transistor
NPN Silicon



BF199



CASE 29-04, STYLE 21
TO-92 (TO-226AA)

MAXIMUM RATINGS

Rating	Symbol	Value	Unit
Collector–Emitter Voltage	V_{CEO}	25	Vdc
Collector–Base Voltage	V_{CBO}	40	Vdc
Emitter–Base Voltage	V_{EBO}	4.0	Vdc
Collector Current — Continuous	I_C	100	mAdc
Total Device Dissipation @ $T_A = 25^\circ\text{C}$ Derate above 25°C	P_D	350 2.8	mW mW/ $^\circ\text{C}$
Total Device Dissipation @ $T_C = 25^\circ\text{C}$ Derate above 25°C	P_D	1.0 8.0	Watts mW/ $^\circ\text{C}$
Operating and Storage Junction Temperature Range	T_J, T_{stg}	-55 to +150	$^\circ\text{C}$

THERMAL CHARACTERISTICS

Characteristic	Symbol	Max	Unit
Thermal Resistance, Junction to Ambient	$R_{\theta JA}$	357	$^\circ\text{C}/\text{W}$
Thermal Resistance, Junction to Case	$R_{\theta JC}$	125	$^\circ\text{C}/\text{W}$

ELECTRICAL CHARACTERISTICS ($T_A = 25^\circ\text{C}$ unless otherwise noted)

Characteristic	Symbol	Min	Typ	Max	Unit
----------------	--------	-----	-----	-----	------

OFF CHARACTERISTICS

Collector–Emitter Breakdown Voltage ($I_C = 1.0 \text{ mAdc}, I_E = 0$)	$V_{(BR)CEO}$	25	—	—	Vdc
Collector–Base Breakdown Voltage ($I_C = 100 \mu\text{Adc}, I_E = 0$)	$V_{(BR)CBO}$	40	—	—	Vdc
Emitter–Base Breakdown Voltage ($I_E = 10 \mu\text{Adc}, I_C = 0$)	$V_{(BR)EBO}$	4.0	—	—	Vdc
Collector Cutoff Current ($V_{CB} = 20 \text{ Vdc}, I_E = 0$)	I_{CBO}	—	—	100	nAdc

BF199**ELECTRICAL CHARACTERISTICS** ($T_A = 25^\circ\text{C}$ unless otherwise noted) (Continued)

Characteristic	Symbol	Min	Typ	Max	Unit
ON CHARACTERISTICS					
DC Current Gain ($I_C = 7.0 \text{ mAdc}$, $V_{CE} = 10 \text{ Vdc}$)	h_{FE}	40	85	—	—
Base–Emitter On Voltage ($I_C = 7.0 \text{ mAdc}$, $V_{CE} = 10 \text{ Vdc}$)	$V_{BE(on)}$	—	770	900	mVdc
SMALL–SIGNAL CHARACTERISTICS					
Current Gain — Bandwidth Product ($I_C = 5.0 \text{ mAdc}$, $V_{CE} = 10 \text{ Vdc}$, $f = 100 \text{ MHz}$)	f_T	400	750	—	MHz
Common Emitter Feedback Capacitance ($V_{CB} = 10 \text{ Vdc}$, $I_E = 0$, $f = 1.0 \text{ MHz}$)	C_{re}	—	0.25	0.35	pF
Noise Figure ($I_C = 4.0 \text{ mAdc}$, $V_{CE} = 10 \text{ Vdc}$, $R_S = 50 \Omega$, $f = 35 \text{ MHz}$)	N_f	—	2.5	—	dB

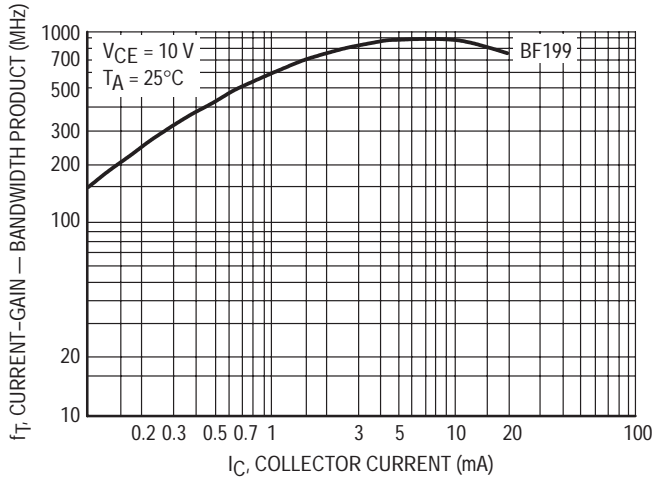


Figure 1. Current-Gain — Bandwidth Product

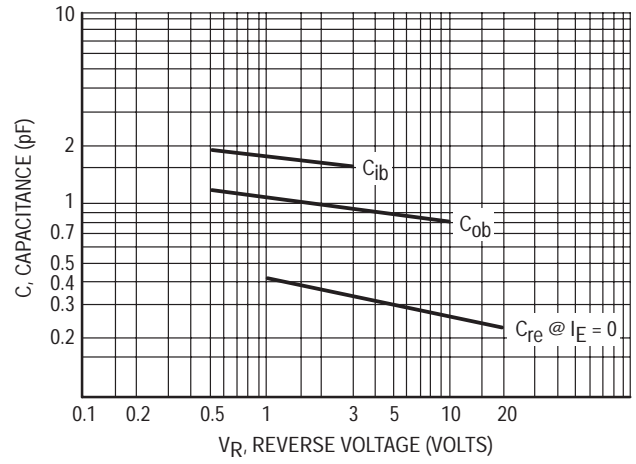


Figure 2. Capacitances

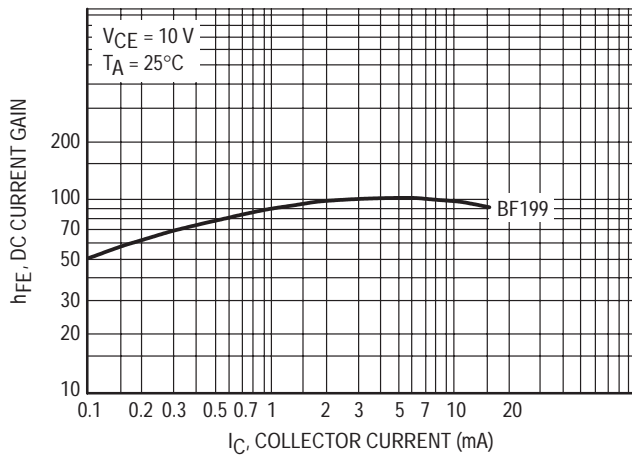


Figure 3. DC Current Gain

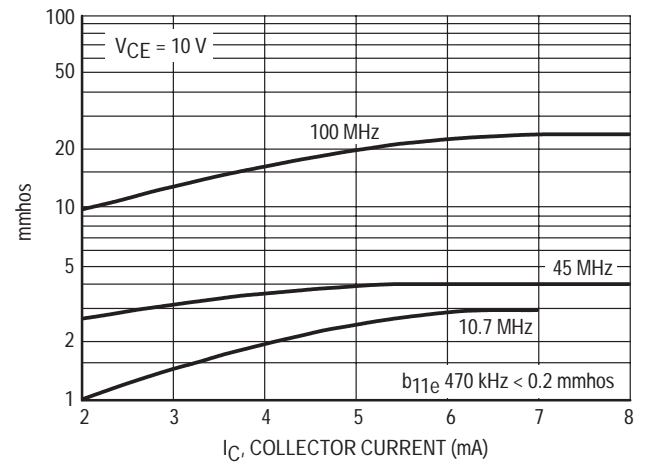


Figure 4. b_{11e}

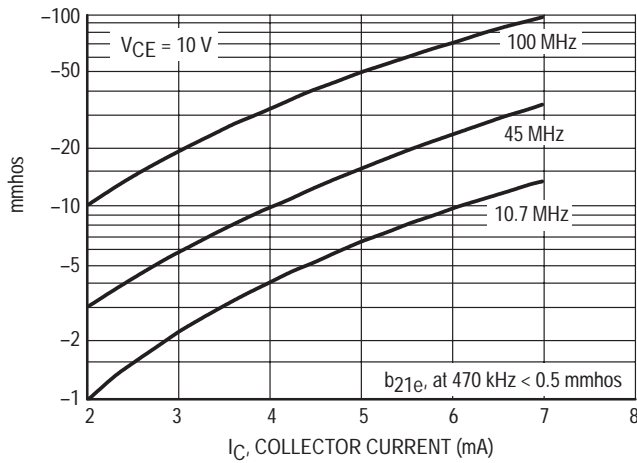


Figure 5. b_{21e}

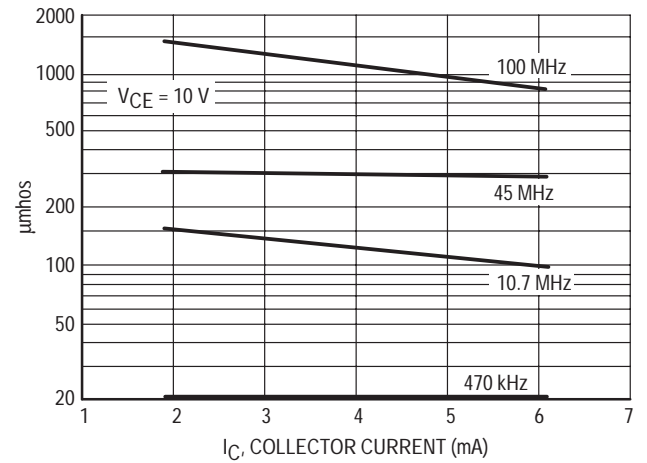


Figure 6. b_{22e} (boe)

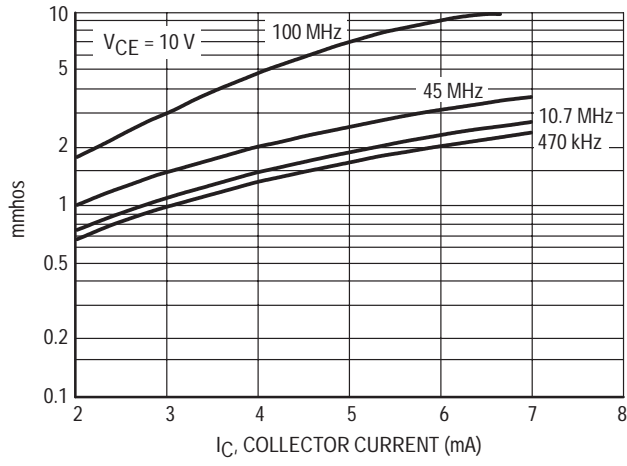


Figure 7. g11e (gie)

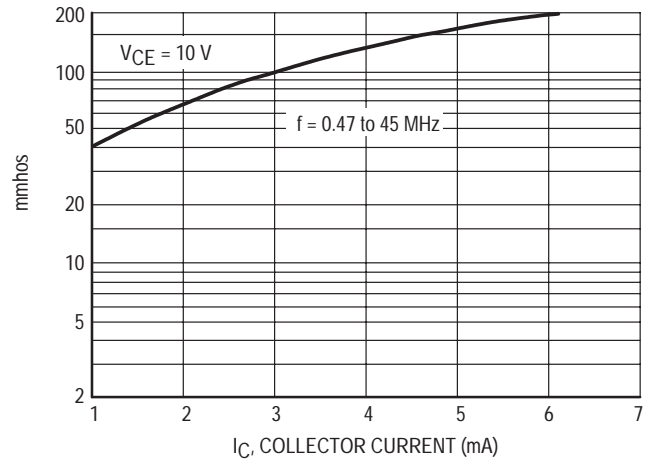


Figure 8. g21e (Yfe)

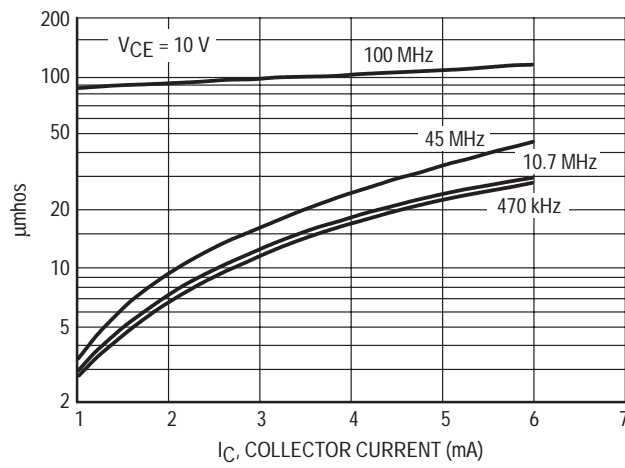
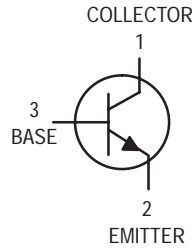


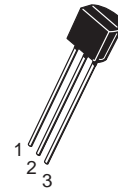
Figure 9. g22e (goe)

RF Transistor

NPN Silicon



BF224



CASE 29-04, STYLE 21
TO-92 (TO-226AA)

MAXIMUM RATINGS

Rating	Symbol	Value	Unit
Collector–Emitter Voltage	V_{CEO}	30	Vdc
Collector–Base Voltage	V_{CBO}	45	Vdc
Emitter–Base Voltage	V_{EBO}	4.0	Vdc
Collector Current — Continuous	I_C	50	mAdc
Total Device Dissipation @ $T_A = 25^\circ\text{C}$ Derate above 25°C	P_D	350 2.8	mW mW/ $^\circ\text{C}$
Total Device Dissipation @ $T_C = 25^\circ\text{C}$ Derate above 25°C	P_D	1.0 8.0	Watts mW/ $^\circ\text{C}$
Operating and Storage Junction Temperature Range	T_J, T_{stg}	-55 to +150	$^\circ\text{C}$

THERMAL CHARACTERISTICS

Characteristic	Symbol	Max	Unit
Thermal Resistance, Junction to Ambient	$R_{\theta JA}$	357	$^\circ\text{C}/\text{W}$
Thermal Resistance, Junction to Case	$R_{\theta JC}$	125	$^\circ\text{C}/\text{W}$

ELECTRICAL CHARACTERISTICS ($T_A = 25^\circ\text{C}$ unless otherwise noted)

Characteristic	Symbol	Min	Typ	Max	Unit
----------------	--------	-----	-----	-----	------

OFF CHARACTERISTICS

Collector–Emitter Breakdown Voltage ($I_C = 1.0 \text{ mAdc}, I_E = 0$)	$V_{(BR)CEO}$	30	—	—	Vdc
Collector–Base Breakdown Voltage ($I_C = 100 \mu\text{Adc}, I_E = 0$)	$V_{(BR)CBO}$	45	—	—	Vdc
Emitter–Base Breakdown Voltage ($I_E = 100 \mu\text{Adc}, I_C = 0$)	$V_{(BR)EBO}$	4.0	—	—	Vdc
Collector Cutoff Current ($V_{CB} = 20 \text{ Vdc}, I_E = 0$)	I_{CBO}	—	—	100	nAdc
Emitter Cutoff Current ($V_{EB} = 3.0 \text{ Vdc}, I_C = 0$)	I_{EBO}	—	—	100	nAdc

BF224**ELECTRICAL CHARACTERISTICS** ($T_A = 25^\circ\text{C}$ unless otherwise noted) (Continued)

Characteristic	Symbol	Min	Typ	Max	Unit
ON CHARACTERISTICS					
DC Current Gain ($I_C = 7.0 \text{ mAdc}$, $V_{CE} = 10 \text{ Vdc}$)	h_{FE}	30	—	—	—
Base–Emitter On Voltage ($I_C = 7.0 \text{ mAdc}$, $V_{CE} = 10 \text{ Vdc}$)	$V_{BE(on)}$	—	0.77	0.9	mVdc
Collector–Emitter Saturation Voltage ($I_C = 10 \text{ mAdc}$, $I_B = 1.0 \text{ mAdc}$)	$V_{CE(sat)}$	—	—	0.15	Vdc
SMALL–SIGNAL CHARACTERISTICS					
Current Gain — Bandwidth Product ($I_C = 1.5 \text{ mAdc}$, $V_{CE} = 10 \text{ Vdc}$, $f = 100 \text{ MHz}$) ($I_C = 7.0 \text{ mAdc}$, $V_{CE} = 10 \text{ Vdc}$, $f = 100 \text{ MHz}$)	f_T	300 —	600 850	— —	MHz
Common Emitter Feedback Capacitance ($V_{CE} = 10 \text{ Vdc}$, $I_E = 0$, $f = 1.0 \text{ MHz}$)	C_{re}	—	0.28	—	pF
Noise Figure ($I_C = 1.0 \text{ mAdc}$, $V_{CE} = 10 \text{ Vdc}$, $R_S = 50 \Omega$, $f = 100 \text{ MHz}$) ($I_C = 1.0 \text{ mAdc}$, $V_{CE} = 10 \text{ Vdc}$, $R_S = 50 \Omega$, $f = 200 \text{ MHz}$)	N_f	— —	2.5 3.5	— —	dB

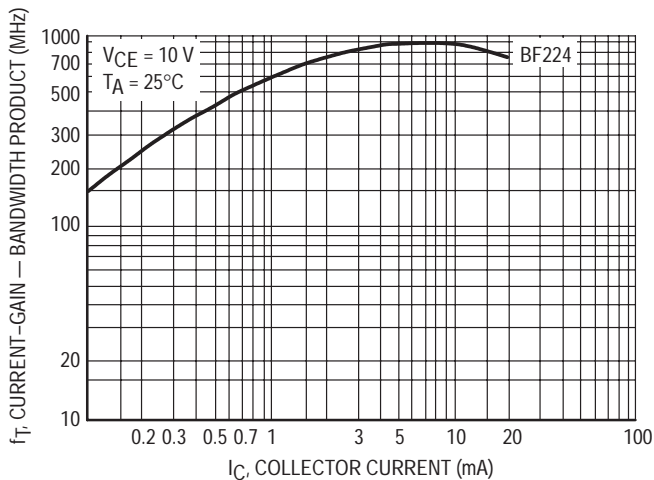


Figure 1. Current-Gain — Bandwidth Product

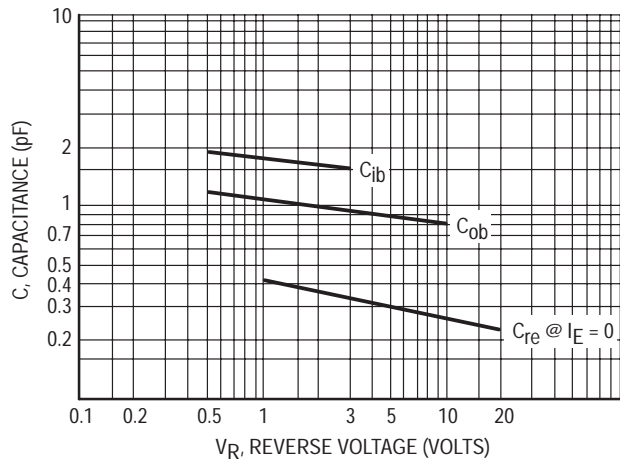


Figure 2. Capacitances

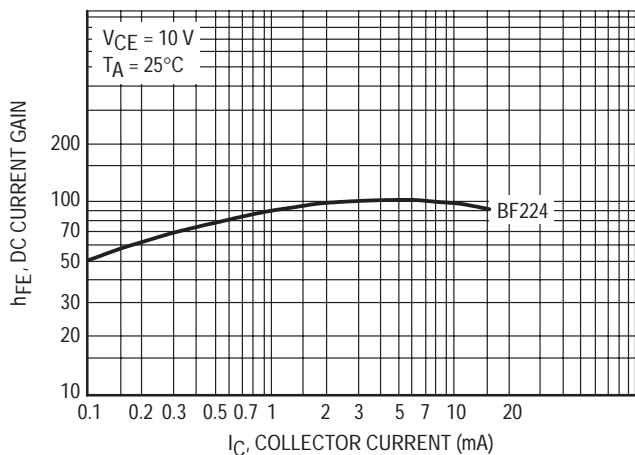


Figure 3. DC Current Gain

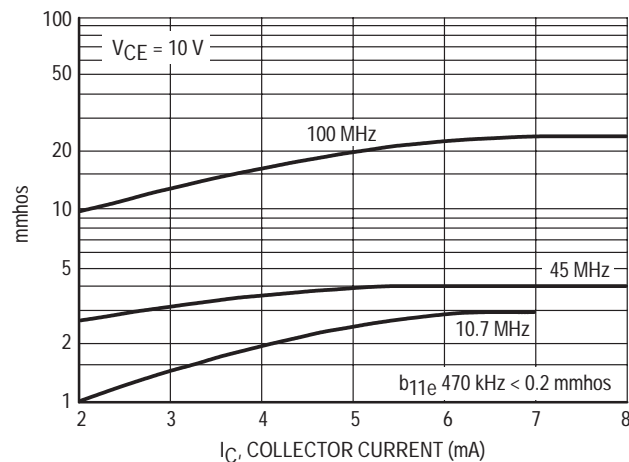


Figure 4. b_{11e}

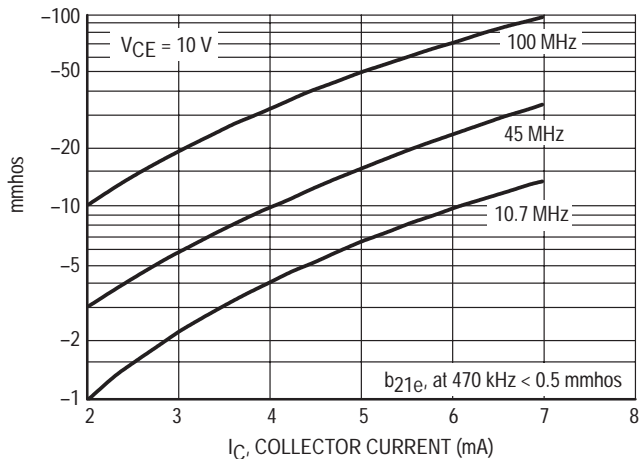


Figure 5. b_{21e}

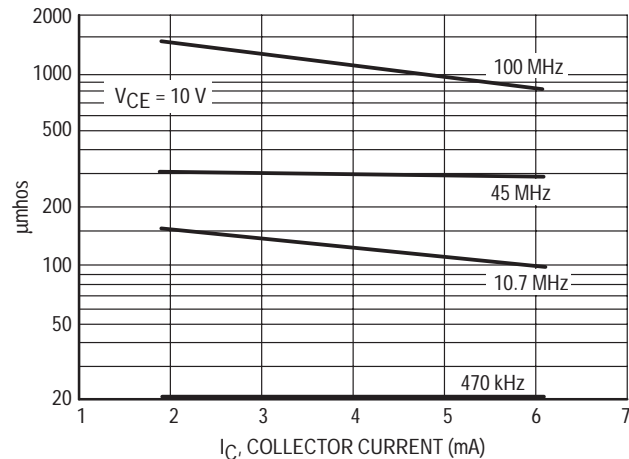


Figure 6. b_{22e} (boe)

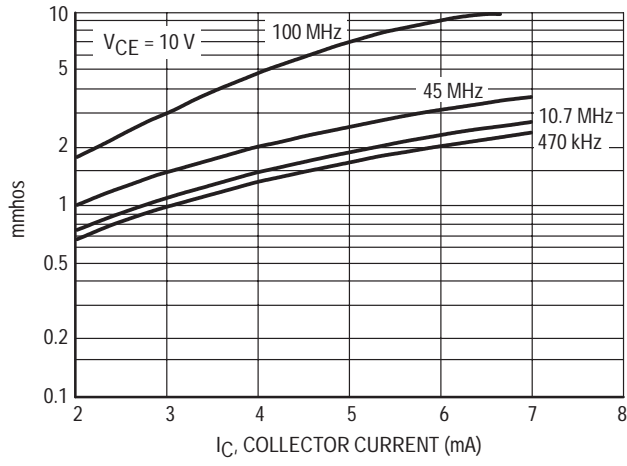


Figure 7. g11e (gie)

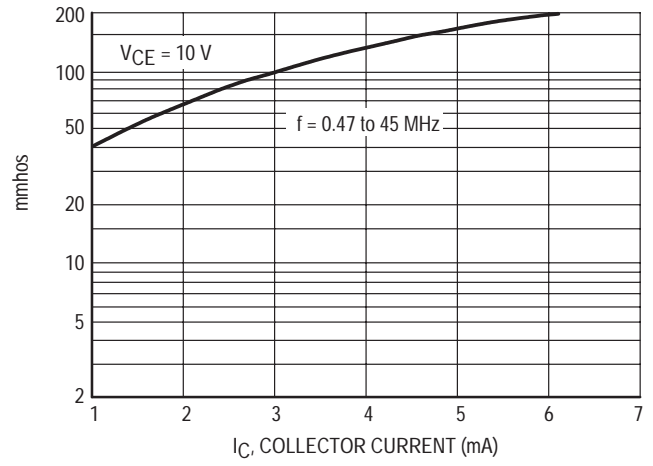


Figure 8. g21e (Yfe)

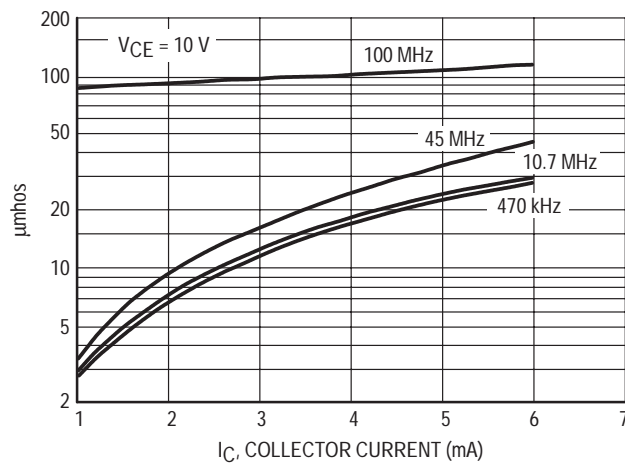
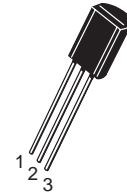
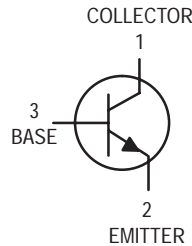


Figure 9. g22e (goe)

AM/FM Transistor
NPN Silicon

BF240



CASE 29-04, STYLE 18
TO-92 (TO-226AA)

MAXIMUM RATINGS

Rating	Symbol	Value	Unit
Collector–Emitter Voltage	V_{CE0}	40	Vdc
Collector–Base Voltage	V_{CBO}	40	Vdc
Emitter–Base Voltage	V_{EBO}	4.0	Vdc
Collector Current — Continuous	I_C	25	mAdc
Total Device Dissipation @ $T_A = 25^\circ\text{C}$ Derate above 25°C	P_D	350 2.8	mW mW/ $^\circ\text{C}$
Total Device Dissipation @ $T_C = 25^\circ\text{C}$ Derate above 25°C	P_D	1.0 8.0	Watt mW/ $^\circ\text{C}$
Operating and Storage Junction Temperature Range	T_J, T_{stg}	-55 to +150	$^\circ\text{C}$

THERMAL CHARACTERISTICS

Characteristic	Symbol	Max	Unit
Thermal Resistance, Junction to Ambient	$R_{\theta JA}$	357	$^\circ\text{C}/\text{W}$
Thermal Resistance, Junction to Case	$R_{\theta JC}$	125	$^\circ\text{C}/\text{W}$

ELECTRICAL CHARACTERISTICS ($T_A = 25^\circ\text{C}$ unless otherwise noted)

Characteristic	Symbol	Min	Typ	Max	Unit
----------------	--------	-----	-----	-----	------

OFF CHARACTERISTICS

Collector–Emitter Breakdown Voltage ⁽¹⁾ ($I_C = 1.0 \text{ mAdc}, I_E = 0$)	$V_{(BR)CEO}$	40	—	—	Vdc
Collector–Base Breakdown Voltage ($I_C = 100 \mu\text{Adc}, I_E = 0$)	$V_{(BR)CBO}$	40	—	—	Vdc
Emitter–Base Breakdown Voltage ($I_E = 10 \mu\text{Adc}, I_C = 0$)	$V_{(BR)EBO}$	4.0	—	—	Vdc
Collector Cutoff Current ($V_{CB} = 20 \text{ Vdc}, I_E = 0$)	I_{CBO}	—	—	100	nAdc

ON CHARACTERISTICS

DC Current Gain ($I_C = 1.0 \text{ mAdc}, V_{CE} = 10 \text{ Vdc}$)	h_{FE}	65	—	220	—
Base–Emitter On Voltage ($I_C = 1.0 \text{ mAdc}, V_{CE} = 10 \text{ Vdc}$)	$V_{BE(on)}$	0.65	0.7	0.74	Vdc

SMALL-SIGNAL CHARACTERISTICS

Current–Gain — Bandwidth Product ($I_C = 1.0 \text{ mAdc}, V_{CE} = 10 \text{ Vdc}, f = 100 \text{ MHz}$)	f_T	—	600	—	MHz
Common Emitter Feedback Capacitance ($V_{CB} = 10 \text{ Vdc}, I_E = 0, f = 1.0 \text{ MHz}$)	C_{re}	—	0.28	0.34	pF

1. Pulse Test: Pulse Width $\leq 300 \mu\text{s}$, Duty Cycle $\leq 2.0\%$.

BF240

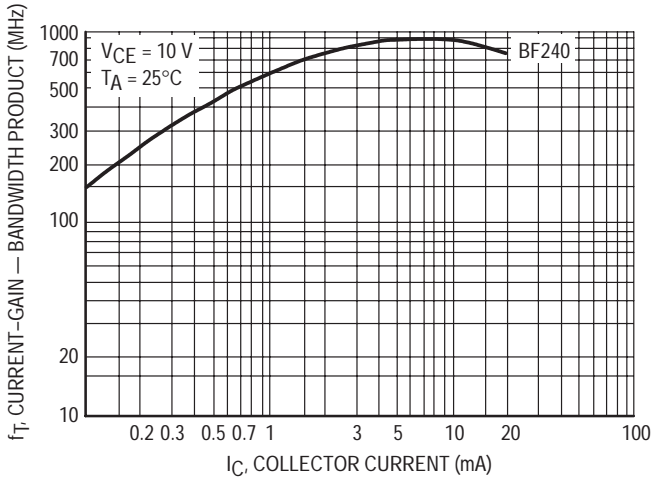


Figure 1. Current-Gain — Bandwidth Product

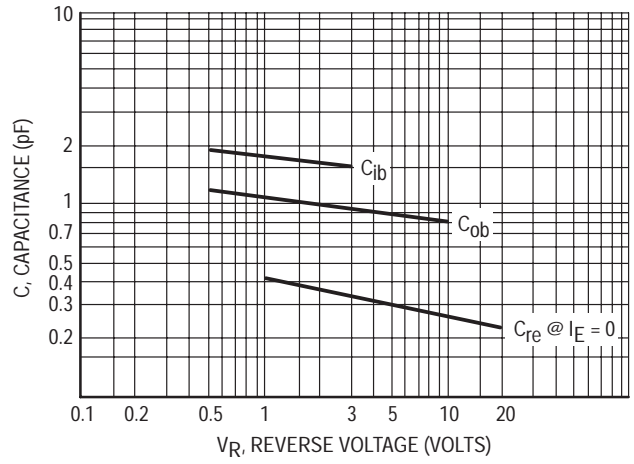


Figure 2. Capacitances

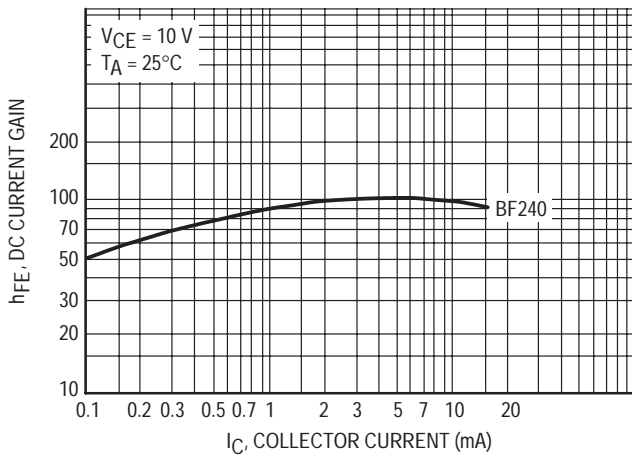


Figure 3. DC Current Gain

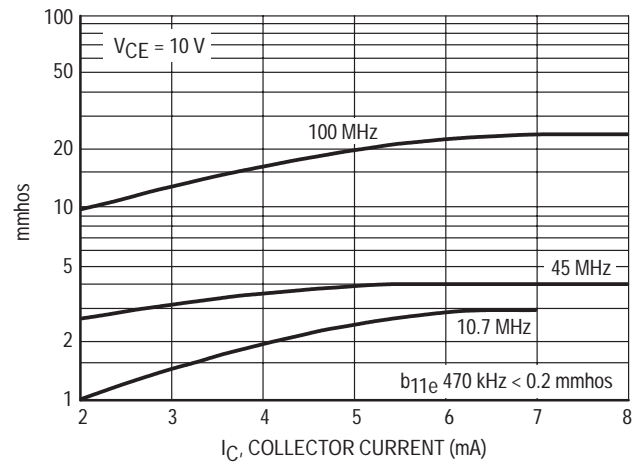


Figure 4. b11e

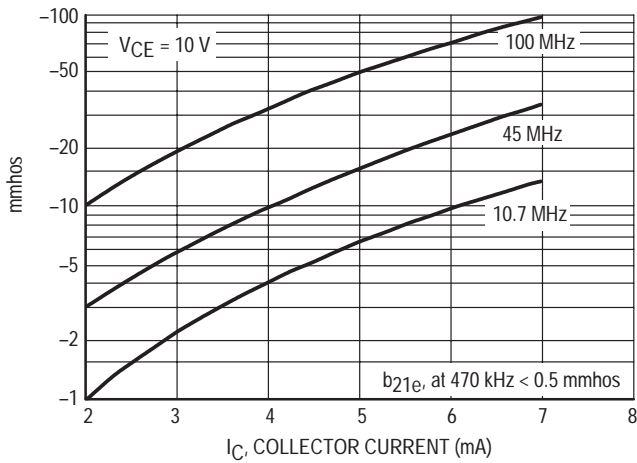


Figure 5. b21e

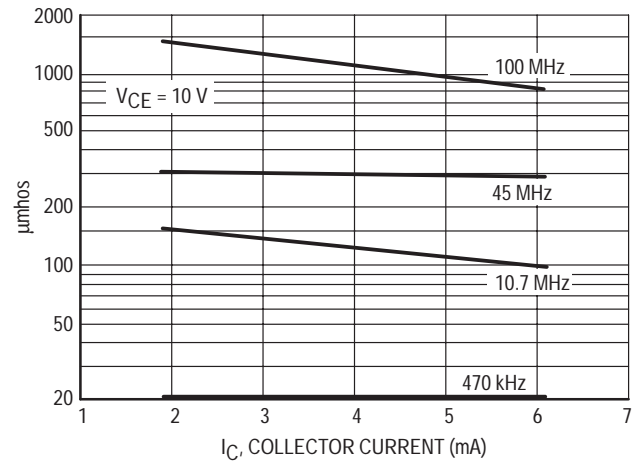


Figure 6. b22e (boe)

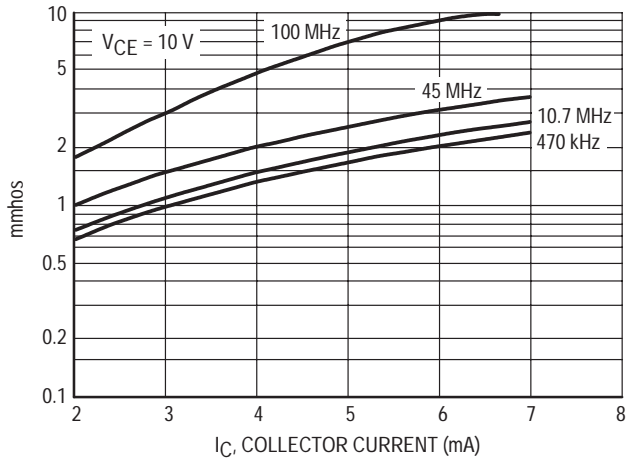


Figure 7. g_{m1e} (g_{ie})

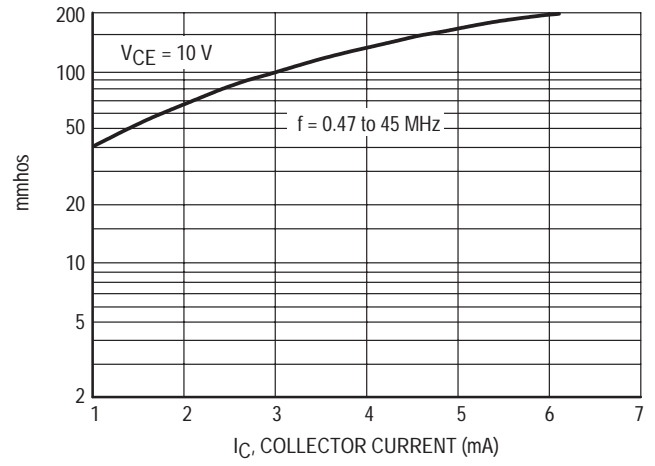


Figure 8. g_{m2e} (Y_{fe})

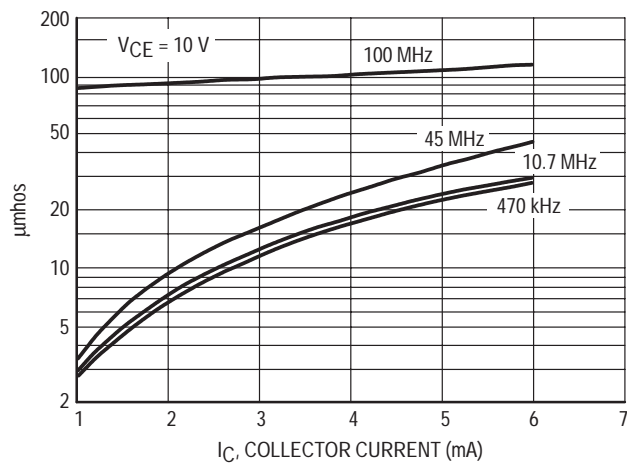
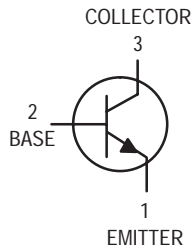


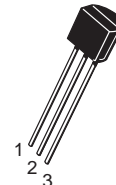
Figure 9. g_{m2e} (g_{oe})

High Voltage Transistor

NPN Silicon



BF393



CASE 29-04, STYLE 1
TO-92 (TO-226AA)

MAXIMUM RATINGS

Rating	Symbol	Value	Unit
Collector–Emitter Voltage	V_{CEO}	300	Vdc
Collector–Base Voltage	V_{CBO}	300	Vdc
Emitter–Base Voltage	V_{EBO}	6.0	Vdc
Collector Current — Continuous	I_C	500	mAdc
Total Device Dissipation @ $T_A = 25^\circ\text{C}$ Derate above 25°C	P_D	625 5.0	mW mW/ $^\circ\text{C}$
Total Device Dissipation @ $T_C = 25^\circ\text{C}$ Derate above 25°C	P_D	1.5 12	Watts mW/ $^\circ\text{C}$
Operating and Storage Junction Temperature Range	T_J, T_{stg}	-55 to +150	$^\circ\text{C}$

THERMAL CHARACTERISTICS

Characteristic	Symbol	Max	Unit
Thermal Resistance, Junction to Ambient	$R_{\theta JA}$	200	$^\circ\text{C}/\text{W}$
Thermal Resistance, Junction to Case	$R_{\theta JC}$	83.3	$^\circ\text{C}/\text{W}$

ELECTRICAL CHARACTERISTICS ($T_A = 25^\circ\text{C}$ unless otherwise noted)

Characteristic	Symbol	Min	Max	Unit
----------------	--------	-----	-----	------

OFF CHARACTERISTICS

Collector–Emitter Breakdown Voltage ⁽¹⁾ ($I_C = 1.0 \text{ mAdc}, I_E = 0$)	$V_{(BR)CEO}$	300	—	Vdc
Collector–Base Breakdown Voltage ($I_C = 100 \mu\text{Adc}, I_E = 0$)	$V_{(BR)CBO}$	300	—	Vdc
Emitter–Base Breakdown Voltage ($I_E = 100 \mu\text{Adc}, I_C = 0$)	$V_{(BR)EBO}$	6.0	—	Vdc
Collector Cutoff Current ($V_{CB} = 200 \text{ Vdc}, I_E = 0$)	I_{CBO}	—	0.1	μAdc
Emitter Cutoff Current ($V_{EB} = 6.0 \text{ Vdc}, I_C = 0$)	I_{EBO}	—	0.1	μAdc

1. Pulse Test: Pulse Width $\leq 300 \mu\text{s}$; Duty Cycle $\leq 2.0\%$.

(Replaces BF392/D)

ELECTRICAL CHARACTERISTICS ($T_A = 25^\circ\text{C}$ unless otherwise noted) (Continued)

Characteristic	Symbol	Min	Max	Unit
ON CHARACTERISTICS				
DC Current Gain ($I_C = 1.0 \text{ mA dc}$, $V_{CE} = 10 \text{ V dc}$) ($I_C = 10 \text{ mA dc}$, $V_{CE} = 10 \text{ V dc}$)	h_{FE}	25 40	— —	—
Collector–Emitter Saturation Voltage ($I_C = 20 \text{ mA dc}$, $I_B = 2.0 \text{ mA dc}$)	$V_{CE(\text{sat})}$	—	2.0	Vdc
Base–Emitter Saturation Voltage ($I_C = 20 \text{ mA dc}$, $I_B = 2.0 \text{ mA dc}$)	$V_{BE(\text{sat})}$	—	2.0	Vdc
SMALL–SIGNAL CHARACTERISTICS				
Current Gain — Bandwidth Product ($I_C = 10 \text{ mA dc}$, $V_{CE} = 20 \text{ V dc}$, $f = 20 \text{ MHz}$)	f_T	50	—	MHz
Common Emitter Feedback Capacitance ($V_{CB} = 60 \text{ V dc}$, $I_E = 0$, $f = 1.0 \text{ MHz}$)	C_{re}	—	2.0	pF

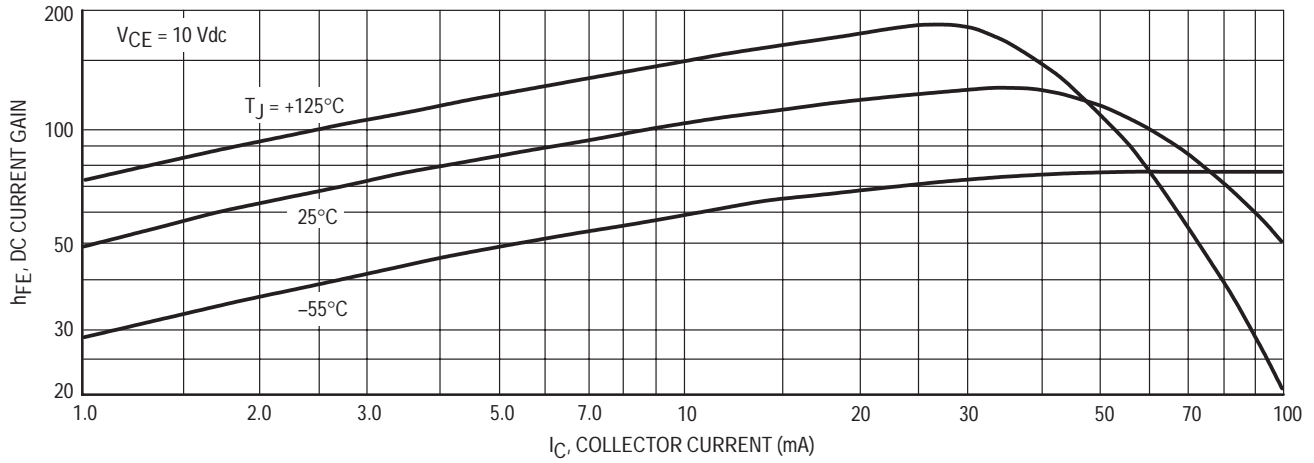


Figure 1. DC Current Gain

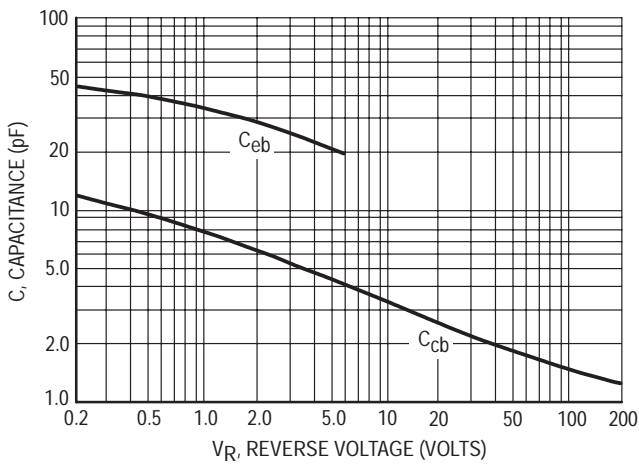


Figure 2. Capacitances

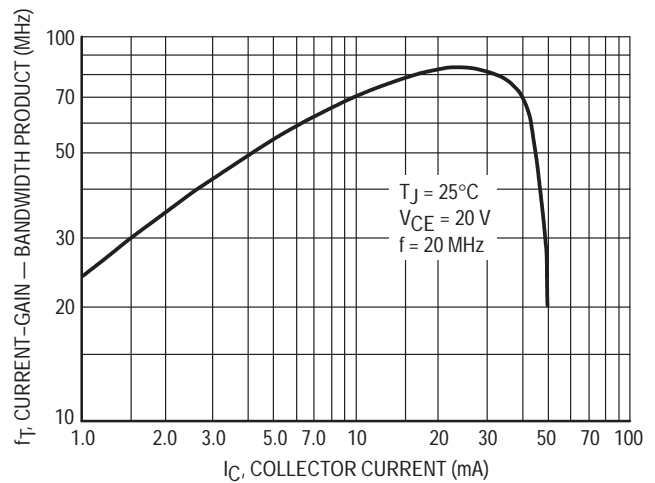


Figure 3. Current-Gain — Bandwidth Product

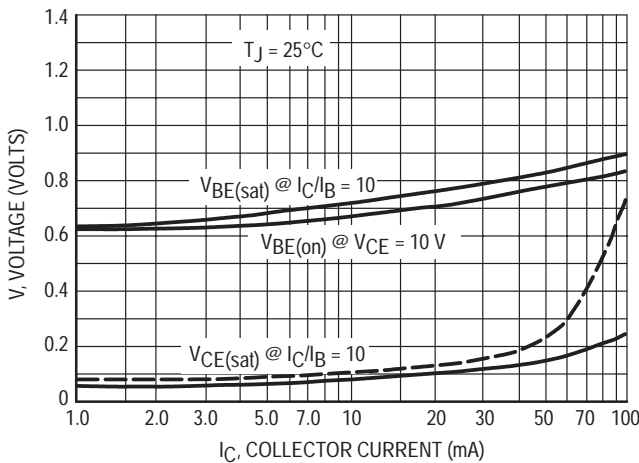


Figure 4. "On" Voltages

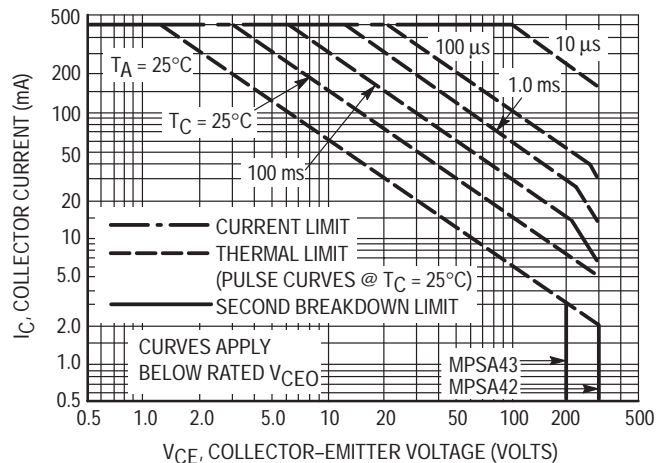
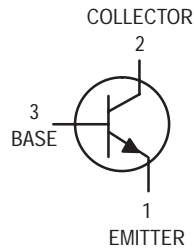


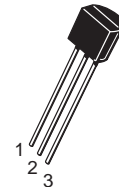
Figure 5. Maximum Forward Bias Safe Operating Area

High Voltage Transistors

NPN Silicon



BF420
BF422



CASE 29-04, STYLE 14
TO-92 (TO-226AA)

MAXIMUM RATINGS

Rating	Symbol	BF420	BF422	Unit
Collector–Emitter Voltage	V_{CEO}	300	250	Vdc
Collector–Base Voltage	V_{CBO}	300	250	Vdc
Emitter–Base Voltage	V_{EBO}	5.0		Vdc
Collector Current — Continuous	I_C	500		mAdc
Total Device Dissipation @ $T_A = 25^\circ\text{C}$ Derate above 25°C	P_D	625	5.0	mW mW/ $^\circ\text{C}$
Total Device Dissipation @ $T_C = 25^\circ\text{C}$ Derate above 25°C	P_D	1.5	12	Watts mW/ $^\circ\text{C}$
Operating and Storage Junction Temperature Range	T_J, T_{stg}	–55 to +150		$^\circ\text{C}$

THERMAL CHARACTERISTICS

Characteristic	Symbol	Max	Unit
Thermal Resistance, Junction to Ambient	$R_{\theta JA}$	200	$^\circ\text{C}/\text{W}$
Thermal Resistance, Junction to Case	$R_{\theta JC}$	83.3	$^\circ\text{C}/\text{W}$

ELECTRICAL CHARACTERISTICS ($T_A = 25^\circ\text{C}$ unless otherwise noted)

Characteristic	Symbol	Min	Max	Unit
----------------	--------	-----	-----	------

OFF CHARACTERISTICS

Collector–Emitter Breakdown Voltage ⁽¹⁾ ($I_C = 1.0 \text{ mAdc}, I_B = 0$)	BF420 BF422	$V_{(BR)CEO}$	300 250	— —	Vdc
Collector–Base Breakdown Voltage ($I_C = 100 \mu\text{Adc}, I_E = 0$)	BF420 BF422	$V_{(BR)CBO}$	300 250	— —	Vdc
Emitter–Base Breakdown Voltage ($I_E = 100 \mu\text{Adc}, I_C = 0$)	BF420 BF422	$V_{(BR)EBO}$	5.0 5.0	— —	Vdc
Collector Cutoff Current ($V_{CB} = 200 \text{ Vdc}, I_E = 0$)	BF420 BF422	I_{CBO}	— —	0.01 —	μAdc
Emitter Cutoff Current ($V_{EB} = 5.0 \text{ Vdc}, I_C = 0$)	BF420 BF422	I_{EBO}	— —	100 —	nAdc

1. Pulse Test: Pulse Width $\leq 300 \mu\text{s}$; Duty Cycle $\leq 2.0\%$.

BF420 BF422**ELECTRICAL CHARACTERISTICS** ($T_A = 25^\circ\text{C}$ unless otherwise noted) (Continued)

Characteristic	Symbol	Min	Max	Unit
ON CHARACTERISTICS				
DC Current Gain ($I_C = 25 \text{ mA dc}$, $V_{CE} = 20 \text{ V dc}$)	h_{FE}	50	—	—
	BF420	50	—	—
	BF422	—	—	—
Collector–Emitter Saturation Voltage ($I_C = 20 \text{ mA dc}$, $I_B = 2.0 \text{ mA dc}$)	$V_{CE(sat)}$	—	0.5	Vdc
Base–Emitter Saturation Voltage ($I_C = 20 \text{ mA dc}$, $I_B = 2.0 \text{ mA dc}$)	$V_{BE(sat)}$	—	2.0	Vdc
SMALL–SIGNAL CHARACTERISTICS				
Current Gain — Bandwidth Product ($I_C = 10 \text{ mA dc}$, $V_{CE} = 10 \text{ V dc}$, $f = 20 \text{ MHz}$)	f_T	60	—	MHz
Common Emitter Feedback Capacitance ($V_{CB} = 30 \text{ V dc}$, $I_E = 0$, $f = 1.0 \text{ MHz}$)	C_{re}	—	1.6	pF

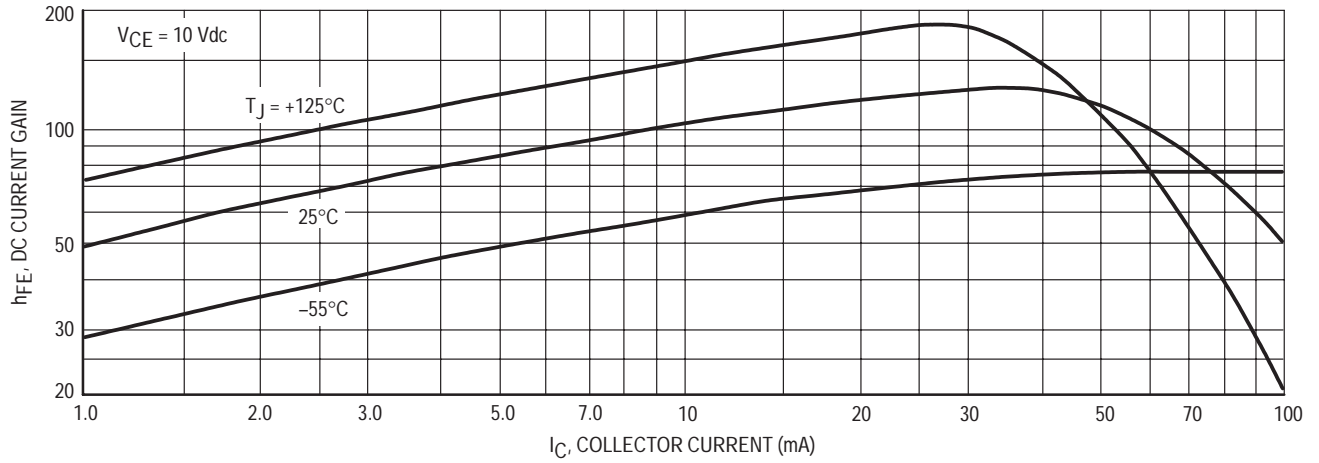


Figure 1. DC Current Gain

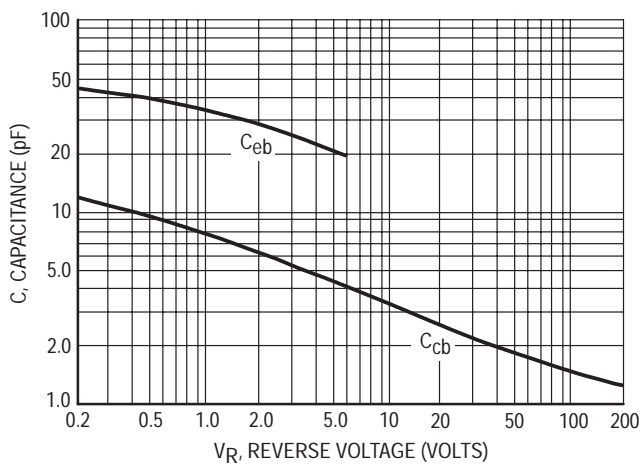


Figure 2. Capacitances

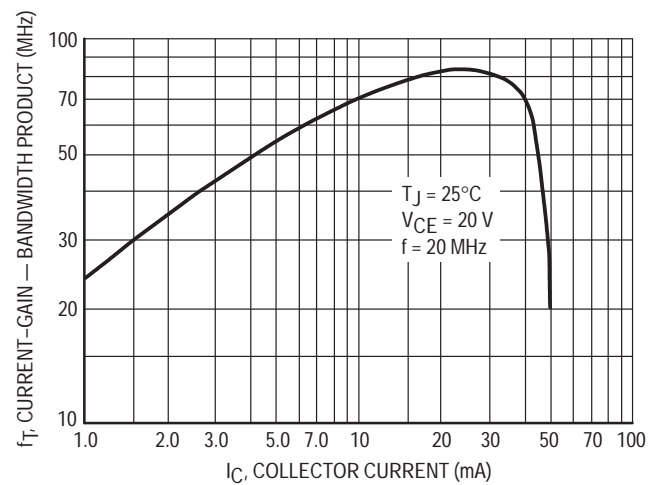


Figure 3. Current-Gain — Bandwidth Product

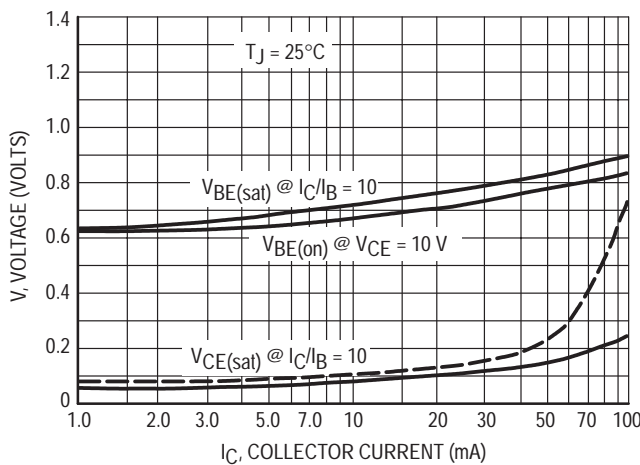


Figure 4. "On" Voltages

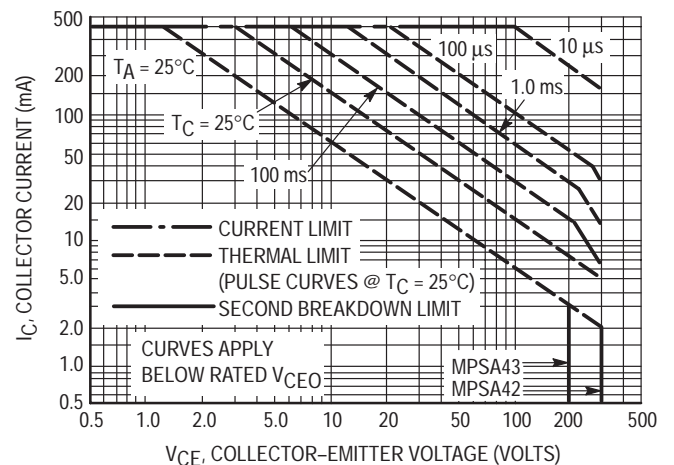
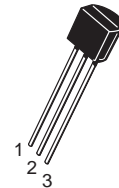
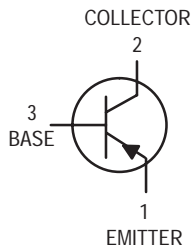


Figure 5. Maximum Forward Bias Safe Operating Area

High Voltage Transistors

PNP Silicon

BF421
BF423



CASE 29-04, STYLE 14
TO-92 (TO-226AA)

MAXIMUM RATINGS

Rating	Symbol	BF421	BF423	Unit
Collector–Emitter Voltage	V_{CEO}	-300	-250	Vdc
Collector–Base Voltage	V_{CBO}	-300	-250	Vdc
Emitter–Base Voltage	V_{EBO}	-5.0		Vdc
Collector Current — Continuous	I_C	-500		mAdc
Total Device Dissipation @ $T_A = 25^\circ\text{C}$ Derate above 25°C	P_D	625 5.0		mW mW/°C
Total Device Dissipation @ $T_C = 25^\circ\text{C}$ Derate above 25°C	P_D	1.5 12		Watts mW/°C
Operating and Storage Junction Temperature Range	T_J, T_{stg}	-55 to +150		°C

THERMAL CHARACTERISTICS

Characteristic	Symbol	Max	Unit
Thermal Resistance, Junction to Ambient	$R_{\theta JA}$	200	°C/W
Thermal Resistance, Junction to Case	$R_{\theta JC}$	83.3	°C/W

ELECTRICAL CHARACTERISTICS ($T_A = 25^\circ\text{C}$ unless otherwise noted)

Characteristic	Symbol	Min	Max	Unit
----------------	--------	-----	-----	------

OFF CHARACTERISTICS

Collector–Emitter Breakdown Voltage (1) ($I_C = -1.0$ mAdc, $I_B = 0$)	BF421 BF423	$V_{(BR)CEO}$	-300 -250	— —	Vdc
Collector–Base Breakdown Voltage ($I_C = -100$ μ Adc, $I_E = 0$)	BF421 BF423	$V_{(BR)CBO}$	-300 -250	— —	Vdc
Emitter–Base Breakdown Voltage ($I_E = -100$ μ Adc, $I_C = 0$)	BF421 BF423	$V_{(BR)EBO}$	-5.0 -5.0	— —	Vdc
Collector Cutoff Current ($V_{CB} = -200$ Vdc, $I_E = 0$)	BF421 BF423	I_{CBO}	— —	-0.01 —	μ Adc
Emitter Cutoff Current ($V_{EB} = -5.0$ Vdc, $I_C = 0$)	BF421 BF423	I_{EBO}	— —	-100 —	nAdc

1. Pulse Test: Pulse Width ≤ 300 μ s; Duty Cycle $\leq 2.0\%$.

ELECTRICAL CHARACTERISTICS ($T_A = 25^\circ\text{C}$ unless otherwise noted) (Continued)

Characteristic	Symbol	Min	Max	Unit
ON CHARACTERISTICS				
DC Current Gain ($I_C = -25\text{ mA}$, $V_{CE} = -20\text{ Vdc}$)	h_{FE}	50	—	—
	BF421	50	—	—
	BF423	50	—	—
Collector–Emitter Saturation Voltage ($I_C = -20\text{ mAdc}$, $I_B = -2.0\text{ mAdc}$)	$V_{CE(sat)}$	—	-0.5	Vdc
Base–Emitter Saturation Voltage ($I_C = -20\text{ mA}$, $I_B = -2.0\text{ mA}$)	$V_{BE(sat)}$	—	-2.0	Vdc
SMALL–SIGNAL CHARACTERISTICS				
Current–Gain — Bandwidth Product ($I_C = -10\text{ mAdc}$, $V_{CE} = -10\text{ Vdc}$, $f = 20\text{ MHz}$)	f_T	60	—	MHz
Common Emitter Feedback Capacitance ($V_{CB} = -30\text{ Vdc}$, $I_E = 0$, $f = 1.0\text{ MHz}$)	C_{re}	—	2.8	pF

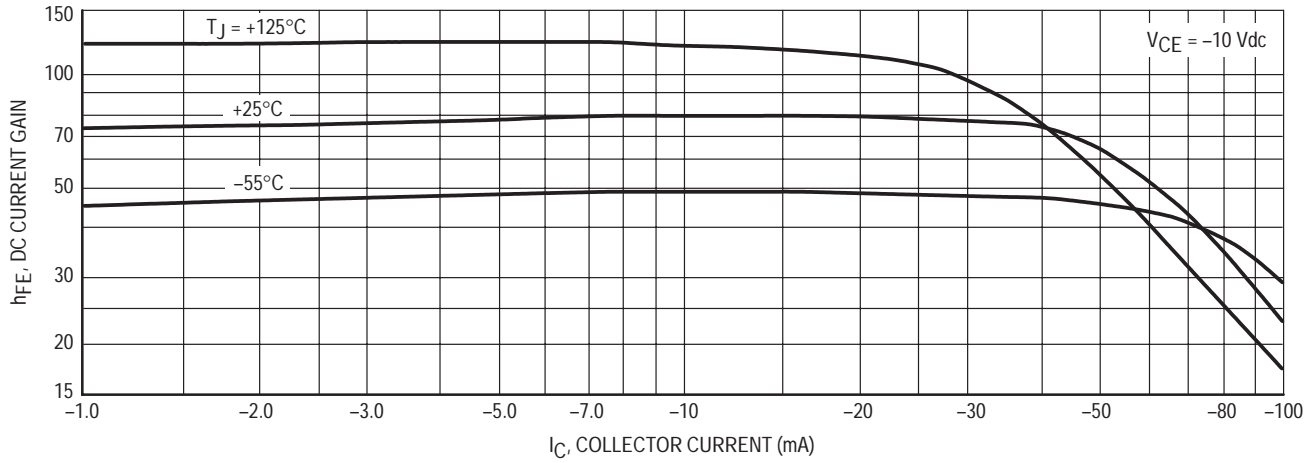


Figure 1. DC Current Gain

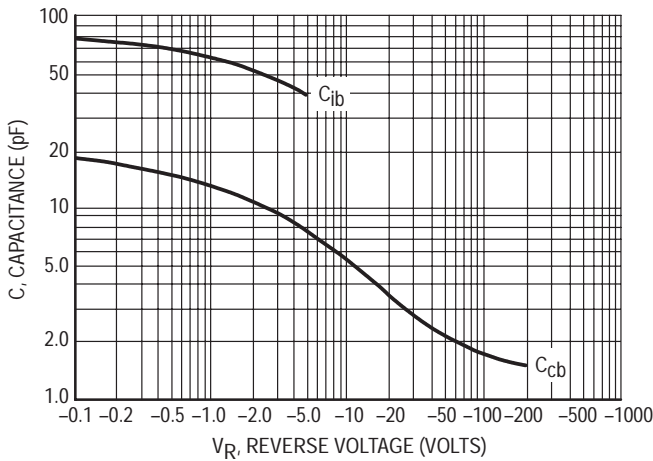


Figure 2. Capacitances

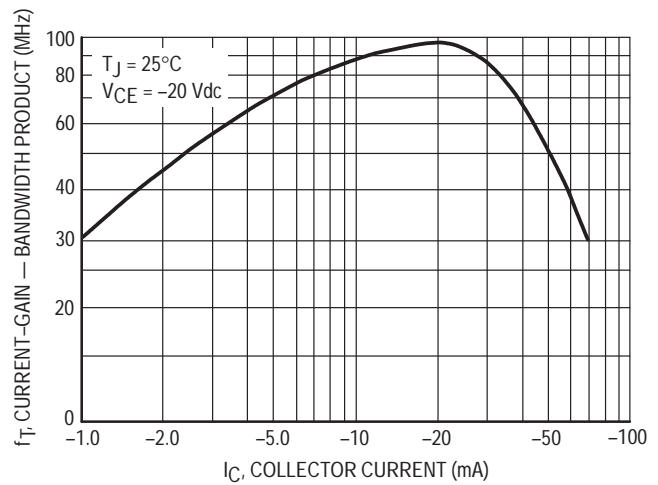


Figure 3. Current-Gain — Bandwidth Product

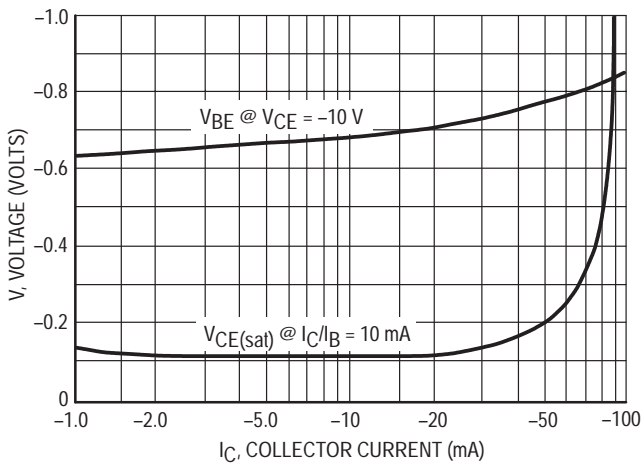


Figure 4. "On" Voltages

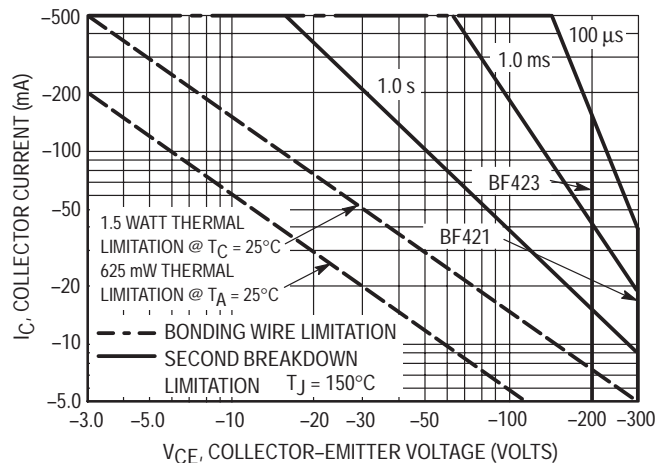
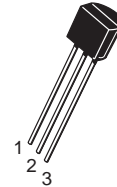
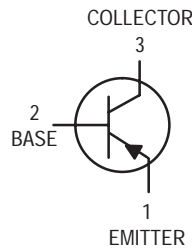


Figure 5. Active Region — Safe Operating Area

High Voltage Transistor

PNP Silicon

BF493S



CASE 29-04, STYLE 1
TO-92 (TO-226AA)

MAXIMUM RATINGS

Rating	Symbol	Value	Unit
Collector–Emitter Voltage	V_{CEO}	–350	Vdc
Collector–Base Voltage	V_{CBO}	–350	Vdc
Emitter–Base Voltage	V_{EBO}	–6.0	Vdc
Collector Current — Continuous	I_C	–500	mAdc
Total Device Dissipation @ $T_A = 25^\circ\text{C}$ Derate above 25°C	P_D	625 5.0	Watts mW/ $^\circ\text{C}$
Total Device Dissipation @ $T_C = 25^\circ\text{C}$ Derate above 25°C	P_D	1.5 12	Watts mW/ $^\circ\text{C}$
Operating and Storage Junction Temperature Range	T_J, T_{stg}	–55 to +150	$^\circ\text{C}$

THERMAL CHARACTERISTICS

Characteristic	Symbol	Max	Unit
Thermal Resistance, Junction to Ambient	$R_{\theta JA}$	200	$^\circ\text{C}/\text{W}$
Thermal Resistance, Junction to Case	$R_{\theta JC}$	83.3	$^\circ\text{C}/\text{W}$

ELECTRICAL CHARACTERISTICS ($T_A = 25^\circ\text{C}$ unless otherwise noted)

Characteristic	Symbol	Min	Max	Unit
----------------	--------	-----	-----	------

OFF CHARACTERISTICS

Collector–Emitter Breakdown Voltage ⁽¹⁾ ($I_C = -1.0$ mAdc, $I_B = 0$)	$V_{(BR)CEO}$	–350	—	Vdc
Collector–Base Breakdown Voltage ($I_C = -100$ μAdc , $I_E = 0$)	$V_{(BR)CBO}$	–350	—	Vdc
Emitter–Base Breakdown Voltage ($I_E = -100$ μAdc , $I_C = 0$)	$V_{(BR)EBO}$	–6.0	—	Vdc
Collector Cutoff Current ($V_{CE} = -250$ Vdc)	I_{CES}	—	–10	nAdc
Emitter Cutoff Current ($V_{EB} = -6.0$ Vdc, $I_C = 0$)	I_{EBO}	—	0.1	μAdc
Collector Cutoff Current ($V_{CB} = -250$ Vdc, $I_E = 0$, $T_A = 25^\circ\text{C}$) ($V_{CB} = -250$ Vdc, $I_E = 0$, $T_A = 100^\circ\text{C}$)	I_{CBO}	— —	–0.005 –1.0	μAdc

1. Pulse Test: Pulse Width ≤ 300 μs ; Duty Cycle $\leq 2.0\%$.

BF493S**ELECTRICAL CHARACTERISTICS** ($T_A = 25^\circ\text{C}$ unless otherwise noted) (Continued)

Characteristic	Symbol	Min	Max	Unit
ON CHARACTERISTICS				
DC Current Gain ($I_C = -1.0 \text{ mAdc}$, $V_{CE} = -10 \text{ Vdc}$) ($I_C = -10 \text{ mAdc}$, $V_{CE} = -10 \text{ Vdc}$)	h_{FE}	25 40	— —	—
Collector–Emitter Saturation Voltage ($I_C = -20 \text{ mAdc}$, $I_B = -2.0 \text{ mAdc}$)	$V_{CE(sat)}$	—	-2.0	Vdc
Base–Emitter On Voltage ($I_C = -20 \text{ mA}$, $I_B = -2.0 \text{ mA}$)	$V_{BE(sat)}$	—	-2.0	Vdc
DYNAMIC CHARACTERISTICS				
Current–Gain — Bandwidth Product ($I_C = -10 \text{ mAdc}$, $V_{CE} = -20 \text{ Vdc}$, $f = 20 \text{ MHz}$)	f_T	50	—	MHz
Common–Emitter Feedback Capacitance ($V_{CB} = -100 \text{ Vdc}$, $I_E = 0$, $f = 1.0 \text{ MHz}$)	C_{re}	—	1.6	pF

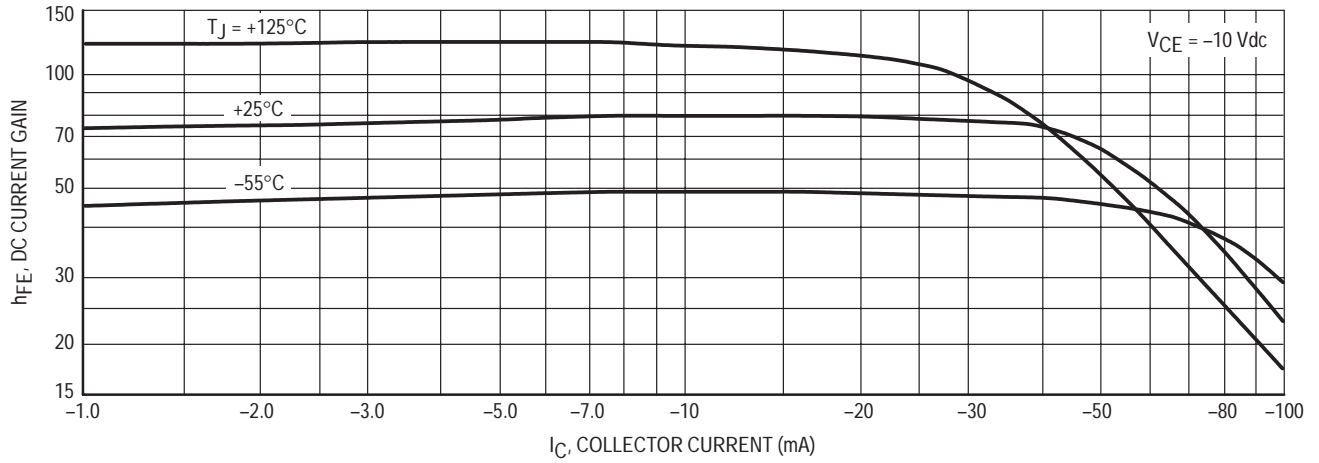


Figure 1. DC Current Gain

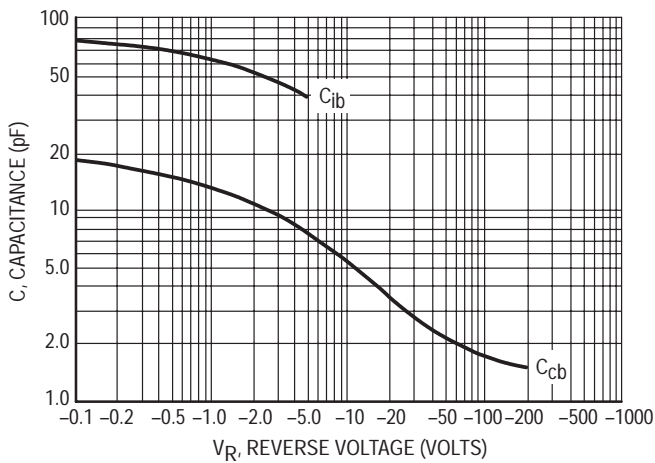


Figure 2. Capacitances

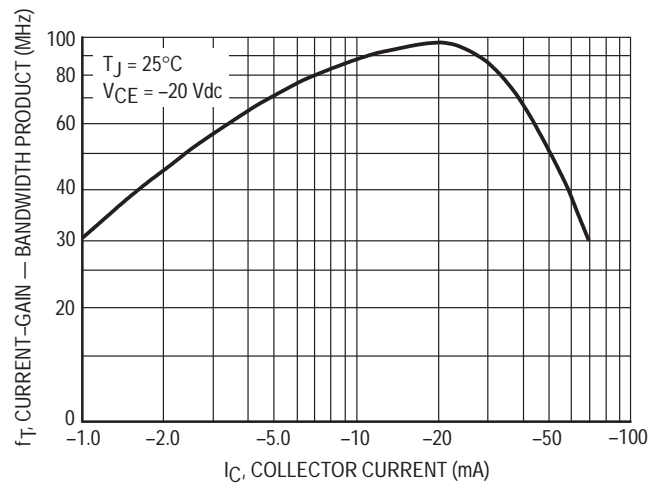


Figure 3. Current-Gain — Bandwidth Product

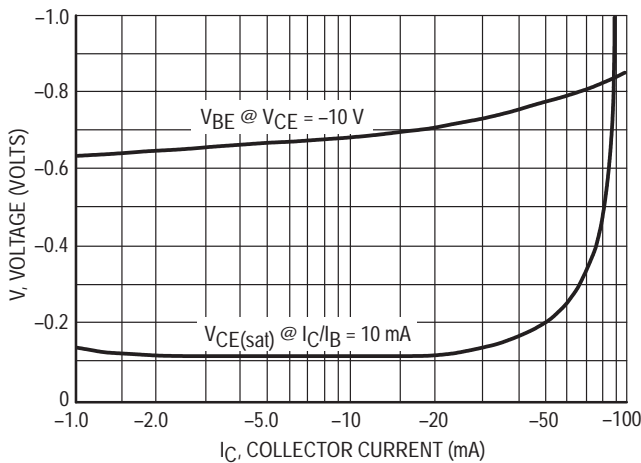


Figure 4. "On" Voltages

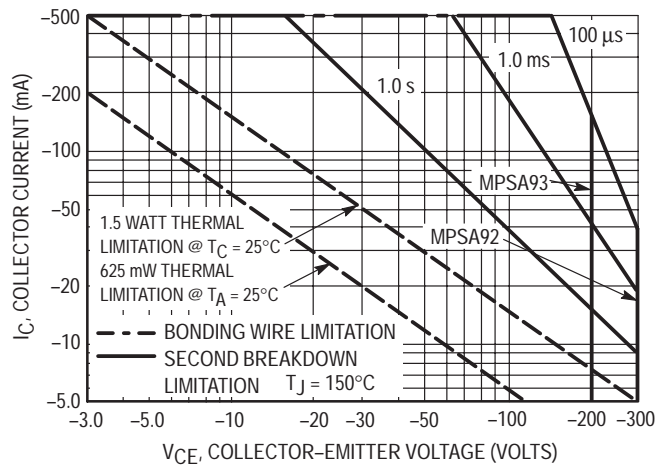
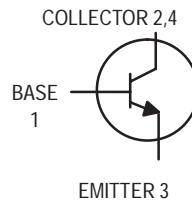


Figure 5. Active Region — Safe Operating Area

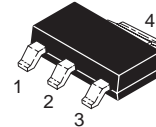
NPN Silicon Transistor



BF720T1

Motorola Preferred Device

**NPN SILICON
TRANSISTOR
SURFACE MOUNT**



**CASE 318E-04, STYLE 1
SOT-223 (TO-261AA)**

MAXIMUM RATINGS

Rating	Symbol	Value	Unit
Collector-Emitter Voltage	V_{CEO}	300	Vdc
Collector-Base Voltage	V_{CBO}	300	Vdc
Collector-Emitter Voltage	V_{CER}	300	Vdc
Emitter-Base Voltage	V_{EBO}	5.0	Vdc
Collector Current	I_C	100	mAdc
Total Power Dissipation up to $T_A = 25^\circ\text{C}$	P_D	1.5	Watts
Storage Temperature Range	T_{stg}	-65 to +150	$^\circ\text{C}$
Junction Temperature	T_J	150	$^\circ\text{C}$

DEVICE MARKING

DC

THERMAL CHARACTERISTICS

Characteristic	Symbol	Max	Unit
Thermal Resistance from Junction-to-Ambient(1)	$R_{\theta JA}$	83.3	$^\circ\text{C}/\text{W}$

ELECTRICAL CHARACTERISTICS ($T_A = 25^\circ\text{C}$ unless otherwise noted)

Characteristics	Symbol	Min	Max	Unit
-----------------	--------	-----	-----	------

OFF CHARACTERISTICS

Collector-Emitter Breakdown Voltage ($I_C = 1.0 \text{ mAdc}$, $I_E = 0$)	$V_{(BR)CEO}$	300	—	Vdc
Collector-Base Breakdown Voltage ($I_C = 100 \mu\text{Adc}$, $I_E = 0$)	$V_{(BR)CBO}$	300	—	Vdc
Collector-Emitter Breakdown Voltage ($I_C = 100 \mu\text{Adc}$, $R_{BE} = 2.7 \text{ k}\Omega$)	$V_{(BR)CER}$	300	—	Vdc
Emitter-Base Breakdown Voltage ($I_E = 10 \mu\text{Adc}$, $I_C = 0$)	$V_{(BR)EBO}$	5.0	—	Vdc
Collector-Base Cutoff Current ($V_{CB} = 200 \text{ Vdc}$, $I_E = 0$)	I_{CBO}	—	10	nAdc
Collector-Emitter Cutoff Current ($V_{CE} = 250 \text{ Vdc}$, $R_{BE} = 2.7 \text{ k}\Omega$) ($V_{CE} = 200 \text{ Vdc}$, $R_{BE} = 2.7 \text{ k}\Omega$, $T_J = 150^\circ\text{C}$)	I_{CER}	—	50 10	nAdc μAdc

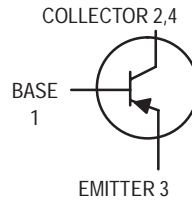
1. Device mounted on a glass epoxy printed circuit board 1.575 in. x 1.575 in. x 0.059 in.; mounting pad for the collector lead min. 0.93 in².

Preferred devices are Motorola recommended choices for future use and best overall value.

ELECTRICAL CHARACTERISTICS ($T_A = 25^\circ\text{C}$ unless otherwise noted) (Continued)

Characteristic	Symbol	Min	Max	Unit
ON CHARACTERISTICS				
DC Current Gain ($I_C = 25 \text{ mA}$, $V_{CE} = 20 \text{ V}$)	h_{FE}	50	—	—
Collector-Emitter Saturation Voltage ($I_C = 30 \text{ mA}$, $I_B = 5.0 \text{ mA}$)	$V_{CE(sat)}$	—	0.6	Vdc
DYNAMIC CHARACTERISTICS				
Current-Gain — Bandwidth Product ($I_C = 10 \text{ mA}$, $V_{CE} = 10 \text{ V}$, $f = 35 \text{ MHz}$)	f_T	60	—	MHz
Feedback Capacitance ($V_{CE} = 30 \text{ V}$, $I_C = 0$, $f = 1.0 \text{ MHz}$)	C_{re}	—	1.6	pF

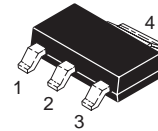
PNP Silicon Transistor



BF721T1

Motorola Preferred Device

**PNP SILICON
TRANSISTOR
SURFACE MOUNT**



**CASE 318E-04, STYLE 1
SOT-223 (TO-261AA)**

MAXIMUM RATINGS

Rating	Symbol	Value	Unit
Collector-Emitter Voltage	V_{CEO}	-300	Vdc
Collector-Base Voltage	V_{CBO}	-300	Vdc
Collector-Emitter Voltage	V_{CER}	-300	Vdc
Emitter-Base Voltage	V_{EBO}	-5.0	Vdc
Collector Current	I_C	-100	mAdc
Total Power Dissipation up to $T_A = 25^\circ\text{C}^{(1)}$	P_D	1.5	Watts
Storage Temperature Range	T_{stg}	-65 to +150	$^\circ\text{C}$
Junction Temperature	T_J	150	$^\circ\text{C}$

DEVICE MARKING

DF

THERMAL CHARACTERISTICS

Characteristic	Symbol	Max	Unit
Thermal Resistance from Junction to Ambient ⁽¹⁾	$R_{\theta JA}$	83.3	$^\circ\text{C}/\text{W}$

ELECTRICAL CHARACTERISTICS ($T_A = 25^\circ\text{C}$ unless otherwise noted)

Characteristic	Symbol	Min	Max	Unit
----------------	--------	-----	-----	------

OFF CHARACTERISTICS

Collector-Emitter Breakdown Voltage ($I_C = -1.0 \text{ mAdc}$, $I_E = 0$)	$V_{(BR)CEO}$	-300	—	Vdc
Collector-Base Breakdown Voltage ($I_C = -100 \mu\text{Adc}$, $I_E = 0$)	$V_{(BR)CBO}$	-300	—	Vdc
Collector-Emitter Breakdown Voltage ($I_C = -100 \mu\text{Adc}$, $R_{BE} = 2.7 \text{ k}\Omega$)	$V_{(BR)CER}$	-300	—	Vdc
Emitter-Base Breakdown Voltage ($I_E = -10 \mu\text{Adc}$, $I_C = 0$)	$V_{(BR)EBO}$	-5.0	—	Vdc
Collector-Base Cutoff Current ($V_{CB} = -200 \text{ Vdc}$, $I_E = 0$)	I_{CBO}	—	-10	nAdc
Collector-Emitter Cutoff Current ($V_{CE} = -250 \text{ Vdc}$, $R_{BE} = 2.7 \text{ k}\Omega$) ($V_{CE} = -200 \text{ Vdc}$, $R_{BE} = 2.7 \text{ k}\Omega$, $T_J = 150^\circ\text{C}$)	I_{CER}	—	-50 -10	nAdc μAdc

1. Device mounted on a glass epoxy printed circuit board 1.575 in. x 1.575 in. x 0.059 in.; mounting pad for the collector lead min. 0.93 in².

Preferred devices are Motorola recommended choices for future use and best overall value.

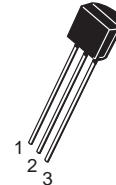
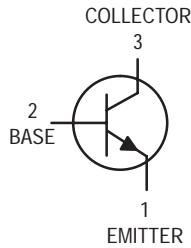
ELECTRICAL CHARACTERISTICS ($T_A = 25^\circ\text{C}$ unless otherwise noted) (Continued)

Characteristic	Symbol	Min	Max	Unit
ON CHARACTERISTICS				
DC Current Gain ($V_{CE} = -25\text{ mAdc}$, $V_{CE} = -20\text{ Vdc}$)	h_{FE}	50	—	—
Collector-Emitter Saturation Voltage ($I_C = -30\text{ mAdc}$, $I_B = -5.0\text{ mAdc}$)	$V_{CE(\text{sat})}$	—	-0.8	Vdc
DYNAMIC CHARACTERISTICS				
Current-Gain — Bandwidth Product ($V_{CE} = -10\text{ Vdc}$, $I_C = -10\text{ mAdc}$, $f = 35\text{ MHz}$)	f_T	60	—	MHz
Feedback Capacitance ($V_{CE} = -30\text{ Vdc}$, $I_C = 0$, $f = 1.0\text{ MHz}$)	C_{re}	—	1.6	pF

High Voltage Transistor

NPN Silicon

BF844



CASE 29-04, STYLE 1
TO-92 (TO-226AA)

MAXIMUM RATINGS

Rating	Symbol	Value	Unit
Collector–Emitter Voltage	V_{CEO}	400	Vdc
Collector–Base Voltage	V_{CBO}	450	Vdc
Emitter–Base Voltage	V_{EBO}	6.0	Vdc
Collector Current — Continuous	I_C	300	mAdc
Total Device Dissipation @ $T_A = 25^\circ\text{C}$ Derate above 25°C	P_D	625 5.0	mW mW/ $^\circ\text{C}$
Total Device Dissipation @ $T_C = 25^\circ\text{C}$ Derate above 25°C	P_D	1.5 12	Watt mW/ $^\circ\text{C}$
Operating and Storage Junction Temperature Range	T_J, T_{stg}	-55 to +150	$^\circ\text{C}$

THERMAL CHARACTERISTICS

Characteristic	Symbol	Max	Unit
Thermal Resistance, Junction to Ambient	$R_{\theta JA}$	200	$^\circ\text{C}/\text{W}$
Thermal Resistance, Junction to Case	$R_{\theta JC}$	83.3	$^\circ\text{C}/\text{W}$

ELECTRICAL CHARACTERISTICS ($T_A = 25^\circ\text{C}$ unless otherwise noted)

Characteristic	Symbol	Min	Max	Unit
----------------	--------	-----	-----	------

OFF CHARACTERISTICS

Collector–Emitter Breakdown Voltage ⁽¹⁾ ($I_C = 1.0 \text{ mAdc}, I_B = 0$)	$V_{(BR)CEO}$	400	—	Vdc
Collector–Emitter Breakdown Voltage ($I_C = 100 \mu\text{Adc}, V_{BE} = 0$)	$V_{(BR)CES}$	450	—	Vdc
Collector–Base Breakdown Voltage ($I_C = 100 \mu\text{Adc}, I_E = 0$)	$V_{(BR)CBO}$	450	—	Vdc
Emitter–Base Breakdown Voltage ($I_E = 10 \mu\text{Adc}, I_C = 0$)	$V_{(BR)EBO}$	6.0	—	Vdc
Collector Cutoff Current ($V_{CB} = 400 \text{ Vdc}, I_E = 0$)	I_{CBO}	—	0.1	μAdc
Collector Cutoff Current ($V_{CE} = 400 \text{ Vdc}, V_{BE} = 0$)	I_{CES}	—	500	nAdc
Emitter Cutoff Current ($V_{EB} = 4.0 \text{ Vdc}, I_C = 0$)	I_{EBO}	—	0.1	μAdc

1. Pulse Test: Pulse Width $\leq 300 \mu\text{s}$, Duty Cycle $\leq 2.0\%$.

ELECTRICAL CHARACTERISTICS ($T_A = 25^\circ\text{C}$ unless otherwise noted) (Continued)

Characteristic	Symbol	Min	Max	Unit
ON CHARACTERISTICS				
DC Current Gain ⁽¹⁾ ($I_C = 1.0\text{ mAdc}$, $V_{CE} = 10\text{ Vdc}$) ($I_C = 10\text{ mAdc}$, $V_{CE} = 10\text{ Vdc}$) ($I_C = 50\text{ mAdc}$, $V_{CE} = 10\text{ Vdc}$) ($I_C = 100\text{ mAdc}$, $V_{CE} = 10\text{ Vdc}$)	h_{FE}	40 50 45 20	— 200 — —	—
Collector–Emitter Saturation Voltage ⁽¹⁾ ($I_C = 1.0\text{ mAdc}$, $I_B = 0.1\text{ mAdc}$) ($I_C = 10\text{ mAdc}$, $I_B = 1.0\text{ mAdc}$) ($I_C = 50\text{ mAdc}$, $I_B = 5.0\text{ mAdc}$)	$V_{CE(sat)}$	— — —	0.4 0.5 0.75	Vdc
Base–Emitter Saturation Voltage ($I_C = 10\text{ mAdc}$, $I_B = 1.0\text{ mAdc}$)	$V_{BE(sat)}$	—	0.75	Vdc
DYNAMIC CHARACTERISTICS				
High Frequency Current Gain ($I_C = 10\text{ mAdc}$, $V_{CE} = 10\text{ Vdc}$, $f = 20\text{ MHz}$)	$ h_{fe} $	1.0	—	
Collector–Base Capacitance ($V_{CB} = 20\text{ Vdc}$, $I_E = 0$, $f = 1.0\text{ MHz}$)	C_{ob}	—	6.0	pF
Emitter–Base Capacitance ($V_{EB} = 0.5\text{ Vdc}$, $I_C = 0$, $f = 1.0\text{ MHz}$)	C_{ib}	—	110	pF
Turn–On Time ($V_{CC} = 150\text{ Vdc}$, $V_{BE(off)} = 4.0\text{ V}$, $I_C = 30\text{ mAdc}$, $I_{B1} = 3.0\text{ mAdc}$)	t_{on}	—	0.6	μs
Turn–Off Time ($V_{CC} = 150\text{ Vdc}$, $I_C = 30\text{ mAdc}$, $I_{B1} = I_{B2} = 3.0\text{ mAdc}$)	t_{off}	—	10	μs

1. Pulse Test: Pulse Width $\leq 300\ \mu\text{s}$, Duty Cycle $\leq 2.0\%$.

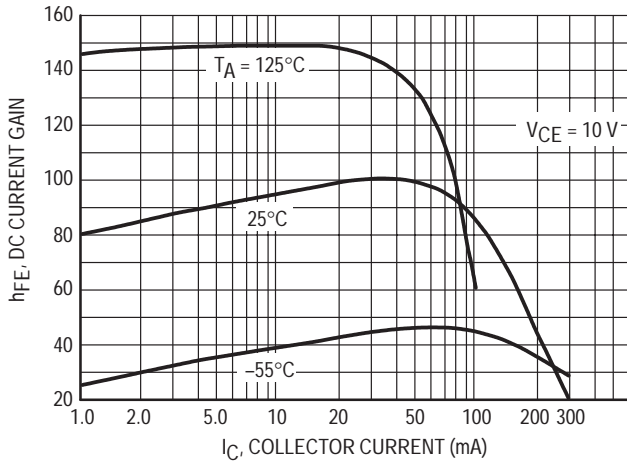


Figure 1. DC Current Gain

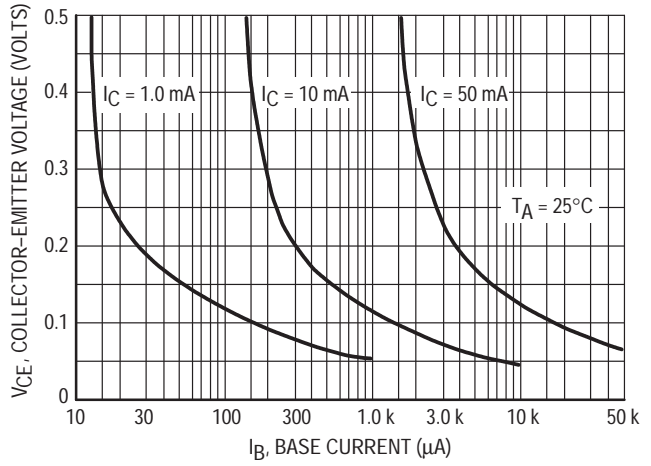


Figure 2. Collector Saturation Region

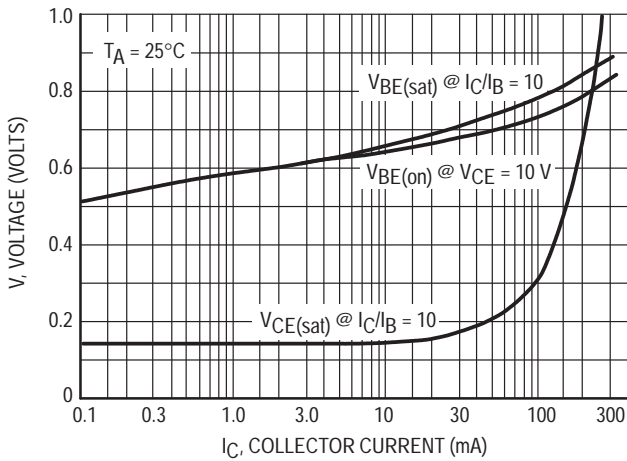


Figure 3. On Voltages

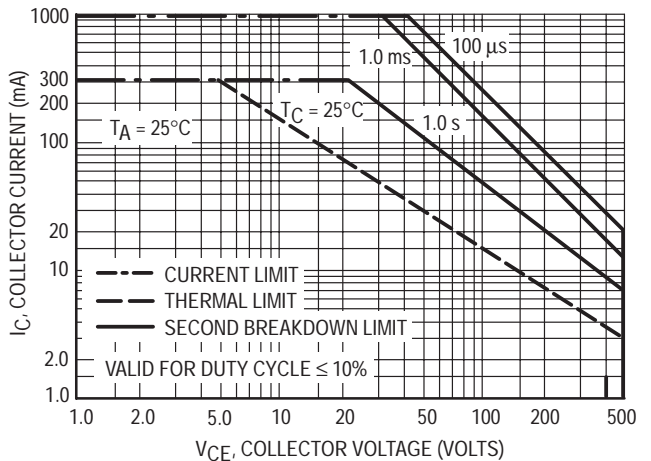


Figure 4. Active Region Safe Operating Area

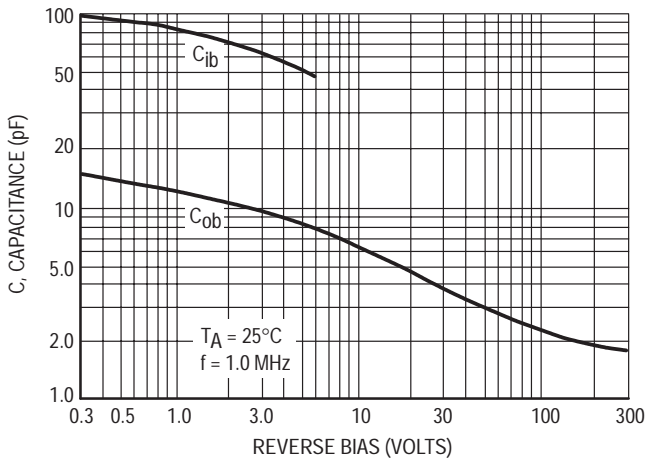


Figure 5. Capacitance

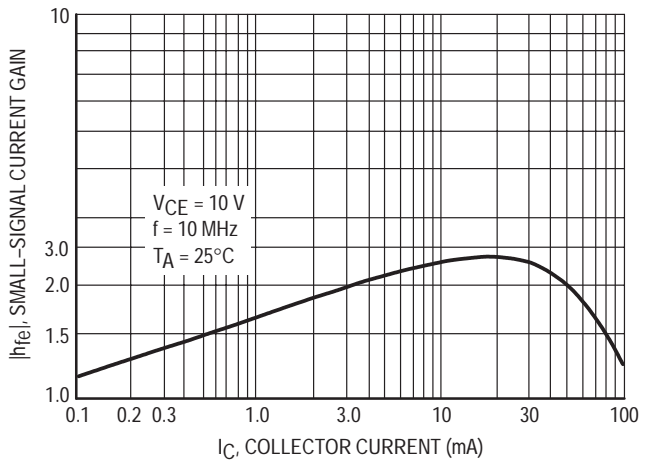


Figure 6. High Frequency Current Gain

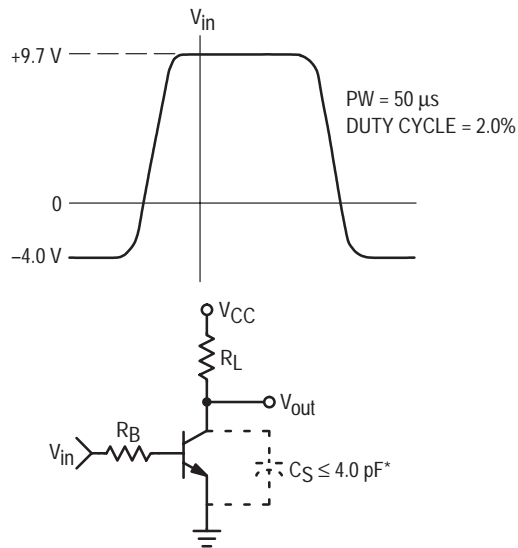
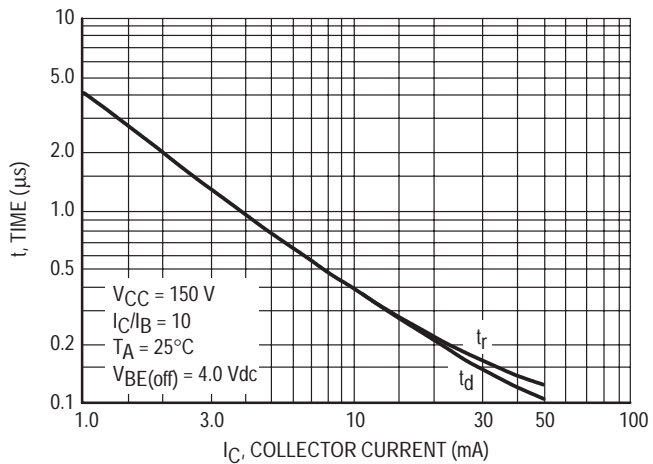


Figure 7. Turn-On Switching Times and Test Circuit

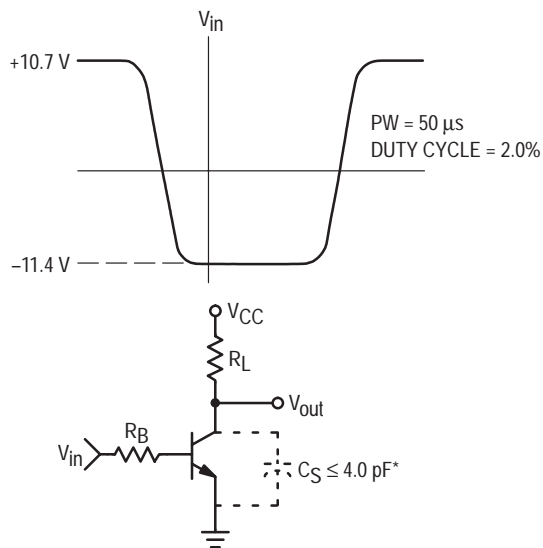
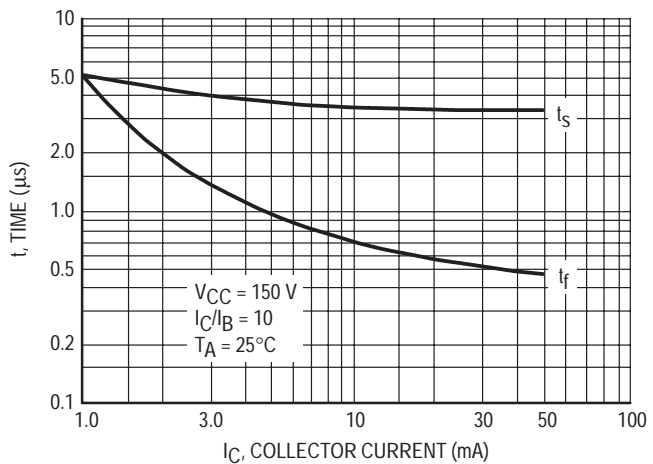
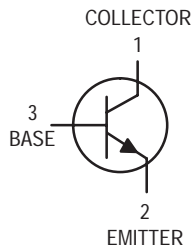


Figure 8. Turn-Off Switching Times and Test Circuit

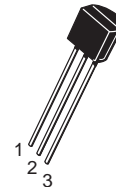
* Total Shunt Capacitance of Test Jig and Connectors.

VHF Transistor

NPN Silicon



BF959



CASE 29-04, STYLE 21
TO-92 (TO-226AA)

MAXIMUM RATINGS

Rating	Symbol	Value	Unit
Collector–Emitter Voltage	V_{CEO}	20	Vdc
Collector–Base Voltage	V_{CBO}	30	Vdc
Emitter–Base Voltage	V_{EBO}	3.0	Vdc
Collector Current — Continuous	I_C	100	mAdc
Total Device Dissipation @ $T_A = 25^\circ\text{C}$ Derate above 25°C	P_D	625 5.0	mW mW/ $^\circ\text{C}$
Total Device Dissipation @ $T_C = 25^\circ\text{C}$ Derate above 25°C	P_D	1.5 12	Watt mW/ $^\circ\text{C}$
Operating and Storage Junction Temperature Range	T_J, T_{stg}	-55 to +150	$^\circ\text{C}$

THERMAL CHARACTERISTICS

Characteristic	Symbol	Max	Unit
Thermal Resistance, Junction to Ambient	$R_{\theta JA}$	200	$^\circ\text{C}/\text{W}$
Thermal Resistance, Junction to Case	$R_{\theta JC}$	83.3	$^\circ\text{C}/\text{W}$

ELECTRICAL CHARACTERISTICS ($T_A = 25^\circ\text{C}$ unless otherwise noted)

Characteristic	Symbol	Min	Typ	Max	Unit
----------------	--------	-----	-----	-----	------

OFF CHARACTERISTICS

Collector–Emitter Breakdown Voltage ($I_C = 1.0$ mAdc, $I_B = 0$)	$V_{(BR)CEO}$	20	—	—	Vdc
Collector–Base Breakdown Voltage ($I_C = 10$ μ Adc, $I_E = 0$)	$V_{(BR)CBO}$	30	—	—	Vdc
Emitter–Base Breakdown Voltage ($I_E = 10$ μ Adc, $I_C = 0$)	$V_{(BR)EBO}$	3.0	—	—	Vdc
Collector Cutoff Current ($V_{CB} = 20$ Vdc, $I_E = 0$)	I_{CBO}	—	—	100	nAdc

ON CHARACTERISTICS

DC Current Gain ($I_C = 5.0$ mAdc, $V_{CE} = 10$ Vdc) ($I_C = 20$ mAdc, $V_{CE} = 10$ Vdc)	h_{FE}	35 40	— —	— —	—
Collector–Emitter Saturation Voltage ($I_C = 30$ mAdc, $I_B = 2.0$ mAdc)	$V_{CE(sat)}$	—	—	1.0	Vdc
Base–Emitter Saturation Voltage ($I_C = 30$ mAdc, $I_B = 2.0$ mAdc)	$V_{BE(sat)}$	—	—	1.0	Vdc

SMALL-SIGNAL CHARACTERISTICS

Current–Gain — Bandwidth Product ($I_C = 20$ mAdc, $V_{CE} = 10$ Vdc, $f = 100$ MHz) ($I_C = 30$ mAdc, $V_{CE} = 10$ Vdc, $f = 100$ MHz)	f_T	700 600	— —	— —	MHz
Common Emitter Feedback Capacitance ($V_{CB} = 10$ Vdc, $P_f = 0$, $f = 10$ MHz)	C_{re}	—	0.65	—	pF
Noise Figure ($I_C = 4.0$ mA, $V_{CE} = 10$ V, $R_S = 50$ Ω , $f = 200$ MHz)	N_f	—	3.0	—	dB

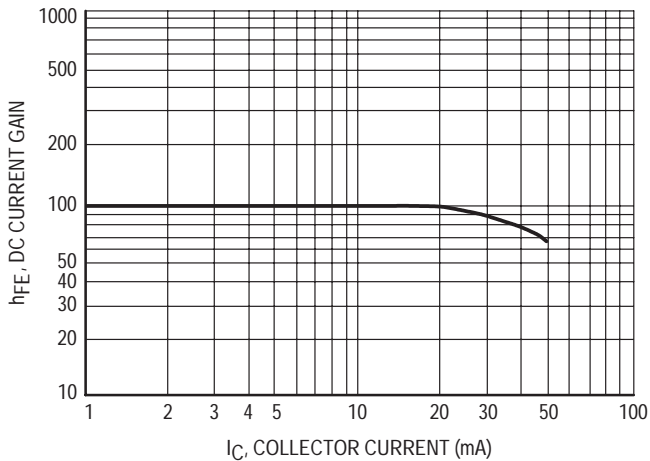


Figure 1. h_{FE} at 10 V

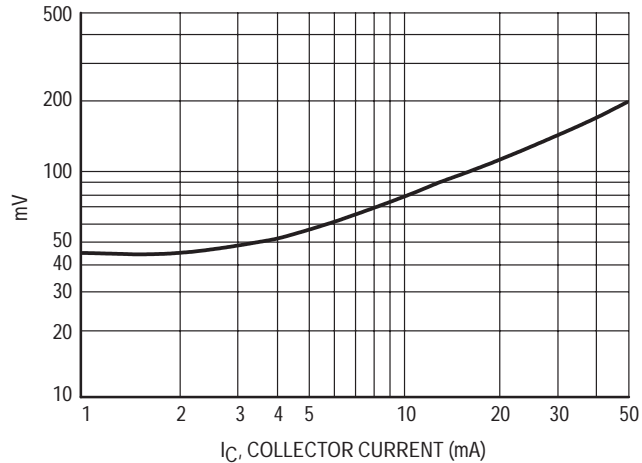


Figure 2. $V_{CE(sat)}$ at $I_C/I_B = 10$

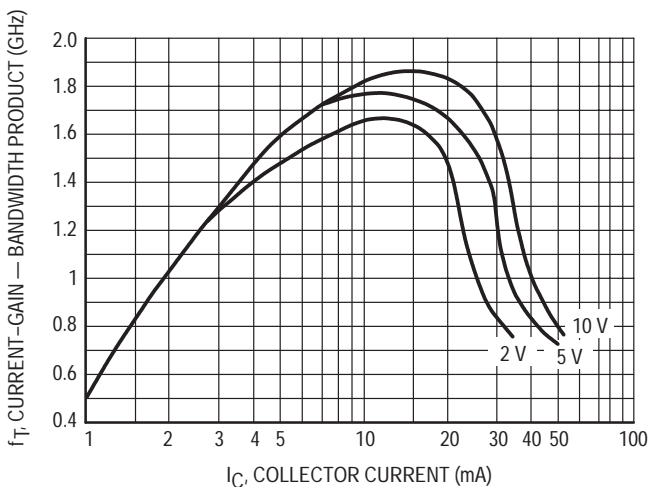


Figure 3. Current-Gain — Bandwidth Product

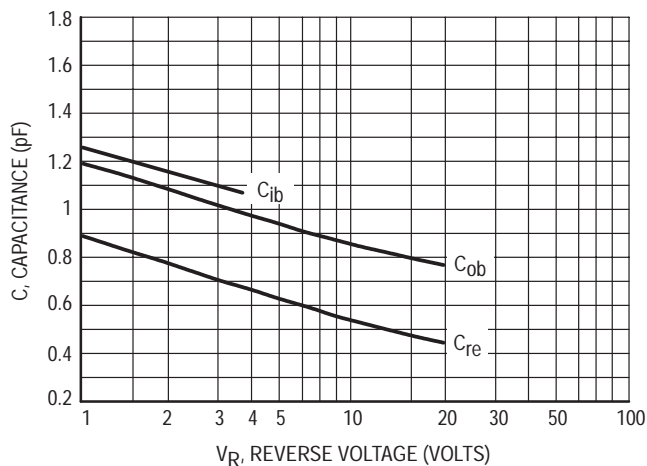


Figure 4. Capacitances

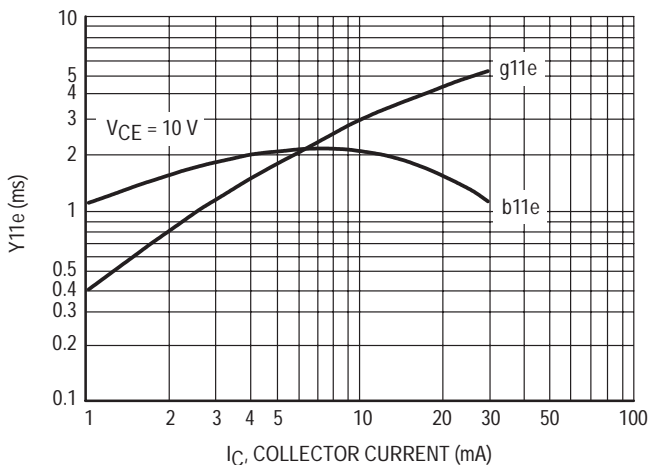


Figure 5. Input Impedance at 30 MHz

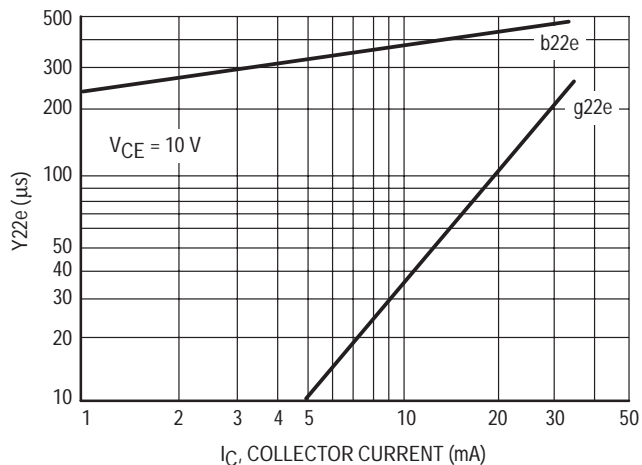


Figure 6. Output Impedance at 30 MHz

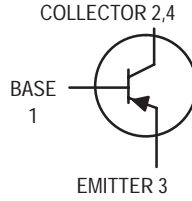
SOT-223 Package

High Voltage Transistor

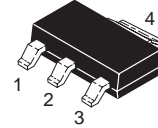
PNP Silicon

BSP16T1

Motorola Preferred Device



SOT-223 PACKAGE
PNP SILICON
HIGH VOLTAGE
TRANSISTOR
SURFACE MOUNT



CASE 318E-04, STYLE 1
TO-261AA

MAXIMUM RATINGS

Rating	Symbol	Value	Unit
Collector–Emitter Voltage	V_{CEO}	–300	Vdc
Collector–Base Voltage	V_{CBO}	–350	Vdc
Emitter–Base Voltage	V_{EBO}	–6.0	Vdc
Collector Current	I_C	–1000	mAdc
Base Current	I_B	–500	mAdc
Total Device Dissipation, $T_A = 25^\circ\text{C}$ (1)	P_D	1.5	Watts
Storage Temperature Range	T_{stg}	–65 to +150	$^\circ\text{C}$
Junction Temperature	T_J	150	$^\circ\text{C}$

DEVICE MARKING

BT2

THERMAL CHARACTERISTICS

Characteristic	Symbol	Max	Unit
Thermal Resistance, Junction to Ambient	$R_{\theta JA}$	83.3	$^\circ\text{C}/\text{W}$

ELECTRICAL CHARACTERISTICS ($T_A = 25^\circ\text{C}$ unless otherwise noted)

Characteristic	Symbol	Min	Max	Unit
----------------	--------	-----	-----	------

OFF CHARACTERISTICS

Collector–Emitter Breakdown Voltage ($I_C = -50$ mAdc, $I_B = 0$, $L = 25$ mH)	$V_{(BR)CEO}$	–300	—	Vdc
Collector–Base Breakdown Voltage ($I_C = -100$ μAdc , $I_E = 0$)	$V_{(BR)CBO}$	–300	—	Vdc
Collector–Emitter Cutoff Current ($V_{CE} = -250$ Vdc, $I_B = 0$)	I_{CES}	—	–50	μAdc
Collector–Base Cutoff Current ($V_{CB} = -280$ Vdc, $I_E = 0$)	I_{CBO}	—	–1.0	μAdc
Emitter–Base Cutoff Current ($V_{EB} = -6.0$ Vdc, $I_C = 0$)	I_{EBO}	—	–20	μAdc

1. Device mounted on a glass epoxy printed circuit board 1.575 in. x 1.575 in. x 0.059 in.; mounting pad for the collector lead min. 0.93 sq. in.

Preferred devices are Motorola recommended choices for future use and best overall value.

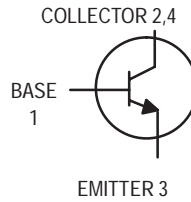
ELECTRICAL CHARACTERISTICS (continued) ($T_A = 25^\circ\text{C}$ unless otherwise noted)

Characteristics	Symbol	Min	Max	Unit
ON CHARACTERISTICS				
DC Current Gain ($V_{CE} = -10\text{ Vdc}$, $I_C = -50\text{ mAdc}$)	h_{FE}	30	120	—
Collector-Emitter Saturation Voltage ($I_C = -50\text{ mAdc}$, $I_B = -5.0\text{ mAdc}$)	$V_{CE(sat)}$	—	-2.0	Vdc
DYNAMIC CHARACTERISTICS				
Current Gain – Bandwidth Product ($V_{CE} = -10\text{ Vdc}$, $I_C = -10\text{ mAdc}$, $f = 30\text{ MHz}$)	f_T	15	—	MHz
Collector–Base Capacitance ($V_{CB} = -10\text{ Vdc}$, $I_E = 0$, $f = 1.0\text{ MHz}$)	C_{obo}	—	15	pF

NPN Silicon Epitaxial Transistor

This family of NPN Silicon Epitaxial transistors is designed for use as a general purpose amplifier and in switching applications. The device is housed in the SOT-223 package which is designed for medium power surface mount applications.

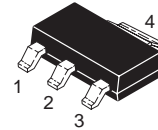
- High Voltage: $V_{(BR)CEO}$ of 250 and 350 Volts.
- The SOT-223 package can be soldered using wave or reflow.
- SOT-223 package ensures level mounting, resulting in improved thermal conduction, and allows visual inspection of soldered joints. The formed leads absorb thermal stress during soldering, eliminating the possibility of damage to the die
- Available in 12 mm Tape and Reel
T1 Configuration – 7 inch/1000 unit reel
T3 Configuration – 13 inch/4000 unit reel
- PNP Complement is BSP16T1



BSP19AT1

Motorola Preferred Device

**SOT-223 PACKAGE
NPN SILICON
HIGH VOLTAGE
TRANSISTOR
SURFACE MOUNT**



**CASE 318E-04, STYLE 1
TO-261AA**

MAXIMUM RATINGS ($T_C = 25^\circ\text{C}$ unless otherwise noted)

Rating	Symbol	Value	Unit
Collector-Emitter Voltage (Open Base)	V_{CEO}	350	Vdc
Collector-Base Voltage (Open Emitter)	V_{CBO}	400	Vdc
Emitter-Base Voltage (Open Collector)	V_{EBO}	5.0	Vdc
Collector Current (DC)	I_C	1000	mAdc
Total Power Dissipation @ $T_A = 25^\circ\text{C}^{(1)}$ Derate above 25°C	P_D	0.8 6.4	Watts mW/ $^\circ\text{C}$
Storage Temperature Range	T_{stg}	-65 to 150	$^\circ\text{C}$
Junction Temperature	T_J	150	$^\circ\text{C}$

DEVICE MARKING

SP19A

THERMAL CHARACTERISTICS

Characteristic	Symbol	Max	Unit
Thermal Resistance from Junction-to-Ambient	$R_{\theta JA}$	156	$^\circ\text{C}/\text{W}$
Maximum Temperature for Soldering Purposes Time in Solder Bath	T_L	260 10	$^\circ\text{C}$ Sec

1. Device mounted on a FR-4 glass epoxy printed circuit board using minimum recommended footprint.

Preferred devices are Motorola recommended choices for future use and best overall value.

ELECTRICAL CHARACTERISTICS (continued) ($T_A = 25^\circ\text{C}$ unless otherwise noted)

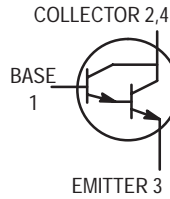
Characteristics	Symbol	Min	Max	Unit
OFF CHARACTERISTICS				
Collector-Emitter Breakdown Voltage ($I_C = 1.0\text{ mAdc}$, $I_B = 0$)	$V_{(BR)CEO}$	350	—	Vdc
Collector-Base Cutoff Current ($V_{CB} = 400\text{ Vdc}$, $I_E = 0$)	I_{CBO}	—	20	nAdc
Emitter-Base Cutoff Current ($V_{EB} = 5.0\text{ Vdc}$, $I_C = 0$)	I_{EBO}	—	10	μAdc
ON CHARACTERISTICS (2)				
DC Current Gain ($I_C = 20\text{ mAdc}$, $V_{CE} = 10\text{ Vdc}$)	h_{FE}	40	—	—
Current-Gain — Bandwidth Product ($I_C = 10\text{ mAdc}$, $V_{CE} = 10\text{ Vdc}$, $f = 5.0\text{ MHz}$)	f_T	70	—	MHz
Collector-Emitter Saturation Voltage ($I_C = 50\text{ mAdc}$, $I_B = 4.0\text{ mAdc}$)	$V_{CE(sat)}$	—	0.5	Vdc
Base-Emitter Saturation Voltage ($I_C = 50\text{ mAdc}$, $I_B = 4.0\text{ mAdc}$)	$V_{BE(sat)}$	—	1.3	Vdc

2. Pulse Test: Pulse Width $\leq 300\ \mu\text{s}$, Duty Cycle = 2.0%

NPN Small-Signal Darlington Transistor

This NPN small signal darlington transistor is designed for use in switching applications, such as print hammer, relay, solenoid and lamp drivers. The device is housed in the SOT-223 package, which is designed for medium power surface mount applications.

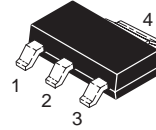
- The SOT-223 Package can be soldered using wave or reflow. The formed leads absorb thermal stress during soldering, eliminating the possibility of damage to the die
- Available in 12 mm Tape and Reel
Use BSP52T1 to order the 7 inch/1000 unit reel
Use BSP52T3 to order the 13 inch/4000 unit reel
- PNP Complement is BSP62T1



BSP52T1

Motorola Preferred Device

**MEDIUM POWER
NPN SILICON
DARLINGTON
TRANSISTOR
SURFACE MOUNT**



**CASE 318E-04, STYLE 1
TO-261AA**

MAXIMUM RATINGS (T_C = 25°C unless otherwise noted)

Rating	Symbol	Value	Unit
Collector-Emitter Voltage	V _{CES}	80	Vdc
Collector-Base Voltage	V _{CBO}	90	Vdc
Emitter-Base Voltage	V _{EBO}	5.0	Vdc
Collector Current	I _C	500	mA _{dc}
Total Power Dissipation @ T _A = 25°C(1) Derate above 25°C	P _D	0.8 6.4	Watts mW/°C
Operating and Storage Temperature Range	T _J , T _{stg}	-65 to 150	°C

DEVICE MARKING

AS3

THERMAL CHARACTERISTICS

Characteristic	Symbol	Max	Unit
Thermal Resistance – Junction-to-Ambient (surface mounted)	R _{θJA}	156	°C/W
Maximum Temperature for Soldering Purposes Time in Solder Bath	T _L	260 10	°C Sec

1. Device mounted on a FR-4 glass epoxy printed circuit board using minimum recommended footprint.

Preferred devices are Motorola recommended choices for future use and best overall value.

ELECTRICAL CHARACTERISTICS (continued) ($T_A = 25^\circ\text{C}$ unless otherwise noted)

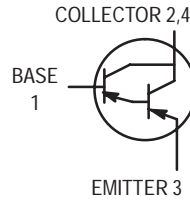
Characteristics	Symbol	Min	Max	Unit
OFF CHARACTERISTICS				
Collector-Base Breakdown Voltage ($I_C = 100 \mu\text{A}$, $I_E = 0$)	$V_{(BR)CBO}$	90	—	Vdc
Emitter-Base Breakdown Voltage ($I_E = 10 \mu\text{A}$, $I_C = 0$)	$V_{(BR)EBO}$	5.0	—	Vdc
Collector-Emitter Cutoff Current ($V_{CE} = 80 \text{ Vdc}$, $V_{BE} = 0$)	I_{CES}	—	10	μA
Emitter-Base Cutoff Current ($V_{EB} = 4.0 \text{ Vdc}$, $I_C = 0$)	I_{EBO}	—	10	μA
ON CHARACTERISTICS (2)				
DC Current Gain ($I_C = 150 \text{ mA}$, $V_{CE} = 10 \text{ Vdc}$) ($I_C = 500 \text{ mA}$, $V_{CE} = 10 \text{ Vdc}$)	h_{FE}	1000 2000	— —	—
Collector-Emitter Saturation Voltage ($I_C = 500 \text{ mA}$, $I_B = 0.5 \text{ mA}$)	$V_{CE(sat)}$	—	1.3	Vdc
Base-Emitter On Voltage ($I_C = 500 \text{ mA}$, $I_B = 0.5 \text{ mA}$)	$V_{BE(on)}$	—	1.9	Vdc

2. Pulse Test: Pulse Width $\leq 300 \mu\text{s}$, Duty Cycle $\leq 2.0\%$

PNP Small-Signal Darlington Transistor

This PNP small signal darlington transistor is designed for use in switching applications, such as print hammer, relay, solenoid and lamp drivers. The device is housed in the SOT-223 package which is designed for medium power surface mount applications.

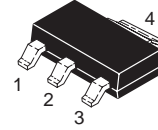
- The SOT-223 Package can be soldered using wave or reflow. The formed leads absorb thermal stress during soldering, eliminating the possibility of damage to the die
- Available in 12 mm Tape and Reel
Use BSP62T1 to order the 7 inch/1000 unit reel.
Use BSP62T3 to order the 13 inch/4000 unit reel.
- NPN Complement is BSP52T1



BSP62T1

Motorola Preferred Device

**MEDIUM POWER
PNP SILICON
DARLINGTON
TRANSISTOR
SURFACE MOUNT**



**CASE 318E-04, STYLE 1
TO-261AA**

MAXIMUM RATINGS (T_C = 25°C unless otherwise noted)

Rating	Symbol	Value	Unit
Collector-Emitter Voltage	V _{CES}	80	Vdc
Collector-Base Voltage	V _{CBO}	90	Vdc
Emitter-Base Voltage	V _{EBO}	5.0	Vdc
Collector Current	I _C	500	mAdc
Total Power Dissipation @ T _A = 25°C(1) Derate above 25°C	P _D	1.5 12	Watts mW/°C
Operating and Storage Temperature Range	T _J , T _{stg}	-65 to 150	°C

DEVICE MARKING

BS3

THERMAL CHARACTERISTICS

Characteristic	Symbol	Max	Unit
Thermal Resistance — Junction-to-Ambient (surface mounted)	R _{θJA}	83.3	°C/W
Maximum Temperature for Soldering Purposes Time in Solder Bath	T _L	260 10	°C Sec

1. Device mounted on a FR-4 glass epoxy printed circuit board 1.575 in. x 1.575 in. x 0.0625 in.; mounting pad for the collector lead = 0.93 sq. in.

Preferred devices are Motorola recommended choices for future use and best overall value.

ELECTRICAL CHARACTERISTICS (continued) ($T_A = 25^\circ\text{C}$ unless otherwise noted)

Characteristics	Symbol	Min	Max	Unit
OFF CHARACTERISTICS				
Collector-Base Breakdown Voltage ($I_C = 100\ \mu\text{A}$, $I_E = 0$)	$V_{(BR)CBO}$	90	—	Vdc
Emitter-Base Breakdown Voltage ($I_E = 10\ \mu\text{A}$, $I_C = 0$)	$V_{(BR)EBO}$	5.0	—	Vdc
Collector-Emitter Cutoff Current ($V_{CE} = 80\ \text{Vdc}$, $V_{BE} = 0$)	I_{CBO}	—	10	μA
Emitter-Base Cutoff Current ($V_{EB} = 4.0\ \text{Vdc}$, $I_C = 0$)	I_{EBO}	—	10	μA
ON CHARACTERISTICS (2)				
DC Current Gain ($I_C = 150\ \text{mA}$, $V_{CE} = 10\ \text{Vdc}$) ($I_C = 500\ \text{mA}$, $V_{CE} = 10\ \text{Vdc}$)	h_{FE}	1000 2000	— —	—
Collector-Emitter Saturation Voltage ($I_C = 500\ \text{mA}$, $I_B = 0.5\ \text{mA}$)	$V_{CE(sat)}$	—	1.3	Vdc
Base-Emitter On Voltage ($I_C = 500\ \text{mA}$, $I_B = 0.5\ \text{mA}$)	$V_{BE(on)}$	—	1.9	Vdc

2. Pulse Test: Pulse Width $\leq 300\ \mu\text{s}$, Duty Cycle $\leq 2.0\%$

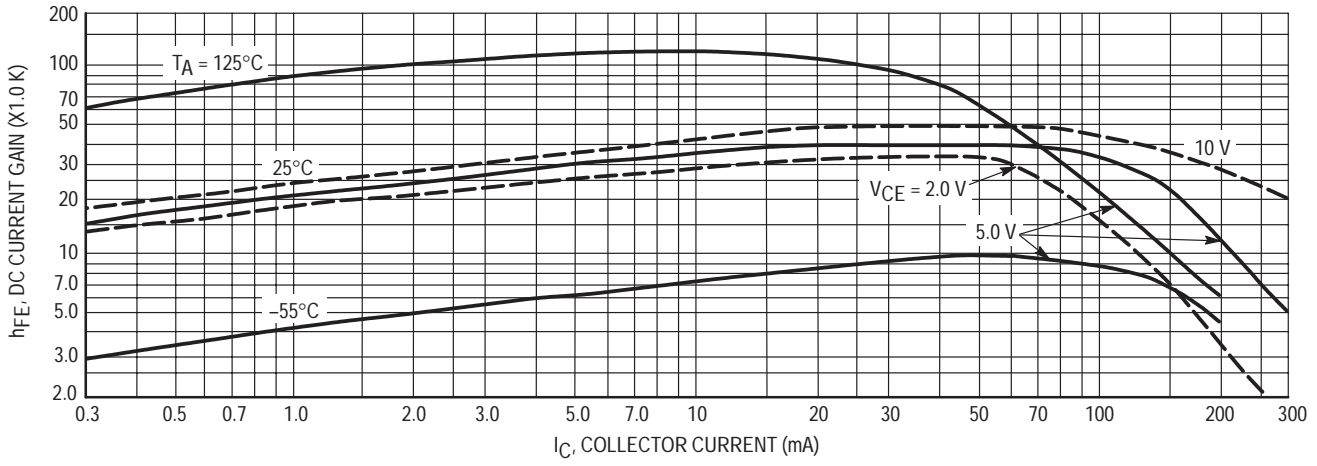


Figure 1. DC Current Gain

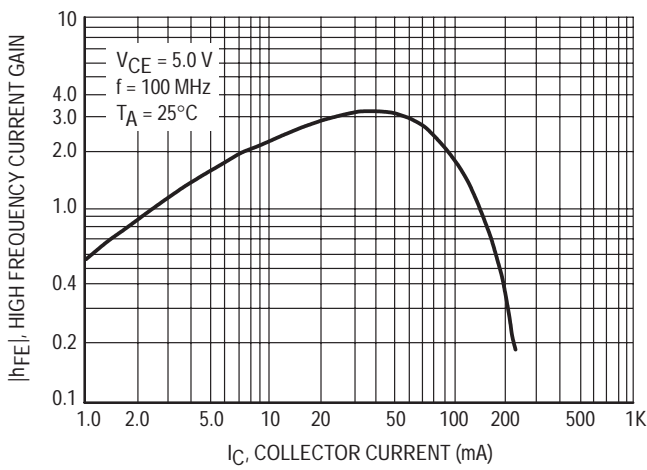


Figure 2. High Frequency Current Gain

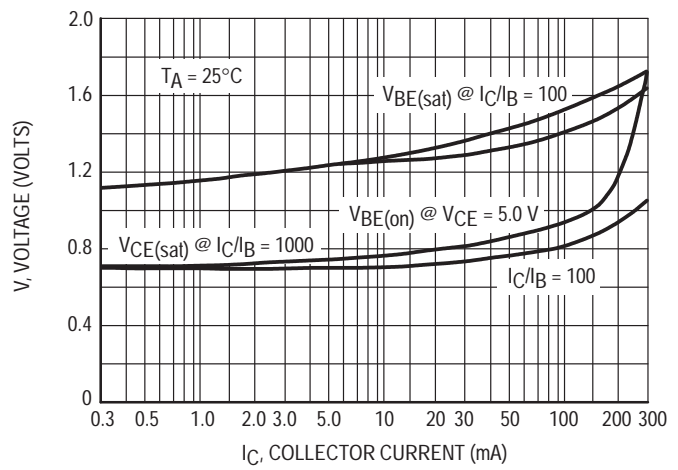


Figure 3. "On" Voltage

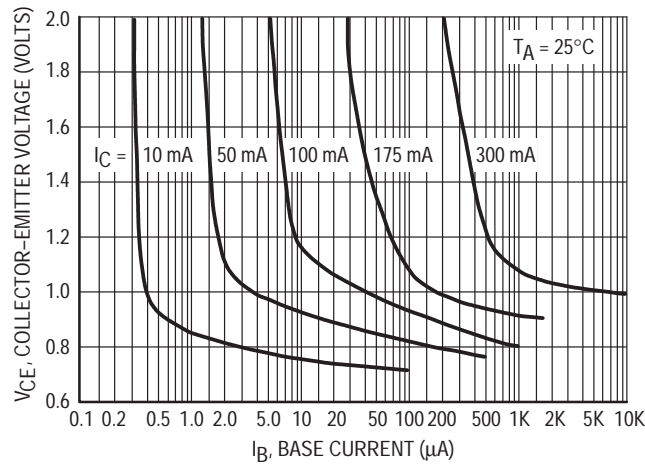
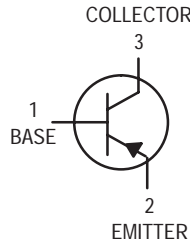


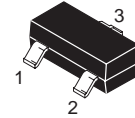
Figure 4. Collector Saturation Region

High Voltage Transistor

PNP Silicon



BSS63LT1



CASE 318-08, STYLE 6
SOT-23 (TO-236AB)

MAXIMUM RATINGS

Rating	Symbol	Value	Unit
Collector–Emitter Voltage	V_{CEO}	-100	Vdc
Collector–Emitter Voltage $R_{BE} = 10\text{ k}\Omega$	V_{CER}	-110	Vdc
Collector Current — Continuous	I_C	-100	mAdc

THERMAL CHARACTERISTICS

Characteristic	Symbol	Max	Unit
Total Device Dissipation FR-5 Board ⁽¹⁾ $T_A = 25^\circ\text{C}$ Derate above 25°C	P_D	225	mW
		1.8	mW/ $^\circ\text{C}$
Thermal Resistance Junction to Ambient	$R_{\theta JA}$	556	$^\circ\text{C}/\text{W}$
Total Device Dissipation Alumina Substrate, ⁽²⁾ $T_A = 25^\circ\text{C}$ Derate above 25°C	P_D	300	mW
		2.4	mW/ $^\circ\text{C}$
Thermal Resistance, Junction to Ambient	$R_{\theta JA}$	417	$^\circ\text{C}/\text{W}$
Junction and Storage Temperature	T_J, T_{stg}	-55 to +150	$^\circ\text{C}$

DEVICE MARKING

BSS63LT1 = T1

ELECTRICAL CHARACTERISTICS ($T_A = 25^\circ\text{C}$ unless otherwise noted)

Characteristic	Symbol	Min	Typ	Max	Unit
----------------	--------	-----	-----	-----	------

OFF CHARACTERISTICS

Collector–Emitter Breakdown Voltage ($I_C = -100\ \mu\text{Adc}$)	$V_{(BR)CEO}$	-100	—	—	Vdc
Collector–Emitter Breakdown Voltage ($I_C = -10\ \mu\text{Adc}, I_E = 0, R_{BE} = 10\text{ k}\Omega$)	$V_{(BR)CER}$	-110	—	—	Vdc
Collector–Base Breakdown Voltage ($I_E = -10\ \mu\text{Adc}, I_C = 0$)	$V_{(BR)CBO}$	-110	—	—	Vdc
Emitter–Base Breakdown Voltage ($I_E = -10\ \mu\text{Adc}$)	$V_{(BR)EBO}$	-6.0	—	—	Vdc
Collector Cutoff Current ($V_{CB} = -90\text{ Vdc}, I_E = 0$)	I_{CBO}	—	—	-100	nAdc
Collector Cutoff Current ($V_{CE} = -110\text{ Vdc}, R_{BE} = 10\text{ k}\Omega$)	I_{CER}	—	—	-10	μAdc
Emitter Cutoff Current ($V_{EB} = -6.0\text{ Vdc}, I_C = 0$)	I_{EBO}	—	—	-200	nAdc

1. FR-5 = $1.0 \times 0.75 \times 0.062\text{ in.}$

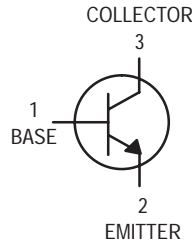
2. Alumina = $0.4 \times 0.3 \times 0.024\text{ in.}$ 99.5% alumina.

BSS63LT1**ELECTRICAL CHARACTERISTICS** ($T_A = 25^\circ\text{C}$ unless otherwise noted) (Continued)

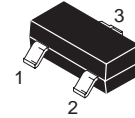
Characteristic	Symbol	Min	Typ	Max	Unit
ON CHARACTERISTICS					
DC Current Gain ($I_C = -10 \text{ mAdc}$, $V_{CE} = -1.0 \text{ Vdc}$) ($I_C = -25 \text{ mAdc}$, $V_{CE} = -1.0 \text{ Vdc}$)	h_{FE}	30 30	— —	— —	—
Collector–Emitter Saturation Voltage ($I_C = -25 \text{ mAdc}$, $I_B = -2.5 \text{ mAdc}$)	$V_{CE(\text{sat})}$	—	—	-250	mVdc
Base–Emitter Saturation Voltage ($I_C = -25 \text{ mAdc}$, $I_B = -2.5 \text{ mAdc}$)	$V_{BE(\text{sat})}$	—	—	-900	mVdc
SMALL–SIGNAL CHARACTERISTICS					
Current–Gain — Bandwidth Product ($I_C = -25 \text{ mAdc}$, $V_{CE} = -5.0 \text{ Vdc}$, $f = 20 \text{ MHz}$)	f_T	50	95	—	MHz
Case Capacitance ($I_E = I_C = 0$, $V_{CB} = -10 \text{ Vdc}$, $f = 1.0 \text{ MHz}$)	C_C	—	—	20	pF

Driver Transistor

NPN Silicon



BSS64LT1



CASE 318-08, STYLE 6
SOT-23 (TO-236AB)

MAXIMUM RATINGS

Rating	Symbol	Value	Unit
Collector–Emitter Voltage	V_{CEO}	80	Vdc
Collector–Base Voltage	V_{CBO}	120	Vdc
Emitter–Base Voltage	V_{EBO}	5.0	Vdc
Collector Current — Continuous	I_C	100	mAdc

THERMAL CHARACTERISTICS

Characteristic	Symbol	Max	Unit
Total Device Dissipation FR-5 Board ⁽¹⁾ $T_A = 25^\circ\text{C}$ Derate above 25°C	P_D	225	mW
		1.8	mW/ $^\circ\text{C}$
Thermal Resistance Junction to Ambient	$R_{\theta JA}$	556	$^\circ\text{C/W}$
Total Device Dissipation Alumina Substrate, ⁽²⁾ $T_A = 25^\circ\text{C}$ Derate above 25°C	P_D	300	mW
		2.4	mW/ $^\circ\text{C}$
Thermal Resistance Junction to Ambient	$R_{\theta JA}$	417	$^\circ\text{C/W}$
Junction and Storage Temperature	T_J, T_{stg}	-55 to +150	$^\circ\text{C}$

DEVICE MARKING

BSS64LT1 = AM

ELECTRICAL CHARACTERISTICS ($T_A = 25^\circ\text{C}$ unless otherwise noted)

Characteristic	Symbol	Min	Max	Unit
----------------	--------	-----	-----	------

OFF CHARACTERISTICS

Collector–Emitter Breakdown Voltage ($I_C = 4.0 \text{ mAdc}$)	$V_{(BR)CEO}$	80	—	Vdc
Collector–Base Breakdown Voltage ($I_C = 100 \mu\text{Adc}$)	$V_{(BR)CBO}$	120	—	Vdc
Emitter–Base Breakdown Voltage ($I_E = 100 \mu\text{Adc}$)	$V_{(BR)EBO}$	5.0	—	Vdc
Collector Cutoff Current ($V_{CE} = 90 \text{ Vdc}$) ($T_A = 150^\circ\text{C}$)	I_{CBO}	—	0.1 500	μAdc
Emitter Cutoff Current ($V_{EB} = 4.0 \text{ Vdc}$)	I_{EBO}	—	200	nAdc

1. FR-5 = $1.0 \times 0.75 \times 0.062 \text{ in.}$

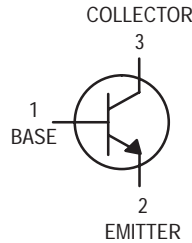
2. Alumina = $0.4 \times 0.3 \times 0.024 \text{ in.}$ 99.5% alumina.

BSS64LT1**ELECTRICAL CHARACTERISTICS** ($T_A = 25^\circ\text{C}$ unless otherwise noted) (Continued)

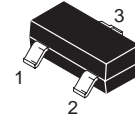
Characteristic	Symbol	Min	Max	Unit
ON CHARACTERISTICS				
DC Current Gain ($V_{CE} = 1.0 \text{ Vdc}$, $I_C = 10 \text{ mA}$)	H_{FE}	20	—	—
Collector–Emitter Saturation Voltage ($I_C = 4.0 \text{ mA}$, $I_B = 400 \mu\text{A}$) ($I_C = 50 \text{ mA}$, $I_B = 15 \text{ mA}$)	$V_{CE(sat)}$	— —	0.15 0.2	Vdc
Forward Base–Emitter Voltage	$V_{BE(sat)}$	—	—	—
SMALL–SIGNAL CHARACTERISTICS				
Current–Gain — Bandwidth Product ($I_C = 4.0 \text{ mA}$, $V_{CE} = 10 \text{ Vdc}$, $f = 20 \text{ MHz}$)	f_T	60	—	MHz
Output Capacitance ($V_{CB} = 10 \text{ Vdc}$, $f = 1.0 \text{ MHz}$)	C_{ob}	—	20	pF

Switching Transistor

NPN Silicon



BSV52LT1



CASE 318-08, STYLE 6
SOT-23 (TO-236AB)

MAXIMUM RATINGS

Rating	Symbol	Value	Unit
Collector-Emitter Voltage	V_{CEO}	12	Vdc
Collector-Base Voltage	V_{CBO}	20	Vdc
Collector Current — Continuous	I_C	100	mAdc

THERMAL CHARACTERISTICS

Characteristic	Symbol	Max	Unit
Total Device Dissipation FR-5 Board ⁽¹⁾ $T_A = 25^\circ\text{C}$ Derate above 25°C	P_D	225	mW
		1.8	mW/ $^\circ\text{C}$
Thermal Resistance Junction to Ambient	$R_{\theta JA}$	556	$^\circ\text{C}/\text{W}$
Total Device Dissipation Alumina Substrate, ⁽²⁾ $T_A = 25^\circ\text{C}$ Derate above 25°C	P_D	300	mW
		2.4	mW/ $^\circ\text{C}$
Thermal Resistance Junction to Ambient	$R_{\theta JA}$	417	$^\circ\text{C}/\text{W}$
Junction and Storage Temperature	T_J, T_{stg}	-55 to +150	$^\circ\text{C}$

DEVICE MARKING

BSV52LT1 = B2

ELECTRICAL CHARACTERISTICS ($T_A = 25^\circ\text{C}$ unless otherwise noted)

Characteristic	Symbol	Min	Max	Unit
----------------	--------	-----	-----	------

OFF CHARACTERISTICS

Collector-Emitter Breakdown Voltage ($I_C = 1.0$ mAdc)	$V_{(BR)CEO}$	12	—	Vdc
Collector Cutoff Current ($V_{CB} = 10$ Vdc, $I_E = 0$) ($V_{CB} = 10$ Vdc, $I_E = 0$, $T_A = 125^\circ\text{C}$)	I_{CBO}	—	100	nAdc
		—	5.0	μAdc

1. FR-5 = $1.0 \times 0.75 \times 0.062$ in.

2. Alumina = $0.4 \times 0.3 \times 0.024$ in. 99.5% alumina.

BSV52LT1**ELECTRICAL CHARACTERISTICS** (continued) ($T_A = 25^\circ\text{C}$ unless otherwise noted)

Characteristic	Symbol	Min	Max	Unit
ON CHARACTERISTICS				
DC Current Gain ($I_C = 1.0\text{ mAdc}$, $V_{CE} = 1.0\text{ Vdc}$) ($I_C = 10\text{ mAdc}$, $V_{CE} = 1.0\text{ Vdc}$) ($I_C = 50\text{ mAdc}$, $V_{CE} = 1.0\text{ Vdc}$)	H_{FE}	25 40 25	— 120 —	—
Collector–Emitter Saturation Voltage ($I_C = 10\text{ mAdc}$, $I_B = 300\text{ }\mu\text{Adc}$) ($I_C = 10\text{ mAdc}$, $I_B = 1.0\text{ mAdc}$) ($I_C = 50\text{ mAdc}$, $I_B = 5.0\text{ mAdc}$)	$V_{CE(sat)}$	— — —	300 250 400	mVdc
Base–Emitter Saturation Voltage ($I_C = 10\text{ mAdc}$, $I_B = 1.0\text{ mAdc}$) ($I_C = 50\text{ mAdc}$, $I_B = 5.0\text{ mAdc}$)	$V_{BE(sat)}$	700 —	850 1200	mVdc
SMALL–SIGNAL CHARACTERISTICS				
Current–Gain — Bandwidth Product ($I_C = 10\text{ mAdc}$, $V_{CE} = 10\text{ Vdc}$, $f = 100\text{ MHz}$)	f_T	400	—	MHz
Output Capacitance ($V_{CB} = 5.0\text{ Vdc}$, $I_E = 0$, $f = 1.0\text{ MHz}$)	C_{obo}	—	4.0	pF
Input Capacitance ($V_{EB} = 1.0\text{ Vdc}$, $I_C = 0$, $f = 1.0\text{ MHz}$)	C_{ibo}	—	4.5	pF
SWITCHING CHARACTERISTICS				
Storage Time ($I_C = I_{B1} = I_{B2} = 10\text{ mAdc}$)	t_s	—	13	ns
Turn–On Time ($V_{BE} = 1.5\text{ Vdc}$, $I_C = 10\text{ mAdc}$, $I_B = 3.0\text{ mAdc}$)	t_{on}	—	12	ns
Turn–Off Time ($I_C = 10\text{ mAdc}$, $I_B = 3.0\text{ mAdc}$)	t_{off}	—	18	ns

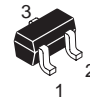
Preliminary Data Sheet

Bias Resistor Transistor
PNP Silicon Surface Mount Transistor with Monolithic Bias Resistor Network

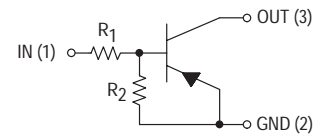
The BRT (Bias Resistor Transistor) contains a single transistor with a monolithic bias network consisting of two resistors; a series base resistor and a base-emitter resistor. These digital transistors are designed to replace a single device and its external resistor bias network. The BRT eliminates these individual components by integrating them into a single device. The DTA114YE is housed in the SOT-416/SC-90 package which is ideal for low-power surface mount applications where board space is at a premium.

- Simplifies Circuit Design
- Reduces Board Space
- Reduces Component Count
- Available in 8 mm, 7 inch/3000 Unit Tape and Reel.

DTA114YE



CASE 463-01, STYLE 1
SOT-416/SC-90



$R_1 = 10\text{ k}\Omega$
 $R_2 = 47\text{ k}\Omega$

MAXIMUM RATINGS ($T_A = 25^\circ\text{C}$ unless otherwise noted)

Rating	Symbol	Value	Unit
Output Voltage	V_O	-50	Vdc
Input Voltage	V_I	-40	Vdc
Output Current	I_O	-100	mAdc

DEVICE MARKING

DTA114YE = 59

THERMAL CHARACTERISTICS

Power Dissipation @ $T_A = 25^\circ\text{C}^{(1)}$	P_D	125	mW
Operating and Storage Temperature Range	T_J, T_{stg}	-55 to +150	$^\circ\text{C}$
Junction Temperature	T_J	150	$^\circ\text{C}$

ELECTRICAL CHARACTERISTICS ($T_A = 25^\circ\text{C}$)

Characteristic	Symbol	Min	Typ	Max	Unit
Input Off Voltage ($V_O = -5.0\text{ Vdc}, I_O = -100\text{ }\mu\text{Adc}$)	$V_{I(off)}$	—	—	-0.3	Vdc
Input On Voltage ($V_O = -0.3\text{ Vdc}, I_O = -1.0\text{ mAdc}$)	$V_{I(on)}$	-1.4	—	—	Vdc
Output On Voltage ($I_O = -5.0\text{ mAdc}, I_I = -0.25\text{ mAdc}$)	$V_{O(on)}$	—	—	-0.3	Vdc
Input Current ($V_I = -5.0\text{ Vdc}$)	I_I	—	—	-0.88	mAdc
Output Cutoff Current ($V_O = -50\text{ Vdc}$)	$I_{O(off)}$	—	—	-500	nAdc
DC Current Gain ($V_O = -5.0\text{ Vdc}, I_O = -5.0\text{ mAdc}$)	G_I	68	—	—	—
Input Resistance	R_1	7.0	10	13	kOhms
Resistance Ratio	R_1/R_2	0.17	0.21	0.25	—

1. Device mounted on a FR-4 glass epoxy printed circuit board using the minimum recommended footprint.

This document contains information on a product under development. Motorola reserves the right to change or discontinue this product without notice.

TYPICAL ELECTRICAL CHARACTERISTICS

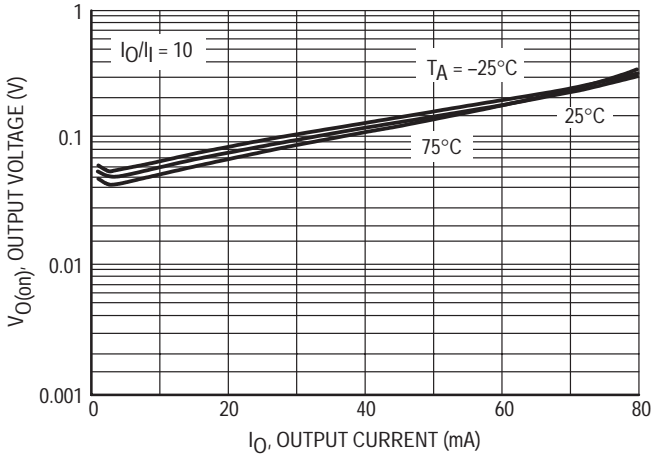


Figure 1. $V_{O(on)}$ versus I_O

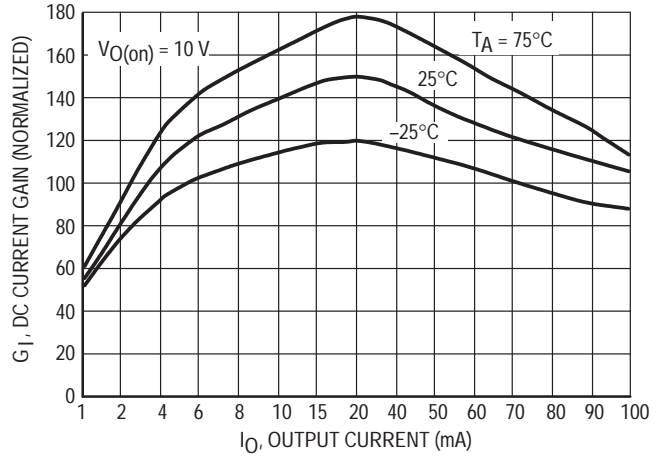


Figure 2. G_I , DC Current Gain

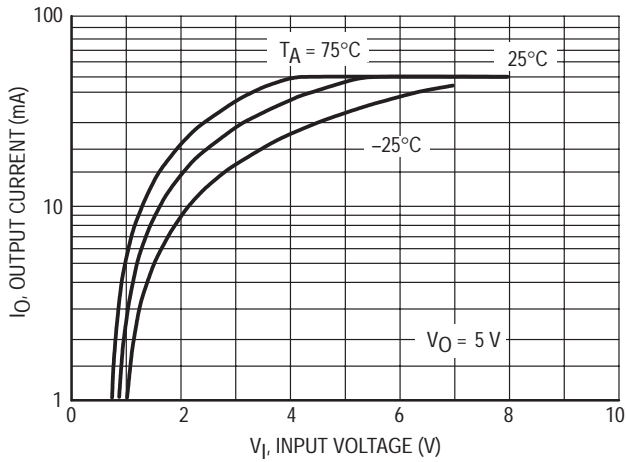


Figure 3. Output Current versus Input Voltage

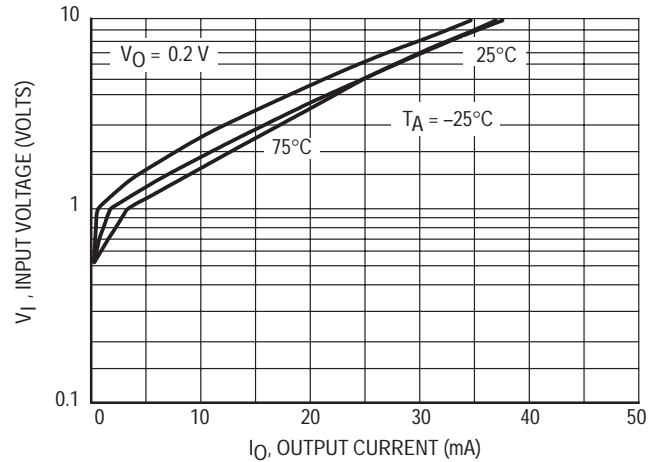


Figure 4. Input Voltage versus Output Current

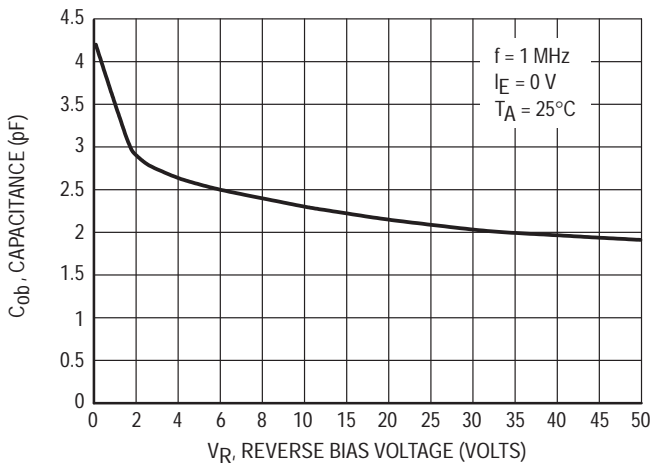


Figure 5. Output Capacitance

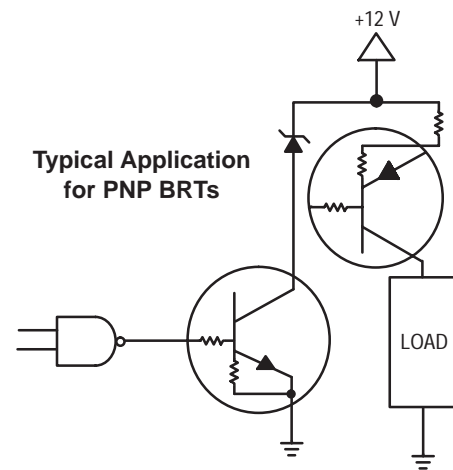


Figure 6. Inexpensive, Unregulated Current Source

Preliminary Data Sheet

Bias Resistor Transistor

PNP Silicon Surface Mount Transistor with Monolithic Bias Resistor Network

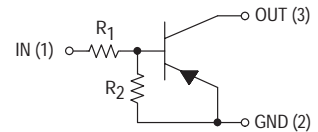
The BRT (Bias Resistor Transistor) contains a single transistor with a monolithic bias network consisting of two resistors; a series base resistor and a base-emitter resistor. These digital transistors are designed to replace a single device and its external resistor bias network. The BRT eliminates these individual components by integrating them into a single device. The DTA143EE is housed in the SOT-416/SC-90 package which is ideal for low-power surface mount applications where board space is at a premium.

- Simplifies Circuit Design
- Reduces Board Space
- Reduces Component Count
- Available in 8 mm, 7 inch/3000 Unit Tape and Reel.

DTA143EE



CASE 463-01, STYLE 1
SOT-416/SC-90



$R_1 = 4.7 \text{ k}\Omega$
 $R_2 = 4.7 \text{ k}\Omega$

MAXIMUM RATINGS ($T_A = 25^\circ\text{C}$ unless otherwise noted)

Rating	Symbol	Value	Unit
Output Voltage	V_O	-50	Vdc
Input Voltage	V_I	-30	Vdc
Output Current	I_O	-100	mAdc

DEVICE MARKING

DTA143EE = 43

THERMAL CHARACTERISTICS

Power Dissipation @ $T_A = 25^\circ\text{C}^{(1)}$	P_D	125	mW
Operating and Storage Temperature Range	T_J, T_{stg}	-55 to +150	$^\circ\text{C}$
Junction Temperature	T_J	150	$^\circ\text{C}$

ELECTRICAL CHARACTERISTICS ($T_A = 25^\circ\text{C}$)

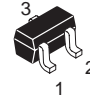
Characteristic	Symbol	Min	Typ	Max	Unit
Input Off Voltage ($V_O = -5.0 \text{ Vdc}, I_O = -100 \mu\text{Adc}$)	$V_{I(\text{off})}$	—	—	-0.5	Vdc
Input On Voltage ($V_O = -0.3 \text{ Vdc}, I_O = -20 \text{ mAdc}$)	$V_{I(\text{on})}$	-3.0	—	—	Vdc
Output On Voltage ($I_O = -10 \text{ mAdc}, I_I = -0.5 \text{ mAdc}$)	$V_{O(\text{on})}$	—	—	-0.3	Vdc
Input Current ($V_I = -5.0 \text{ Vdc}$)	I_I	—	—	-1.8	mAdc
Output Cutoff Current ($V_O = -50 \text{ Vdc}$)	$I_{O(\text{off})}$	—	—	-500	nAdc
DC Current Gain ($V_O = -5.0 \text{ Vdc}, I_O = -10 \text{ mAdc}$)	G_I	20	—	—	—
Input Resistance	R_1	3.3	4.7	6.1	kOhms
Resistance Ratio	R_1/R_2	0.8	1.0	1.2	—

1. Device mounted on a FR-4 glass epoxy printed circuit board using the minimum recommended footprint.

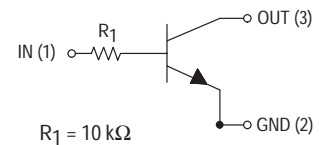
* Typical electrical characteristic curves are not available at this time.

This document contains information on a product under development. Motorola reserves the right to change or discontinue this product without notice.

DTC114TE



CASE 463-01, STYLE 1
SOT-416/SC-90



Preliminary Data Sheet
Bias Resistor Transistor
NPN Silicon Surface Mount Transistor with
Monolithic Bias Resistor Network

The BRT (Bias Resistor Transistor) contains a single transistor with a monolithic bias network consisting of two resistors; a series base resistor and a base-emitter resistor. These digital transistors are designed to replace a single device and its external resistor bias network. The BRT eliminates these individual components by integrating them into a single device. The DTC114TE is housed in the SOT-416/SC-90 package which is ideal for low power surface mount applications where board space is at a premium.

- Simplifies Circuit Design
- Reduces Board Space
- Reduces Component Count
- Available in 8 mm, 7 inch/3000 Unit Tape and Reel.

MAXIMUM RATINGS ($T_A = 25^\circ\text{C}$ unless otherwise noted)

Rating	Symbol	Value	Unit
Collector-Base Voltage	V_{CBO}	50	Vdc
Collector-Emitter Voltage	V_{CEO}	50	Vdc
Collector Current	I_C	100	mAdc

DEVICE MARKING

DTC114TE = 94

THERMAL CHARACTERISTICS

Power Dissipation @ $T_A = 25^\circ\text{C}$ (1)	P_D	125	mW
Operating and Storage Temperature Range	T_J, T_{stg}	-55 to +150	$^\circ\text{C}$
Junction Temperature	T_J	150	$^\circ\text{C}$

ELECTRICAL CHARACTERISTICS ($T_A = 25^\circ\text{C}$)

Characteristic	Symbol	Min	Typ	Max	Unit
Collector-Base Breakdown Voltage ($I_C = 50 \mu\text{Adc}$)	$V_{(BR)CBO}$	50	—	—	Vdc
Collector-Emitter Breakdown Voltage ($I_C = 1.0 \text{ mAdc}$)	$V_{(BR)CEO}$	50	—	—	Vdc
Emitter-Base Breakdown Voltage ($I_E = 50 \mu\text{Adc}$)	$V_{(BR)EBO}$	5.0	—	—	Vdc
Collector-Base Cutoff Current ($V_{CB} = 50 \text{ Vdc}$)	I_{CBO}	—	—	500	nAdc
Emitter-Base Cutoff Current ($V_{EB} = 4.0 \text{ Vdc}$)	I_{EBO}	—	—	500	nAdc
DC Current Gain ($I_C = 1.0 \text{ mAdc}, V_{CE} = 5 \text{ Vdc}$)	h_{FE}	100	300	600	—
Collector-Emitter Saturation Voltage ($I_C = 10 \text{ mAdc}, I_B = 1.0 \text{ mAdc}$)	$V_{CE(sat)}$	—	—	0.3	Vdc
Input Resistance	R_1	7.0	10	13	kOhms

1. Device mounted on a FR-4 glass epoxy printed circuit board using the minimum recommended footprint.

* Typical electrical characteristic curves are not available at this time.

This document contains information on a product under development. Motorola reserves the right to change or discontinue this product without notice.

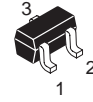
Preliminary Data Sheet

Bias Resistor Transistor
NPN Silicon Surface Mount Transistor with
Monolithic Bias Resistor Network

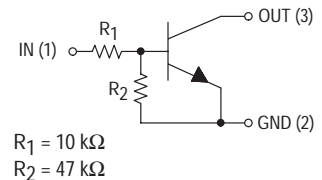
The BRT (Bias Resistor Transistor) contains a single transistor with a monolithic bias network consisting of two resistors; a series base resistor and a base-emitter resistor. These digital transistors are designed to replace a single device and its external resistor bias network. The BRT eliminates these individual components by integrating them into a single device. The DTC114YE is housed in the SOT-416/SC-90 package which is ideal for low power surface mount applications where board space is at a premium.

- Simplifies Circuit Design
- Reduces Board Space
- Reduces Component Count
- Available in 8 mm, 7 inch/3000 Unit Tape and Reel.

DTC114YE



CASE 463-01, STYLE 1
SOT-416/SC-90



MAXIMUM RATINGS ($T_A = 25^\circ\text{C}$ unless otherwise noted)

Rating	Symbol	Value	Unit
Output Voltage	V_O	50	Vdc
Input Voltage	V_I	40	Vdc
Output Current	I_O	100	mAdc

DEVICE MARKING

DTC114YE = 69

THERMAL CHARACTERISTICS

Power Dissipation @ $T_A = 25^\circ\text{C}$ (1)	P_D	125	mW
Operating and Storage Temperature Range	T_J, T_{stg}	-55 to +150	$^\circ\text{C}$
Junction Temperature	T_J	150	$^\circ\text{C}$

ELECTRICAL CHARACTERISTICS ($T_A = 25^\circ\text{C}$)

Characteristic	Symbol	Min	Typ	Max	Unit
Input Off Voltage ($V_O = 5.0\text{ Vdc}, I_O = 100\text{ }\mu\text{Adc}$)	$V_{I(off)}$	—	—	0.3	Vdc
Input On Voltage ($V_O = 0.3\text{ Vdc}, I_O = 1.0\text{ mAdc}$)	$V_{I(on)}$	1.4	—	—	Vdc
Output On Voltage ($I_O = 5.0\text{ mAdc}, I_I = 0.25\text{ mAdc}$)	$V_{O(on)}$	—	—	0.3	Vdc
Input Current ($V_I = 5.0\text{ Vdc}$)	I_I	—	—	0.88	mAdc
Output Cutoff Current ($V_O = 50\text{ Vdc}$)	$I_{O(off)}$	—	—	500	nAdc
DC Current Gain ($V_O = 5.0\text{ Vdc}, I_O = 5.0\text{ mAdc}$)	G_I	68	—	—	—
Input Resistance	R_1	7.0	10	13	kOhms
Resistance Ratio	R_1/R_2	0.17	0.21	0.25	—

1. Device mounted on a FR-4 glass epoxy printed circuit board using the minimum recommended footprint.

This document contains information on a product under development. Motorola reserves the right to change or discontinue this product without notice.

TYPICAL ELECTRICAL CHARACTERISTICS

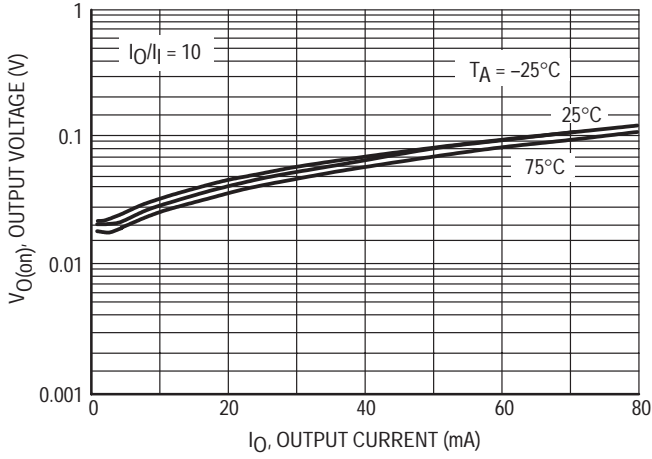


Figure 1. $V_{O(on)}$ versus I_O

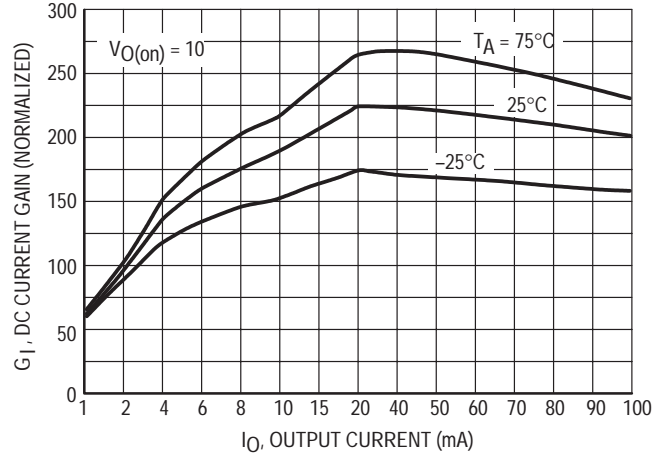


Figure 2. G_I , DC Current Gain

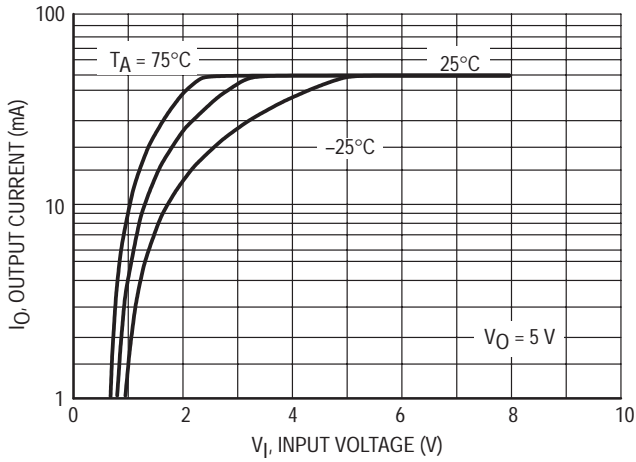


Figure 3. Output Current versus Input Voltage

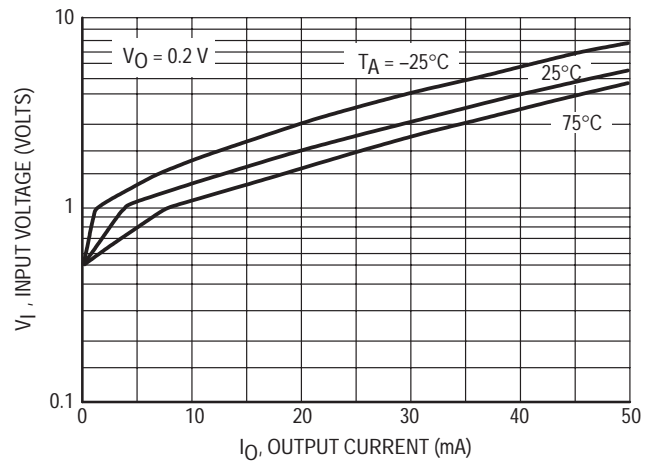


Figure 4. Input Voltage versus Output Current

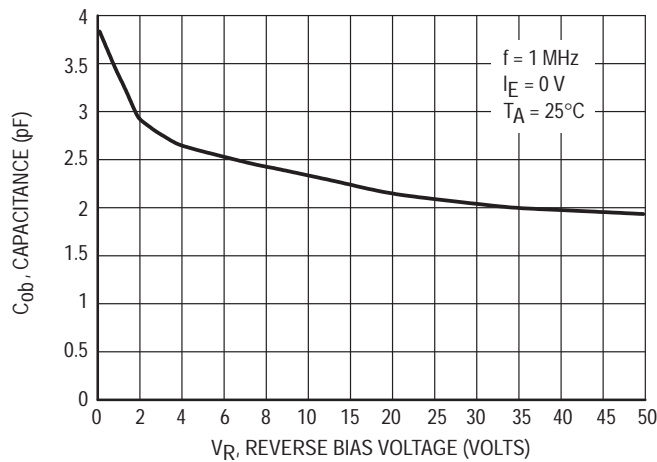


Figure 5. Output Capacitance

TYPICAL APPLICATIONS FOR NPN BRTs

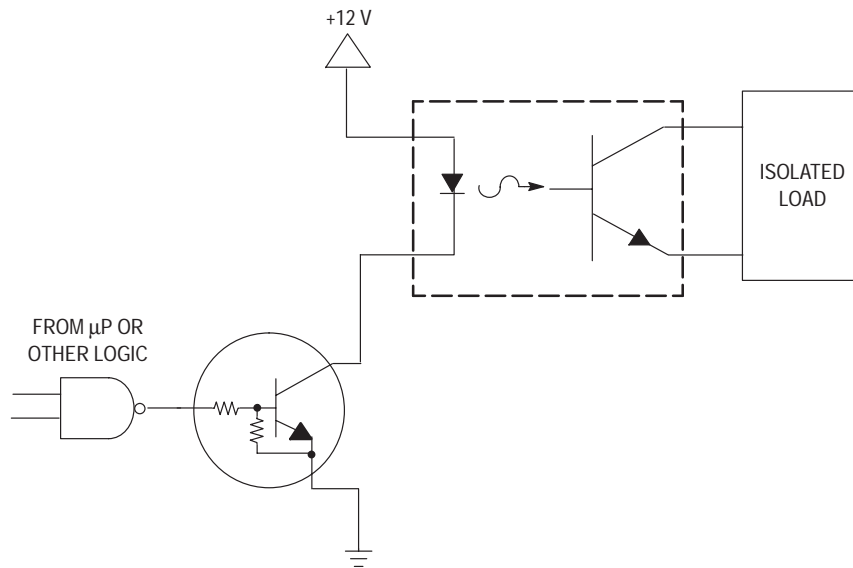


Figure 6. Level Shifter: Connects 12 or 24 Volt Circuits to Logic

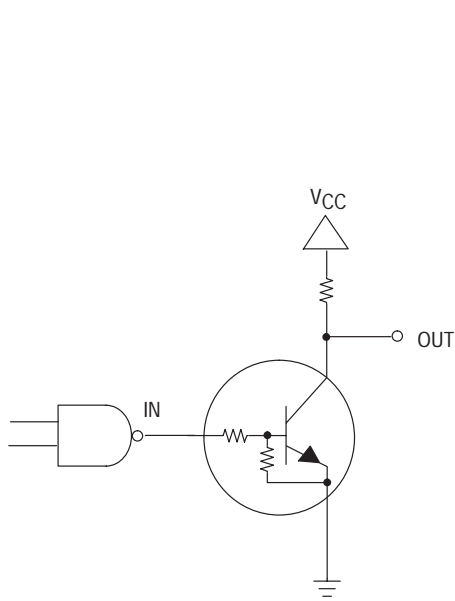


Figure 7. Open Collector Inverter: Inverts the Input Signal

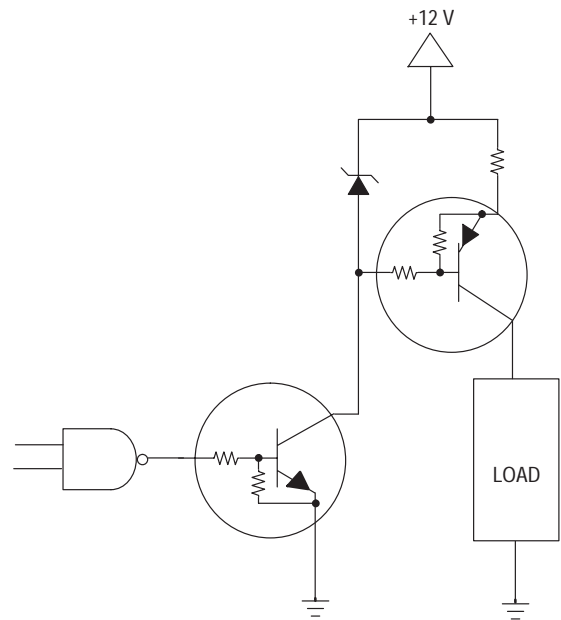


Figure 8. Inexpensive, Unregulated Current Source

Dual General Purpose Transistors

The MBT3904DW1T1, MBT3906DW1T1, and MBT3946DW1T1 devices are spin-offs of our popular SOT-23/SOT-323 three-leaded devices. They are designed for general purpose amplifier applications and are housed in the SOT-363 six-leaded surface mount package. By putting two discrete devices in one package, these devices are ideal for low-power surface mount applications where board space is at a premium.

- h_{FE} , 100–300
- Low $V_{CE(sat)}$, ≤ 0.4 V
- Simplifies Circuit Design
- Reduces Board Space
- Reduces Component Count
- Available in 8 mm, 7-inch/3,000 Unit Tape and Reel

MAXIMUM RATINGS

Rating	Symbol	Value	Unit
Collector–Emitter Voltage MBT3904DW1T1 (NPN) MBT3906DW1T1 (PNP)	V_{CEO}	40 –40	Vdc
Collector–Base Voltage MBT3904DW1T1 (NPN) MBT3906DW1T1 (PNP)	V_{CBO}	60 –40	Vdc
Emitter–Base Voltage MBT3904DW1T1 (NPN) MBT3906DW1T1 (PNP)	V_{EBO}	6.0 –5.0	Vdc
Collector Current — Continuous MBT3904DW1T1 (NPN) MBT3906DW1T1 (PNP)	I_C	200 –200	mAdc

THERMAL CHARACTERISTICS

Characteristic	Symbol	Max	Unit
Total Package Dissipation ⁽¹⁾ $T_A = 25^\circ\text{C}$	P_D	150	mW
Thermal Resistance Junction to Ambient	$R_{\theta JA}$	833	$^\circ\text{C/W}$
Junction and Storage Temperature	T_J, T_{stg}	–55 to +150	$^\circ\text{C}$

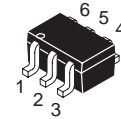
1. Device mounted on FR4 glass epoxy printed circuit board using the minimum recommended footprint.

DEVICE MARKING

MBT3904DW1T1 = MA MBT3946DW1T1 = 46
MBT3906DW1T1 = A2

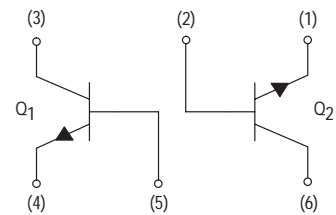
MBT3904DW1T1 MBT3906DW1T1 MBT3946DW1T1

MBT3904DW1T1
MBT3906DW1T1
MBT3946DW1T1

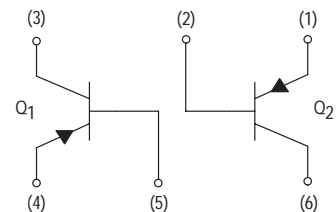


CASE 419B-01, STYLE 1

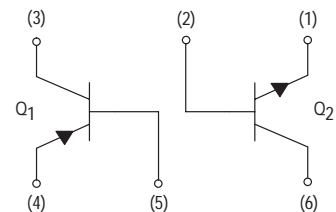
MBT3904DW1T1



MBT3906DW1T1



MBT3946DW1T1*



*Q1 same as MBT3906DW1T1
Q2 same as MBT3904DW1T1

ELECTRICAL CHARACTERISTICS ($T_A = 25^\circ\text{C}$ unless otherwise noted)

Characteristic	Symbol	Min	Max	Unit	
OFF CHARACTERISTICS					
Collector–Emitter Breakdown Voltage ⁽²⁾ ($I_C = 1.0\text{ mAdc}$, $I_B = 0$) ($I_C = -1.0\text{ mAdc}$, $I_B = 0$)	MBT3904DW1T1 (NPN) MBT3906DW1T1 (PNP)	$V_{(BR)CEO}$	40 –40	— —	Vdc
Collector–Base Breakdown Voltage ($I_C = 10\ \mu\text{A}$, $I_E = 0$) ($I_C = -10\ \mu\text{A}$, $I_E = 0$)	MBT3904DW1T1 (NPN) MBT3906DW1T1 (PNP)	$V_{(BR)CBO}$	60 –40	— —	Vdc
Emitter–Base Breakdown Voltage ($I_E = 10\ \mu\text{A}$, $I_C = 0$) ($I_E = -10\ \mu\text{A}$, $I_C = 0$)	MBT3904DW1T1 (NPN) MBT3906DW1T1 (PNP)	$V_{(BR)EBO}$	6.0 –5.0	— —	Vdc
Base Cutoff Current ($V_{CE} = 30\text{ Vdc}$, $V_{EB} = 3.0\text{ Vdc}$) ($V_{CE} = -30\text{ Vdc}$, $V_{EB} = -3.0\text{ Vdc}$)	MBT3904DW1T1 (NPN) MBT3906DW1T1 (PNP)	I_{BL}	— —	50 –50	nA
Collector Cutoff Current ($V_{CE} = 30\text{ Vdc}$, $V_{EB} = 3.0\text{ Vdc}$) ($V_{CE} = -30\text{ Vdc}$, $V_{EB} = -3.0\text{ Vdc}$)	MBT3904DW1T1 (NPN) MBT3906DW1T1 (PNP)	I_{CEX}	— —	50 –50	nA

ON CHARACTERISTICS (2)

DC Current Gain ($I_C = 0.1\text{ mAdc}$, $V_{CE} = 1.0\text{ Vdc}$) ($I_C = 1.0\text{ mAdc}$, $V_{CE} = 1.0\text{ Vdc}$) ($I_C = 10\text{ mAdc}$, $V_{CE} = 1.0\text{ Vdc}$) ($I_C = 50\text{ mAdc}$, $V_{CE} = 1.0\text{ Vdc}$) ($I_C = 100\text{ mAdc}$, $V_{CE} = 1.0\text{ Vdc}$) ($I_C = -0.1\text{ mAdc}$, $V_{CE} = -1.0\text{ Vdc}$) ($I_C = -1.0\text{ mAdc}$, $V_{CE} = -1.0\text{ Vdc}$) ($I_C = -10\text{ mAdc}$, $V_{CE} = -1.0\text{ Vdc}$) ($I_C = -50\text{ mAdc}$, $V_{CE} = -1.0\text{ Vdc}$) ($I_C = -100\text{ mAdc}$, $V_{CE} = -1.0\text{ Vdc}$)	MBT3904DW1T1 (NPN) MBT3906DW1T1 (PNP)	h_{FE}	40 70 100 60 30 60 80 100 60 30	— — 300 — — — — 300 — —	—
Collector–Emitter Saturation Voltage ($I_C = 10\text{ mAdc}$, $I_B = 1.0\text{ mAdc}$) ($I_C = 50\text{ mAdc}$, $I_B = 5.0\text{ mAdc}$) ($I_C = -10\text{ mAdc}$, $I_B = -1.0\text{ mAdc}$) ($I_C = -50\text{ mAdc}$, $I_B = -5.0\text{ mAdc}$)	MBT3904DW1T1 (NPN) MBT3906DW1T1 (PNP)	$V_{CE(sat)}$	— — — —	0.2 0.3 –0.25 –0.4	Vdc
Base–Emitter Saturation Voltage ($I_C = 10\text{ mAdc}$, $I_B = 1.0\text{ mAdc}$) ($I_C = 50\text{ mAdc}$, $I_B = 5.0\text{ mAdc}$) ($I_C = -10\text{ mAdc}$, $I_B = -1.0\text{ mAdc}$) ($I_C = -50\text{ mAdc}$, $I_B = -5.0\text{ mAdc}$)	MBT3904DW1T1 (NPN) MBT3906DW1T1 (PNP)	$V_{BE(sat)}$	0.65 — –0.65 —	0.85 0.95 –0.85 –0.95	Vdc

SMALL–SIGNAL CHARACTERISTICS

Current–Gain — Bandwidth Product ($I_C = 10\text{ mAdc}$, $V_{CE} = 20\text{ Vdc}$, $f = 100\text{ MHz}$) ($I_C = -10\text{ mAdc}$, $V_{CE} = -20\text{ Vdc}$, $f = 100\text{ MHz}$)	MBT3904DW1T1 (NPN) MBT3906DW1T1 (PNP)	f_T	300 250	— —	MHz
Output Capacitance ($V_{CB} = 5.0\text{ Vdc}$, $I_E = 0$, $f = 1.0\text{ MHz}$) ($V_{CB} = -5.0\text{ Vdc}$, $I_E = 0$, $f = 1.0\text{ MHz}$)	MBT3904DW1T1 (NPN) MBT3906DW1T1 (PNP)	C_{obo}	— —	4.0 4.5	pF
Input Capacitance ($V_{EB} = 0.5\text{ Vdc}$, $I_C = 0$, $f = 1.0\text{ MHz}$) ($V_{EB} = -0.5\text{ Vdc}$, $I_C = 0$, $f = 1.0\text{ MHz}$)	MBT3904DW1T1 (NPN) MBT3906DW1T1 (PNP)	C_{ibo}	— —	8.0 10.0	pF

 2. Pulse Test: Pulse Width $\leq 300\ \mu\text{s}$; Duty Cycle $\leq 2.0\%$.

MBT3904DW1T1 MBT3906DW1T1 MBT3946DW1T1
ELECTRICAL CHARACTERISTICS ($T_A = 25^\circ\text{C}$ unless otherwise noted) (Continued)

Characteristic		Symbol	Min	Max	Unit
Input Impedance ($V_{CE} = 10\text{ Vdc}$, $I_C = 1.0\text{ mAdc}$, $f = 1.0\text{ kHz}$) ($V_{CE} = -10\text{ Vdc}$, $I_C = -1.0\text{ mAdc}$, $f = 1.0\text{ kHz}$)	MBT3904DW1T1 (NPN) MBT3906DW1T1 (PNP)	h_{ie}	1.0 2.0	10 12	$k\ \Omega$
Voltage Feedback Ratio ($V_{CE} = 10\text{ Vdc}$, $I_C = 1.0\text{ mAdc}$, $f = 1.0\text{ kHz}$) ($V_{CE} = -10\text{ Vdc}$, $I_C = -1.0\text{ mAdc}$, $f = 1.0\text{ kHz}$)	MBT3904DW1T1 (NPN) MBT3906DW1T1 (PNP)	h_{re}	0.5 0.1	8.0 10	$\times 10^{-4}$
Small-Signal Current Gain ($V_{CE} = 10\text{ Vdc}$, $I_C = 1.0\text{ mAdc}$, $f = 1.0\text{ kHz}$) ($V_{CE} = -10\text{ Vdc}$, $I_C = -1.0\text{ mAdc}$, $f = 1.0\text{ kHz}$)	MBT3904DW1T1 (NPN) MBT3906DW1T1 (PNP)	h_{fe}	100 100	400 400	—
Output Admittance ($V_{CE} = 10\text{ Vdc}$, $I_C = 1.0\text{ mAdc}$, $f = 1.0\text{ kHz}$) ($V_{CE} = -10\text{ Vdc}$, $I_C = -1.0\text{ mAdc}$, $f = 1.0\text{ kHz}$)	MBT3904DW1T1 (NPN) MBT3906DW1T1 (PNP)	h_{oe}	1.0 3.0	40 60	μmhos
Noise Figure ($V_{CE} = 5.0\text{ Vdc}$, $I_C = 100\ \mu\text{A}$, $R_S = 1.0\text{ k}\ \Omega$, $f = 1.0\text{ kHz}$) ($V_{CE} = -5.0\text{ Vdc}$, $I_C = -100\ \mu\text{A}$, $R_S = 1.0\text{ k}\ \Omega$, $f = 1.0\text{ kHz}$)	MBT3904DW1T1 (NPN) MBT3906DW1T1 (PNP)	NF	— —	5.0 4.0	dB

SWITCHING CHARACTERISTICS

Delay Time	($V_{CC} = 3.0\text{ Vdc}$, $V_{BE} = -0.5\text{ Vdc}$)	MBT3904DW1T1 (NPN)	t_d	—	35	ns
	($V_{CC} = -3.0\text{ Vdc}$, $V_{BE} = 0.5\text{ Vdc}$)	MBT3906DW1T1 (PNP)		—	35	
Rise Time	($I_C = 10\text{ mAdc}$, $I_{B1} = 1.0\text{ mAdc}$)	MBT3904DW1T1 (NPN)	t_r	—	35	ns
	($I_C = -10\text{ mAdc}$, $I_{B1} = -1.0\text{ mAdc}$)	MBT3906DW1T1 (PNP)		—	35	
Storage Time	($V_{CC} = 3.0\text{ Vdc}$, $I_C = 10\text{ mAdc}$)	MBT3904DW1T1 (NPN)	t_s	—	200	ns
	($V_{CC} = -3.0\text{ Vdc}$, $I_C = -10\text{ mAdc}$)	MBT3906DW1T1 (PNP)		—	225	
Fall Time	($I_{B1} = I_{B2} = 1.0\text{ mAdc}$)	MBT3904DW1T1 (NPN)	t_f	—	50	ns
	($I_{B1} = I_{B2} = -1.0\text{ mAdc}$)	MBT3906DW1T1 (PNP)		—	75	

MBT3904DW1T1 (NPN)

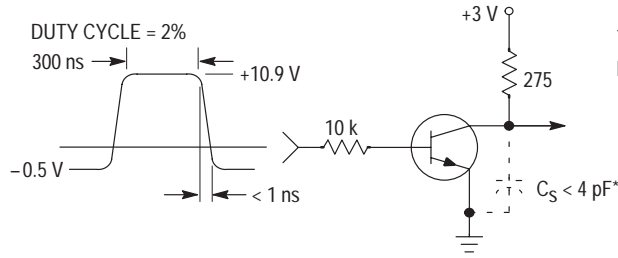


Figure 1. Delay and Rise Time Equivalent Test Circuit

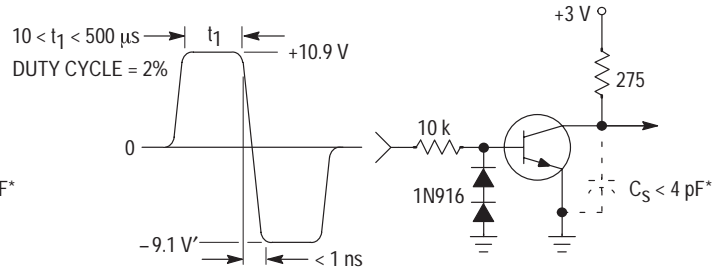


Figure 2. Storage and Fall Time Equivalent Test Circuit

* Total shunt capacitance of test jig and connectors

TYPICAL TRANSIENT CHARACTERISTICS

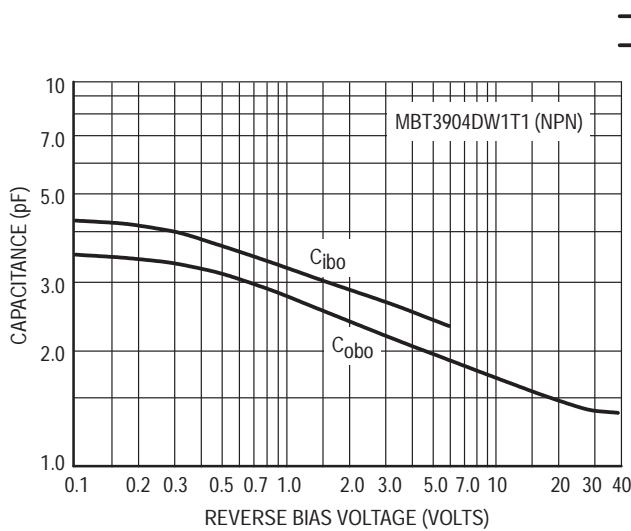


Figure 3. Capacitance

— $T_J = 25^\circ\text{C}$
 - - - $T_J = 125^\circ\text{C}$

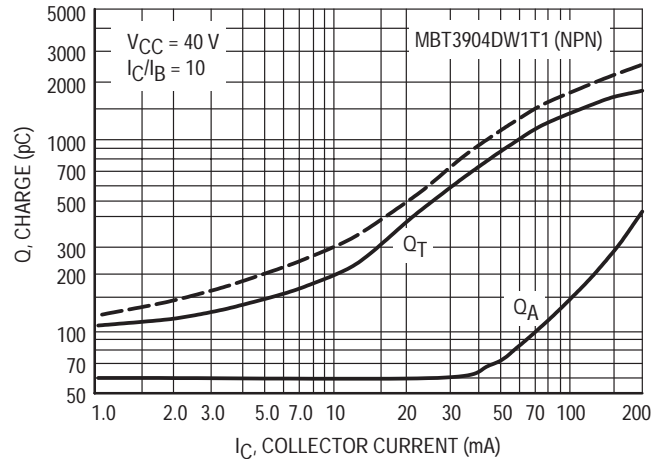


Figure 4. Charge Data

MBT3904DW1T1 (NPN)

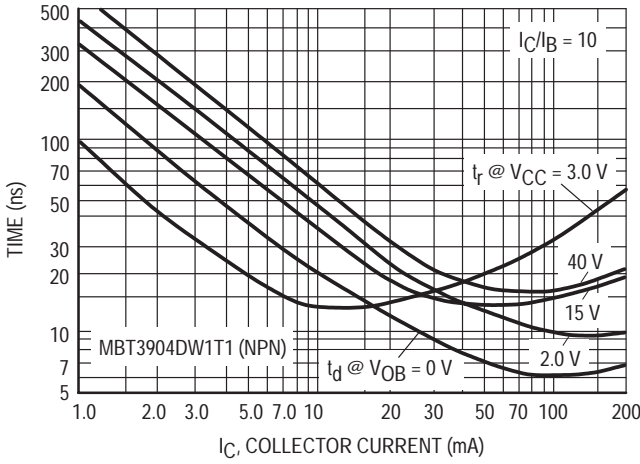


Figure 5. Turn-On Time

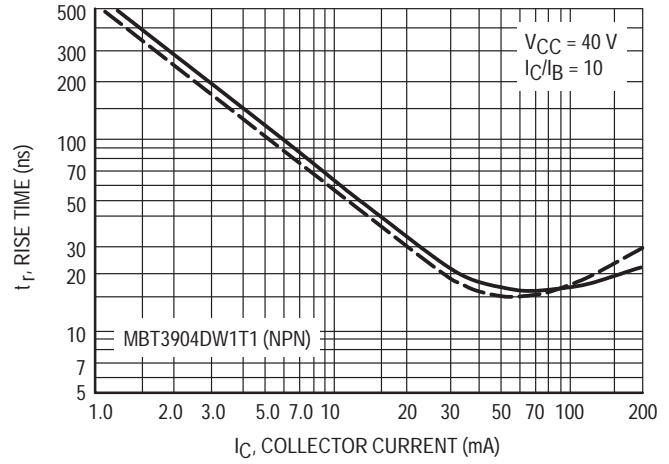


Figure 6. Rise Time

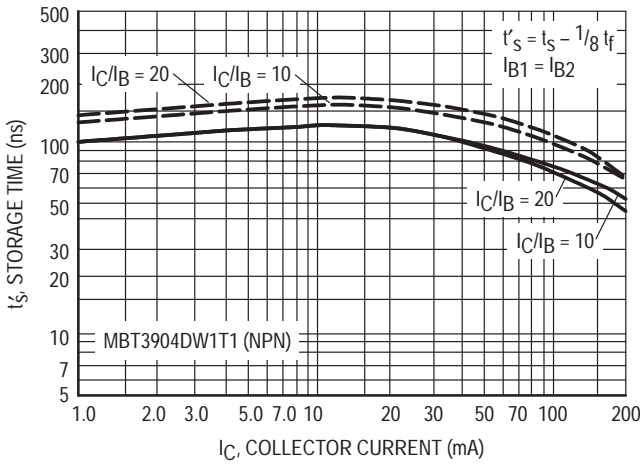


Figure 7. Storage Time

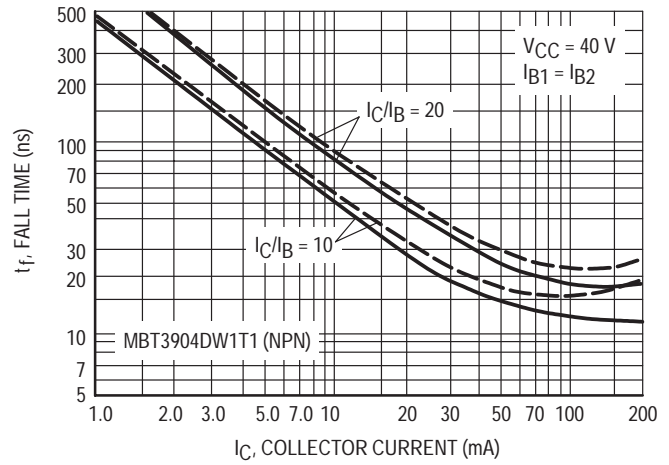


Figure 8. Fall Time

TYPICAL AUDIO SMALL-SIGNAL CHARACTERISTICS
NOISE FIGURE VARIATIONS

($V_{CE} = 5.0 \text{ Vdc}$, $T_A = 25^\circ\text{C}$, Bandwidth = 1.0 Hz)

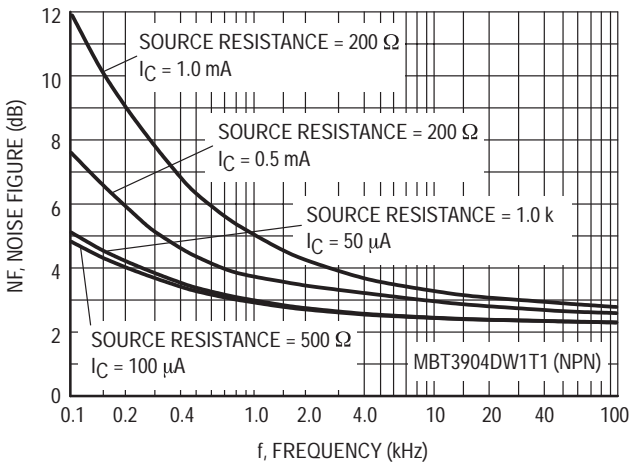


Figure 9. Noise Figure

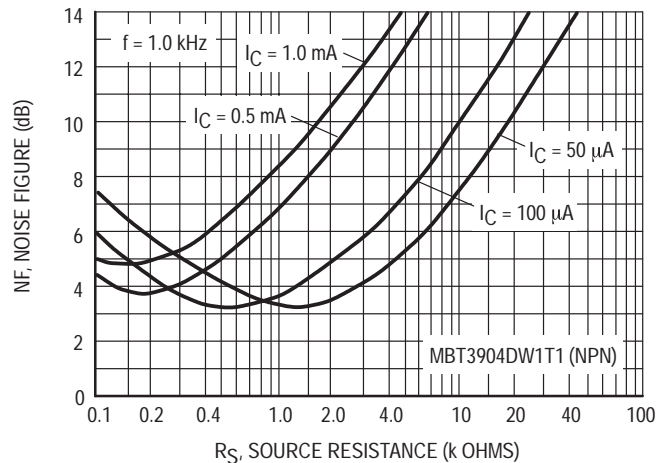


Figure 10. Noise Figure

MBT3904DW1T1 (NPN)

h PARAMETERS

($V_{CE} = 10 \text{ Vdc}$, $f = 1.0 \text{ kHz}$, $T_A = 25^\circ\text{C}$)

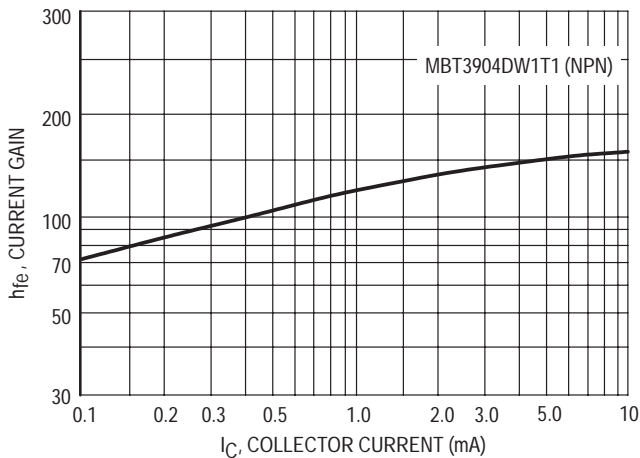


Figure 11. Current Gain

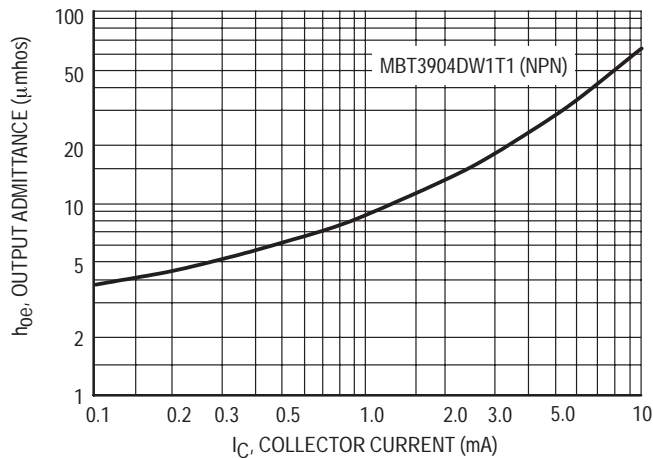


Figure 12. Output Admittance

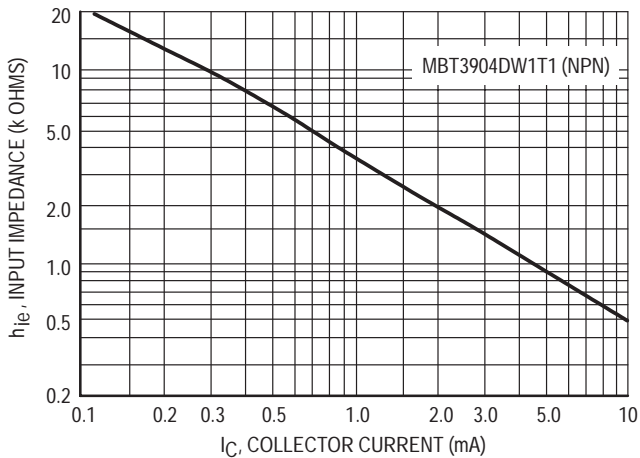


Figure 13. Input Impedance

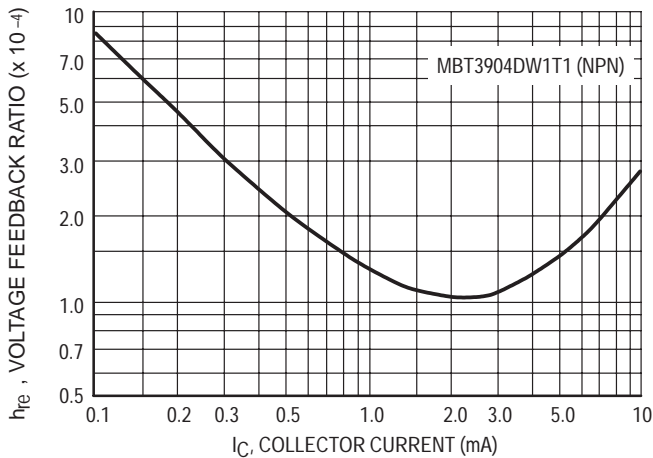


Figure 14. Voltage Feedback Ratio

MBT3904DW1T1 (NPN)

TYPICAL STATIC CHARACTERISTICS

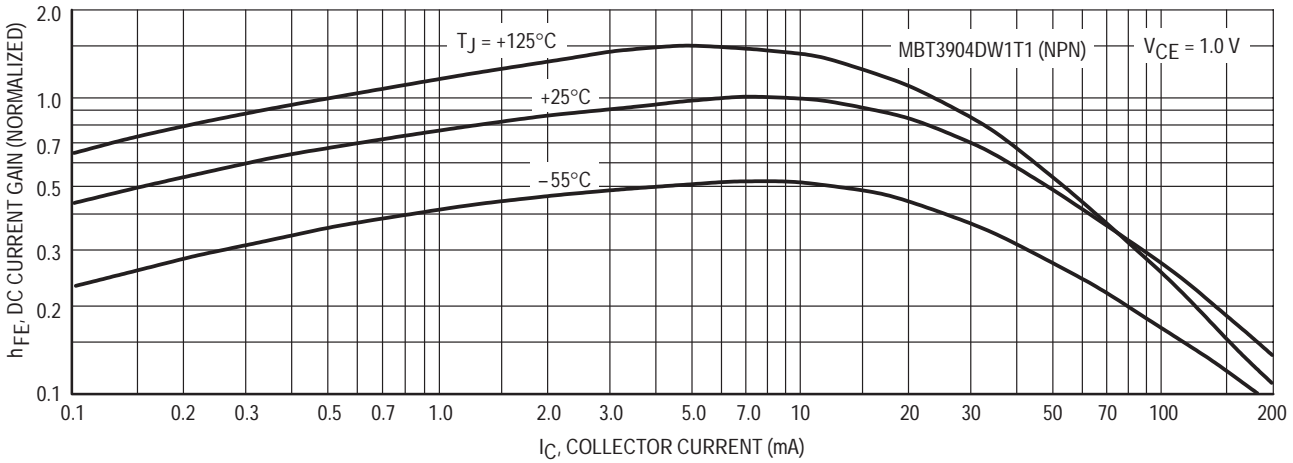


Figure 15. DC Current Gain

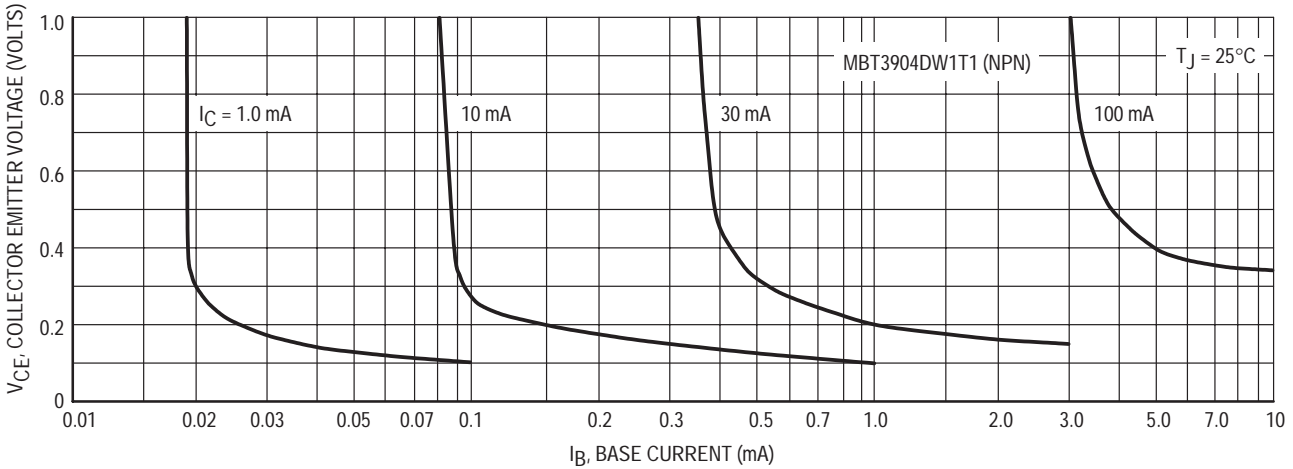


Figure 16. Collector Saturation Region

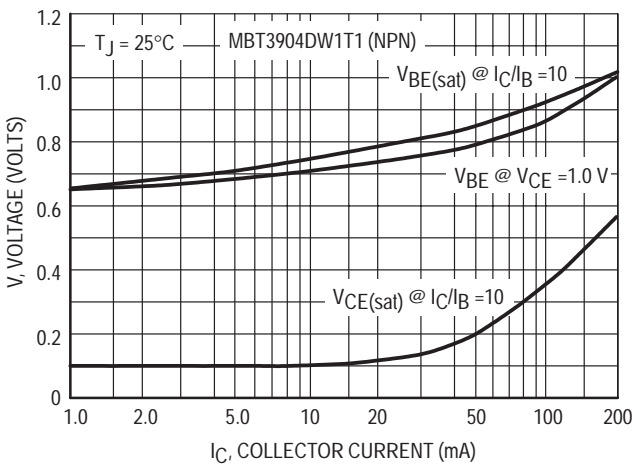


Figure 17. "ON" Voltages

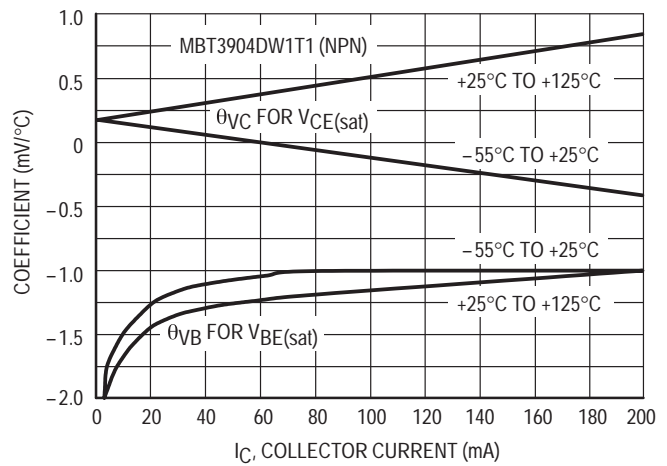


Figure 18. Temperature Coefficients

MBT3906DW1T1 (PNP)

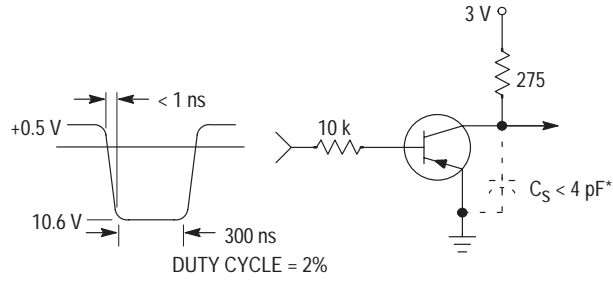


Figure 19. Delay and Rise Time Equivalent Test Circuit

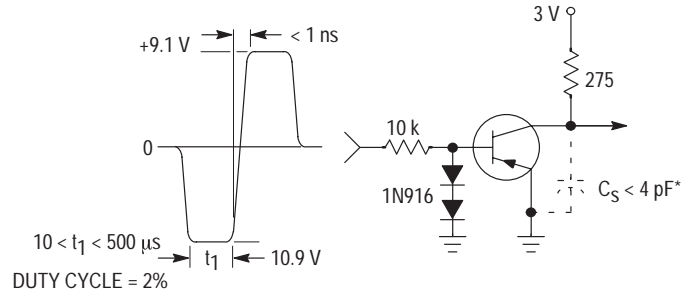


Figure 20. Storage and Fall Time Equivalent Test Circuit

* Total shunt capacitance of test jig and connectors

TYPICAL TRANSIENT CHARACTERISTICS

— $T_J = 25^\circ\text{C}$
 - - - $T_J = 125^\circ\text{C}$

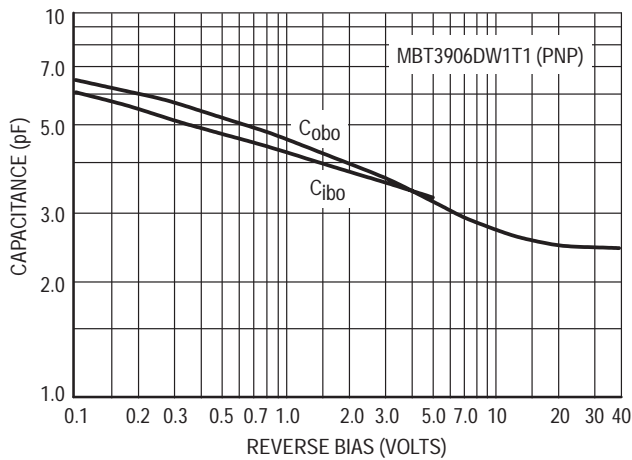


Figure 21. Capacitance

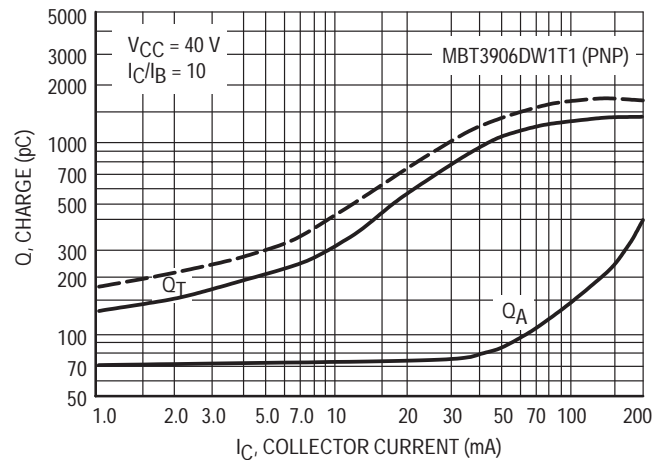


Figure 22. Charge Data

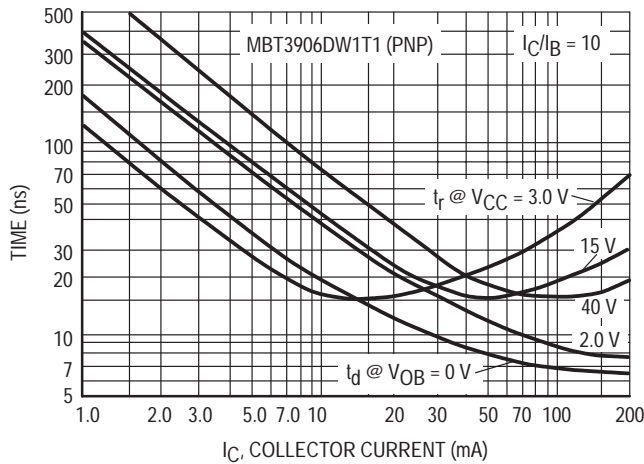


Figure 23. Turn-On Time

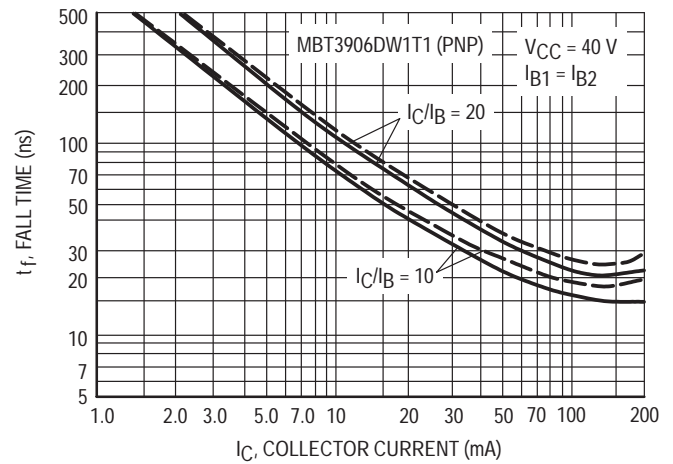


Figure 24. Fall Time

MBT3906DW1T1 (PNP)

TYPICAL AUDIO SMALL-SIGNAL CHARACTERISTICS
NOISE FIGURE VARIATIONS

($V_{CE} = -5.0$ Vdc, $T_A = 25^\circ\text{C}$, Bandwidth = 1.0 Hz)

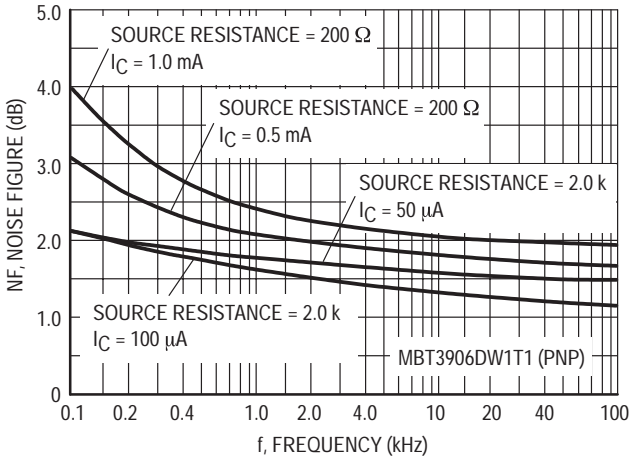


Figure 25.

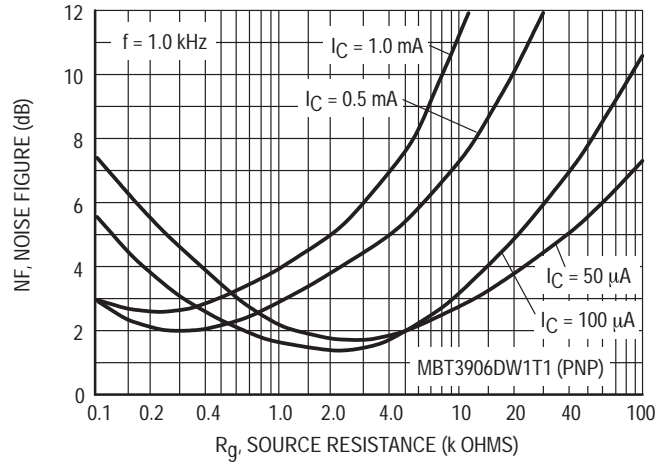


Figure 26.

h PARAMETERS

($V_{CE} = -10$ Vdc, $f = 1.0$ kHz, $T_A = 25^\circ\text{C}$)

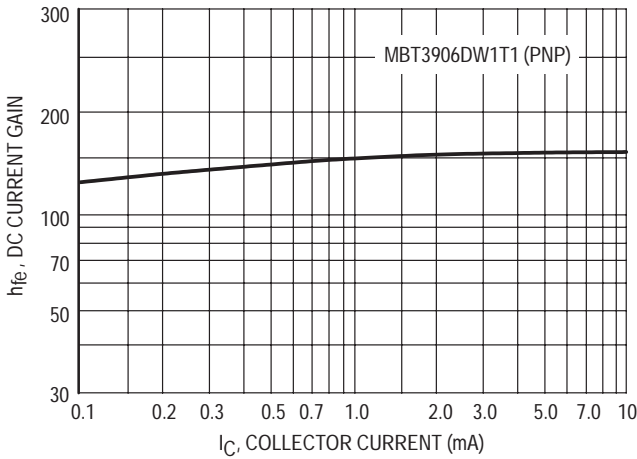


Figure 27. Current Gain

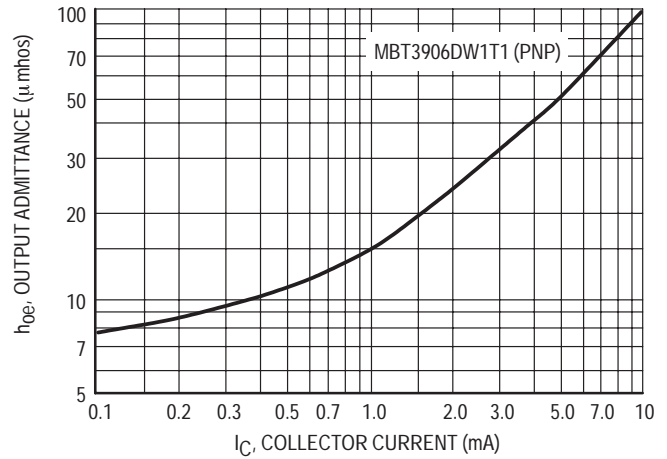


Figure 28. Output Admittance

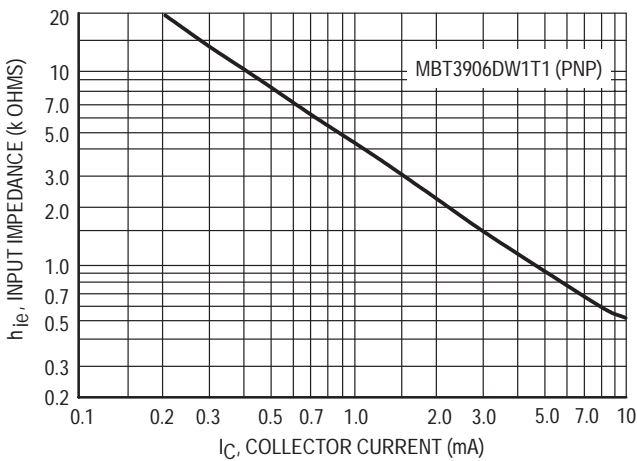


Figure 29. Input Impedance

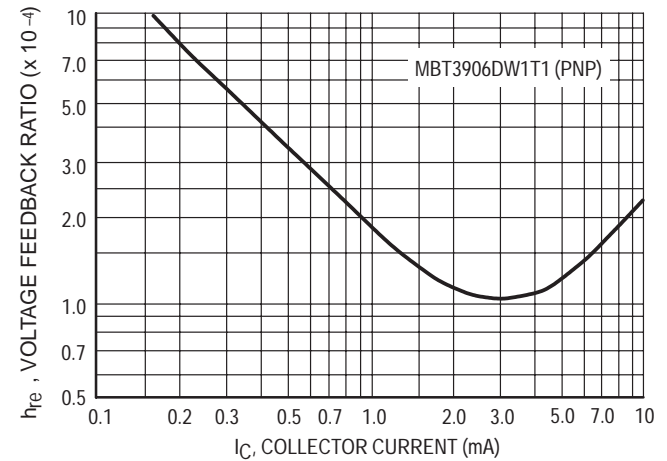


Figure 30. Voltage Feedback Ratio

MBT3906DW1T1 (PNP)

TYPICAL STATIC CHARACTERISTICS

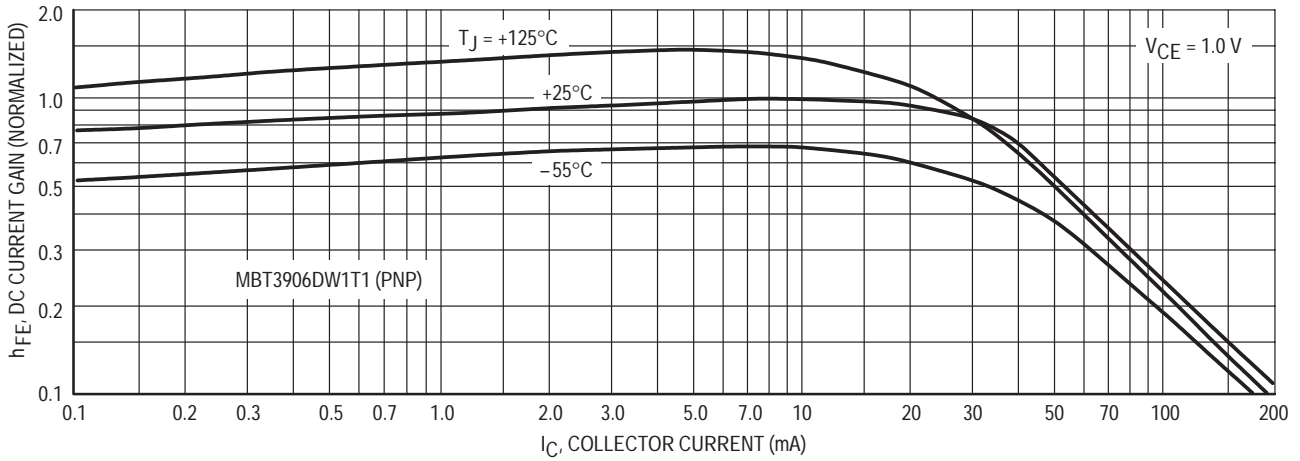


Figure 31. DC Current Gain

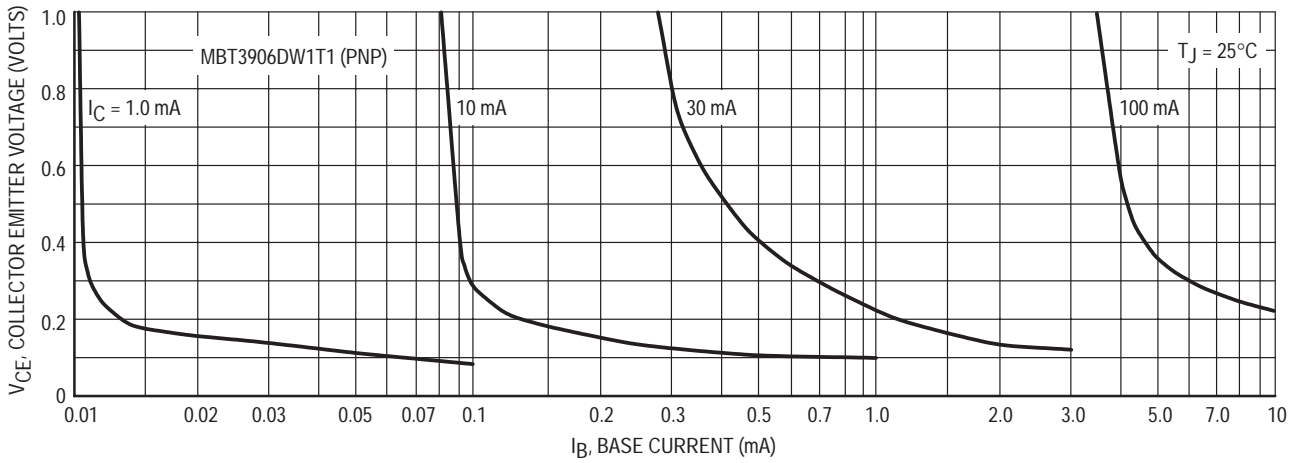


Figure 32. Collector Saturation Region

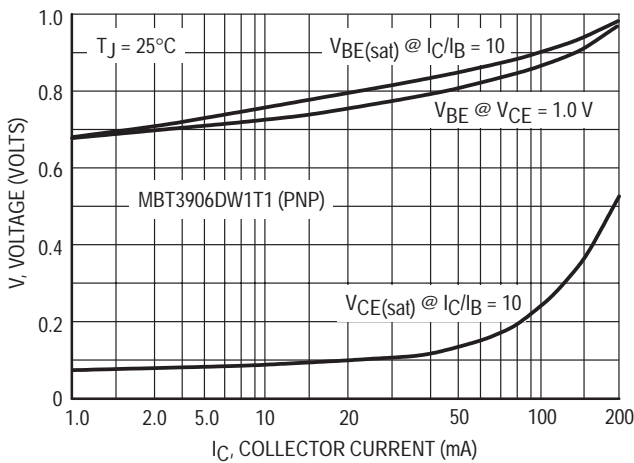


Figure 33. "ON" Voltages

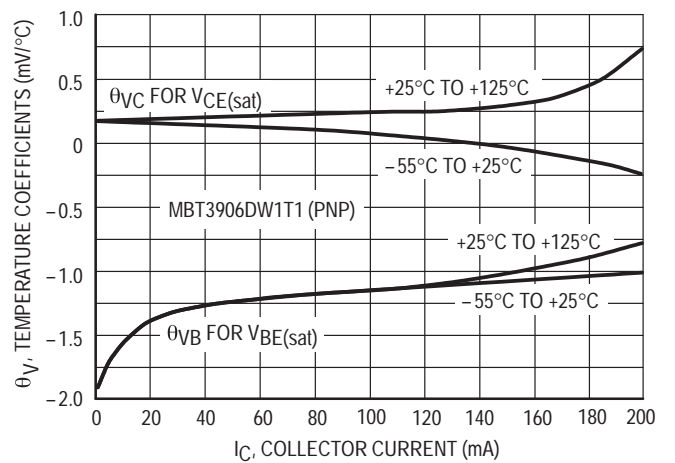
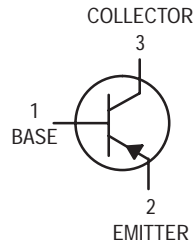


Figure 34. Temperature Coefficients

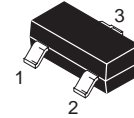
Chopper Transistor

PNP Silicon



MMBT404ALT1

Motorola Preferred Device



CASE 318-08, STYLE 6
SOT-23 (TO-236AB)

MAXIMUM RATINGS

Rating	Symbol	Value	Unit
Collector-Emitter Voltage	V_{CEO}	-35	Vdc
Collector-Base Voltage	V_{CBO}	-40	Vdc
Emitter-Base Voltage	V_{EBO}	-25	Vdc
Collector Current — Continuous	I_C	-150	mAdc

DEVICE MARKING

MMBT404ALT1 = 2N

THERMAL CHARACTERISTICS

Characteristic	Symbol	Max	Unit
Total Device Dissipation FR-5 Board,* $T_A = 25^\circ\text{C}$ Derate above 25°C	P_D	225	mW
Thermal Resistance, Junction to Ambient	$R_{\theta JA}$	1.8	$\text{mW}/^\circ\text{C}$
Total Device Dissipation Alumina Substrate,** $T_A = 25^\circ\text{C}$ Derate above 25°C	P_D	300	mW
Thermal Resistance, Junction to Ambient	$R_{\theta JA}$	2.4	$\text{mW}/^\circ\text{C}$
Junction and Storage Temperature	T_J, T_{stg}	-55 to +150	$^\circ\text{C}$

*FR-5 = 1.0 x 0.75 x 0.062 in.

** Alumina = 0.4 x 0.3 x 0.024 in. 99.5% alumina.

ELECTRICAL CHARACTERISTICS ($T_A = 25^\circ\text{C}$ unless otherwise noted)

Characteristic	Symbol	Min	Typ	Max	Unit
----------------	--------	-----	-----	-----	------

OFF CHARACTERISTICS

Collector-Emitter Breakdown Voltage ($I_C = -10 \text{ mAdc}, I_B = 0$)	$V_{(BR)CEO}$	-35	—	—	Vdc
Collector-Emitter Breakdown Voltage ($I_C = -10 \mu\text{Adc}, I_E = 0$)	$V_{(BR)CBO}$	-40	—	—	Vdc
Emitter-Base Breakdown Voltage ($I_E = -10 \mu\text{Adc}, I_C = 0$)	$V_{(BR)EBO}$	-25	—	—	Vdc
Collector Cutoff Current ($V_{CB} = -10 \text{ Vdc}, I_E = 0$)	I_{CBO}	—	—	-100	nAdc
Emitter Cutoff Current ($V_{EB} = -10 \text{ Vdc}, I_C = 0$)	I_{EBO}	—	—	-100	nAdc

Preferred devices are Motorola recommended choices for future use and best overall value.

ELECTRICAL CHARACTERISTICS ($T_A = 25^\circ\text{C}$ unless otherwise noted) (Continued)

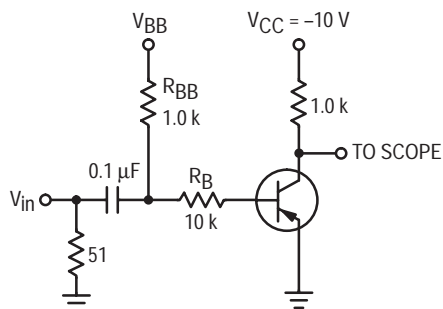
Characteristic	Symbol	Min	Typ	Max	Unit
ON CHARACTERISTICS					
DC Current Gain ($I_C = -12\text{ mA}$, $V_{CE} = -0.15\text{ Vdc}$)	h_{FE}	100	—	400	—
Collector–Emitter Saturation Voltage ($I_C = -12\text{ mA}$, $I_B = -0.4\text{ mA}$) ($I_C = -24\text{ mA}$, $I_B = -1.0\text{ mA}$)	$V_{CE(sat)}$	— —	— —	-0.15 -0.2	Vdc
Base–Emitter Saturation Voltage ($I_C = -12\text{ mA}$, $I_B = -0.4\text{ mA}$) ($I_C = -24\text{ mA}$, $I_B = -1.0\text{ mA}$)	$V_{BE(sat)}$	— —	— —	-0.85 -1.0	Vdc

SMALL–SIGNAL CHARACTERISTICS

Output Capacitance ($V_{CB} = -6.0\text{ Vdc}$, $I_E = 0$, $f = 1.0\text{ MHz}$)	C_{obo}	—	—	20	pF
-----------------------------------------------------------------------------------------	-----------	---	---	----	----

SWITCHING CHARACTERISTICS

Delay time ($V_{CC} = -10\text{ Vdc}$, $I_C = -10\text{ mA}$) (Figure 1)	t_d	—	43	—	ns
Rise Time ($I_{B1} = -1.0\text{ mA}$, $V_{BE(off)} = -14\text{ Vdc}$)	t_r	—	180	—	ns
Storage Time ($V_{CC} = -10\text{ Vdc}$, $I_C = -10\text{ mA}$)	t_s	—	675	—	ns
Fall Time ($I_{B1} = I_{B2} = -1.0\text{ mA}$) (Figure 1)	t_f	—	160	—	ns



	V_{in} (Volts)	V_{BB} (Volts)
t_{on} , t_d , t_r	-12	+1.4
t_{off} , t_s and t_f	+20.6	-11.6

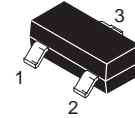
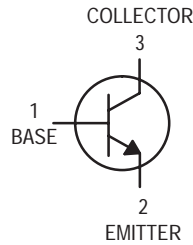
Voltages and resistor values shown are for $I_C = 10\text{ mA}$, $I_C/I_B = 10$ and $I_{B1} = I_{B2}$

Figure 1. Switching Time Test Circuit

VHF/UHF Transistor

NPN Silicon

MMBT918LT1



CASE 318-08, STYLE 6
SOT-23 (TO-236AB)

MAXIMUM RATINGS

Rating	Symbol	Value	Unit
Collector-Emitter Voltage	V_{CEO}	15	Vdc
Collector-Base Voltage	V_{CBO}	30	Vdc
Emitter-Base Voltage	V_{EBO}	3.0	Vdc
Collector Current — Continuous	I_C	50	mAdc

THERMAL CHARACTERISTICS

Characteristic	Symbol	Max	Unit
Total Device Dissipation FR-5 Board, ⁽¹⁾ $T_A = 25^\circ\text{C}$ Derate above 25°C	P_D	225	mW
		1.8	mW/ $^\circ\text{C}$
Thermal Resistance, Junction to Ambient	$R_{\theta JA}$	556	$^\circ\text{C}/\text{W}$
Total Device Dissipation Alumina Substrate, ⁽²⁾ $T_A = 25^\circ\text{C}$ Derate above 25°C	P_D	300	mW
		2.4	mW/ $^\circ\text{C}$
Thermal Resistance, Junction to Ambient	$R_{\theta JA}$	417	$^\circ\text{C}/\text{W}$
Junction and Storage Temperature	T_J, T_{stg}	-55 to +150	$^\circ\text{C}$

DEVICE MARKING

MMBT918LT1 = M3B

ELECTRICAL CHARACTERISTICS ($T_A = 25^\circ\text{C}$ unless otherwise noted)

Characteristic	Symbol	Min	Max	Unit
----------------	--------	-----	-----	------

OFF CHARACTERISTICS

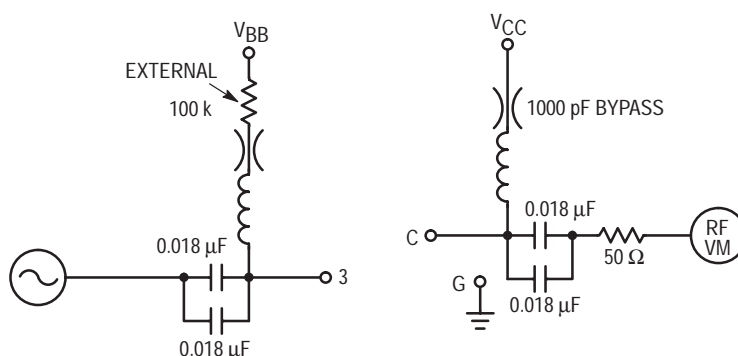
Collector-Emitter Breakdown Voltage ($I_C = 3.0 \text{ mAdc}, I_B = 0$)	$V_{(BR)CEO}$	15	—	Vdc
Collector-Base Breakdown Voltage ($I_C = 1.0 \mu\text{Adc}, I_E = 0$)	$V_{(BR)CBO}$	30	—	Vdc
Emitter-Base Breakdown Voltage ($I_E = 10 \mu\text{Adc}, I_C = 0$)	$V_{(BR)EBO}$	3.0	—	Vdc
Collector Cutoff Current ($V_{CB} = 15 \text{ Vdc}, I_E = 0$)	I_{CBO}	—	50	nAdc

1. FR-5 = 1.0 x 0.75 x 0.062 in.

2. Alumina = 0.4 x 0.3 x 0.024 in. 99.5% alumina.

ELECTRICAL CHARACTERISTICS (T_A = 25°C unless otherwise noted) (Continued)

Characteristic	Symbol	Min	Max	Unit
ON CHARACTERISTICS				
DC Current Gain (I _C = 3.0 mA, V _{CE} = 1.0 Vdc)	h _{FE}	20	—	—
Collector–Emitter Saturation Voltage (I _C = 10 mA, I _B = 1.0 mA)	V _{CE(sat)}	—	0.4	Vdc
Base–Emitter Saturation Voltage (I _C = 10 mA, I _B = 1.0 mA)	V _{BE(sat)}	—	1.0	Vdc
SMALL–SIGNAL CHARACTERISTICS				
Current–Gain — Bandwidth Product (I _C = 4.0 mA, V _{CE} = 10 Vdc, f = 100 MHz)	f _T	600	—	MHz
Output Capacitance (V _{CB} = 0 Vdc, I _E = 0, f = 1.0 MHz) (V _{CB} = 10 Vdc, I _E = 0, f = 1.0 MHz)	C _{obo}	— —	3.0 1.7	pF
Input Capacitance (V _{EB} = 0.5 Vdc, I _C = 0, f = 1.0 MHz)	C _{ibo}	—	2.0	pF
Noise Figure (I _C = 1.0 mA, V _{CE} = 6.0 Vdc, R _S = 50 Ω, f = 60 MHz) (Figure 1)	NF	—	6.0	dB
Power Output (I _C = 8.0 mA, V _{CB} = 15 Vdc, f = 500 MHz)	P _{out}	30	—	mW
Common–Emitter Amplifier Power Gain (I _C = 6.0 mA, V _{CB} = 12 Vdc, f = 200 MHz)	G _{pe}	11	—	dB



NF TEST CONDITIONS

- I_C = 1.0 mA
- V_{CE} = 6.0 VOLTS
- R_S = 50 Ω
- f = 60 MHz

G_{pe} TEST CONDITIONS

- I_C = 6.0 mA
- V_{CE} = 12 VOLTS
- f = 200 MHz

Figure 1. NF, G_{pe} Measurement Circuit 20–200



Low Saturation Voltage PNP Silicon Driver Transistors

Part of the GreenLine™ Portfolio of devices with energy-conserving traits.

This PNP Silicon Epitaxial Planar Transistor is designed to conserve energy in general purpose driver applications. This device is housed in the SOT-23 and SC-59 packages which are designed for low power surface mount applications.

- Low $V_{CE(sat)}$, < 0.1 V at 50 mA

Applications

- LCD Backlight Driver
- Annunciator Driver
- General Output Device Driver

MAXIMUM RATINGS ($T_A = 25^\circ\text{C}$)

Rating	Symbol	Value	Unit
Collector-Base Voltage	$V_{(BR)CBO}$	45	Vdc
Collector-Emitter Voltage	$V_{(BR)CEO}$	15	Vdc
Emitter-Base Voltage	$V_{(BR)EBO}$	5.0	Vdc
Collector Current — Continuous	I_C	100	mAdc

DEVICE MARKING

MMBT1010LT1 = GLP
MSD1010T1 = GLP

THERMAL CHARACTERISTICS

Rating	Symbol	Max	Unit
Power Dissipation $T_A = 25^\circ\text{C}$ Derate above 25°C	$P_D^{(1)}$	250 1.8	mW mW/°C
Thermal Resistance Junction to Ambient	$R_{\theta JA}$	556	°C/W
Junction Temperature	T_J	150	°C
Storage Temperature Range	T_{stg}	-55 ~ +150	°C

ELECTRICAL CHARACTERISTICS

Characteristic	Symbol	Condition	Min	Max	Unit
Collector-Emitter Breakdown Voltage	$V_{(BR)CEO}$	$I_C = 10\text{ mA}, I_B = 0$	15	—	Vdc
Emitter-Base Breakdown Voltage	$V_{(BR)EBO}$	$I_E = 10\text{ }\mu\text{A}, I_C = 0$	5.0	—	Vdc
Collector-Base Cutoff Current	I_{CBO}	$V_{CB} = 20\text{ V}, I_E = 0$	—	0.1	μA
Collector-Emitter Cutoff Current	I_{CEO}	$V_{CE} = 10\text{ V}, I_B = 0$	—	100	μA
DC Current Gain	$h_{FE1}^{(2)}$	$V_{CE} = 5\text{ V}, I_C = 100\text{ mA}$	300	600	—
Collector-Emitter Saturation Voltage	$V_{CE(sat)}^{(2)}$	$I_C = 10\text{ mA}, I_B = 1.0\text{ mA}$ $I_C = 50\text{ mA}, I_B = 5.0\text{ mA}$ $I_C = 100\text{ mA}, I_B = 10\text{ mA}$	—	0.1 0.1 0.19	Vdc
Base-Emitter Saturation Voltage	$V_{BE(sat)}^{(2)}$	$I_C = 100\text{ mA}, I_B = 10\text{ mA}$	—	1.1	Vdc

(1) Device mounted on a FR-4 glass epoxy printed circuit board using the minimum recommended footprint.

(2) Pulse Test: Pulse Width $\leq 300\text{ }\mu\text{s}$, D.C. $\leq 2\%$.

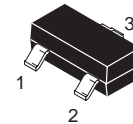
Preferred devices are Motorola recommended choices for future use and best overall value.

REV 2

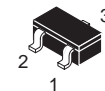
MMBT1010LT1 MSD1010T1

Motorola Preferred Devices

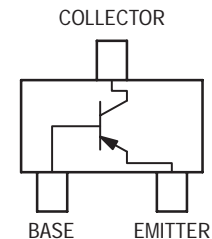
PNP GENERAL PURPOSE DRIVER TRANSISTORS SURFACE MOUNT



CASE 318-08, STYLE 6
SOT-23

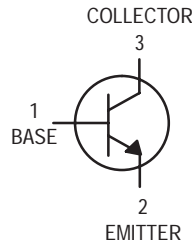


CASE 318D-04, STYLE 1
SC-59



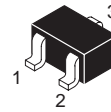
Preliminary Information
General Purpose Transistor
NPN Silicon

These transistors are designed for general purpose amplifier applications. They are housed in the SOT-323/SC-70 package which is designed for low power surface mount applications.



MMBT2222AWT1

Motorola Preferred Device



CASE 419-02, STYLE 3
SOT-323/SC-70

MAXIMUM RATINGS

Rating	Symbol	Value	Unit
Collector-Emitter Voltage	V_{CEO}	40	Vdc
Collector-Base Voltage	V_{CBO}	75	Vdc
Emitter-Base Voltage	V_{EBO}	6.0	Vdc
Collector Current — Continuous	I_C	600	mAdc

THERMAL CHARACTERISTICS

Characteristic	Symbol	Max	Unit
Total Device Dissipation FR-5 Board $T_A = 25^\circ\text{C}$	P_D	150	mW
Thermal Resistance Junction to Ambient	$R_{\theta JA}$	833	$^\circ\text{C/W}$
Junction and Storage Temperature	T_J, T_{stg}	-55 to +150	$^\circ\text{C}$

DEVICE MARKING

MMBT2222AWT1 = 1P

ELECTRICAL CHARACTERISTICS ($T_A = 25^\circ\text{C}$ unless otherwise noted)

Characteristic	Symbol	Min	Max	Unit
----------------	--------	-----	-----	------

OFF CHARACTERISTICS

Collector-Emitter Breakdown Voltage ⁽¹⁾ ($I_C = 1.0 \text{ mAdc}, I_B = 0$)	$V_{(BR)CEO}$	40	—	Vdc
Collector-Base Breakdown Voltage ($I_C = 10 \text{ }\mu\text{Adc}, I_E = 0$)	$V_{(BR)CBO}$	75	—	Vdc
Emitter-Base Breakdown Voltage ($I_E = 10 \text{ }\mu\text{Adc}, I_C = 0$)	$V_{(BR)EBO}$	6.0	—	Vdc
Base Cutoff Current ($V_{CE} = 60 \text{ Vdc}, V_{EB} = 3.0 \text{ Vdc}$)	I_{BL}	—	20	nAdc
Collector Cutoff Current ($V_{CE} = 60 \text{ Vdc}, V_{EB} = 3.0 \text{ Vdc}$)	I_{CEX}	—	10	nAdc

1. Pulse Test: Pulse Width $\leq 300 \text{ }\mu\text{s}$, Duty Cycle $\leq 2.0\%$.

Preferred devices are Motorola recommended choices for future use and best overall value.

MMBT2222AWT1

ELECTRICAL CHARACTERISTICS (T_A = 25°C unless otherwise noted) (Continued)

Characteristic	Symbol	Min	Max	Unit
ON CHARACTERISTICS(1)				
DC Current Gain (1) (I _C = 0.1 mA _{dc} , V _{CE} = 10 V _{dc}) (I _C = 1.0 mA _{dc} , V _{CE} = 10 V _{dc}) (I _C = 10 mA _{dc} , V _{CE} = 10 V _{dc}) (I _C = 150 mA _{dc} , V _{CE} = 10 V _{dc}) (I _C = 500 mA _{dc} , V _{CE} = 10 V _{dc})	H _{FE}	35 50 75 100 40	— — — — —	—
Collector–Emitter Saturation Voltage ⁽¹⁾ (I _C = 150 mA _{dc} , I _B = 15 mA _{dc}) (I _C = 500 mA _{dc} , I _B = 50 mA _{dc})	V _{CE(sat)}	— —	0.3 1.0	V _{dc}
Base–Emitter Saturation Voltage ⁽¹⁾ (I _C = 150 mA _{dc} , I _B = 15 mA _{dc}) (I _C = 500 mA _{dc} , I _B = 50 mA _{dc})	V _{BE(sat)}	0.6 —	1.2 2.0	V _{dc}

SMALL–SIGNAL CHARACTERISTICS

Current–Gain — Bandwidth Product (I _C = 20 mA _{dc} , V _{CE} = 20 V _{dc} , f = 100 MHz)	f _T	300	—	MHz
Output Capacitance (V _{CB} = 10 V _{dc} , I _E = 0, f = 1.0 MHz)	C _{obo}	—	8.0	pF
Input Capacitance (V _{EB} = 0.5 V _{dc} , I _C = 0, f = 1.0 MHz)	C _{ibo}	—	30	pF
Input Impedance (V _{CE} = 10 V _{dc} , I _C = 10 mA _{dc} , f = 1.0 kHz)	h _{ie}	0.25	1.25	k ohms
Voltage Feedback Ratio (V _{CE} = 10 V _{dc} , I _C = 10 mA _{dc} , f = 1.0 kHz)	h _{re}	—	4.0	X 10 ^{–4}
Small–Signal Current Gain (V _{CE} = 10 V _{dc} , I _C = 10 mA _{dc} , f = 1.0 kHz)	h _{fe}	75	375	—
Output Admittance (V _{CE} = 10 V _{dc} , I _C = 10 mA _{dc} , f = 1.0 kHz)	h _{oe}	25	200	μmhos
Noise Figure (V _{CE} = 10 V _{dc} , I _C = 100 μA _{dc} , R _S = 1.0 k ohms, f = 1.0 kHz)	NF	—	4.0	dB

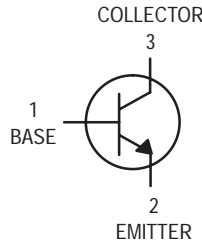
SWITCHING CHARACTERISTICS

Delay Time	(V _{CC} = 3.0 V _{dc} , V _{BE} = –0.5 V _{dc} , I _C = 150 mA _{dc} , I _{B1} = 15 mA _{dc})	t _d	—	10	ns
Rise Time		t _r	—	25	
Storage Time	(V _{CC} = 30 V _{dc} , I _C = 150 mA _{dc} , I _{B1} = I _{B2} = 15 mA _{dc})	t _s	—	225	ns
Fall Time		t _f	—	60	

1. Pulse Test: Pulse Width ≤ 300 μs, Duty Cycle ≤ 2.0%.

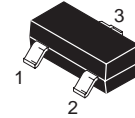
General Purpose Transistors

NPN Silicon



MMBT2222LT1
MMBT2222ALT1*

*Motorola Preferred Device



CASE 318-08, STYLE 6
SOT-23 (TO-236AB)

MAXIMUM RATINGS

Rating	Symbol	2222	2222A	Unit
Collector-Emitter Voltage	V_{CEO}	30	40	Vdc
Collector-Base Voltage	V_{CBO}	60	75	Vdc
Emitter-Base Voltage	V_{EBO}	5.0	6.0	Vdc
Collector Current — Continuous	I_C	600		mAdc

THERMAL CHARACTERISTICS

Characteristic	Symbol	Max	Unit
Total Device Dissipation FR-5 Board ⁽¹⁾ $T_A = 25^\circ\text{C}$ Derate above 25°C	P_D	225	mW
		1.8	mW/ $^\circ\text{C}$
Thermal Resistance, Junction to Ambient	$R_{\theta JA}$	556	$^\circ\text{C}/\text{W}$
Total Device Dissipation Alumina Substrate, ⁽²⁾ $T_A = 25^\circ\text{C}$ Derate above 25°C	P_D	300	mW
		2.4	mW/ $^\circ\text{C}$
Thermal Resistance, Junction to Ambient	$R_{\theta JA}$	417	$^\circ\text{C}/\text{W}$
Junction and Storage Temperature	T_J, T_{stg}	-55 to +150	$^\circ\text{C}$

DEVICE MARKING

MMBT2222LT1 = M1B; MMBT2222ALT1 = 1P

ELECTRICAL CHARACTERISTICS ($T_A = 25^\circ\text{C}$ unless otherwise noted)

Characteristic	Symbol	Min	Max	Unit
----------------	--------	-----	-----	------

OFF CHARACTERISTICS

Collector-Emitter Breakdown Voltage ($I_C = 10 \text{ mAdc}, I_E = 0$)	MMBT2222 MMBT2222A	$V_{(BR)CEO}$	30 40	— —	Vdc
Collector-Base Breakdown Voltage ($I_C = 10 \text{ }\mu\text{Adc}, I_E = 0$)	MMBT2222 MMBT2222A	$V_{(BR)CBO}$	60 75	— —	Vdc
Emitter-Base Breakdown Voltage ($I_E = 10 \text{ }\mu\text{Adc}, I_C = 0$)	MMBT2222 MMBT2222A	$V_{(BR)EBO}$	5.0 6.0	— —	Vdc
Collector Cutoff Current ($V_{CE} = 60 \text{ Vdc}, V_{EB(off)} = 3.0 \text{ Vdc}$)	MMBT2222A	I_{CEX}	—	10	nAdc
Collector Cutoff Current ($V_{CB} = 50 \text{ Vdc}, I_E = 0$) ($V_{CB} = 60 \text{ Vdc}, I_E = 0$) ($V_{CB} = 50 \text{ Vdc}, I_E = 0, T_A = 125^\circ\text{C}$) ($V_{CB} = 60 \text{ Vdc}, I_E = 0, T_A = 125^\circ\text{C}$)	MMBT2222 MMBT2222A MMBT2222 MMBT2222A	I_{CBO}	— — — —	0.01 0.01 10 10	μAdc
Emitter Cutoff Current ($V_{EB} = 3.0 \text{ Vdc}, I_C = 0$)	MMBT2222A	I_{EBO}	—	100	nAdc
Base Cutoff Current ($V_{CE} = 60 \text{ Vdc}, V_{EB(off)} = 3.0 \text{ Vdc}$)	MMBT2222A	I_{BL}	—	20	nAdc

1. FR-5 = $1.0 \times 0.75 \times 0.062 \text{ in.}$

2. Alumina = $0.4 \times 0.3 \times 0.024 \text{ in.}$ 99.5% alumina.

Preferred devices are Motorola recommended choices for future use and best overall value.

MMBT2222LT1 MMBT2222ALT1
ELECTRICAL CHARACTERISTICS ($T_A = 25^\circ\text{C}$ unless otherwise noted) (Continued)

Characteristic	Symbol	Min	Max	Unit
ON CHARACTERISTICS				
DC Current Gain ($I_C = 0.1\text{ mAdc}$, $V_{CE} = 10\text{ Vdc}$) ($I_C = 1.0\text{ mAdc}$, $V_{CE} = 10\text{ Vdc}$) ($I_C = 10\text{ mAdc}$, $V_{CE} = 10\text{ Vdc}$) ($I_C = 10\text{ mAdc}$, $V_{CE} = 10\text{ Vdc}$, $T_A = -55^\circ\text{C}$) ($I_C = 150\text{ mAdc}$, $V_{CE} = 10\text{ Vdc}$) (3) ($I_C = 150\text{ mAdc}$, $V_{CE} = 1.0\text{ Vdc}$) (3) ($I_C = 500\text{ mAdc}$, $V_{CE} = 10\text{ Vdc}$) (3)	h_{FE}	35 50 75 35 100 50 30 40	— — — — 300 — — —	—
Collector–Emitter Saturation Voltage (3) ($I_C = 150\text{ mAdc}$, $I_B = 15\text{ mAdc}$) ($I_C = 500\text{ mAdc}$, $I_B = 50\text{ mAdc}$)	$V_{CE(sat)}$	— — — —	0.4 0.3 1.6 1.0	Vdc
Base–Emitter Saturation Voltage (3) ($I_C = 150\text{ mAdc}$, $I_B = 15\text{ mAdc}$) ($I_C = 500\text{ mAdc}$, $I_B = 50\text{ mAdc}$)	$V_{BE(sat)}$	— 0.6 — —	1.3 1.2 2.6 2.0	Vdc

SMALL–SIGNAL CHARACTERISTICS

Current–Gain — Bandwidth Product (4) ($I_C = 20\text{ mAdc}$, $V_{CE} = 20\text{ Vdc}$, $f = 100\text{ MHz}$)	f_T	250 300	— —	MHz
Output Capacitance ($V_{CB} = 10\text{ Vdc}$, $I_E = 0$, $f = 1.0\text{ MHz}$)	C_{obo}	—	8.0	pF
Input Capacitance ($V_{EB} = 0.5\text{ Vdc}$, $I_C = 0$, $f = 1.0\text{ MHz}$)	C_{ibo}	— —	30 25	pF
Input Impedance ($I_C = 1.0\text{ mAdc}$, $V_{CE} = 10\text{ Vdc}$, $f = 1.0\text{ kHz}$) ($I_C = 10\text{ mAdc}$, $V_{CE} = 10\text{ Vdc}$, $f = 1.0\text{ kHz}$)	h_{ie}	2.0 0.25	8.0 1.25	k Ω
Voltage Feedback Ratio ($I_C = 1.0\text{ mAdc}$, $V_{CE} = 10\text{ Vdc}$, $f = 1.0\text{ kHz}$) ($I_C = 10\text{ mAdc}$, $V_{CE} = 10\text{ Vdc}$, $f = 1.0\text{ kHz}$)	h_{re}	— —	8.0 4.0	$\times 10^{-4}$
Small–Signal Current Gain ($I_C = 1.0\text{ mAdc}$, $V_{CE} = 10\text{ Vdc}$, $f = 1.0\text{ kHz}$) ($I_C = 10\text{ mAdc}$, $V_{CE} = 10\text{ Vdc}$, $f = 1.0\text{ kHz}$)	h_{fe}	50 75	300 375	—
Output Admittance ($I_C = 1.0\text{ mAdc}$, $V_{CE} = 10\text{ Vdc}$, $f = 1.0\text{ kHz}$) ($I_C = 10\text{ mAdc}$, $V_{CE} = 10\text{ Vdc}$, $f = 1.0\text{ kHz}$)	h_{oe}	5.0 25	35 200	μmhos
Collector Base Time Constant ($I_E = 20\text{ mAdc}$, $V_{CB} = 20\text{ Vdc}$, $f = 31.8\text{ MHz}$)	r_b, C_C	—	150	ps
Noise Figure ($I_C = 100\text{ }\mu\text{A}$, $V_{CE} = 10\text{ Vdc}$, $R_S = 1.0\text{ k}\Omega$, $f = 1.0\text{ kHz}$)	NF	—	4.0	dB

SWITCHING CHARACTERISTICS (MMBT2222A only)

Delay Time	$(V_{CC} = 30\text{ Vdc}$, $V_{BE(off)} = -0.5\text{ Vdc}$, $I_C = 150\text{ mAdc}$, $I_{B1} = 15\text{ mAdc}$)	t_d	—	10	ns
Rise Time		t_r	—	25	
Storage Time	$(V_{CC} = 30\text{ Vdc}$, $I_C = 150\text{ mAdc}$, $I_{B1} = I_{B2} = 15\text{ mAdc}$)	t_s	—	225	ns
Fall Time		t_f	—	60	

 3. Pulse Test: Pulse Width $\leq 300\text{ }\mu\text{s}$, Duty Cycle $\leq 2.0\%$.

 4. f_T is defined as the frequency at which $|h_{fe}|$ extrapolates to unity.

SWITCHING TIME EQUIVALENT TEST CIRCUITS

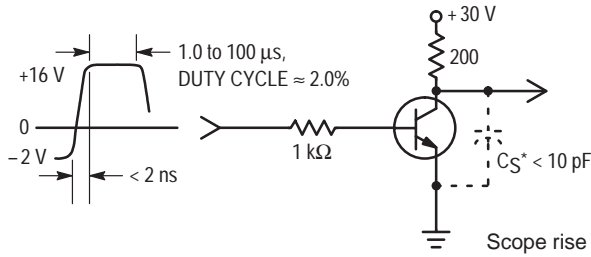


Figure 1. Turn-On Time

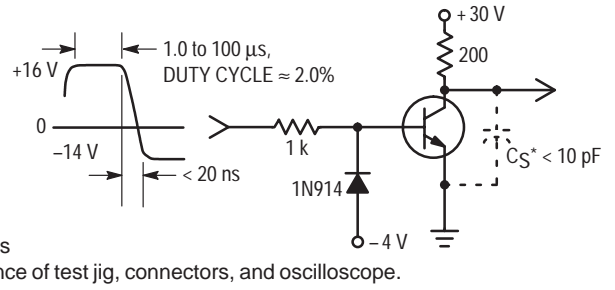


Figure 2. Turn-Off Time

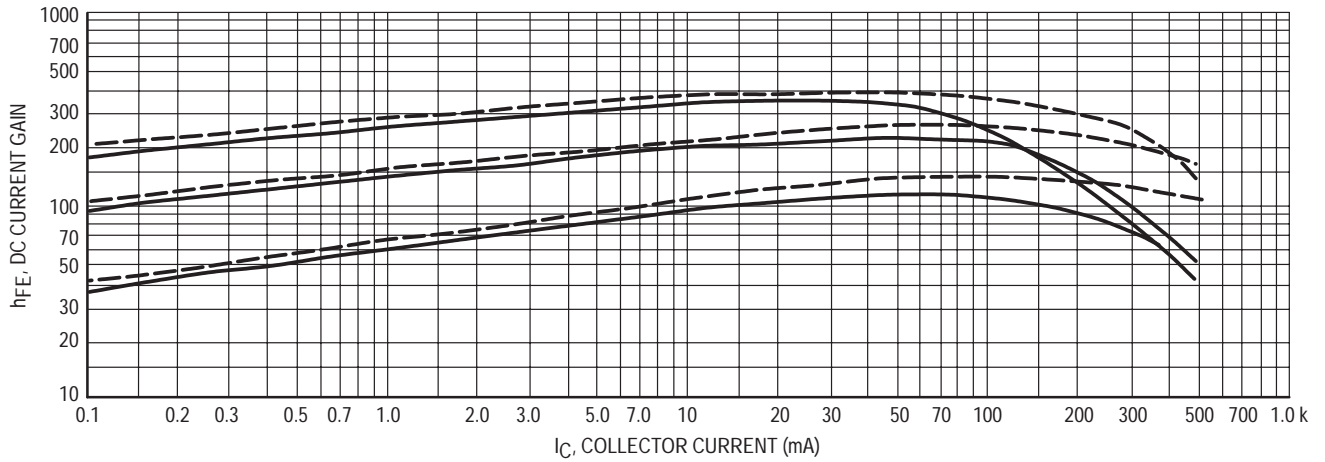


Figure 3. DC Current Gain

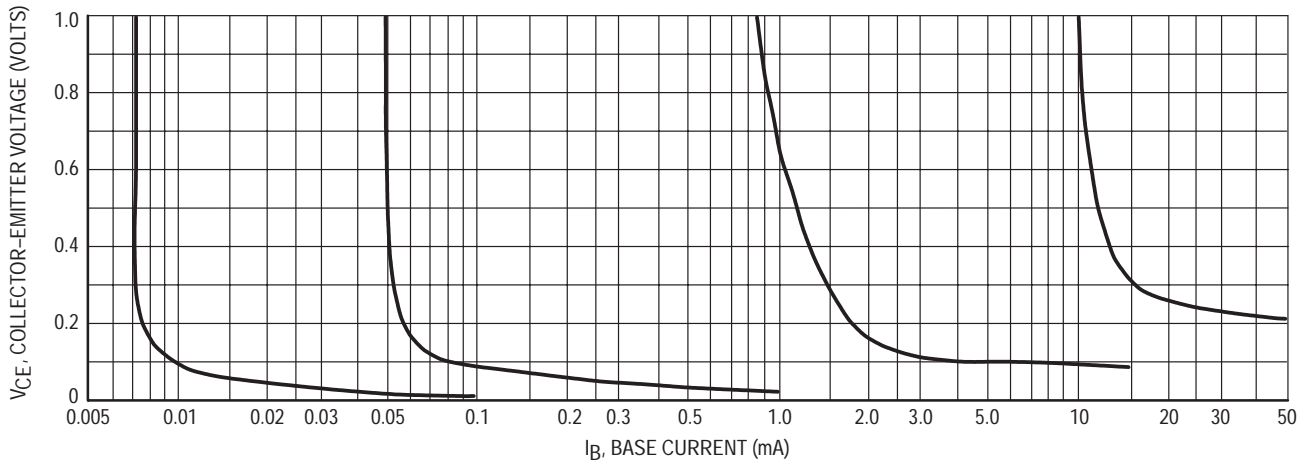


Figure 4. Collector Saturation Region

MMBT2222LT1 MMBT2222ALT1

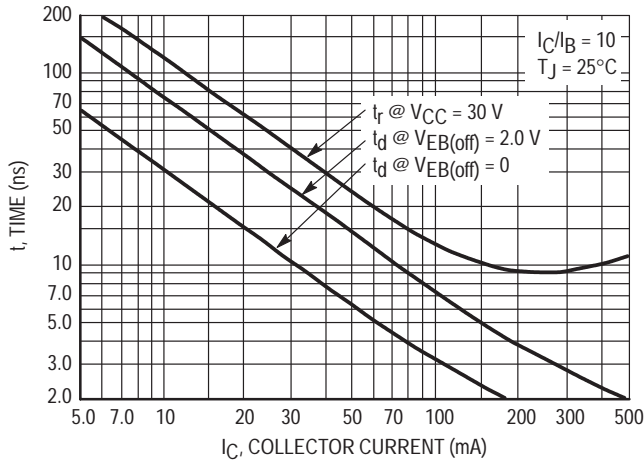


Figure 5. Turn-On Time

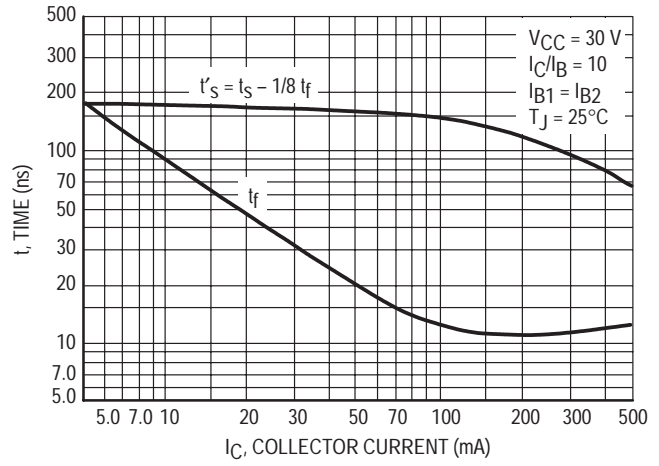


Figure 6. Turn-Off Time

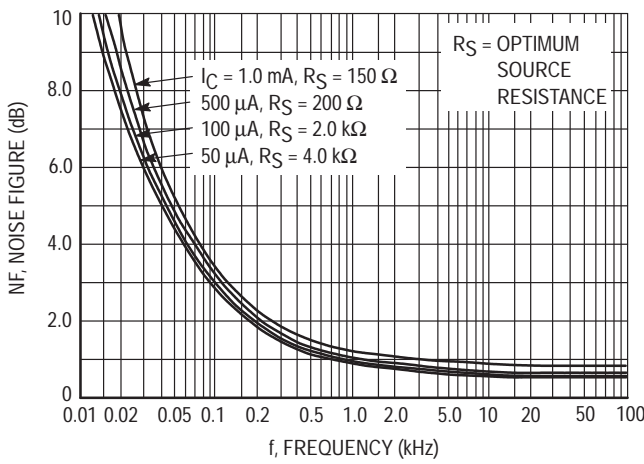


Figure 7. Frequency Effects

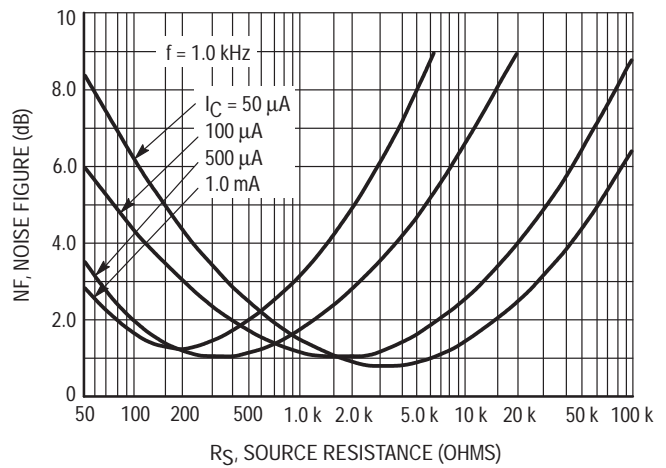


Figure 8. Source Resistance Effects

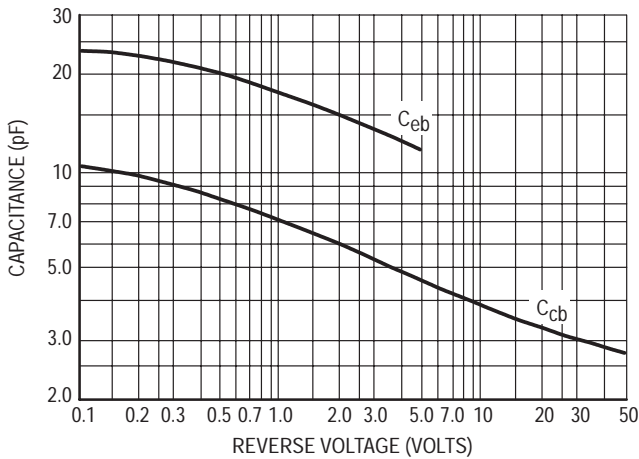


Figure 9. Capacitances

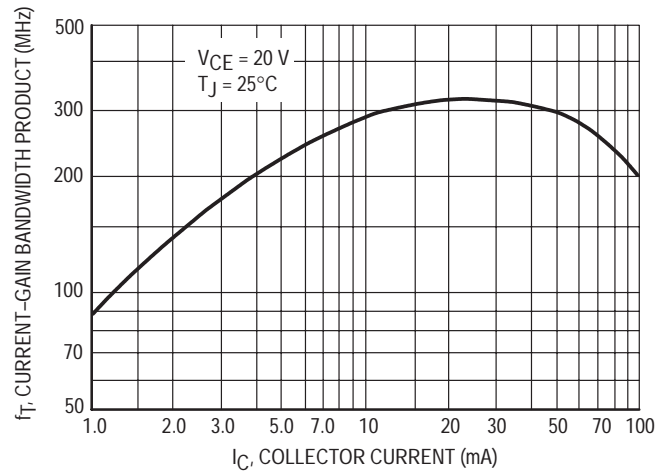


Figure 10. Current-Gain Bandwidth Product

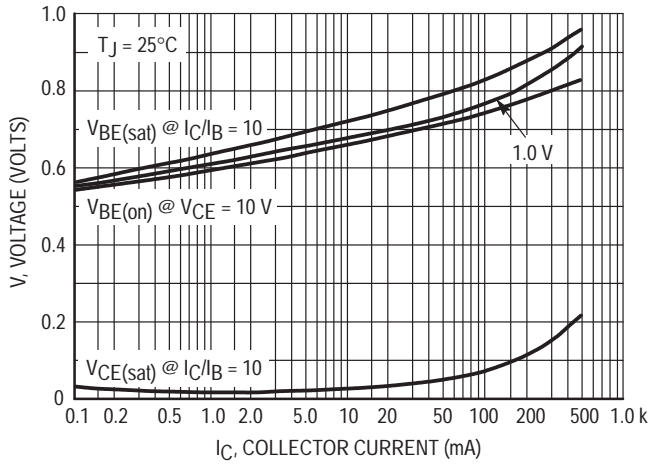


Figure 11. "On" Voltages

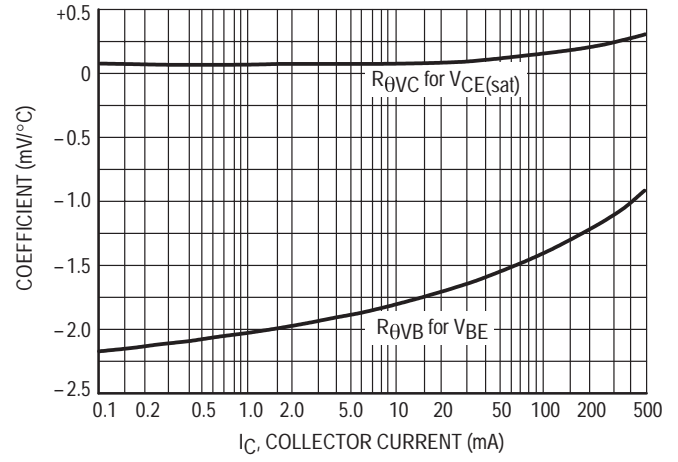
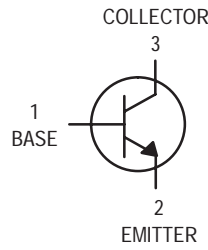


Figure 12. Temperature Coefficients

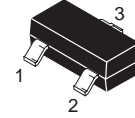
Switching Transistors

NPN Silicon



MMBT2369LT1
MMBT2369ALT1*

*Motorola Preferred Device



CASE 318-08, STYLE 6
SOT-23 (TO-236AB)

MAXIMUM RATINGS

Rating	Symbol	Value	Unit
Collector-Emitter Voltage	V_{CEO}	15	Vdc
Collector-Emitter Voltage	V_{CES}	40	Vdc
Collector-Base Voltage	V_{CBO}	40	Vdc
Emitter-Base Voltage	V_{EBO}	4.5	Vdc
Collector Current — Continuous	I_C	200	mAdc

THERMAL CHARACTERISTICS

Characteristic	Symbol	Max	Unit
Total Device Dissipation FR-5 Board ⁽¹⁾ $T_A = 25^\circ\text{C}$ Derate above 25°C	P_D	225	mW
		1.8	mW/ $^\circ\text{C}$
Thermal Resistance, Junction to Ambient	$R_{\theta JA}$	556	$^\circ\text{C}/\text{W}$
Total Device Dissipation Alumina Substrate, ⁽²⁾ $T_A = 25^\circ\text{C}$ Derate above 25°C	P_D	300	mW
		2.4	mW/ $^\circ\text{C}$
Thermal Resistance, Junction to Ambient	$R_{\theta JA}$	417	$^\circ\text{C}/\text{W}$
Junction and Storage Temperature	T_J, T_{stg}	-55 to +150	$^\circ\text{C}$

DEVICE MARKING

MMBT2369LT1 = M1J; MMBT2369ALT1 = 1JA

ELECTRICAL CHARACTERISTICS ($T_A = 25^\circ\text{C}$ unless otherwise noted)

Characteristic	Symbol	Min	Typ	Max	Unit
----------------	--------	-----	-----	-----	------

OFF CHARACTERISTICS

Collector-Emitter Breakdown Voltage (3) ($I_C = 10 \text{ mAdc}, I_B = 0$)	$V_{(BR)CEO}$	15	—	—	Vdc
Collector-Emitter Breakdown Voltage ($I_C = 10 \mu\text{Adc}, V_{BE} = 0$)	$V_{(BR)CES}$	40	—	—	Vdc
Collector-Base Breakdown Voltage ($I_C = 10 \mu\text{Adc}, I_E = 0$)	$V_{(BR)CBO}$	40	—	—	Vdc
Emitter-Base Breakdown Voltage ($I_E = 10 \mu\text{Adc}, I_C = 0$)	$V_{(BR)EBO}$	4.5	—	—	Vdc
Collector Cutoff Current ($V_{CB} = 20 \text{ Vdc}, I_E = 0$) ($V_{CB} = 20 \text{ Vdc}, I_E = 0, T_A = 150^\circ\text{C}$)	I_{CBO}	—	—	0.4 30	μAdc
Collector Cutoff Current ($V_{CE} = 20 \text{ Vdc}, V_{BE} = 0$)	I_{CES}	—	—	0.4	μAdc

1. FR-5 = $1.0 \times 0.75 \times 0.062 \text{ in.}$

2. Alumina = $0.4 \times 0.3 \times 0.024 \text{ in. 99.5\% alumina.}$

3. Pulse Test: Pulse Width $\leq 300 \mu\text{s}$, Duty Cycle $\leq 2.0\%$.

Preferred devices are Motorola recommended choices for future use and best overall value.

ELECTRICAL CHARACTERISTICS (continued) ($T_A = 25^\circ\text{C}$ unless otherwise noted)

Characteristic	Symbol	Min	Typ	Max	Unit	
ON CHARACTERISTICS						
DC Current Gain (3) ($I_C = 10\text{ mA}$, $V_{CE} = 1.0\text{ Vdc}$) ($I_C = 10\text{ mA}$, $V_{CE} = 1.0\text{ Vdc}$) ($I_C = 10\text{ mA}$, $V_{CE} = 0.35\text{ Vdc}$) ($I_C = 10\text{ mA}$, $V_{CE} = 0.35\text{ Vdc}$, $T_A = -55^\circ\text{C}$) ($I_C = 30\text{ mA}$, $V_{CE} = 0.4\text{ Vdc}$) ($I_C = 100\text{ mA}$, $V_{CE} = 2.0\text{ Vdc}$) ($I_C = 100\text{ mA}$, $V_{CE} = 1.0\text{ Vdc}$)	MMBT2369 MMBT2369A MMBT2369A MMBT2369A MMBT2369A MMBT2369 MMBT2369A	h_{FE}	40 — 40 20 30 20 20	— — — — — — —	120 120 — — — — —	—
Collector–Emitter Saturation Voltage (3) ($I_C = 10\text{ mA}$, $I_B = 1.0\text{ mA}$) ($I_C = 10\text{ mA}$, $I_B = 1.0\text{ mA}$) ($I_C = 10\text{ mA}$, $I_B = 1.0\text{ mA}$, $T_A = +125^\circ\text{C}$) ($I_C = 30\text{ mA}$, $I_B = 3.0\text{ mA}$) ($I_C = 100\text{ mA}$, $I_B = 10\text{ mA}$)	MMBT2369 MMBT2369A MMBT2369A MMBT2369A MMBT2369A	$V_{CE(sat)}$	— — — — —	— — — — —	0.25 0.20 0.30 0.25 0.50	Vdc
Base–Emitter Saturation Voltage (3) ($I_C = 10\text{ mA}$, $I_B = 1.0\text{ mA}$) ($I_C = 10\text{ mA}$, $I_B = 1.0\text{ mA}$, $T_A = -55^\circ\text{C}$) ($I_C = 30\text{ mA}$, $I_B = 3.0\text{ mA}$) ($I_C = 100\text{ mA}$, $I_B = 10\text{ mA}$)	MMBT2369A MMBT2369A MMBT2369A MMBT2369A	$V_{BE(sat)}$	0.7 — — —	— — — —	0.85 1.02 1.15 1.60	Vdc

SMALL–SIGNAL CHARACTERISTICS

Output Capacitance ($V_{CB} = 5.0\text{ Vdc}$, $I_E = 0$, $f = 1.0\text{ MHz}$)	C_{obo}	—	—	4.0	pF
Small Signal Current Gain ($I_C = 10\text{ mA}$, $V_{CE} = 10\text{ Vdc}$, $f = 100\text{ MHz}$)	h_{fe}	5.0	—	—	—

SWITCHING CHARACTERISTICS

Storage Time ($I_{B1} = I_{B2} = I_C = 10\text{ mA}$)	t_s	—	5.0	13	ns
Turn–On Time ($V_{CC} = 3.0\text{ Vdc}$, $I_C = 10\text{ mA}$, $I_{B1} = 3.0\text{ mA}$)	t_{on}	—	8.0	12	ns
Turn–Off Time ($V_{CC} = 3.0\text{ Vdc}$, $I_C = 10\text{ mA}$, $I_{B1} = 3.0\text{ mA}$, $I_{B2} = 1.5\text{ mA}$)	t_{off}	—	10	18	ns

3. Pulse Test: Pulse Width $\leq 300\ \mu\text{s}$, Duty Cycle $\leq 2.0\%$.

SWITCHING TIME EQUIVALENT TEST CIRCUITS FOR 2N2369, 2N3227

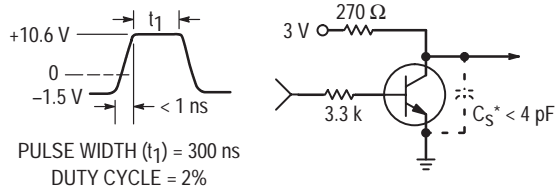


Figure 1. t_{on} Circuit — 10 mA

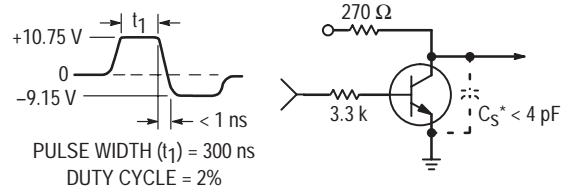


Figure 3. t_{off} Circuit — 10 mA

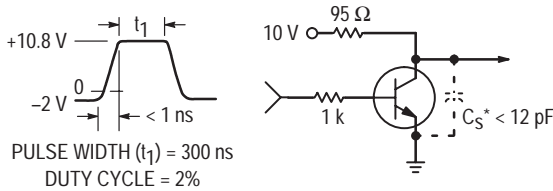


Figure 2. t_{on} Circuit — 100 mA

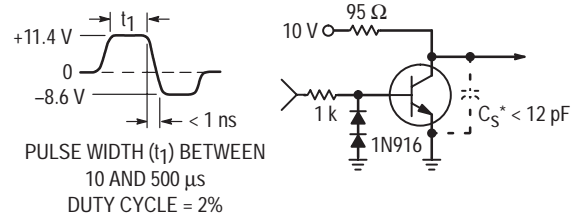


Figure 4. t_{off} Circuit — 100 mA

* Total shunt capacitance of test jig and connectors.

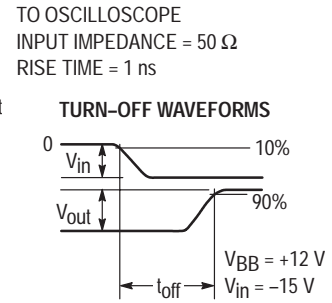
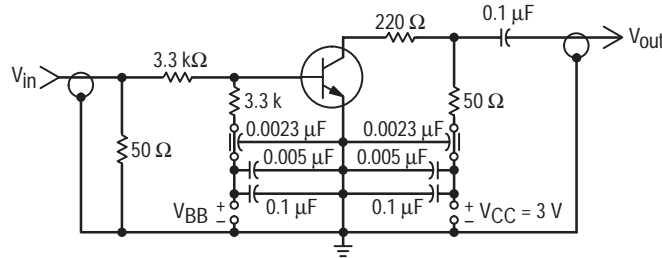
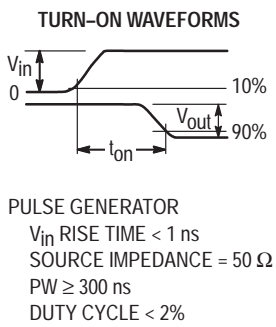


Figure 5. Turn-On and Turn-Off Time Test Circuit

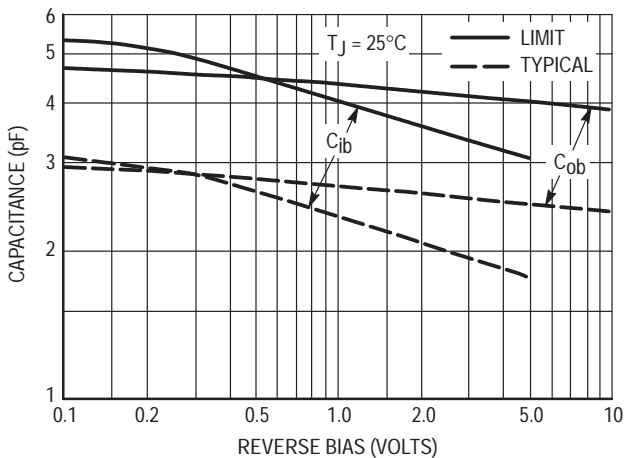


Figure 6. Junction Capacitance Variations

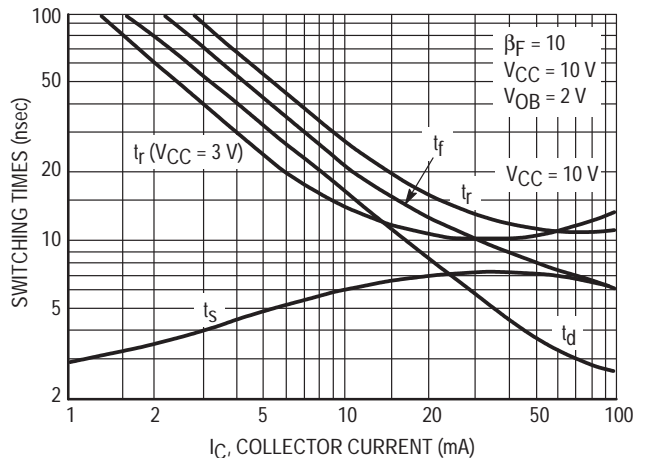


Figure 7. Typical Switching Times

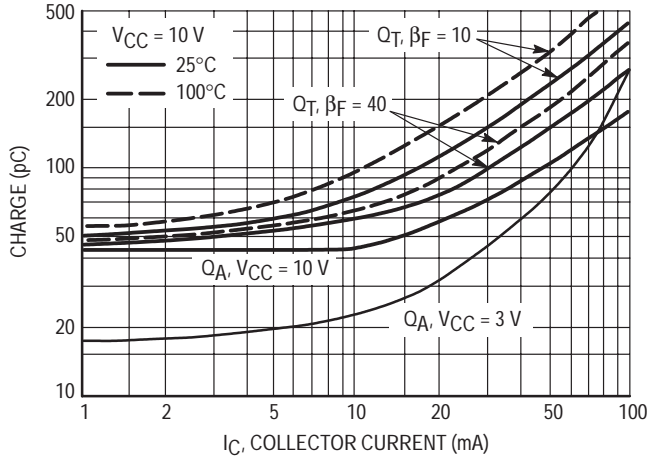


Figure 8. Maximum Charge Data

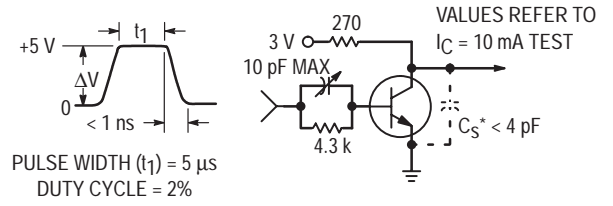


Figure 9. Q_T Test Circuit

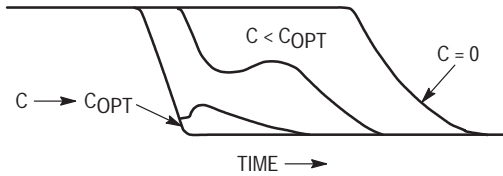


Figure 10. Turn-Off Waveform

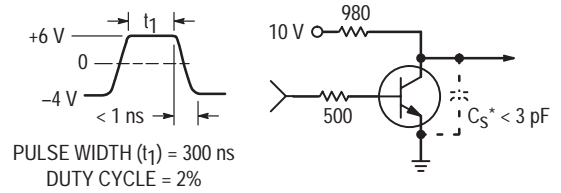


Figure 11. Storage Time Equivalent Test Circuit

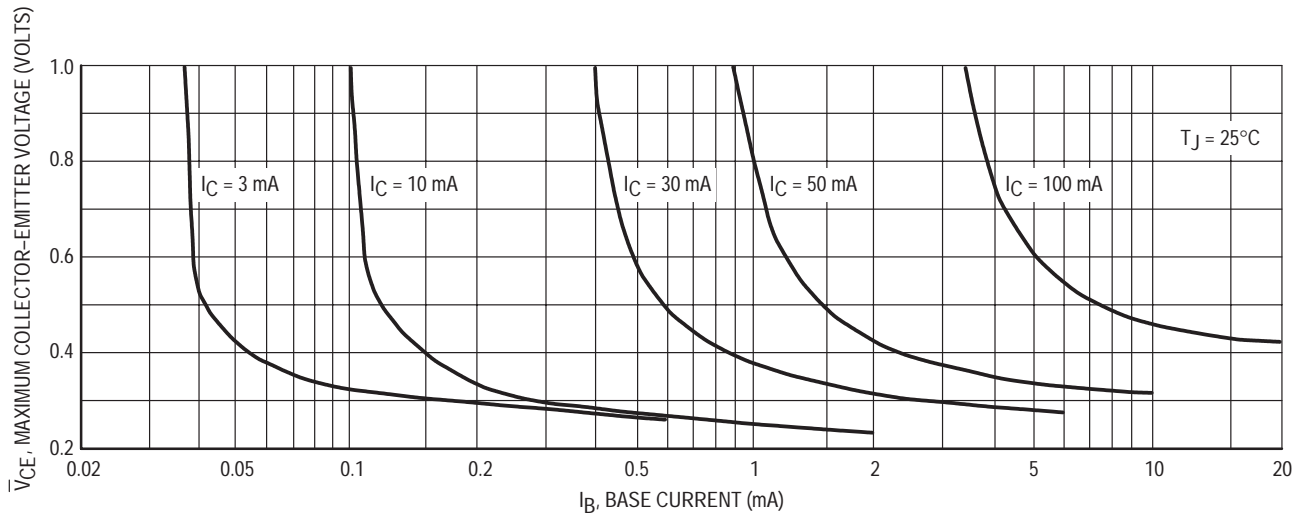


Figure 12. Maximum Collector Saturation Voltage Characteristics

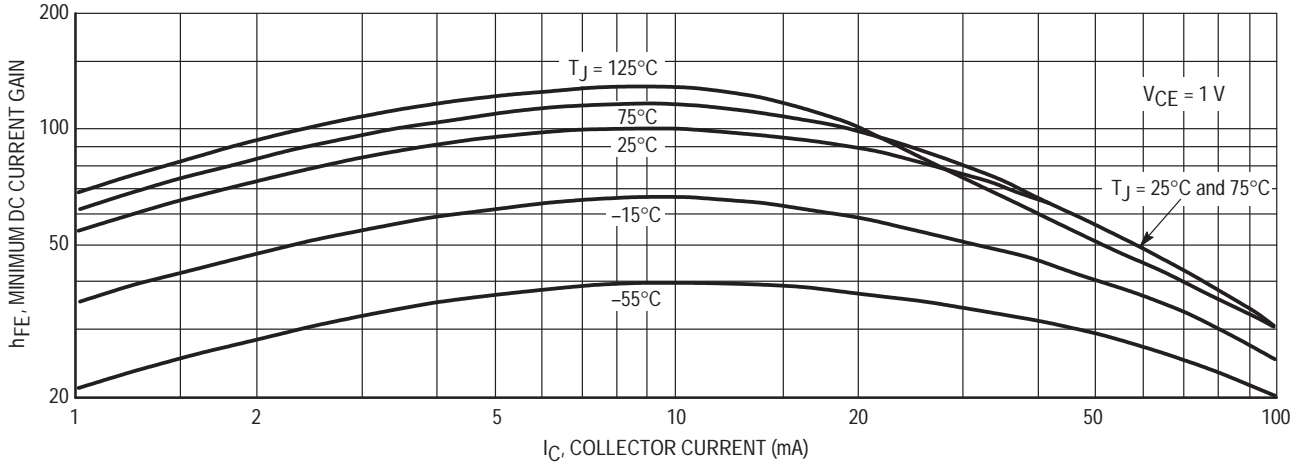


Figure 13. Minimum Current Gain Characteristics

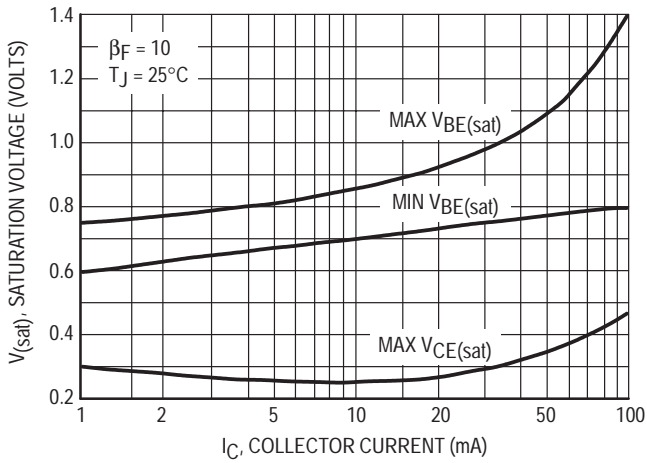


Figure 14. Saturation Voltage Limits

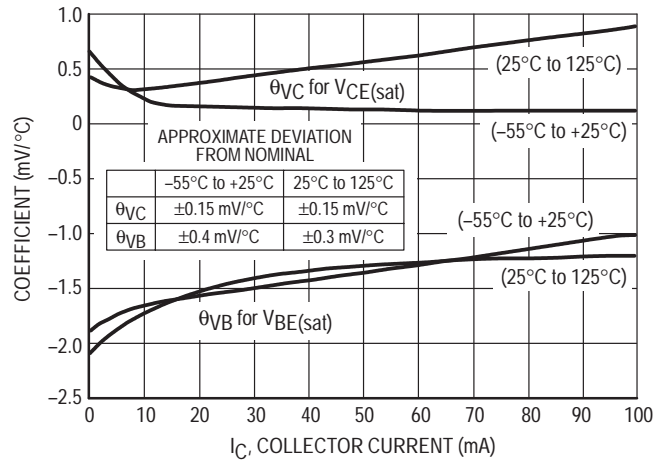
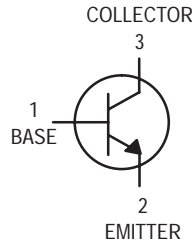


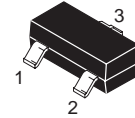
Figure 15. Typical Temperature Coefficients

Low Noise Transistor

NPN Silicon



MMBT2484LT1



CASE 318-08, STYLE 6
SOT-23 (TO-236AB)

MAXIMUM RATINGS

Rating	Symbol	Value	Unit
Collector–Emitter Voltage	V_{CEO}	60	Vdc
Collector–Base Voltage	V_{CBO}	60	Vdc
Emitter–Base Voltage	V_{EBO}	6.0	Vdc
Collector Current — Continuous	I_C	50	mAdc

THERMAL CHARACTERISTICS

Characteristic	Symbol	Max	Unit
Total Device Dissipation FR-5 Board ⁽¹⁾ $T_A = 25^\circ\text{C}$ Derate above 25°C	P_D	225	mW
		1.8	mW/ $^\circ\text{C}$
Thermal Resistance, Junction to Ambient	$R_{\theta JA}$	556	$^\circ\text{C}/\text{W}$
Total Device Dissipation Alumina Substrate, ⁽²⁾ $T_A = 25^\circ\text{C}$ Derate above 25°C	P_D	300	mW
		2.4	mW/ $^\circ\text{C}$
Thermal Resistance, Junction to Ambient	$R_{\theta JA}$	417	$^\circ\text{C}/\text{W}$
Junction and Storage Temperature	T_J, T_{stg}	-55 to +150	$^\circ\text{C}$

DEVICE MARKING

MMBT2484LT1 = 1U

ELECTRICAL CHARACTERISTICS ($T_A = 25^\circ\text{C}$ unless otherwise noted)

Characteristic	Symbol	Min	Max	Unit
----------------	--------	-----	-----	------

OFF CHARACTERISTICS

Collector–Emitter Breakdown Voltage ($I_C = 10 \text{ mAdc}, I_B = 0$)	$V_{(BR)CEO}$	60	—	Vdc
Collector–Base Breakdown Voltage ($I_C = 10 \text{ } \mu\text{Adc}, I_E = 0$)	$V_{(BR)CBO}$	60	—	Vdc
Emitter–Base Breakdown Voltage ($I_E = 10 \text{ } \mu\text{Adc}, I_C = 0$)	$V_{(BR)EBO}$	5.0	—	Vdc
Collector Cutoff Current ($V_{CB} = 45 \text{ Vdc}, I_E = 0$) ($V_{CB} = 45 \text{ Vdc}, I_E = 0, T_A = 150^\circ\text{C}$)	I_{CBO}	—	10	nAdc
		—	10	μAdc
Emitter Cutoff Current ($V_{EB} = 5.0 \text{ Vdc}, I_C = 0$)	I_{EBO}	—	10	nAdc

1. FR-5 = $1.0 \times 0.75 \times 0.062 \text{ in.}$

2. Alumina = $0.4 \times 0.3 \times 0.024 \text{ in.}$ 99.5% alumina.

MMBT2484LT1

ELECTRICAL CHARACTERISTICS (continued) ($T_A = 25^\circ\text{C}$ unless otherwise noted)

Characteristic	Symbol	Min	Max	Unit
ON CHARACTERISTICS				
DC Current Gain ($I_C = 1.0 \text{ mA}$, $V_{CE} = 5.0 \text{ Vdc}$) ($I_C = 10 \text{ mA}$, $V_{CE} = 5.0 \text{ Vdc}$)	h_{FE}	250 —	— 800	—
Collector–Emitter Saturation Voltage ($I_C = 1.0 \text{ mA}$, $I_B = 0.1 \text{ mA}$)	$V_{CE(sat)}$	—	0.35	Vdc
Base–Emitter On Voltage ($I_C = 1.0 \text{ mA}$, $V_{CE} = 5.0 \text{ Vdc}$)	$V_{BE(on)}$	—	0.95	Vdc

SMALL–SIGNAL CHARACTERISTICS

Output Capacitance ($V_{CB} = 5.0 \text{ Vdc}$, $I_E = 0$, $f = 1.0 \text{ MHz}$)	C_{obo}	—	6.0	pF
Input Capacitance ($V_{EB} = 0.5 \text{ Vdc}$, $I_C = 0$, $f = 1.0 \text{ MHz}$)	C_{ibo}	—	6.0	pF
Noise Figure ($I_C = 10 \text{ }\mu\text{A}$, $V_{CE} = 5.0 \text{ Vdc}$, $R_S = 10 \text{ k}\Omega$, $f = 1.0 \text{ kHz}$, $BW = 200 \text{ Hz}$)	NF	—	3.0	dB

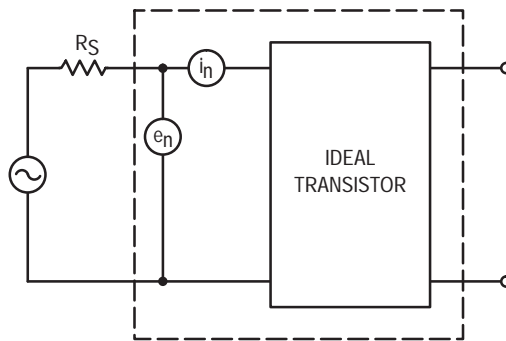


Figure 1. Transistor Noise Model

NOISE CHARACTERISTICS

($V_{CE} = 5.0 \text{ Vdc}$, $T_A = 25^\circ\text{C}$)

NOISE VOLTAGE

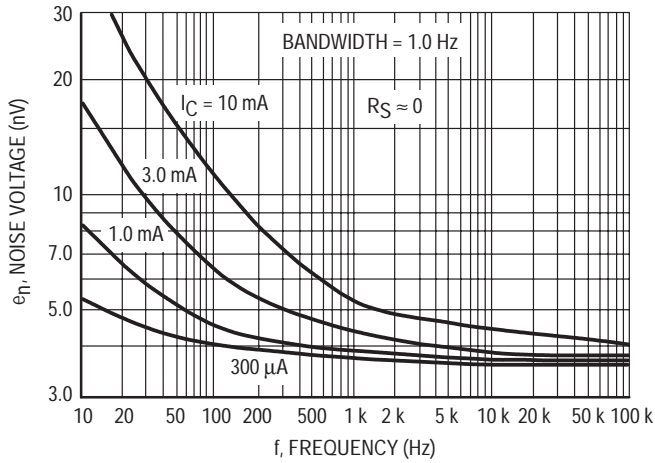


Figure 2. Effects of Frequency

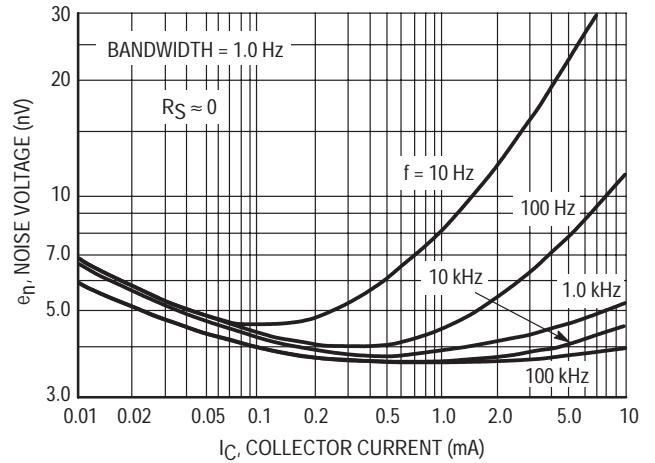


Figure 3. Effects of Collector Current

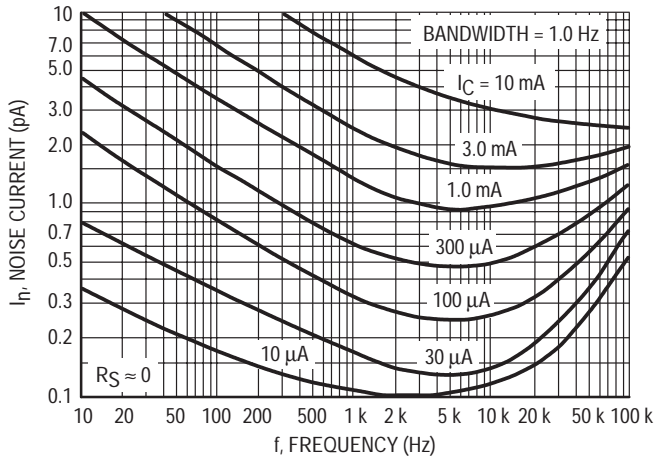


Figure 4. Noise Current

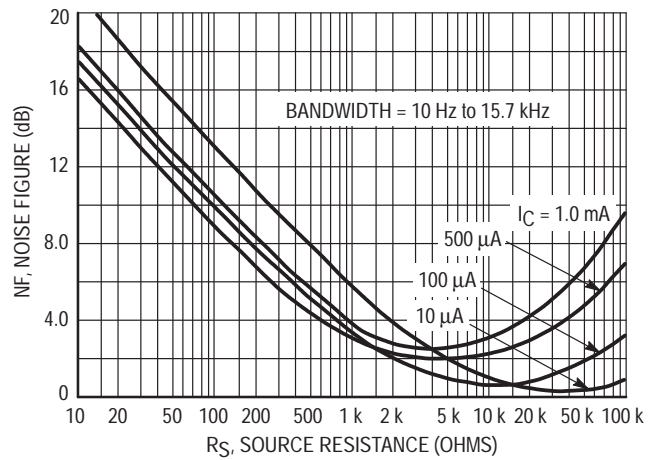


Figure 5. Wideband Noise Figure

100 Hz NOISE DATA

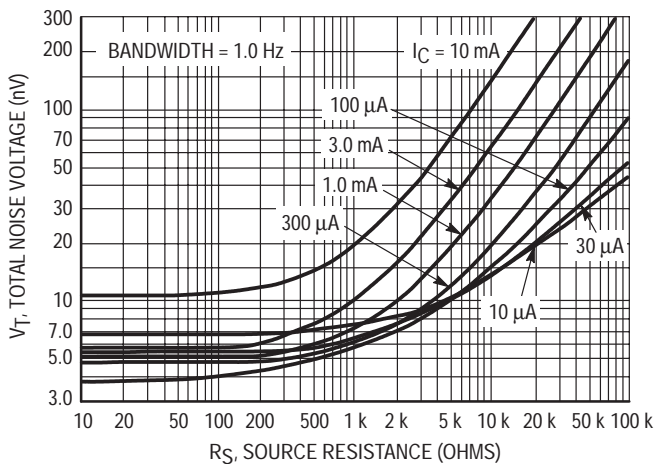


Figure 6. Total Noise Voltage

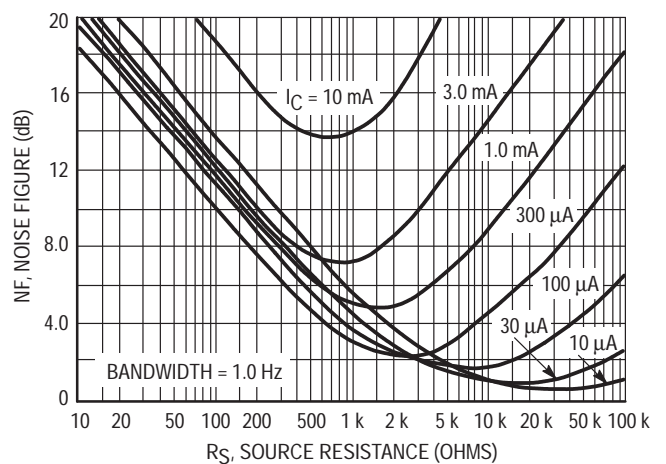


Figure 7. Noise Figure

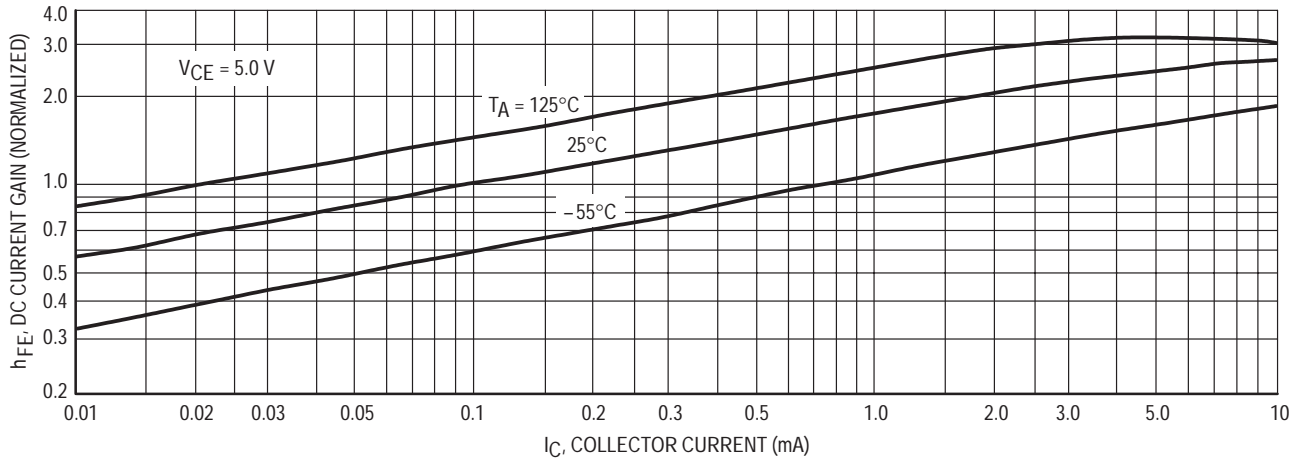


Figure 8. DC Current Gain

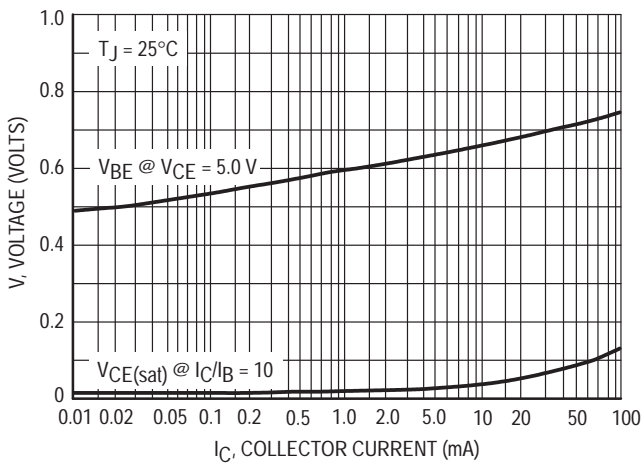


Figure 9. "On" Voltages

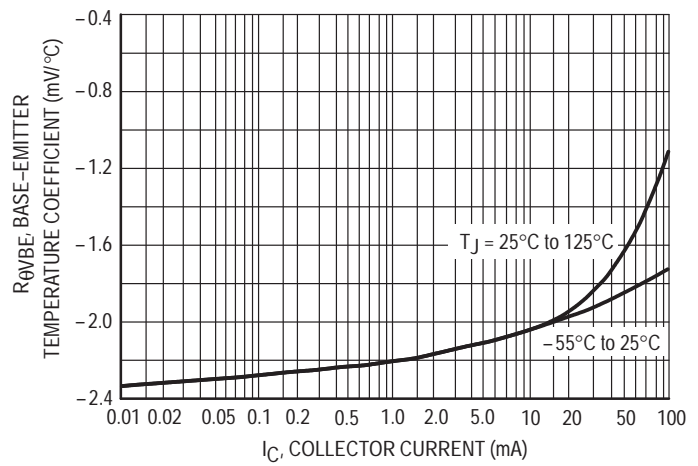


Figure 10. Temperature Coefficients

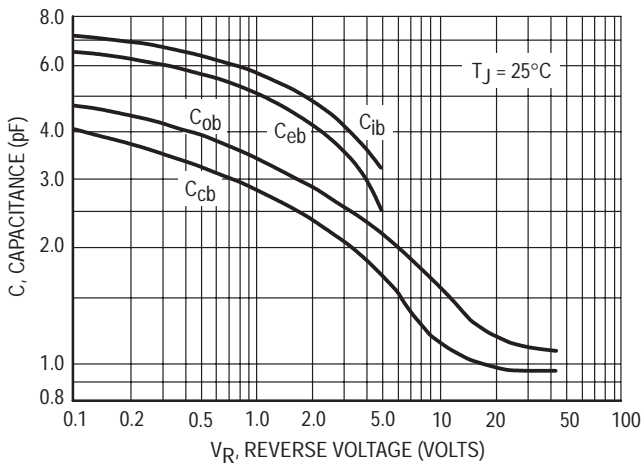


Figure 11. Capacitance

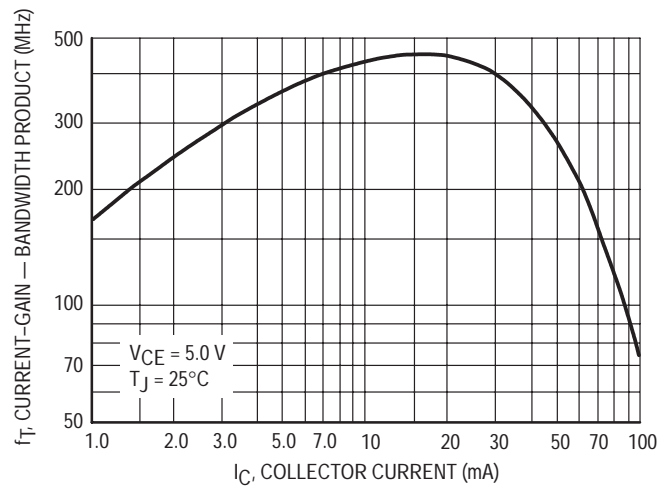
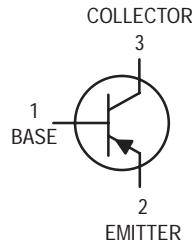


Figure 12. Current-Gain — Bandwidth Product

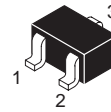
Preliminary Information
General Purpose Transistor
PNP Silicon

These transistors are designed for general purpose amplifier applications. They are housed in the SOT-323/SC-70 package which is designed for low power surface mount applications.



MMBT2907AWT1

Motorola Preferred Device



CASE 419-02, STYLE 3
SOT-323/SC-70

MAXIMUM RATINGS

Rating	Symbol	Value	Unit
Collector–Emitter Voltage	V_{CEO}	-60	Vdc
Collector–Base Voltage	V_{CBO}	-60	Vdc
Emitter–Base Voltage	V_{EBO}	-5.0	Vdc
Collector Current — Continuous	I_C	-600	mAdc

THERMAL CHARACTERISTICS

Characteristic	Symbol	Max	Unit
Total Device Dissipation FR-5 Board ⁽¹⁾ $T_A = 25^\circ\text{C}$	P_D	150	mW
Thermal Resistance Junction to Ambient	$R_{\theta JA}$	833	$^\circ\text{C/W}$
Junction and Storage Temperature	T_J, T_{stg}	-55 to +150	$^\circ\text{C}$

DEVICE MARKING

MMBT2907AWT1 = 2F

ELECTRICAL CHARACTERISTICS ($T_A = 25^\circ\text{C}$ unless otherwise noted)

Characteristic	Symbol	Min	Max	Unit
----------------	--------	-----	-----	------

OFF CHARACTERISTICS

Collector–Emitter Breakdown Voltage ⁽²⁾ ($I_C = -10 \text{ mAdc}, I_B = 0$)	$V_{(BR)CEO}$	-60	—	Vdc
Collector–Base Breakdown Voltage ($I_C = -10 \text{ mAdc}, I_E = 0$)	$V_{(BR)CBO}$	-60	—	Vdc
Emitter–Base Breakdown Voltage ($I_E = -10 \mu\text{Adc}, I_C = 0$)	$V_{(BR)EBO}$	-5.0	—	Vdc
Base Cutoff Current ($V_{CE} = -30 \text{ Vdc}, V_{EB(off)} = -0.5 \text{ Vdc}$)	I_{BL}	—	-50	nAdc
Collector Cutoff Current ($V_{CE} = -30 \text{ Vdc}, V_{EB(off)} = -0.5 \text{ Vdc}$)	I_{CEX}	—	-50	nAdc

1. FR-5 = 1.0 x 0.75 x 0.062 in.

2. Pulse Test: Pulse Width $\leq 300 \mu\text{s}$, Duty Cycle $\leq 2.0\%$.

Preferred devices are Motorola recommended choices for future use and best overall value.

MMBT2907AWT1

ELECTRICAL CHARACTERISTICS ($T_A = 25^\circ\text{C}$ unless otherwise noted) (Continued)

Characteristic	Symbol	Min	Max	Unit
ON CHARACTERISTICS(1)				
DC Current Gain (1) ($I_C = -0.1 \text{ mAdc}$, $V_{CE} = -10 \text{ Vdc}$) ($I_C = -1.0 \text{ mAdc}$, $V_{CE} = -10 \text{ Vdc}$) ($I_C = -10 \text{ mAdc}$, $V_{CE} = -10 \text{ Vdc}$) ($I_C = -150 \text{ mAdc}$, $V_{CE} = -10 \text{ Vdc}$) ($I_C = -500 \text{ mAdc}$, $V_{CE} = -10 \text{ Vdc}$)	H_{FE}	75 100 100 100 50	— — — — —	—
Collector–Emitter Saturation Voltage ⁽¹⁾ ($I_C = -150 \text{ mAdc}$, $I_B = -15 \text{ mAdc}$) ($I_C = -500 \text{ mAdc}$, $I_B = -50 \text{ mAdc}$)	$V_{CE(sat)}$	— —	-0.4 -1.6	Vdc
Base–Emitter Saturation Voltage ⁽¹⁾ ($I_C = -150 \text{ mAdc}$, $I_B = -15 \text{ mAdc}$) ($I_C = -500 \text{ mAdc}$, $I_B = -50 \text{ mAdc}$)	$V_{BE(sat)}$	— —	-1.3 -2.6	Vdc

SMALL–SIGNAL CHARACTERISTICS

Current–Gain — Bandwidth Product ($I_C = -50 \text{ mAdc}$, $V_{CE} = 20 \text{ Vdc}$, $f = 100 \text{ MHz}$)	f_T	200	—	MHz
Output Capacitance ($V_{CB} = -10 \text{ Vdc}$, $I_E = 0$, $f = 1.0 \text{ MHz}$)	C_{obo}	—	8.0	pF
Input Capacitance ($V_{EB} = -2.0 \text{ Vdc}$, $I_C = 0$, $f = 1.0 \text{ MHz}$)	C_{ibo}	—	30	pF

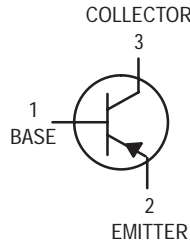
SWITCHING CHARACTERISTICS

Turn–On Time	$(V_{CC} = -30 \text{ Vdc}$, $I_C = -150 \text{ mAdc}$, $I_{B1} = -15 \text{ mAdc}$)	t_{on}	—	45	ns
Delay Time		t_d	—	10	
Rise Time		t_r	—	40	
Storage Time	$(V_{CC} = -6.0 \text{ Vdc}$, $I_C = -150 \text{ mAdc}$, $I_{B1} = I_{B2} = 15 \text{ mAdc}$)	t_s	—	80	
Fall Time		t_f	—	30	
Turn–Off Time		t_{off}	—	100	

1. Pulse Test: Pulse Width $\leq 300 \mu\text{s}$, Duty Cycle $\leq 2.0\%$.

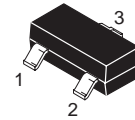
General Purpose Transistors

PNP Silicon



MMBT2907LT1
MMBT2907ALT1*

*Motorola Preferred Device



CASE 318-08, STYLE 6
SOT-23 (TO-236AB)

MAXIMUM RATINGS

Rating	Symbol	2907	2907A	Unit
Collector-Emitter Voltage	V_{CEO}	-40	-60	Vdc
Collector-Base Voltage	V_{CBO}	-60		Vdc
Emitter-Base Voltage	V_{EBO}	-5.0		Vdc
Collector Current — Continuous	I_C	-600		mAdc

THERMAL CHARACTERISTICS

Characteristic	Symbol	Max	Unit
Total Device Dissipation FR-5 Board ⁽¹⁾ $T_A = 25^\circ\text{C}$ Derate above 25°C	P_D	225	mW
		1.8	mW/ $^\circ\text{C}$
Thermal Resistance, Junction to Ambient	$R_{\theta JA}$	556	$^\circ\text{C}/\text{W}$
Total Device Dissipation Alumina Substrate, ⁽²⁾ $T_A = 25^\circ\text{C}$ Derate above 25°C	P_D	300	mW
		2.4	mW/ $^\circ\text{C}$
Thermal Resistance, Junction to Ambient	$R_{\theta JA}$	417	$^\circ\text{C}/\text{W}$
Junction and Storage Temperature	T_J, T_{stg}	-55 to +150	$^\circ\text{C}$

DEVICE MARKING

MMBT2907LT1 = M2B; MMBT2907ALT1 = 2F

ELECTRICAL CHARACTERISTICS ($T_A = 25^\circ\text{C}$ unless otherwise noted)

Characteristic	Symbol	Min	Max	Unit
----------------	--------	-----	-----	------

OFF CHARACTERISTICS

Collector-Emitter Breakdown Voltage ⁽³⁾ ($I_C = -10 \text{ mAdc}, I_E = 0$)	MMBT2907 MMBT2907A	$V_{(BR)CEO}$	-40 -60	— —	Vdc
Collector-Base Breakdown Voltage ($I_C = -10 \mu\text{Adc}, I_E = 0$)		$V_{(BR)CBO}$	-60	—	Vdc
Emitter-Base Breakdown Voltage ($I_E = -10 \mu\text{Adc}, I_C = 0$)		$V_{(BR)EBO}$	-5.0	—	Vdc
Collector Cutoff Current ($V_{CE} = -30 \text{ Vdc}, V_{BE(off)} = -0.5 \text{ Vdc}$)		I_{CEX}	—	-50	nAdc
Collector Cutoff Current ($V_{CB} = -50 \text{ Vdc}, I_E = 0$)	MMBT2907 MMBT2907A	I_{CBO}	— —	-0.020 -0.010	μAdc
($V_{CB} = -50 \text{ Vdc}, I_E = 0, T_A = 125^\circ\text{C}$)	MMBT2907 MMBT2907A		— —	-20 -10	
Base Current ($V_{CE} = -30 \text{ Vdc}, V_{EB(off)} = -0.5 \text{ Vdc}$)		I_B	—	-50	nAdc

1. FR-5 = $1.0 \times 0.75 \times 0.062 \text{ in.}$

2. Alumina = $0.4 \times 0.3 \times 0.024 \text{ in.}$ 99.5% alumina.

3. Pulse Test: Pulse Width $\leq 300 \mu\text{s}$, Duty Cycle $\leq 2.0\%$.

Preferred devices are Motorola recommended choices for future use and best overall value.

MMBT2907LT1 MMBT2907ALT1

ELECTRICAL CHARACTERISTICS (T_A = 25°C unless otherwise noted) (Continued)

Characteristic	Symbol	Min	Max	Unit	
ON CHARACTERISTICS					
DC Current Gain (I _C = -0.1 mA _{dc} , V _{CE} = -10 V _{dc})	MMBT2907 MMBT2907A	h _{FE}	35	—	—
(I _C = -1.0 mA _{dc} , V _{CE} = -10 V _{dc})			75	—	—
(I _C = -10 mA _{dc} , V _{CE} = -10 V _{dc})			50	—	—
(I _C = -150 mA _{dc} , V _{CE} = -10 V _{dc}) (3)			100	—	—
(I _C = -500 mA _{dc} , V _{CE} = -10 V _{dc}) (3)			75	—	—
	MMBT2907A	100	—	—	
	MMBT2907A	100	—	—	
	MMBT2907A	100	300	—	
	MMBT2907A	30	—	—	
	MMBT2907A	50	—	—	
Collector–Emitter Saturation Voltage (3) (I _C = -150 mA _{dc} , I _B = -15 mA _{dc}) (I _C = -500 mA _{dc} , I _B = -50 mA _{dc})	V _{CE(sat)}	—	-0.4	V _{dc}	
		—	-1.6		
Base–Emitter Saturation Voltage (3) (I _C = -150 mA _{dc} , I _B = -15 mA _{dc}) (I _C = -500 mA _{dc} , I _B = -50 mA _{dc})	V _{BE(sat)}	—	-1.3	V _{dc}	
		—	-2.6		

SMALL-SIGNAL CHARACTERISTICS

Current–Gain — Bandwidth Product (3),(4) (I _C = -50 mA _{dc} , V _{CE} = -20 V _{dc} , f = 100 MHz)	f _T	200	—	MHz
Output Capacitance (V _{CB} = -10 V _{dc} , I _E = 0, f = 1.0 MHz)	C _{obo}	—	8.0	pF
Input Capacitance (V _{EB} = -2.0 V _{dc} , I _C = 0, f = 1.0 MHz)	C _{ibo}	—	30	pF

SWITCHING CHARACTERISTICS

Turn–On Time	(V _{CC} = -30 V _{dc} , I _C = -150 mA _{dc} , I _{B1} = -15 mA _{dc})	t _{on}	—	45	ns
Delay Time		t _d	—	10	
Rise Time		t _r	—	40	
Turn–Off Time	(V _{CC} = -6.0 V _{dc} , I _C = -150 mA _{dc} , I _{B1} = I _{B2} = -15 mA _{dc})	t _{off}	—	100	ns
Storage Time		t _s	—	80	
Fall Time		t _f	—	30	

- Pulse Test: Pulse Width ≤ 300 μs, Duty Cycle ≤ 2.0%.
- f_T is defined as the frequency at which |h_{fe}| extrapolates to unity.

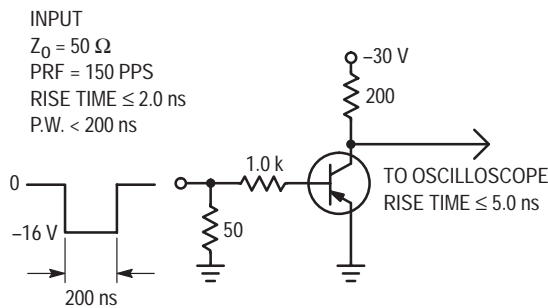


Figure 1. Delay and Rise Time Test Circuit

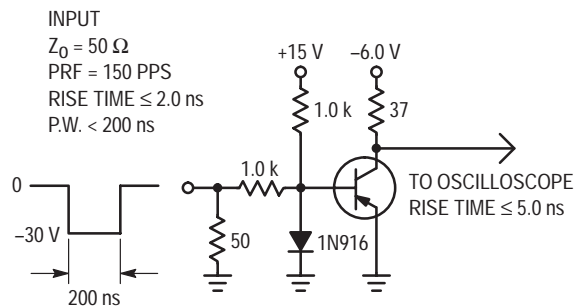


Figure 2. Storage and Fall Time Test Circuit

TYPICAL CHARACTERISTICS

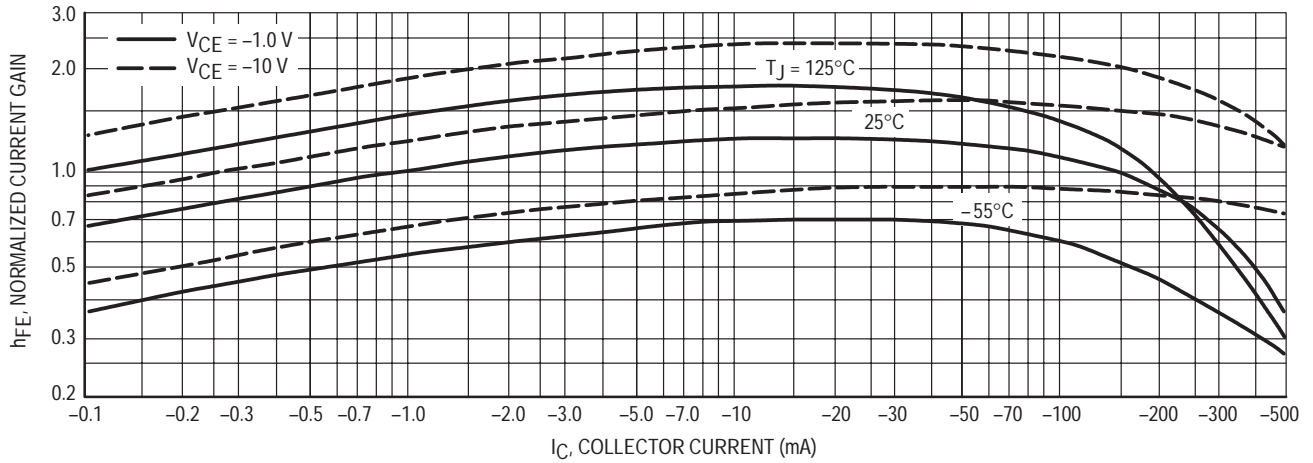


Figure 3. DC Current Gain

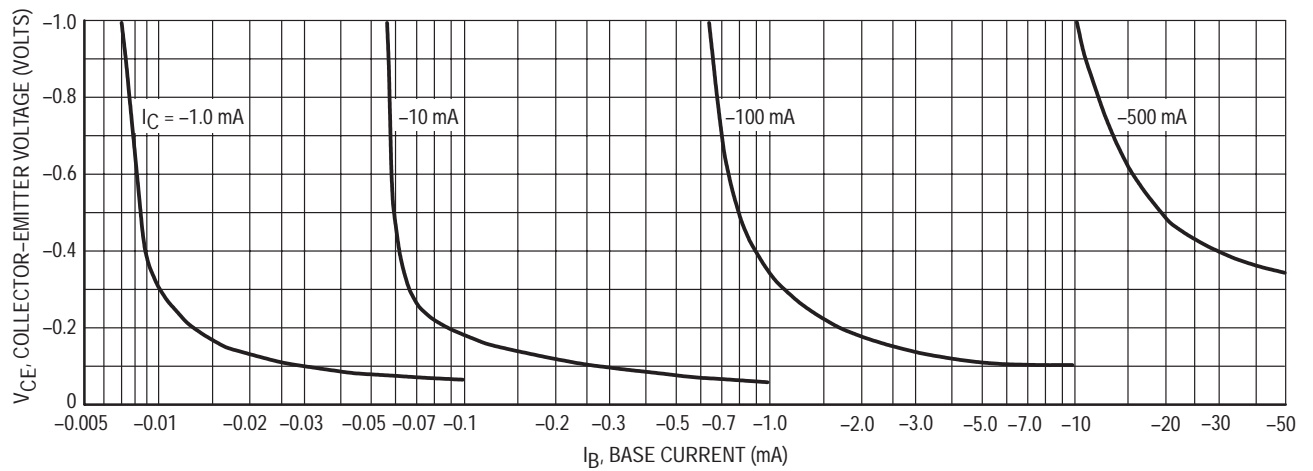


Figure 4. Collector Saturation Region

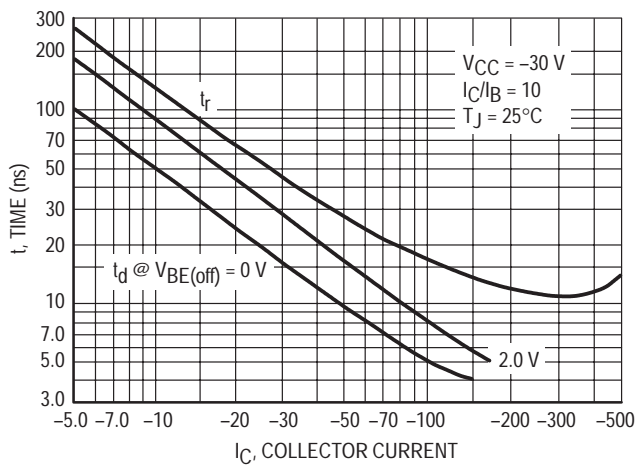


Figure 5. Turn-On Time

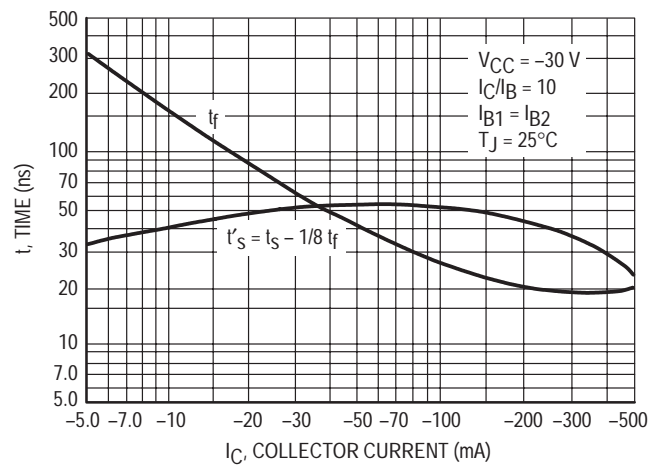


Figure 6. Turn-Off Time

TYPICAL SMALL-SIGNAL CHARACTERISTICS

NOISE FIGURE

$V_{CE} = 10 \text{ Vdc}$, $T_A = 25^\circ\text{C}$

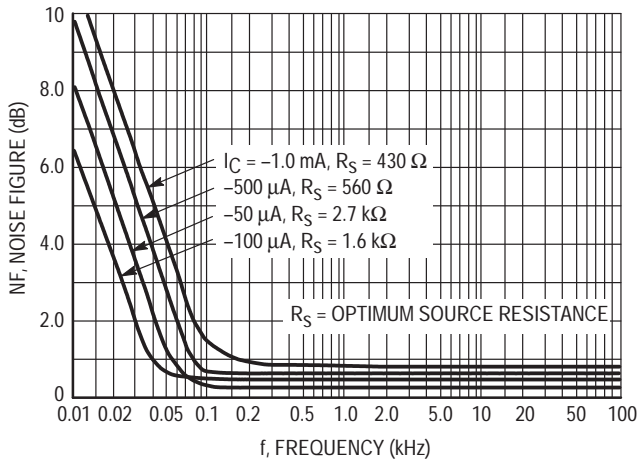


Figure 7. Frequency Effects

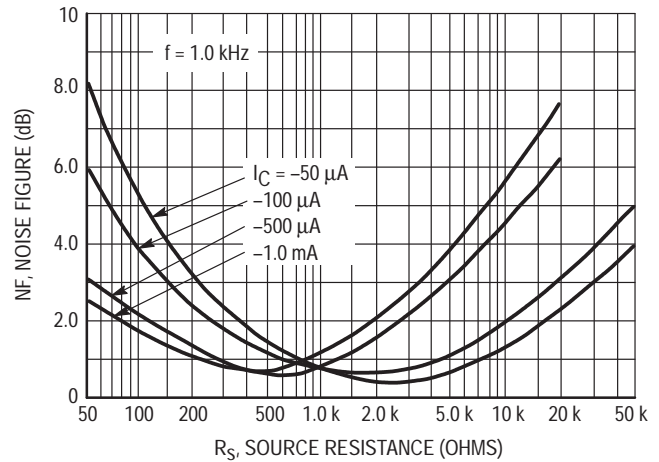


Figure 8. Source Resistance Effects

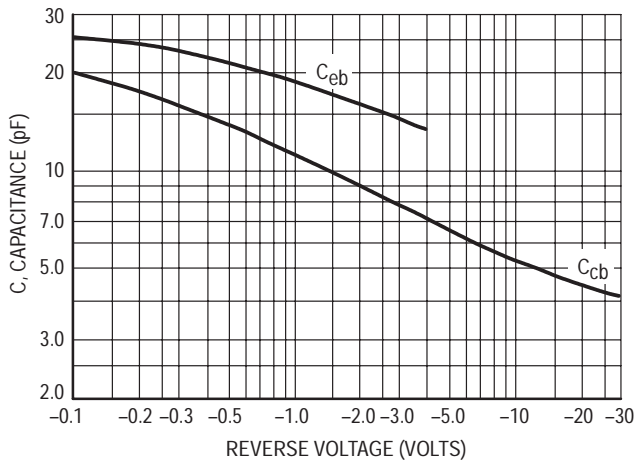


Figure 9. Capacitances

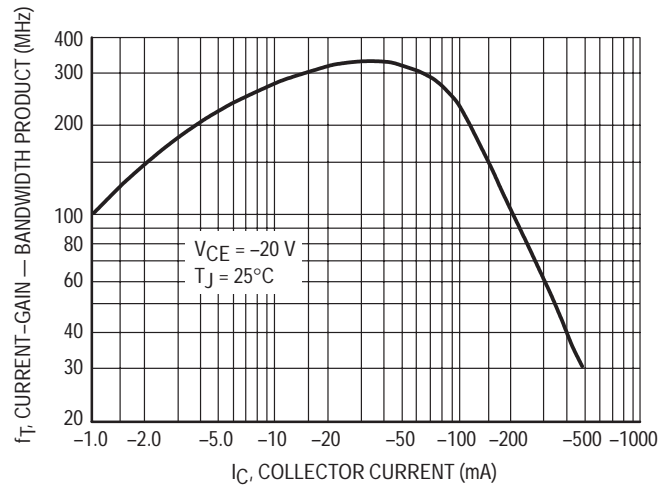


Figure 10. Current-Gain — Bandwidth Product

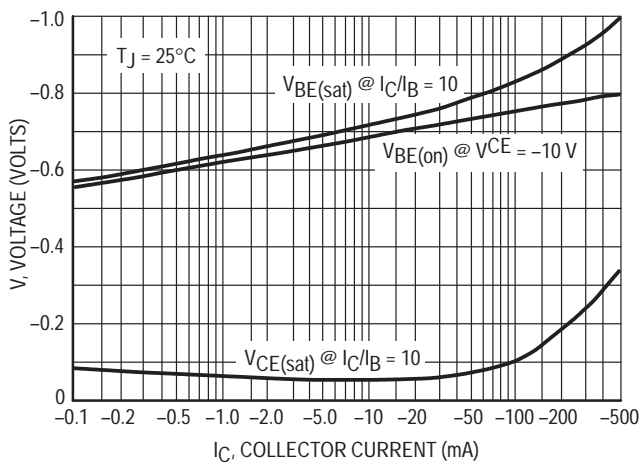


Figure 11. "On" Voltage

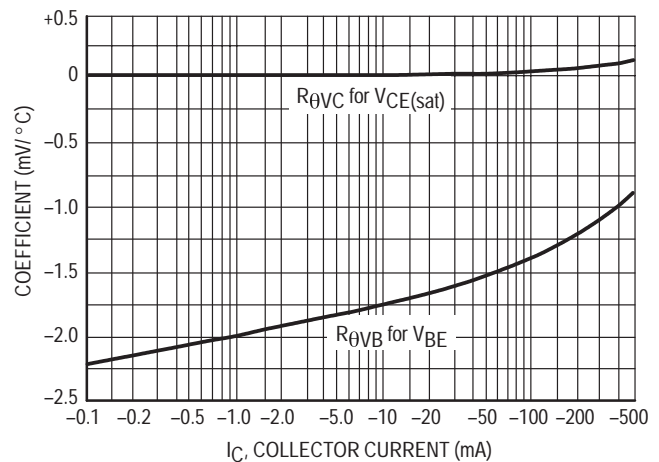
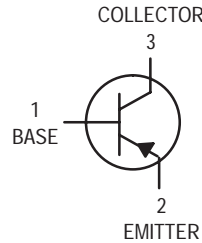


Figure 12. Temperature Coefficients

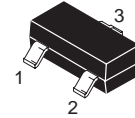
Switching Transistor

PNP Silicon



MMBT3640LT1

Motorola Preferred Device



CASE 318-08, STYLE 6
SOT-23 (TO-236AB)

MAXIMUM RATINGS

Rating	Symbol	Value	Unit
Collector–Emitter Voltage	V_{CEO}	-12	Vdc
Collector–Base Voltage	V_{CBO}	-12	Vdc
Emitter–Base Voltage	V_{EBO}	-4.0	Vdc
Collector Current — Continuous	I_C	-80	mAdc

THERMAL CHARACTERISTICS

Characteristic	Symbol	Max	Unit
Total Device Dissipation FR-5 Board ⁽¹⁾ $T_A = 25^\circ\text{C}$ Derate above 25°C	P_D	225	mW
		1.8	mW/ $^\circ\text{C}$
Thermal Resistance, Junction to Ambient	$R_{\theta JA}$	556	$^\circ\text{C}/\text{W}$
Total Device Dissipation Alumina Substrate, ⁽²⁾ $T_A = 25^\circ\text{C}$ Derate above 25°C	P_D	300	mW
		2.4	mW/ $^\circ\text{C}$
Thermal Resistance, Junction to Ambient	$R_{\theta JA}$	417	$^\circ\text{C}/\text{W}$
Junction and Storage Temperature	T_J, T_{stg}	-55 to +150	$^\circ\text{C}$

DEVICE MARKING

MMBT3640LT1 = 2J

ELECTRICAL CHARACTERISTICS ($T_A = 25^\circ\text{C}$ unless otherwise noted)

Characteristic	Symbol	Min	Max	Unit
----------------	--------	-----	-----	------

OFF CHARACTERISTICS

Collector–Emitter Breakdown Voltage ($I_C = -100 \mu\text{Adc}, V_{BE} = 0$)	$V_{(BR)CES}$	-12	—	Vdc
Collector–Emitter Sustaining Voltage ⁽¹⁾ ($I_C = -10 \text{ mAdc}, I_B = 0$)	$V_{CEO(sus)}$	-12	—	Vdc
Collector–Base Breakdown Voltage ($I_C = -100 \mu\text{Adc}, I_E = 0$)	$V_{(BR)CBO}$	-12	—	Vdc
Emitter–Base Breakdown Voltage ($I_E = -100 \mu\text{Adc}, I_C = 0$)	$V_{(BR)EBO}$	-4.0	—	Vdc
Collector Cutoff Current ($V_{CE} = -6.0 \text{ Vdc}, V_{BE} = 0$) ($V_{CE} = -6.0 \text{ Vdc}, V_{BE} = 0, T_A = 65^\circ\text{C}$)	I_{CES}	—	-0.01 -1.0	μAdc
Base Cutoff Current ($V_{CE} = -6.0 \text{ Vdc}, V_{EB} = 0$)	I_B	—	-10	nAdc

1. FR-5 = $1.0 \times 0.75 \times 0.062 \text{ in.}$

2. Alumina = $0.4 \times 0.3 \times 0.024 \text{ in.}$ 99.5% alumina.

Preferred devices are Motorola recommended choices for future use and best overall value.

MMBT3640LT1

ELECTRICAL CHARACTERISTICS (T_A = 25°C unless otherwise noted) (Continued)

Characteristic	Symbol	Min	Max	Unit
ON CHARACTERISTICS(3)				
DC Current Gain (I _C = -10 mAdc, V _{CE} = -0.3 Vdc) (I _C = -50 mAdc, V _{CE} = -1.0 Vdc)	h _{FE}	30 20	120 —	—
Collector–Emitter Saturation Voltage (I _C = -10 mAdc, I _B = -1.0 mAdc) (I _C = -50 mAdc, I _B = -5.0 mAdc) (I _C = -10 mAdc, I _B = -1.0 mAdc, T _A = 65°C)	V _{CE(sat)}	— — —	-0.2 -0.6 -0.25	Vdc
Base–Emitter Saturation Voltage (I _C = -10 mAdc, I _B = -0.5 mAdc) (I _C = -10 mAdc, I _B = -1.0 mAdc) (I _C = -50 mAdc, I _B = -5.0 mAdc)	V _{BE(sat)}	-0.75 -0.8 —	-0.95 -1.0 -1.5	Vdc

SMALL–SIGNAL CHARACTERISTICS

Current–Gain — Bandwidth Product (I _C = -10 mAdc, V _{CE} = -5.0 Vdc, f = 100 MHz)	f _T	500	—	MHz
Output Capacitance (V _{CB} = -5.0 Vdc, I _E = 0, f = 1.0 MHz)	C _{obo}	—	3.5	pF
Input Capacitance (V _{EB} = -0.5 Vdc, I _C = 0, f = 1.0 MHz)	C _{ibo}	—	3.5	pF

SWITCHING CHARACTERISTICS

Delay Time	(V _{CC} = -6.0 Vdc, I _C = -50 mAdc, V _{EB(off)} = -1.9 Vdc, I _{B1} = -5.0 mAdc)	t _d	—	10	ns
Rise Time		t _r	—	30	
Storage Time	(V _{CC} = -6.0 Vdc, I _C = -50 mAdc, I _{B1} = I _{B2} = -5.0 mAdc)	t _s	—	20	ns
Fall Time		t _f	—	12	
Turn–On Time (V _{CC} = -6.0 Vdc, I _C = -50 mAdc, V _{EB(off)} = -1.9 Vdc, I _{B1} = -5.0 mAdc) (V _{CC} = -1.5 Vdc, I _C = -10 mAdc, I _{B1} = -0.5 mAdc)	t _{on}	— —	25 60	ns	
Turn–Off Time (V _{CC} = -6.0 Vdc, I _C = -50 mAdc, V _{EB(off)} = -1.9 Vdc, I _{B1} = I _{B2} = -5.0 mAdc) (V _{CC} = -1.5 Vdc, I _C = -10 mAdc, I _{B1} = I _{B2} = -0.5 mAdc)	t _{off}	— —	35 75	ns	

3. Pulse Test: Pulse Width ≤ 300 μs, Duty Cycle ≤ 2.0%.

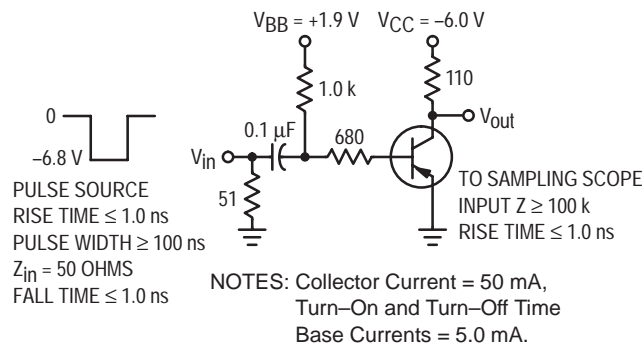


Figure 1.

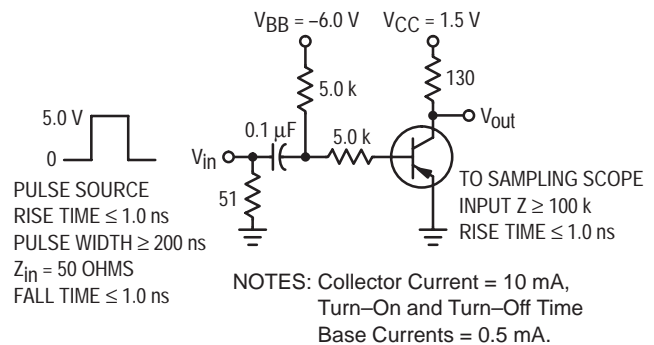


Figure 2.

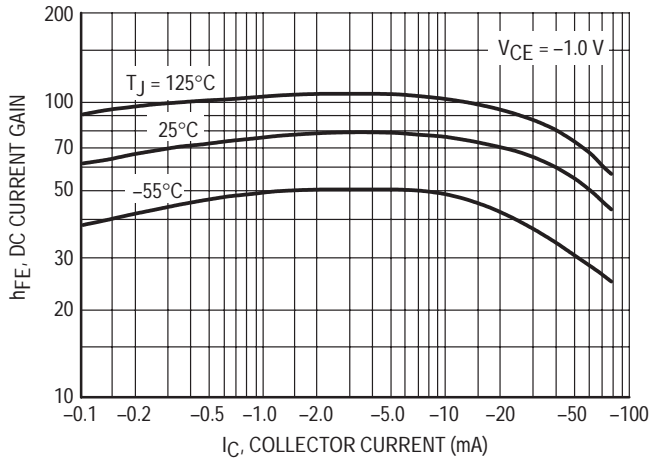


Figure 3. DC Current Gain

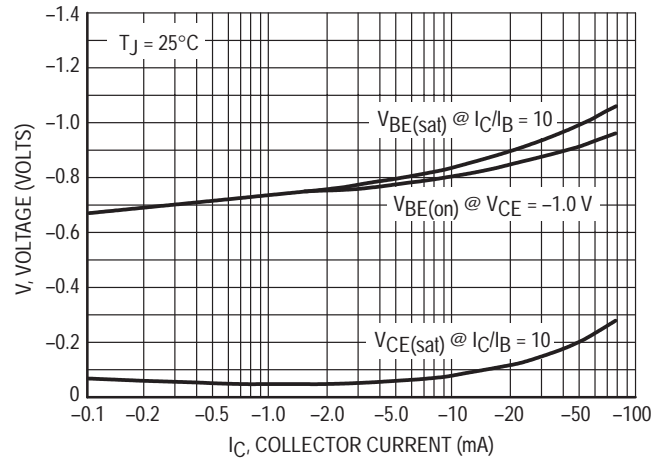


Figure 4. "On" Voltages

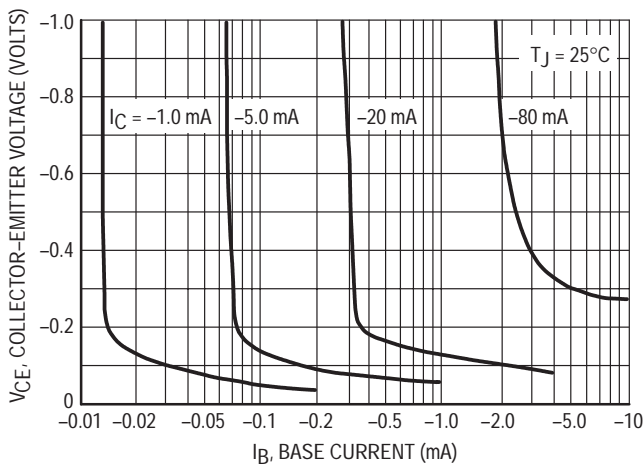


Figure 5. Collector Saturation Region

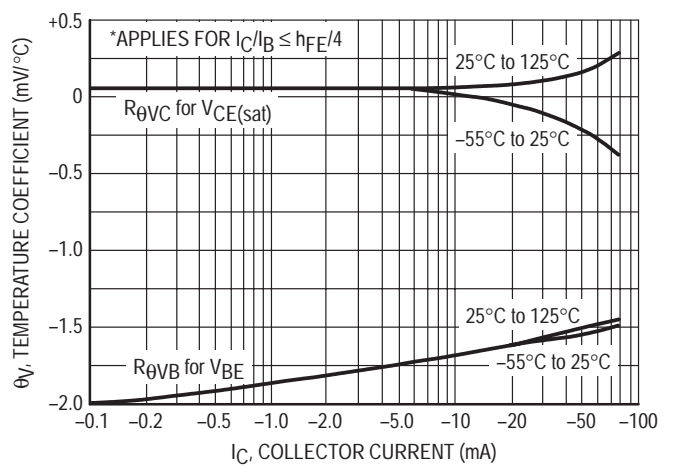


Figure 6. Temperature Coefficients

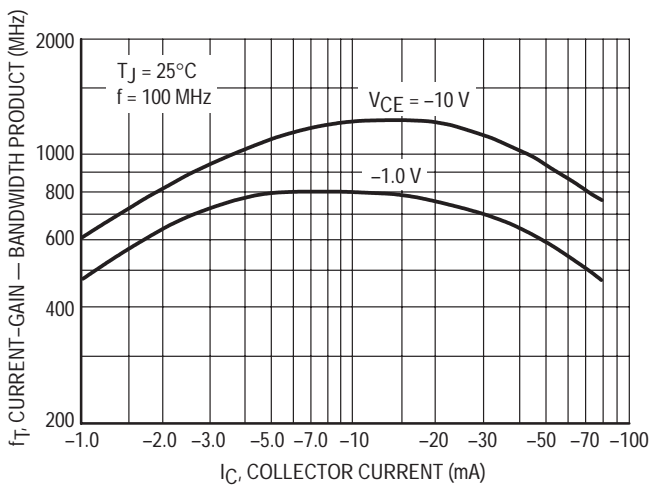


Figure 7. Current-Gain — Bandwidth Product

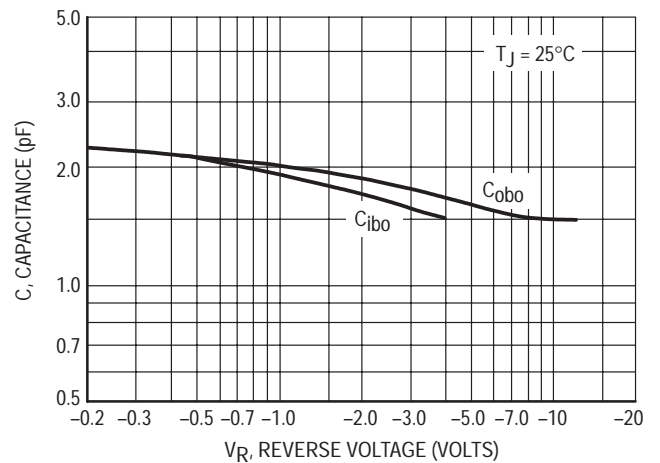
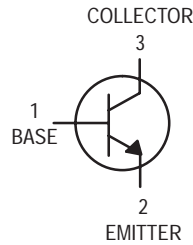


Figure 8. Capacitance

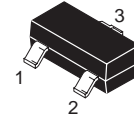
General Purpose Transistor

NPN Silicon



MMBT3904LT1

Motorola Preferred Device



CASE 318-08, STYLE 6
SOT-23 (TO-236AB)

MAXIMUM RATINGS

Rating	Symbol	Value	Unit
Collector–Emitter Voltage	V_{CEO}	40	Vdc
Collector–Base Voltage	V_{CBO}	60	Vdc
Emitter–Base Voltage	V_{EBO}	6.0	Vdc
Collector Current — Continuous	I_C	200	mAdc

THERMAL CHARACTERISTICS

Characteristic	Symbol	Max	Unit
Total Device Dissipation FR-5 Board ⁽¹⁾ $T_A = 25^\circ\text{C}$ Derate above 25°C	P_D	225	mW
		1.8	mW/ $^\circ\text{C}$
Thermal Resistance Junction to Ambient	$R_{\theta JA}$	556	$^\circ\text{C}/\text{W}$
Total Device Dissipation Alumina Substrate, ⁽²⁾ $T_A = 25^\circ\text{C}$ Derate above 25°C	P_D	300	mW
		2.4	mW/ $^\circ\text{C}$
Thermal Resistance Junction to Ambient	$R_{\theta JA}$	417	$^\circ\text{C}/\text{W}$
Junction and Storage Temperature	T_J, T_{stg}	-55 to +150	$^\circ\text{C}$

DEVICE MARKING

MMBT3904LT1 = 1AM

ELECTRICAL CHARACTERISTICS ($T_A = 25^\circ\text{C}$ unless otherwise noted)

Characteristic	Symbol	Min	Max	Unit
----------------	--------	-----	-----	------

OFF CHARACTERISTICS

Collector–Emitter Breakdown Voltage (3) ($I_C = 1.0 \text{ mAdc}, I_B = 0$)	$V_{(BR)CEO}$	40	—	Vdc
Collector–Base Breakdown Voltage ($I_C = 10 \mu\text{Adc}, I_E = 0$)	$V_{(BR)CBO}$	60	—	Vdc
Emitter–Base Breakdown Voltage ($I_E = 10 \mu\text{Adc}, I_C = 0$)	$V_{(BR)EBO}$	6.0	—	Vdc
Base Cutoff Current ($V_{CE} = 30 \text{ Vdc}, V_{EB} = 3.0 \text{ Vdc}$)	I_{BL}	—	50	nAdc
Collector Cutoff Current ($V_{CE} = 30 \text{ Vdc}, V_{EB} = 3.0 \text{ Vdc}$)	I_{CEX}	—	50	nAdc

1. FR-5 = $1.0 \times 0.75 \times 0.062 \text{ in.}$

2. Alumina = $0.4 \times 0.3 \times 0.024 \text{ in. 99.5\% alumina.}$

3. Pulse Test: Pulse Width $\leq 300 \mu\text{s}$, Duty Cycle $\leq 2.0\%$.

Preferred devices are Motorola recommended choices for future use and best overall value.

ELECTRICAL CHARACTERISTICS ($T_A = 25^\circ\text{C}$ unless otherwise noted) (Continued)

Characteristic	Symbol	Min	Max	Unit
ON CHARACTERISTICS(3)				
DC Current Gain (1) ($I_C = 0.1\text{ mAdc}$, $V_{CE} = 1.0\text{ Vdc}$) ($I_C = 1.0\text{ mAdc}$, $V_{CE} = 1.0\text{ Vdc}$) ($I_C = 10\text{ mAdc}$, $V_{CE} = 1.0\text{ Vdc}$) ($I_C = 50\text{ mAdc}$, $V_{CE} = 1.0\text{ Vdc}$) ($I_C = 100\text{ mAdc}$, $V_{CE} = 1.0\text{ Vdc}$)	H_{FE}	40 70 100 60 30	— — 300 — —	—
Collector–Emitter Saturation Voltage (3) ($I_C = 10\text{ mAdc}$, $I_B = 1.0\text{ mAdc}$) ($I_C = 50\text{ mAdc}$, $I_B = 5.0\text{ mAdc}$)	$V_{CE(sat)}$	— —	0.2 0.3	Vdc
Base–Emitter Saturation Voltage (3) ($I_C = 10\text{ mAdc}$, $I_B = 1.0\text{ mAdc}$) ($I_C = 50\text{ mAdc}$, $I_B = 5.0\text{ mAdc}$)	$V_{BE(sat)}$	0.65 —	0.85 0.95	Vdc

SMALL–SIGNAL CHARACTERISTICS

Current–Gain — Bandwidth Product ($I_C = 10\text{ mAdc}$, $V_{CE} = 20\text{ Vdc}$, $f = 100\text{ MHz}$)	f_T	300	—	MHz
Output Capacitance ($V_{CB} = 5.0\text{ Vdc}$, $I_E = 0$, $f = 1.0\text{ MHz}$)	C_{obo}	—	4.0	pF
Input Capacitance ($V_{EB} = 0.5\text{ Vdc}$, $I_C = 0$, $f = 1.0\text{ MHz}$)	C_{ibo}	—	8.0	pF
Input Impedance ($V_{CE} = 10\text{ Vdc}$, $I_C = 1.0\text{ mAdc}$, $f = 1.0\text{ kHz}$)	h_{ie}	1.0	10	k ohms
Voltage Feedback Ratio ($V_{CE} = 10\text{ Vdc}$, $I_C = 1.0\text{ mAdc}$, $f = 1.0\text{ kHz}$)	h_{re}	0.5	8.0	$\times 10^{-4}$
Small–Signal Current Gain ($V_{CE} = 10\text{ Vdc}$, $I_C = 1.0\text{ mAdc}$, $f = 1.0\text{ kHz}$)	h_{fe}	100	400	—
Output Admittance ($V_{CE} = 10\text{ Vdc}$, $I_C = 1.0\text{ mAdc}$, $f = 1.0\text{ kHz}$)	h_{oe}	1.0	40	μmhos
Noise Figure ($V_{CE} = 5.0\text{ Vdc}$, $I_C = 100\text{ }\mu\text{A}$, $R_S = 1.0\text{ k ohms}$, $f = 1.0\text{ kHz}$)	NF	—	5.0	dB

SWITCHING CHARACTERISTICS

Delay Time	($V_{CC} = 3.0\text{ Vdc}$, $V_{BE} = -0.5\text{ Vdc}$, $I_C = 10\text{ mAdc}$, $I_{B1} = 1.0\text{ mAdc}$)	t_d	—	35	ns
Rise Time		t_r	—	35	
Storage Time	($V_{CC} = 3.0\text{ Vdc}$, $I_C = 10\text{ mAdc}$, $I_{B1} = I_{B2} = 1.0\text{ mAdc}$)	t_s	—	200	ns
Fall Time		t_f	—	50	

3. Pulse Test: Pulse Width $\leq 300\text{ }\mu\text{s}$, Duty Cycle $\leq 2.0\%$.

MMBT3904LT1

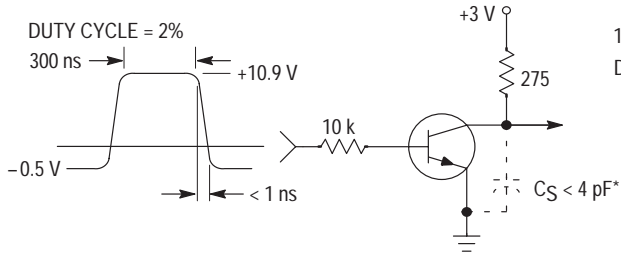


Figure 1. Delay and Rise Time Equivalent Test Circuit

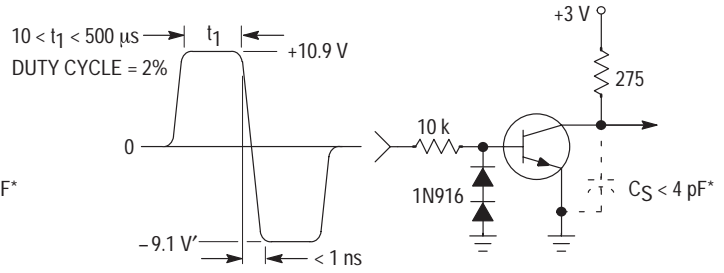


Figure 2. Storage and Fall Time Equivalent Test Circuit

* Total shunt capacitance of test jig and connectors

TYPICAL TRANSIENT CHARACTERISTICS

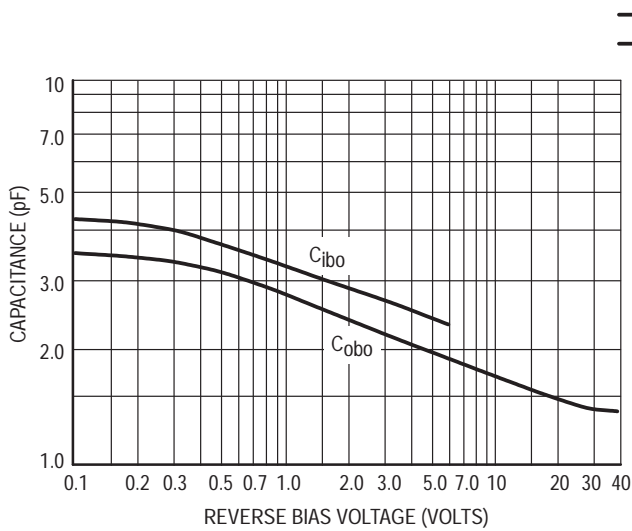


Figure 3. Capacitance

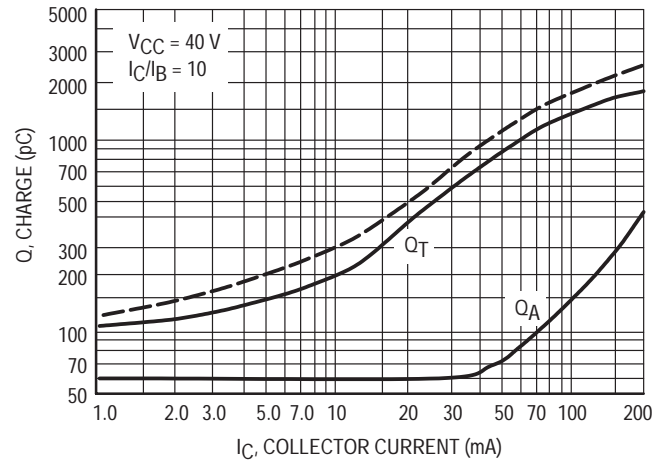


Figure 4. Charge Data

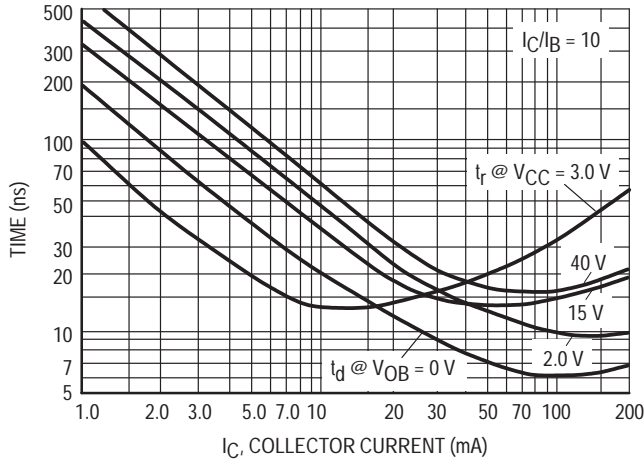


Figure 5. Turn-On Time

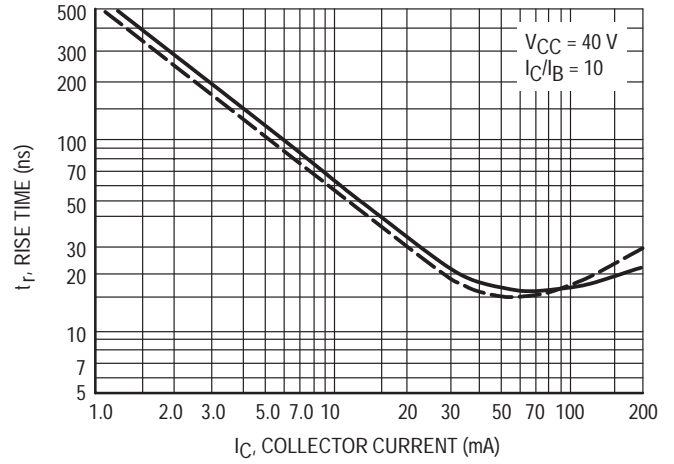


Figure 6. Rise Time

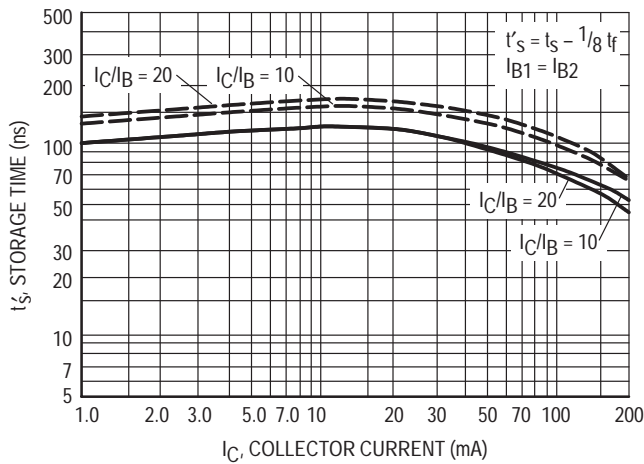


Figure 7. Storage Time

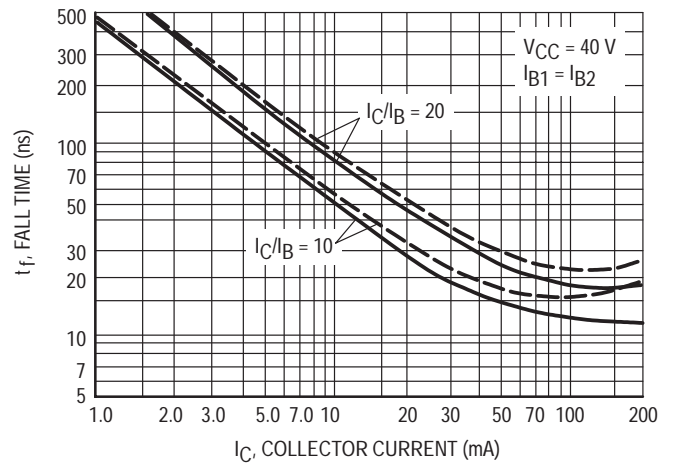


Figure 8. Fall Time

TYPICAL AUDIO SMALL-SIGNAL CHARACTERISTICS
NOISE FIGURE VARIATIONS

(VCE = 5.0 Vdc, TA = 25°C, Bandwidth = 1.0 Hz)

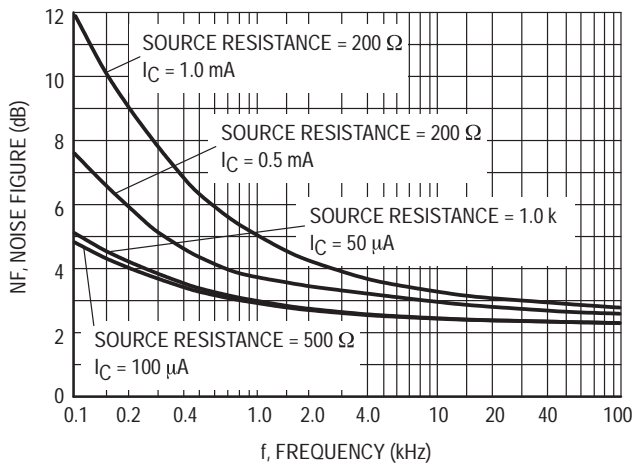


Figure 9.

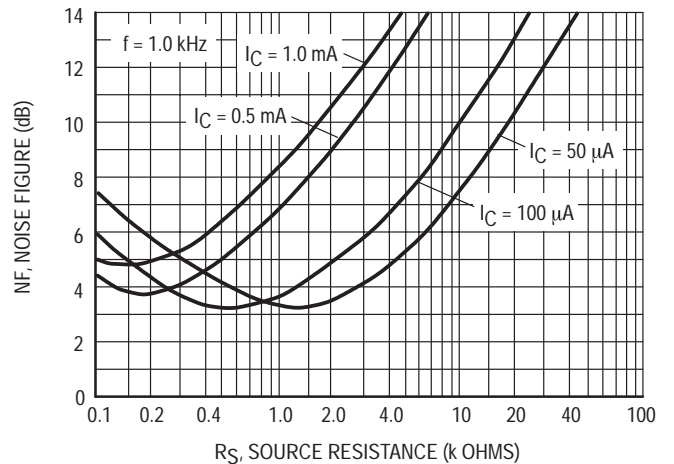


Figure 10.

h PARAMETERS

($V_{CE} = 10 \text{ Vdc}$, $f = 1.0 \text{ kHz}$, $T_A = 25^\circ\text{C}$)

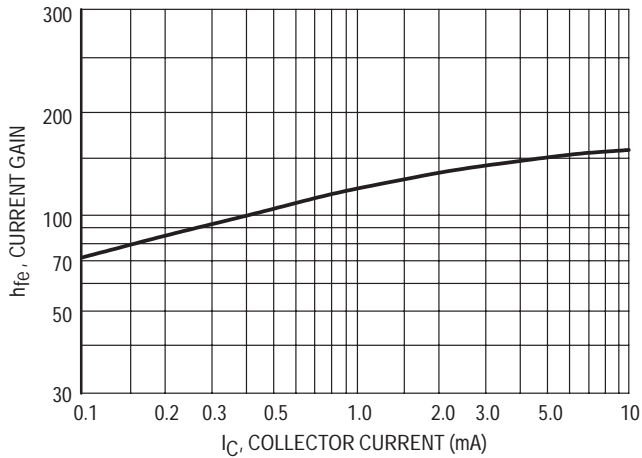


Figure 11. Current Gain

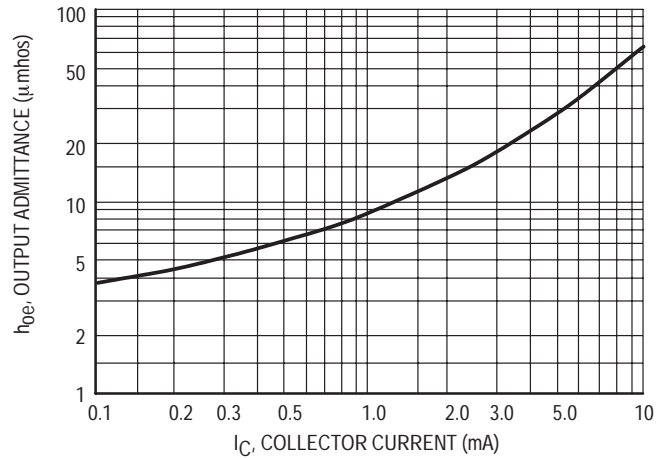


Figure 12. Output Admittance

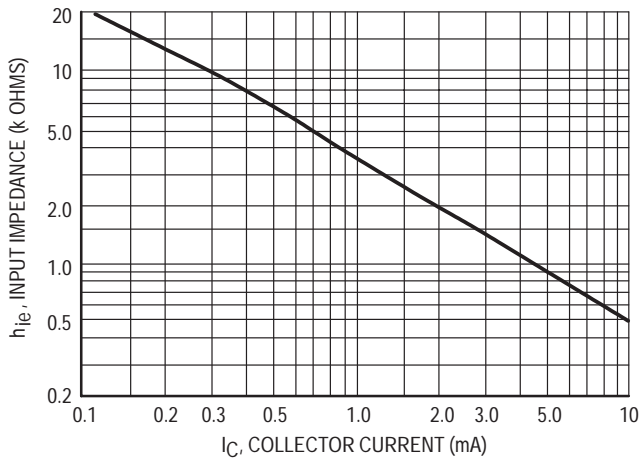


Figure 13. Input Impedance

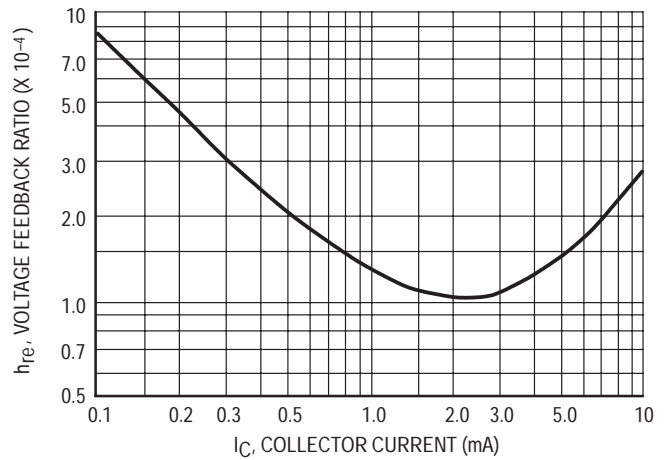


Figure 14. Voltage Feedback Ratio

TYPICAL STATIC CHARACTERISTICS

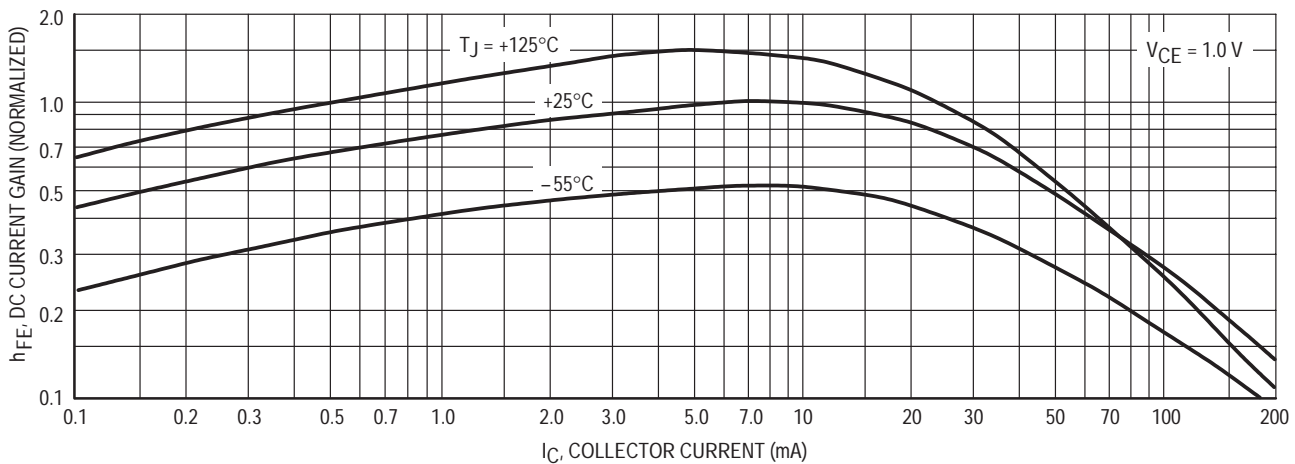


Figure 15. DC Current Gain

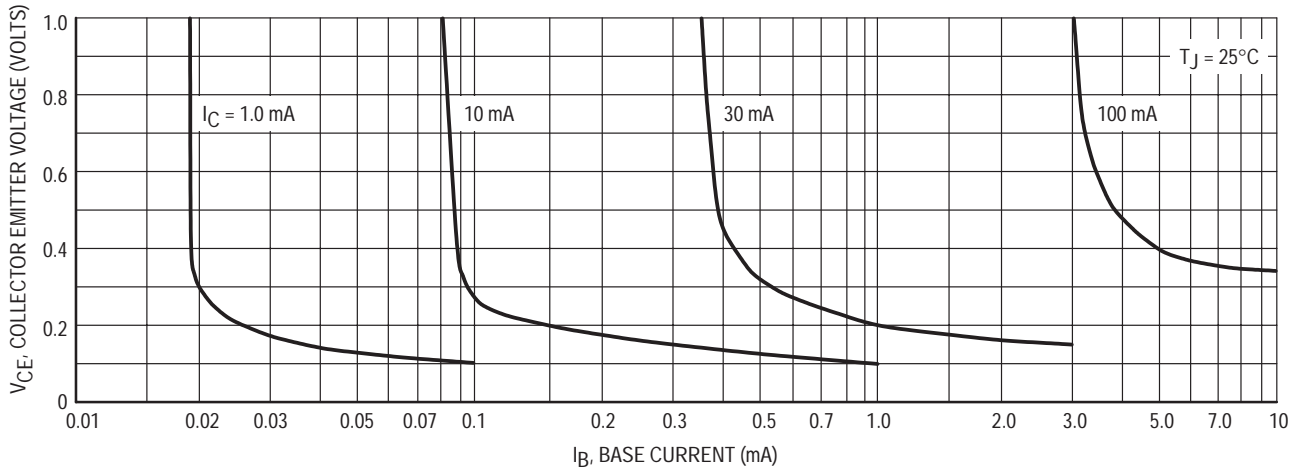


Figure 16. Collector Saturation Region

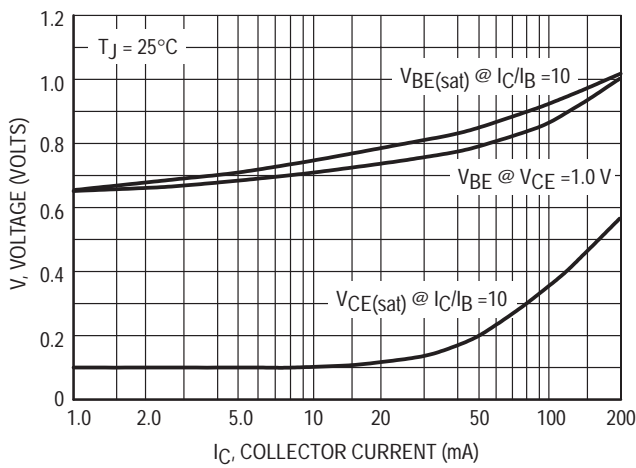


Figure 17. "ON" Voltages

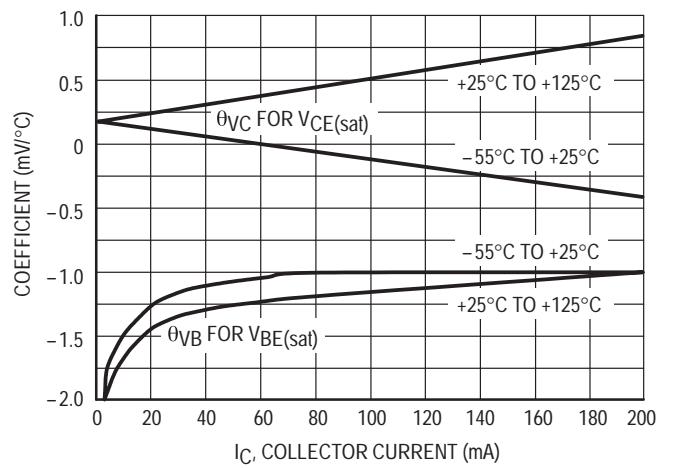


Figure 18. Temperature Coefficients

General Purpose Transistors

NPN and PNP Silicon

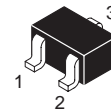
These transistors are designed for general purpose amplifier applications. They are housed in the SOT-323/SC-70 which is designed for low power surface mount applications.

NPN
MMBT3904WT1
PNP
MMBT3906WT1

MAXIMUM RATINGS

Rating	Symbol	Value	Unit
Collector–Emitter Voltage MMBT3904WT1 MMBT3906WT1	V_{CEO}	40 –40	Vdc
Collector–Base Voltage MMBT3904WT1 MMBT3906WT1	V_{CBO}	60 –40	Vdc
Emitter–Base Voltage MMBT3904WT1 MMBT3906WT1	V_{EBO}	6.0 –5.0	Vdc
Collector Current — Continuous MMBT3904WT1 MMBT3906WT1	I_C	200 –200	mAdc

**GENERAL PURPOSE
AMPLIFIER TRANSISTORS
SURFACE MOUNT**



**CASE 419–02, STYLE 3
SOT–323/SC–70**

THERMAL CHARACTERISTICS

Characteristic	Symbol	Max	Unit
Total Device Dissipation ⁽¹⁾ $T_A = 25^\circ\text{C}$	P_D	150	mW
Thermal Resistance, Junction to Ambient	$R_{\theta JA}$	833	$^\circ\text{C/W}$
Junction and Storage Temperature	T_J, T_{stg}	–55 to +150	$^\circ\text{C}$

DEVICE MARKING

MMBT3904WT1 = AM
MMBT3906WT1 = 2A

ELECTRICAL CHARACTERISTICS ($T_A = 25^\circ\text{C}$ unless otherwise noted)

Characteristic	Symbol	Min	Max	Unit
----------------	--------	-----	-----	------

OFF CHARACTERISTICS

Collector–Emitter Breakdown Voltage ⁽²⁾ ($I_C = 1.0 \text{ mAdc}, I_B = 0$) ($I_C = -1.0 \text{ mAdc}, I_B = 0$)	MMBT3904WT1 MMBT3906WT1	$V_{(BR)CEO}$	40 –40	— —	Vdc
Collector–Base Breakdown Voltage ($I_C = 10 \mu\text{Adc}, I_E = 0$) ($I_C = -10 \mu\text{Adc}, I_E = 0$)	MMBT3904WT1 MMBT3906WT1	$V_{(BR)CBO}$	60 –40	— —	Vdc
Emitter–Base Breakdown Voltage ($I_E = 10 \mu\text{Adc}, I_C = 0$) ($I_E = -10 \mu\text{Adc}, I_C = 0$)	MMBT3904WT1 MMBT3906WT1	$V_{(BR)EBO}$	6.0 –5.0	— —	Vdc
Base Cutoff Current ($V_{CE} = 30 \text{ Vdc}, V_{EB} = 3.0 \text{ Vdc}$) ($V_{CE} = -30 \text{ Vdc}, V_{EB} = -3.0 \text{ Vdc}$)	MMBT3904WT1 MMBT3906WT1	I_{BL}	— —	50 –50	nAdc
Collector Cutoff Current ($V_{CE} = 30 \text{ Vdc}, V_{EB} = 3.0 \text{ Vdc}$) ($V_{CE} = -30 \text{ Vdc}, V_{EB} = -3.0 \text{ Vdc}$)	MMBT3904WT1 MMBT3906WT1	I_{CEX}	— —	50 –50	nAdc

1. Device mounted on FR4 glass epoxy printed circuit board using the minimum recommended footprint.
2. Pulse Test: Pulse Width $\leq 300 \mu\text{s}$; Duty Cycle $\leq 2.0\%$.

ELECTRICAL CHARACTERISTICS ($T_A = 25^\circ\text{C}$ unless otherwise noted) (Continued)

Characteristic	Symbol	Min	Max	Unit	
ON CHARACTERISTICS(2)					
DC Current Gain ($I_C = 0.1\text{ mAdc}$, $V_{CE} = 1.0\text{ Vdc}$) ($I_C = 1.0\text{ mAdc}$, $V_{CE} = 1.0\text{ Vdc}$) ($I_C = 10\text{ mAdc}$, $V_{CE} = 1.0\text{ Vdc}$) ($I_C = 50\text{ mAdc}$, $V_{CE} = 1.0\text{ Vdc}$) ($I_C = 100\text{ mAdc}$, $V_{CE} = 1.0\text{ Vdc}$) ($I_C = -0.1\text{ mAdc}$, $V_{CE} = -1.0\text{ Vdc}$) ($I_C = -1.0\text{ mAdc}$, $V_{CE} = -1.0\text{ Vdc}$) ($I_C = -10\text{ mAdc}$, $V_{CE} = -1.0\text{ Vdc}$) ($I_C = -50\text{ mAdc}$, $V_{CE} = -1.0\text{ Vdc}$) ($I_C = -100\text{ mAdc}$, $V_{CE} = -1.0\text{ Vdc}$)	MMBT3904WT1 MMBT3906WT1	h_{FE}	40 70 100 60 30 60 80 100 60 30	— — 300 — — — — 300 — —	—
Collector–Emitter Saturation Voltage ($I_C = 10\text{ mAdc}$, $I_B = 1.0\text{ mAdc}$) ($I_C = 50\text{ mAdc}$, $I_B = 5.0\text{ mAdc}$) ($I_C = -10\text{ mAdc}$, $I_B = -1.0\text{ mAdc}$) ($I_C = -50\text{ mAdc}$, $I_B = -5.0\text{ mAdc}$)	MMBT3904WT1 MMBT3906WT1	$V_{CE(sat)}$	— — — —	0.2 0.3 -0.25 -0.4	Vdc
Base–Emitter Saturation Voltage ($I_C = 10\text{ mAdc}$, $I_B = 1.0\text{ mAdc}$) ($I_C = 50\text{ mAdc}$, $I_B = 5.0\text{ mAdc}$) ($I_C = -10\text{ mAdc}$, $I_B = -1.0\text{ mAdc}$) ($I_C = -50\text{ mAdc}$, $I_B = -5.0\text{ mAdc}$)	MMBT3904WT1 MMBT3906WT1	$V_{BE(sat)}$	0.65 — -0.65 —	0.85 0.95 -0.85 -0.95	Vdc

SMALL–SIGNAL CHARACTERISTICS

Current–Gain — Bandwidth Product ($I_C = 10\text{ mAdc}$, $V_{CE} = 20\text{ Vdc}$, $f = 100\text{ MHz}$) ($I_C = -10\text{ mAdc}$, $V_{CE} = -20\text{ Vdc}$, $f = 100\text{ MHz}$)	MMBT3904WT1 MMBT3906WT1	f_T	300 250	— —	MHz
Output Capacitance ($V_{CB} = 5.0\text{ Vdc}$, $I_E = 0$, $f = 1.0\text{ MHz}$) ($V_{CB} = -5.0\text{ Vdc}$, $I_E = 0$, $f = 1.0\text{ MHz}$)	MMBT3904WT1 MMBT3906WT1	C_{obo}	— —	4.0 4.5	pF
Input Capacitance ($V_{EB} = 0.5\text{ Vdc}$, $I_C = 0$, $f = 1.0\text{ MHz}$) ($V_{EB} = -0.5\text{ Vdc}$, $I_C = 0$, $f = 1.0\text{ MHz}$)	MMBT3904WT1 MMBT3906WT1	C_{ibo}	— —	8.0 10.0	pF
Input Impedance ($V_{CE} = 10\text{ Vdc}$, $I_C = 1.0\text{ mAdc}$, $f = 1.0\text{ kHz}$) ($V_{CE} = -10\text{ Vdc}$, $I_C = -1.0\text{ mAdc}$, $f = 1.0\text{ kHz}$)	MMBT3904WT1 MMBT3906WT1	h_{ie}	1.0 2.0	10 12	k Ω
Voltage Feedback Ratio ($V_{CE} = 10\text{ Vdc}$, $I_C = 1.0\text{ mAdc}$, $f = 1.0\text{ kHz}$) ($V_{CE} = -10\text{ Vdc}$, $I_C = -1.0\text{ mAdc}$, $f = 1.0\text{ kHz}$)	MMBT3904WT1 MMBT3906WT1	h_{re}	0.5 0.1	8.0 10	$\times 10^{-4}$
Small–Signal Current Gain ($V_{CE} = 10\text{ Vdc}$, $I_C = 1.0\text{ mAdc}$, $f = 1.0\text{ kHz}$) ($V_{CE} = -10\text{ Vdc}$, $I_C = -1.0\text{ mAdc}$, $f = 1.0\text{ kHz}$)	MMBT3904WT1 MMBT3906WT1	h_{fe}	100 100	400 400	—
Output Admittance ($V_{CE} = 10\text{ Vdc}$, $I_C = 1.0\text{ mAdc}$, $f = 1.0\text{ kHz}$) ($V_{CE} = -10\text{ Vdc}$, $I_C = -1.0\text{ mAdc}$, $f = 1.0\text{ kHz}$)	MMBT3904WT1 MMBT3906WT1	h_{oe}	1.0 3.0	40 60	μmhos
Noise Figure ($V_{CE} = 5.0\text{ Vdc}$, $I_C = 100\text{ }\mu\text{A}$, $R_S = 1.0\text{ k}\Omega$, $f = 1.0\text{ kHz}$) ($V_{CE} = -5.0\text{ Vdc}$, $I_C = -100\text{ }\mu\text{A}$, $R_S = 1.0\text{ k}\Omega$, $f = 1.0\text{ kHz}$)	MMBT3904WT1 MMBT3906WT1	NF	— —	5.0 4.0	dB

SWITCHING CHARACTERISTICS

Delay Time	($V_{CC} = 3.0\text{ Vdc}$, $V_{BE} = -0.5\text{ Vdc}$) ($V_{CC} = -3.0\text{ Vdc}$, $V_{BE} = 0.5\text{ Vdc}$)	MMBT3904WT1 MMBT3906WT1	t_d	— —	35 35	ns
Rise Time	($I_C = 10\text{ mAdc}$, $I_{B1} = 1.0\text{ mAdc}$) ($I_C = -10\text{ mAdc}$, $I_{B1} = -1.0\text{ mAdc}$)	MMBT3904WT1 MMBT3906WT1	t_r	— —	35 35	
Storage Time	($V_{CC} = 3.0\text{ Vdc}$, $I_C = 10\text{ mAdc}$) ($V_{CC} = -3.0\text{ Vdc}$, $I_C = -10\text{ mAdc}$)	MMBT3904WT1 MMBT3906WT1	t_s	— —	200 225	ns
Fall Time	($I_{B1} = I_{B2} = 1.0\text{ mAdc}$) ($I_{B1} = I_{B2} = -1.0\text{ mAdc}$)	MMBT3904WT1 MMBT3906WT1	t_f	— —	50 75	

2. Pulse Test: Pulse Width $\leq 300\text{ }\mu\text{s}$, Duty Cycle $\leq 2.0\%$.

MMBT3904WT1

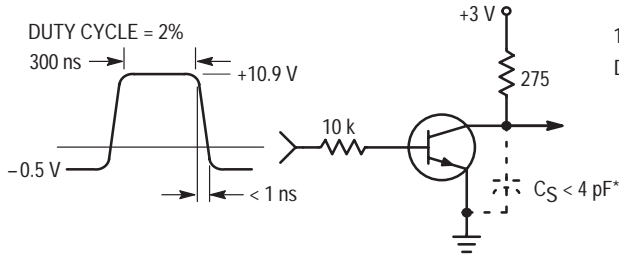


Figure 1. Delay and Rise Time Equivalent Test Circuit

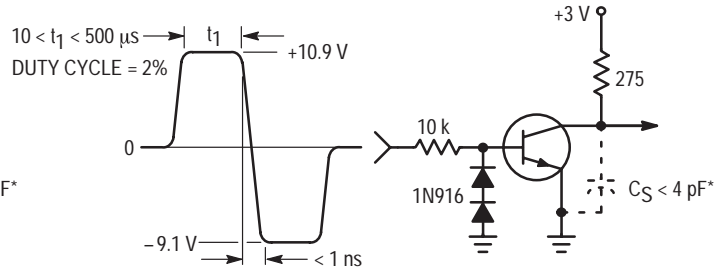


Figure 2. Storage and Fall Time Equivalent Test Circuit

* Total shunt capacitance of test jig and connectors

TYPICAL TRANSIENT CHARACTERISTICS

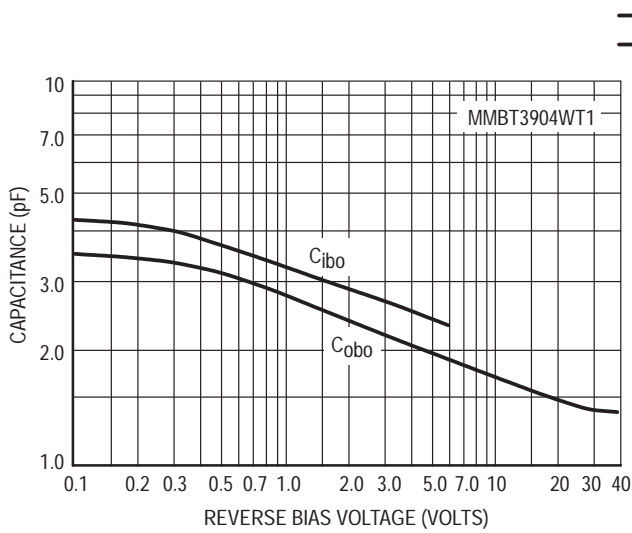


Figure 3. Capacitance

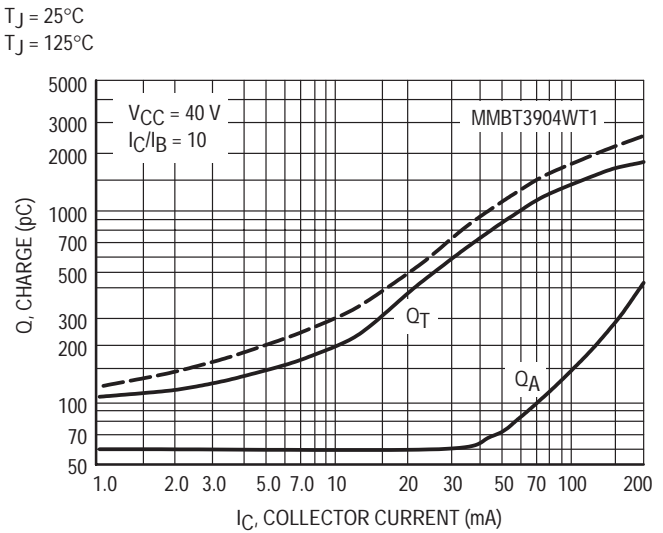


Figure 4. Charge Data

MMBT3904WT1

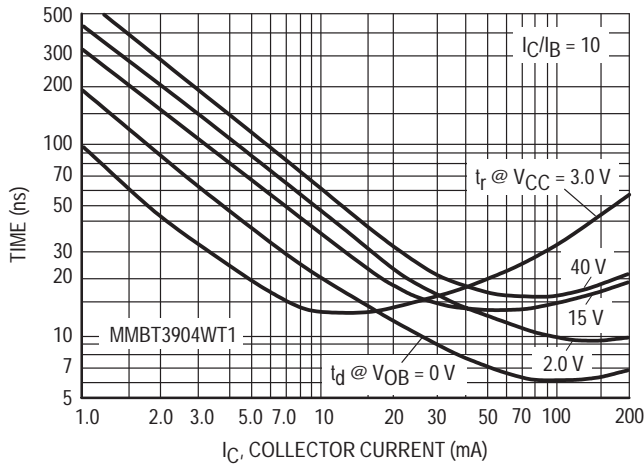


Figure 5. Turn-On Time

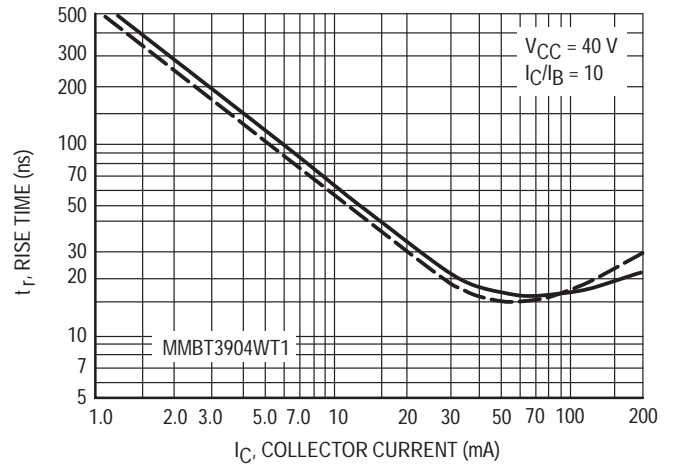


Figure 6. Rise Time

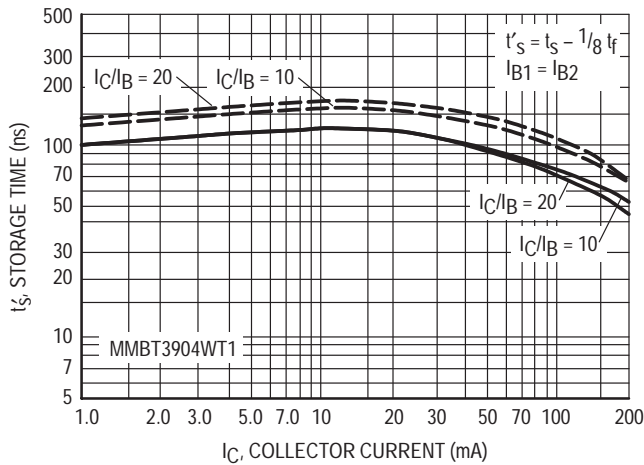


Figure 7. Storage Time

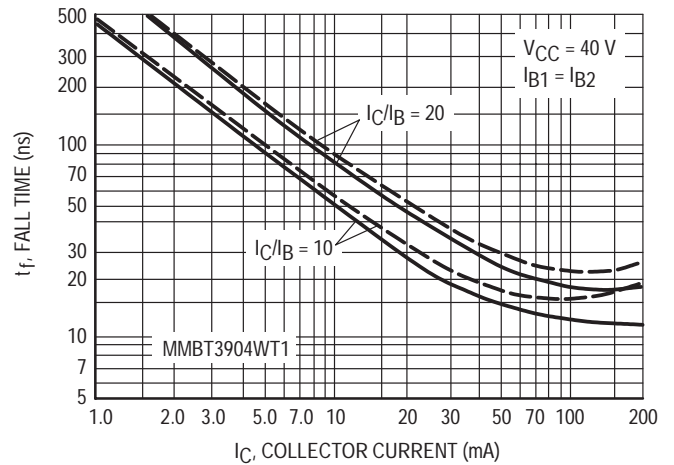


Figure 8. Fall Time

TYPICAL AUDIO SMALL-SIGNAL CHARACTERISTICS
NOISE FIGURE VARIATIONS

(V_{CE} = 5.0 Vdc, T_A = 25°C, Bandwidth = 1.0 Hz)

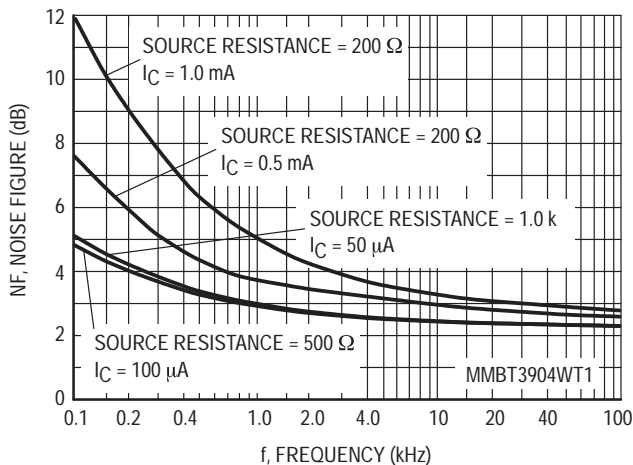


Figure 9. Noise Figure

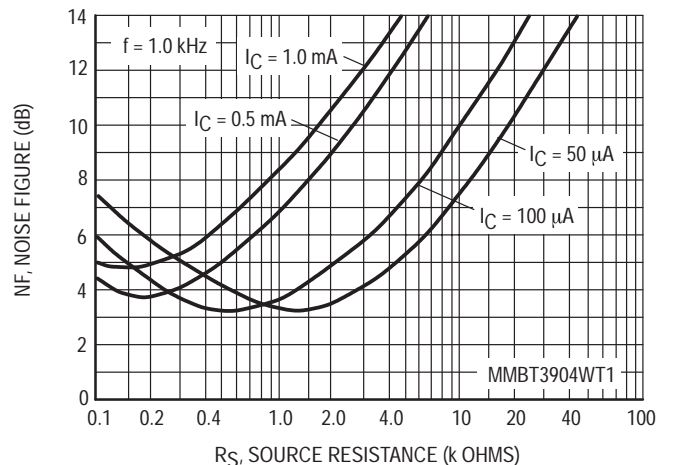


Figure 10. Noise Figure

MMBT3904WT1

h PARAMETERS

($V_{CE} = 10 \text{ Vdc}$, $f = 1.0 \text{ kHz}$, $T_A = 25^\circ\text{C}$)

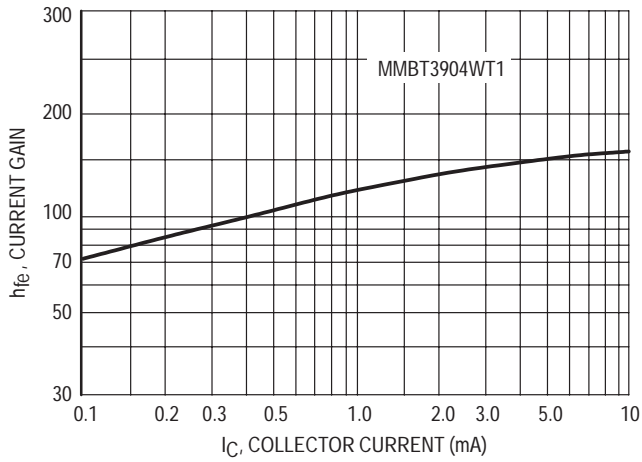


Figure 11. Current Gain

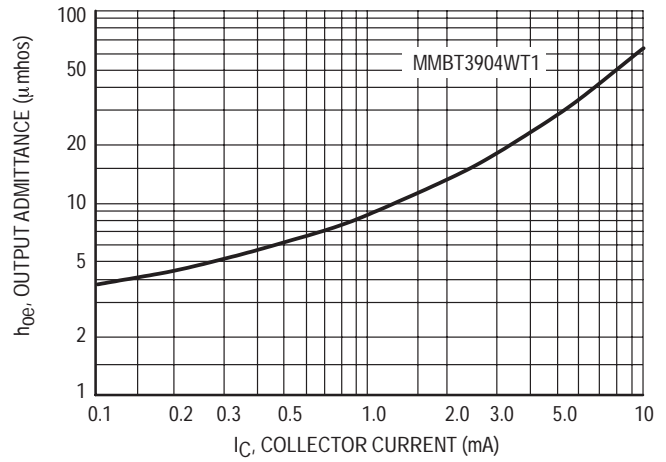


Figure 12. Output Admittance

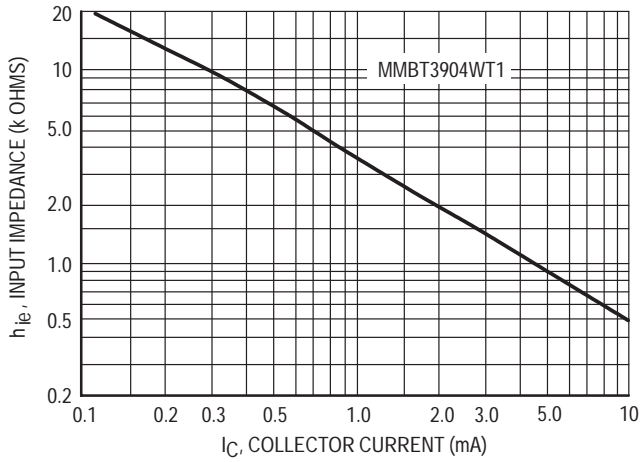


Figure 13. Input Impedance

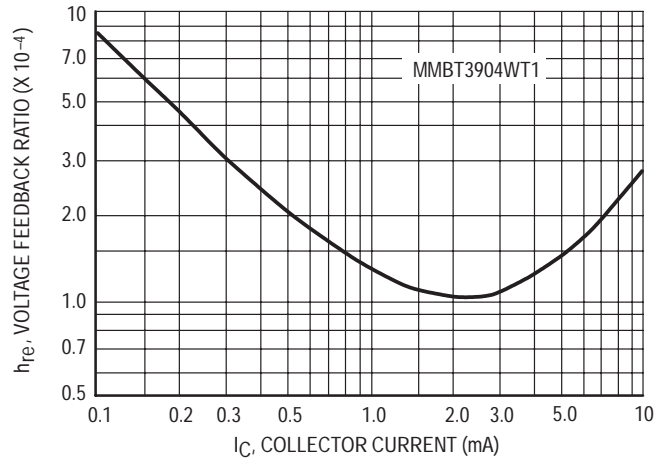


Figure 14. Voltage Feedback Ratio

MMBT3904WT1

TYPICAL STATIC CHARACTERISTICS

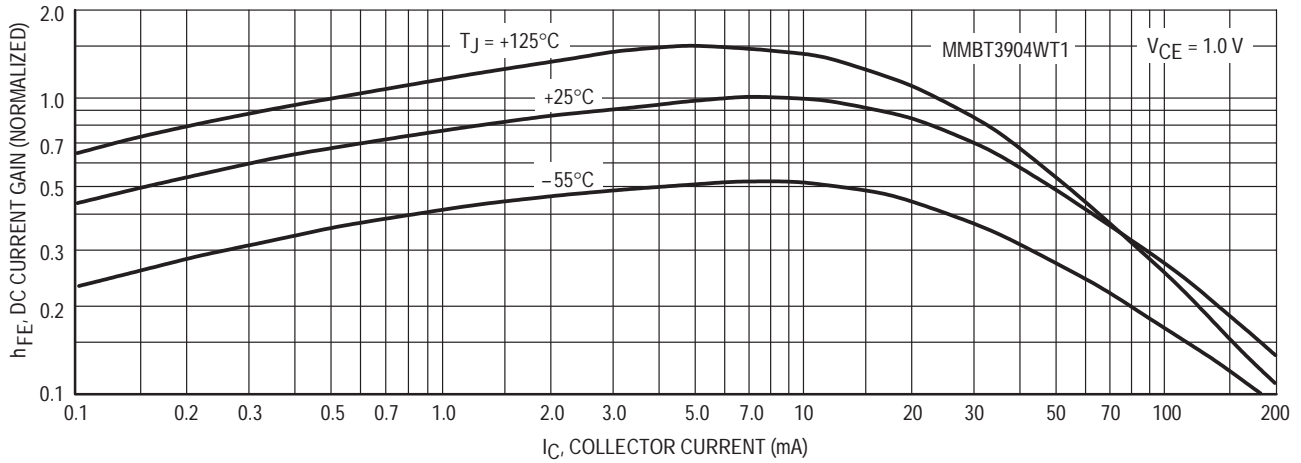


Figure 15. DC Current Gain

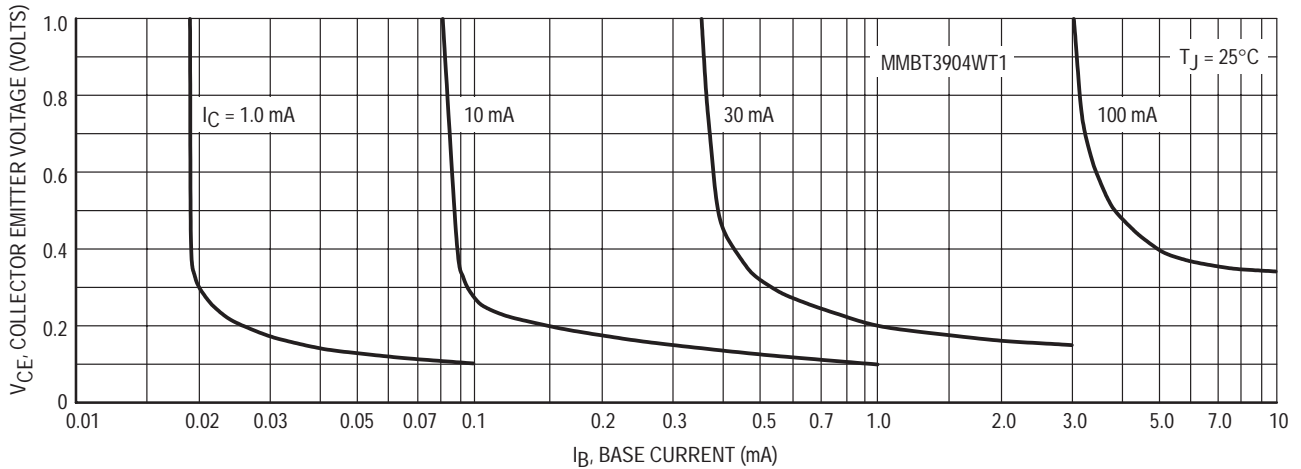


Figure 16. Collector Saturation Region

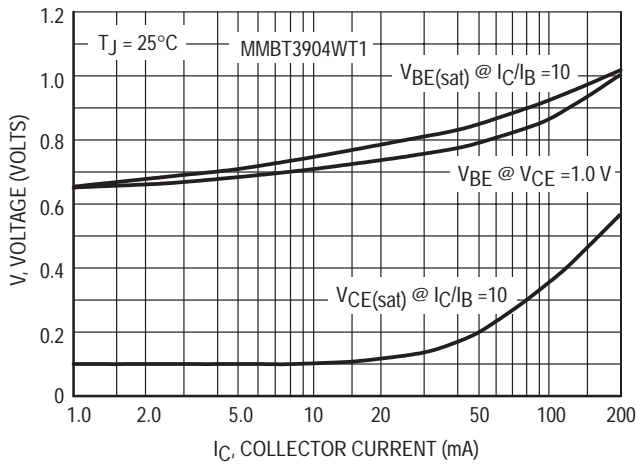


Figure 17. "ON" Voltages

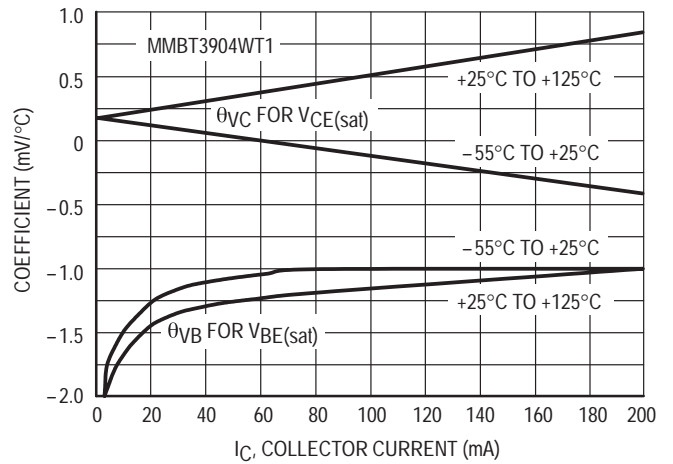


Figure 18. Temperature Coefficients

MMBT3906WT1

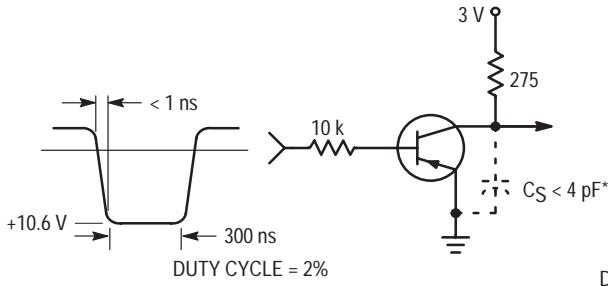


Figure 19. Delay and Rise Time Equivalent Test Circuit

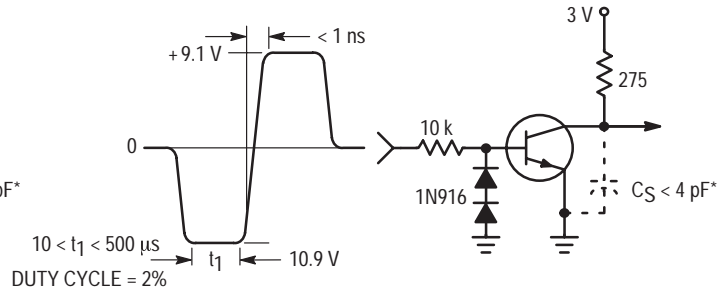


Figure 20. Storage and Fall Time Equivalent Test Circuit

* Total shunt capacitance of test jig and connectors

TYPICAL TRANSIENT CHARACTERISTICS

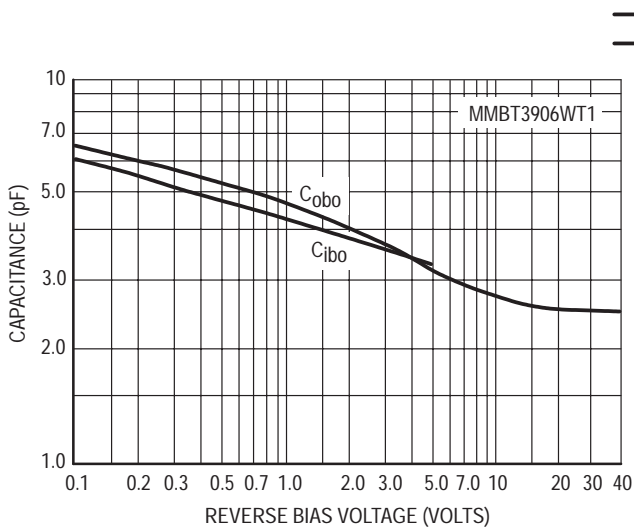


Figure 21. Capacitance

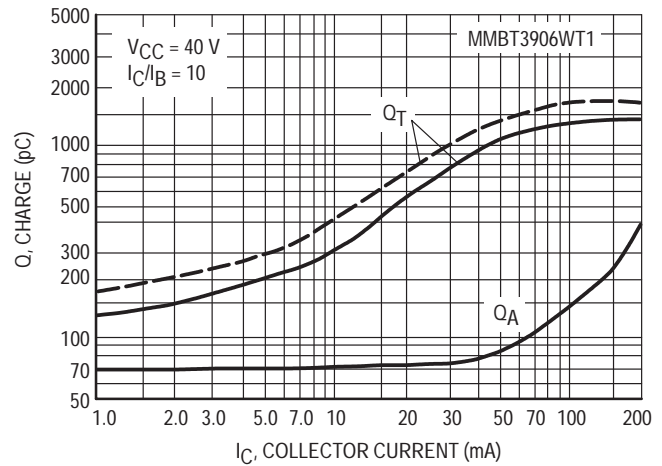


Figure 22. Charge Data

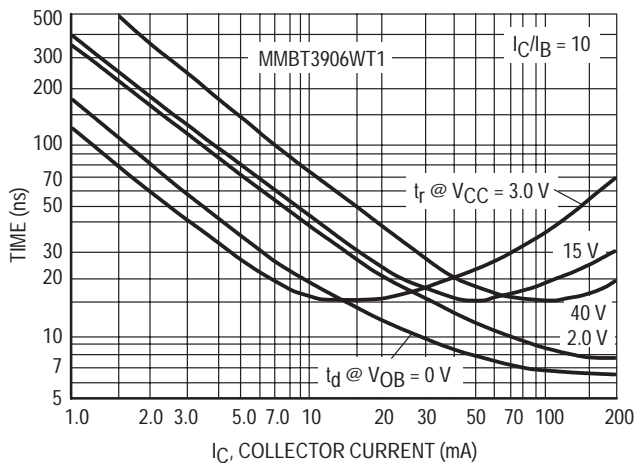


Figure 23. Turn-On Time

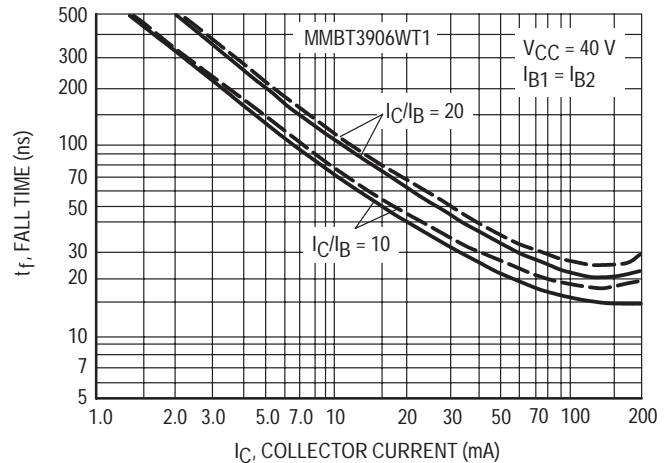


Figure 24. Fall Time

MMBT3906WT1

TYPICAL AUDIO SMALL-SIGNAL CHARACTERISTICS
NOISE FIGURE VARIATIONS

($V_{CE} = -5.0$ Vdc, $T_A = 25^\circ\text{C}$, Bandwidth = 1.0 Hz)

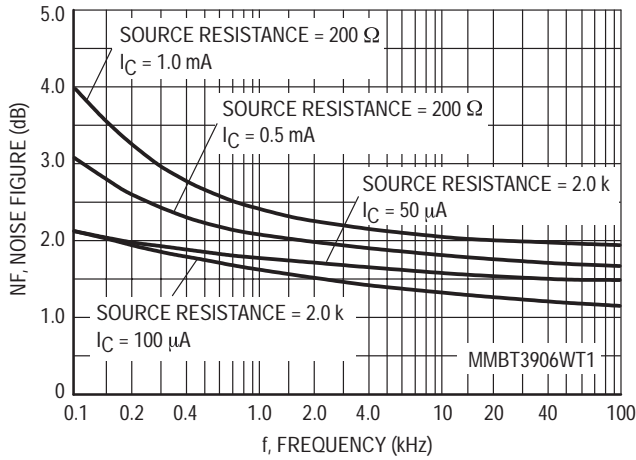


Figure 25.

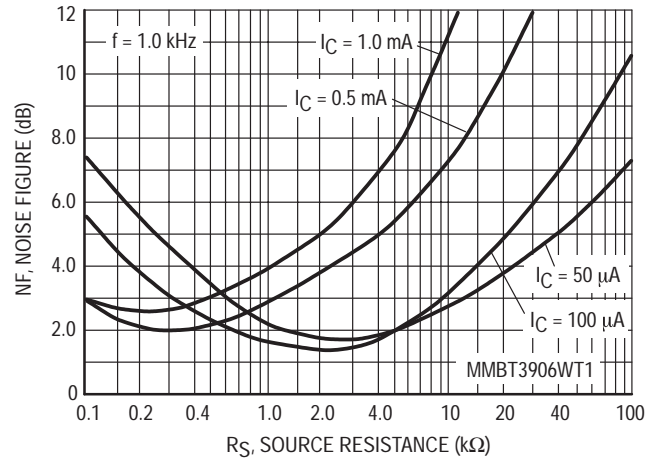


Figure 26.

h PARAMETERS

($V_{CE} = -10$ Vdc, $f = 1.0$ kHz, $T_A = 25^\circ\text{C}$)

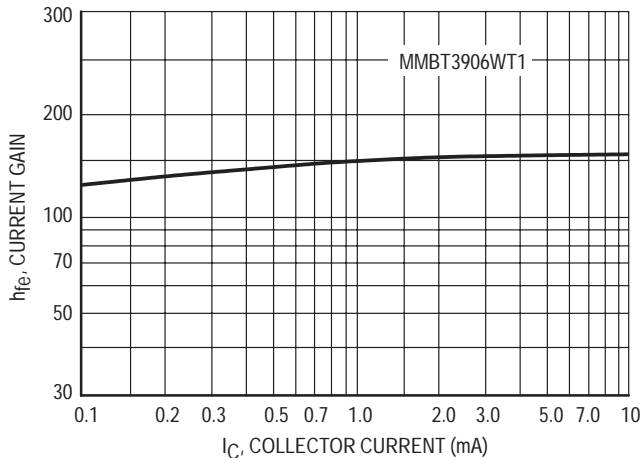


Figure 27. Current Gain

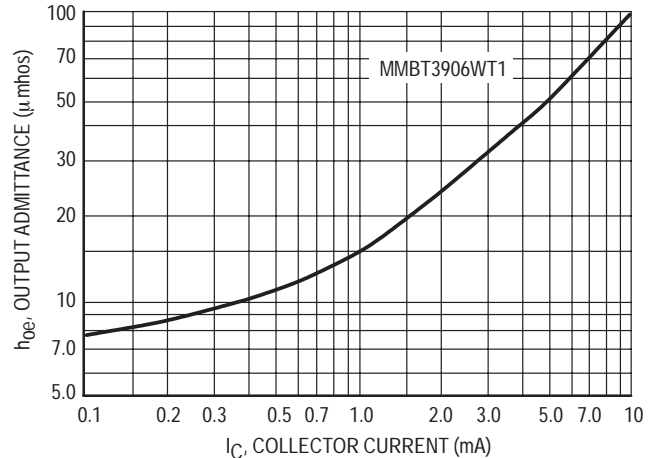


Figure 28. Output Admittance

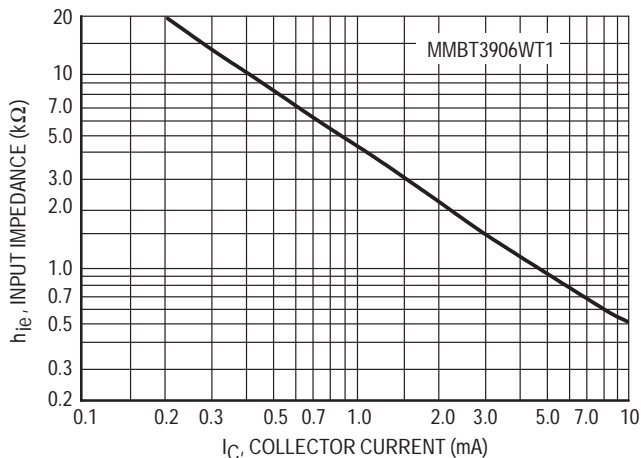


Figure 29. Input Impedance

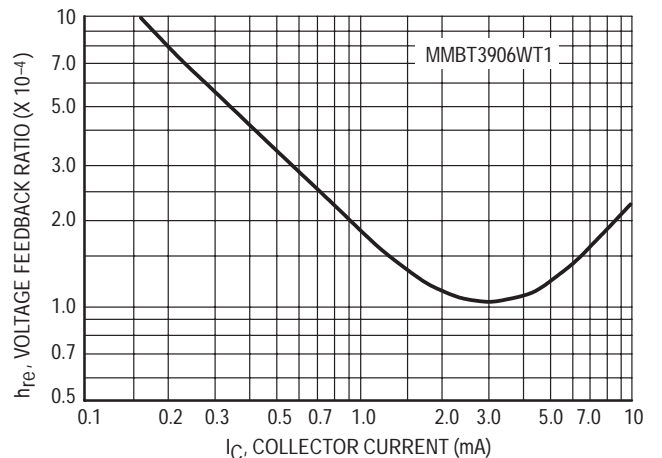


Figure 30. Voltage Feedback Ratio

MMBT3906WT1

STATIC CHARACTERISTICS

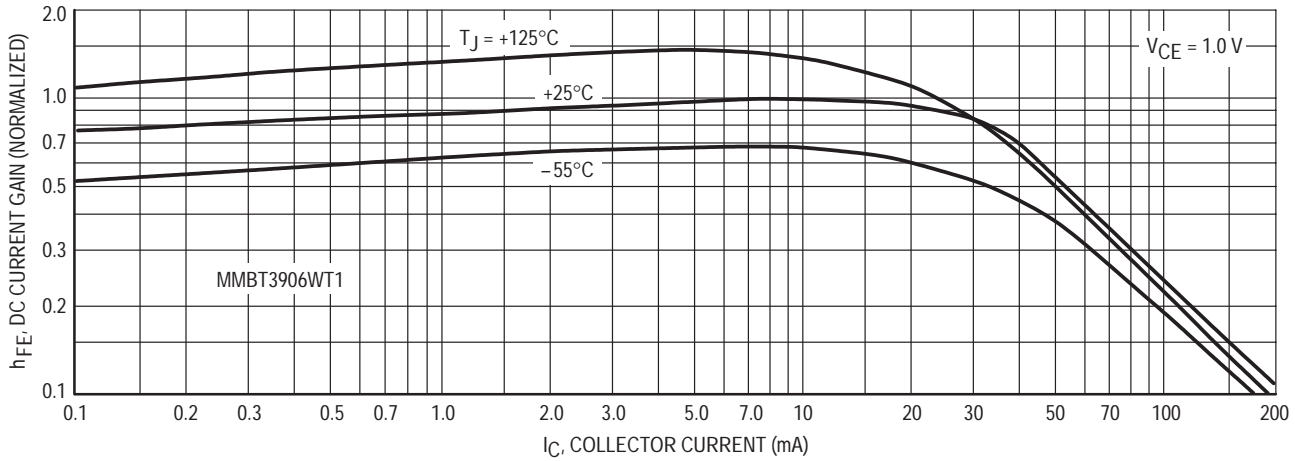


Figure 31. DC Current Gain

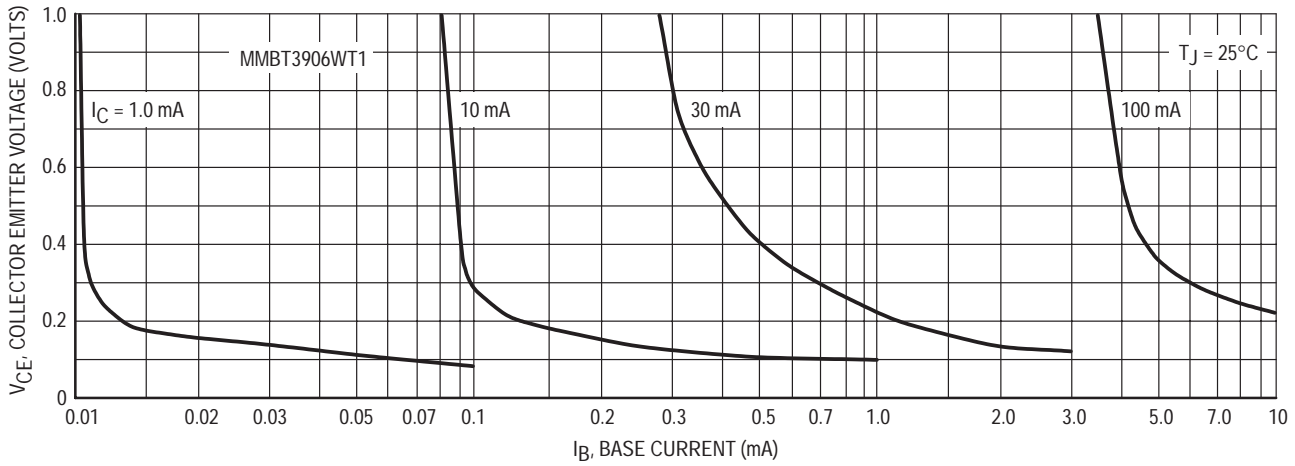


Figure 32. Collector Saturation Region

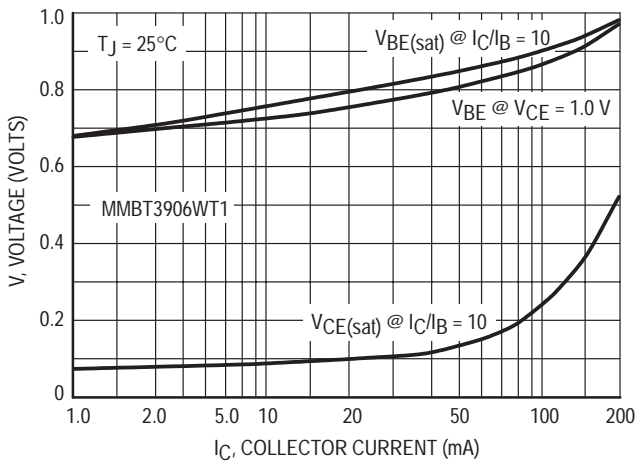


Figure 33. "ON" Voltages

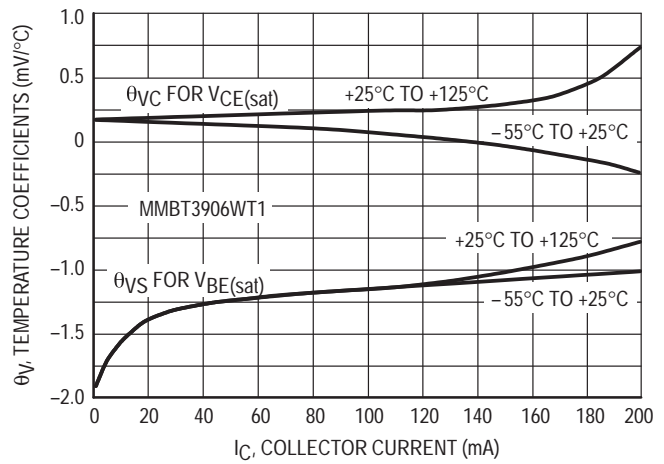
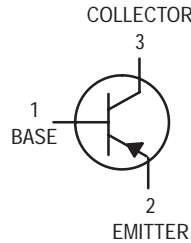


Figure 34. Temperature Coefficients

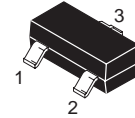
General Purpose Transistor

PNP Silicon



MMBT3906LT1

Motorola Preferred Device



CASE 318-08, STYLE 6
SOT-23 (TO-236AB)

MAXIMUM RATINGS

Rating	Symbol	Value	Unit
Collector–Emitter Voltage	V_{CEO}	–40	Vdc
Collector–Base Voltage	V_{CBO}	–40	Vdc
Emitter–Base Voltage	V_{EBO}	–5.0	Vdc
Collector Current — Continuous	I_C	–200	mAdc

THERMAL CHARACTERISTICS

Characteristic	Symbol	Max	Unit
Total Device Dissipation FR–5 Board ⁽¹⁾ $T_A = 25^\circ\text{C}$ Derate above 25°C	P_D	225	mW
		1.8	mW/ $^\circ\text{C}$
Thermal Resistance Junction to Ambient	$R_{\theta JA}$	556	$^\circ\text{C}/\text{W}$
Total Device Dissipation Alumina Substrate, ⁽²⁾ $T_A = 25^\circ\text{C}$ Derate above 25°C	P_D	300	mW
		2.4	mW/ $^\circ\text{C}$
Thermal Resistance Junction to Ambient	$R_{\theta JA}$	417	$^\circ\text{C}/\text{W}$
Junction and Storage Temperature	T_J, T_{stg}	–55 to +150	$^\circ\text{C}$

DEVICE MARKING

MMBT3906LT1 = 2A

ELECTRICAL CHARACTERISTICS ($T_A = 25^\circ\text{C}$ unless otherwise noted)

Characteristic	Symbol	Min	Max	Unit
----------------	--------	-----	-----	------

OFF CHARACTERISTICS

Collector–Emitter Breakdown Voltage ⁽³⁾ ($I_C = -1.0$ mAdc, $I_B = 0$)	$V_{(BR)CEO}$	–40	—	Vdc
Collector–Base Breakdown Voltage ($I_C = -10$ μ Adc, $I_E = 0$)	$V_{(BR)CBO}$	–40	—	Vdc
Emitter–Base Breakdown Voltage ($I_E = -10$ μ Adc, $I_C = 0$)	$V_{(BR)EBO}$	–5.0	—	Vdc
Base Cutoff Current ($V_{CE} = -30$ Vdc, $V_{EB} = -3.0$ Vdc)	I_{BL}	—	–50	nAdc
Collector Cutoff Current ($V_{CE} = -30$ Vdc, $V_{EB} = -3.0$ Vdc)	I_{CEX}	—	–50	nAdc

- FR–5 = $1.0 \times 0.75 \times 0.062$ in.
- Alumina = $0.4 \times 0.3 \times 0.024$ in. 99.5% alumina.
- Pulse Width ≤ 300 μ s, Duty Cycle $\leq 2.0\%$.

Preferred devices are Motorola recommended choices for future use and best overall value.

MMBT3906LT1

ELECTRICAL CHARACTERISTICS (T_A = 25°C unless otherwise noted) (Continued)

Characteristic	Symbol	Min	Max	Unit
ON CHARACTERISTICS(3)				
DC Current Gain (I _C = -0.1 mA _{dc} , V _{CE} = -1.0 V _{dc}) (I _C = -1.0 mA _{dc} , V _{CE} = -1.0 V _{dc}) (I _C = -10 mA _{dc} , V _{CE} = -1.0 V _{dc}) (I _C = -50 mA _{dc} , V _{CE} = -1.0 V _{dc}) (I _C = -100 mA _{dc} , V _{CE} = -1.0 V _{dc})	H _{FE}	60 80 100 60 30	— — 300 — —	—
Collector–Emitter Saturation Voltage (I _C = -10 mA _{dc} , I _B = -1.0 mA _{dc}) (I _C = -50 mA _{dc} , I _B = -5.0 mA _{dc})	V _{CE(sat)}	— —	-0.25 -0.4	V _{dc}
Base–Emitter Saturation Voltage (I _C = -10 mA _{dc} , I _B = -1.0 mA _{dc}) (I _C = -50 mA _{dc} , I _B = -5.0 mA _{dc})	V _{BE(sat)}	-0.65 —	-0.85 -0.95	V _{dc}

SMALL–SIGNAL CHARACTERISTICS

Current–Gain — Bandwidth Product (I _C = -10 mA _{dc} , V _{CE} = -20 V _{dc} , f = 100 MHz)	f _T	250	—	MHz
Output Capacitance (V _{CB} = -5.0 V _{dc} , I _E = 0, f = 1.0 MHz)	C _{obo}	—	4.5	pF
Input Capacitance (V _{EB} = -0.5 V _{dc} , I _C = 0, f = 1.0 MHz)	C _{ibo}	—	10	pF
Input Impedance (I _C = -1.0 mA _{dc} , V _{CE} = -10 V _{dc} , f = 1.0 kHz)	h _{ie}	2.0	12	kΩ
Voltage Feedback Ratio (I _C = -1.0 mA _{dc} , V _{CE} = -10 V _{dc} , f = 1.0 kHz)	h _{re}	0.1	10	X 10 ⁻⁴
Small–Signal Current Gain (I _C = -1.0 mA _{dc} , V _{CE} = -10 V _{dc} , f = 1.0 kHz)	h _{fe}	100	400	—
Output Admittance (I _C = -1.0 mA _{dc} , V _{CE} = -10 V _{dc} , f = 1.0 kHz)	h _{oe}	3.0	60	μmhos
Noise Figure (I _C = -100 μA _{dc} , V _{CE} = -5.0 V _{dc} , R _S = 1.0 kΩ, f = 1.0 kHz)	NF	—	4.0	dB

SWITCHING CHARACTERISTICS

Delay Time	(V _{CC} = -3.0 V _{dc} , V _{BE} = 0.5 V _{dc} , I _C = -10 mA _{dc} , I _{B1} = -1.0 mA _{dc})	t _d	—	35	ns
Rise Time		t _r	—	35	
Storage Time	(V _{CC} = -3.0 V _{dc} , I _C = -10 mA _{dc} , I _{B1} = I _{B2} = -1.0 mA _{dc})	t _s	—	225	ns
Fall Time		t _f	—	75	

3. Pulse Test: Pulse Width ≤ 300 μs, Duty Cycle ≤ 2.0%.

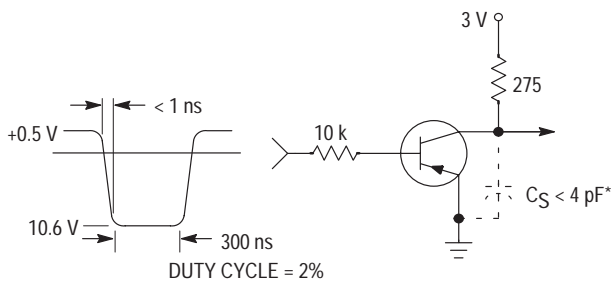


Figure 1. Delay and Rise Time Equivalent Test Circuit

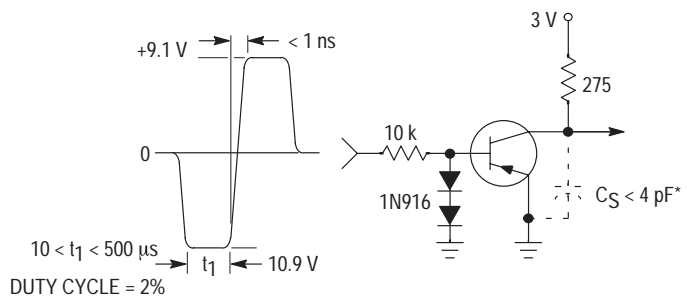


Figure 2. Storage and Fall Time Equivalent Test Circuit

* Total shunt capacitance of test jig and connectors

TYPICAL TRANSIENT CHARACTERISTICS

— $T_J = 25^\circ\text{C}$
 - - - $T_J = 125^\circ\text{C}$

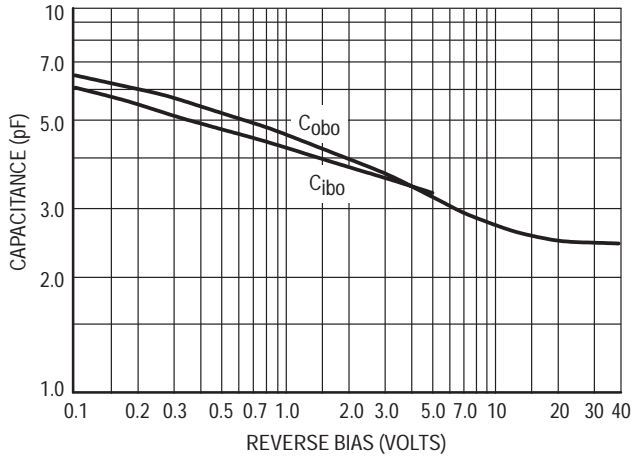


Figure 3. Capacitance

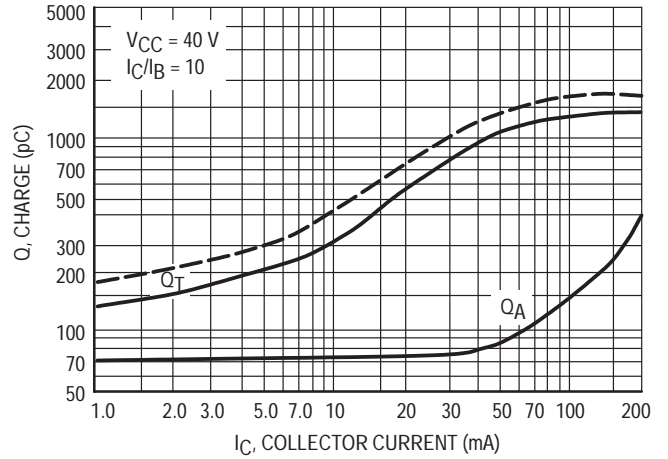


Figure 4. Charge Data

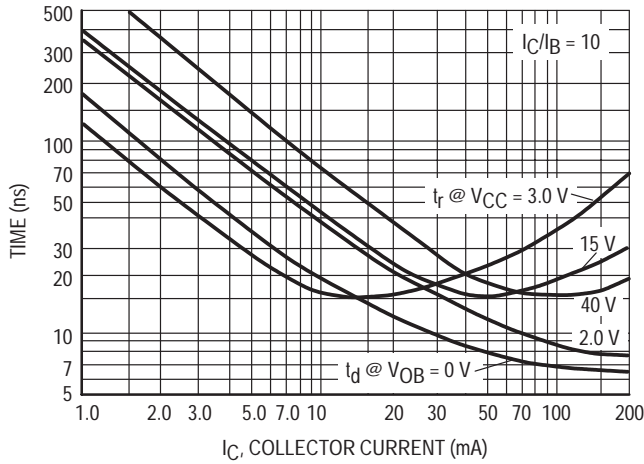


Figure 5. Turn-On Time

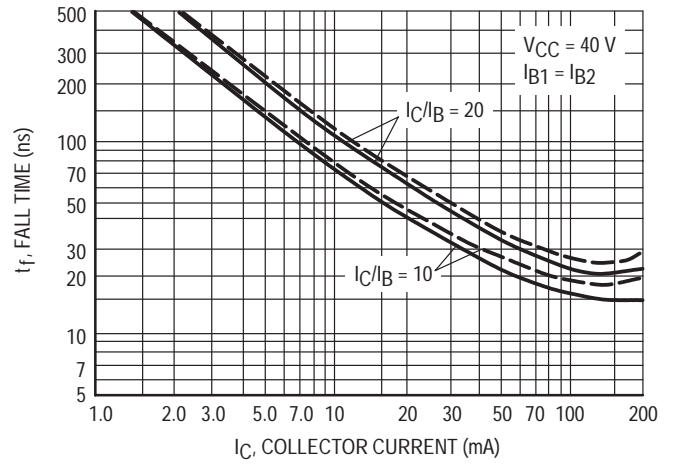


Figure 6. Fall Time

TYPICAL AUDIO SMALL-SIGNAL CHARACTERISTICS
NOISE FIGURE VARIATIONS

($V_{CE} = -5.0$ Vdc, $T_A = 25^\circ\text{C}$, Bandwidth = 1.0 Hz)

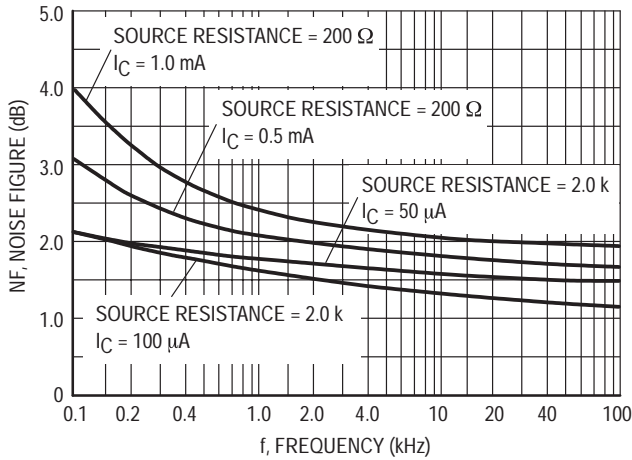


Figure 7.

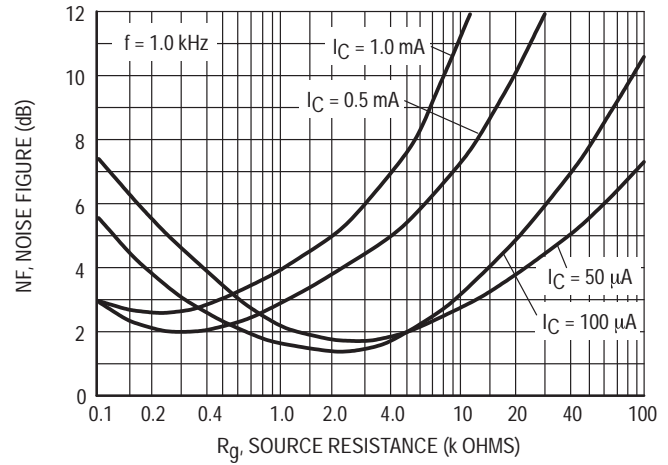


Figure 8.

h PARAMETERS

($V_{CE} = -10$ Vdc, $f = 1.0$ kHz, $T_A = 25^\circ\text{C}$)

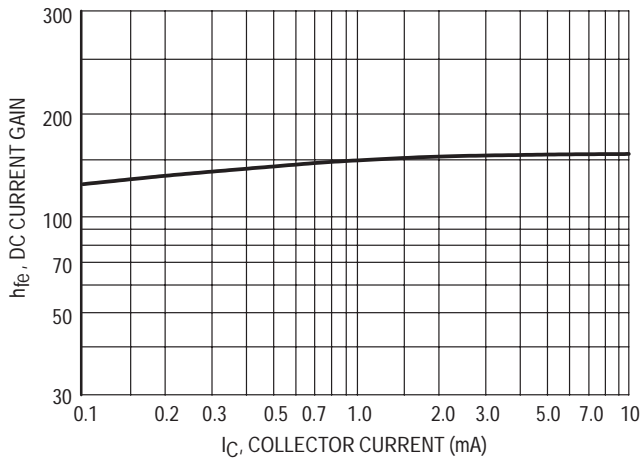


Figure 9. Current Gain

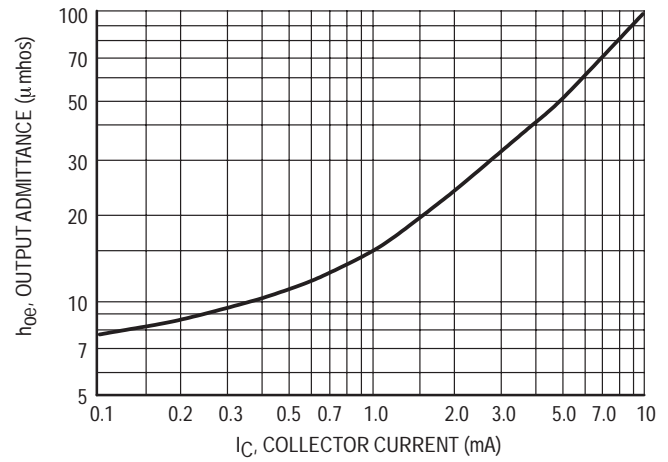


Figure 10. Output Admittance

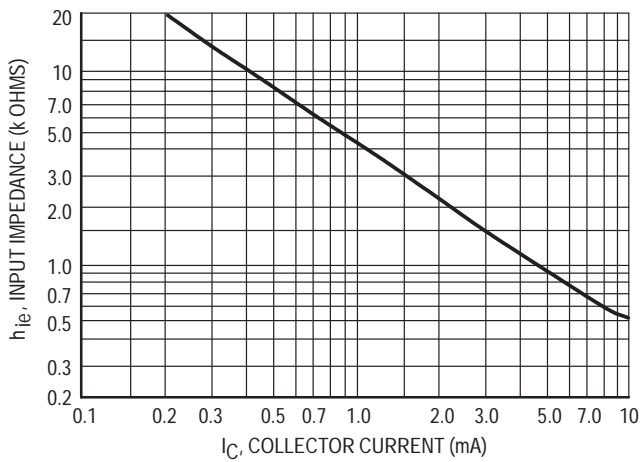


Figure 11. Input Impedance

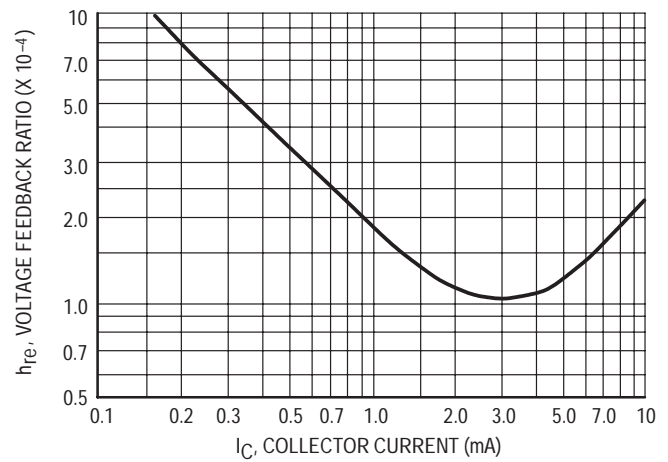


Figure 12. Voltage Feedback Ratio

TYPICAL STATIC CHARACTERISTICS

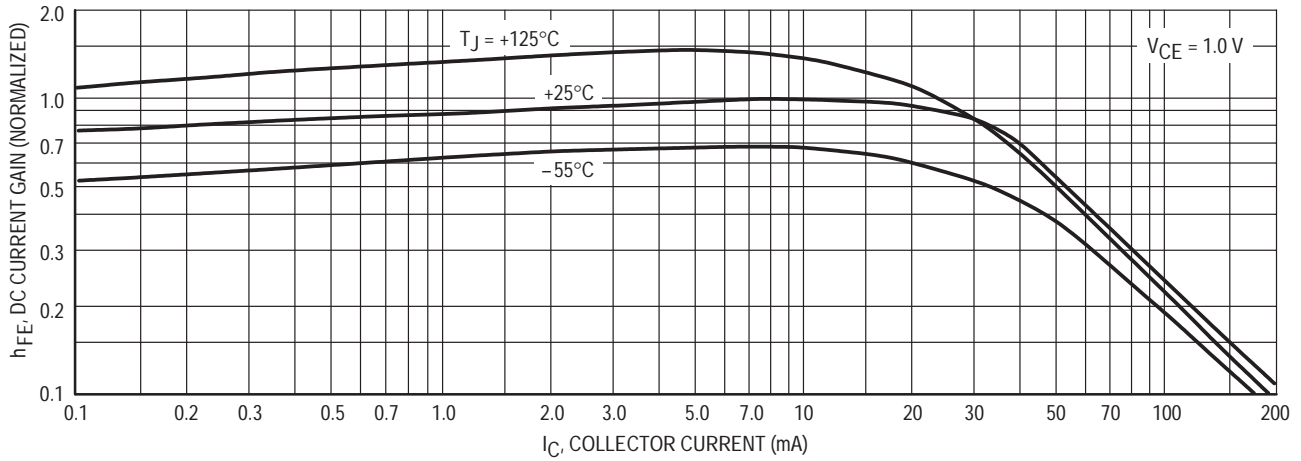


Figure 13. DC Current Gain

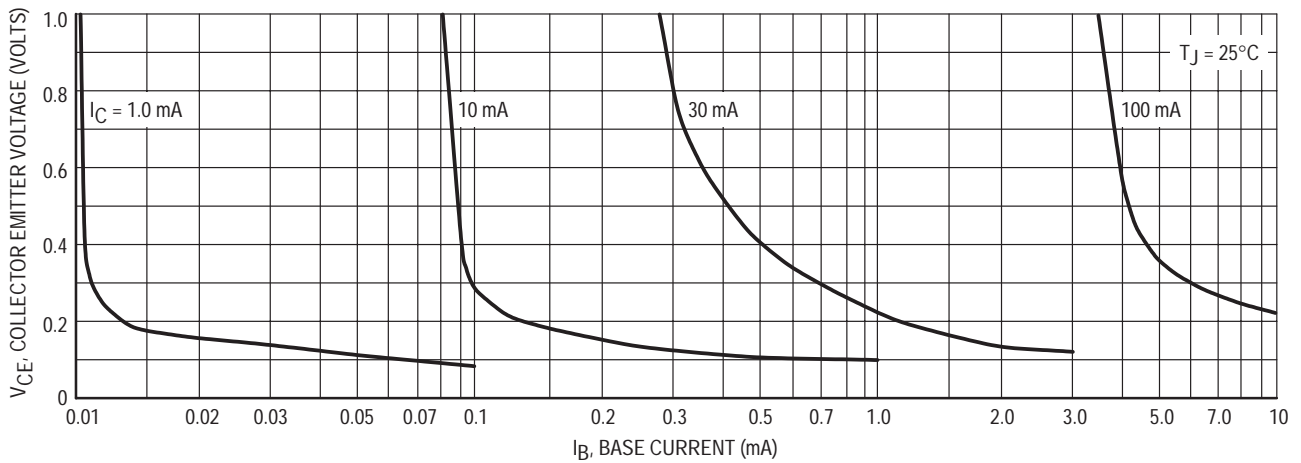


Figure 14. Collector Saturation Region

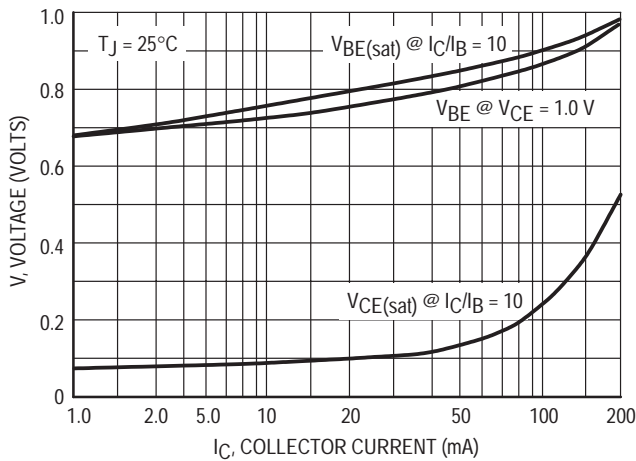


Figure 15. "ON" Voltages

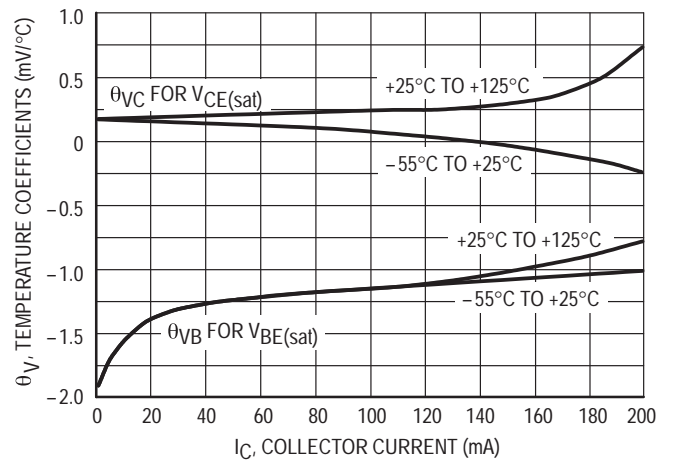
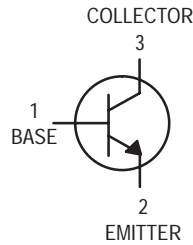


Figure 16. Temperature Coefficients

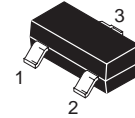
Switching Transistor

NPN Silicon



MMBT4401LT1

Motorola Preferred Device



CASE 318-08, STYLE 6
SOT-23 (TO-236AB)

MAXIMUM RATINGS

Rating	Symbol	Value	Unit
Collector–Emitter Voltage	V_{CEO}	40	Vdc
Collector–Base Voltage	V_{CBO}	60	Vdc
Emitter–Base Voltage	V_{EBO}	6.0	Vdc
Collector Current — Continuous	I_C	600	mAdc

THERMAL CHARACTERISTICS

Characteristic	Symbol	Max	Unit
Total Device Dissipation FR-5 Board ⁽¹⁾ $T_A = 25^\circ\text{C}$ Derate above 25°C	P_D	225 1.8	mW mW/ $^\circ\text{C}$
Thermal Resistance, Junction to Ambient	$R_{\theta JA}$	556	$^\circ\text{C}/\text{W}$
Total Device Dissipation Alumina Substrate, ⁽²⁾ $T_A = 25^\circ\text{C}$ Derate above 25°C	P_D	300 2.4	mW mW/ $^\circ\text{C}$
Thermal Resistance, Junction to Ambient	$R_{\theta JA}$	417	$^\circ\text{C}/\text{W}$
Junction and Storage Temperature	T_J, T_{stg}	-55 to +150	$^\circ\text{C}$

DEVICE MARKING

MMBT4401LT1 = 2X

ELECTRICAL CHARACTERISTICS ($T_A = 25^\circ\text{C}$ unless otherwise noted)

Characteristic	Symbol	Min	Max	Unit
----------------	--------	-----	-----	------

OFF CHARACTERISTICS

Collector–Emitter Breakdown Voltage ⁽³⁾ ($I_C = 1.0$ mAdc, $I_B = 0$)	$V_{(BR)CEO}$	40	—	Vdc
Collector–Base Breakdown Voltage ($I_C = 0.1$ mAdc, $I_E = 0$)	$V_{(BR)CBO}$	60	—	Vdc
Emitter–Base Breakdown Voltage ($I_E = 0.1$ mAdc, $I_C = 0$)	$V_{(BR)EBO}$	6.0	—	Vdc
Base Cutoff Current ($V_{CE} = 35$ Vdc, $V_{EB} = 0.4$ Vdc)	I_{BEV}	—	0.1	μAdc
Collector Cutoff Current ($V_{CE} = 35$ Vdc, $V_{EB} = 0.4$ Vdc)	I_{CEX}	—	0.1	μAdc

- FR-5 = $1.0 \times 0.75 \times 0.062$ in.
- Alumina = $0.4 \times 0.3 \times 0.024$ in. 99.5% alumina.
- Pulse Test: Pulse Width ≤ 300 μs , Duty Cycle $\leq 2.0\%$.

Preferred devices are Motorola recommended choices for future use and best overall value.

ELECTRICAL CHARACTERISTICS (continued) ($T_A = 25^\circ\text{C}$ unless otherwise noted)

Characteristic	Symbol	Min	Max	Unit
ON CHARACTERISTICS(3)				
DC Current Gain ($I_C = 0.1 \text{ mA dc}, V_{CE} = 1.0 \text{ V dc}$) ($I_C = 1.0 \text{ mA dc}, V_{CE} = 1.0 \text{ V dc}$) ($I_C = 10 \text{ mA dc}, V_{CE} = 1.0 \text{ V dc}$) ($I_C = 150 \text{ mA dc}, V_{CE} = 1.0 \text{ V dc}$) ($I_C = 500 \text{ mA dc}, V_{CE} = 2.0 \text{ V dc}$)	h_{FE}	20 40 80 100 40	— — — 300 —	—
Collector–Emitter Saturation Voltage ($I_C = 150 \text{ mA dc}, I_B = 15 \text{ mA dc}$) ($I_C = 500 \text{ mA dc}, I_B = 50 \text{ mA dc}$)	$V_{CE(sat)}$	— —	0.4 0.75	Vdc
Base–Emitter Saturation Voltage ($I_C = 150 \text{ mA dc}, I_B = 15 \text{ mA dc}$) ($I_C = 500 \text{ mA dc}, I_B = 50 \text{ mA dc}$)	$V_{BE(sat)}$	0.75 —	0.95 1.2	Vdc

SMALL–SIGNAL CHARACTERISTICS

Current–Gain — Bandwidth Product ($I_C = 20 \text{ mA dc}, V_{CE} = 10 \text{ V dc}, f = 100 \text{ MHz}$)	f_T	250	—	MHz
Collector–Base Capacitance ($V_{CB} = 5.0 \text{ V dc}, I_E = 0, f = 1.0 \text{ MHz}$)	C_{cb}	—	6.5	pF
Emitter–Base Capacitance ($V_{EB} = 0.5 \text{ V dc}, I_C = 0, f = 1.0 \text{ MHz}$)	C_{eb}	—	30	pF
Input Impedance ($I_C = 1.0 \text{ mA dc}, V_{CE} = 10 \text{ V dc}, f = 1.0 \text{ kHz}$)	h_{ie}	1.0	15	k Ω
Voltage Feedback Ratio ($I_C = 1.0 \text{ mA dc}, V_{CE} = 10 \text{ V dc}, f = 1.0 \text{ kHz}$)	h_{re}	0.1	8.0	$\times 10^{-4}$
Small–Signal Current Gain ($I_C = 1.0 \text{ mA dc}, V_{CE} = 10 \text{ V dc}, f = 1.0 \text{ kHz}$)	h_{fe}	40	500	—
Output Admittance ($I_C = 1.0 \text{ mA dc}, V_{CE} = 10 \text{ V dc}, f = 1.0 \text{ kHz}$)	h_{oe}	1.0	30	μmhos

SWITCHING CHARACTERISTICS

Delay Time	($V_{CC} = 30 \text{ V dc}, V_{EB} = 2.0 \text{ V dc}, I_C = 150 \text{ mA dc}, I_{B1} = 15 \text{ mA dc}$)	t_d	—	15	ns
Rise Time		t_r	—	20	
Storage Time	($V_{CC} = 30 \text{ V dc}, I_C = 150 \text{ mA dc}, I_{B1} = I_{B2} = 15 \text{ mA dc}$)	t_s	—	225	ns
Fall Time		t_f	—	30	

3. Pulse Test: Pulse Width $\leq 300 \mu\text{s}$, Duty Cycle $\leq 2.0\%$.

SWITCHING TIME EQUIVALENT TEST CIRCUITS

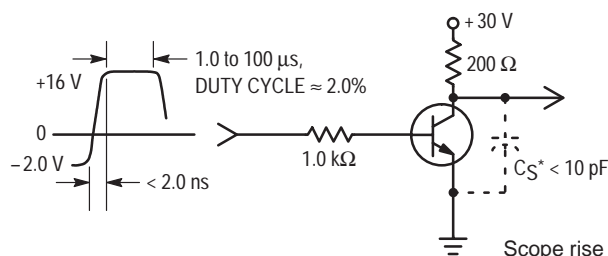


Figure 1. Turn–On Time

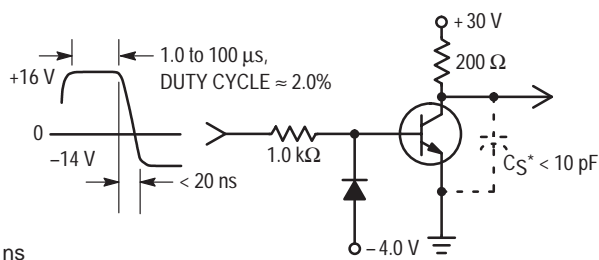


Figure 2. Turn–Off Time

TRANSIENT CHARACTERISTICS

— 25°C - - - 100°C

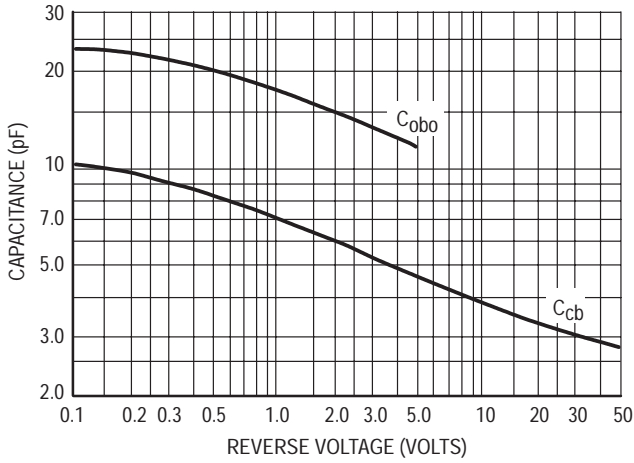


Figure 3. Capacitances

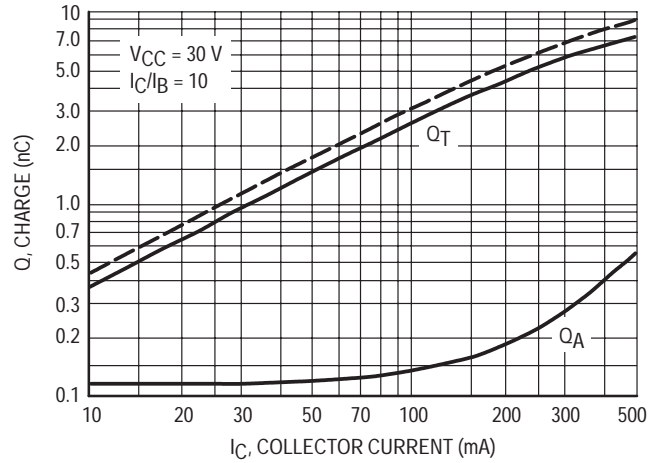


Figure 4. Charge Data

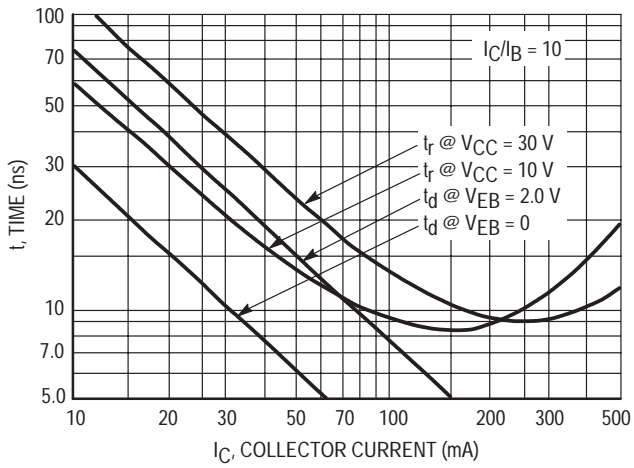


Figure 5. Turn-On Time

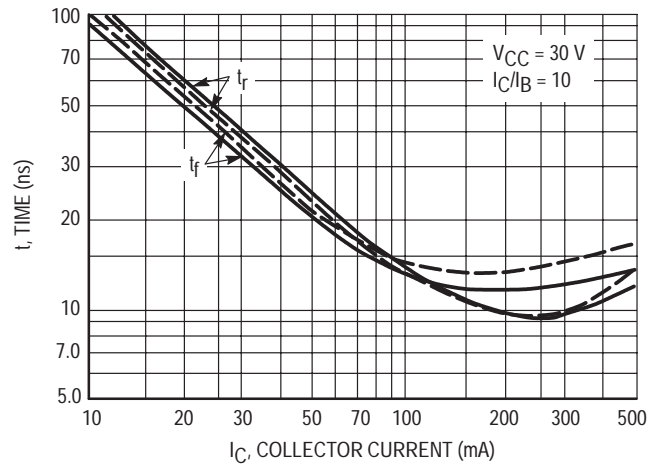


Figure 6. Rise and Fall Times

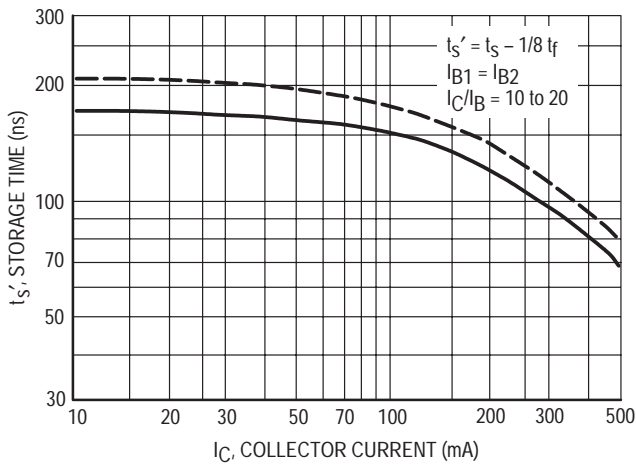


Figure 7. Storage Time

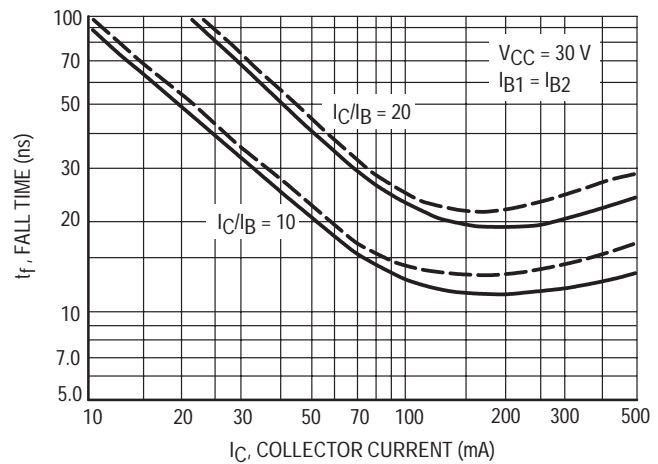


Figure 8. Fall Time

SMALL-SIGNAL CHARACTERISTICS

NOISE FIGURE

$V_{CE} = 10 \text{ Vdc}$, $T_A = 25^\circ\text{C}$

Bandwidth = 1.0 Hz

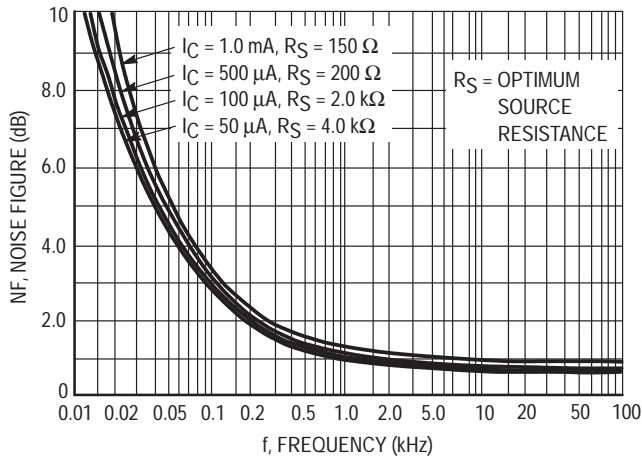


Figure 9. Frequency Effects

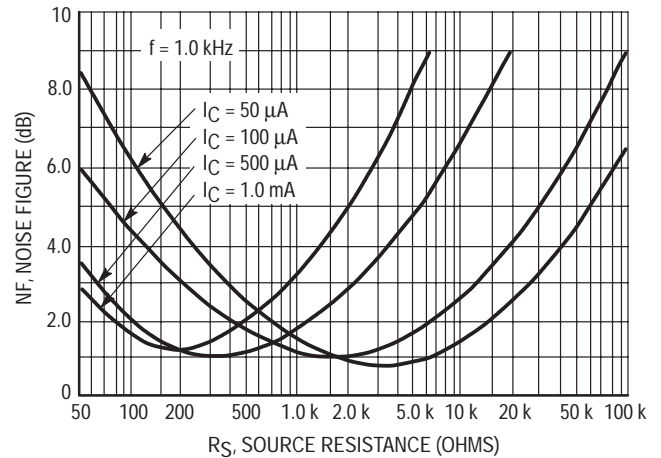


Figure 10. Source Resistance Effects

h PARAMETERS

$V_{CE} = 10 \text{ Vdc}$, $f = 1.0 \text{ kHz}$, $T_A = 25^\circ\text{C}$

This group of graphs illustrates the relationship between h_{fe} and other "h" parameters for this series of transistors. To obtain these curves, a high-gain and a low-gain unit were

selected from the MMBT4401LT1 lines, and the same units were used to develop the correspondingly numbered curves on each graph.

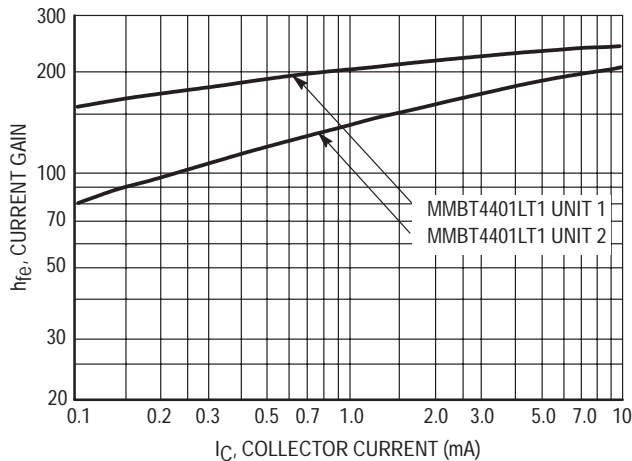


Figure 11. Current Gain

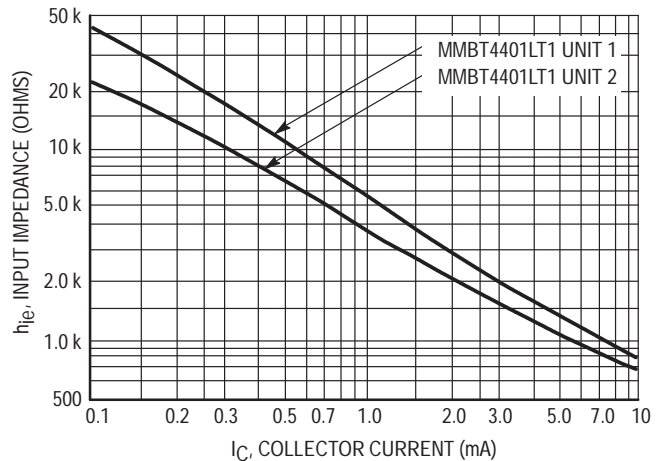


Figure 12. Input Impedance

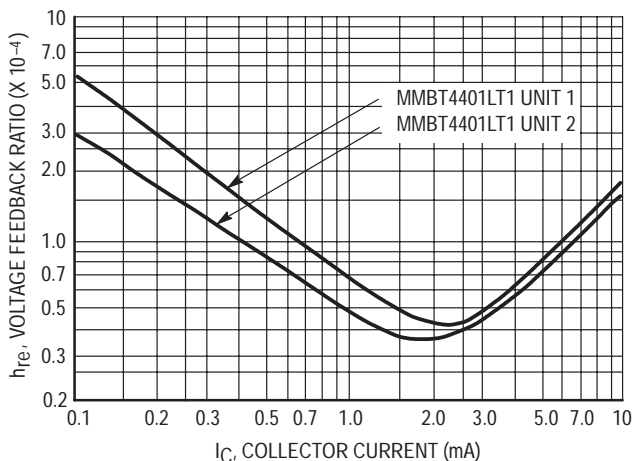


Figure 13. Voltage Feedback Ratio

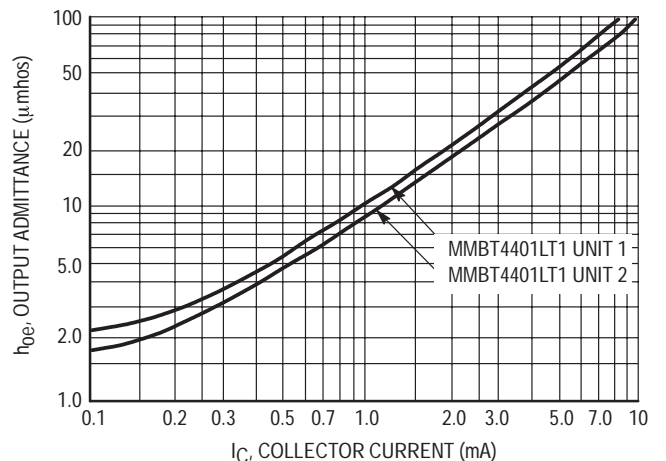


Figure 14. Output Admittance

STATIC CHARACTERISTICS

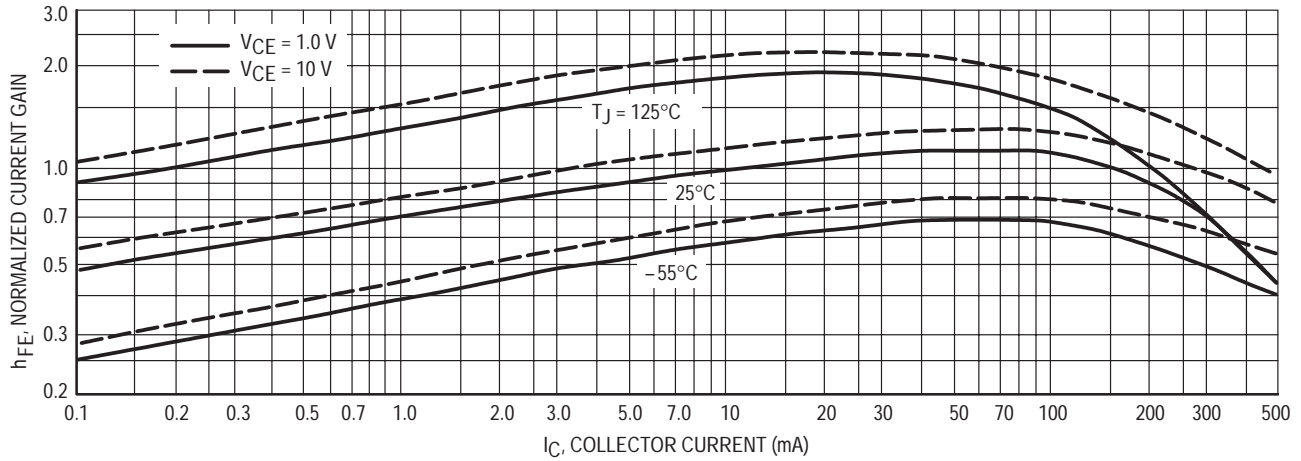


Figure 15. DC Current Gain

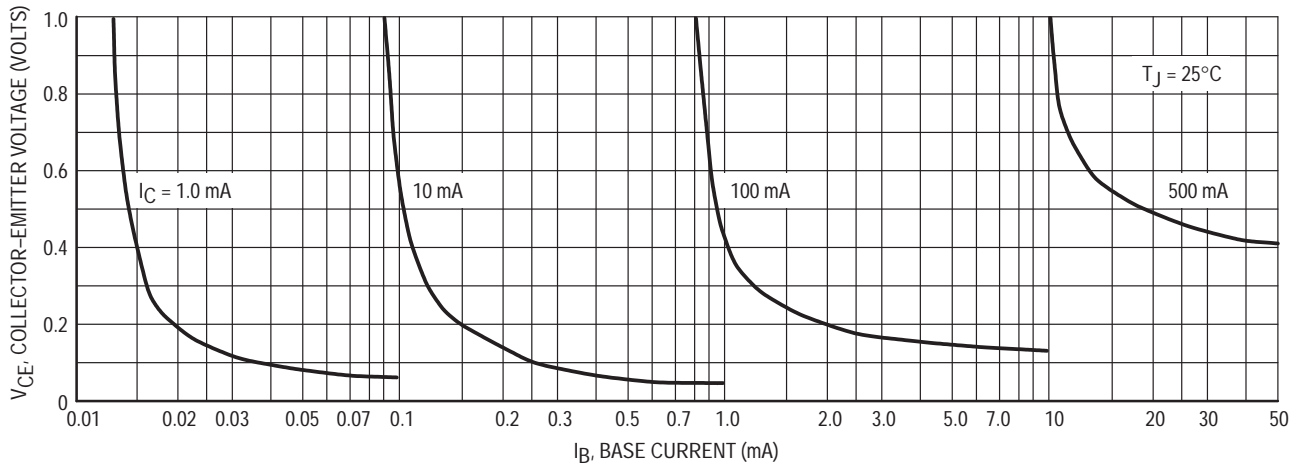


Figure 16. Collector Saturation Region

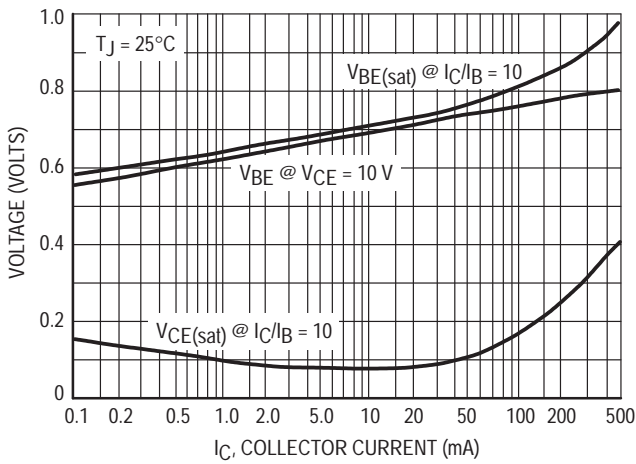


Figure 17. "On" Voltages

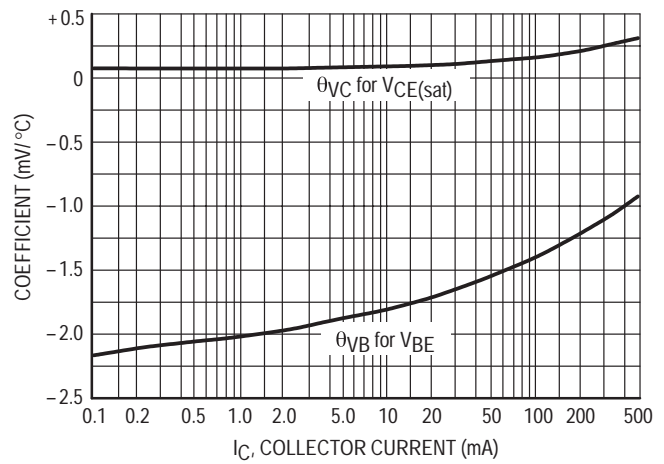
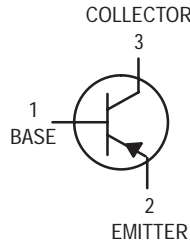


Figure 18. Temperature Coefficients

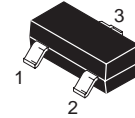
Switching Transistor

PNP Silicon



MMBT4403LT1

Motorola Preferred Device



CASE 318-08, STYLE 6
SOT-23 (TO-236AB)

MAXIMUM RATINGS

Rating	Symbol	Value	Unit
Collector–Emitter Voltage	V_{CEO}	–40	Vdc
Collector–Base Voltage	V_{CBO}	–40	Vdc
Emitter–Base Voltage	V_{EBO}	–5.0	Vdc
Collector Current — Continuous	I_C	–600	mAdc

THERMAL CHARACTERISTICS

Characteristic	Symbol	Max	Unit
Total Device Dissipation FR–5 Board ⁽¹⁾ $T_A = 25^\circ\text{C}$ Derate above 25°C	P_D	225	mW
		1.8	mW/ $^\circ\text{C}$
Thermal Resistance, Junction to Ambient	$R_{\theta JA}$	556	$^\circ\text{C}/\text{W}$
Total Device Dissipation Alumina Substrate, ⁽²⁾ $T_A = 25^\circ\text{C}$ Derate above 25°C	P_D	300	mW
		2.4	mW/ $^\circ\text{C}$
Thermal Resistance, Junction to Ambient	$R_{\theta JA}$	417	$^\circ\text{C}/\text{W}$
Junction and Storage Temperature	T_J, T_{stg}	–55 to +150	$^\circ\text{C}$

DEVICE MARKING

MMBT4403LT1 = 2T

ELECTRICAL CHARACTERISTICS ($T_A = 25^\circ\text{C}$ unless otherwise noted)

Characteristic	Symbol	Min	Max	Unit
----------------	--------	-----	-----	------

OFF CHARACTERISTICS

Collector–Emitter Breakdown Voltage ⁽³⁾ ($I_C = -1.0$ mAdc, $I_B = 0$)	$V_{(BR)CEO}$	–40	—	Vdc
Collector–Base Breakdown Voltage ($I_C = -0.1$ mAdc, $I_E = 0$)	$V_{(BR)CBO}$	–40	—	Vdc
Emitter–Base Breakdown Voltage ($I_E = -0.1$ mAdc, $I_C = 0$)	$V_{(BR)EBO}$	–5.0	—	Vdc
Base Cutoff Current ($V_{CE} = -35$ Vdc, $V_{EB} = -0.4$ Vdc)	I_{BEV}	—	–0.1	μAdc
Collector Cutoff Current ($V_{CE} = -35$ Vdc, $V_{EB} = -0.4$ Vdc)	I_{CEX}	—	–0.1	μAdc

- FR–5 = $1.0 \times 0.75 \times 0.062$ in.
- Alumina = $0.4 \times 0.3 \times 0.024$ in. 99.5% alumina.
- Pulse Test: Pulse Width ≤ 300 μs , Duty Cycle $\leq 2.0\%$.

Preferred devices are Motorola recommended choices for future use and best overall value.

MMBT4403LT1

ELECTRICAL CHARACTERISTICS (T_A = 25°C unless otherwise noted) (Continued)

Characteristic	Symbol	Min	Max	Unit
ON CHARACTERISTICS				
DC Current Gain (I _C = -0.1 mA _{dc} , V _{CE} = -1.0 V _{dc}) (I _C = -1.0 mA _{dc} , V _{CE} = -1.0 V _{dc}) (I _C = -10 mA _{dc} , V _{CE} = -1.0 V _{dc}) (I _C = -150 mA _{dc} , V _{CE} = -2.0 V _{dc}) ⁽³⁾ (I _C = -500 mA _{dc} , V _{CE} = -2.0 V _{dc}) ⁽³⁾	h _{FE}	30 60 100 100 20	— — — 300 —	—
Collector–Emitter Saturation Voltage ⁽³⁾ (I _C = -150 mA _{dc} , I _B = -15 mA _{dc}) (I _C = -500 mA _{dc} , I _B = -50 mA _{dc})	V _{CE(sat)}	— —	-0.4 -0.75	V _{dc}
Base–Emitter Saturation Voltage (3) (I _C = -150 mA _{dc} , I _B = -15 mA _{dc}) (I _C = -500 mA _{dc} , I _B = -50 mA _{dc})	V _{BE(sat)}	-0.75 —	-0.95 -1.3	V _{dc}

SMALL–SIGNAL CHARACTERISTICS

Current–Gain — Bandwidth Product (I _C = -20 mA _{dc} , V _{CE} = -10 V _{dc} , f = 100 MHz)	f _T	200	—	MHz
Collector–Base Capacitance (V _{CB} = -10 V _{dc} , I _E = 0, f = 1.0 MHz)	C _{cb}	—	8.5	pF
Emitter–Base Capacitance (V _{BE} = -0.5 V _{dc} , I _C = 0, f = 1.0 MHz)	C _{eb}	—	30	pF
Input Impedance (I _C = -1.0 mA _{dc} , V _{CE} = -10 V _{dc} , f = 1.0 kHz)	h _{ie}	1.5	15	kΩ
Voltage Feedback Ratio (I _C = -1.0 mA _{dc} , V _{CE} = -10 V _{dc} , f = 1.0 kHz)	h _{re}	0.1	8.0	X 10 ⁻⁴
Small–Signal Current Gain (I _C = -1.0 mA _{dc} , V _{CE} = -10 V _{dc} , f = 1.0 kHz)	h _{fe}	60	500	—
Output Admittance (I _C = -1.0 mA _{dc} , V _{CE} = -10 V _{dc} , f = 1.0 kHz)	h _{oe}	1.0	100	μmhos

SWITCHING CHARACTERISTICS

Delay Time	(V _{CC} = -30 V _{dc} , V _{EB} = -2.0 V _{dc} , I _C = -150 mA _{dc} , I _{B1} = -15 mA _{dc})	t _d	—	15	ns
Rise Time		t _r	—	20	
Storage Time	(V _{CC} = -30 V _{dc} , I _C = -150 mA _{dc} , I _{B1} = I _{B2} = -15 mA _{dc})	t _s	—	225	ns
Fall Time		t _f	—	30	

3. Pulse Test: Pulse Width ≤ 300 μs, Duty Cycle ≤ 2.0%.

SWITCHING TIME EQUIVALENT TEST CIRCUIT

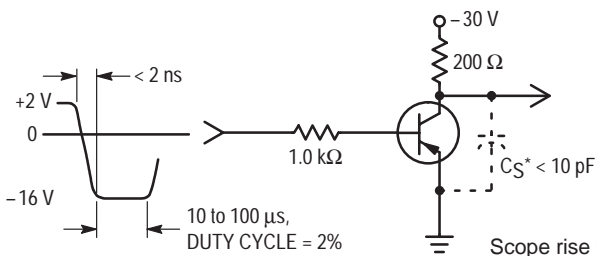


Figure 1. Turn–On Time

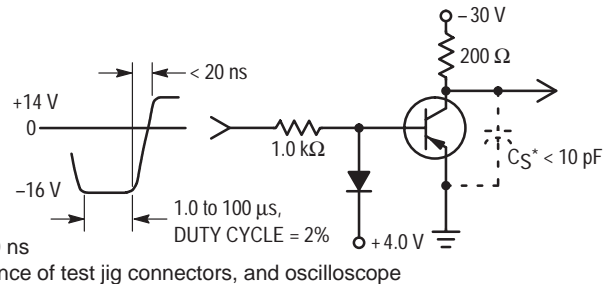


Figure 2. Turn–Off Time

TRANSIENT CHARACTERISTICS

— 25°C - - - 100°C

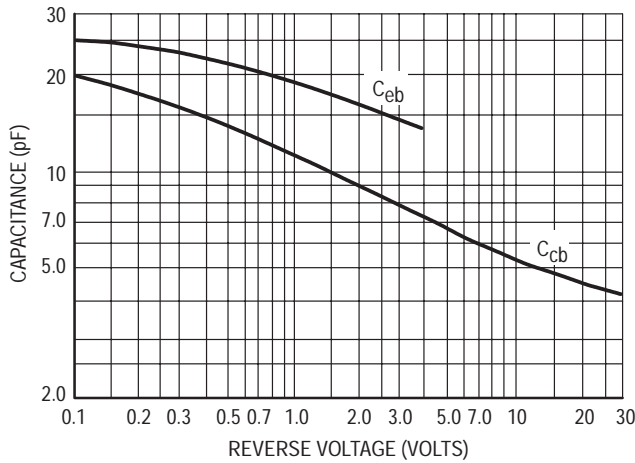


Figure 3. Capacitances

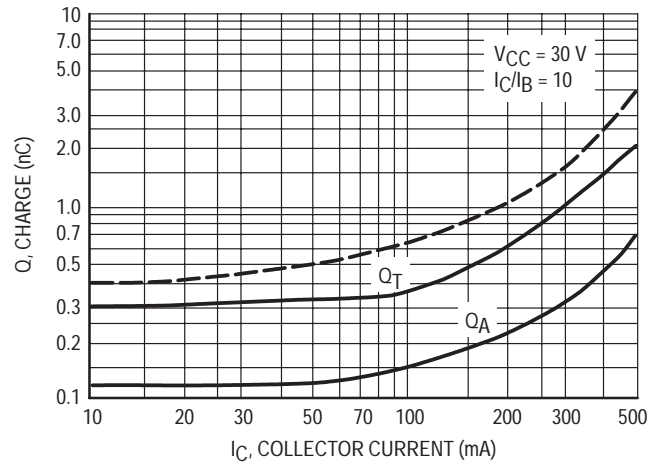


Figure 4. Charge Data

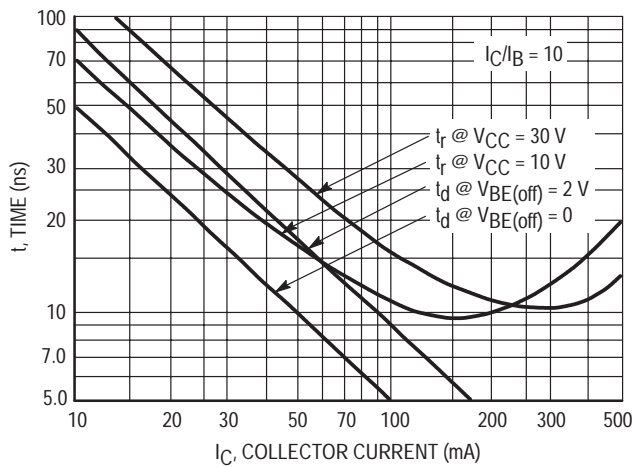


Figure 5. Turn-On Time

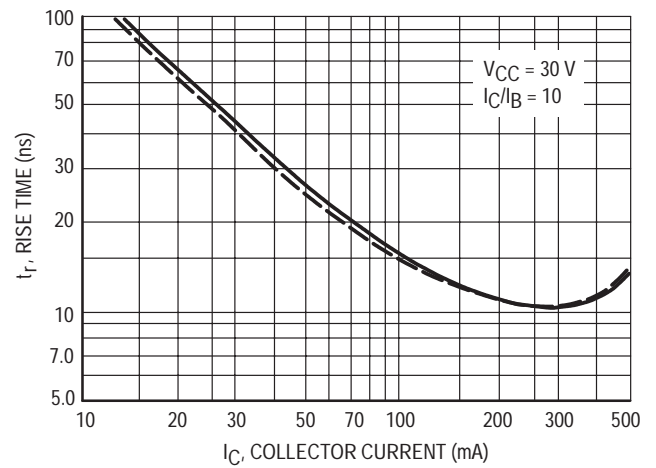


Figure 6. Rise Time

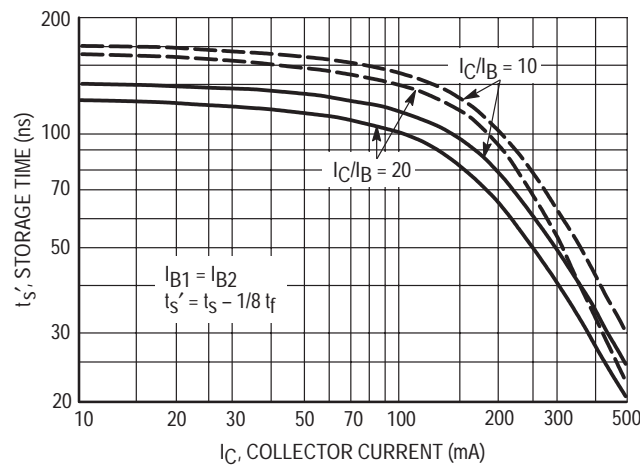


Figure 7. Storage Time

SMALL-SIGNAL CHARACTERISTICS

NOISE FIGURE

$V_{CE} = -10 \text{ Vdc}$, $T_A = 25^\circ\text{C}$

Bandwidth = 1.0 Hz

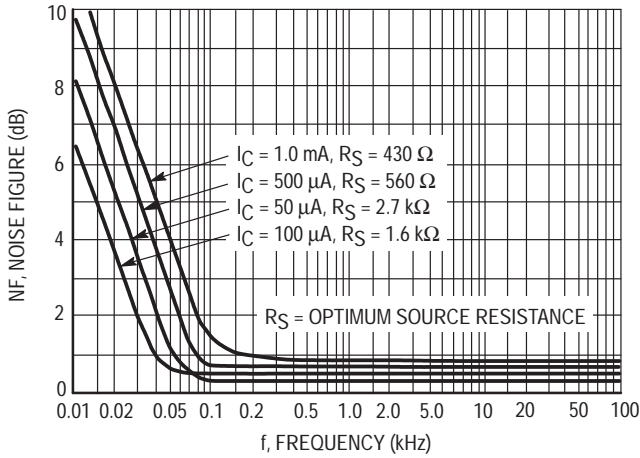


Figure 8. Frequency Effects

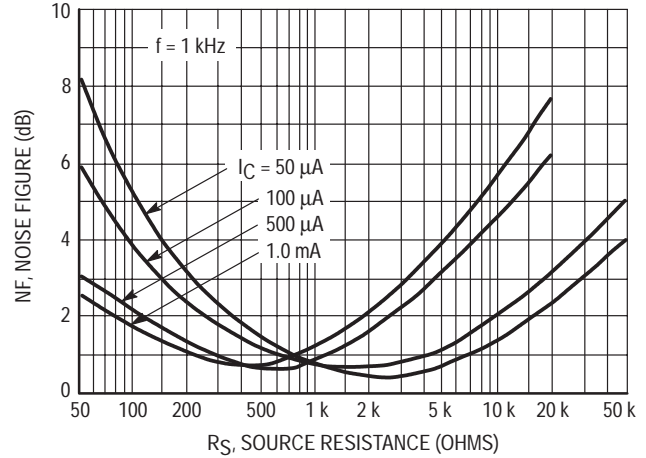


Figure 9. Source Resistance Effects

h PARAMETERS

$V_{CE} = -10 \text{ Vdc}$, $f = 1.0 \text{ kHz}$, $T_A = 25^\circ\text{C}$

This group of graphs illustrates the relationship between h_{fe} and other "h" parameters for this series of transistors. To obtain these curves, a high-gain and a low-gain unit were

selected from the MMBT4403LT1 lines, and the same units were used to develop the correspondingly-numbered curves on each graph.

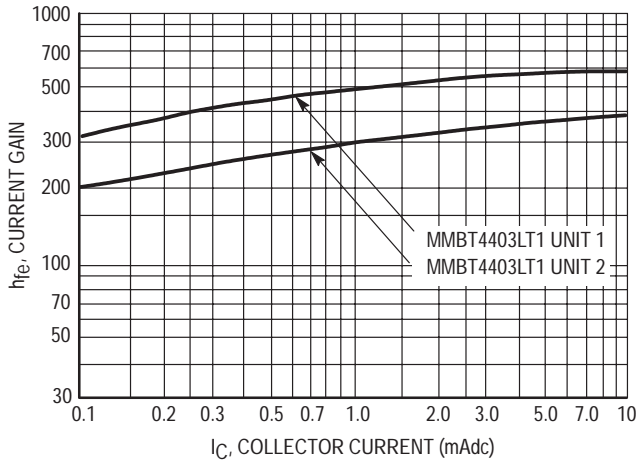


Figure 10. Current Gain

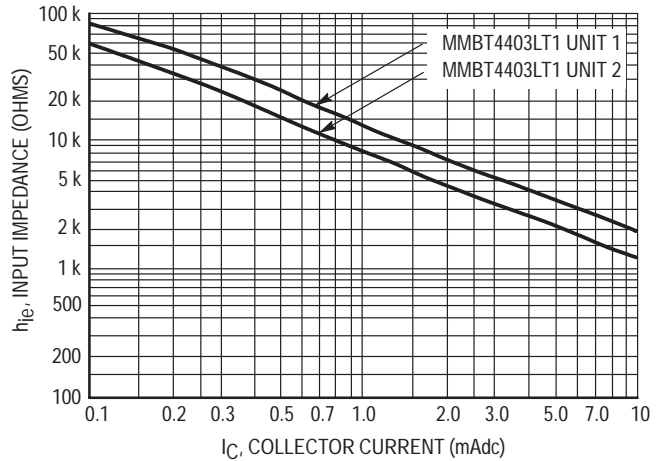


Figure 11. Input Impedance

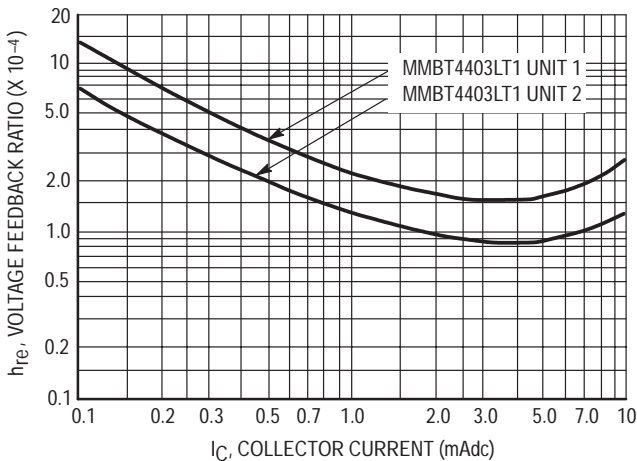


Figure 12. Voltage Feedback Ratio

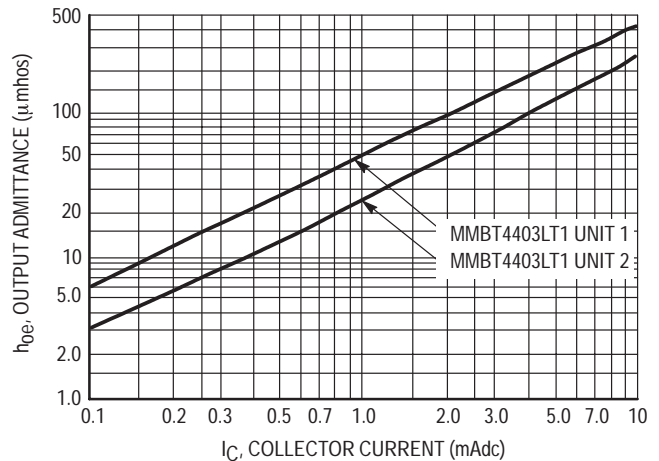


Figure 13. Output Admittance

STATIC CHARACTERISTICS

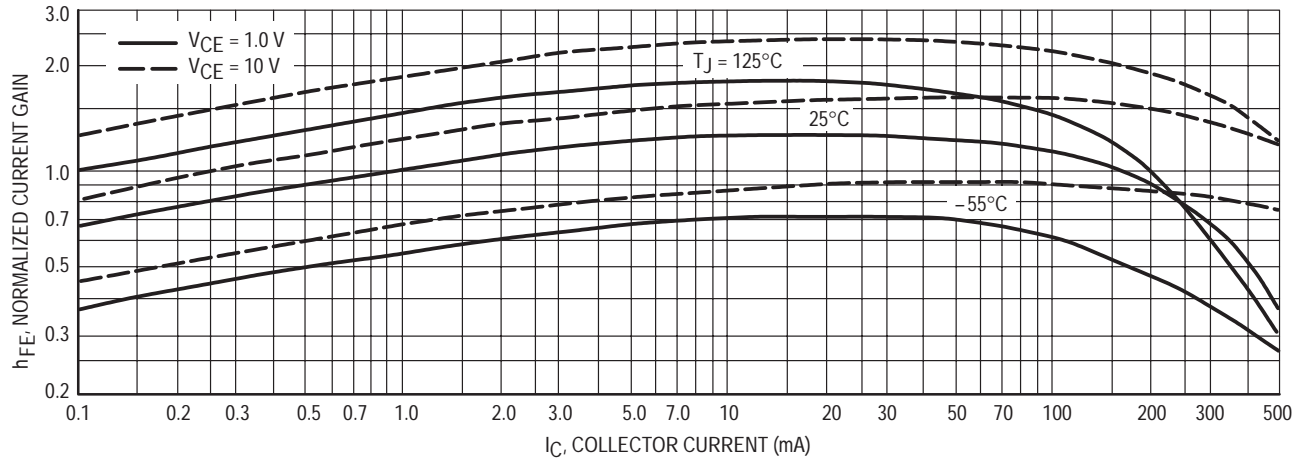


Figure 14. DC Current Gain

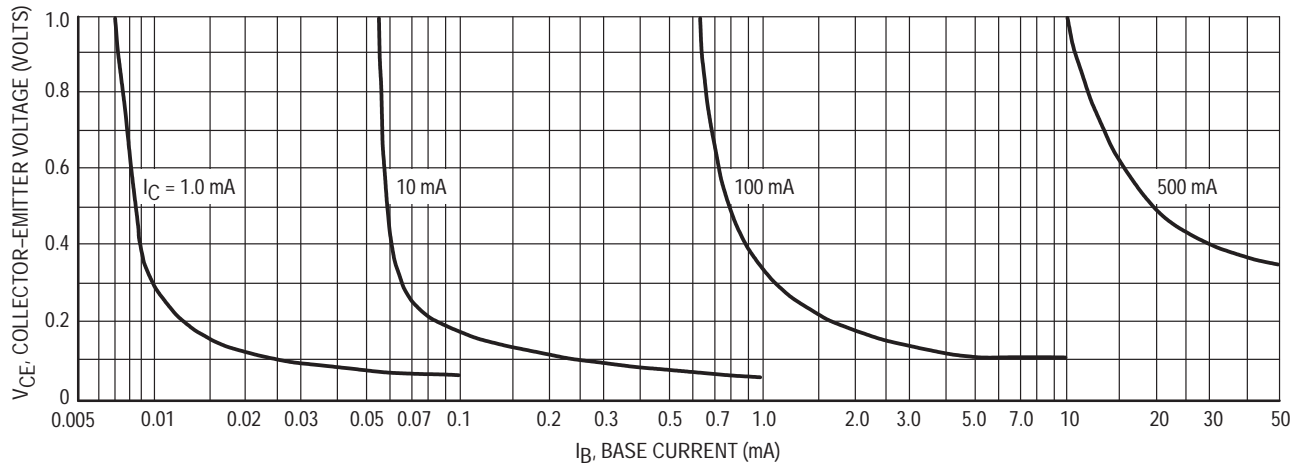


Figure 15. Collector Saturation Region

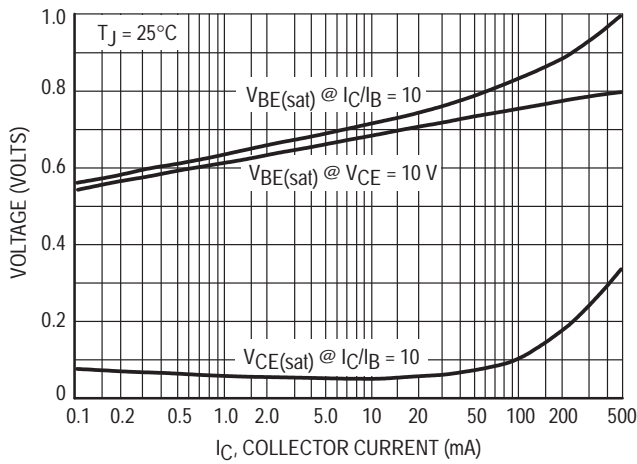


Figure 16. "On" Voltages

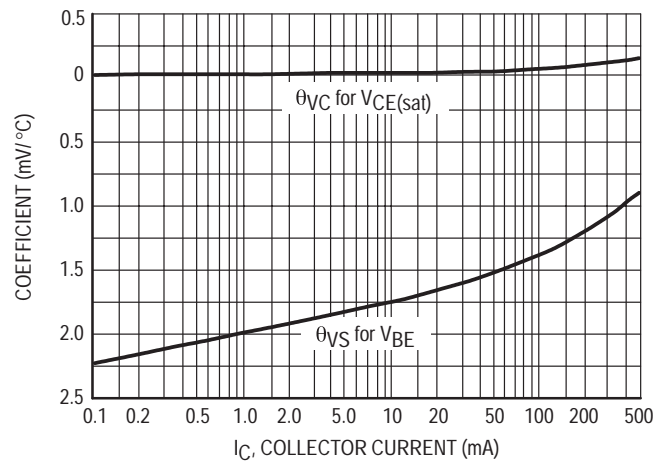


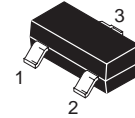
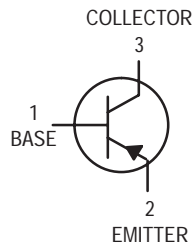
Figure 17. Temperature Coefficients

Low Noise Transistor

PNP Silicon

MMBT5087LT1

Motorola Preferred Device



CASE 318-08, STYLE 6
SOT-23 (TO-236AB)

MAXIMUM RATINGS

Rating	Symbol	Value	Unit
Collector-Emitter Voltage	V_{CEO}	-50	Vdc
Collector-Base Voltage	V_{CBO}	-50	Vdc
Emitter-Base Voltage	V_{EBO}	-3.0	Vdc
Collector Current — Continuous	I_C	-50	mAdc

DEVICE MARKING

MMBT5087LT1 = 2Q

THERMAL CHARACTERISTICS

Characteristic	Symbol	Max	Unit
Total Device Dissipation FR-5 Board (1) $T_A = 25^\circ\text{C}$ Derate above 25°C	P_D	225	mW
Thermal Resistance, Junction to Ambient	$R_{\theta JA}$	1.8	$\text{mW}/^\circ\text{C}$
Total Device Dissipation Alumina Substrate, (2) $T_A = 25^\circ\text{C}$ Derate above 25°C	P_D	300	mW
Thermal Resistance, Junction to Ambient	$R_{\theta JA}$	2.4	$\text{mW}/^\circ\text{C}$
Junction and Storage Temperature	T_J, T_{stg}	-55 to +150	$^\circ\text{C}$

ELECTRICAL CHARACTERISTICS ($T_A = 25^\circ\text{C}$ unless otherwise noted)

Characteristic	Symbol	Min	Max	Unit
----------------	--------	-----	-----	------

OFF CHARACTERISTICS

Collector-Emitter Breakdown Voltage ($I_C = -1.0 \text{ mAdc}, I_B = 0$)	$V_{(BR)CEO}$	-50	—	Vdc
Collector-Base Breakdown Voltage ($I_C = -100 \mu\text{Adc}, I_E = 0$)	$V_{(BR)CBO}$	-50	—	Vdc
Collector Cutoff Current ($V_{CB} = -10 \text{ Vdc}, I_E = 0$) ($V_{CB} = -35 \text{ Vdc}, I_E = 0$)	I_{CBO}	—	-10 -50	nAdc

1. FR-5 = 1.0 x 0.75 x 0.062 in.

2. Alumina = 0.4 x 0.3 x 0.024 in. 99.5% alumina

Preferred devices are Motorola recommended choices for future use and best overall value.

ELECTRICAL CHARACTERISTICS ($T_A = 25^\circ\text{C}$ unless otherwise noted) (Continued)

Characteristic	Symbol	Min	Max	Unit
ON CHARACTERISTICS				
DC Current Gain ($I_C = -100\ \mu\text{A}$, $V_{CE} = -5.0\ \text{V}$) ($I_C = -1.0\ \text{mA}$, $V_{CE} = -5.0\ \text{V}$) ($I_C = -10\ \text{mA}$, $V_{CE} = -5.0\ \text{V}$)	h_{FE}	250 250 250	800 — —	—
Collector–Emitter Saturation Voltage ($I_C = -10\ \text{mA}$, $I_B = -1.0\ \text{mA}$)	$V_{CE(\text{sat})}$	—	-0.3	Vdc
Base–Emitter Saturation Voltage ($I_C = -10\ \text{mA}$, $I_B = -1.0\ \text{mA}$)	$V_{BE(\text{sat})}$	—	0.85	Vdc
SMALL–SIGNAL CHARACTERISTICS				
Current–Gain — Bandwidth Product ($I_C = -500\ \mu\text{A}$, $V_{CE} = -5.0\ \text{V}$, $f = 20\ \text{MHz}$)	f_T	40	—	MHz
Output Capacitance ($V_{CB} = -5.0\ \text{V}$, $I_E = 0$, $f = 1.0\ \text{MHz}$)	C_{obo}	—	4.0	pF
Small–Signal Current Gain ($I_C = -1.0\ \text{mA}$, $V_{CE} = -5.0\ \text{V}$, $f = 1.0\ \text{kHz}$)	h_{fe}	250	900	—
Noise Figure ($I_C = -20\ \text{mA}$, $V_{CE} = -5.0\ \text{V}$, $R_S = 10\ \text{k}\Omega$, $f = 1.0\ \text{kHz}$) ($I_C = -100\ \mu\text{A}$, $V_{CE} = -5.0\ \text{V}$, $R_S = 3.0\ \text{k}\Omega$, $f = 1.0\ \text{kHz}$)	NF	— —	2.0 2.0	dB

TYPICAL NOISE CHARACTERISTICS

($V_{CE} = -5.0$ Vdc, $T_A = 25^\circ\text{C}$)

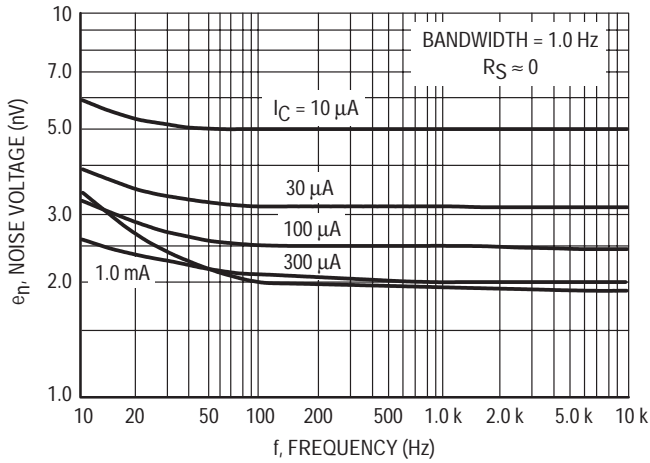


Figure 1. Noise Voltage

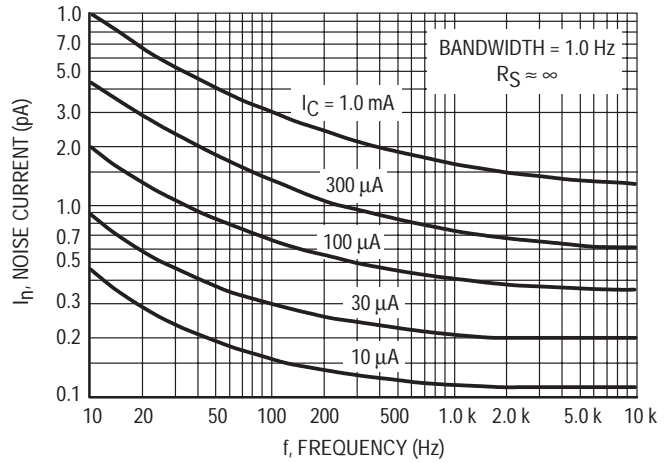


Figure 2. Noise Current

NOISE FIGURE CONTOURS

($V_{CE} = -5.0$ Vdc, $T_A = 25^\circ\text{C}$)

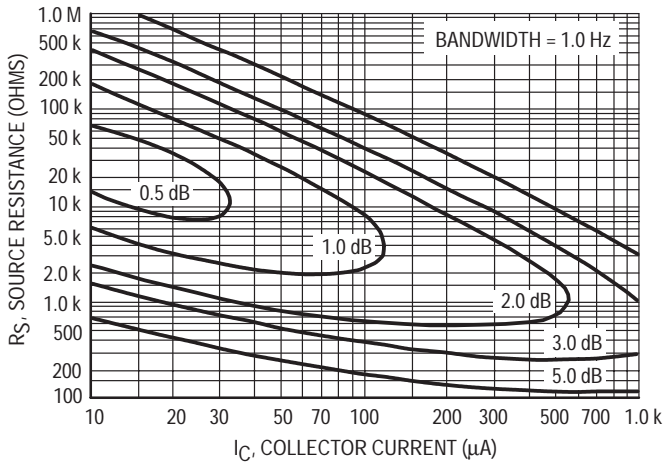


Figure 3. Narrow Band, 100 Hz

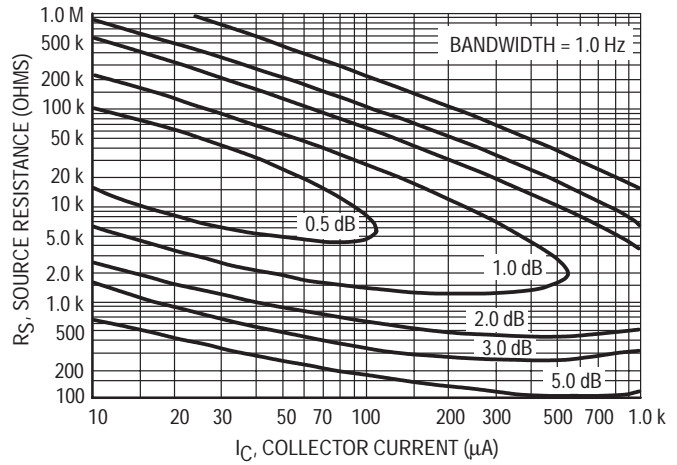


Figure 4. Narrow Band, 1.0 kHz

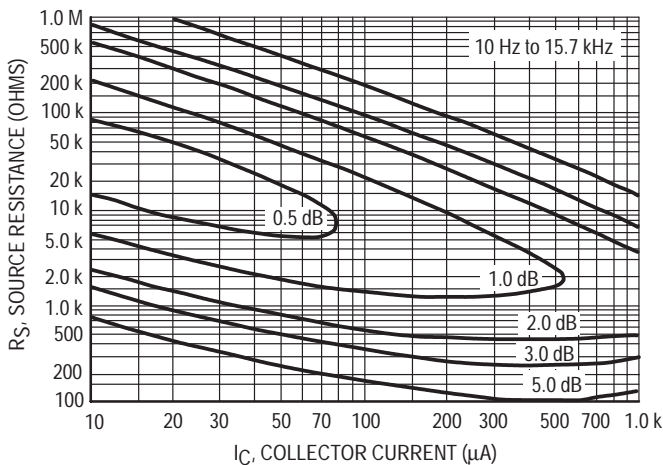


Figure 5. Wideband

Noise Figure is Defined as:

$$NF = 20 \log_{10} \left[\frac{e_n^2 + 4KTR_S + I_n^2 R_S^2}{4KTR_S} \right]^{1/2}$$

- e_n = Noise Voltage of the Transistor referred to the input. (Figure 3)
- I_n = Noise Current of the Transistor referred to the input. (Figure 4)
- K = Boltzman's Constant (1.38×10^{-23} j/ $^\circ\text{K}$)
- T = Temperature of the Source Resistance ($^\circ\text{K}$)
- R_S = Source Resistance (Ohms)

TYPICAL STATIC CHARACTERISTICS

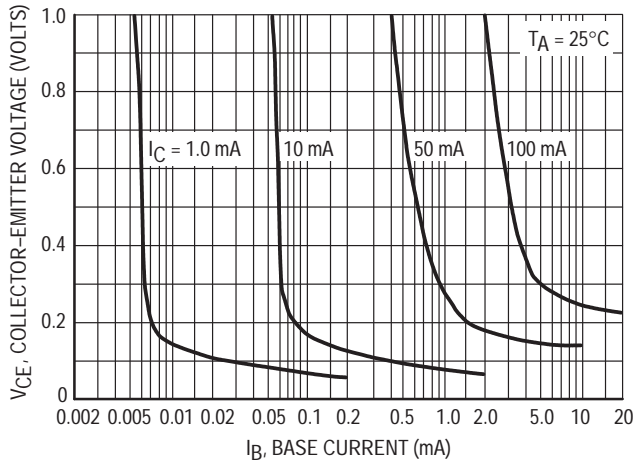


Figure 6. Collector Saturation Region

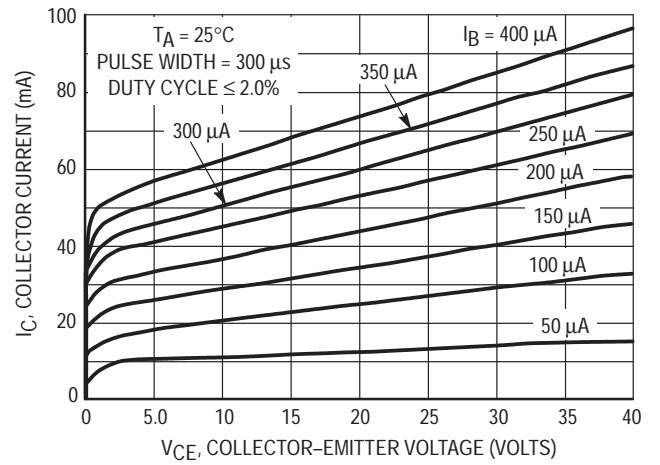


Figure 7. Collector Characteristics

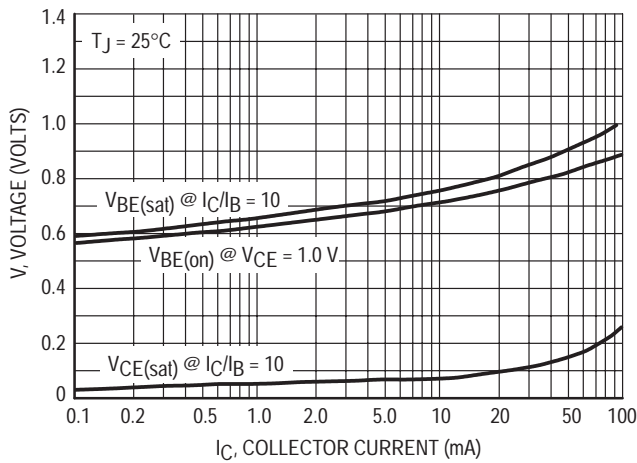


Figure 8. "On" Voltages

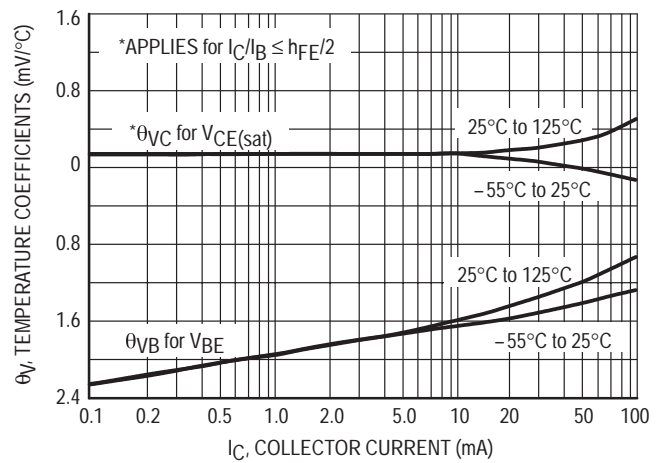


Figure 9. Temperature Coefficients

TYPICAL DYNAMIC CHARACTERISTICS

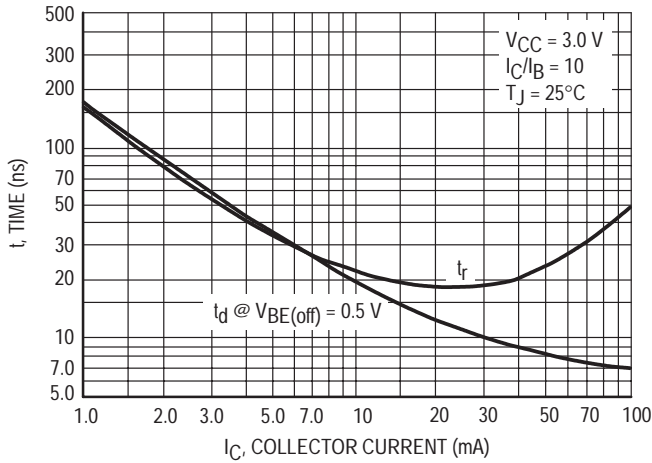


Figure 10. Turn-On Time

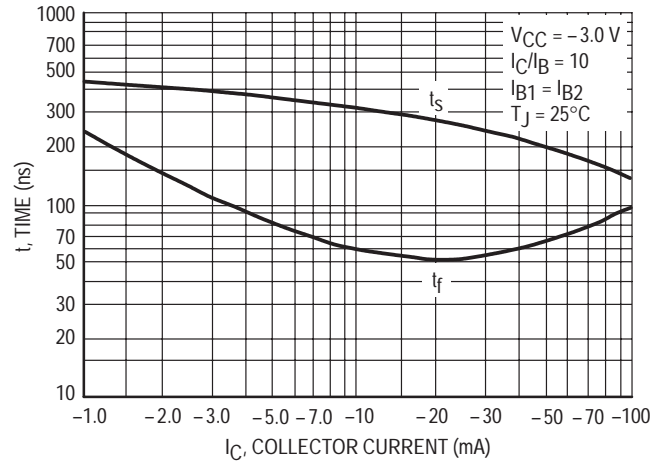


Figure 11. Turn-Off Time

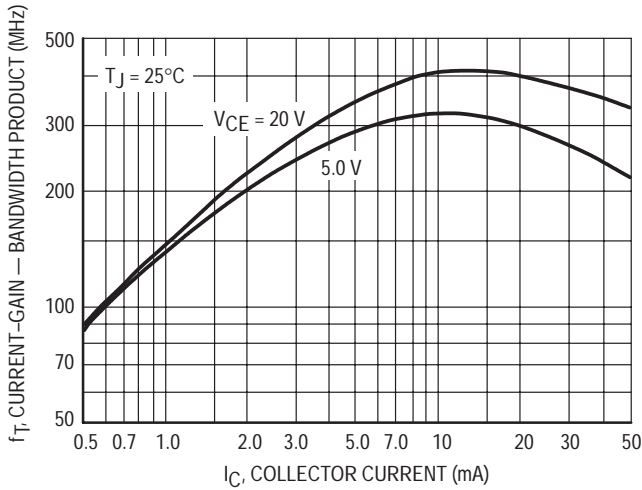


Figure 12. Current-Gain — Bandwidth Product

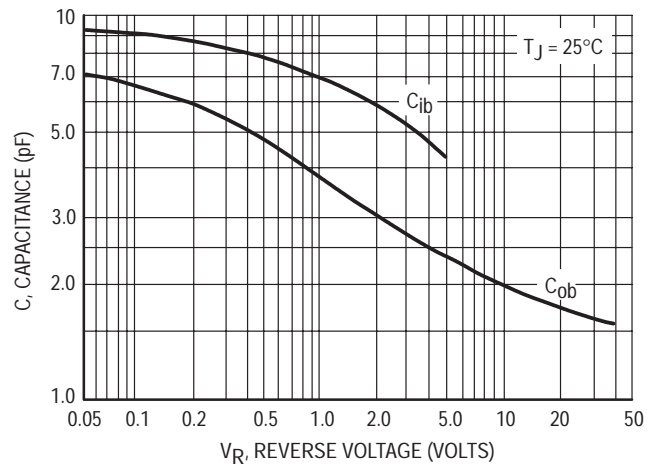


Figure 13. Capacitance

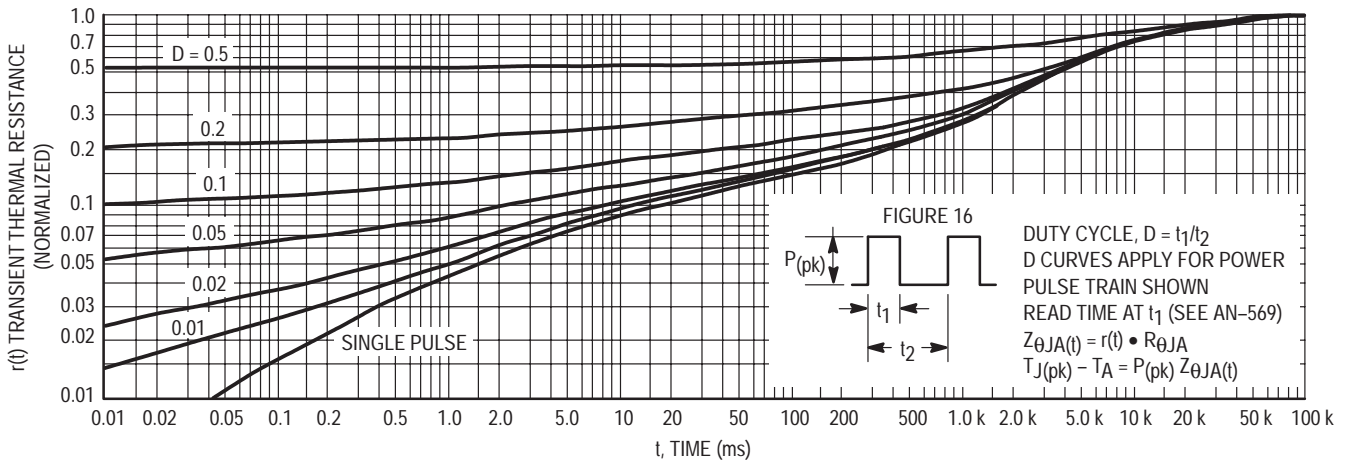


Figure 14. Thermal Response

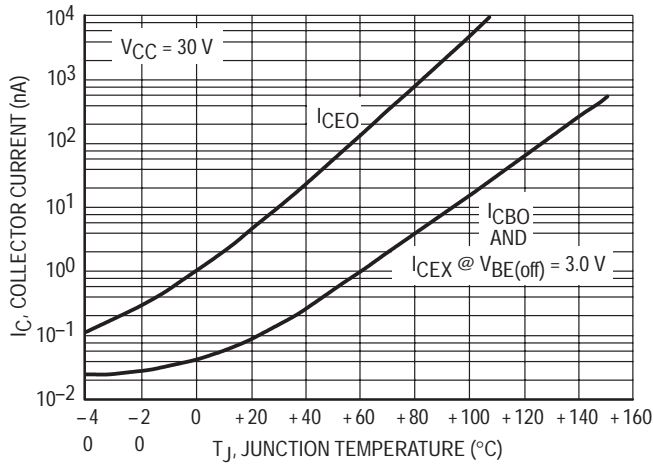


Figure 15. Typical Collector Leakage Current

DESIGN NOTE: USE OF THERMAL RESPONSE DATA

A train of periodical power pulses can be represented by the model as shown in Figure 16. Using the model and the device thermal response the normalized effective transient thermal resistance of Figure 14 was calculated for various duty cycles.

To find $Z_{\theta JA}(t)$, multiply the value obtained from Figure 14 by the steady state value $R_{\theta JA}$.

Example:

Dissipating 2.0 watts peak under the following conditions:

$$t_1 = 1.0 \text{ ms}, t_2 = 5.0 \text{ ms} (D = 0.2)$$

Using Figure 14 at a pulse width of 1.0 ms and $D = 0.2$, the reading of $r(t)$ is 0.22.

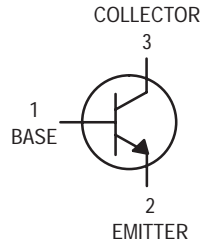
The peak rise in junction temperature is therefore

$$\Delta T = r(t) \times P(pk) \times R_{\theta JA} = 0.22 \times 2.0 \times 200 = 88^\circ\text{C}.$$

For more information, see AN-569.

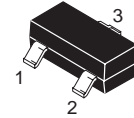
Low Noise Transistors

NPN Silicon



MMBT5088LT1
MMBT5089LT1*

*Motorola Preferred Device



CASE 318-08, STYLE 6
SOT-23 (TO-236AB)

MAXIMUM RATINGS

Rating	Symbol	5088LT1	5089LT1	Unit
Collector-Emitter Voltage	V_{CEO}	30	25	Vdc
Collector-Base Voltage	V_{CBO}	35	30	Vdc
Emitter-Base Voltage	V_{EBO}	4.5		Vdc
Collector Current — Continuous	I_C	50		mAdc

THERMAL CHARACTERISTICS

Characteristic	Symbol	Max	Unit
Total Device Dissipation FR-5 Board ⁽¹⁾ $T_A = 25^\circ\text{C}$ Derate above 25°C	P_D	225	mW
		1.8	mW/ $^\circ\text{C}$
Thermal Resistance, Junction to Ambient	$R_{\theta JA}$	556	$^\circ\text{C}/\text{W}$
Total Device Dissipation Alumina Substrate, ⁽²⁾ $T_A = 25^\circ\text{C}$ Derate above 25°C	P_D	300	mW
		2.4	mW/ $^\circ\text{C}$
Thermal Resistance, Junction to Ambient	$R_{\theta JA}$	417	$^\circ\text{C}/\text{W}$
Junction and Storage Temperature	T_J, T_{stg}	-55 to +150	$^\circ\text{C}$

DEVICE MARKING

MMBT5088LT1 = 1Q; MMBT5089LT1 = 1R

ELECTRICAL CHARACTERISTICS ($T_A = 25^\circ\text{C}$ unless otherwise noted)

Characteristic	Symbol	Min	Max	Unit
----------------	--------	-----	-----	------

OFF CHARACTERISTICS

Collector-Emitter Breakdown Voltage ($I_C = 1.0 \text{ mAdc}, I_E = 0$)	MMBT5088 MMBT5089	$V_{(BR)CEO}$	30 25	— —	Vdc
Collector-Base Breakdown Voltage ($I_C = 100 \mu\text{Adc}, I_E = 0$)	MMBT5088 MMBT5089	$V_{(BR)CBO}$	35 30	— —	Vdc
Collector Cutoff Current ($V_{CB} = 20 \text{ Vdc}, I_E = 0$) ($V_{CB} = 15 \text{ Vdc}, I_E = 0$)	MMBT5088 MMBT5089	I_{CBO}	— —	50 50	nAdc
Emitter Cutoff Current ($V_{EB(off)} = 3.0 \text{ Vdc}, I_C = 0$) ($V_{EB(off)} = 4.5 \text{ Vdc}, I_C = 0$)	MMBT5088 MMBT5089	I_{EBO}	— —	50 100	nAdc

1. FR-5 = $1.0 \times 0.75 \times 0.062 \text{ in.}$

2. Alumina = $0.4 \times 0.3 \times 0.024 \text{ in.}$ 99.5% alumina.

Preferred devices are Motorola recommended choices for future use and best overall value.

ELECTRICAL CHARACTERISTICS ($T_A = 25^\circ\text{C}$ unless otherwise noted) (Continued)

Characteristic	Symbol	Min	Max	Unit
ON CHARACTERISTICS				
DC Current Gain ($I_C = 100 \mu\text{A}$, $V_{CE} = 5.0 \text{ Vdc}$)	h_{FE}	300	900	—
	MMBT5088	400	1200	
	MMBT5089			
($I_C = 1.0 \text{ mA}$, $V_{CE} = 5.0 \text{ Vdc}$)	h_{FE}	350	—	—
	MMBT5088	450	—	—
	MMBT5089			
($I_C = 10 \text{ mA}$, $V_{CE} = 5.0 \text{ Vdc}$)	h_{FE}	300	—	—
	MMBT5088	400	—	—
	MMBT5089			
Collector–Emitter Saturation Voltage ($I_C = 10 \text{ mA}$, $I_B = 1.0 \text{ mA}$)	$V_{CE(sat)}$	—	0.5	Vdc
Base–Emitter Saturation Voltage ($I_C = 10 \text{ mA}$, $I_B = 1.0 \text{ mA}$)	$V_{BE(sat)}$	—	0.8	Vdc

SMALL–SIGNAL CHARACTERISTICS

Current–Gain — Bandwidth Product ($I_C = 500 \mu\text{A}$, $V_{CE} = 5.0 \text{ Vdc}$, $f = 20 \text{ MHz}$)	f_T	50	—	MHz
Collector–Base Capacitance ($V_{CB} = 5.0 \text{ Vdc}$, $I_E = 0$, $f = 1.0 \text{ MHz}$ emitter guarded)	C_{cb}	—	4.0	pF
Emitter–Base Capacitance ($V_{EB} = 0.5 \text{ Vdc}$, $I_C = 0$, $f = 1.0 \text{ MHz}$ collector guarded)	C_{eb}	—	10	pF
Small Signal Current Gain ($I_C = 1.0 \text{ mA}$, $V_{CE} = 5.0 \text{ Vdc}$, $f = 1.0 \text{ kHz}$)	h_{fe}	350	1400	—
	MMBT5088	450	1800	
	MMBT5089			
Noise Figure ($I_C = 100 \mu\text{A}$, $V_{CE} = 5.0 \text{ Vdc}$, $R_S = 10 \text{ k}\Omega$, $f = 1.0 \text{ kHz}$)	NF	—	3.0	dB
	MMBT5088	—	2.0	
	MMBT5089			

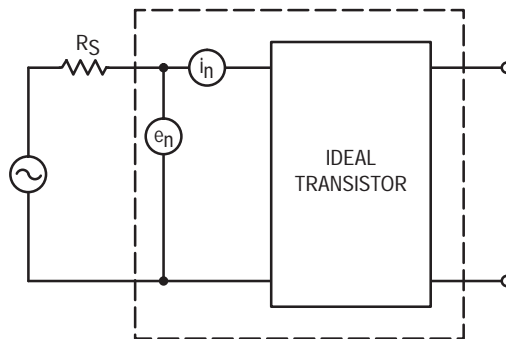


Figure 1. Transistor Noise Model

NOISE CHARACTERISTICS

($V_{CE} = 5.0 \text{ Vdc}$, $T_A = 25^\circ\text{C}$)

NOISE VOLTAGE

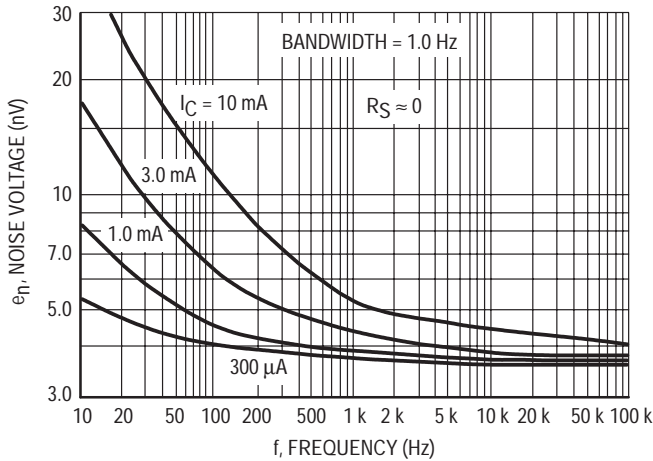


Figure 2. Effects of Frequency

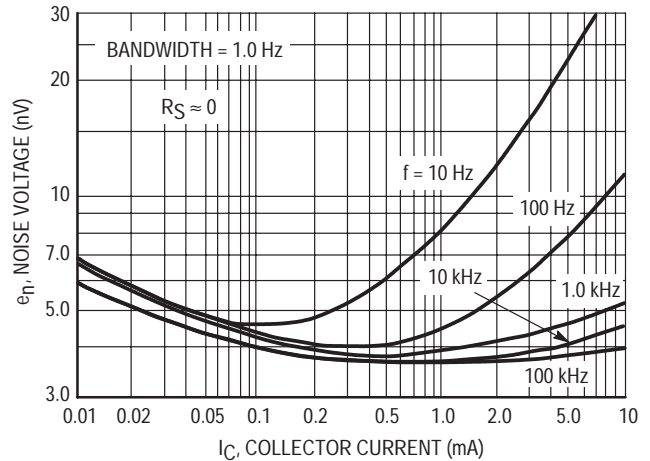


Figure 3. Effects of Collector Current

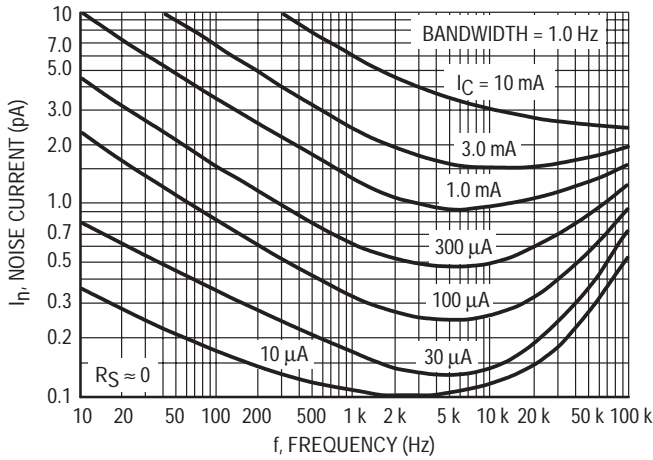


Figure 4. Noise Current

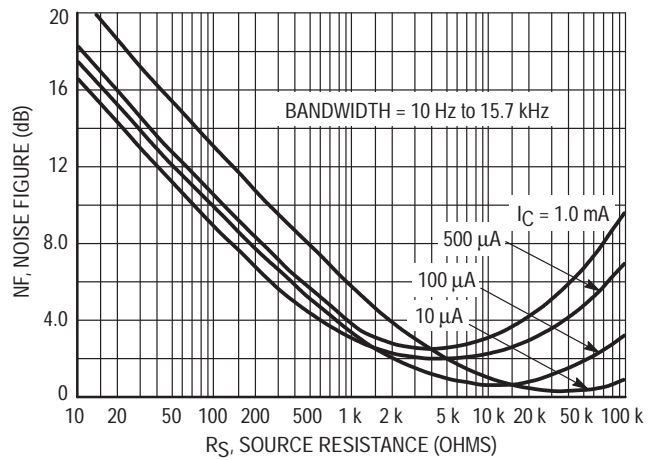


Figure 5. Wideband Noise Figure

100 Hz NOISE DATA

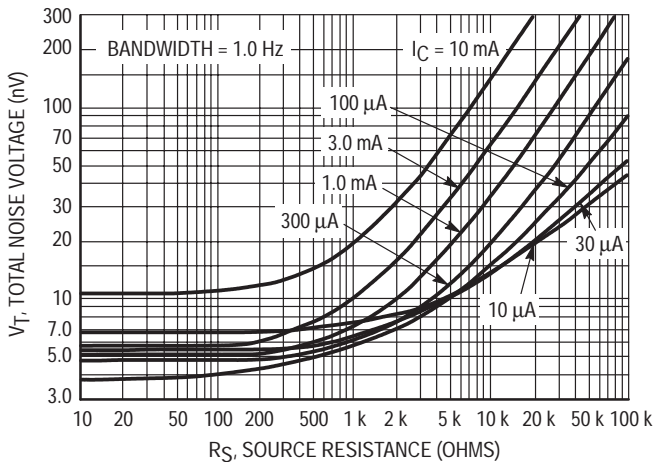


Figure 6. Total Noise Voltage

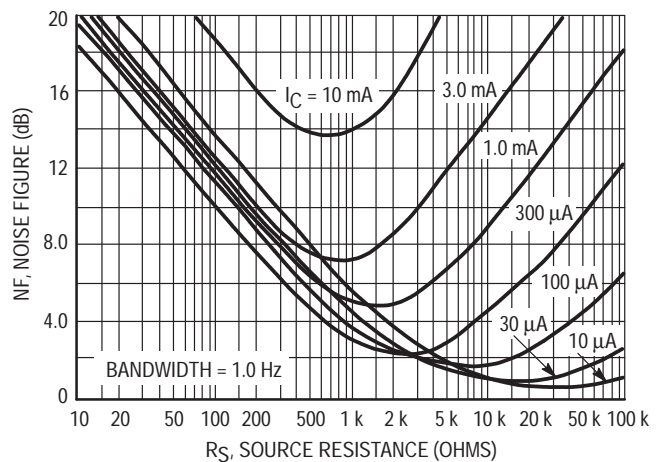


Figure 7. Noise Figure

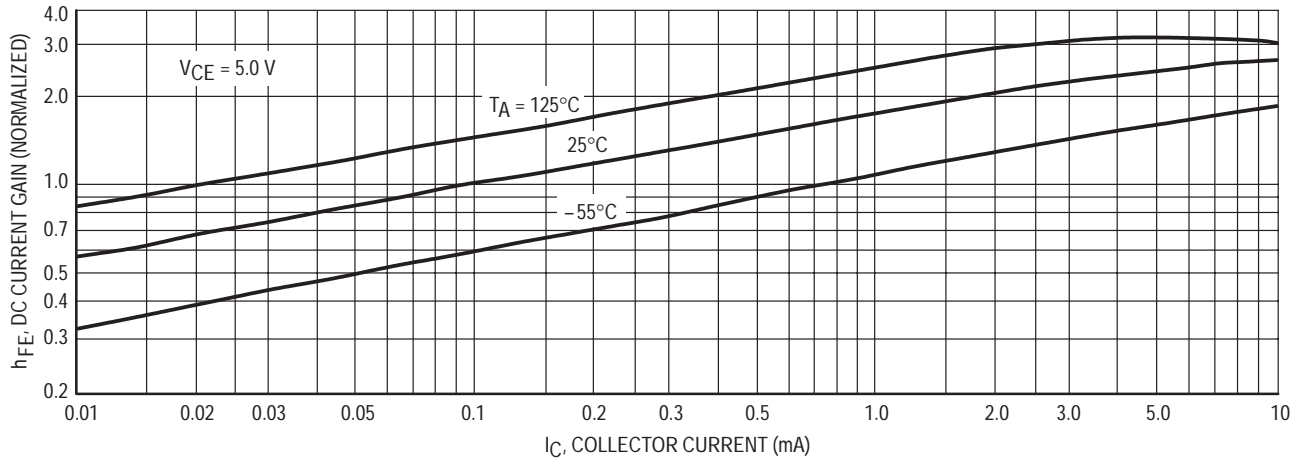


Figure 8. DC Current Gain

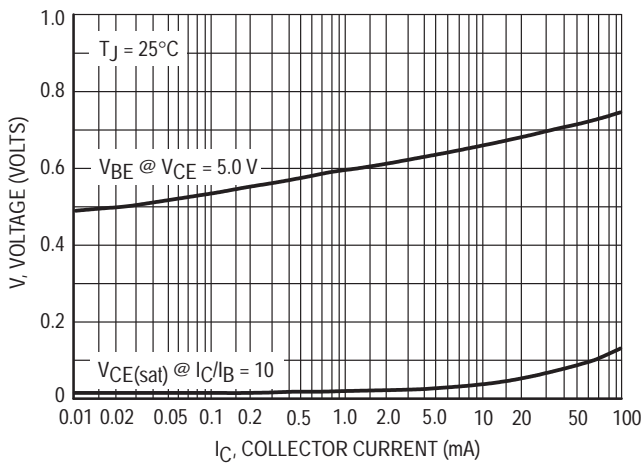


Figure 9. "On" Voltages

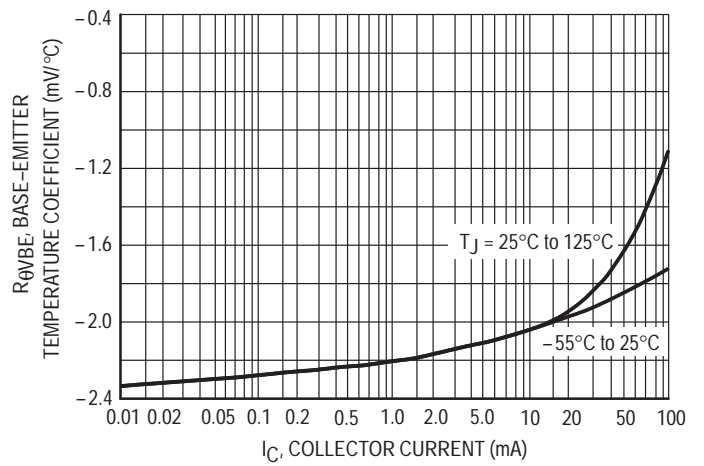


Figure 10. Temperature Coefficients

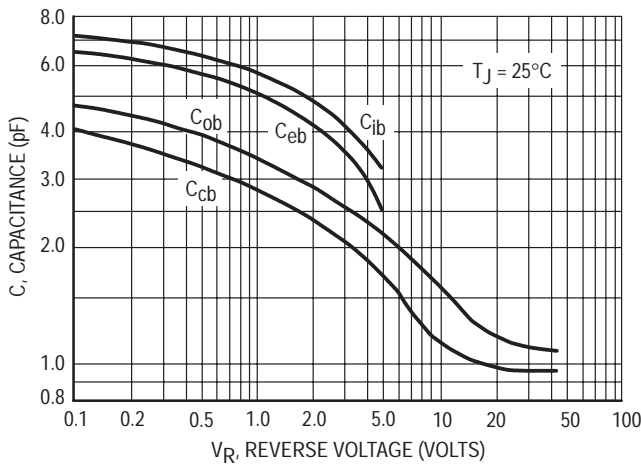


Figure 11. Capacitance

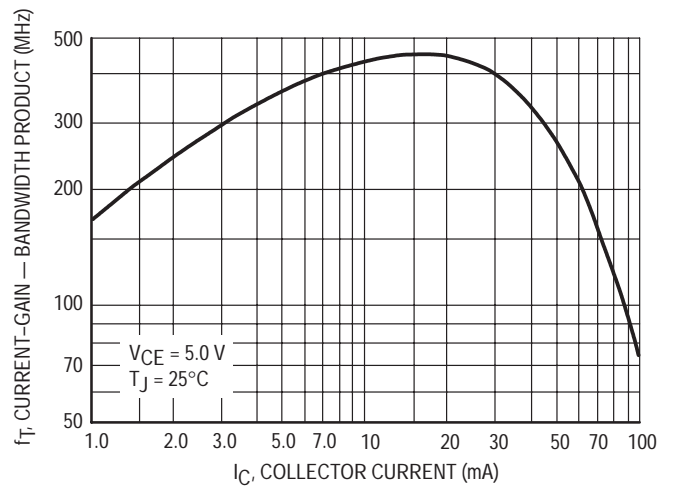
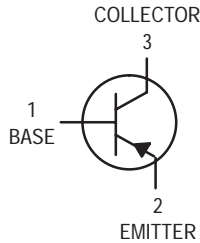


Figure 12. Current-Gain — Bandwidth Product

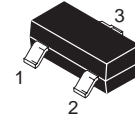
High Voltage Transistor

PNP Silicon



MMBT5401LT1

Motorola Preferred Device



CASE 318-08, STYLE 6
SOT-23 (TO-236AB)

MAXIMUM RATINGS

Rating	Symbol	Value	Unit
Collector-Emitter Voltage	V_{CEO}	-150	Vdc
Collector-Base Voltage	V_{CBO}	-160	Vdc
Emitter-Base Voltage	V_{EBO}	-5.0	Vdc
Collector Current — Continuous	I_C	-500	mAdc

THERMAL CHARACTERISTICS

Characteristic	Symbol	Max	Unit
Total Device Dissipation FR-5 Board ⁽¹⁾ $T_A = 25^\circ\text{C}$ Derate above 25°C	P_D	225 1.8	mW mW/ $^\circ\text{C}$
Thermal Resistance, Junction to Ambient	$R_{\theta JA}$	556	$^\circ\text{C}/\text{W}$
Total Device Dissipation Alumina Substrate, ⁽²⁾ $T_A = 25^\circ\text{C}$ Derate above 25°C	P_D	300 2.4	mW mW/ $^\circ\text{C}$
Thermal Resistance, Junction to Ambient	$R_{\theta JA}$	417	$^\circ\text{C}/\text{W}$
Junction and Storage Temperature	T_J, T_{stg}	-55 to +150	$^\circ\text{C}$

DEVICE MARKING

MMBT5401LT1 = 2L

ELECTRICAL CHARACTERISTICS ($T_A = 25^\circ\text{C}$ unless otherwise noted)

Characteristic	Symbol	Min	Max	Unit
----------------	--------	-----	-----	------

OFF CHARACTERISTICS

Collector-Emitter Breakdown Voltage ($I_C = -1.0 \text{ mAdc}, I_B = 0$)	$V_{(BR)CEO}$	-150	—	Vdc
Collector-Base Breakdown Voltage ($I_C = -100 \mu\text{Adc}, I_E = 0$)	$V_{(BR)CBO}$	-160	—	Vdc
Emitter-Base Breakdown Voltage ($I_E = -10 \mu\text{Adc}, I_C = 0$)	$V_{(BR)EBO}$	-5.0	—	Vdc
Collector Cutoff Current ($V_{CB} = -120 \text{ Vdc}, I_E = 0$) ($V_{CB} = -120 \text{ Vdc}, I_E = 0, T_A = 100^\circ\text{C}$)	I_{CES}	— —	-50 -50	nAdc μAdc

1. FR-5 = $1.0 \times 0.75 \times 0.062 \text{ in.}$

2. Alumina = $0.4 \times 0.3 \times 0.024 \text{ in. 99.5\% alumina.}$

Preferred devices are Motorola recommended choices for future use and best overall value.

ELECTRICAL CHARACTERISTICS ($T_A = 25^\circ\text{C}$ unless otherwise noted) (Continued)

Characteristic	Symbol	Min	Max	Unit
ON CHARACTERISTICS				
DC Current Gain ($I_C = -1.0\text{ mAdc}$, $V_{CE} = -5.0\text{ Vdc}$) ($I_C = -10\text{ mAdc}$, $V_{CE} = -5.0\text{ Vdc}$) ($I_C = -50\text{ mAdc}$, $V_{CE} = -5.0\text{ Vdc}$)	h_{FE}	50 60 50	— 240 —	—
Collector–Emitter Saturation Voltage ($I_C = -10\text{ mAdc}$, $I_B = -1.0\text{ mAdc}$) ($I_C = -50\text{ mAdc}$, $I_B = -5.0\text{ mAdc}$)	$V_{CE(sat)}$	— —	—0.2 —0.5	Vdc
Base–Emitter Saturation Voltage ($I_C = -10\text{ mAdc}$, $I_B = -1.0\text{ mAdc}$) ($I_C = -50\text{ mAdc}$, $I_B = -5.0\text{ mAdc}$)	$V_{BE(sat)}$	— —	—1.0 —1.0	Vdc
SMALL–SIGNAL CHARACTERISTICS				
Current–Gain — Bandwidth Product ($I_C = -10\text{ mAdc}$, $V_{CE} = -10\text{ Vdc}$, $f = 100\text{ MHz}$)	f_T	100	300	MHz
Output Capacitance ($V_{CB} = -10\text{ Vdc}$, $I_E = 0$, $f = 1.0\text{ MHz}$)	C_{obo}	—	6.0	pF
Small Signal Current Gain ($I_C = -1.0\text{ mAdc}$, $V_{CE} = -10\text{ Vdc}$, $f = 1.0\text{ kHz}$)	h_{fe}	40	200	—
Noise Figure ($I_C = -200\text{ }\mu\text{A}$, $V_{CE} = -5.0\text{ Vdc}$, $R_S = 10\text{ }\Omega$, $f = 1.0\text{ kHz}$)	NF	—	8.0	dB

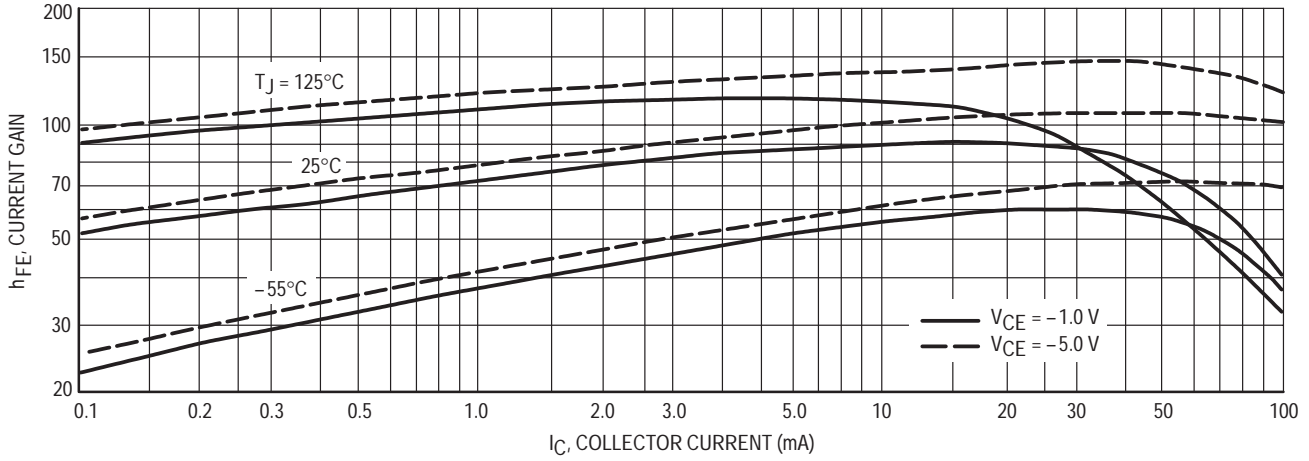


Figure 1. DC Current Gain

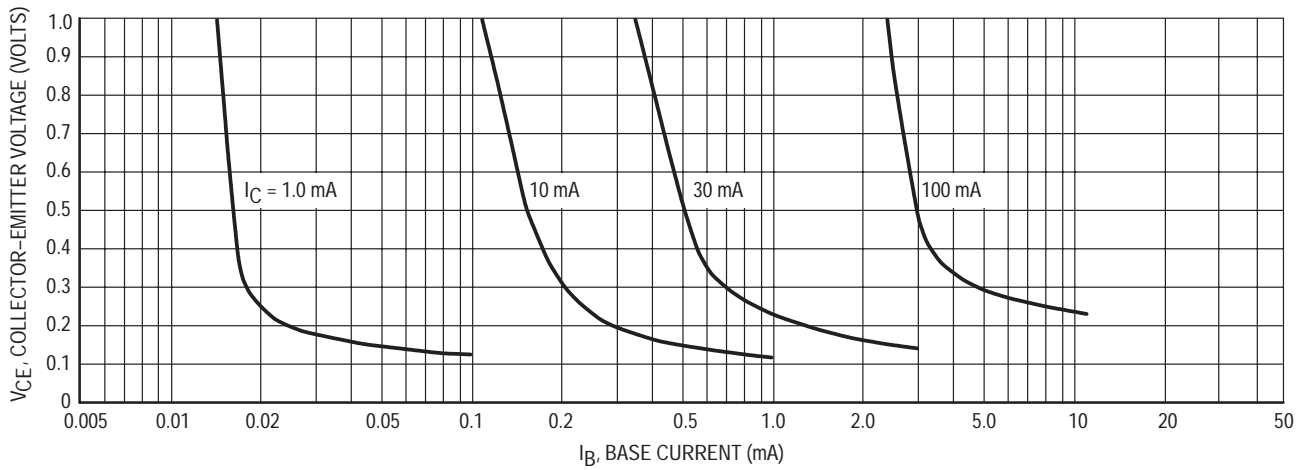


Figure 2. Collector Saturation Region

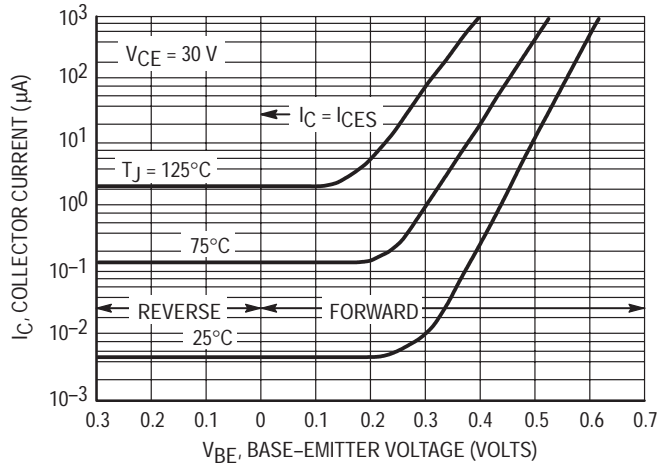


Figure 3. Collector Cut-Off Region

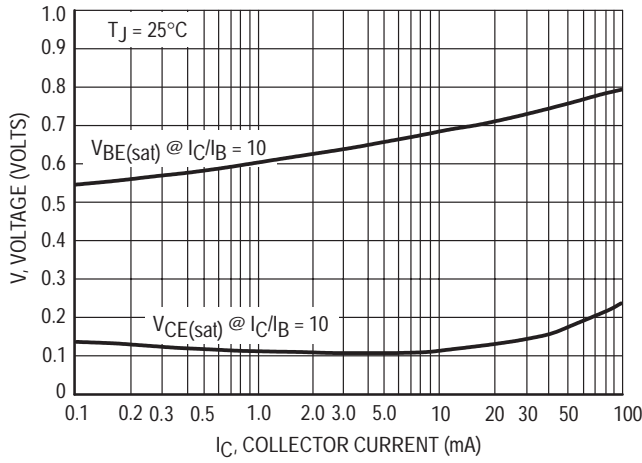


Figure 4. "On" Voltages

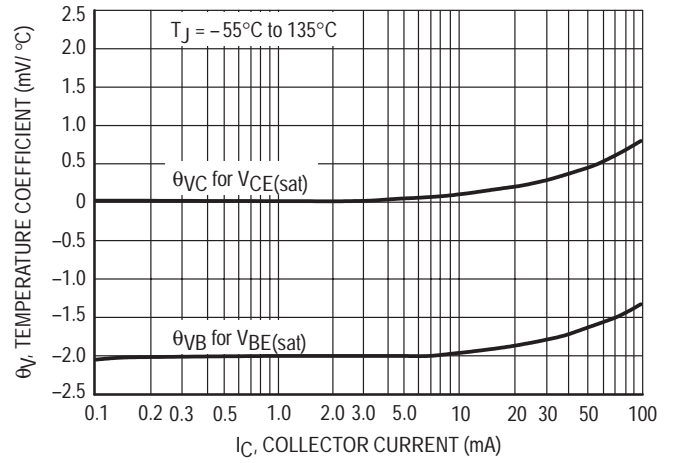


Figure 5. Temperature Coefficients

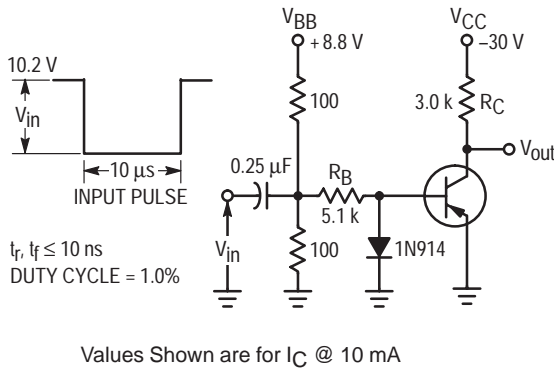


Figure 6. Switching Time Test Circuit

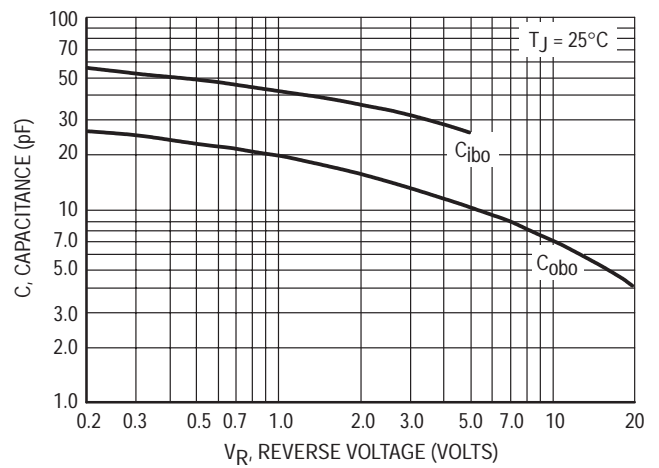


Figure 7. Capacitances

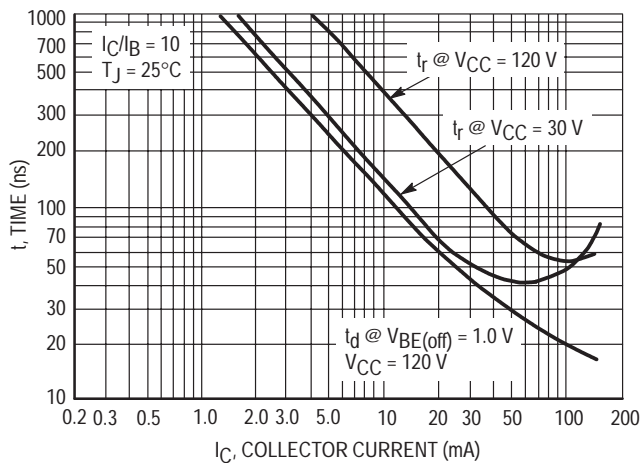


Figure 8. Turn-On Time

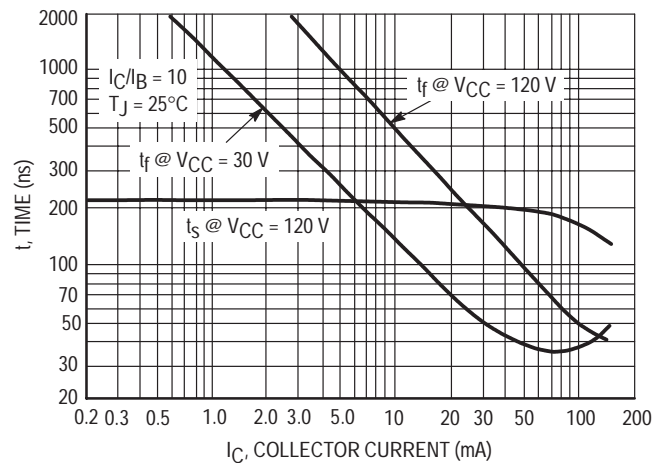
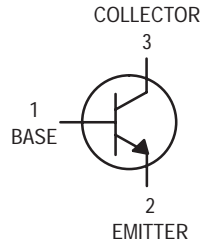


Figure 9. Turn-Off Time

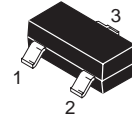
High Voltage Transistors

NPN Silicon



MMBT5550LT1
MMBT5551LT1*

*Motorola Preferred Device



CASE 318-08, STYLE 6
SOT-23 (TO-236AB)

MAXIMUM RATINGS

Rating	Symbol	Value	Unit
Collector-Emitter Voltage	V_{CEO}	140	Vdc
Collector-Base Voltage	V_{CBO}	160	Vdc
Emitter-Base Voltage	V_{EBO}	6.0	Vdc
Collector Current — Continuous	I_C	600	mAdc

THERMAL CHARACTERISTICS

Characteristic	Symbol	Max	Unit
Total Device Dissipation FR-5 Board ⁽¹⁾ $T_A = 25^\circ\text{C}$ Derate above 25°C	P_D	225	mW
		1.8	mW/ $^\circ\text{C}$
Thermal Resistance, Junction to Ambient	$R_{\theta JA}$	556	$^\circ\text{C}/\text{W}$
Total Device Dissipation Alumina Substrate, ⁽²⁾ $T_A = 25^\circ\text{C}$ Derate above 25°C	P_D	300	mW
		2.4	mW/ $^\circ\text{C}$
Thermal Resistance, Junction to Ambient	$R_{\theta JA}$	417	$^\circ\text{C}/\text{W}$
Junction and Storage Temperature	T_J, T_{stg}	-55 to +150	$^\circ\text{C}$

DEVICE MARKING

MMBT5550LT1 = M1F; MMBT5551LT1 = G1

ELECTRICAL CHARACTERISTICS ($T_A = 25^\circ\text{C}$ unless otherwise noted)

Characteristic	Symbol	Min	Max	Unit
----------------	--------	-----	-----	------

OFF CHARACTERISTICS

Collector-Emitter Breakdown Voltage ⁽³⁾ ($I_C = 1.0 \text{ mAdc}, I_E = 0$)	MMBT5550 MMBT5551	$V_{(BR)CEO}$	140 160	— —	Vdc
Collector-Base Breakdown Voltage ($I_C = 100 \mu\text{Adc}, I_E = 0$)	MMBT5550 MMBT5551	$V_{(BR)CBO}$	160 180	— —	Vdc
Emitter-Base Breakdown Voltage ($I_E = 10 \mu\text{Adc}, I_C = 0$)		$V_{(BR)EBO}$	6.0	—	Vdc
Collector Cutoff Current ($V_{CB} = 100 \text{ Vdc}, I_E = 0$) ($V_{CB} = 120 \text{ Vdc}, I_E = 0$) ($V_{CB} = 100 \text{ Vdc}, I_E = 0, T_A = 100^\circ\text{C}$) ($V_{CB} = 120 \text{ Vdc}, I_E = 0, T_A = 100^\circ\text{C}$)	MMBT5550 MMBT5551 MMBT5550 MMBT5551	I_{CBO}	— — — —	100 50 100 50	nAdc μAdc
Emitter Cutoff Current ($V_{EB} = 4.0 \text{ Vdc}, I_C = 0$)		I_{EBO}	—	50	nAdc

1. FR-5 = $1.0 \times 0.75 \times 0.062 \text{ in.}$

2. Alumina = $0.4 \times 0.3 \times 0.024 \text{ in.}$ 99.5% alumina.

3. Pulse Test: Pulse Width = $300 \mu\text{s}$, Duty Cycle = 2.0%.

Preferred devices are Motorola recommended choices for future use and best overall value.

ELECTRICAL CHARACTERISTICS ($T_A = 25^\circ\text{C}$ unless otherwise noted) (Continued)

Characteristic		Symbol	Min	Max	Unit
ON CHARACTERISTICS					
DC Current Gain ($I_C = 1.0\text{ mAdc}$, $V_{CE} = 5.0\text{ Vdc}$)	MMBT5550	h_{FE}	60	—	—
	MMBT5551		80	—	
($I_C = 10\text{ mAdc}$, $V_{CE} = 5.0\text{ Vdc}$)	MMBT5550	60	250		
	MMBT5551	80	250		
($I_C = 50\text{ mAdc}$, $V_{CE} = 5.0\text{ Vdc}$)	MMBT5550	20	—		
	MMBT5551	30	—		
Collector–Emitter Saturation Voltage ($I_C = 10\text{ mAdc}$, $I_B = 1.0\text{ mAdc}$)	Both Types	$V_{CE(sat)}$	—	0.15	Vdc
	MMBT5550		—	0.25	
($I_C = 50\text{ mAdc}$, $I_B = 5.0\text{ mAdc}$)	MMBT5551	—	0.20		
Base–Emitter Saturation Voltage ($I_C = 10\text{ mAdc}$, $I_B = 1.0\text{ mAdc}$)	Both Types	$V_{BE(sat)}$	—	1.0	Vdc
	MMBT5550		—	1.2	
($I_C = 50\text{ mAdc}$, $I_B = 5.0\text{ mAdc}$)	MMBT5551	—	1.0		

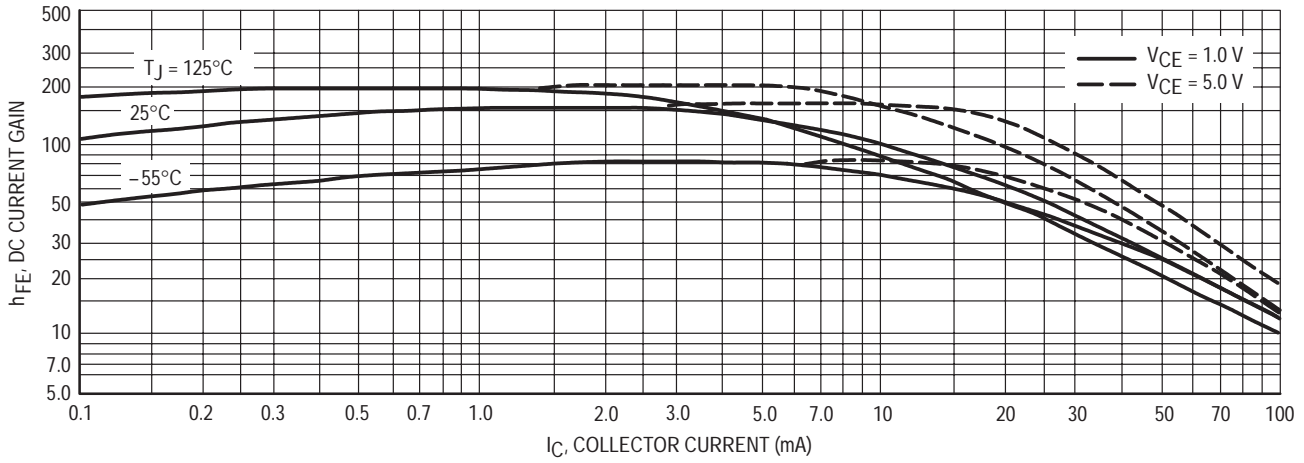


Figure 1. DC Current Gain

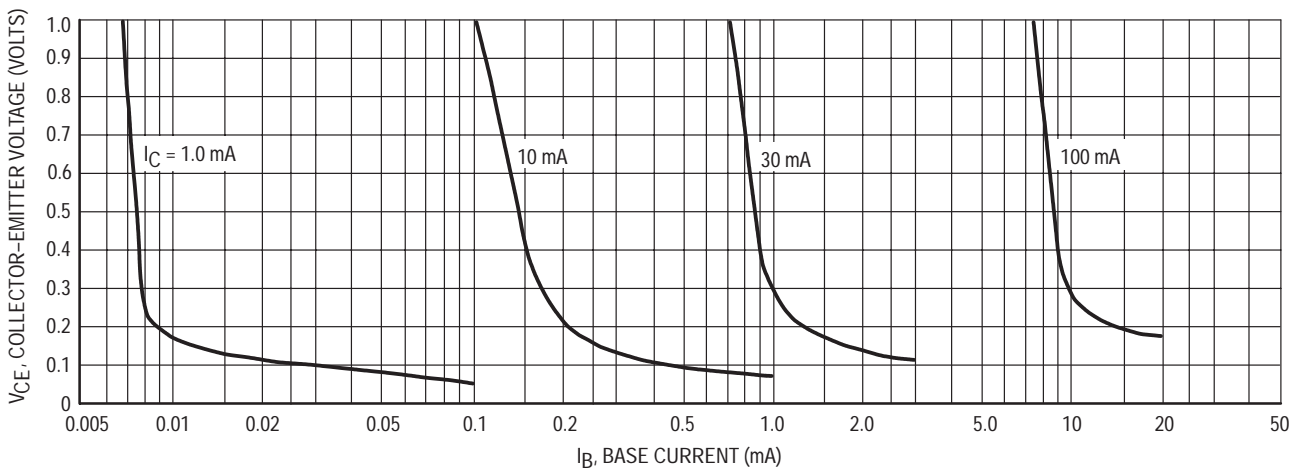


Figure 2. Collector Saturation Region

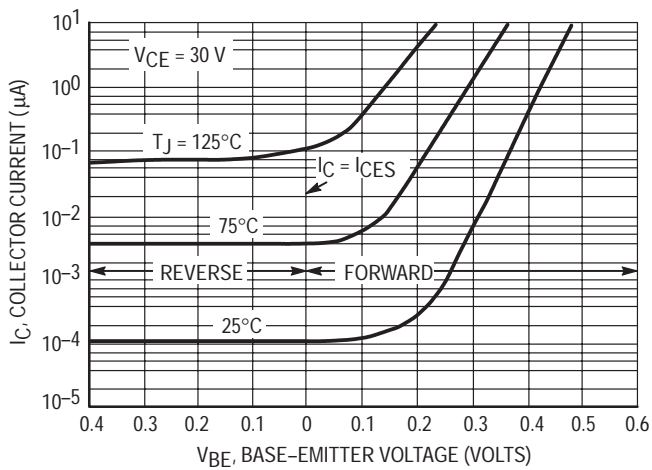


Figure 3. Collector Cut-Off Region

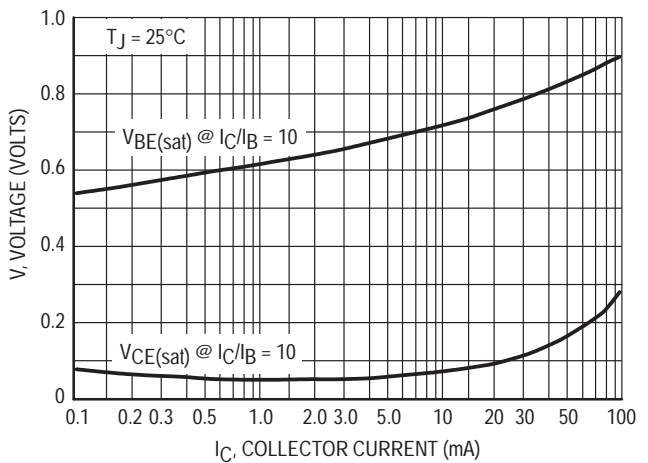


Figure 4. "On" Voltages

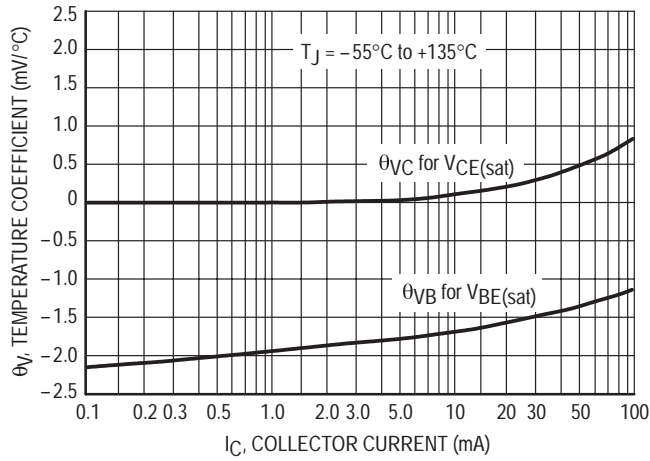
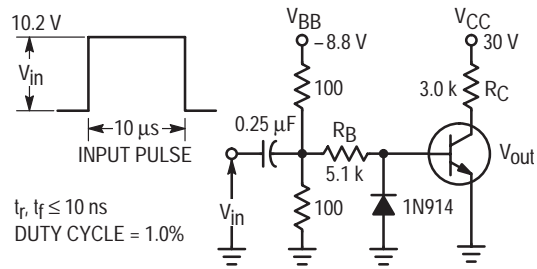


Figure 5. Temperature Coefficients



Values Shown are for I_C @ 10 mA

Figure 6. Switching Time Test Circuit

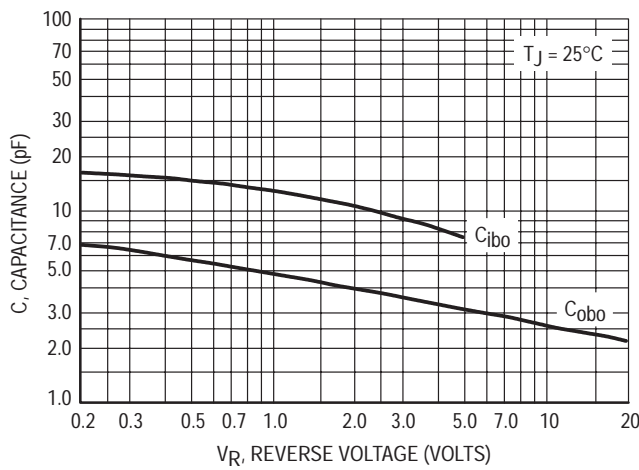


Figure 7. Capacitances

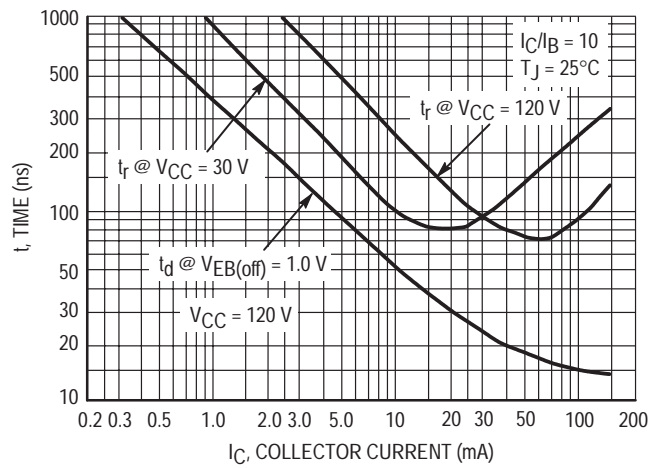


Figure 8. Turn-On Time

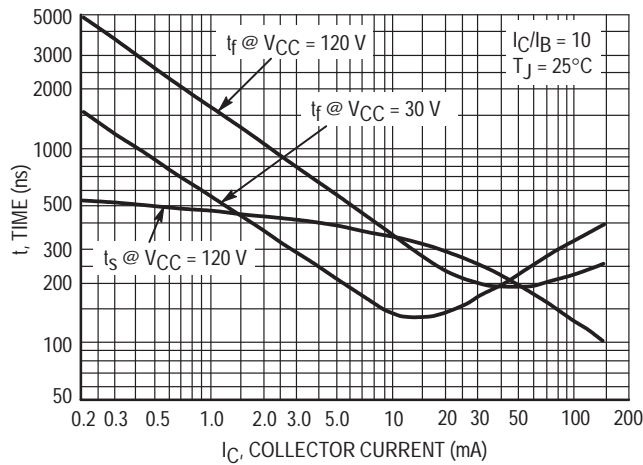
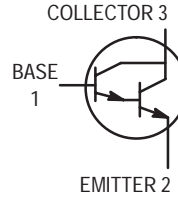


Figure 9. Turn-Off Time

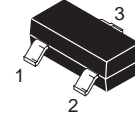
Darlington Transistor

NPN Silicon



MMBT6427LT1

Motorola Preferred Device



CASE 318-08, STYLE 6
SOT-23 (TO-236AB)

MAXIMUM RATINGS

Rating	Symbol	Value	Unit
Collector-Emitter Voltage	V_{CEO}	40	Vdc
Collector-Base Voltage	V_{CBO}	40	Vdc
Emitter-Base Voltage	V_{EBO}	12	Vdc
Collector Current — Continuous	I_C	500	mAdc

THERMAL CHARACTERISTICS

Characteristic	Symbol	Max	Unit
Total Device Dissipation FR-5 Board ⁽¹⁾ $T_A = 25^\circ\text{C}$ Derate above 25°C	P_D	225	mW
		1.8	mW/ $^\circ\text{C}$
Thermal Resistance, Junction to Ambient	$R_{\theta JA}$	556	$^\circ\text{C/W}$
Total Device Dissipation Alumina Substrate, ⁽²⁾ $T_A = 25^\circ\text{C}$ Derate above 25°C	P_D	300	mW
		2.4	mW/ $^\circ\text{C}$
Thermal Resistance, Junction to Ambient	$R_{\theta JA}$	417	$^\circ\text{C/W}$
Junction and Storage Temperature	T_J, T_{stg}	-55 to +150	$^\circ\text{C}$

DEVICE MARKING

MMBT6427LT1 = 1V

ELECTRICAL CHARACTERISTICS ($T_A = 25^\circ\text{C}$ unless otherwise noted)

Characteristic	Symbol	Min	Max	Unit
----------------	--------	-----	-----	------

OFF CHARACTERISTICS

Collector-Emitter Breakdown Voltage ($I_C = 10 \text{ mAdc}, V_{BE} = 0$)	$V_{(BR)CEO}$	40	—	Vdc
Collector-Base Breakdown Voltage ($I_C = 100 \mu\text{Adc}, I_E = 0$)	$V_{(BR)CBO}$	40	—	Vdc
Emitter-Base Breakdown Voltage ($I_C = 10 \mu\text{Adc}, I_C = 0$)	$V_{(BR)EBO}$	12	—	Vdc
Collector Cutoff Current ($V_{CE} = 25 \text{ Vdc}, I_B = 0$)	I_{CES}	—	1.0	μAdc
Collector Cutoff Current ($V_{CB} = 30 \text{ Vdc}, I_E = 0$)	I_{CBO}	—	50	nAdc
Emitter Cutoff Current ($V_{EB} = 10 \text{ Vdc}, I_C = 0$)	I_{EBO}	—	50	nAdc

1. FR-5 = $1.0 \times 0.75 \times 0.062 \text{ in.}$

2. Alumina = $0.4 \times 0.3 \times 0.024 \text{ in.}$ 99.5% alumina.

Preferred devices are Motorola recommended choices for future use and best overall value.

ELECTRICAL CHARACTERISTICS ($T_A = 25^\circ\text{C}$ unless otherwise noted) (Continued)

Characteristic	Symbol	Min	Max	Unit
ON CHARACTERISTICS				
DC Current Gain ($I_C = 10\text{ mAdc}$, $V_{CE} = 5.0\text{ Vdc}$) ($I_C = 100\text{ mAdc}$, $V_{CE} = 5.0\text{ Vdc}$) ($I_C = 500\text{ mAdc}$, $V_{CE} = 5.0\text{ Vdc}$)	h_{FE}	10,000 20,000 14,000	100,000 200,000 140,000	—
Collector–Emitter Saturation Voltage ($I_C = 50\text{ mAdc}$, $I_B = 0.5\text{ mAdc}$) ($I_C = 500\text{ mAdc}$, $I_B = 0.5\text{ mAdc}$)	$V_{CE(sat)}^{(3)}$	— —	1.2 1.5	Vdc
Base–Emitter Saturation Voltage ($I_C = 500\text{ mAdc}$, $I_B = 0.5\text{ mAdc}$)	$V_{BE(sat)}$	—	2.0	Vdc
Base–Emitter On Voltage ($I_C = 50\text{ mAdc}$, $V_{CE} = 5.0\text{ Vdc}$)	$V_{BE(on)}$	—	1.75	Vdc

SMALL–SIGNAL CHARACTERISTICS

Output Capacitance ($V_{CB} = 10\text{ Vdc}$, $I_E = 0$, $f = 1.0\text{ MHz}$)	C_{obo}	—	7.0	pF
Input Capacitance ($V_{EB} = 0.5\text{ Vdc}$, $I_C = 0$, $f = 1.0\text{ MHz}$)	C_{ibo}	—	15	pF
Current Gain — High Frequency ($I_C = 10\text{ mAdc}$, $V_{CE} = 5.0\text{ Vdc}$, $f = 100\text{ MHz}$)	$ h_{fe} $	1.3	—	Vdc
Noise Figure ($I_C = 1.0\text{ mAdc}$, $V_{CE} = 5.0\text{ Vdc}$, $R_S = 100\text{ k}\Omega$, $f = 1.0\text{ kHz}$)	NF	—	10	dB

3. Pulse Test: Pulse Width = 300 μs , Duty Cycle = 2.0%.

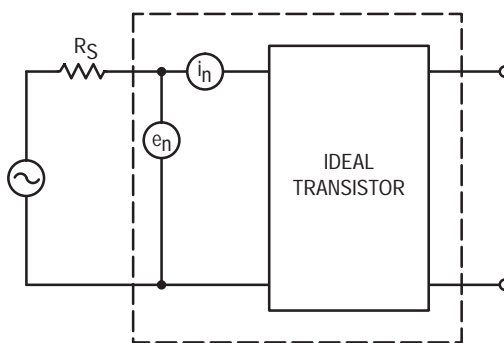


Figure 1. Transistor Noise Model

NOISE CHARACTERISTICS

($V_{CE} = 5.0 \text{ Vdc}$, $T_A = 25^\circ\text{C}$)

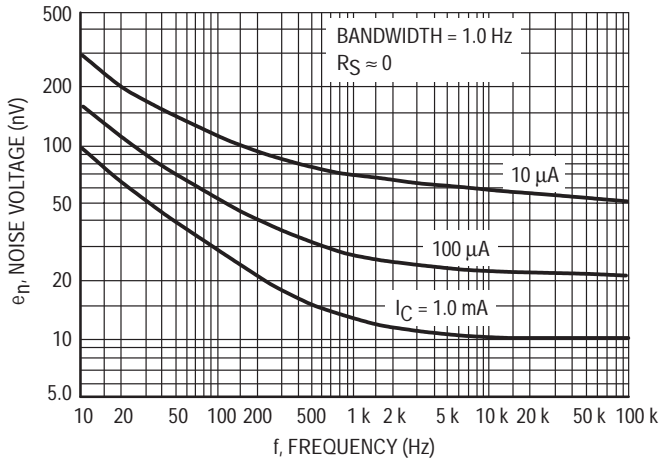


Figure 2. Noise Voltage

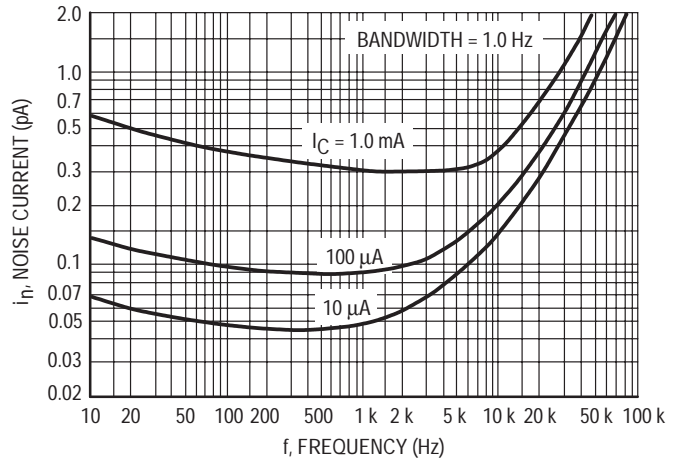


Figure 3. Noise Current

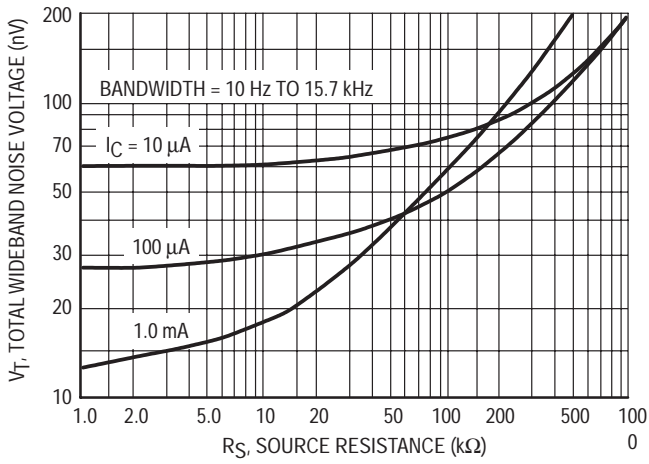


Figure 4. Total Wideband Noise Voltage

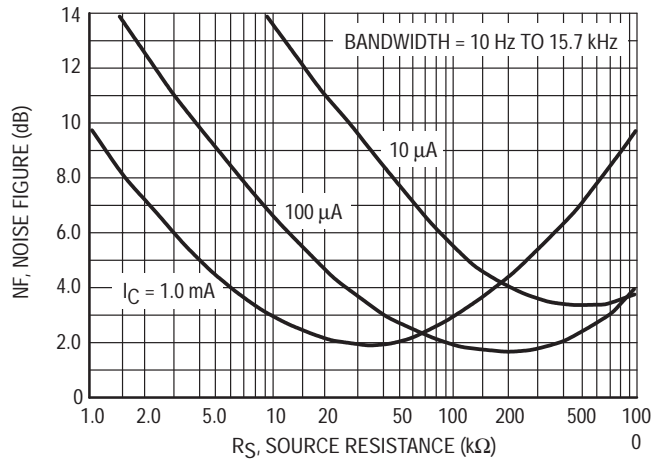


Figure 5. Wideband Noise Figure

SMALL-SIGNAL CHARACTERISTICS

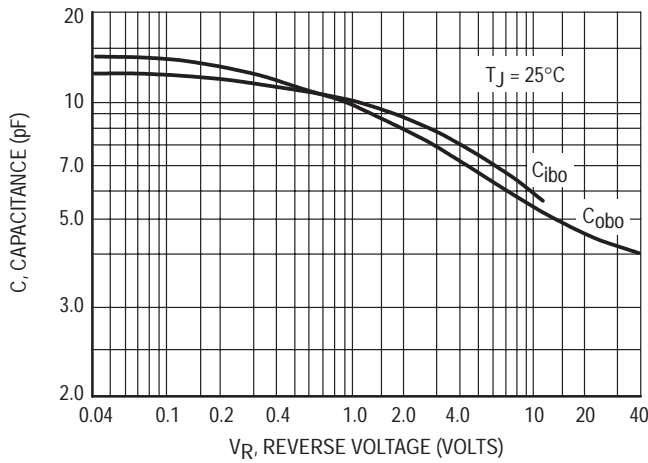


Figure 6. Capacitance

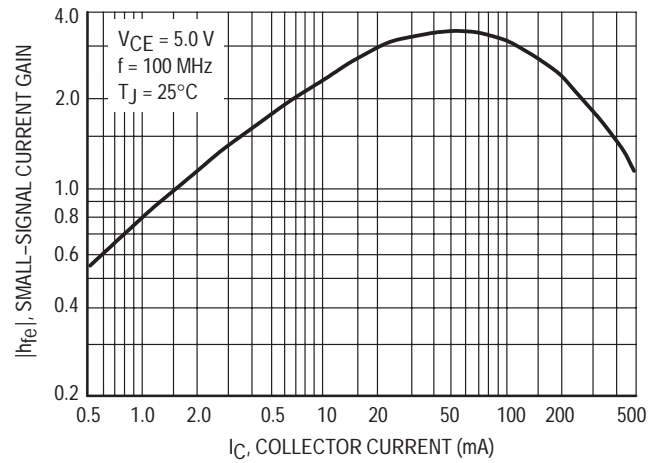


Figure 7. High Frequency Current Gain

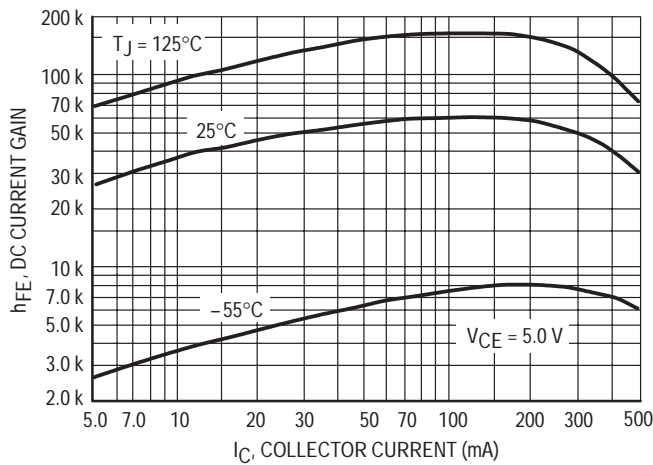


Figure 8. DC Current Gain

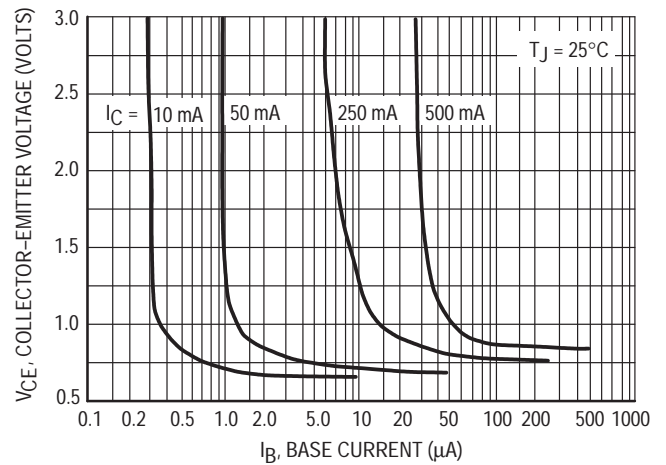


Figure 9. Collector Saturation Region

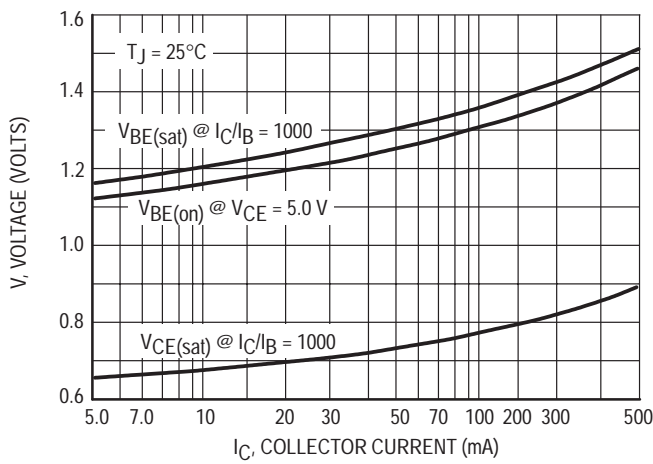


Figure 10. "On" Voltages

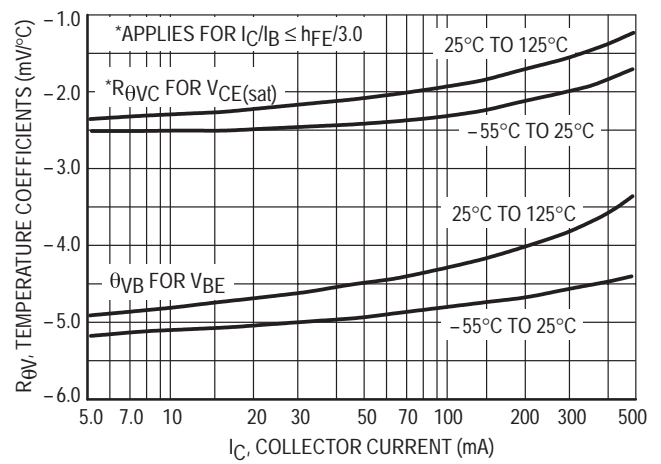


Figure 11. Temperature Coefficients

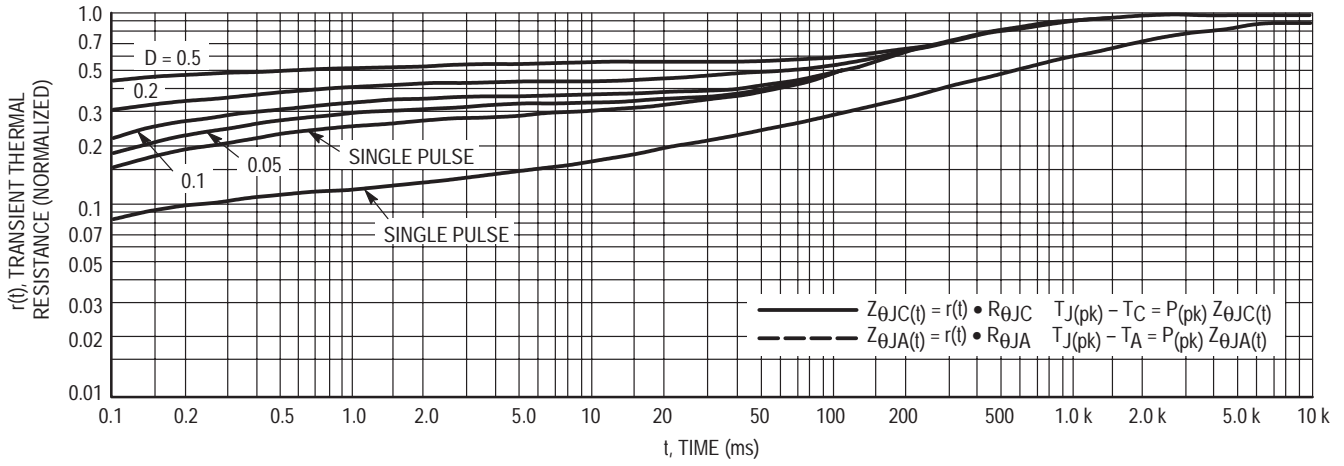
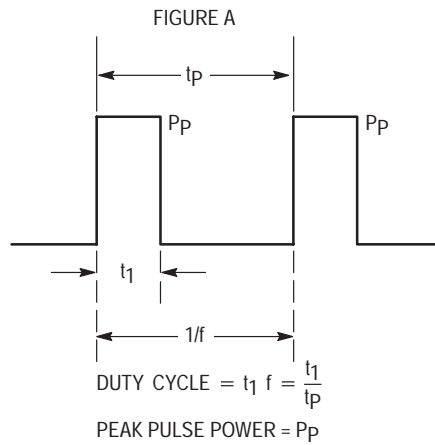


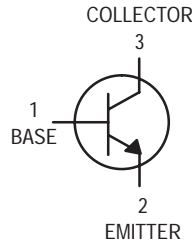
Figure 12. Thermal Response



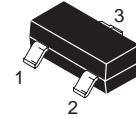
Design Note: Use of Transient Thermal Resistance Data

Amplifier Transistors

NPN Silicon



MMBT6428LT1
MMBT6429LT1



CASE 318-08, STYLE 6
SOT-23 (TO-236AB)

MAXIMUM RATINGS

Rating	Symbol	6428LT1	6429LT1	Unit
Collector–Emitter Voltage	V_{CEO}	50	45	Vdc
Collector–Base Voltage	V_{CBO}	60	55	Vdc
Emitter–Base Voltage	V_{EBO}	6.0		Vdc
Collector Current — Continuous	I_C	200		mAdc

THERMAL CHARACTERISTICS

Characteristic	Symbol	Max	Unit
Total Device Dissipation FR-5 Board ⁽¹⁾ $T_A = 25^\circ\text{C}$ Derate above 25°C	P_D	225	mW
		1.8	mW/ $^\circ\text{C}$
Thermal Resistance, Junction to Ambient	$R_{\theta JA}$	556	$^\circ\text{C}/\text{W}$
Total Device Dissipation Alumina Substrate, ⁽²⁾ $T_A = 25^\circ\text{C}$ Derate above 25°C	P_D	300	mW
		2.4	mW/ $^\circ\text{C}$
Thermal Resistance, Junction to Ambient	$R_{\theta JA}$	417	$^\circ\text{C}/\text{W}$
Junction and Storage Temperature	T_J, T_{stg}	-55 to +150	$^\circ\text{C}$

DEVICE MARKING

MMBT6428LT1 = 1KM; MMBT6429LT1 = 1L

ELECTRICAL CHARACTERISTICS ($T_A = 25^\circ\text{C}$ unless otherwise noted)

Characteristic	Symbol	Min	Max	Unit
----------------	--------	-----	-----	------

OFF CHARACTERISTICS

Collector–Emitter Breakdown Voltage ($I_C = 1.0 \text{ mAdc}, I_E = 0$) ($I_C = 1.0 \text{ mAdc}, I_E = 0$)	MMBT6428 MMBT6429	$V_{(BR)CEO}$	50 45	—	Vdc
Collector–Base Breakdown Voltage ($I_C = 0.1 \text{ mAdc}, I_E = 0$) ($I_C = 0.1 \text{ mAdc}, I_E = 0$)	MMBT6428 MMBT6429	$V_{(BR)CBO}$	60 55	—	Vdc
Collector Cutoff Current ($V_{CE} = 30 \text{ Vdc}$)		I_{CES}	—	0.1	μAdc
Collector Cutoff Current ($V_{CB} = 30 \text{ Vdc}, I_E = 0$)		I_{CBO}	—	0.01	μAdc
Emitter Cutoff Current ($V_{EB} = 5.0 \text{ Vdc}, I_C = 0$)		I_{EBO}	—	0.01	μAdc

1. FR-5 = $1.0 \times 0.75 \times 0.062 \text{ in.}$

2. Alumina = $0.4 \times 0.3 \times 0.024 \text{ in.}$ 99.5% alumina.

MMBT6428LT1 MMBT6429LT1

ELECTRICAL CHARACTERISTICS ($T_A = 25^\circ\text{C}$ unless otherwise noted) (Continued)

Characteristic	Symbol	Min	Max	Unit
ON CHARACTERISTICS				
DC Current Gain ($I_C = 0.01 \text{ mAdc}$, $V_{CE} = 5.0 \text{ Vdc}$)	h_{FE}	250	—	—
	MMBT6428	500	—	—
	MMBT6429	—	—	—
($I_C = 0.1 \text{ mAdc}$, $V_{CE} = 5.0 \text{ Vdc}$)		250	650	
	MMBT6428	500	1250	
	MMBT6429	—	—	—
($I_C = 1.0 \text{ mAdc}$, $V_{CE} = 5.0 \text{ Vdc}$)		250	—	
	MMBT6428	500	—	
	MMBT6429	—	—	—
($I_C = 10 \text{ mAdc}$, $V_{CE} = 5.0 \text{ Vdc}$)		250	—	
	MMBT6428	500	—	
	MMBT6429	—	—	—
Collector–Emitter Saturation Voltage ($I_C = 10 \text{ mAdc}$, $I_B = 0.5 \text{ mAdc}$) ($I_C = 100 \text{ mAdc}$, $I_B = 5.0 \text{ mAdc}$)	$V_{CE(sat)}$	—	0.2	Vdc
		—	0.6	
Base–Emitter On Voltage ($I_C = 1.0 \text{ mAdc}$, $V_{CE} = 5.0 \text{ mAdc}$)	$V_{BE(on)}$	0.56	0.66	Vdc

SMALL–SIGNAL CHARACTERISTICS

Current–Gain — Bandwidth Product ($I_C = 1.0 \text{ mAdc}$, $V_{CE} = 5.0 \text{ Vdc}$, $f = 100 \text{ MHz}$)	f_T	100	700	MHz
Output Capacitance ($V_{CB} = 10 \text{ Vdc}$, $I_E = 0$, $f = 1.0 \text{ MHz}$)	C_{obo}	—	3.0	pF
Input Capacitance ($V_{EB} = 0.5 \text{ Vdc}$, $I_C = 0$, $f = 1.0 \text{ MHz}$)	C_{ibo}	—	8.0	pF

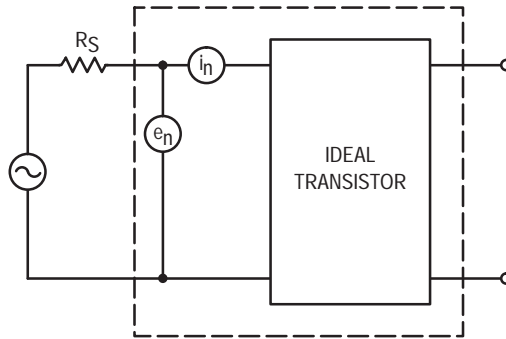


Figure 1. Transistor Noise Model

NOISE CHARACTERISTICS

($V_{CE} = 5.0$ Vdc, $T_A = 25^\circ\text{C}$)

NOISE VOLTAGE

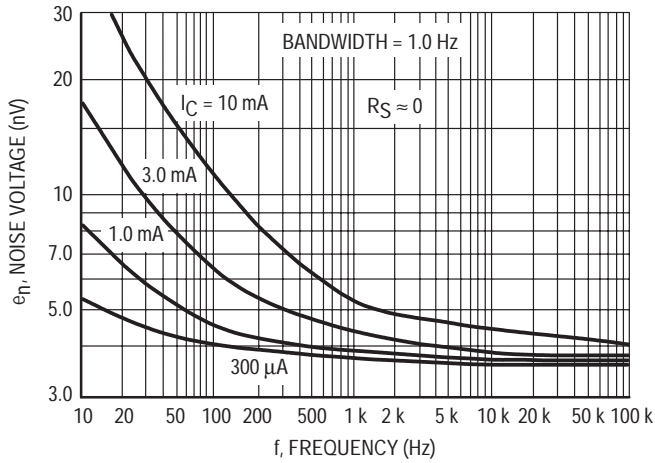


Figure 2. Effects of Frequency

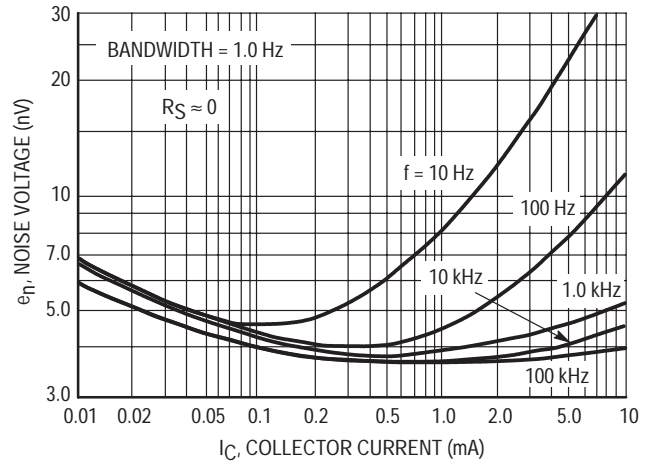


Figure 3. Effects of Collector Current

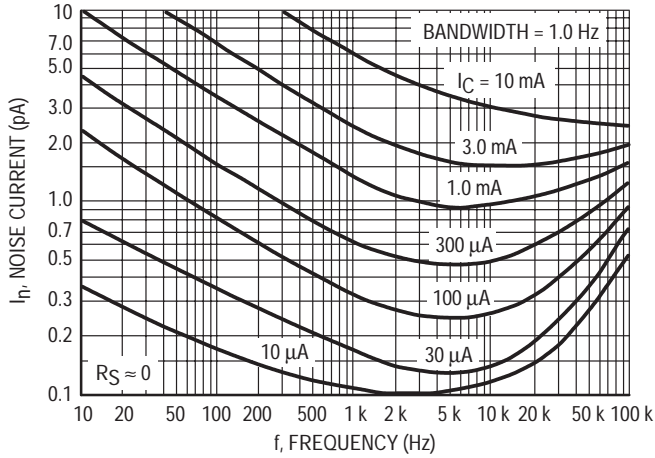


Figure 4. Noise Current

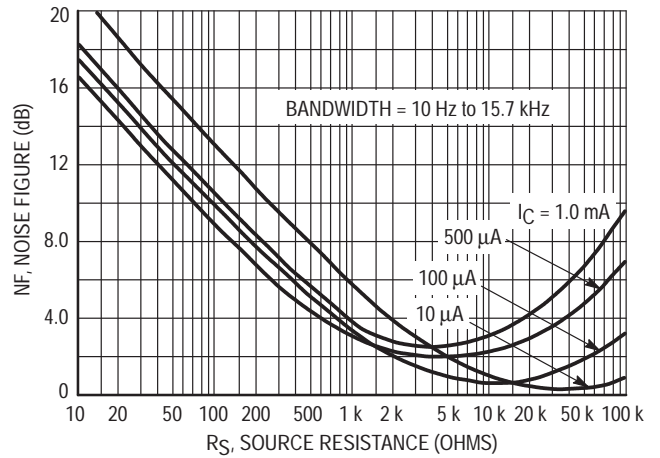


Figure 5. Wideband Noise Figure

100 Hz NOISE DATA

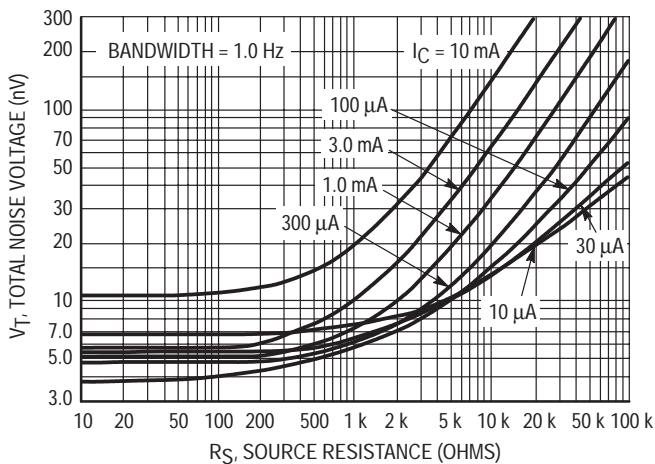


Figure 6. Total Noise Voltage

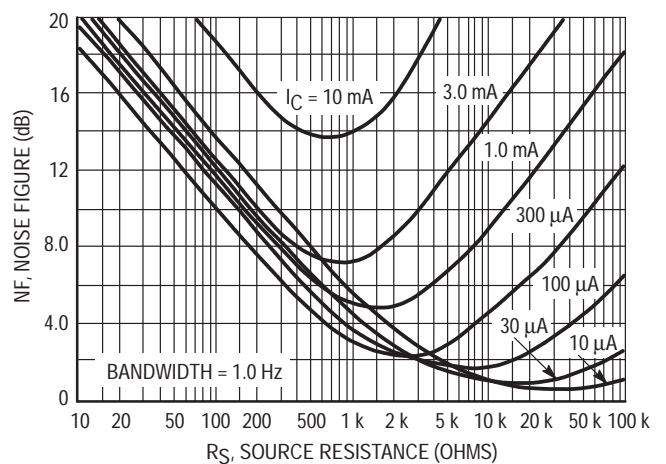


Figure 7. Noise Figure

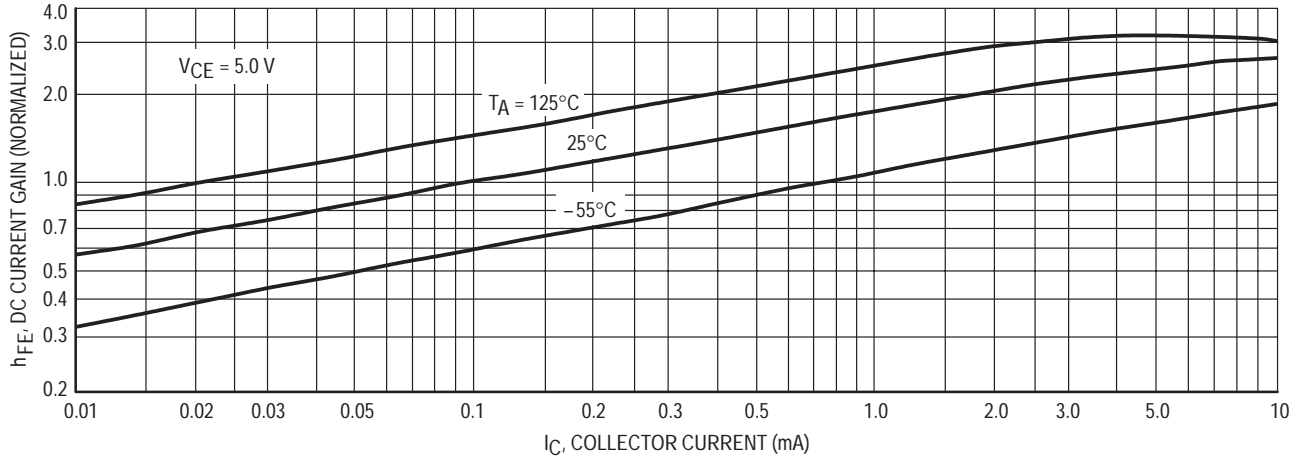


Figure 8. DC Current Gain

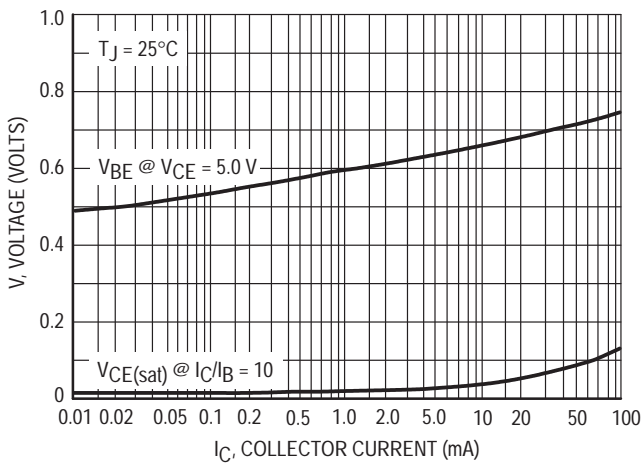


Figure 9. "On" Voltages

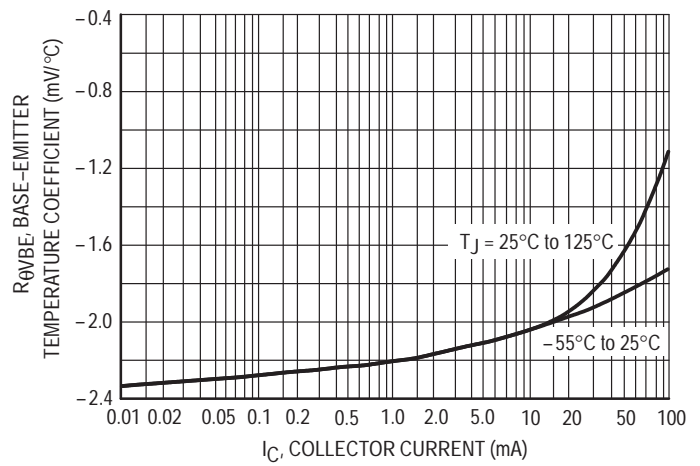


Figure 10. Temperature Coefficients

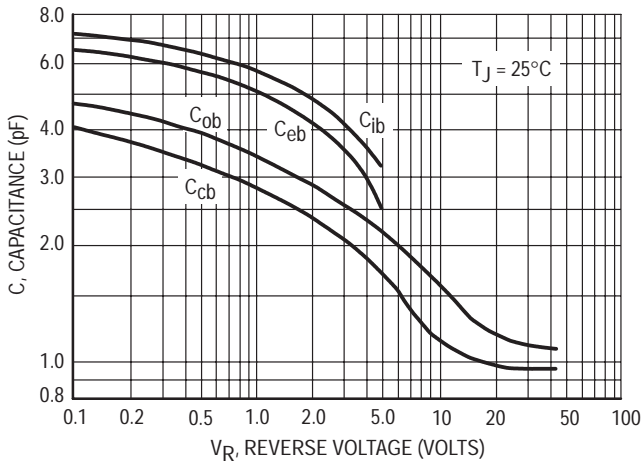


Figure 11. Capacitance

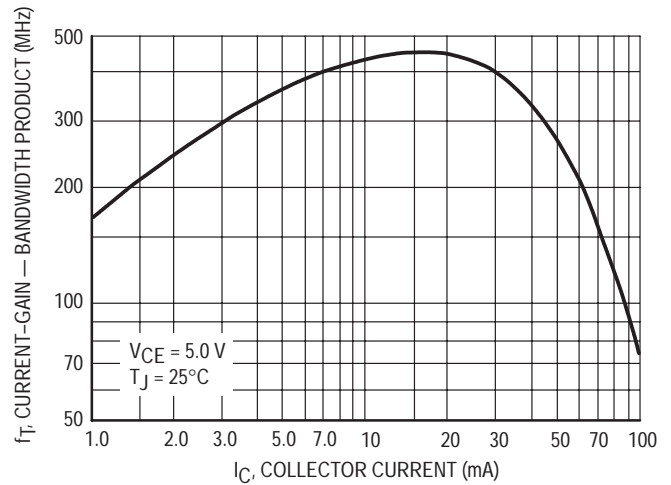
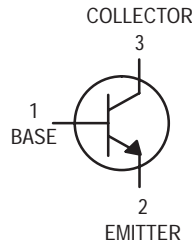


Figure 12. Current-Gain — Bandwidth Product

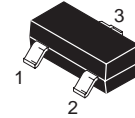
High Voltage Transistor

NPN Silicon



MMBT6517LT1

Motorola Preferred Device



CASE 318-08, STYLE 6
SOT-23 (TO-236AB)

MAXIMUM RATINGS

Rating	Symbol	Value	Unit
Collector–Emitter Voltage	V_{CEO}	350	Vdc
Collector–Base Voltage	V_{CBO}	350	Vdc
Emitter–Base Voltage	V_{EBO}	5.0	Vdc
Base Current	I_B	250	mAdc
Collector Current — Continuous	I_C	500	mAdc

THERMAL CHARACTERISTICS

Characteristic	Symbol	Max	Unit
Total Device Dissipation FR-5 Board ⁽¹⁾ $T_A = 25^\circ\text{C}$ Derate above 25°C	P_D	225 1.8	mW mW/ $^\circ\text{C}$
Thermal Resistance, Junction to Ambient	$R_{\theta JA}$	556	$^\circ\text{C}/\text{W}$
Total Device Dissipation Alumina Substrate, ⁽²⁾ $T_A = 25^\circ\text{C}$ Derate above 25°C	P_D	300 2.4	mW mW/ $^\circ\text{C}$
Thermal Resistance, Junction to Ambient	$R_{\theta JA}$	417	$^\circ\text{C}/\text{W}$
Junction and Storage Temperature	T_J, T_{stg}	-55 to +150	$^\circ\text{C}$

DEVICE MARKING

MMBT6517LT1 = 1Z

ELECTRICAL CHARACTERISTICS ($T_A = 25^\circ\text{C}$ unless otherwise noted)

Characteristic	Symbol	Min	Max	Unit
----------------	--------	-----	-----	------

OFF CHARACTERISTICS

Collector–Emitter Breakdown Voltage ($I_C = 1.0 \text{ mAdc}$)	$V_{(BR)CEO}$	350	—	Vdc
Collector–Base Breakdown Voltage ($I_C = 100 \mu\text{Adc}$)	$V_{(BR)CBO}$	350	—	Vdc
Emitter–Base Breakdown Voltage ($I_E = 10 \mu\text{Adc}$)	$V_{(BR)EBO}$	6.0	—	Vdc
Collector Cutoff Current ($V_{CB} = 250 \text{ Vdc}$)	I_{CBO}	—	50	nAdc
Emitter Cutoff Current ($V_{EB} = 5.0 \text{ Vdc}$)	I_{EBO}	—	50	nAdc

1. FR-5 = $1.0 \times 0.75 \times 0.062 \text{ in.}$

2. Alumina = $0.4 \times 0.3 \times 0.024 \text{ in.}$ 99.5% alumina.

Preferred devices are Motorola recommended choices for future use and best overall value.

MMBT6517LT1**ELECTRICAL CHARACTERISTICS** ($T_A = 25^\circ\text{C}$ unless otherwise noted) (Continued)

Characteristic	Symbol	Min	Max	Unit
ON CHARACTERISTICS				
DC Current Gain ($I_C = 1.0\text{ mAdc}$, $V_{CE} = 10\text{ Vdc}$) ($I_C = 10\text{ mAdc}$, $V_{CE} = 10\text{ Vdc}$) ($I_C = 30\text{ mAdc}$, $V_{CE} = 10\text{ Vdc}$) ($I_C = 50\text{ mAdc}$, $V_{CE} = 10\text{ Vdc}$) ($I_C = 100\text{ mAdc}$, $V_{CE} = 10\text{ Vdc}$)	h_{FE}	20 30 30 20 15	— — 200 200 —	—
Collector–Emitter Saturation Voltage (3) ($I_C = 10\text{ mAdc}$, $I_B = 1.0\text{ mAdc}$) ($I_C = 20\text{ mAdc}$, $I_B = 2.0\text{ mAdc}$) ($I_C = 30\text{ mAdc}$, $I_B = 3.0\text{ mAdc}$) ($I_C = 50\text{ mAdc}$, $I_B = 5.0\text{ mAdc}$)	$V_{CE(sat)}$	— — — —	0.30 0.35 0.50 1.0	Vdc
Base–Emitter Saturation Voltage ($I_C = 10\text{ mAdc}$, $I_B = 1.0\text{ mAdc}$) ($I_C = 20\text{ mAdc}$, $I_B = 2.0\text{ mAdc}$) ($I_C = 30\text{ mAdc}$, $I_B = 3.0\text{ mAdc}$)	$V_{BE(sat)}$	— — —	0.75 0.85 0.90	Vdc
Base–Emitter On Voltage ($I_C = 100\text{ mAdc}$, $V_{CE} = 10\text{ Vdc}$)	$V_{BE(on)}$	—	2.0	Vdc
SMALL–SIGNAL CHARACTERISTICS				
Current Gain — Bandwidth Product ($I_C = 10\text{ mAdc}$, $V_{CE} = 20\text{ Vdc}$, $f = 20\text{ MHz}$)	f_T	40	200	MHz
Collector–Base Capacitance ($V_{CB} = 20\text{ Vdc}$, $f = 1.0\text{ MHz}$)	C_{cb}	—	6.0	pF
Emitter–Base Capacitance ($V_{EB} = 0.5\text{ Vdc}$, $f = 1.0\text{ MHz}$)	C_{eb}	—	80	pF

3. Pulse Test: Pulse Width = 300 μs , Duty Cycle = 2.0%.

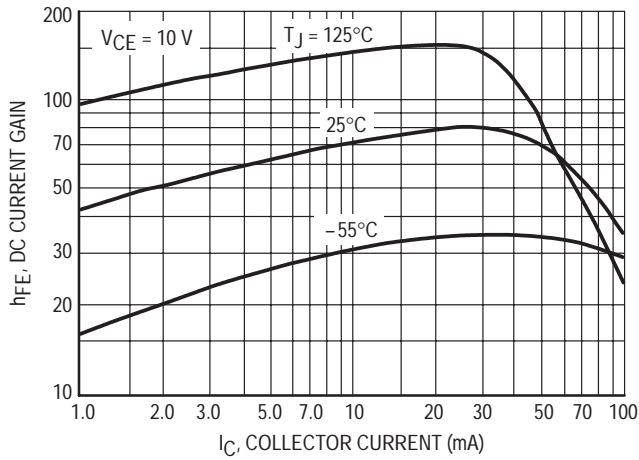


Figure 1. DC Current Gain

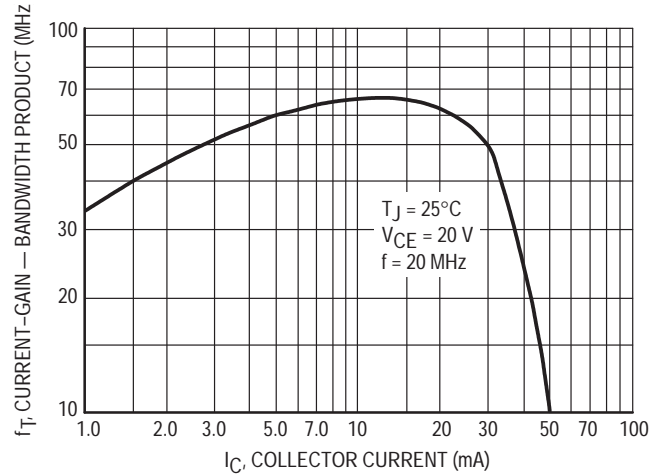


Figure 2. Current-Gain — Bandwidth Product

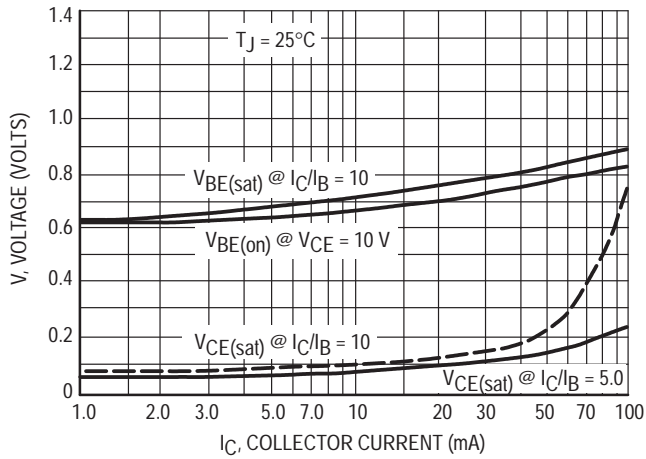


Figure 3. "On" Voltages

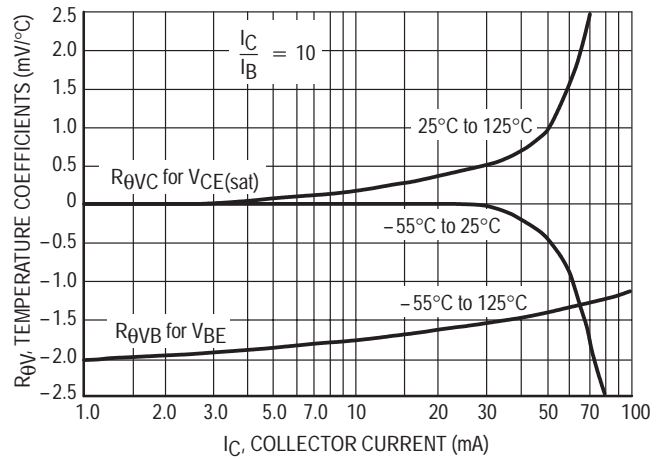


Figure 4. Temperature Coefficients

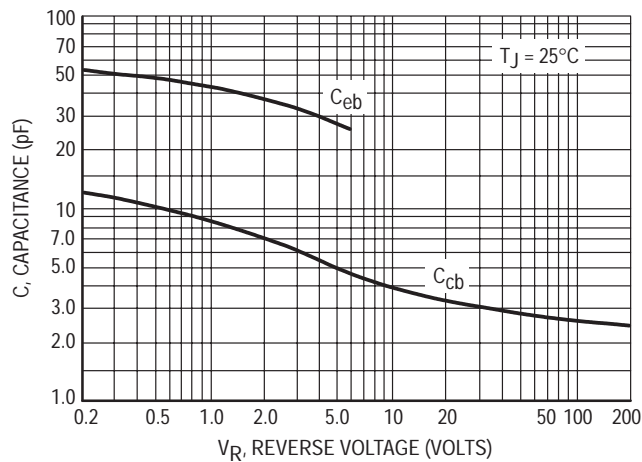


Figure 5. Capacitance

MMBT6517LT1

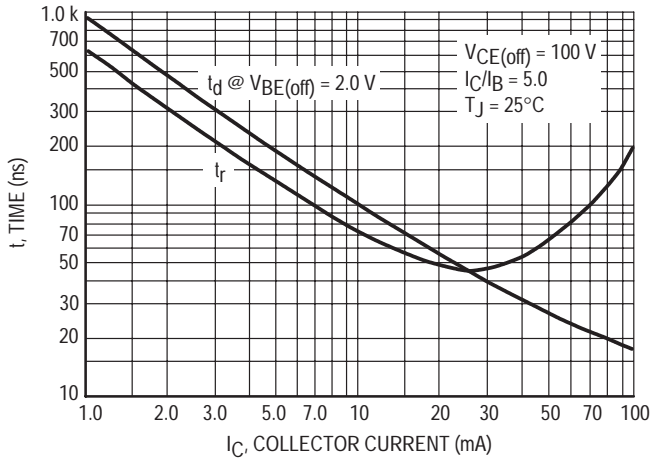


Figure 6. Turn-On Time

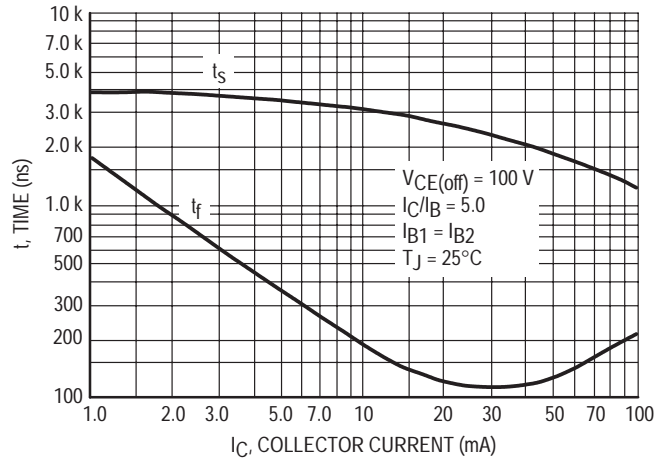


Figure 7. Turn-Off Time

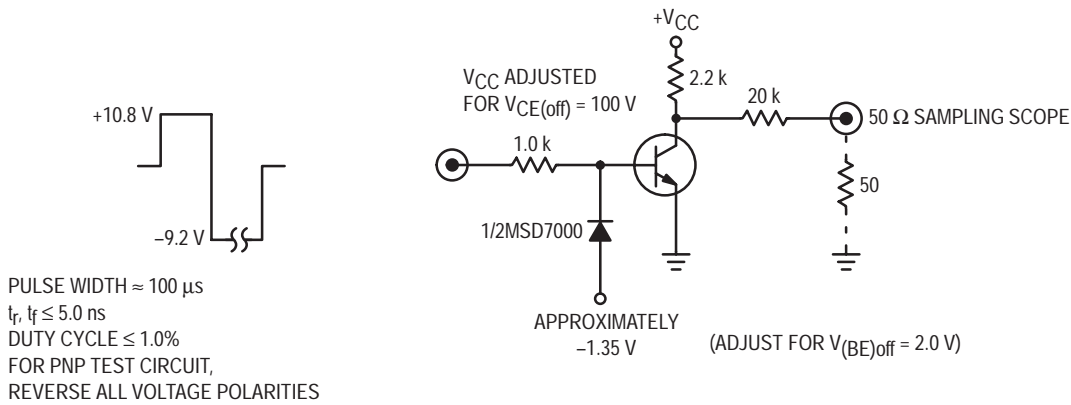


Figure 8. Switching Time Test Circuit

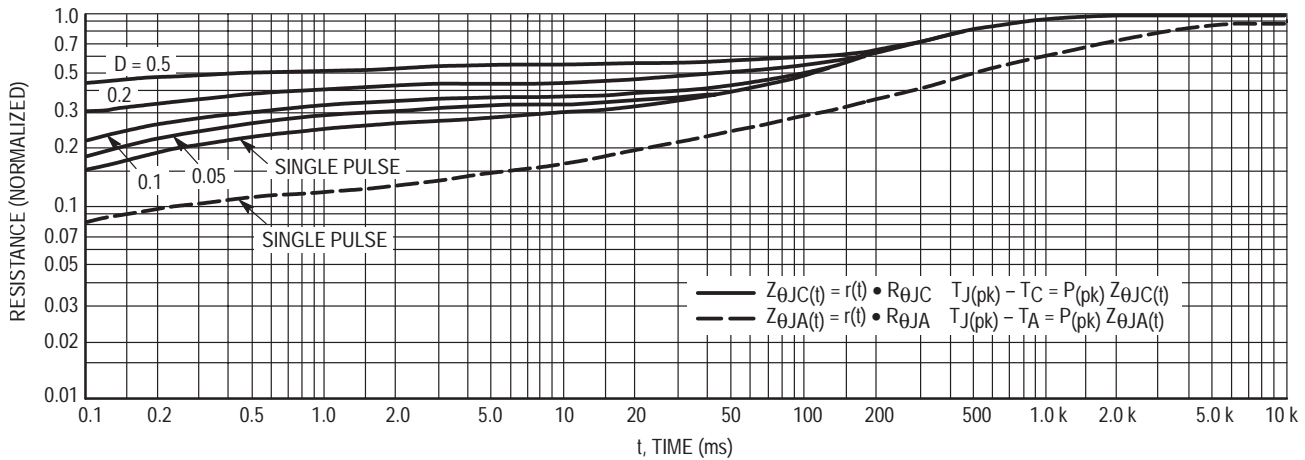
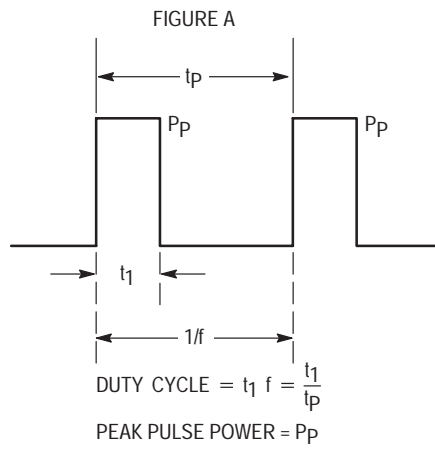


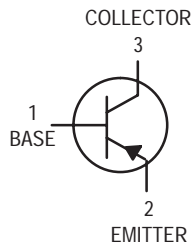
Figure 9. Thermal Response



Design Note: Use of Transient Thermal Resistance Data

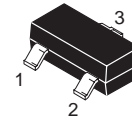
High Voltage Transistor

PNP Silicon



MMBT6520LT1

Motorola Preferred Device



CASE 318-08, STYLE 6
SOT-23 (TO-236AB)

MAXIMUM RATINGS

Rating	Symbol	Value	Unit
Collector-Emitter Voltage	V_{CEO}	-350	Vdc
Collector-Base Voltage	V_{CBO}	-350	Vdc
Emitter-Base Voltage	V_{EBO}	-5.0	Vdc
Base Current	I_B	-250	mA
Collector Current — Continuous	I_C	-500	mAdc

DEVICE MARKING

MMBT6520LT1 = 2Z

THERMAL CHARACTERISTICS

Characteristic	Symbol	Max	Unit
Total Device Dissipation FR-5 Board (1) $T_A = 25^\circ\text{C}$ Derate above 25°C	P_D	225	mW
		1.8	mW/ $^\circ\text{C}$
Thermal Resistance, Junction to Ambient	$R_{\theta JA}$	556	$^\circ\text{C}/\text{W}$
Total Device Dissipation Alumina Substrate, (2) $T_A = 25^\circ\text{C}$ Derate above 25°C	P_D	300	mW
		2.4	mW/ $^\circ\text{C}$
Thermal Resistance, Junction to Ambient	$R_{\theta JA}$	417	$^\circ\text{C}/\text{W}$
Junction and Storage Temperature	T_J, T_{stg}	-55 to +150	$^\circ\text{C}$

ELECTRICAL CHARACTERISTICS ($T_A = 25^\circ\text{C}$ unless otherwise noted)

Characteristic	Symbol	Min	Max	Unit
----------------	--------	-----	-----	------

OFF CHARACTERISTICS

Collector-Emitter Breakdown Voltage ($I_C = -1.0\text{ mA}$)	$V_{(BR)CEO}$	-350	—	Vdc
Collector-Base Breakdown Voltage ($I_C = -100\ \mu\text{A}$)	$V_{(BR)CBO}$	-350	—	Vdc
Emitter-Base Breakdown Voltage ($I_E = -10\ \mu\text{A}$)	$V_{(BR)EBO}$	-5.0	—	Vdc
Collector Cutoff Current ($V_{CB} = -250\text{ V}$)	I_{CBO}	—	-50	nA
Emitter Cutoff Current ($V_{EB} = -4.0\text{ V}$)	I_{EBO}	—	-50	nA

1. FR-5 = $1.0 \times 0.75 \times 0.062$ in.

2. Alumina = $0.4 \times 0.3 \times 0.024$ in. 99.5% alumina

Preferred devices are Motorola recommended choices for future use and best overall value.

ELECTRICAL CHARACTERISTICS ($T_A = 25^\circ\text{C}$ unless otherwise noted) (Continued)

Characteristic	Symbol	Min	Max	Unit
ON CHARACTERISTICS				
DC Current Gain ($I_C = -1.0\text{ mA}$, $V_{CE} = -10\text{ V}$) ($I_C = -10\text{ mA}$, $V_{CE} = -10\text{ V}$) ($I_C = -30\text{ mA}$, $V_{CE} = -10\text{ V}$) ($I_C = -50\text{ mA}$, $V_{CE} = -10\text{ V}$) ($I_C = -100\text{ mA}$, $V_{CE} = -10\text{ V}$)	h_{FE}	20 30 30 20 15	— — 200 200 —	—
Collector–Emitter Saturation Voltage ($I_C = -10\text{ mA}$, $I_B = -1.0\text{ mA}$) ($I_C = -20\text{ mA}$, $I_B = -2.0\text{ mA}$) ($I_C = -30\text{ mA}$, $I_B = -3.0\text{ mA}$) ($I_C = -50\text{ mA}$, $I_B = -5.0\text{ mA}$)	$V_{CE(sat)}$	— — — —	-0.30 -0.35 -0.50 -1.0	Vdc
Base–Emitter Saturation Voltage ($I_C = -10\text{ mA}$, $I_B = -1.0\text{ mA}$) ($I_C = -20\text{ mA}$, $I_B = -2.0\text{ mA}$) ($I_C = -30\text{ mA}$, $I_B = -3.0\text{ mA}$)	$V_{BE(sat)}$	— — —	-0.75 -0.85 -0.90	Vdc
Base–Emitter On Voltage ($I_C = -100\text{ mA}$, $V_{CE} = -10\text{ V}$)	$V_{BE(on)}$	—	-2.0	Vdc
SMALL–SIGNAL CHARACTERISTICS				
Current–Gain — Bandwidth Product ($I_C = -10\text{ mA}$, $V_{CE} = -20\text{ V}$, $f = 20\text{ MHz}$)	f_T	40	200	MHz
Collector–Base Capacitance ($V_{CB} = -20\text{ V}$, $f = 1.0\text{ MHz}$)	C_{cb}	—	6.0	pF
Emitter–Base Capacitance ($V_{EB} = -0.5\text{ V}$, $f = 1.0\text{ MHz}$)	C_{eb}	—	100	pF

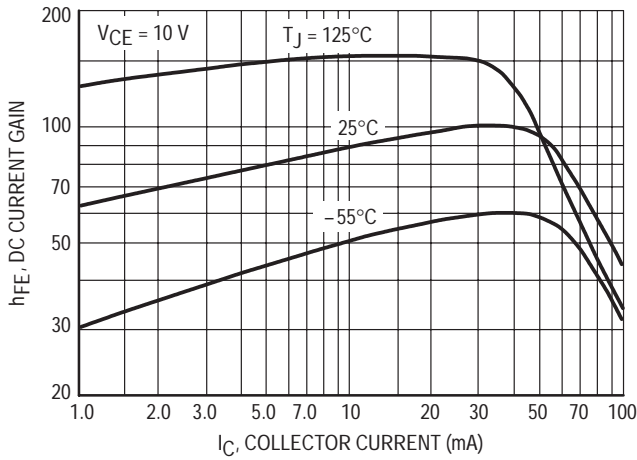


Figure 1. DC Current Gain

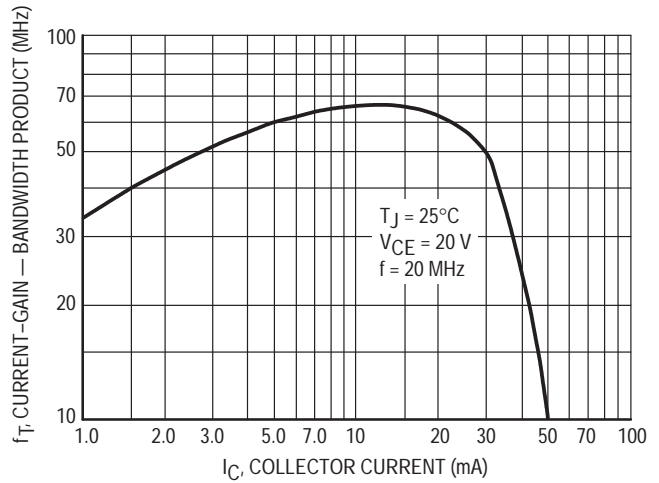


Figure 2. Current-Gain — Bandwidth Product

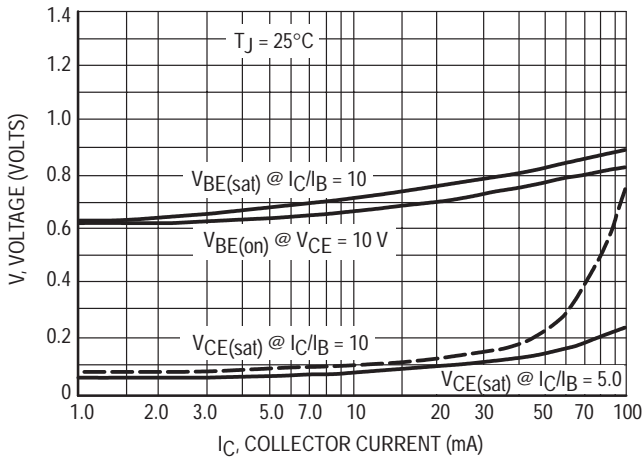


Figure 3. "On" Voltages

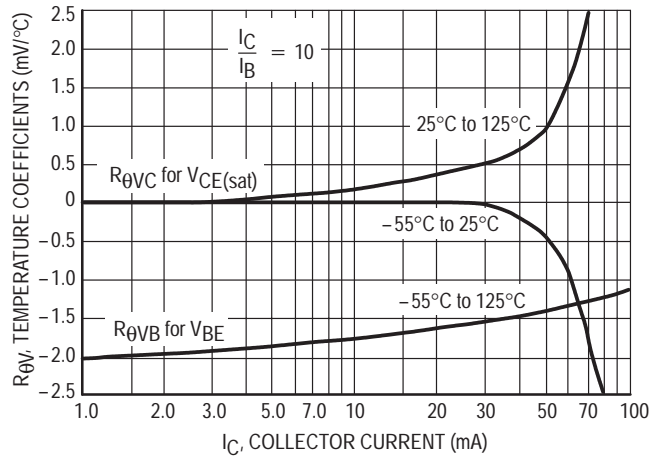


Figure 4. Temperature Coefficients

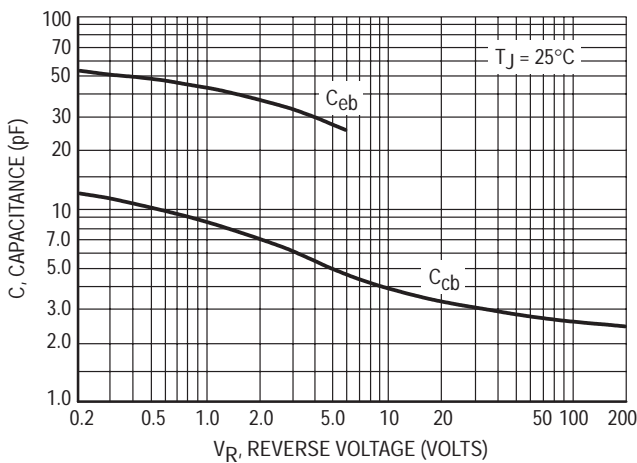


Figure 5. Capacitance

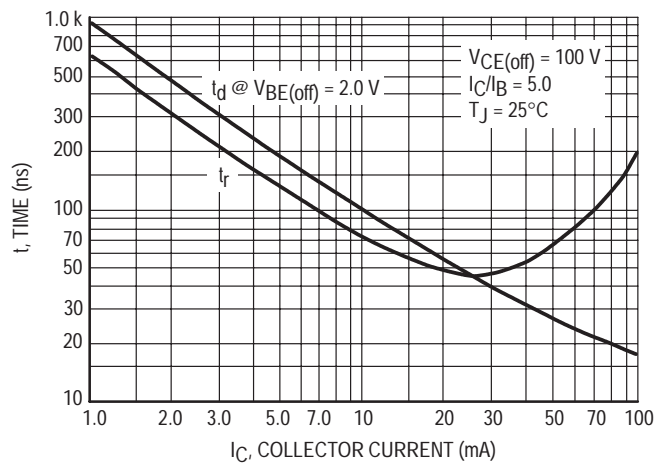


Figure 6. Turn-On Time

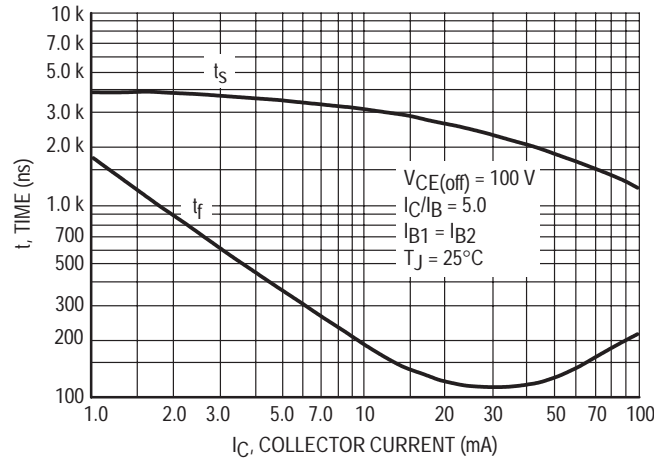


Figure 7. Turn-Off Time

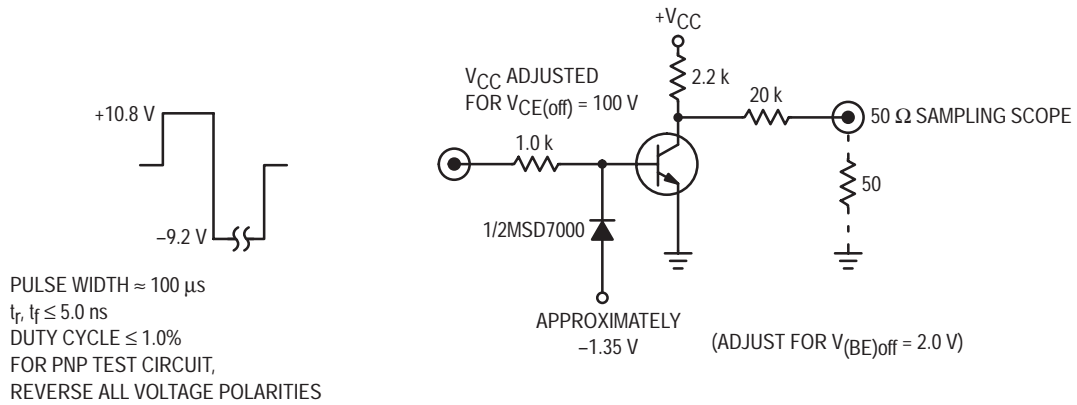


Figure 8. Switching Time Test Circuit

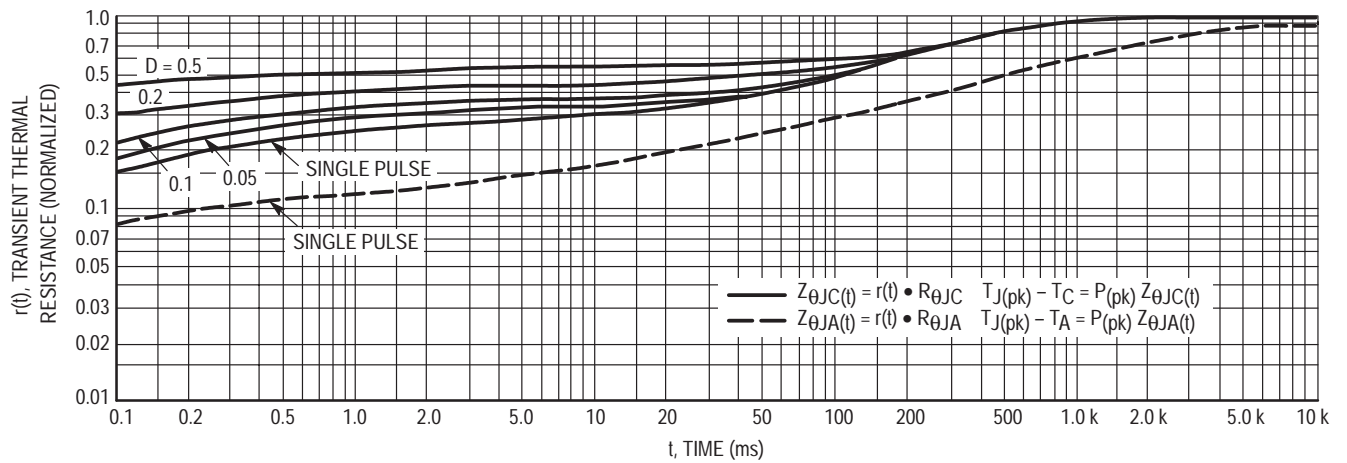
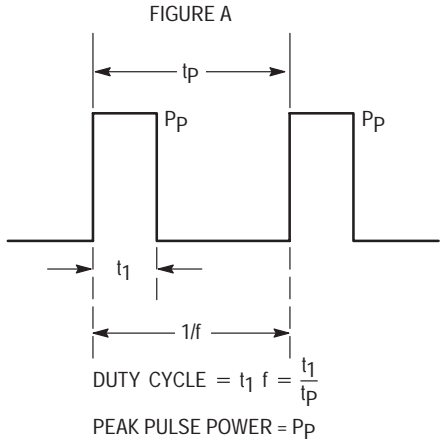


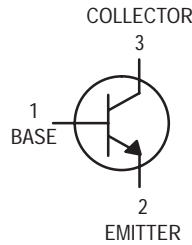
Figure 9. Thermal Response



Design Note: Use of Transient Thermal Resistance Data

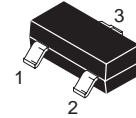
Driver Transistors

NPN Silicon



MMBTA05LT1
MMBTA06LT1*

*Motorola Preferred Device



CASE 318-08, STYLE 6
SOT-23 (TO-236AB)

MAXIMUM RATINGS

Rating	Symbol	MMBTA05	MMBTA06	Unit
Collector-Emitter Voltage	V_{CEO}	60	80	Vdc
Collector-Base Voltage	V_{CBO}	60	80	Vdc
Emitter-Base Voltage	V_{EBO}	4.0		Vdc
Collector Current — Continuous	I_C	500		mAdc

THERMAL CHARACTERISTICS

Characteristic	Symbol	Max	Unit
Total Device Dissipation FR-5 Board ⁽¹⁾ $T_A = 25^\circ\text{C}$ Derate above 25°C	P_D	225	mW
		1.8	mW/ $^\circ\text{C}$
Thermal Resistance, Junction to Ambient	$R_{\theta JA}$	556	$^\circ\text{C/W}$
Total Device Dissipation Alumina Substrate, ⁽²⁾ $T_A = 25^\circ\text{C}$ Derate above 25°C	P_D	300	mW
		2.4	mW/ $^\circ\text{C}$
Thermal Resistance, Junction to Ambient	$R_{\theta JA}$	417	$^\circ\text{C/W}$
Junction and Storage Temperature	T_J, T_{stg}	-55 to +150	$^\circ\text{C}$

DEVICE MARKING

MMBTA05LT1 = 1H; MMBTA06LT1 = 1GM

ELECTRICAL CHARACTERISTICS ($T_A = 25^\circ\text{C}$ unless otherwise noted)

Characteristic	Symbol	Min	Max	Unit
----------------	--------	-----	-----	------

OFF CHARACTERISTICS

Collector-Emitter Breakdown Voltage (3) ($I_C = 1.0 \text{ mAdc}, I_B = 0$)	MMBTA05 MMBTA06	$V_{(BR)CEO}$	60 80	—	Vdc
Emitter-Base Breakdown Voltage ($I_E = 100 \mu\text{Adc}, I_C = 0$)		$V_{(BR)EBO}$	4.0	—	Vdc
Collector Cutoff Current ($V_{CE} = 60 \text{ Vdc}, I_B = 0$)		I_{CES}	—	0.1	μAdc
Collector Cutoff Current ($V_{CB} = 60 \text{ Vdc}, I_E = 0$) ($V_{CB} = 80 \text{ Vdc}, I_E = 0$)	MMBTA05 MMBTA06	I_{CBO}	— —	0.1 0.1	μAdc

1. FR-5 = $1.0 \times 0.75 \times 0.062 \text{ in.}$

2. Alumina = $0.4 \times 0.3 \times 0.024 \text{ in.}$ 99.5% alumina.

3. Pulse Test: Pulse Width $\leq 300 \mu\text{s}$, Duty Cycle $\leq 2.0\%$.

Preferred devices are Motorola recommended choices for future use and best overall value.

MMBTA05LT1 MMBTA06LT1**ELECTRICAL CHARACTERISTICS** ($T_A = 25^\circ\text{C}$ unless otherwise noted) (Continued)

Characteristic	Symbol	Min	Max	Unit
ON CHARACTERISTICS				
DC Current Gain ($I_C = 10\text{ mAdc}$, $V_{CE} = 1.0\text{ Vdc}$) ($I_C = 100\text{ mAdc}$, $V_{CE} = 1.0\text{ Vdc}$)	h_{FE}	100 100	— —	—
Collector–Emitter Saturation Voltage ($I_C = 100\text{ mAdc}$, $I_B = 10\text{ mAdc}$)	$V_{CE(sat)}$	—	0.25	Vdc
Base–Emitter On Voltage ($I_C = 100\text{ mAdc}$, $V_{CE} = 1.0\text{ Vdc}$)	$V_{BE(on)}$	—	1.2	Vdc
SMALL–SIGNAL CHARACTERISTICS				
Current–Gain — Bandwidth Product ⁽⁴⁾ ($I_C = 10\text{ mA}$, $V_{CE} = 2.0\text{ V}$, $f = 100\text{ MHz}$)	f_T	100	—	MHz

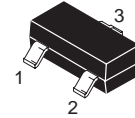
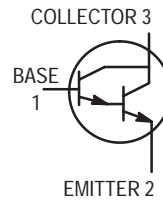
4. f_T is defined as the frequency at which $|h_{fe}|$ extrapolates to unity.

Darlington Amplifier Transistors

NPN Silicon

MMBTA13LT1
MMBTA14LT1*

*Motorola Preferred Device



CASE 318-08, STYLE 6
SOT-23 (TO-236AB)

MAXIMUM RATINGS

Rating	Symbol	Value	Unit
Collector–Emitter Voltage	V_{CES}	30	Vdc
Collector–Base Voltage	V_{CBO}	30	Vdc
Emitter–Base Voltage	V_{EBO}	10	Vdc
Collector Current — Continuous	I_C	300	mAdc

THERMAL CHARACTERISTICS

Characteristic	Symbol	Max	Unit
Total Device Dissipation FR-5 Board ⁽¹⁾ $T_A = 25^\circ\text{C}$ Derate above 25°C	P_D	225	mW
		1.8	mW/ $^\circ\text{C}$
Thermal Resistance Junction to Ambient	$R_{\theta JA}$	556	$^\circ\text{C}/\text{W}$
Total Device Dissipation Alumina Substrate, ⁽²⁾ $T_A = 25^\circ\text{C}$ Derate above 25°C	P_D	300	mW
		2.4	mW/ $^\circ\text{C}$
Thermal Resistance Junction to Ambient	$R_{\theta JA}$	417	$^\circ\text{C}/\text{W}$
Junction and Storage Temperature	T_J, T_{stg}	-55 to +150	$^\circ\text{C}$

DEVICE MARKING

MMBTA13LT1 = 1M; MMBTA14LT1 = 1N

ELECTRICAL CHARACTERISTICS ($T_A = 25^\circ\text{C}$ unless otherwise noted)

Characteristic	Symbol	Min	Max	Unit
----------------	--------	-----	-----	------

OFF CHARACTERISTICS

Collector–Emitter Breakdown Voltage ($I_C = 100 \mu\text{Adc}, V_{BE} = 0$)	$V_{(BR)CES}$	30	—	Vdc
Collector Cutoff Current ($V_{CB} = 30 \text{ Vdc}, I_E = 0$)	I_{CBO}	—	100	nAdc
Emitter Cutoff Current ($V_{EB} = 10 \text{ Vdc}, I_C = 0$)	I_{EBO}	—	100	nAdc

1. FR-5 = $1.0 \times 0.75 \times 0.062$ in.

2. Alumina = $0.4 \times 0.3 \times 0.024$ in. 99.5% alumina.

Preferred devices are Motorola recommended choices for future use and best overall value.

MMBTA13LT1 MMBTA14LT1

ELECTRICAL CHARACTERISTICS (T_A = 25°C unless otherwise noted) (Continued)

Characteristic	Symbol	Min	Max	Unit
ON CHARACTERISTICS(3)				
DC Current Gain (I _C = 10 mA _{dc} , V _{CE} = 5.0 V _{dc})	MMBTA13	5000	—	—
	MMBTA14	10,000	—	—
(I _C = 100 mA _{dc} , V _{CE} = 5.0 V _{dc})	MMBTA13	10,000	—	—
	MMBTA14	20,000	—	—
Collector–Emitter Saturation Voltage (I _C = 100 mA _{dc} , I _B = 0.1 mA _{dc})	V _{CE(sat)}	—	1.5	V _{dc}
Base–Emitter On Voltage (I _C = 100 mA _{dc} , V _{CE} = 5.0 V _{dc})	V _{BE}	—	2.0	V _{dc}

SMALL–SIGNAL CHARACTERISTICS

Current–Gain — Bandwidth Product ⁽⁴⁾ (I _C = 10 mA _{dc} , V _{CE} = 5.0 V _{dc} , f = 100 MHz)	f _T	125	—	MHz
-------------------------------------------------------------------------------------------------------------------------------------------------	----------------	-----	---	-----

3. Pulse Test: Pulse Width ≤ 300 μs, Duty Cycle ≤ 2.0%.

4. f_T = |h_{fe}| • f_{test}.

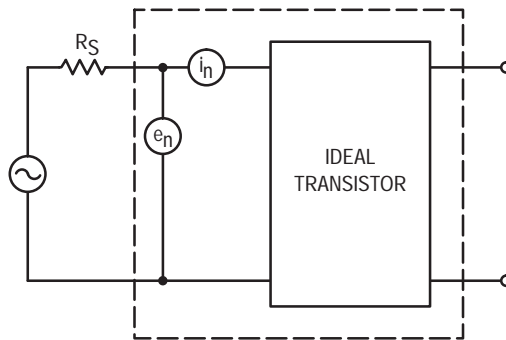


Figure 1. Transistor Noise Model

NOISE CHARACTERISTICS

($V_{CE} = 5.0 \text{ Vdc}$, $T_A = 25^\circ\text{C}$)

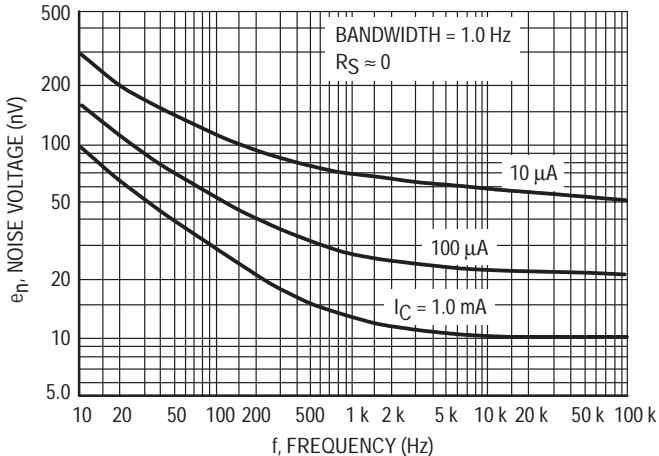


Figure 2. Noise Voltage

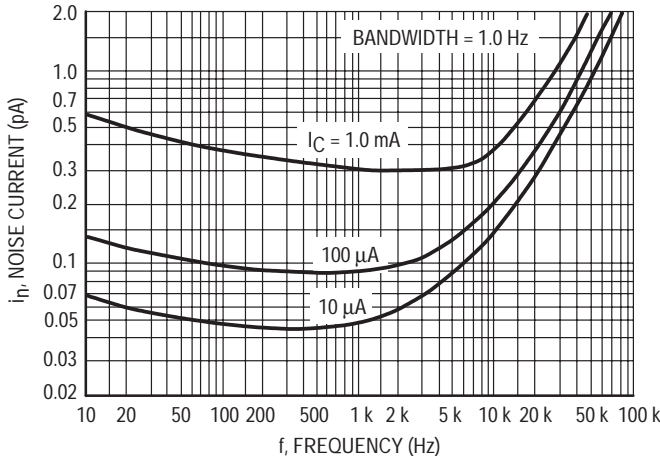


Figure 3. Noise Current

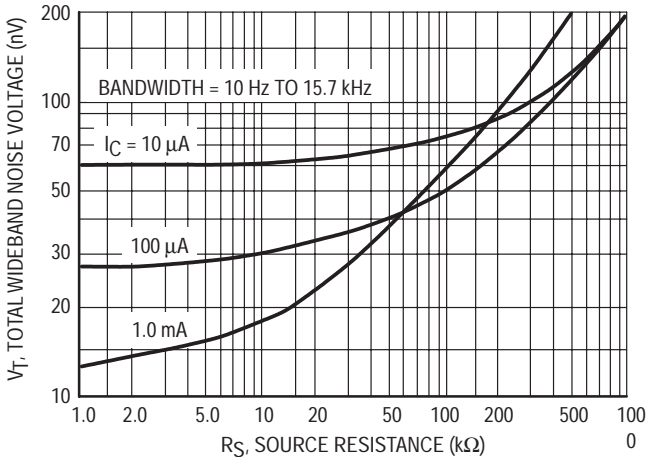


Figure 4. Total Wideband Noise Voltage

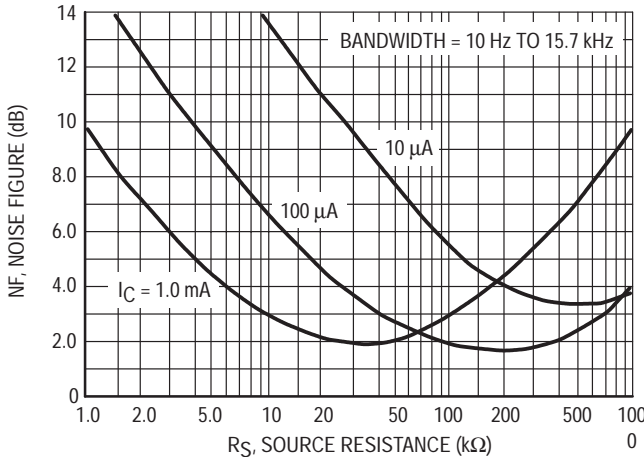


Figure 5. Wideband Noise Figure

SMALL-SIGNAL CHARACTERISTICS

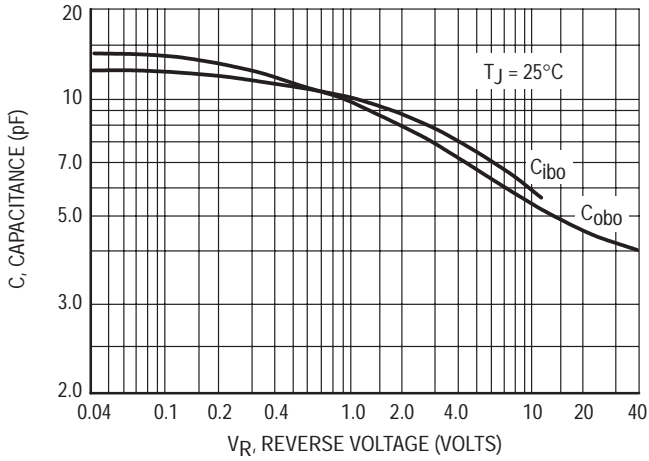


Figure 6. Capacitance

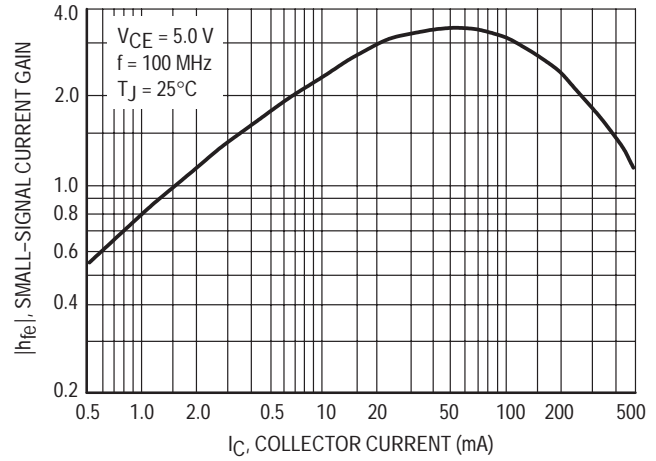


Figure 7. High Frequency Current Gain

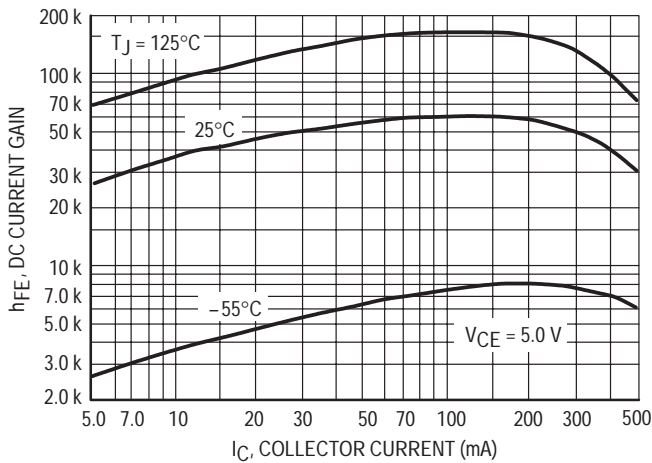


Figure 8. DC Current Gain

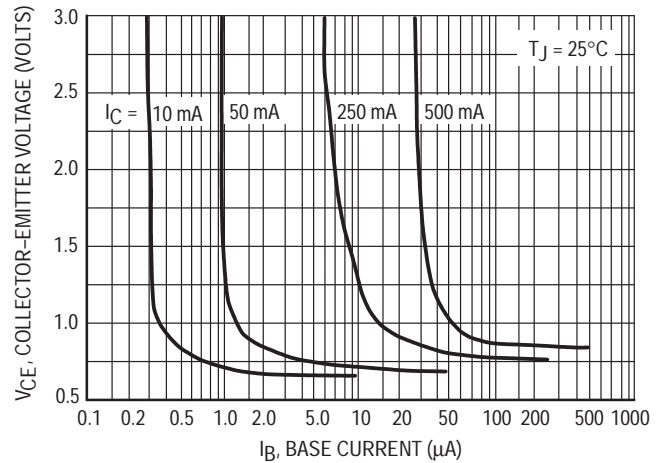


Figure 9. Collector Saturation Region

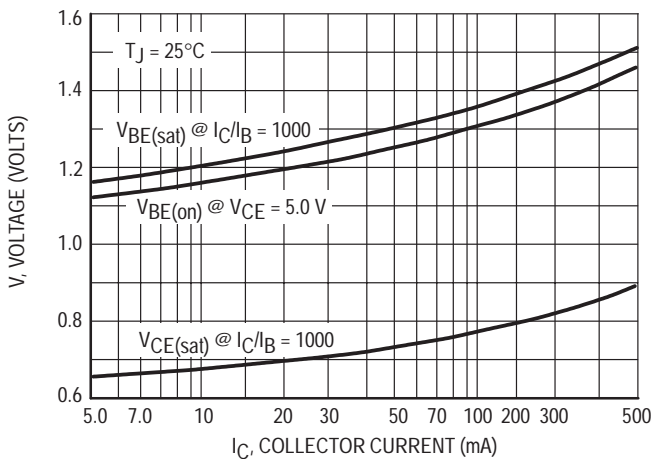


Figure 10. "On" Voltages

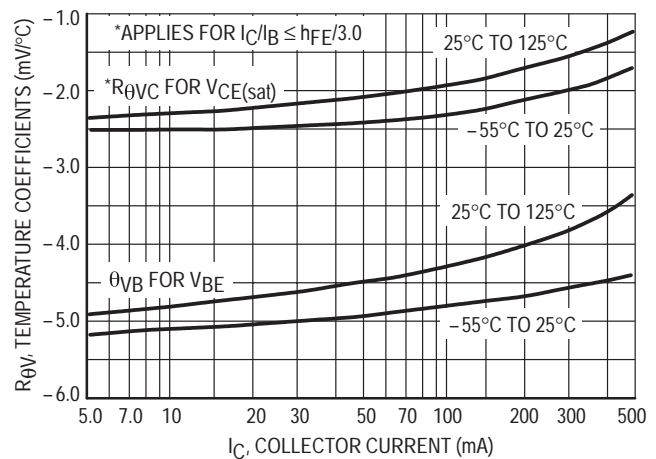


Figure 11. Temperature Coefficients

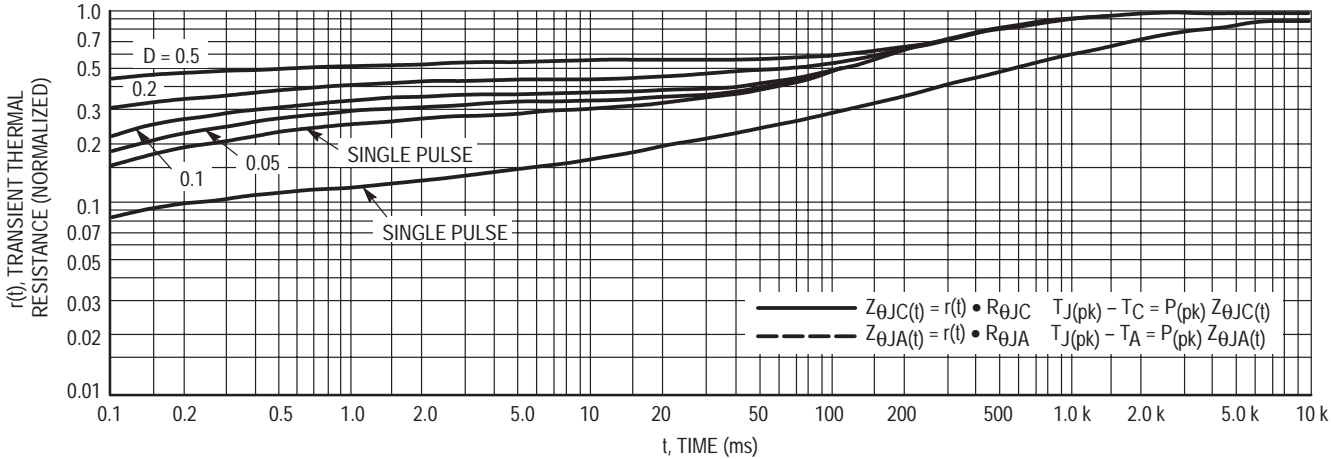


Figure 12. Thermal Response

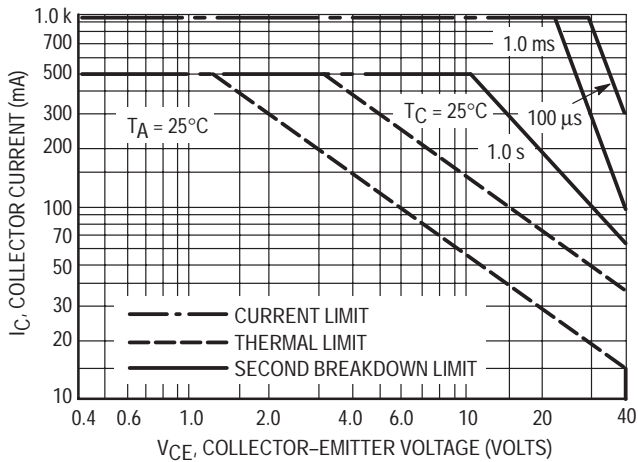
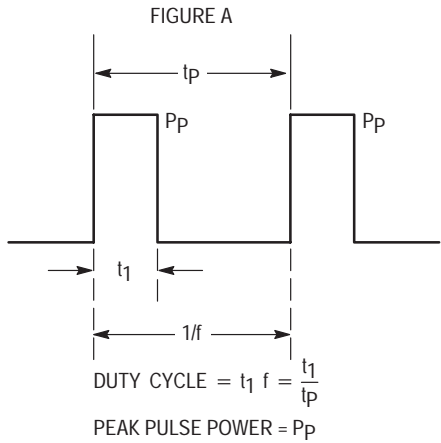


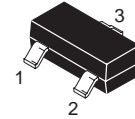
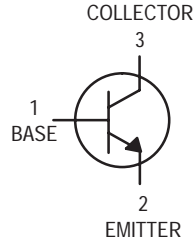
Figure 13. Active Region Safe Operating Area



Design Note: Use of Transient Thermal Resistance Data

General Purpose Amplifier
NPN Silicon

MMBTA20LT1



CASE 318-08, STYLE 6
SOT-23 (TO-236AB)

MAXIMUM RATINGS

Rating	Symbol	Value	Unit
Collector–Emitter Voltage	V_{CEO}	40	Vdc
Emitter–Base Voltage	V_{EBO}	4.0	Vdc
Collector Current — Continuous	I_C	100	mAdc

THERMAL CHARACTERISTICS

Characteristic	Symbol	Max	Unit
Total Device Dissipation FR-5 Board ⁽¹⁾ $T_A = 25^\circ\text{C}$ Derate above 25°C	P_D	225	mW
		1.8	mW/ $^\circ\text{C}$
Thermal Resistance Junction to Ambient	$R_{\theta JA}$	556	$^\circ\text{C}/\text{W}$
Total Device Dissipation Alumina Substrate, ⁽²⁾ $T_A = 25^\circ\text{C}$ Derate above 25°C	P_D	300	mW
		2.4	mW/ $^\circ\text{C}$
Thermal Resistance Junction to Ambient	$R_{\theta JA}$	417	$^\circ\text{C}/\text{W}$
Junction and Storage Temperature	T_J, T_{stg}	-55 to +150	$^\circ\text{C}$

DEVICE MARKING

MMBTA20LT1 = 1C

ELECTRICAL CHARACTERISTICS ($T_A = 25^\circ\text{C}$ unless otherwise noted)

Characteristic	Symbol	Min	Max	Unit
----------------	--------	-----	-----	------

OFF CHARACTERISTICS

Collector–Emitter Breakdown Voltage ($I_C = 1.0 \text{ mAdc}, I_B = 0$)	$V_{(BR)CEO}$	40	—	Vdc
Emitter–Base Breakdown Voltage ($I_E = 100 \mu\text{Adc}, I_C = 0$)	$V_{(BR)EBO}$	4.0	—	Vdc
Collector Cutoff Current ($V_{CB} = 30 \text{ Vdc}, I_E = 0$)	I_{CBO}	—	100	nAdc

1. FR-5 = $1.0 \times 0.75 \times 0.062 \text{ in.}$

2. Alumina = $0.4 \times 0.3 \times 0.024 \text{ in.}$ 99.5% alumina.

ELECTRICAL CHARACTERISTICS ($T_A = 25^\circ\text{C}$ unless otherwise noted) (Continued)

Characteristic	Symbol	Min	Max	Unit
ON CHARACTERISTICS				
DC Current Gain ($I_C = 5.0\text{ mAdc}$, $V_{CE} = 10\text{ Vdc}$)	h_{FE}	40	400	—
Collector–Emitter Saturation Voltage ($I_C = 10\text{ mAdc}$, $I_B = 1.0\text{ mAdc}$)	$V_{CE(sat)}$	—	0.25	Vdc
SMALL–SIGNAL CHARACTERISTICS				
Current–Gain — Bandwidth Product ($I_C = 5.0\text{ mAdc}$, $V_{CE} = 10\text{ Vdc}$, $f = 100\text{ MHz}$)	f_T	125	—	MHz
Output Capacitance ($V_{CB} = 10\text{ Vdc}$, $I_E = 0$, $f = 1.0\text{ MHz}$)	C_{obo}	—	4.0	pF

EQUIVALENT SWITCHING TIME TEST CIRCUITS

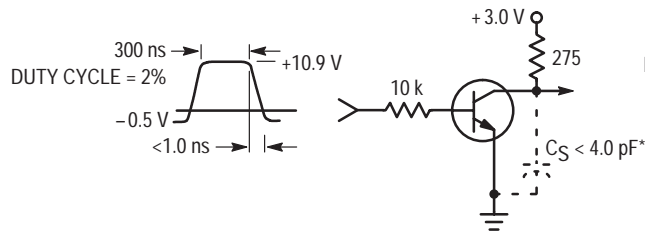


Figure 1. Turn–On Time

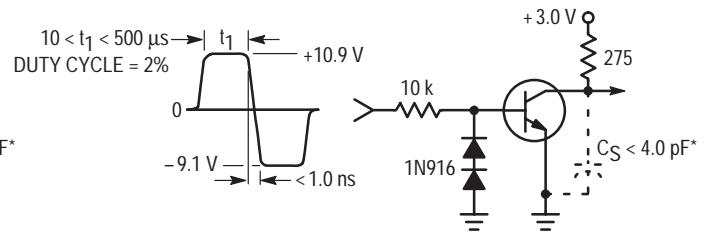


Figure 2. Turn–Off Time

*Total shunt capacitance of test jig and connectors

TYPICAL NOISE CHARACTERISTICS

($V_{CE} = 5.0 \text{ Vdc}$, $T_A = 25^\circ\text{C}$)

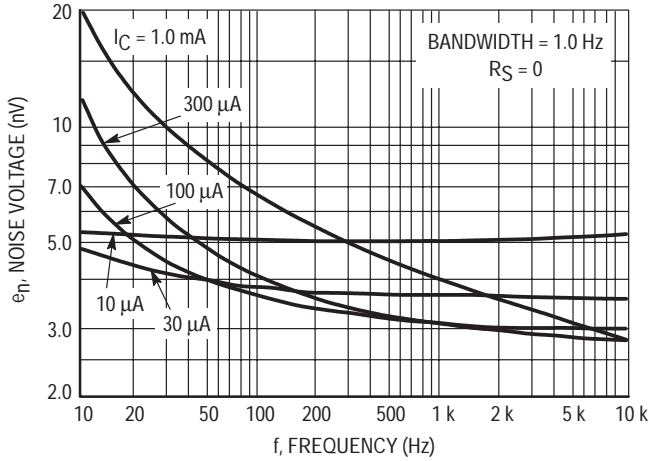


Figure 3. Noise Voltage

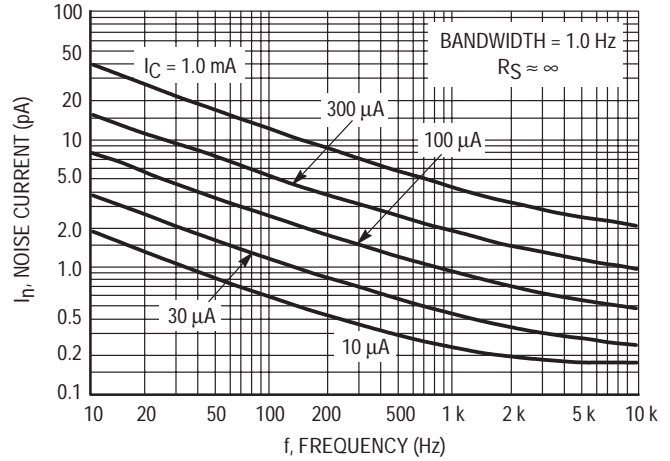


Figure 4. Noise Current

NOISE FIGURE CONTOURS

($V_{CE} = 5.0 \text{ Vdc}$, $T_A = 25^\circ\text{C}$)

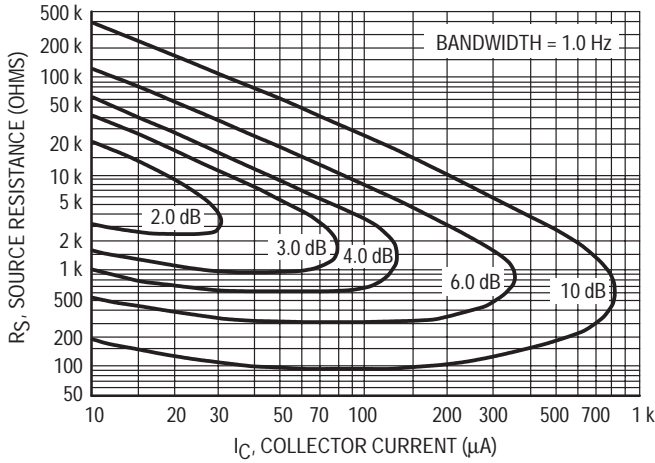


Figure 5. Narrow Band, 100 Hz

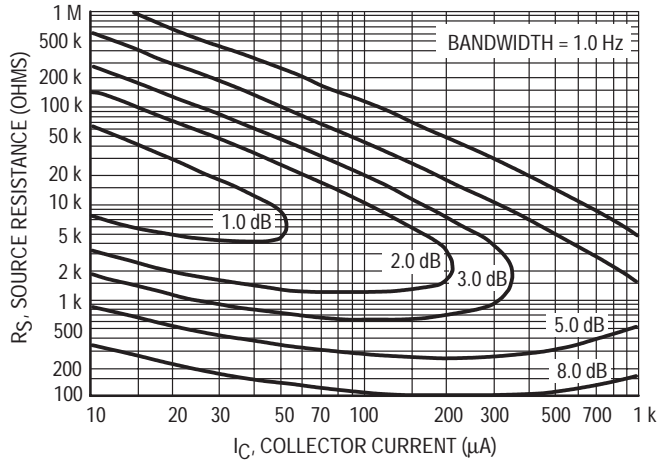


Figure 6. Narrow Band, 1.0 kHz

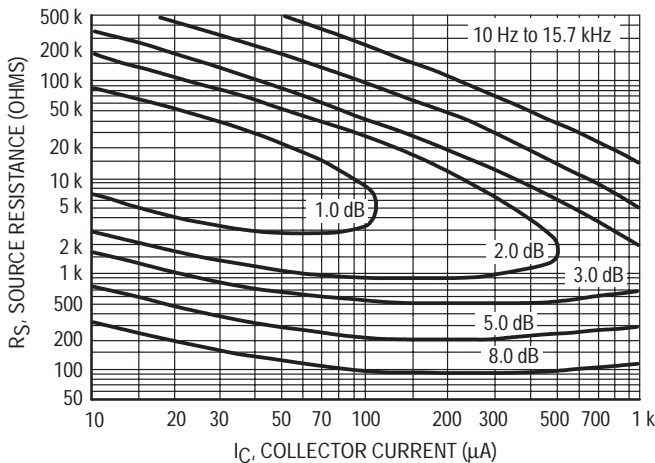


Figure 7. Wideband

Noise Figure is defined as:

$$NF = 20 \log_{10} \left(\frac{e_n^2 + 4KTR_S + I_n^2 R_S^2}{4KTR_S} \right)^{1/2}$$

e_n = Noise Voltage of the Transistor referred to the input. (Figure 3)

I_n = Noise Current of the Transistor referred to the input. (Figure 4)

K = Boltzman's Constant ($1.38 \times 10^{-23} \text{ J}/^\circ\text{K}$)

T = Temperature of the Source Resistance ($^\circ\text{K}$)

R_S = Source Resistance (Ohms)

TYPICAL STATIC CHARACTERISTICS

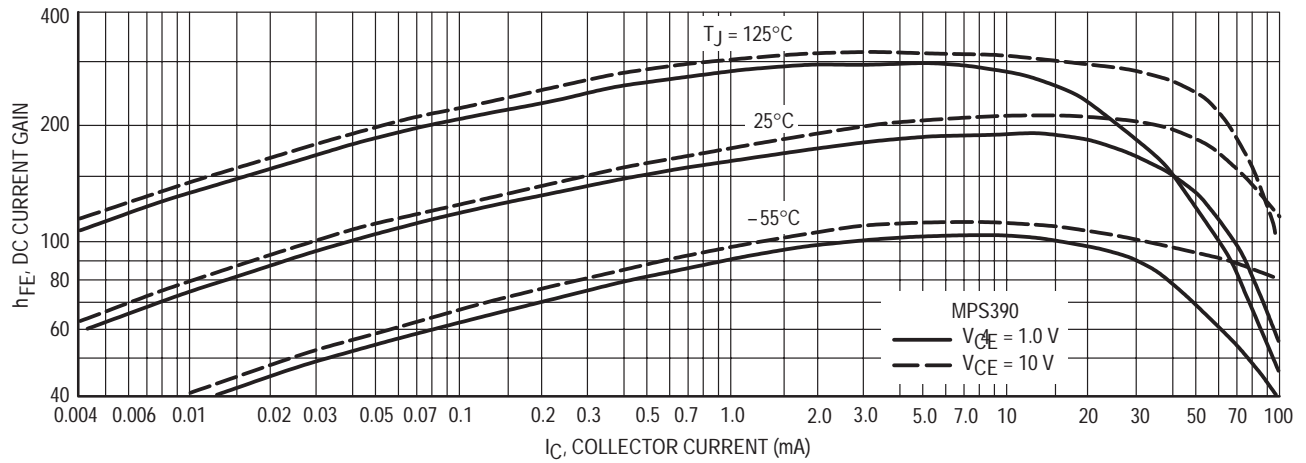


Figure 8. DC Current Gain

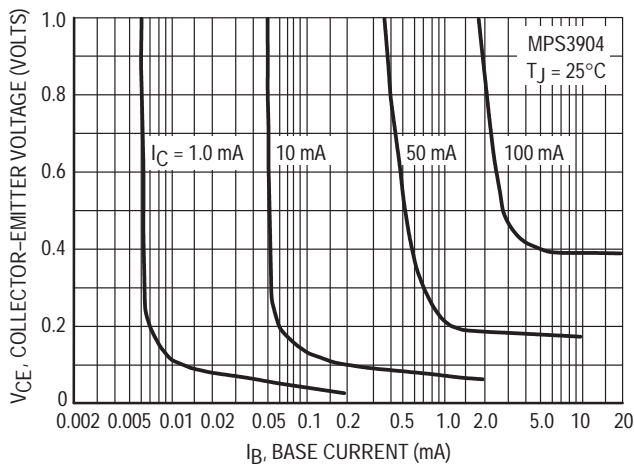


Figure 9. Collector Saturation Region

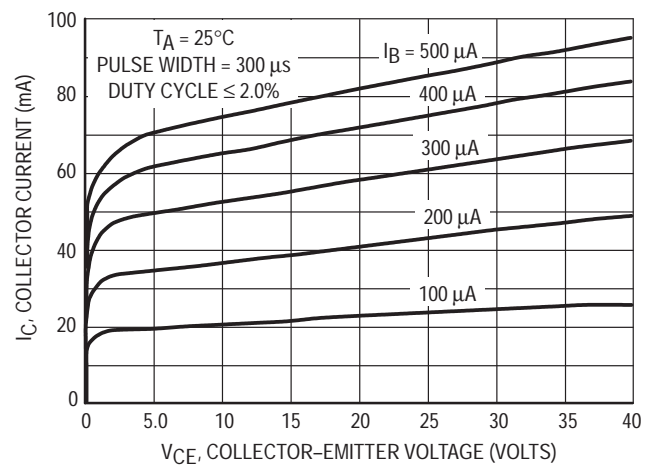


Figure 10. Collector Characteristics

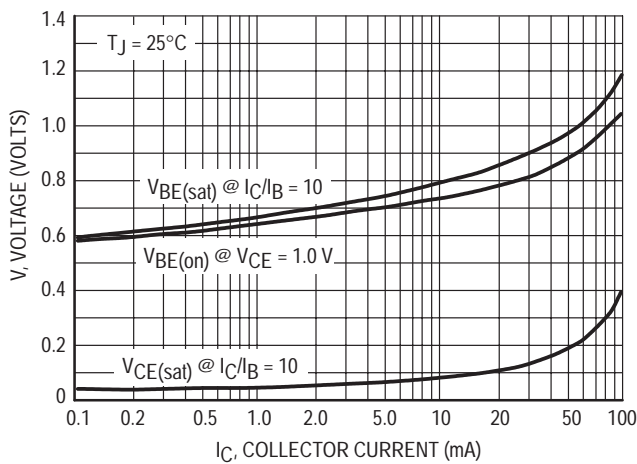


Figure 11. "On" Voltages

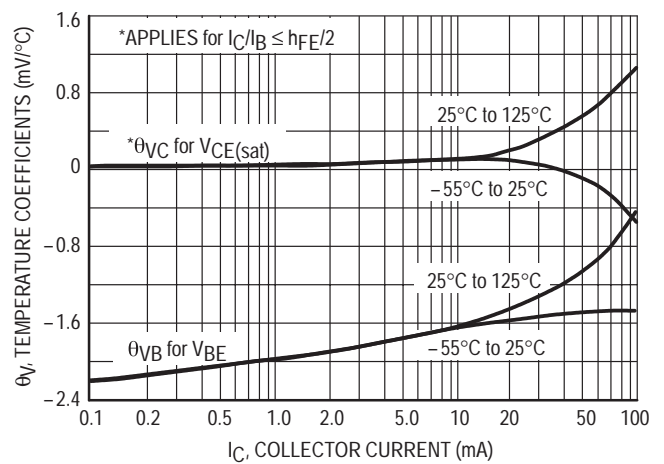


Figure 12. Temperature Coefficients

TYPICAL DYNAMIC CHARACTERISTICS

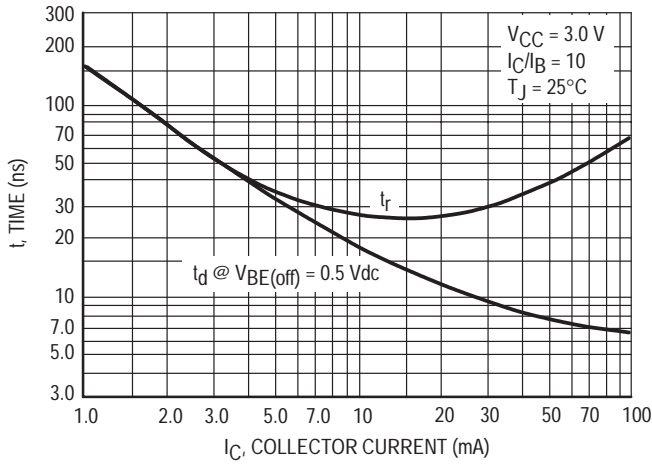


Figure 13. Turn-On Time

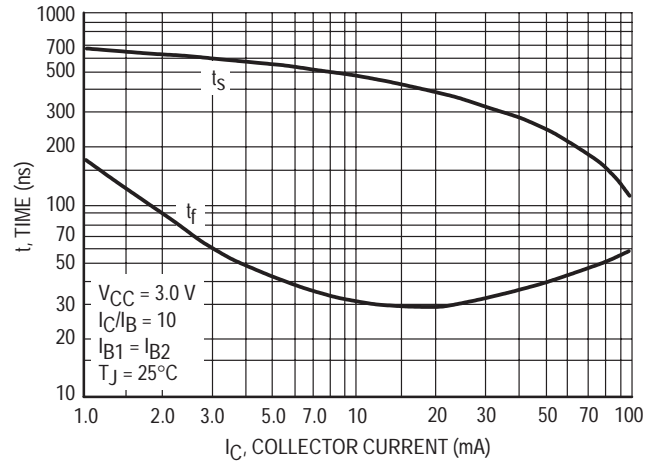


Figure 14. Turn-Off Time

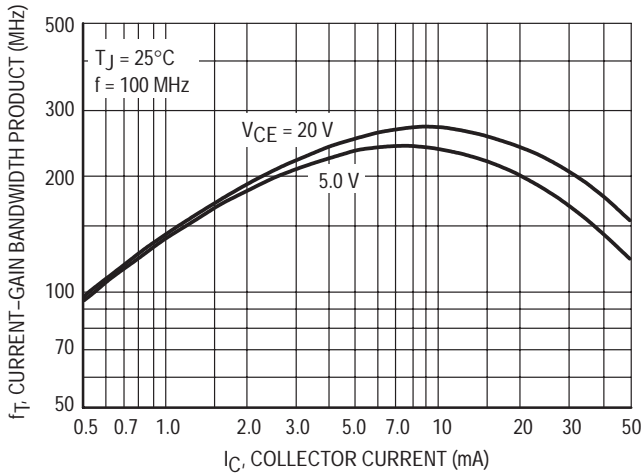


Figure 15. Current-Gain — Bandwidth Product

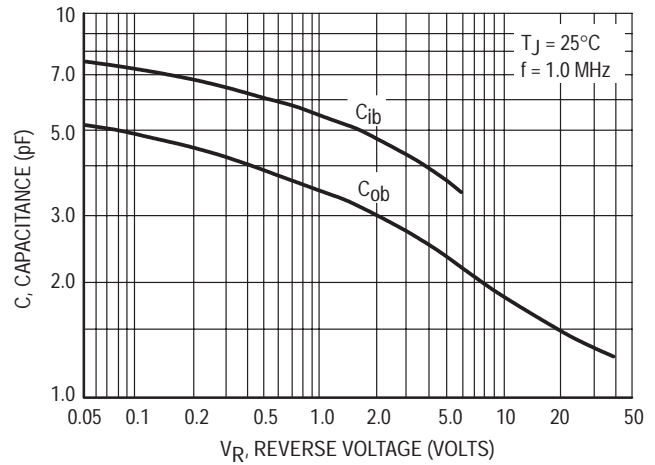


Figure 16. Capacitance

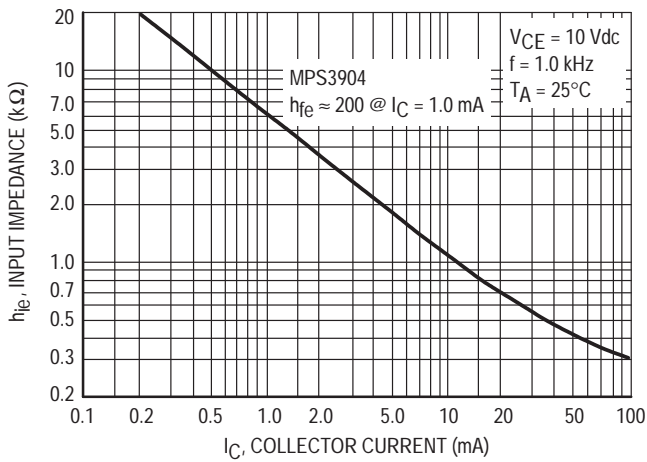


Figure 17. Input Impedance

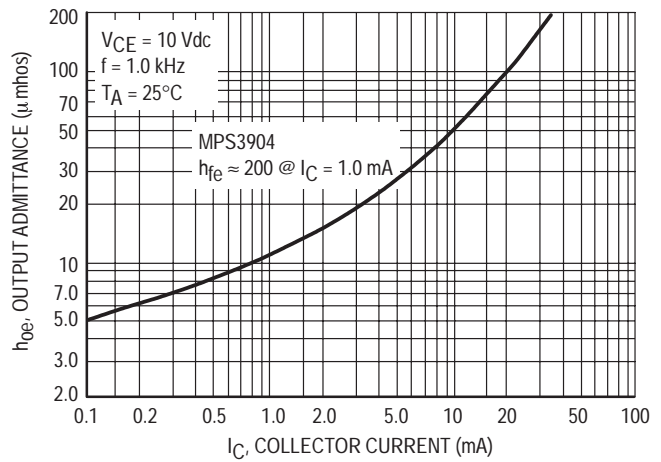


Figure 18. Output Admittance

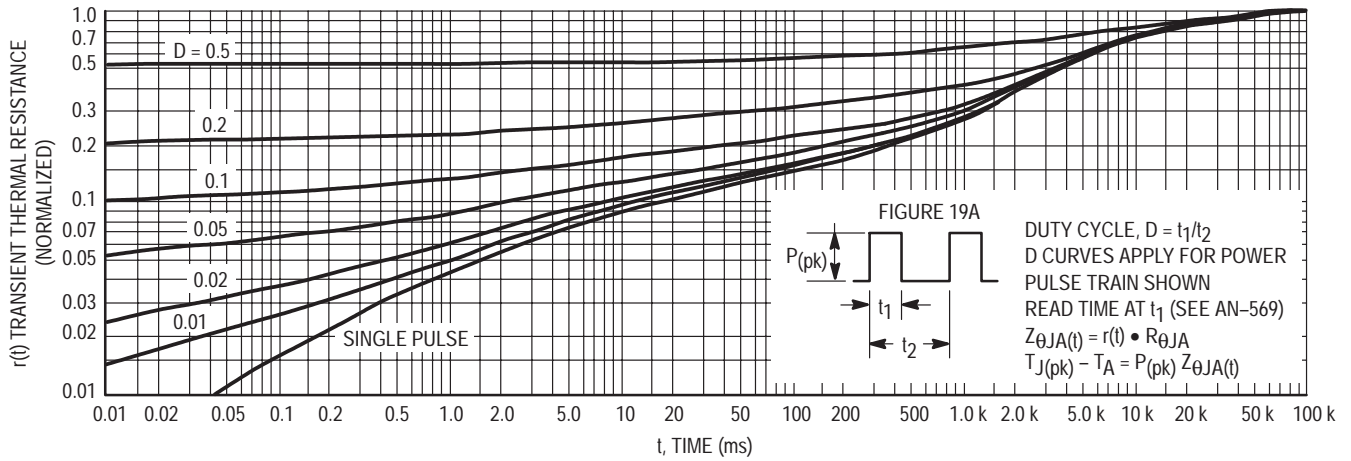


Figure 19. Thermal Response

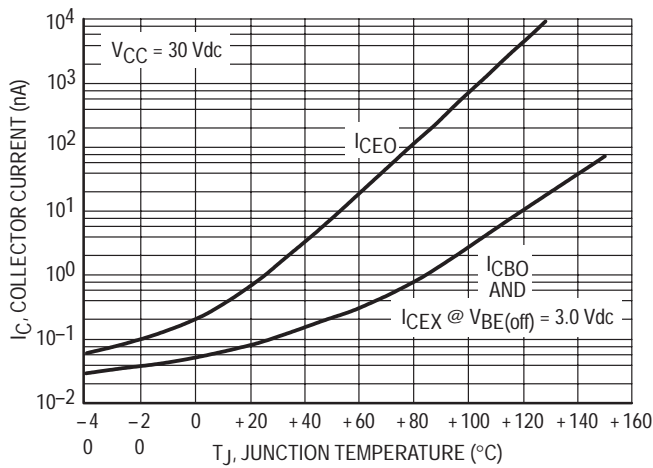


Figure 19A.

DESIGN NOTE: USE OF THERMAL RESPONSE DATA

A train of periodical power pulses can be represented by the model as shown in Figure 19A. Using the model and the device thermal response the normalized effective transient thermal resistance of Figure 19 was calculated for various duty cycles.

To find $Z_{\theta JA}(t)$, multiply the value obtained from Figure 19 by the steady state value $R_{\theta JA}$.

Example:

The MPS3904 is dissipating 2.0 watts peak under the following conditions:

$t_1 = 1.0$ ms, $t_2 = 5.0$ ms. ($D = 0.2$)

Using Figure 19 at a pulse width of 1.0 ms and $D = 0.2$, the reading of $r(t)$ is 0.22.

The peak rise in junction temperature is therefore

$\Delta T = r(t) \times P_{(pk)} \times R_{\theta JA} = 0.22 \times 2.0 \times 200 = 88^\circ\text{C}$.

For more information, see AN-569.

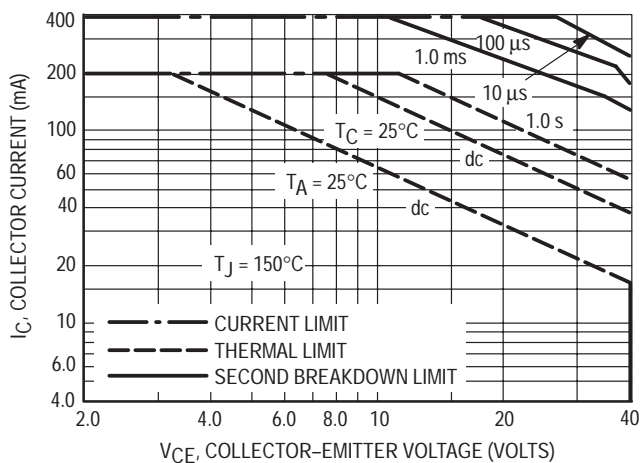


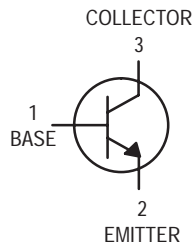
Figure 20.

The safe operating area curves indicate I_C - V_{CE} limits of the transistor that must be observed for reliable operation. Collector load lines for specific circuits must fall below the limits indicated by the applicable curve.

The data of Figure 20 is based upon $T_{J(pk)} = 150^\circ\text{C}$; T_C or T_A is variable depending upon conditions. Pulse curves are valid for duty cycles to 10% provided $T_{J(pk)} \leq 150^\circ\text{C}$. $T_{J(pk)}$ may be calculated from the data in Figure 19. At high case or ambient temperatures, thermal limitations will reduce the power that can be handled to values less than the limitations imposed by second breakdown.

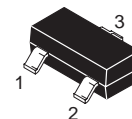
High Voltage Transistors

NPN Silicon



MMBTA42LT1*
MMBTA43LT1

*Motorola Preferred Device



CASE 318-08, STYLE 6
SOT-23 (TO-236AB)

MAXIMUM RATINGS

Rating	Symbol	MMBTA42	MMBTA43	Unit
Collector-Emitter Voltage	V_{CEO}	300	200	Vdc
Collector-Base Voltage	V_{CBO}	300	200	Vdc
Emitter-Base Voltage	V_{EBO}	6.0	6.0	Vdc
Collector Current — Continuous	I_C	500		mAdc

DEVICE MARKING

MMBTA42LT1 = 1D; MMBTA43LT1 = M1E

THERMAL CHARACTERISTICS

Characteristic	Symbol	Max	Unit
Total Device Dissipation FR-5 Board, ⁽¹⁾ $T_A = 25^\circ\text{C}$ Derate above 25°C	P_D	225	mW
		1.8	mW/ $^\circ\text{C}$
Thermal Resistance, Junction to Ambient	$R_{\theta JA}$	556	$^\circ\text{C}/\text{W}$
Total Device Dissipation Alumina Substrate, ⁽²⁾ $T_A = 25^\circ\text{C}$ Derate above 25°C	P_D	300	mW
		2.4	mW/ $^\circ\text{C}$
Thermal Resistance, Junction to Ambient	$R_{\theta JA}$	417	$^\circ\text{C}/\text{W}$
Junction and Storage Temperature	T_J, T_{stg}	-55 to +150	$^\circ\text{C}$

ELECTRICAL CHARACTERISTICS ($T_A = 25^\circ\text{C}$ unless otherwise noted)

Characteristic	Symbol	Min	Max	Unit
----------------	--------	-----	-----	------

OFF CHARACTERISTICS

Collector-Emitter Breakdown Voltage ⁽³⁾ ($I_C = 1.0 \text{ mAdc}$, $I_B = 0$)	MMBTA42 MMBTA43	$V_{(BR)CEO}$	300 200	—	Vdc
Collector-Base Breakdown Voltage ($I_C = 100 \mu\text{Adc}$, $I_E = 0$)	MMBTA42 MMBTA43	$V_{(BR)CBO}$	300 200	—	Vdc
Emitter-Base Breakdown Voltage ($I_E = 100 \mu\text{Adc}$, $I_C = 0$)		$V_{(BR)EBO}$	6.0	—	Vdc
Collector Cutoff Current ($V_{CB} = 200 \text{ Vdc}$, $I_E = 0$) ($V_{CB} = 160 \text{ Vdc}$, $I_E = 0$)	MMBTA42 MMBTA43	I_{CBO}	— —	0.1 0.1	μAdc
Emitter Cutoff Current ($V_{EB} = 6.0 \text{ Vdc}$, $I_C = 0$) ($V_{EB} = 4.0 \text{ Vdc}$, $I_C = 0$)	MMBTA42 MMBTA43	I_{EBO}	— —	0.1 0.1	μAdc

1. FR-5 = 1.0 x 0.75 x 0.062 in.

2. Alumina = 0.4 x 0.3 x 0.024 in. 99.5% alumina.

3. Pulse Test: Pulse Width $\leq 300 \mu\text{s}$, Duty Cycle $\leq 2.0\%$.

Preferred devices are Motorola recommended choices for future use and best overall value.

ELECTRICAL CHARACTERISTICS ($T_A = 25^\circ\text{C}$ unless otherwise noted) (Continued)

Characteristic		Symbol	Min	Max	Unit
ON CHARACTERISTICS⁽³⁾					
DC Current Gain ($I_C = 1.0\text{ mAdc}$, $V_{CE} = 10\text{ Vdc}$) ($I_C = 10\text{ mAdc}$, $V_{CE} = 10\text{ Vdc}$) ($I_C = 30\text{ mAdc}$, $V_{CE} = 10\text{ Vdc}$)	Both Types	h_{FE}	25	—	—
	Both Types		40	—	
	MMBTA42 MMBTA43	40	—	—	
		40	—		
Collector–Emitter Saturation Voltage ($I_C = 20\text{ mAdc}$, $I_B = 2.0\text{ mAdc}$)	MMBTA42 MMBTA43	$V_{CE(sat)}$	— —	0.5 0.5	Vdc
Base–Emitter Saturation Voltage ($I_C = 20\text{ mAdc}$, $I_B = 2.0\text{ mAdc}$)		$V_{BE(sat)}$	—	0.9	Vdc
SMALL–SIGNAL CHARACTERISTICS					
Current–Gain — Bandwidth Product ($I_C = 10\text{ mAdc}$, $V_{CE} = 20\text{ Vdc}$, $f = 100\text{ MHz}$)		f_T	50	—	MHz
Collector–Base Capacitance ($V_{CB} = 20\text{ Vdc}$, $I_E = 0$, $f = 1.0\text{ MHz}$)	MMBTA42 MMBTA43	C_{cb}	—	3.0	pF
			—	4.0	

3. Pulse Test: Pulse Width $\leq 300\ \mu\text{s}$, Duty Cycle $\leq 2.0\%$.

MMBTA42LT1 MMBTA43LT1

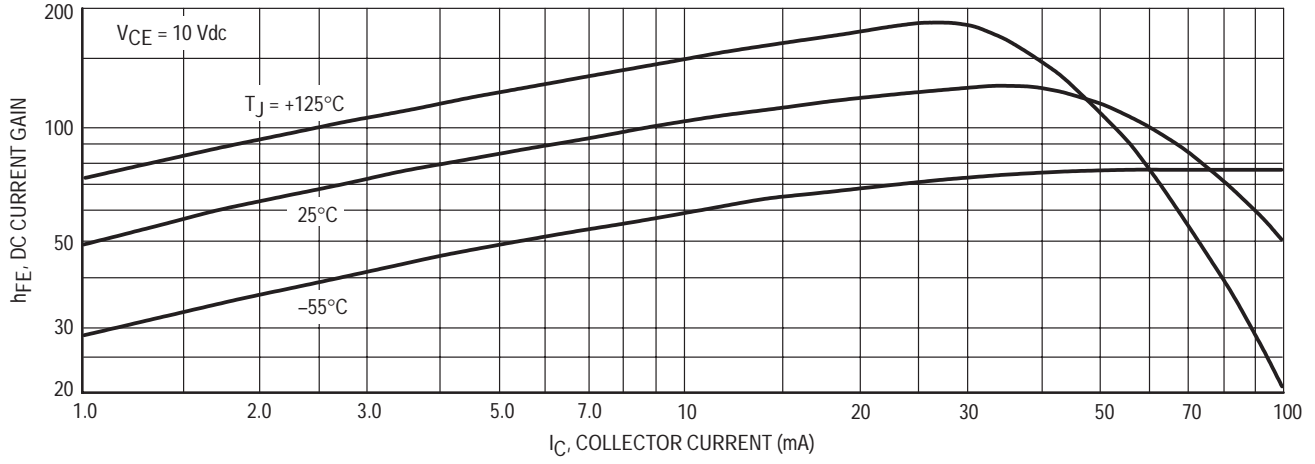


Figure 1. DC Current Gain

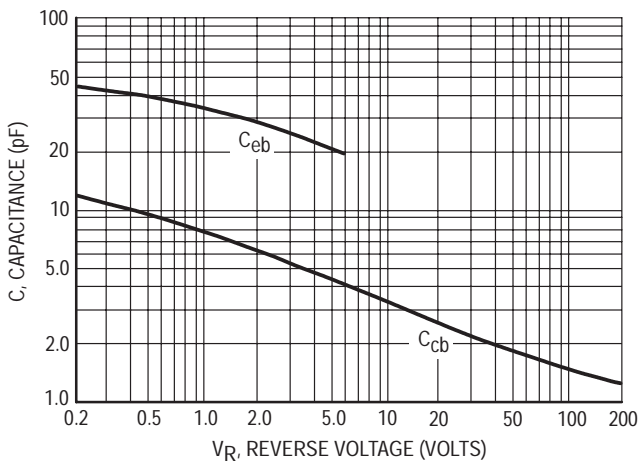


Figure 2. Capacitances

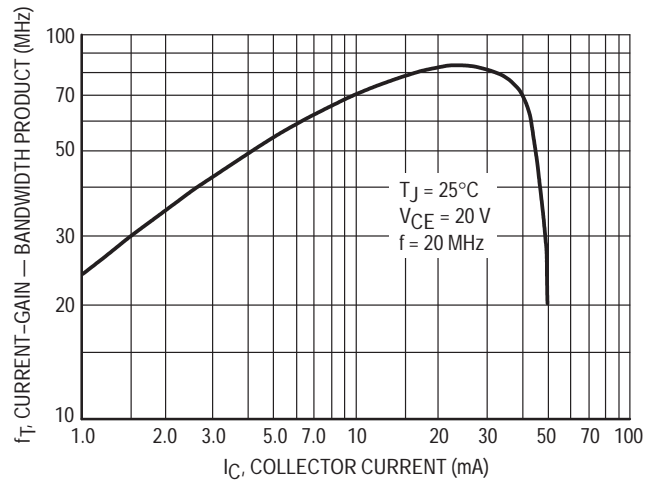


Figure 3. Current-Gain — Bandwidth Product

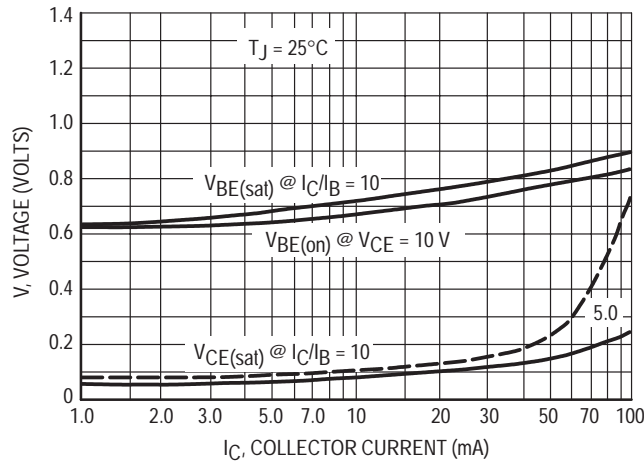
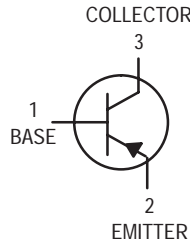


Figure 4. "On" Voltages

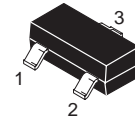
Driver Transistors

PNP Silicon



MMBTA55LT1 MMBTA56LT1*

*Motorola Preferred Device



CASE 318-08, STYLE 6
SOT-23 (TO-236AB)

MAXIMUM RATINGS

Rating	Symbol	MMBTA55	MMBTA56	Unit
Collector–Emitter Voltage	V_{CEO}	-60	-80	Vdc
Collector–Base Voltage	V_{CBO}	-60	-80	Vdc
Emitter–Base Voltage	V_{EBO}	-4.0		Vdc
Collector Current — Continuous	I_C	-500		mAdc

DEVICE MARKING

MMBTA55LT1 = 2H; MMBTA56LT1 = 2GM

THERMAL CHARACTERISTICS

Characteristic	Symbol	Max	Unit
Total Device Dissipation FR-5 Board, ⁽¹⁾ $T_A = 25^\circ\text{C}$ Derate above 25°C	P_D	225	mW
		1.8	mW/ $^\circ\text{C}$
Thermal Resistance, Junction to Ambient	$R_{\theta JA}$	556	$^\circ\text{C}/\text{W}$
Total Device Dissipation Alumina Substrate, ⁽²⁾ $T_A = 25^\circ\text{C}$ Derate above 25°C	P_D	300	mW
		2.4	mW/ $^\circ\text{C}$
Thermal Resistance, Junction to Ambient	$R_{\theta JA}$	417	$^\circ\text{C}/\text{W}$
Junction and Storage Temperature	T_J, T_{stg}	-55 to +150	$^\circ\text{C}$

ELECTRICAL CHARACTERISTICS ($T_A = 25^\circ\text{C}$ unless otherwise noted)

Characteristic	Symbol	Min	Max	Unit
----------------	--------	-----	-----	------

OFF CHARACTERISTICS

Collector–Emitter Breakdown Voltage ⁽³⁾ ($I_C = -1.0$ mAdc, $I_B = 0$)	MMBTA55 MMBTA56	$V_{(BR)CEO}$	-60 -80	—	Vdc
Emitter–Base Breakdown Voltage ($I_E = -100$ μ Adc, $I_C = 0$)		$V_{(BR)EBO}$	-4.0	—	Vdc
Collector Cutoff Current ($V_{CE} = -60$ Vdc, $I_B = 0$)		I_{CES}	—	-0.1	μ Adc
Collector Cutoff Current ($V_{CB} = -60$ Vdc, $I_E = 0$) ($V_{CB} = -80$ Vdc, $I_E = 0$)	MMBTA55 MMBTA56	I_{CBO}	—	-0.1 -0.1	μ Adc

ON CHARACTERISTICS

DC Current Gain ($I_C = -10$ mAdc, $V_{CE} = -1.0$ Vdc) ($I_C = -100$ mAdc, $V_{CE} = -1.0$ Vdc)	h_{FE}	100 100	—	—	—
Collector–Emitter Saturation Voltage ($I_C = -100$ mAdc, $I_B = -10$ mAdc)	$V_{CE(sat)}$	—	-0.25	—	Vdc
Base–Emitter On Voltage ($I_C = -100$ mAdc, $V_{CE} = -1.0$ Vdc)	$V_{BE(on)}$	—	-1.2	—	Vdc

SMALL-SIGNAL CHARACTERISTICS

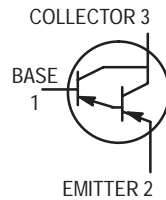
Current–Gain — Bandwidth Product ⁽⁴⁾ ($I_C = -100$ mAdc, $V_{CE} = -1.0$ Vdc, $f = 100$ MHz)	f_T	50	—	—	MHz
-------------------------------------------------------------------------------------------------------------	-------	----	---	---	-----

- FR-5 = 1.0 x 0.75 x 0.062 in.
- Alumina = 0.4 x 0.3 x 0.024 in. 99.5% alumina.
- Pulse Test: Pulse Width ≤ 300 μ s, Duty Cycle $\leq 2.0\%$.
- f_T is defined as the frequency at which $|h_{fe}|$ extrapolates to unity.

Preferred devices are Motorola recommended choices for future use and best overall value.

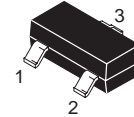
Darlington Transistors

PNP Silicon



MMBTA63LT1
MMBTA64LT1*

*Motorola Preferred Device



CASE 318-08, STYLE 6
SOT-23 (TO-236AB)

MAXIMUM RATINGS

Rating	Symbol	Value	Unit
Collector-Emitter Voltage	V_{CES}	-30	Vdc
Collector-Base Voltage	V_{CBO}	-30	Vdc
Emitter-Base Voltage	V_{EBO}	-10	Vdc
Collector Current — Continuous	I_C	-500	mAdc

DEVICE MARKING

MMBTA63LT1 = 2U; MMBTA64LT1 = 2V

THERMAL CHARACTERISTICS

Characteristic	Symbol	Max	Unit
Total Device Dissipation FR-5 Board, ⁽¹⁾ $T_A = 25^\circ\text{C}$ Derate above 25°C	P_D	225	mW
		1.8	mW/ $^\circ\text{C}$
Thermal Resistance, Junction to Ambient	$R_{\theta JA}$	556	$^\circ\text{C}/\text{W}$
Total Device Dissipation Alumina Substrate, ⁽²⁾ $T_A = 25^\circ\text{C}$ Derate above 25°C	P_D	300	mW
		2.4	mW/ $^\circ\text{C}$
Thermal Resistance, Junction to Ambient	$R_{\theta JA}$	417	$^\circ\text{C}/\text{W}$
Junction and Storage Temperature	T_J, T_{stg}	-55 to +150	$^\circ\text{C}$

ELECTRICAL CHARACTERISTICS ($T_A = 25^\circ\text{C}$ unless otherwise noted)

Characteristic	Symbol	Min	Max	Unit
----------------	--------	-----	-----	------

OFF CHARACTERISTICS

Collector-Emitter Breakdown Voltage ($I_C = -100 \mu\text{Adc}$)	$V_{(BR)CEO}$	-30	—	Vdc
Collector Cutoff Current ($V_{CB} = -30 \text{ Vdc}$)	I_{CBO}	—	-100	nAdc
Emitter Cutoff Current ($V_{EB} = -10 \text{ Vdc}$)	I_{EBO}	—	-100	nAdc

ON CHARACTERISTICS

DC Current Gain ⁽³⁾ ($I_C = -10 \text{ mAdc}, V_{CE} = -5.0 \text{ Vdc}$) ($I_C = -10 \text{ mAdc}, V_{CE} = -5.0 \text{ Vdc}$) ($I_C = -100 \text{ mAdc}, V_{CE} = -5.0 \text{ Vdc}$) ($I_C = -100 \text{ mAdc}, V_{CE} = -5.0 \text{ Vdc}$)	MMBTA63 MMBTA64 MMBTA63 MMBTA64	h_{FE}	5,000 10,000 10,000 20,000	— — — —	—
Collector-Emitter Saturation Voltage ($I_C = -100 \text{ mAdc}, I_B = -0.1 \text{ mAdc}$)		$V_{CE(sat)}$	—	-1.5	Vdc
Base-Emitter On Voltage ($I_C = -100 \text{ mAdc}, V_{CE} = -5.0 \text{ Vdc}$)		$V_{BE(on)}$	—	-2.0	Vdc

SMALL-SIGNAL CHARACTERISTICS

Current-Gain — Bandwidth Product ($I_C = -10 \text{ mAdc}, V_{CE} = -5.0 \text{ Vdc}, f = 100 \text{ MHz}$)	f_T	125	—	MHz
---------------------------------------------------------------------------------------------------------------	-------	-----	---	-----

- FR-5 = 1.0 x 0.75 x 0.062 in.
- Alumina = 0.4 x 0.3 x 0.024 in. 99.5% alumina.
- Pulse Test: Pulse Width $\leq 300 \mu\text{s}$, Duty Cycle $\leq 2.0\%$.

Preferred devices are Motorola recommended choices for future use and best overall value.

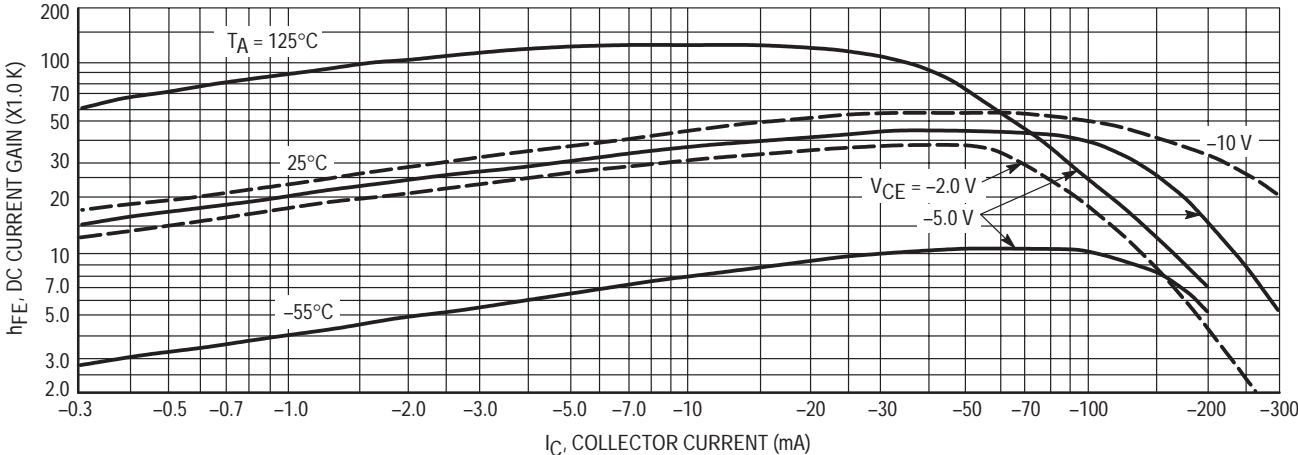


Figure 1. DC Current Gain

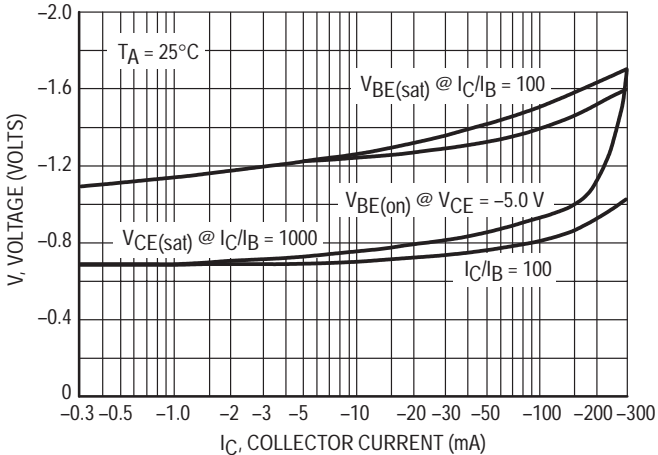


Figure 2. "On" Voltage

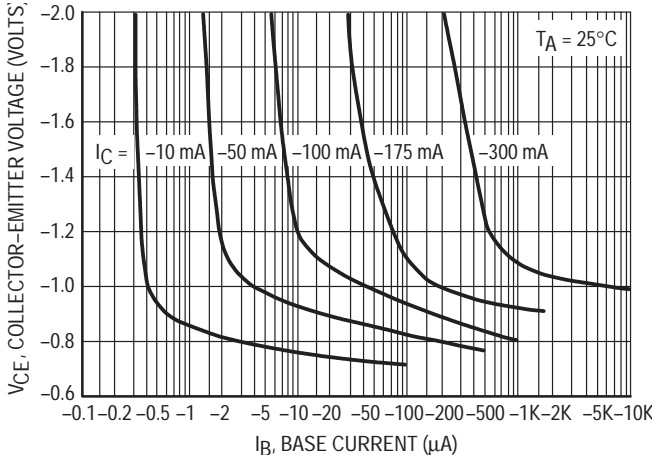


Figure 3. Collector Saturation Region

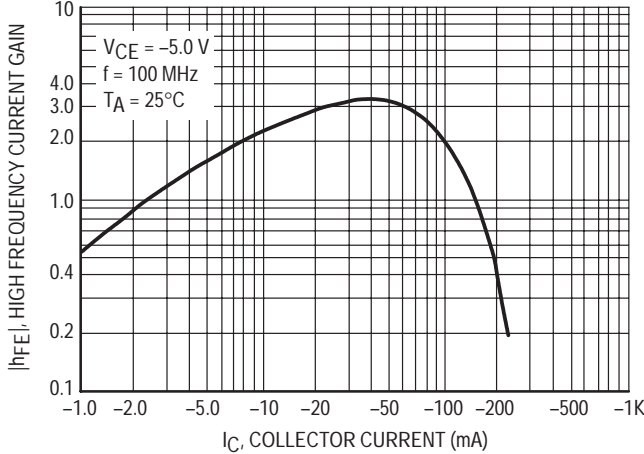
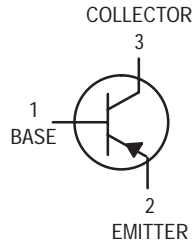


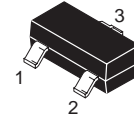
Figure 4. High Frequency Current Gain

General Purpose Transistor

PNP Silicon



MMBTA70LT1



CASE 318-08, STYLE 6
SOT-23 (TO-236AB)

MAXIMUM RATINGS

Rating	Symbol	Value	Unit
Collector-Emitter Voltage	V_{CEO}	-40	Vdc
Emitter-Base Voltage	V_{EBO}	-4.0	Vdc
Collector Current — Continuous	I_C	-100	mAdc

DEVICE MARKING

MMBTA70LT1 = M2C

THERMAL CHARACTERISTICS

Characteristic	Symbol	Max	Unit
Total Device Dissipation FR-5 Board, ⁽¹⁾ $T_A = 25^\circ\text{C}$ Derate above 25°C	P_D	225	mW
Thermal Resistance, Junction to Ambient	$R_{\theta JA}$	1.8	$\text{mW}/^\circ\text{C}$
Total Device Dissipation Alumina Substrate, ⁽²⁾ $T_A = 25^\circ\text{C}$ Derate above 25°C	P_D	300	mW
Thermal Resistance, Junction to Ambient	$R_{\theta JA}$	2.4	$\text{mW}/^\circ\text{C}$
Junction and Storage Temperature	T_J, T_{stg}	-55 to +150	$^\circ\text{C}$

ELECTRICAL CHARACTERISTICS ($T_A = 25^\circ\text{C}$ unless otherwise noted)

Characteristic	Symbol	Min	Max	Unit
----------------	--------	-----	-----	------

OFF CHARACTERISTICS

Collector-Emitter Breakdown Voltage ($I_C = -1.0 \text{ mAdc}, I_B = 0$)	$V_{(BR)CEO}$	-40	—	Vdc
Emitter-Base Breakdown Voltage ($I_E = -100 \mu\text{Adc}, I_C = 0$)	$V_{(BR)EBO}$	-4.0	—	Vdc
Collector Cutoff Current ($V_{CB} = -30 \text{ Vdc}, I_E = 0$)	I_{CBO}	—	-100	nAdc

ON CHARACTERISTICS

DC Current Gain ($I_C = -5.0 \text{ mAdc}, V_{CE} = -10 \text{ Vdc}$)	h_{FE}	40	400	—
Collector-Emitter Saturation Voltage ($I_C = -10 \text{ mAdc}, I_B = -1.0 \text{ mAdc}$)	$V_{CE(sat)}$	—	-0.25	Vdc

SMALL-SIGNAL CHARACTERISTICS

Current-Gain - Bandwidth Product ($I_C = -5.0 \text{ mAdc}, V_{CE} = -10 \text{ Vdc}, f = 100 \text{ MHz}$)	f_T	125	—	MHz
Output Capacitance ($V_{CB} = -10 \text{ Vdc}, I_E = 0, f = 1.0 \text{ MHz}$)	C_{obo}	—	4.0	pF

1. FR-5 = 1.0 x 0.75 x 0.062 in.

2. Alumina = 0.4 x 0.3 x 0.024 in. 99.5% alumina.

TYPICAL NOISE CHARACTERISTICS

($V_{CE} = -5.0 \text{ Vdc}$, $T_A = 25^\circ\text{C}$)

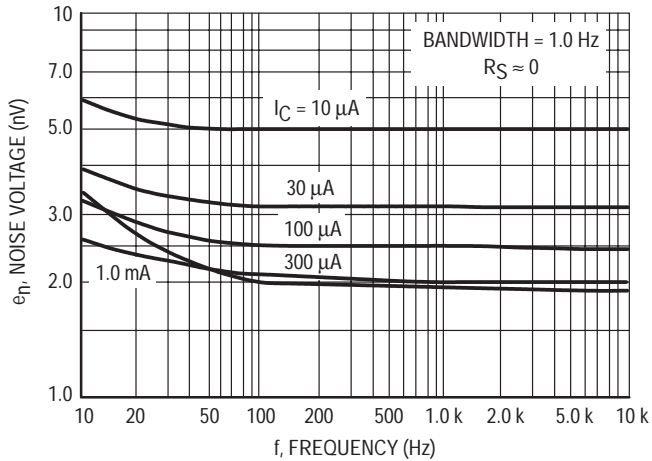


Figure 1. Noise Voltage

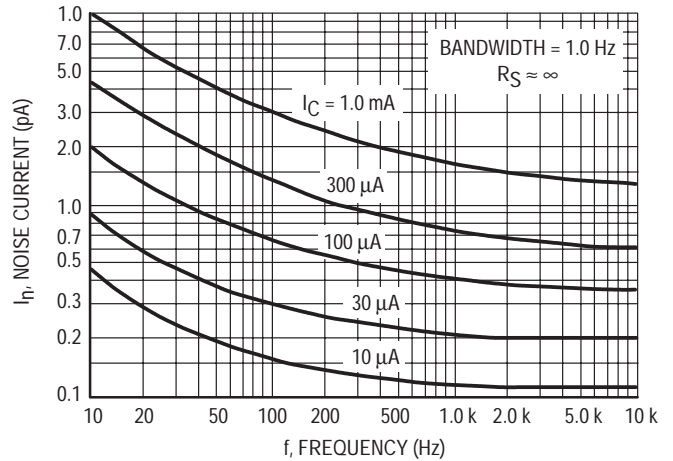


Figure 2. Noise Current

NOISE FIGURE CONTOURS

($V_{CE} = -5.0 \text{ Vdc}$, $T_A = 25^\circ\text{C}$)

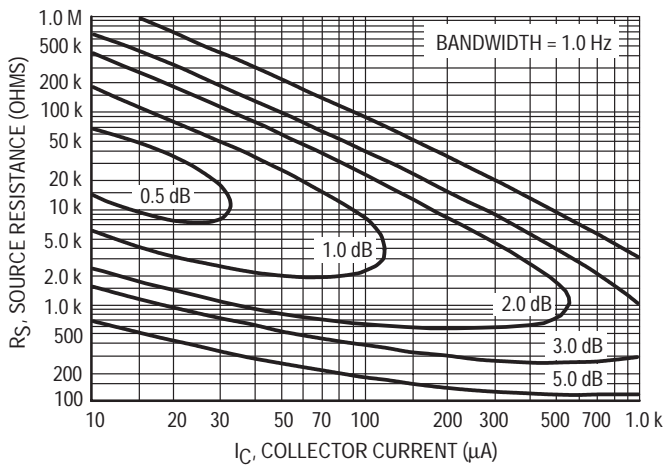


Figure 3. Narrow Band, 100 Hz

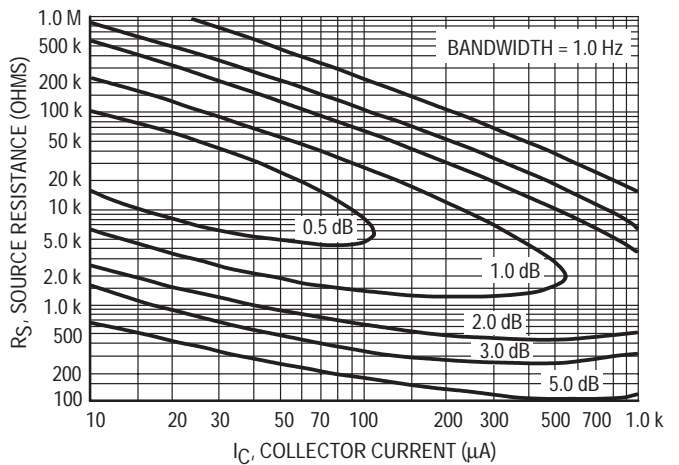


Figure 4. Narrow Band, 1.0 kHz

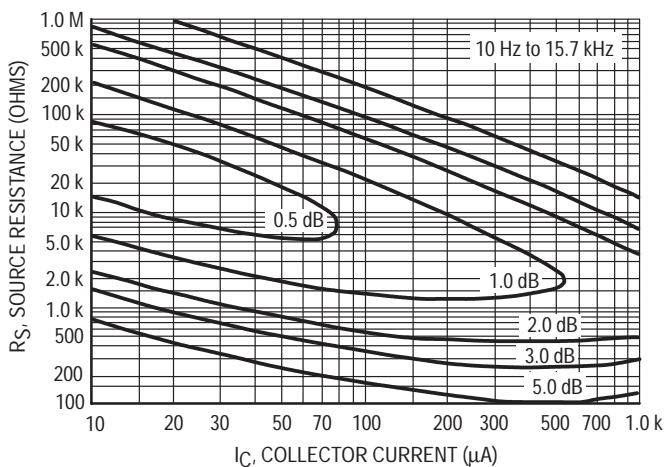


Figure 5. Wideband

Noise Figure is Defined as:

$$NF = 20 \log_{10} \left[\frac{e_n^2 + 4KTR_S + I_n^2 R_S^2}{4KTR_S} \right]^{1/2}$$

- e_n = Noise Voltage of the Transistor referred to the input. (Figure 3)
- I_n = Noise Current of the Transistor referred to the input. (Figure 4)
- K = Boltzman's Constant ($1.38 \times 10^{-23} \text{ J/}^\circ\text{K}$)
- T = Temperature of the Source Resistance ($^\circ\text{K}$)
- R_S = Source Resistance (Ohms)

TYPICAL STATIC CHARACTERISTICS

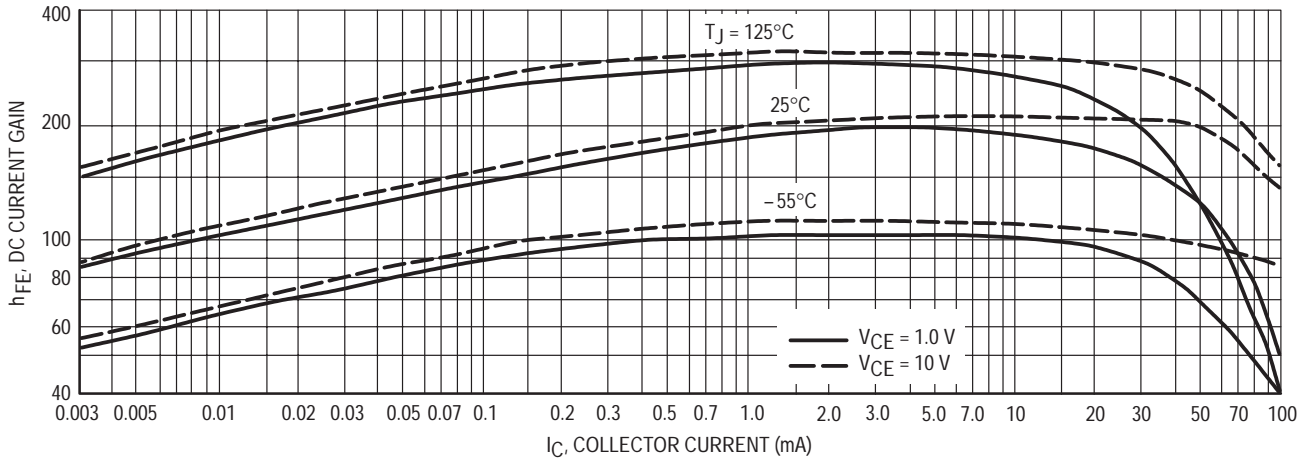


Figure 6. DC Current Gain

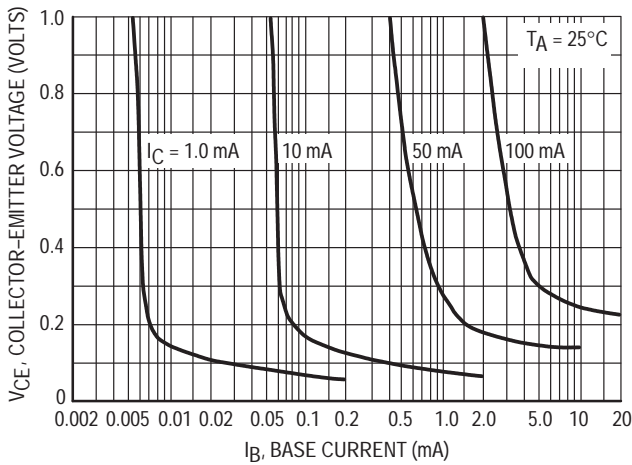


Figure 7. Collector Saturation Region

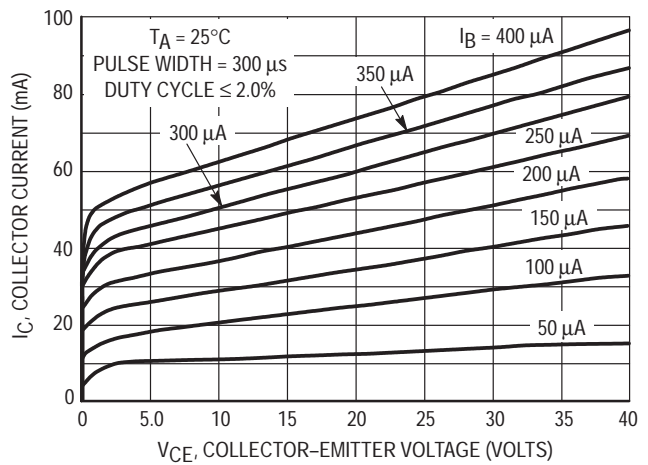


Figure 8. Collector Characteristics

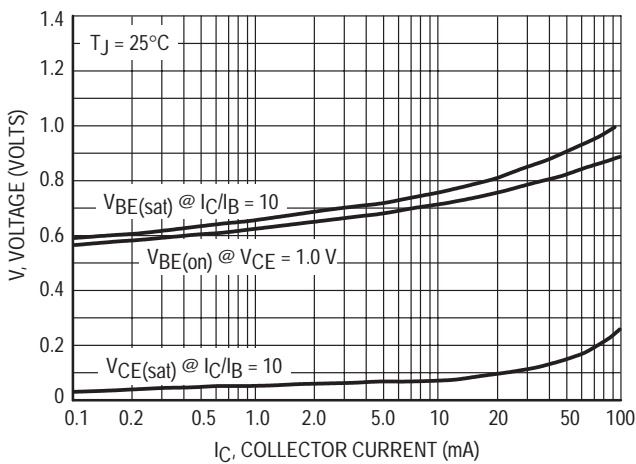


Figure 9. "On" Voltages

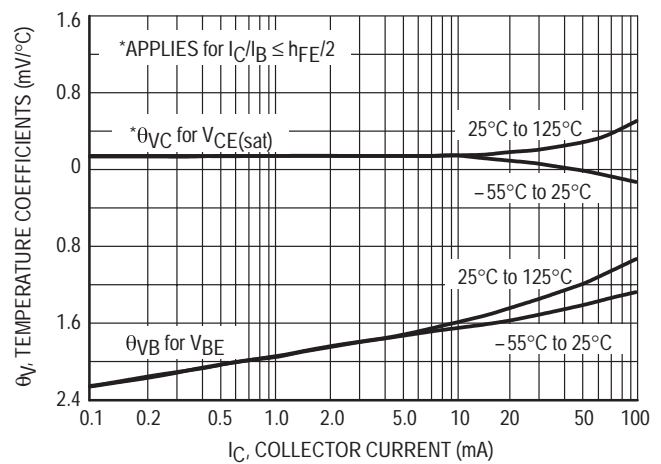


Figure 10. Temperature Coefficients

TYPICAL DYNAMIC CHARACTERISTICS

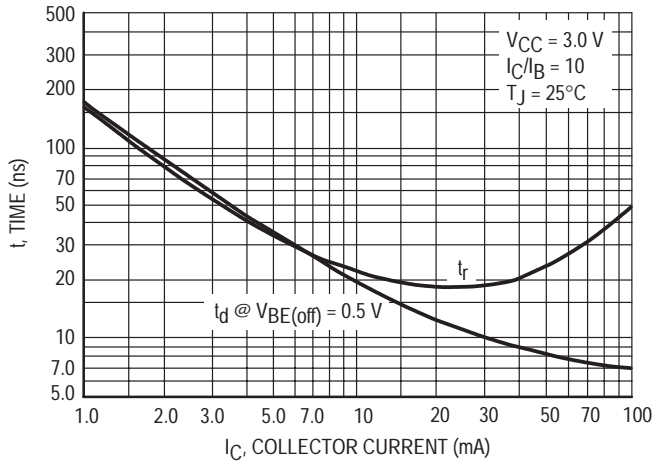


Figure 11. Turn-On Time

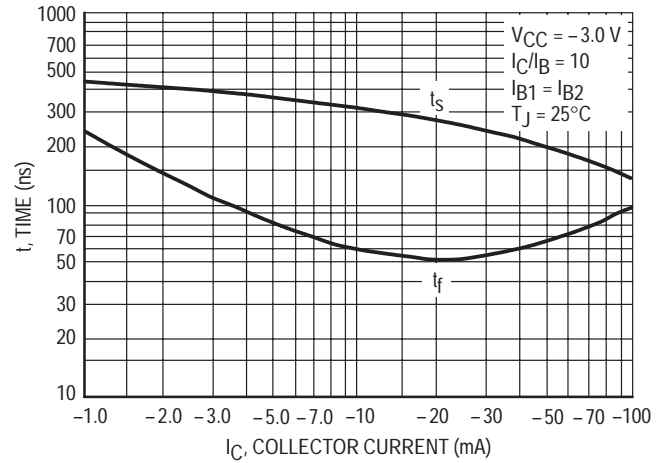


Figure 12. Turn-Off Time

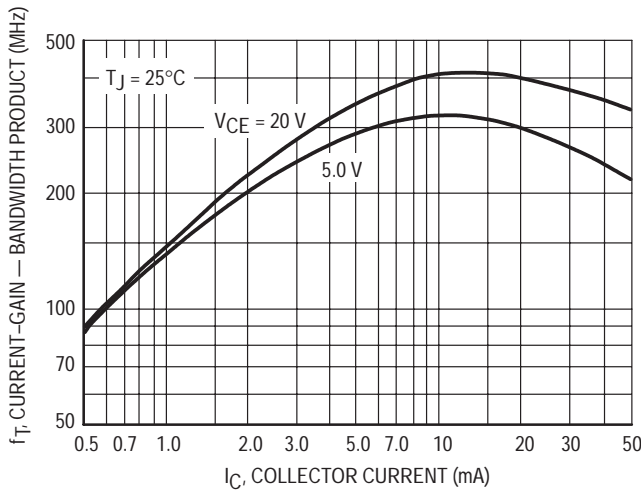


Figure 13. Current-Gain — Bandwidth Product

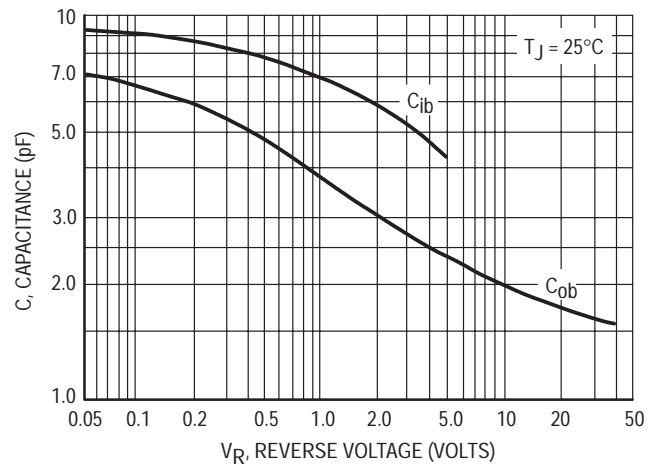


Figure 14. Capacitance

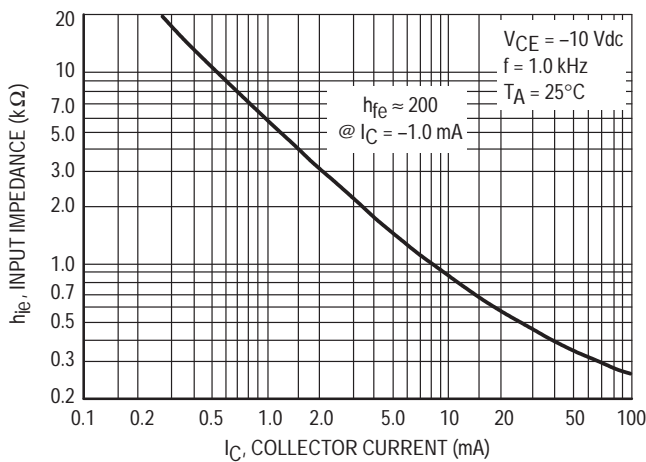


Figure 15. Input Impedance

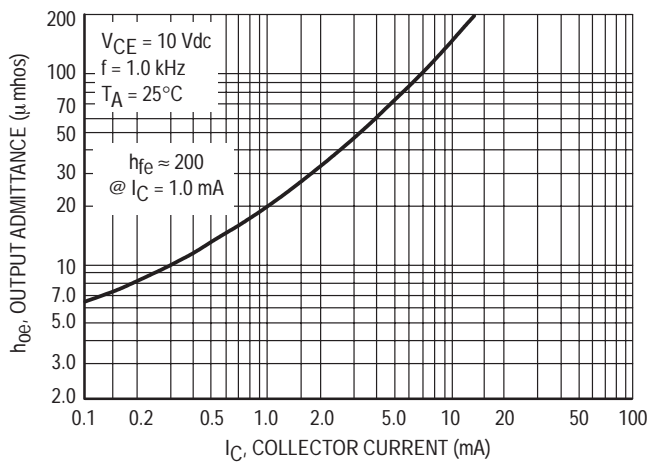


Figure 16. Output Admittance

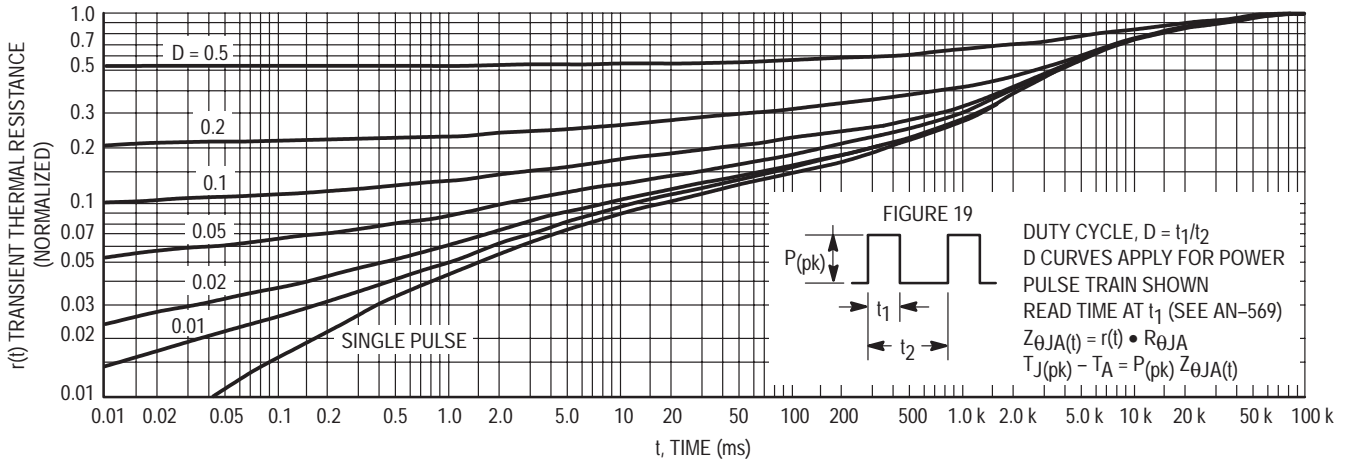


Figure 17. Thermal Response

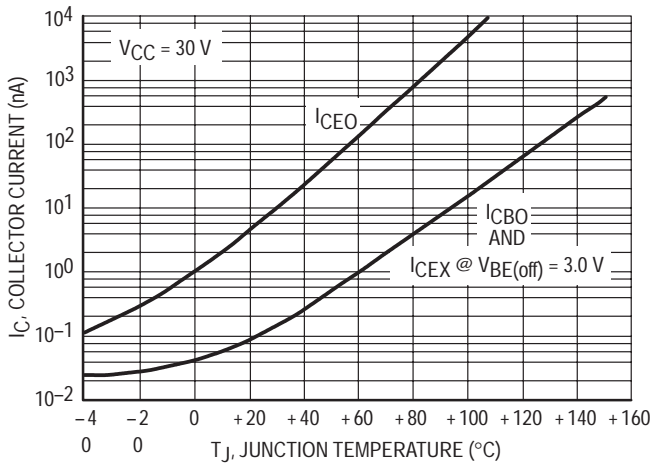


Figure 18. Typical Collector Leakage Current

DESIGN NOTE: USE OF THERMAL RESPONSE DATA

A train of periodical power pulses can be represented by the model as shown in Figure 19. Using the model and the device thermal response the normalized effective transient thermal resistance of Figure 17 was calculated for various duty cycles.

To find $Z_{\theta JA}(t)$, multiply the value obtained from Figure 17 by the steady state value $R_{\theta JA}$.

Example:

Dissipating 2.0 watts peak under the following conditions:

$$t_1 = 1.0 \text{ ms}, t_2 = 5.0 \text{ ms} (D = 0.2)$$

Using Figure 17 at a pulse width of 1.0 ms and $D = 0.2$, the reading of $r(t)$ is 0.22.

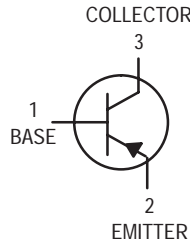
The peak rise in junction temperature is therefore

$$\Delta T = r(t) \times P_{(pk)} \times R_{\theta JA} = 0.22 \times 2.0 \times 200 = 88^\circ\text{C}.$$

For more information, see AN-569.

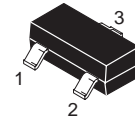
High Voltage Transistors

PNP Silicon



MMBTA92LT1*
MMBTA93LT1

*Motorola Preferred Device



CASE 318-08, STYLE 6
SOT-23 (TO-236AB)

MAXIMUM RATINGS

Rating	Symbol	MMBTA92	MMBTA93	Unit
Collector-Emitter Voltage	V_{CEO}	-300	-200	Vdc
Collector-Base Voltage	V_{CBO}	-300	-200	Vdc
Emitter-Base Voltage	V_{EBO}	-5.0	-5.0	Vdc
Collector Current — Continuous	I_C	-500		mAdc

DEVICE MARKING

MMBTA92LT1 = 2D; MMBTA93LT1 = 2E

THERMAL CHARACTERISTICS

Characteristic	Symbol	Max	Unit
Total Device Dissipation FR-5 Board, ⁽¹⁾ $T_A = 25^\circ\text{C}$ Derate above 25°C	P_D	225	mW
Thermal Resistance, Junction to Ambient	$R_{\theta JA}$	1.8	$\text{mW}/^\circ\text{C}$
Total Device Dissipation Alumina Substrate, ⁽²⁾ $T_A = 25^\circ\text{C}$ Derate above 25°C	P_D	300	mW
Thermal Resistance, Junction to Ambient	$R_{\theta JA}$	2.4	$\text{mW}/^\circ\text{C}$
Thermal Resistance, Junction to Ambient	$R_{\theta JA}$	417	$^\circ\text{C}/\text{W}$
Junction and Storage Temperature	T_J, T_{stg}	-55 to +150	$^\circ\text{C}$

ELECTRICAL CHARACTERISTICS ($T_A = 25^\circ\text{C}$ unless otherwise noted)

Characteristic	Symbol	Min	Max	Unit
----------------	--------	-----	-----	------

OFF CHARACTERISTICS

Collector-Emitter Breakdown Voltage ⁽³⁾ ($I_C = -1.0$ mAdc, $I_B = 0$)	MMBTA92 MMBTA93	$V_{(BR)CEO}$	-300 -200	— —	Vdc
Collector-Base Breakdown Voltage ($I_C = -100$ μAdc , $I_E = 0$)	MMBTA92 MMBTA93	$V_{(BR)CBO}$	-300 -200	— —	Vdc
Emitter-Base Breakdown Voltage ($I_E = -100$ μAdc , $I_C = 0$)		$V_{(BR)EBO}$	-5.0	—	Vdc
Collector Cutoff Current ($V_{CB} = -200$ Vdc, $I_E = 0$) ($V_{CB} = -160$ Vdc, $I_E = 0$)	MMBTA92 MMBTA93	I_{CBO}	— —	-0.25 -0.25	μAdc
Emitter Cutoff Current ($V_{EB} = -3.0$ Vdc, $I_C = 0$)		I_{EBO}	—	-0.1	μAdc

- FR-5 = 1.0 x 0.75 x 0.062 in.
- Alumina = 0.4 x 0.3 x 0.024 in. 99.5% alumina.
- Pulse Test: Pulse Width ≤ 300 μs , Duty Cycle $\leq 2.0\%$.

Preferred devices are Motorola recommended choices for future use and best overall value.

MMBTA92LT1 MMBTA93LT1**ELECTRICAL CHARACTERISTICS** ($T_A = 25^\circ\text{C}$ unless otherwise noted) (Continued)

Characteristic	Symbol	Min	Max	Unit
ON CHARACTERISTICS(3)				
DC Current Gain ($I_C = -1.0 \text{ mAdc}$, $V_{CE} = -10 \text{ Vdc}$) ($I_C = -10 \text{ mAdc}$, $V_{CE} = -10 \text{ Vdc}$)	Both Types Both Types	h_{FE}	25 40	— —
($I_C = -30 \text{ mAdc}$, $V_{CE} = -10 \text{ Vdc}$)	MMBTA92 MMBTA93		25 25	— —
Collector–Emitter Saturation Voltage ($I_C = -20 \text{ mAdc}$, $I_B = -2.0 \text{ mAdc}$)	MMBTA92 MMBTA93	$V_{CE(sat)}$	— —	-0.5 -0.5
Base–Emitter Saturation Voltage ($I_C = -20 \text{ mAdc}$, $I_B = -2.0 \text{ mAdc}$)		$V_{BE(sat)}$	—	-0.9
SMALL–SIGNAL CHARACTERISTICS				
Current–Gain — Bandwidth Product ($I_C = -10 \text{ mAdc}$, $V_{CE} = -20 \text{ Vdc}$, $f = 100 \text{ MHz}$)		f_T	50	—
Collector–Base Capacitance ($V_{CB} = -20 \text{ Vdc}$, $I_E = 0$, $f = 1.0 \text{ MHz}$)	MMBTA92 MMBTA93	C_{cb}	— —	6.0 8.0

3. Pulse Test: Pulse Width $\leq 300 \mu\text{s}$, Duty Cycle $\leq 2.0\%$.

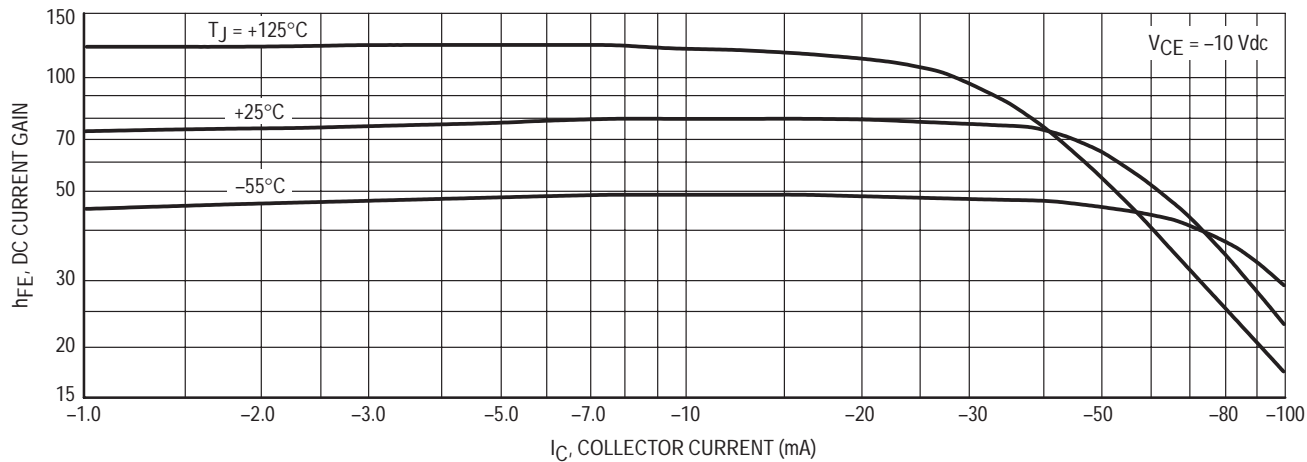


Figure 1. DC Current Gain

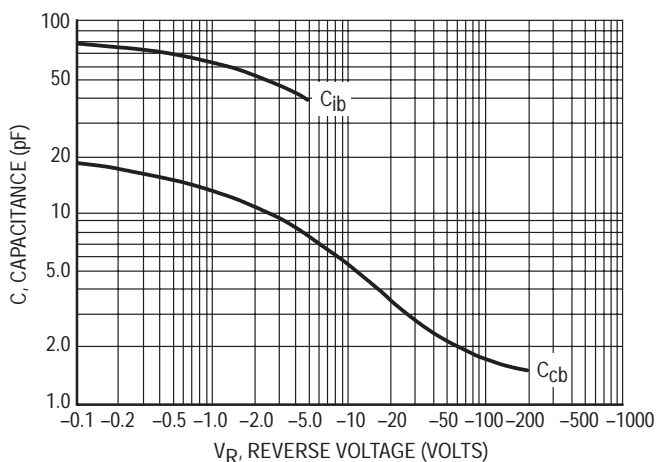


Figure 2. Capacitances

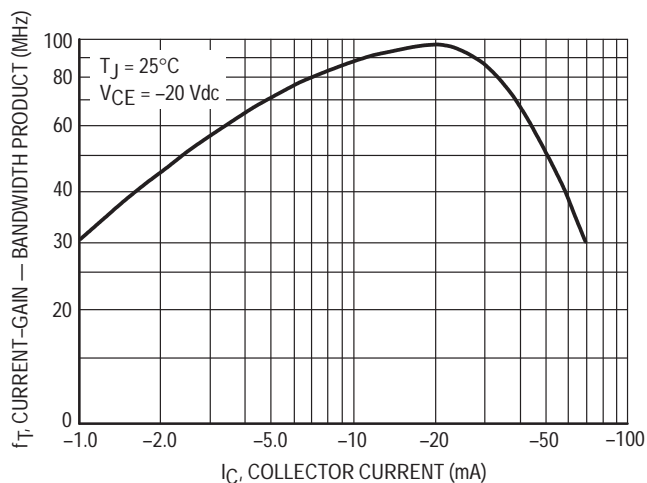


Figure 3. Current-Gain — Bandwidth Product

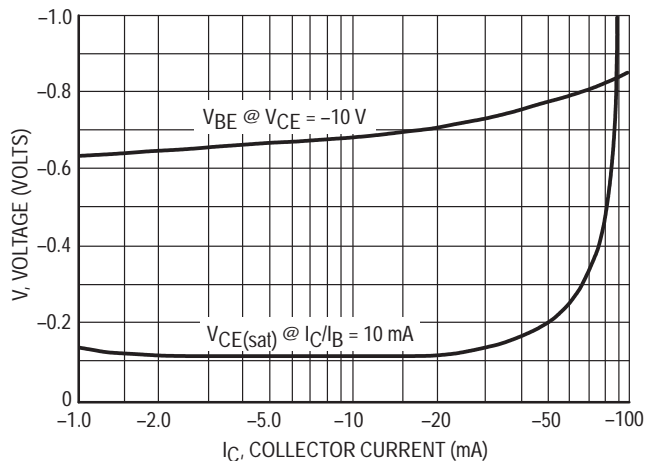
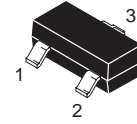
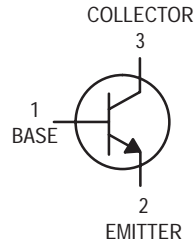


Figure 4. "On" Voltages

VHF/UHF Transistor
NPN Silicon

MMBTH10LT1

Motorola Preferred Device



CASE 318-08, STYLE 6
SOT-23 (TO-236AB)

MAXIMUM RATINGS

Rating	Symbol	Value	Unit
Collector–Emitter Voltage	V_{CEO}	25	Vdc
Collector–Base Voltage	V_{CB0}	30	Vdc
Emitter–Base Voltage	V_{EBO}	3.0	Vdc

DEVICE MARKING

MMBTH10LT1 = 3EM

THERMAL CHARACTERISTICS

Characteristic	Symbol	Max	Unit
Total Device Dissipation FR-5 Board (1) $T_A = 25^\circ\text{C}$ Derate above 25°C	P_D	225	mW
		1.8	mW/ $^\circ\text{C}$
Thermal Resistance Junction to Ambient	$R_{\theta JA}$	556	$^\circ\text{C}/\text{W}$
Total Device Dissipation Alumina Substrate, (2) $T_A = 25^\circ\text{C}$ Derate above 25°C	P_D	300	mW
		2.4	mW/ $^\circ\text{C}$
Thermal Resistance Junction to Ambient	$R_{\theta JA}$	417	$^\circ\text{C}/\text{W}$
Junction and Storage Temperature	T_J, T_{stg}	-55 to +150	$^\circ\text{C}$

ELECTRICAL CHARACTERISTICS ($T_A = 25^\circ\text{C}$ unless otherwise noted)

Characteristic	Symbol	Min	Typ	Max	Unit
----------------	--------	-----	-----	-----	------

OFF CHARACTERISTICS

Collector–Emitter Breakdown Voltage ($I_C = 1.0 \text{ mAdc}$, $I_B = 0$)	$V_{(BR)CEO}$	25	—	—	Vdc
Collector–Base Breakdown Voltage ($I_C = 100 \mu\text{Adc}$, $I_E = 0$)	$V_{(BR)CBO}$	30	—	—	Vdc
Emitter–Base Breakdown Voltage ($I_E = 10 \mu\text{Adc}$, $I_C = 0$)	$V_{(BR)EBO}$	3.0	—	—	Vdc
Collector Cutoff Current ($V_{CB} = 25 \text{ Vdc}$, $I_E = 0$)	I_{CBO}	—	—	100	nAdc
Emitter Cutoff Current ($V_{EB} = 2.0 \text{ Vdc}$, $I_C = 0$)	I_{EBO}	—	—	100	nAdc

1. FR-5 = 1.0 x 0.75 x 0.062 in.

2. Alumina = 0.4 x 0.3 x 0.024 in. 99.5% alumina

Preferred devices are Motorola recommended choices for future use and best overall value.

ELECTRICAL CHARACTERISTICS ($T_A = 25^\circ\text{C}$ unless otherwise noted) (Continued)

Characteristic	Symbol	Min	Typ	Max	Unit
ON CHARACTERISTICS					
DC Current Gain ($I_C = 4.0\text{ mA dc}$, $V_{CE} = 10\text{ V dc}$)	h_{FE}	60	—	—	—
Collector–Emitter Saturation Voltage ($I_C = 4.0\text{ mA dc}$, $I_B = 0.4\text{ mA dc}$)	$V_{CE(sat)}$	—	—	0.5	Vdc
Base–Emitter On Voltage ($I_C = 4.0\text{ mA dc}$, $V_{CE} = 10\text{ V dc}$)	V_{BE}	—	—	0.95	Vdc
SMALL–SIGNAL CHARACTERISTICS					
Current–Gain – Bandwidth Product ($I_C = 4.0\text{ mA dc}$, $V_{CE} = 10\text{ V dc}$, $f = 100\text{ MHz}$)	f_T	650	—	—	MHz
Collector–Base Capacitance ($V_{CB} = 10\text{ V dc}$, $I_E = 0$, $f = 1.0\text{ MHz}$)	C_{cb}	—	—	0.7	pF
Common–Base Feedback Capacitance ($V_{CB} = 10\text{ V dc}$, $I_E = 0$, $f = 1.0\text{ MHz}$)	C_{rb}	—	—	0.65	pF
Collector Base Time Constant ($I_C = 4.0\text{ mA dc}$, $V_{CB} = 10\text{ V dc}$, $f = 31.8\text{ MHz}$)	$rb'C_C$	—	—	9.0	ps

TYPICAL CHARACTERISTICS

COMMON-BASE y PARAMETERS versus FREQUENCY
 ($V_{CB} = 10 \text{ Vdc}$, $I_C = 4.0 \text{ mAdc}$, $T_A = 25^\circ\text{C}$)

y_{ib} , INPUT ADMITTANCE

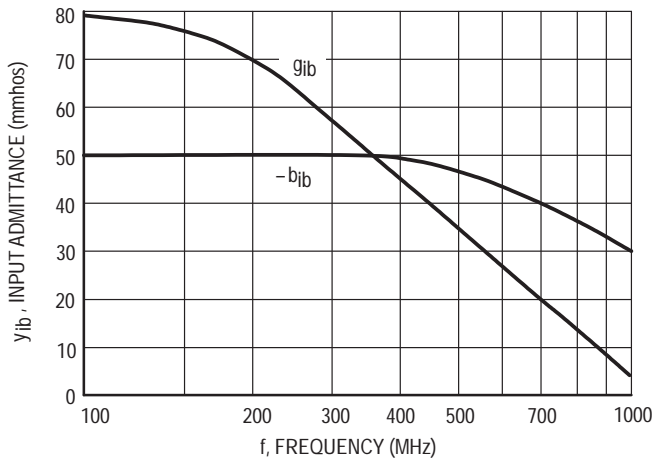


Figure 1. Rectangular Form

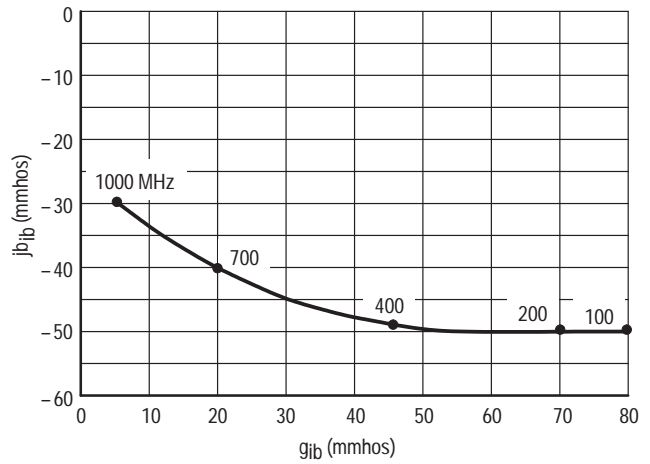


Figure 2. Polar Form

y_{fb} , FORWARD TRANSFER ADMITTANCE

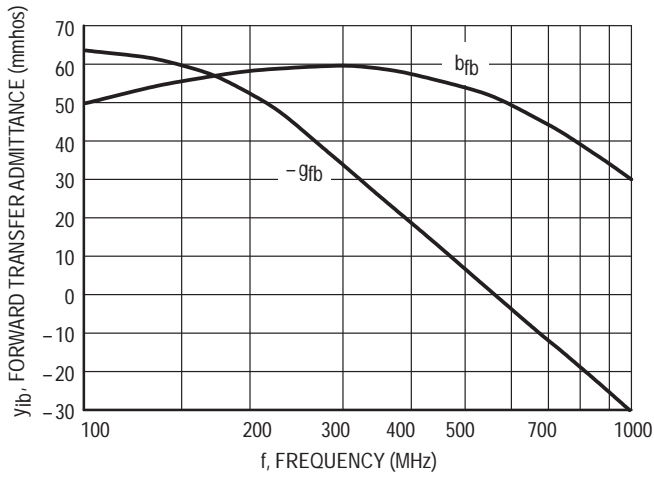


Figure 3. Rectangular Form

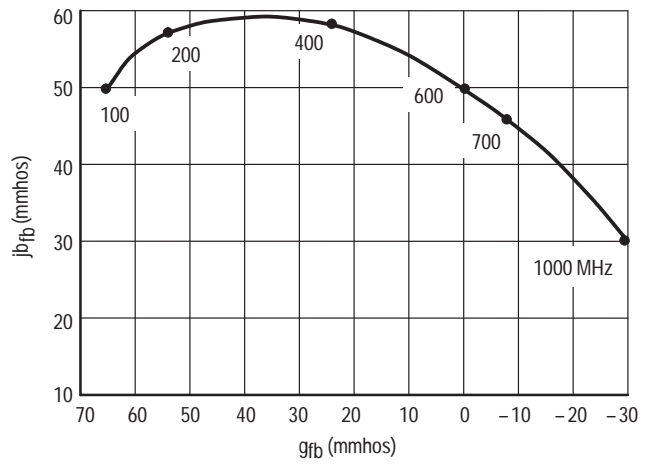


Figure 4. Polar Form

TYPICAL CHARACTERISTICS

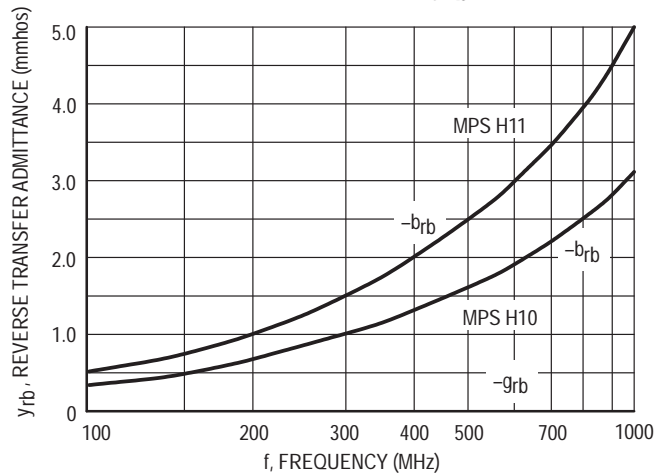
COMMON-BASE y PARAMETERS versus FREQUENCY $(V_{CB} = 10 \text{ Vdc}, I_C = 4.0 \text{ mA}, T_A = 25^\circ\text{C})$ y_{rb} , REVERSE TRANSFER ADMITTANCE

Figure 5. Rectangular Form

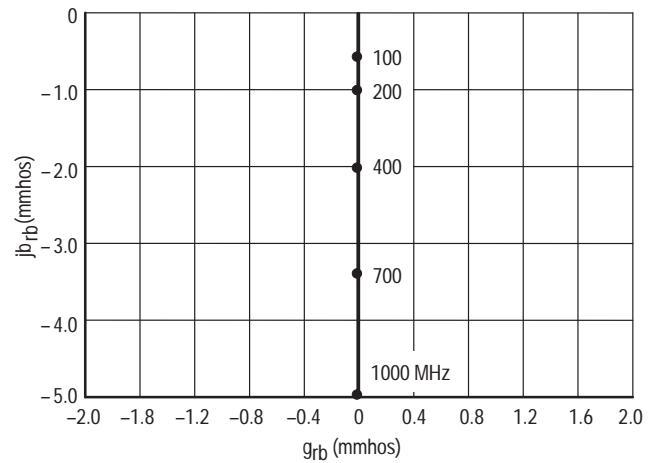


Figure 6. Polar Form

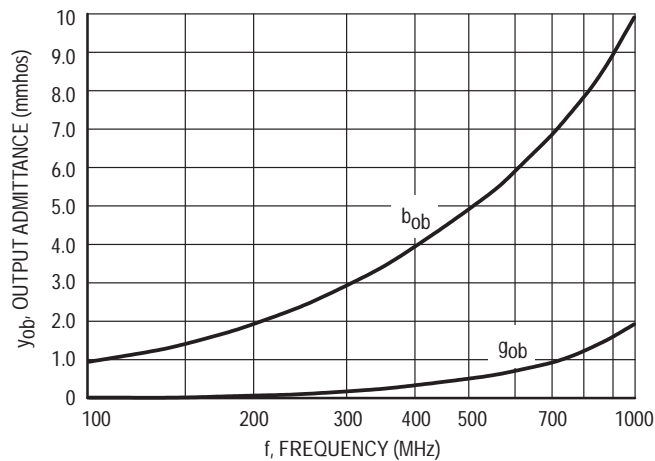
 y_{ob} , OUTPUT ADMITTANCE

Figure 7. Rectangular Form

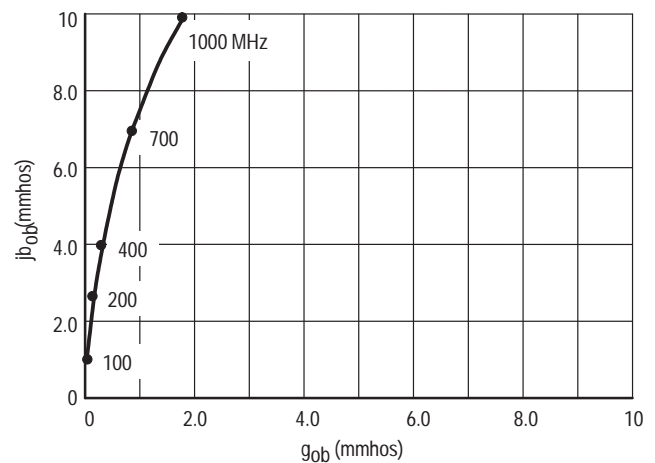
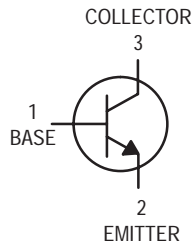


Figure 8. Polar Form

VHF Mixer Transistor

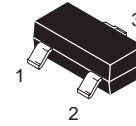
NPN Silicon

- Designed for
- $f_T = 400$ MHz Min @ 8 mA



MMBTH24LT1

Motorola Preferred Device



CASE 318-08, STYLE 6
SOT-23 (TO-236AB)

MAXIMUM RATINGS

Rating	Symbol	Value	Unit
Collector–Emitter Voltage	V_{CEO}	30	Vdc
Collector–Base Voltage	V_{CBO}	40	Vdc
Emitter–Base Voltage	V_{EBO}	4.0	Vdc
Collector Current – Continuous	I_C	50	mAdc

DEVICE MARKING

MMBTH24LT1 = M3A

THERMAL CHARACTERISTICS

Characteristic	Symbol	Max	Unit
Total Device Dissipation FR-5 Board (1) $T_A = 25^\circ\text{C}$ Derate above 25°C	P_D	225	mW
		1.8	$\text{mW}/^\circ\text{C}$
Thermal Resistance Junction to Ambient	$R_{\theta JA}$	556	$^\circ\text{C}/\text{W}$
Total Device Dissipation Alumina Substrate, (2) $T_A = 25^\circ\text{C}$ Derate above 25°C	P_D	300	mW
		2.4	$\text{mW}/^\circ\text{C}$
Thermal Resistance Junction to Ambient	$R_{\theta JA}$	417	$^\circ\text{C}/\text{W}$
Junction and Storage Temperature	T_J, T_{stg}	-55 to +150	$^\circ\text{C}$

ELECTRICAL CHARACTERISTICS ($T_A = 25^\circ\text{C}$ unless otherwise noted)

Characteristic	Symbol	Min	Typ	Max	Unit
----------------	--------	-----	-----	-----	------

OFF CHARACTERISTICS

Collector–Emitter Breakdown Voltage ($I_C = 1.0$ mAdc, $I_B = 0$)	$V_{(BR)CEO}$	30	—	—	Vdc
Collector–Base Breakdown Voltage ($I_C = 100$ μAdc , $I_E = 0$)	$V_{(BR)CBO}$	40	—	—	Vdc
Emitter–Base Breakdown Voltage ($I_E = 10$ μAdc , $I_C = 0$)	$V_{(BR)EBO}$	4.0	—	—	Vdc
Collector Cutoff Current ($V_{CB} = 15$ Vdc, $I_E = 0$)	I_{CBO}	—	—	50	nAdc

1. FR-5 = 1.0 x 0.75 x 0.062 in.

2. Alumina = 0.4 x 0.3 x 0.024 in. 99.5% alumina

Preferred devices are Motorola recommended choices for future use and best overall value.

ELECTRICAL CHARACTERISTICS ($T_A = 25^\circ\text{C}$ unless otherwise noted) (Continued)

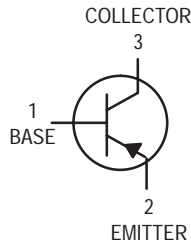
Characteristic	Symbol	Min	Typ	Max	Unit
ON CHARACTERISTICS					
DC Current Gain ($I_C = 8.0 \text{ mAdc}$, $V_{CE} = 10 \text{ Vdc}$)	h_{FE}	30	—	—	—
SMALL-SIGNAL CHARACTERISTICS					
Current-Gain – Bandwidth Product ⁽³⁾ ($I_C = 8.0 \text{ mAdc}$, $V_{CE} = 10 \text{ Vdc}$, $f = 100 \text{ MHz}$)	f_T	400	620	—	MHz
Collector-Base Capacitance ($V_{CB} = 10 \text{ Vdc}$, $I_E = 0$, $f = 1.0 \text{ MHz}$)	C_{cb}	—	0.25	0.45	pF
Conversion Gain (213 MHz to 45 MHz) ($I_C = 8.0 \text{ mAdc}$, $V_{CC} = 20 \text{ Vdc}$, Oscillator Injection = 150 mVrms) (60 MHz to 45 MHz) ($I_C = 8.0 \text{ mAdc}$, $V_{CC} = 20 \text{ Vdc}$, Oscillator Injection = 150 mVrms)	— C_G	— 19 24	— 24 20	— — —	dB

3. Pulse Test: Pulse Width $\leq 300 \mu\text{s}$, Duty Cycle $\leq 2.0\%$.

UHF/VHF Transistor

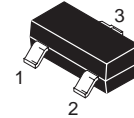
PNP Silicon

- Designed for UHF/VHF Amplifier Applications
- High Current Gain Bandwidth Product
 $f_T = 2000 \text{ MHz Min @ } 10 \text{ mA}$



MMBTH69LT1

Motorola Preferred Device



CASE 318-08, STYLE 6
SOT-23 (TO-236AB)

MAXIMUM RATINGS

Rating	Symbol	Value	Unit
Collector-Emitter Voltage	V_{CEO}	-15	Vdc
Collector-Base Voltage	V_{CBO}	-15	Vdc
Emitter-Base Voltage	V_{EBO}	-4.0	Vdc

DEVICE MARKING

MMBTH69LT1 = M3J

THERMAL CHARACTERISTICS

Characteristic	Symbol	Max	Unit
Total Device Dissipation FR-5 Board (1) $T_A = 25^\circ\text{C}$ Derate above 25°C	P_D	225	mW
Thermal Resistance Junction to Ambient	$R_{\theta JA}$	556	$^\circ\text{C/W}$
Total Device Dissipation Alumina Substrate, (2) $T_A = 25^\circ\text{C}$ Derate above 25°C	P_D	300	mW
Thermal Resistance Junction to Ambient	$R_{\theta JA}$	417	$^\circ\text{C/W}$
Junction and Storage Temperature	T_J, T_{stg}	-55 to +150	$^\circ\text{C}$

ELECTRICAL CHARACTERISTICS ($T_A = 25^\circ\text{C}$ unless otherwise noted)

Characteristic	Symbol	Min	Typ	Max	Unit
----------------	--------	-----	-----	-----	------

OFF CHARACTERISTICS

Collector-Emitter Breakdown Voltage ($I_C = -1.0 \text{ mA}$, $I_B = 0$)	$V_{(BR)CEO}$	-15	—	—	Vdc
Collector-Base Breakdown Voltage ($I_C = -10 \mu\text{A}$, $I_E = 0$)	$V_{(BR)CBO}$	-15	—	—	Vdc
Emitter-Base Breakdown Voltage ($I_E = -10 \mu\text{A}$, $I_C = 0$)	$V_{(BR)EBO}$	-4.0	—	—	Vdc
Collector Cutoff Current ($V_{CB} = -10 \text{ Vdc}$, $I_E = 0$)	I_{CBO}	—	—	-100	nA

ON CHARACTERISTICS

DC Current Gain ($I_C = -10 \text{ mA}$, $V_{CE} = -10 \text{ Vdc}$)	h_{FE}	30	—	300	—
-------------------------------------------------------------------------	----------	----	---	-----	---

SMALL-SIGNAL CHARACTERISTICS

Current-Gain - Bandwidth Product ($I_C = -10 \text{ mA}$, $V_{CE} = -10 \text{ Vdc}$, $f = 100 \text{ MHz}$)	f_T	2000	—	—	MHz
Collector-Base Capacitance ($V_{CE} = -10 \text{ Vdc}$, $I_E = 0$, $f = 1.0 \text{ MHz}$)	C_{rb}	—	—	0.35	pF

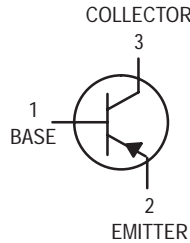
1. FR-5 = 1.0 x 0.75 x 0.062 in.

2. Alumina = 0.4 x 0.3 x 0.024 in. 99.5% alumina

Preferred devices are Motorola recommended choices for future use and best overall value.

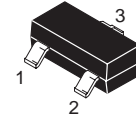
UHF/VHF Transistor

PNP Silicon



MMBTH81LT1

Motorola Preferred Device



CASE 318-08, STYLE 6
SOT-23 (TO-236AB)

MAXIMUM RATINGS

Rating	Symbol	Value	Unit
Collector-Emitter Voltage	V_{CEO}	-20	Vdc
Collector-Base Voltage	V_{CBO}	-20	Vdc
Emitter-Base Voltage	V_{EBO}	-3.0	Vdc

DEVICE MARKING

MMBTH81LT1 = 3D

THERMAL CHARACTERISTICS

Characteristic	Symbol	Max	Unit
Total Device Dissipation FR-5 Board, ⁽¹⁾ $T_A = 25^\circ\text{C}$ Derate above 25°C	P_D	225	mW
Thermal Resistance, Junction to Ambient	$R_{\theta JA}$	1.8	$\text{mW}/^\circ\text{C}$
Total Device Dissipation Alumina Substrate, ⁽²⁾ $T_A = 25^\circ\text{C}$ Derate above 25°C	P_D	300	mW
Thermal Resistance, Junction to Ambient	$R_{\theta JA}$	2.4	$\text{mW}/^\circ\text{C}$
Junction and Storage Temperature	T_J, T_{stg}	-55 to +150	$^\circ\text{C}$

ELECTRICAL CHARACTERISTICS ($T_A = 25^\circ\text{C}$ unless otherwise noted)

Characteristic	Symbol	Min	Typ	Max	Unit
----------------	--------	-----	-----	-----	------

OFF CHARACTERISTICS

Collector-Emitter Breakdown Voltage ($I_C = -1.0 \text{ mAdc}, I_B = 0$)	$V_{(BR)CEO}$	-20	—	—	Vdc
Collector-Base Breakdown Voltage ($I_C = -10 \mu\text{Adc}, I_E = 0$)	$V_{(BR)CBO}$	-20	—	—	Vdc
Emitter-Base Breakdown Voltage ($I_E = -10 \mu\text{Adc}, I_C = 0$)	$V_{(BR)EBO}$	-3.0	—	—	Vdc
Collector Cutoff Current ($V_{CB} = -10 \text{ Vdc}, I_E = 0$)	I_{CBO}	—	—	-100	nAdc
Emitter Cutoff Current ($V_{EB} = -2.0 \text{ Vdc}, I_C = 0$)	I_{EBO}	—	—	-100	nAdc

ON CHARACTERISTICS

DC Current Gain ($I_C = -5.0 \text{ mAdc}, V_{CE} = -10 \text{ Vdc}$)	h_{FE}	60	—	—	—
Collector-Emitter Saturation Voltage ($I_C = -5.0 \text{ mAdc}, I_B = -0.5 \text{ mAdc}$)	$V_{CE(sat)}$	—	—	-0.5	Vdc
Base-Emitter On Voltage ($I_C = -5.0 \text{ mAdc}, V_{CE} = -10 \text{ Vdc}$)	$V_{BE(on)}$	—	—	-0.9	Vdc

SMALL-SIGNAL CHARACTERISTICS

Current-Gain - Bandwidth Product ($I_C = -5.0 \text{ mAdc}, V_{CE} = -10 \text{ Vdc}, f = 100 \text{ MHz}$)	f_T	600	—	—	MHz
Collector-Base Capacitance ($V_{CB} = -10 \text{ Vdc}, I_E = 0, f = 1.0 \text{ MHz}$)	C_{cb}	—	—	0.85	pF
Collector-Emitter Capacitance ($I_B = 0, V_{CB} = -10 \text{ Vdc}, f = 1.0 \text{ MHz}$)	C_{ce}	—	—	0.65	pF

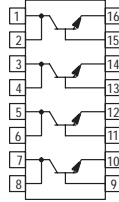
1. FR-5 = 1.0 x 0.75 x 0.062 in.

2. Alumina = 0.4 x 0.3 x 0.024 in. 99.5% alumina.

Preferred devices are Motorola recommended choices for future use and best overall value.

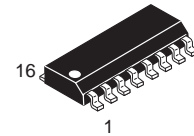
Quad General Purpose Transistors

NPN Silicon



MMPQ2222
MMPQ2222A*

*Motorola Preferred Device



CASE 751B-05, STYLE 4
SO-16

MAXIMUM RATINGS

Rating	Symbol	MMPQ2222	MMPQ2222A	Unit
Collector-Emitter Voltage	V_{CEO}	30	40	Vdc
Collector-Base Voltage	V_{CB}	60	75	Vdc
Emitter-Base Voltage	V_{EB}	5.0		Vdc
Collector Current — Continuous	I_C	500		mAdc
		Each Transistor	Four Transistors Equal Power	
Total Power Dissipation @ $T_A = 25^\circ\text{C}$ Derate above 25°C	P_D	0.52 4.2	1.0 8.0	Watts mW/ $^\circ\text{C}$
Total Power Dissipation @ $T_C = 25^\circ\text{C}$ Derate above 25°C	P_D	0.8 6.4	2.4 19.2	Watts mW/ $^\circ\text{C}$
Operating and Storage Junction Temperature Range	T_J, T_{stg}	-55 to +150		$^\circ\text{C}$

ELECTRICAL CHARACTERISTICS ($T_A = 25^\circ\text{C}$ unless otherwise noted)

Characteristic	Symbol	Min	Typ	Max	Unit
----------------	--------	-----	-----	-----	------

OFF CHARACTERISTICS

Collector-Emitter Breakdown Voltage ⁽¹⁾ ($I_C = 10 \text{ mAdc}, I_E = 0$)	MMPQ2222 MMPQ2222A	$V_{(BR)CEO}$	30 40	— —	— —	Vdc
Collector-Base Breakdown Voltage ($I_C = 10 \mu\text{Adc}, I_E = 0$)	MMPQ2222 MMPQ2222A	$V_{(BR)CBO}$	60 75	— —	— —	Vdc
Emitter-Base Breakdown Voltage ($I_B = 10 \mu\text{Adc}, I_C = 0$)		$V_{(BR)EBO}$	5.0 —	— —	— —	Vdc
Collector Cutoff Current ($V_{CB} = 50 \text{ Vdc}, I_E = 0$) ($V_{CB} = 60 \text{ Vdc}, I_E = 0$)	MMPQ2222 MMPQ2222A	I_{CBO}	— —	— —	50 10	nAdc
Emitter Cutoff Current ($V_{EB} = 3.0 \text{ Vdc}, I_C = 0$)		I_{EBO}	—	—	100	nAdc

1. Pulse Test: Pulse Width $\leq 300 \mu\text{s}$; Duty Cycle $\leq 2.0\%$.

Preferred devices are Motorola recommended choices for future use and best overall value.

ELECTRICAL CHARACTERISTICS ($T_A = 25^\circ\text{C}$ unless otherwise noted) (Continued)

Characteristic		Symbol	Min	Typ	Max	Unit
ON CHARACTERISTICS						
DC Current Gain ⁽¹⁾ ($I_C = 100\ \mu\text{A}$, $V_{CE} = 10\ \text{V}$) ($I_C = 1.0\ \text{mA}$, $V_{CE} = 10\ \text{V}$) ($I_C = 10\ \text{mA}$, $V_{CE} = 10\ \text{V}$) ($I_C = 150\ \text{mA}$, $V_{CE} = 10\ \text{V}$) ($I_C = 300\ \text{mA}$, $V_{CE} = 10\ \text{V}$) ($I_C = 500\ \text{mA}$, $V_{CE} = 10\ \text{V}$) ($I_C = 150\ \text{mA}$, $V_{CE} = 1.0\ \text{V}$)	MMPQ2222A MMPQ2222A MMPQ2222 MMPQ2222A MMPQ2222 MMPQ2222A MMPQ2222 MMPQ2222A MMPQ2222A	h_{FE}	35 50 75 75 100 100 30 40 50	— — — — — — — — —	— — — — — 300 — — —	—
Collector–Emitter Saturation Voltage ⁽¹⁾ ($I_C = 150\ \text{mAdc}$, $I_B = 15\ \text{mAdc}$) ($I_C = 300\ \text{mAdc}$, $I_B = 30\ \text{mAdc}$) ($I_C = 500\ \text{mAdc}$, $I_B = 50\ \text{mAdc}$)	MMPQ2222 MMPQ2222A MMPQ2222 MMPQ2222A	$V_{CE(sat)}$	— — — —	— — — —	0.4 0.3 1.6 1.0	Vdc
Base–Emitter Saturation Voltage ⁽¹⁾ ($I_C = 150\ \text{mAdc}$, $I_B = 15\ \text{mAdc}$) ($I_C = 300\ \text{mAdc}$, $I_B = 30\ \text{mAdc}$) ($I_C = 500\ \text{mAdc}$, $I_B = 50\ \text{mAdc}$)	MMPQ2222 MMPQ2222A MMPQ2222 MMPQ2222A	$V_{BE(sat)}$	— — — —	— — — —	1.3 1.2 2.6 2.0	Vdc

DYNAMIC CHARACTERISTICS

Current–Gain — Bandwidth Product ⁽¹⁾ ($I_C = 20\ \text{mAdc}$, $V_{CE} = 20\ \text{Vdc}$, $f = 100\ \text{MHz}$)		f_T	200	350	—	MHz
Output Capacitance ($V_{CB} = 10\ \text{Vdc}$, $I_E = 0$, $f = 1.0\ \text{MHz}$)		C_{ob}	—	4.5	—	pF
Input Capacitance ($V_{EB} = 0.5\ \text{Vdc}$, $I_C = 0$, $f = 1.0\ \text{MHz}$)		C_{ib}	—	17	—	pF

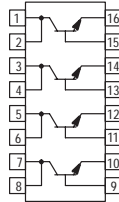
SWITCHING CHARACTERISTICS

Turn–On Time ($V_{CC} = 30\ \text{Vdc}$, $V_{BE(off)} = -0.5\ \text{Vdc}$, $I_C = 150\ \text{mAdc}$, $I_{B1} = 15\ \text{mAdc}$)		t_{on}	—	25	—	ns
Turn–Off Time ($V_{CC} = 30\ \text{Vdc}$, $I_C = 150\ \text{mAdc}$, $I_{B1} = I_{B2} = 15\ \text{mAdc}$)		t_{off}	—	250	—	ns

1. Pulse Test: Pulse Width $\leq 300\ \mu\text{s}$; Duty Cycle $\leq 2.0\%$.

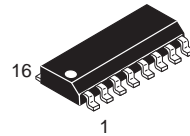
Quad Switching Transistor

NPN Silicon



MMPQ2369

Motorola Preferred Device



CASE 751B-05, STYLE 4
SO-16

MAXIMUM RATINGS

Rating	Symbol	Value		Unit
Collector–Emitter Voltage	V_{CEO}	15		Vdc
Collector–Base Voltage	V_{CB}	40		Vdc
Emitter–Base Voltage	V_{EB}	4.5		Vdc
Collector Current — Continuous	I_C	500		mAdc
		Each Transistor	Four Transistors Equal Power	
Total Power Dissipation @ $T_A = 25^\circ\text{C}$ Derate above 25°C	P_D	0.4 3.2	0.72 6.4	Watts mW/ $^\circ\text{C}$
Total Power Dissipation @ $T_C = 25^\circ\text{C}$ Derate above 25°C	P_D	0.66 5.3	1.92 15.4	Watts mW/ $^\circ\text{C}$
Operating and Storage Junction Temperature Range	T_J, T_{stg}	–55 to +150		$^\circ\text{C}$

ELECTRICAL CHARACTERISTICS ($T_A = 25^\circ\text{C}$ unless otherwise noted)

Characteristic	Symbol	Min	Typ	Max	Unit
----------------	--------	-----	-----	-----	------

OFF CHARACTERISTICS

Collector–Emitter Breakdown Voltage ⁽¹⁾ ($I_C = 10 \text{ mAdc}, I_E = 0$)	$V_{(BR)CEO}$	15	—	—	Vdc
Collector–Base Breakdown Voltage ($I_C = 10 \mu\text{Adc}, I_E = 0$)	$V_{(BR)CBO}$	40	—	—	Vdc
Emitter–Base Breakdown Voltage ($I_E = 10 \mu\text{Adc}, I_C = 0$)	$V_{(BR)EBO}$	4.5	—	—	Vdc
Collector Cutoff Current ($V_{CB} = 20 \text{ Vdc}, I_E = 0$)	I_{CBO}	—	—	0.4	μAdc

1. Pulse Test: Pulse Width $\leq 300 \mu\text{s}$; Duty Cycle $\leq 2.0\%$.

Preferred devices are Motorola recommended choices for future use and best overall value.

ELECTRICAL CHARACTERISTICS ($T_A = 25^\circ\text{C}$ unless otherwise noted) (Continued)

Characteristic	Symbol	Min	Typ	Max	Unit
ON CHARACTERISTICS					
DC Current Gain ⁽¹⁾ ($I_C = 10\text{ mAdc}$, $V_{CE} = 1.0\text{ Vdc}$) ($I_C = 100\text{ mAdc}$, $V_{CE} = 2.0\text{ Vdc}$)	h_{FE}	40 20	— —	— —	—
Collector–Emitter Saturation Voltage ($I_C = 10\text{ mAdc}$, $I_B = 1.0\text{ mAdc}$)	$V_{CE(sat)}$	—	—	0.25	Vdc
Base–Emitter Saturation Voltage ($I_C = 10\text{ mAdc}$, $I_B = 1.0\text{ mAdc}$)	$V_{BE(sat)}$	—	—	0.9	Vdc

DYNAMIC CHARACTERISTICS

Current–Gain — Bandwidth Product ($I_C = 10\text{ mAdc}$, $V_{CE} = 10\text{ Vdc}$, $f = 100\text{ MHz}$)	f_T	450	550	—	MHz
Output Capacitance ($V_{CB} = 5.0\text{ Vdc}$, $I_E = 0$, $f = 1.0\text{ MHz}$)	C_{ob}	—	2.5	4.0	pF
Input Capacitance ($V_{EB} = 0.5\text{ Vdc}$, $I_C = 0$, $f = 1.0\text{ MHz}$)	C_{ib}	—	3.0	5.0	pF

SWITCHING CHARACTERISTICS

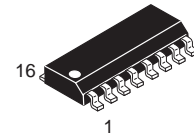
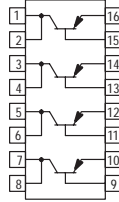
Turn–On Time ($V_{CC} = 3.0\text{ Vdc}$, $V_{EB(off)} = 1.5\text{ Vdc}$, $I_C = 10\text{ mAdc}$, $I_{B1} = 3.0\text{ mAdc}$)	t_{on}	—	9.0	—	ns
Turn–Off Time ($V_{CC} = 3.0\text{ Vdc}$, $I_C = 10\text{ mAdc}$, $I_{B1} = 3.0\text{ mAdc}$, $I_{B2} = 1.5\text{ mAdc}$)	t_{off}	—	15	—	ns

1. Pulse Test: Pulse Width $\leq 300\ \mu\text{s}$; Duty Cycle $\leq 2.0\%$.

Quad General Purpose Transistors

PNP Silicon

MMPQ2907
MMPQ2907A



CASE 751B-05, STYLE 4
SO-16

MAXIMUM RATINGS

Rating	Symbol	MMPQ2907	MMPQ2907A	Unit
Collector-Emitter Voltage	V_{CEO}	-40	-60	Vdc
Collector-Base Voltage	V_{CB}	-60		Vdc
Emitter-Base Voltage	V_{EB}	-5.0		Vdc
Collector Current — Continuous	I_C	-600		mAdc
		Each Transistor	Four Transistors Equal Power	
Total Power Dissipation @ $T_A = 25^\circ\text{C}$ Derate above 25°C	P_D	0.52 4.2	1.0 8.0	Watts mW/ $^\circ\text{C}$
Total Power Dissipation @ $T_C = 25^\circ\text{C}$ Derate above 25°C	P_D	0.8 6.4	2.4 19.2	Watts mW/ $^\circ\text{C}$
Operating and Storage Junction Temperature Range	T_J, T_{stg}	-55 to +150		$^\circ\text{C}$

ELECTRICAL CHARACTERISTICS ($T_A = 25^\circ\text{C}$ unless otherwise noted)

Characteristic	Symbol	Min	Typ	Max	Unit
----------------	--------	-----	-----	-----	------

OFF CHARACTERISTICS

Collector-Emitter Breakdown Voltage ⁽¹⁾ ($I_C = -10$ mAdc, $I_E = 0$)	MMPQ2907 MMPQ2907A	$V_{(BR)CEO}$	-40 -60	— —	— —	Vdc
Collector-Base Breakdown Voltage ($I_C = -10$ μ Adc, $I_E = 0$)		$V_{(BR)CBO}$	-60	—	—	Vdc
Emitter-Base Breakdown Voltage ($I_E = -10$ μ Adc, $I_C = 0$)		$V_{(BR)EBO}$	-5.0	—	—	Vdc
Collector Cutoff Current ($V_{CB} = -30$ Vdc, $I_E = 0$) ($V_{CB} = -50$ Vdc, $I_E = 0$)	MMPQ2907 MMPQ2907A	I_{CBO}	— —	— —	-50 -10	nAdc
Emitter Cutoff Current ($V_{EB} = -3.0$ Vdc, $I_C = 0$)		I_{EBO}	—	—	-50	nAdc

1. Pulse Test: Pulse Width ≤ 300 μ s, Duty Cycle = 2.0%.

ELECTRICAL CHARACTERISTICS ($T_A = 25^\circ\text{C}$ unless otherwise noted) (Continued)

Characteristic	Symbol	Min	Typ	Max	Unit	
ON CHARACTERISTICS						
DC Current Gain ⁽¹⁾ ($I_C = -100\ \mu\text{A}$ dc, $V_{CE} = -10\ \text{V}$ dc) ($I_C = -1.0\ \text{mA}$ dc, $V_{CE} = -10\ \text{V}$ dc) ($I_C = -10\ \text{mA}$ dc, $V_{CE} = -10\ \text{V}$ dc) ($I_C = -150\ \text{mA}$ dc, $V_{CE} = -10\ \text{V}$ dc) ($I_C = -300\ \text{mA}$ dc, $V_{CE} = -10\ \text{V}$ dc) ($I_C = -500\ \text{mA}$ dc, $V_{CE} = -10\ \text{V}$ dc)	MMPQ2907A MMPQ2907A MMPQ2907/2907A MMPQ2907/2907A MMPQ2907/2907A MMPQ2907/2907A	h_{FE}	75 100 75/100 100 30/50 50	— — — — — —	— — — 300 — —	—
Collector–Emitter Saturation Voltage ⁽¹⁾ ($I_C = -150\ \text{mA}$ dc, $I_B = -15\ \text{mA}$ dc) ($I_C = -300\ \text{mA}$ dc, $I_B = -30\ \text{mA}$ dc) ($I_C = -500\ \text{mA}$ dc, $I_B = -50\ \text{mA}$ dc)	MMPQ2907 MMPQ2907 MMPQ2907	$V_{CE(\text{sat})}$	— — —	— — —	-0.4 -1.6 -1.6	Vdc
Base–Emitter Saturation Voltage ⁽¹⁾ ($I_C = -150\ \text{mA}$ dc, $I_B = -15\ \text{mA}$ dc) ($I_C = -300\ \text{mA}$ dc, $I_B = -30\ \text{mA}$ dc) ($I_C = -500\ \text{mA}$ dc, $I_B = -50\ \text{mA}$ dc)	MMPQ2907 MMPQ2907 MMPQ2907A	$V_{BE(\text{sat})}$	— — —	— — —	-1.3 -2.6 -2.6	Vdc

DYNAMIC CHARACTERISTICS

Current–Gain — Bandwidth Product ⁽¹⁾ ($I_C = -50\ \text{mA}$ dc, $V_{CE} = -20\ \text{V}$ dc, $f = 100\ \text{MHz}$)	f_T	200	350	—	MHz
Output Capacitance ($V_{CB} = -10\ \text{V}$ dc, $I_E = 0$, $f = 1.0\ \text{MHz}$)	C_{ob}	—	6.0	—	pF
Input Capacitance ($V_{EB} = -2.0\ \text{V}$ dc, $I_C = 0$, $f = 1.0\ \text{MHz}$)	C_{ib}	—	20	—	pF

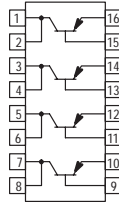
SWITCHING CHARACTERISTICS

Turn–On Time ($V_{CC} = -30\ \text{V}$ dc, $I_C = -150\ \text{mA}$ dc, $I_{B1} = -15\ \text{mA}$ dc)	t_{on}	—	30	—	ns
Turn–Off Time ($V_{CC} = -6.0\ \text{V}$ dc, $I_C = -150\ \text{mA}$ dc, $I_{B1} = I_{B2} = -15\ \text{mA}$ dc)	t_{off}	—	100	—	ns

1. Pulse Test: Pulse Width $\leq 300\ \mu\text{s}$, Duty Cycle = 2.0%.

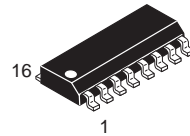
Quad Memory Driver Transistor

PNP Silicon



MMPQ3467

Motorola Preferred Device



CASE 751B-05, STYLE 4
SO-16

MAXIMUM RATINGS

Rating	Symbol	Value		Unit
Collector-Emitter Voltage	V_{CEO}	-40		Vdc
Collector-Base Voltage	V_{CB}	-40		Vdc
Emitter-Base Voltage	V_{EB}	-5.0		Vdc
Collector Current — Continuous	I_C	-1.0		Adc
		Each Transistor	Four Transistors Equal Power	
Power Dissipation @ $T_A = 25^\circ\text{C}$ Derate above 25°C	P_D	0.52 4.2	1.2 9.6	Watts mW/ $^\circ\text{C}$
Power Dissipation @ $T_C = 25^\circ\text{C}$ Derate above 25°C	P_D	1.0 8.0	2.5 20	Watts mW/ $^\circ\text{C}$
Operating and Storage Junction Temperature Range	T_J, T_{stg}	-55 to +150		$^\circ\text{C}$

ELECTRICAL CHARACTERISTICS ($T_A = 25^\circ\text{C}$ unless otherwise noted)

Characteristic	Symbol	Min	Typ	Max	Unit
----------------	--------	-----	-----	-----	------

OFF CHARACTERISTICS

Collector-Emitter Breakdown Voltage ⁽¹⁾ ($I_C = -10 \text{ mAdc}, I_E = 0$)	$V_{(BR)CEO}$	-40	—	—	Vdc
Collector-Base Breakdown Voltage ($I_C = -10 \mu\text{Adc}, I_E = 0$)	$V_{(BR)CBO}$	-40	—	—	Vdc
Emitter-Base Breakdown Voltage ($I_E = -10 \mu\text{Adc}, I_C = 0$)	$V_{(BR)EBO}$	-5.0	—	—	Vdc
Collector Cutoff Current ($V_{CB} = -30 \text{ Vdc}, I_E = 0$)	I_{CBO}	—	—	-200	nAdc
Emitter Cutoff Current ($V_{EB} = -3.0 \text{ Vdc}, I_C = 0$)	I_{EBO}	—	—	-200	nAdc

1. Pulse Test: Pulse Width $\leq 300 \mu\text{s}$; Duty Cycle $\leq 2.0\%$.

Preferred devices are Motorola recommended choices for future use and best overall value.

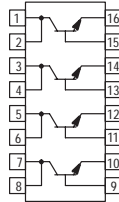
ELECTRICAL CHARACTERISTICS ($T_A = 25^\circ\text{C}$ unless otherwise noted) (Continued)

Characteristic	Symbol	Min	Typ	Max	Unit
ON CHARACTERISTICS					
DC Current Gain ⁽¹⁾ ($I_C = -500\text{ mAdc}$, $V_{CE} = -1.0\text{ Vdc}$)	h_{FE}	20	—	—	—
Collector–Emitter Saturation Voltage ⁽¹⁾ ($I_C = -500\text{ mAdc}$, $I_B = -50\text{ mAdc}$)	$V_{CE(sat)}$	—	-0.23	-0.5	Vdc
Base–Emitter Saturation Voltage ⁽¹⁾ ($I_C = -500\text{ mAdc}$, $I_B = -50\text{ mAdc}$)	$V_{BE(sat)}$	—	-0.9	-1.2	Vdc
DYNAMIC CHARACTERISTICS					
Current–Gain — Bandwidth Product ($I_C = -50\text{ mAdc}$, $V_{CE} = -10\text{ Vdc}$, $f = 100\text{ MHz}$)	f_T	—	190	—	MHz
Output Capacitance ($V_{CB} = -10\text{ Vdc}$, $I_E = 0$, $f = 1.0\text{ MHz}$)	C_{ob}	—	10	—	pF
Input Capacitance ($V_{EB} = -0.5\text{ Vdc}$, $I_C = 0$, $f = 1.0\text{ MHz}$)	C_{ib}	—	55	—	pF
SWITCHING CHARACTERISTICS					
Turn–On Time ($I_C = -500\text{ mAdc}$, $I_{B1} = -50\text{ mAdc}$)	t_{on}	—	20	—	ns
Turn–Off Time ($I_C = -500\text{ mAdc}$, $I_{B1} = I_{B2} = -50\text{ mAdc}$)	t_{off}	—	60	—	ns

1. Pulse Test: Pulse Width $\leq 300\ \mu\text{s}$; Duty Cycle $\leq 2.0\%$.

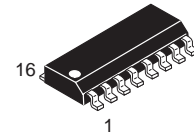
Quad Core Driver Transistor

NPN Silicon



MMPQ3725

Motorola Preferred Device



CASE 751B-05, STYLE 4
SO-16

MAXIMUM RATINGS

Rating	Symbol	Value		Unit
Collector–Emitter Voltage	V_{CEO}	40		Vdc
Collector–Emitter Voltage	V_{CES}	60		Vdc
Emitter–Base Voltage	V_{EB}	5.0		Vdc
Collector Current — Continuous	I_C	1.0		Adc
Operating and Storage Junction Temperature Range	T_J, T_{stg}	–55 to +150		°C
		Each Transistor	Four Transistors Equal Power	
Total Power Dissipation @ $T_A = 25^\circ\text{C}$ Derate above 25°C	P_D	0.6 4.8	1.4 11.2	Watts mW/°C
Power Dissipation @ $T_C = 25^\circ\text{C}$ Derate above 25°C	P_D	1.0 8.0	2.5 2.0	Watts mW/°C
Operating and Storage Junction Temperature Range	T_J, T_{stg}	–55 to +150		°C

ELECTRICAL CHARACTERISTICS ($T_A = 25^\circ\text{C}$ unless otherwise noted)

Characteristic	Symbol	Min	Typ	Max	Unit
----------------	--------	-----	-----	-----	------

OFF CHARACTERISTICS

Collector–Emitter Breakdown Voltage ⁽¹⁾ ($I_C = 10 \text{ mAdc}, I_B = 0$)	$V_{(BR)CEO}$	40	—	—	Vdc
Collector–Base Breakdown Voltage ($I_C = 100 \mu\text{Adc}, V_{BE} = 0$)	$V_{(BR)CES}$	60	—	—	Vdc
Emitter–Base Breakdown Voltage ($I_E = 10 \mu\text{Adc}, I_C = 0$)	$V_{(BR)EBO}$	5.0	—	—	Vdc
Collector Cutoff Current ($V_{CB} = 40 \text{ Vdc}, I_E = 0$)	I_{CBO}	—	—	0.5	μAdc

1. Pulse Test: Pulse Width $\leq 300 \mu\text{s}$; Duty Cycle $\leq 2.0\%$.

Preferred devices are Motorola recommended choices for future use and best overall value.

ELECTRICAL CHARACTERISTICS ($T_A = 25^\circ\text{C}$ unless otherwise noted) (Continued)

Characteristic	Symbol	Min	Typ	Max	Unit
ON CHARACTERISTICS(1)					
DC Current Gain ($I_C = 100\text{ mAdc}$, $V_{CE} = 1.0\text{ Vdc}$) ($I_C = 500\text{ mAdc}$, $V_{CE} = 2.0\text{ Vdc}$)	h_{FE}	35 25	75 45	200 —	—
Collector–Emitter Saturation Voltage ($I_C = 500\text{ mAdc}$, $I_B = 50\text{ mAdc}$)	$V_{CE(sat)}$	—	0.32	0.45	Vdc
Base–Emitter Saturation Voltage ($I_C = 500\text{ mAdc}$, $I_B = 50\text{ mAdc}$)	$V_{BE(sat)}$	0.8	0.9	1.1	Vdc

DYNAMIC CHARACTERISTICS

Current–Gain — Bandwidth Product ($I_C = 50\text{ mAdc}$, $V_{CE} = 10\text{ Vdc}$, $f = 100\text{ MHz}$)	f_T	—	275	—	MHz
Output Capacitance ($V_{CB} = 10\text{ Vdc}$, $I_E = 0$, $f = 1.0\text{ MHz}$)	C_{ob}	—	5.1	—	pF
Input Capacitance ($V_{EB} = 0.5\text{ Vdc}$, $I_C = 0$, $f = 1.0\text{ MHz}$)	C_{ib}	—	62	—	pF

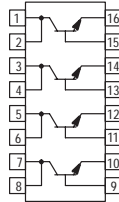
SWITCHING CHARACTERISTICS

Turn–On Time ($I_C = 500\text{ mAdc}$, $I_{B1} = 50\text{ mAdc}$, $V_{BE(off)} = -3.8\text{ Vdc}$)	t_{on}	—	20	—	ns
Turn–Off Time ($I_C = 500\text{ mAdc}$, $I_{B1} = I_{B2} = 50\text{ mAdc}$)	t_{off}	—	50	—	ns

1. Pulse Test: Pulse Width $\leq 300\ \mu\text{s}$; Duty Cycle $\leq 2.0\%$.

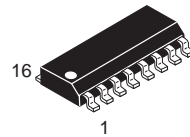
Quad Amplifier/Switch Transistor

NPN Silicon



MMPQ3904

Motorola Preferred Device



CASE 751B-05, STYLE 4
SO-16

MAXIMUM RATINGS

Rating	Symbol	Value		Unit
Collector-Emitter Voltage	V_{CEO}	40		Vdc
Collector-Base Voltage	V_{CB}	60		Vdc
Emitter-Base Voltage	V_{EB}	6.0		Vdc
Collector Current — Continuous	I_C	200		mAdc
		Each Transistor	Four Transistors Equal Power	
Total Power Dissipation @ $T_A = 25^\circ\text{C}$ Derate above 25°C	P_D	0.4 3.2	800 6.4	mW mW/ $^\circ\text{C}$
Total Power Dissipation @ $T_C = 25^\circ\text{C}$ Derate above 25°C	P_D	0.66 5.3	1.92 15.4	Watts mW/ $^\circ\text{C}$
Operating and Storage Junction Temperature Range	T_J, T_{stg}	-55 to +150		$^\circ\text{C}$

ELECTRICAL CHARACTERISTICS ($T_A = 25^\circ\text{C}$ unless otherwise noted)

Characteristic	Symbol	Min	Typ	Max	Unit
----------------	--------	-----	-----	-----	------

OFF CHARACTERISTICS

Collector-Emitter Breakdown Voltage ⁽¹⁾ ($I_C = 1.0 \text{ mAdc}, I_E = 0$)	$V_{(BR)CEO}$	40	—	—	Vdc
Collector-Base Breakdown Voltage ($I_C = 10 \mu\text{Adc}, I_E = 0$)	$V_{(BR)CBO}$	60	—	—	Vdc
Emitter-Base Breakdown Voltage ($I_E = 10 \mu\text{Adc}, I_C = 0$)	$V_{(BR)EBO}$	6.0	—	—	Vdc
Collector Cutoff Current ($V_{CB} = 40 \text{ Vdc}, I_E = 0$)	I_{CBO}	—	—	50	nAdc
Emitter Cutoff Current ($V_{EB} = 4.0 \text{ Vdc}, I_C = 0$)	I_{EBO}	—	—	50	nAdc

1. Pulse Test: Pulse Width $\leq 300 \mu\text{s}$; Duty Cycle $\leq 2.0\%$.

Preferred devices are Motorola recommended choices for future use and best overall value.

ELECTRICAL CHARACTERISTICS ($T_A = 25^\circ\text{C}$ unless otherwise noted) (Continued)

Characteristic	Symbol	Min	Typ	Max	Unit
ON CHARACTERISTICS(1)					
DC Current Gain ($I_C = 0.1\text{ mAdc}$, $V_{CE} = 1.0\text{ Vdc}$) ($I_C = 1.0\text{ mAdc}$, $V_{CE} = 1.0\text{ Vdc}$) ($I_C = 10\text{ mAdc}$, $V_{CE} = 1.0\text{ Vdc}$)	h_{FE}	30 50 75	90 160 200	— — —	—
Collector–Emitter Saturation Voltage ($I_C = 10\text{ mAdc}$, $I_B = 1.0\text{ mAdc}$)	$V_{CE(sat)}$	—	0.1	0.2	Vdc
Base–Emitter Saturation Voltage ($I_C = 10\text{ mAdc}$, $I_B = 1.0\text{ mAdc}$)	$V_{BE(sat)}$	—	0.65	0.85	Vdc

DYNAMIC CHARACTERISTICS

Current–Gain — Bandwidth Product ($I_C = 10\text{ mAdc}$, $V_{CE} = 20\text{ Vdc}$, $f = 100\text{ MHz}$)	f_T	250	300	—	MHz
Output Capacitance ($V_{CB} = 5.0\text{ Vdc}$, $I_E = 0$, $f = 1.0\text{ MHz}$)	C_{ob}	—	2.0	4.0	pF
Input Capacitance ($V_{EB} = 0.5\text{ Vdc}$, $I_C = 0$, $f = 1.0\text{ MHz}$)	C_{ib}	—	4.0	8.0	pF

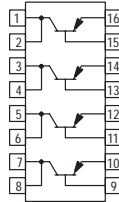
SWITCHING CHARACTERISTICS

Turn–On Time ($I_C = 10\text{ Vdc}$, $V_{BE(off)} = -0.5\text{ Vdc}$, $I_{B1} = 1.0\text{ mAdc}$)	t_{on}	—	37	—	ns
Turn–Off Time ($I_C = 10\text{ mAdc}$, $I_{B1} = I_{B2} = 1.0\text{ mAdc}$)	t_{off}	—	136	—	ns

1. Pulse Test: Pulse Width $\leq 300\ \mu\text{s}$; Duty Cycle $\leq 2.0\%$.

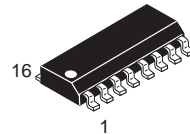
Quad Amplifier/Switch Transistor

PNP Silicon



MMPQ3906

Motorola Preferred Device



CASE 751B-05, STYLE 4
SO-16

MAXIMUM RATINGS

Rating	Symbol	Value		Unit
Collector-Emitter Voltage	V_{CEO}	-40		Vdc
Collector-Base Voltage	V_{CB}	-40		Vdc
Emitter-Base Voltage	V_{EB}	-5.0		Vdc
Collector Current — Continuous	I_C	-200		mAdc
		Each Transistor	Four Transistors Equal Power	
Power Dissipation @ $T_A = 25^\circ\text{C}$ Derate above 25°C	P_D	0.4 3.2	800 6.4	mW mW/ $^\circ\text{C}$
Power Dissipation @ $T_C = 25^\circ\text{C}$ Derate above 25°C	P_D	0.66 5.3	1.92 15.4	Watts mW/ $^\circ\text{C}$
Operating and Storage Junction Temperature Range	T_J, T_{stg}	-55 to +150		$^\circ\text{C}$

ELECTRICAL CHARACTERISTICS ($T_A = 25^\circ\text{C}$ unless otherwise noted)

Characteristic	Symbol	Min	Typ	Max	Unit
----------------	--------	-----	-----	-----	------

OFF CHARACTERISTICS

Collector-Emitter Breakdown Voltage ⁽¹⁾ ($I_C = -1.0$ mAdc, $I_E = 0$)	$V_{(BR)CEO}$	-40	—	—	Vdc
Collector-Base Breakdown Voltage ($I_C = -10$ μ Adc, $I_E = 0$)	$V_{(BR)CBO}$	-40	—	—	Vdc
Emitter-Base Breakdown Voltage ($I_E = -10$ μ Adc, $I_C = 0$)	$V_{(BR)EBO}$	-5.0	—	—	Vdc
Collector Cutoff Current ($V_{CB} = -30$ Vdc, $I_E = 0$)	I_{CBO}	—	—	-50	nAdc
Emitter Cutoff Current ($V_{EB} = -4.0$ Vdc, $I_C = 0$)	I_{EBO}	—	—	-50	nAdc

1. Pulse Test: Pulse Width ≤ 300 μ s; Duty Cycle $\leq 2.0\%$.

Preferred devices are Motorola recommended choices for future use and best overall value.

ELECTRICAL CHARACTERISTICS ($T_A = 25^\circ\text{C}$ unless otherwise noted) (Continued)

Characteristic	Symbol	Min	Typ	Max	Unit
ON CHARACTERISTICS(1)					
DC Current Gain ($I_C = -0.1\text{ mA}$, $V_{CE} = -1.0\text{ Vdc}$) ($I_C = -1.0\text{ mA}$, $V_{CE} = -1.0\text{ Vdc}$) ($I_C = -10\text{ mA}$, $V_{CE} = -1.0\text{ Vdc}$)	h_{FE}	40 60 75	160 180 200	— — —	—
Collector–Emitter Saturation Voltage ($I_C = -10\text{ mA}$, $I_B = -1.0\text{ mA}$)	$V_{CE(sat)}$	—	-0.1	-0.25	Vdc
Base–Emitter Saturation Voltage ($I_C = -10\text{ mA}$, $I_B = -1.0\text{ mA}$)	$V_{BE(sat)}$	—	-0.65	-0.85	Vdc

DYNAMIC CHARACTERISTICS

Current–Gain — Bandwidth Product ($I_C = -10\text{ mA}$, $V_{CE} = -20\text{ Vdc}$, $f = 100\text{ MHz}$)	f_T	200	250	—	MHz
Output Capacitance ($V_{CB} = -5.0\text{ Vdc}$, $I_E = 0$, $f = 1.0\text{ MHz}$)	C_{ob}	—	3.3	4.5	pF
Input Capacitance ($V_{EB} = -0.5\text{ Vdc}$, $I_C = 0$, $f = 1.0\text{ MHz}$)	C_{ib}	—	4.8	10	pF

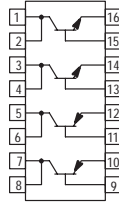
SWITCHING CHARACTERISTICS

Turn–On Time ($I_C = -10\text{ mA}$, $V_{BE(off)} = 0.5\text{ Vdc}$, $I_{B1} = -1.0\text{ mA}$)	t_{on}	—	43	—	ns
Turn–Off Time ($I_C = -10\text{ mA}$, $I_{B1} = I_{B2} = -1.0\text{ mA}$)	t_{off}	—	155	—	ns

1. Pulse Test: Pulse Width $\leq 300\ \mu\text{s}$; Duty Cycle $\leq 2.0\%$.

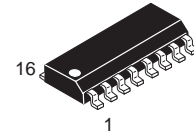
Quad Complementary Pair Transistor

PNP/NPN Silicon



MMPQ6700

Voltage and current are negative for PNP transistors



CASE 751B-05, STYLE 4
SO-16

MAXIMUM RATINGS

Rating	Symbol	Value		Unit
Collector–Emitter Voltage	V_{CEO}	40		Vdc
Collector–Base Voltage	V_{CB}	40		Vdc
Emitter–Base Voltage	V_{EB}	5.0		Vdc
Collector Current — Continuous	I_C	200		mAdc
		Each Transistor	Four Transistors Equal Power	
Total Power Dissipation @ $T_A = 25^\circ\text{C}$ Derate above 25°C	P_D	0.4 3.2	0.72 6.4	Watts mW/ $^\circ\text{C}$
Total Power Dissipation @ $T_C = 25^\circ\text{C}$ Derate above 25°C	P_D	0.66 5.3	1.92 15.4	Watts mW/ $^\circ\text{C}$
Operating and Storage Junction Temperature Range	T_J, T_{stg}	–55 to +150		$^\circ\text{C}$

ELECTRICAL CHARACTERISTICS ($T_A = 25^\circ\text{C}$ unless otherwise noted)

Characteristic	Symbol	Min	Max	Unit
----------------	--------	-----	-----	------

OFF CHARACTERISTICS

Collector–Emitter Breakdown Voltage ⁽¹⁾ ($I_C = 10\text{ mAdc}, I_B = 0$)	$V_{(BR)CEO}$	40	—	Vdc
Collector–Base Breakdown Voltage ($I_C = 10\ \mu\text{Adc}, I_E = 0$)	$V_{(BR)CBO}$	40	—	Vdc
Emitter–Base Breakdown Voltage ($I_E = 10\ \mu\text{Adc}, I_C = 0$)	$V_{(BR)EBO}$	5.0	—	Vdc
Collector Cutoff Current ($V_{CB} = 30\text{ Vdc}, I_E = 0$)	I_{CBO}	—	50	nAdc
Emitter Cutoff Current ($V_{EB} = 4.0\text{ Vdc}, I_C = 0$)	I_{EBO}	—	50	nAdc

ON CHARACTERISTICS⁽¹⁾

DC Current Gain ($I_C = 0.1\text{ mAdc}, V_{CE} = 1.0\text{ Vdc}$) ($I_C = 1.0\text{ mAdc}, V_{CE} = 1.0\text{ Vdc}$) ($I_C = 10\text{ mAdc}, V_{CE} = 1.0\text{ Vdc}$)	h_{FE}	35 50 70	— — —	—
Collector–Emitter Saturation Voltage ($I_C = 10\text{ mAdc}, I_B = 1.0\text{ mAdc}$)	$V_{CE(sat)}$	—	0.25	Vdc
Base–Emitter Saturation Voltage ($I_C = 10\text{ mAdc}, I_B = 1.0\text{ mAdc}$)	$V_{BE(sat)}$	—	0.9	Vdc

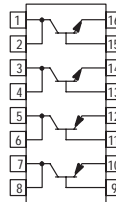
DYNAMIC CHARACTERISTICS

Current–Gain — Bandwidth Product ⁽¹⁾ ($I_C = 10\text{ mAdc}, V_{CE} = 20\text{ Vdc}, f = 100\text{ MHz}$)	f_T	200	—	MHz
Output Capacitance ($V_{CB} = 5.0\text{ Vdc}, I_E = 0, f = 1.0\text{ MHz}$)	C_{ob}	—	4.5	pF
Input Capacitance ($V_{EB} = 0.5\text{ Vdc}, I_C = 0, f = 1.0\text{ MHz}$)	C_{ib}	— —	10 8.0	pF
		PNP NPN		

1. Pulse Test: Pulse Width $\leq 300\ \mu\text{s}$, Duty Cycle $\leq 2.0\%$.

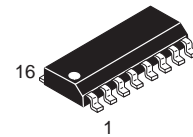
Quad MPU Clock Buffer Transistor

NPN/PNP Silicon



MMPQ6842

Voltage and current are negative for PNP transistors



CASE 751B-05, STYLE 4
SO-16

MAXIMUM RATINGS

Rating	Symbol	Value		Unit
Collector–Emitter Voltage	V_{CEO}	30		Vdc
Collector–Base Voltage	V_{CB}	30		Vdc
Emitter–Base Voltage	V_{EB}	4.0		Vdc
Collector Current — Continuous	I_C	200		mAdc
		Each Transistor	Four Transistors Equal Power	
Total Power Dissipation @ $T_A = 25^\circ\text{C}$ Derate above 25°C	P_D	0.4	0.72	Watts
		3.2	6.4	mW/ $^\circ\text{C}$
Total Power Dissipation @ $T_C = 25^\circ\text{C}$ Derate above 25°C	P_D	0.66	1.92	Watts
		5.3	15.4	mW/ $^\circ\text{C}$
Operating and Storage Junction Temperature Range	T_J, T_{stg}	–55 to +150		$^\circ\text{C}$

ELECTRICAL CHARACTERISTICS ($T_A = 25^\circ\text{C}$ unless otherwise noted)

Characteristic	Symbol	Min	Typ	Max	Unit
----------------	--------	-----	-----	-----	------

OFF CHARACTERISTICS

Collector–Emitter Breakdown Voltage ⁽¹⁾ ($I_C = 10 \text{ mAdc}, I_E = 0$)	$V_{(BR)CEO}$	30	—	—	Vdc
Collector–Base Breakdown Voltage ($I_C = 10 \text{ } \mu\text{Adc}, I_E = 0$)	$V_{(BR)CBO}$	30	—	—	Vdc
Emitter–Base Breakdown Voltage ($I_E = 10 \text{ } \mu\text{Adc}, I_C = 0$)	$V_{(BR)EBO}$	4.0	—	—	Vdc
Collector Cutoff Current ($V_{CB} = 20 \text{ Vdc}, I_E = 0$)	I_{CBO}	—	—	50	nAdc
Emitter Cutoff Current ($V_{EB} = 3.0 \text{ Vdc}, I_C = 0$)	I_{EBO}	—	—	50	nAdc

1. Pulse Test: Pulse Width $\leq 300 \text{ } \mu\text{s}$; Duty Cycle $\leq 2.0\%$.

MMPQ6842**ELECTRICAL CHARACTERISTICS** ($T_A = 25^\circ\text{C}$ unless otherwise noted) (Continued)

Characteristic	Symbol	Min	Typ	Max	Unit
ON CHARACTERISTICS(1)					
DC Current Gain ($I_C = 0.5 \text{ mAdc}$, $V_{CE} = 1.0 \text{ Vdc}$) ($I_C = 1.0 \text{ mAdc}$, $V_{CE} = 1.0 \text{ Vdc}$) ($I_C = 10 \text{ mAdc}$, $V_{CE} = 1.0 \text{ Vdc}$)	h_{FE}	30 50 70	— — —	— — —	—
Collector–Emitter Saturation Voltage ($I_C = 0.5 \text{ mAdc}$, $I_B = 0.05 \text{ mAdc}$, $0^\circ\text{C} \leq T \leq 70^\circ\text{C}$)	$V_{CE(sat)}$	—	0.05	0.15	Vdc
Base–Emitter Saturation Voltage ($I_C = 0.5 \text{ mAdc}$, $I_B = 0.05 \text{ mAdc}$)	$V_{BE(sat)}$	—	0.65	0.9	Vdc

DYNAMIC CHARACTERISTICS

Current–Gain — Bandwidth Product ⁽¹⁾ ($I_C = 10 \text{ mAdc}$, $V_{CE} = 20 \text{ Vdc}$, $f = 100 \text{ MHz}$)	f_T	200	350	—	MHz
Output Capacitance ($V_{CB} = 5.0 \text{ Vdc}$, $I_E = 0$, $f = 1.0 \text{ MHz}$)	C_{ob}	—	3.0	4.5	pF
Input Capacitance ($V_{EB} = 0.5 \text{ Vdc}$, $I_C = 0$, $f = 1.0 \text{ MHz}$)	C_{ib}	—	5.0	10	pF
		—	4.0	8.0	
	PNP				
	NPN				

SWITCHING CHARACTERISTICS ($T_A = 25^\circ\text{C}$, $V_{CC} = 5.0 \text{ Vdc}$)

Propagation Delay Time (50% Points TP1 to TP3) (50% Points TP2 to TP4)	t_{PLH} t_{PHL}	— —	15 6.0	25 15	ns
Rise Time (0.3 V to 4.7 V, TP3 or TP4)	t_r	5.0	25	35	ns
Fall Time (4.7 V to 0.3 V, TP3 or TP4)	t_f	5.0	10	20	ns

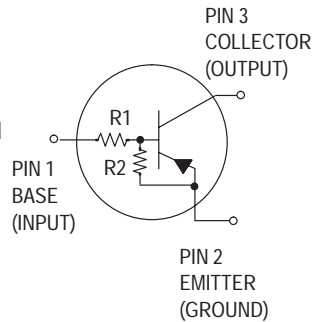
1. Pulse Test: Pulse Width $\leq 300 \mu\text{s}$; Duty Cycle $\leq 2.0\%$.

Bias Resistor Transistor

PNP Silicon Surface Mount Transistor with Monolithic Bias Resistor Network

This new series of digital transistors is designed to replace a single device and its external resistor bias network. The BRT (Bias Resistor Transistor) contains a single transistor with a monolithic bias network consisting of two resistors; a series base resistor and a base-emitter resistor. The BRT eliminates these individual components by integrating them into a single device. The use of a BRT can reduce both system cost and board space. The device is housed in the SOT-23 package which is designed for low power surface mount applications.

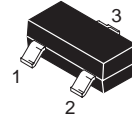
- Simplifies Circuit Design
- Reduces Board Space
- Reduces Component Count
- The SOT-23 package can be soldered using wave or reflow. The modified gull-winged leads absorb thermal stress during soldering eliminating the possibility of damage to the die.
- Available in 8 mm embossed tape and reel. Use the Device Number to order the 7 inch/3000 unit reel. Replace "T1" with "T3" in the Device Number to order the 13 inch/10,000 unit reel.



MMUN2111LT1 SERIES

Motorola Preferred Devices

PNP SILICON BIAS RESISTOR TRANSISTOR



CASE 318-08, STYLE 6
SOT-23 (TO-236AB)

MAXIMUM RATINGS ($T_A = 25^\circ\text{C}$ unless otherwise noted)

Rating	Symbol	Value	Unit
Collector-Base Voltage	V_{CBO}	50	Vdc
Collector-Emitter Voltage	V_{CEO}	50	Vdc
Collector Current	I_C	100	mAdc
Total Power Dissipation @ $T_A = 25^\circ\text{C}$ (1) Derate above 25°C	P_D	200 1.6	mW mW/ $^\circ\text{C}$

THERMAL CHARACTERISTICS

Rating	Symbol	Value	Unit
Thermal Resistance — Junction-to-Ambient (surface mounted)	$R_{\theta JA}$	625	$^\circ\text{C}/\text{W}$
Operating and Storage Temperature Range	T_J, T_{stg}	-65 to +150	$^\circ\text{C}$
Maximum Temperature for Soldering Purposes, Time in Solder Bath	T_L	260 10	$^\circ\text{C}$ Sec

DEVICE MARKING AND RESISTOR VALUES

Device	Marking	R1 (K)	R2 (K)
MMUN2111LT1	A6A	10	10
MMUN2112LT1	A6B	22	22
MMUN2113LT1	A6C	47	47
MMUN2114LT1	A6D	10	47
MMUN2115LT1(2)	A6E	10	∞

1. Device mounted on a FR-4 glass epoxy printed circuit board using the minimum recommended footprint.
2. New devices. Updated curves to follow in subsequent data sheets.

Preferred devices are Motorola recommended choices for future use and best overall value.

(Replaces MMUN2111T1/D)

MMUN2111LT1 SERIES

DEVICE MARKING AND RESISTOR VALUES (Continued)

Device	Marking	R1 (K)	R2 (K)
MMUN2116LT1(2)	A6F	4.7	∞
MMUN2130LT1(2)	A6G	1.0	1.0
MMUN2131LT1(2)	A6H	2.2	2.2
MMUN2132LT1(2)	A6J	4.7	4.7
MMUN2133LT1(2)	A6K	4.7	47
MMUN2134LT1(2)	A6L	22	47

ELECTRICAL CHARACTERISTICS (T_A = 25°C unless otherwise noted)

Characteristic	Symbol	Min	Typ	Max	Unit
----------------	--------	-----	-----	-----	------

OFF CHARACTERISTICS

Collector-Base Cutoff Current (V _{CB} = 50 V, I _E = 0)	I _{CBO}	—	—	100	nAdc
Collector-Emitter Cutoff Current (V _{CE} = 50 V, I _B = 0)	I _{CEO}	—	—	500	nAdc
Emitter-Base Cutoff Current (V _{EB} = 6.0 V, I _C = 0)	I _{EBO}	—	—	0.5	mAdc
	MMUN2111LT1	—	—	0.2	
	MMUN2112LT1	—	—	0.1	
	MMUN2113LT1	—	—	0.2	
	MMUN2114LT1	—	—	0.9	
	MMUN2115LT1	—	—	1.9	
	MMUN2116LT1	—	—	4.3	
	MMUN2130LT1	—	—	2.3	
	MMUN2131LT1	—	—	1.5	
	MMUN2132LT1	—	—	0.18	
	MMUN2133LT1	—	—	0.13	
	MMUN2134LT1	—	—		
Collector-Base Breakdown Voltage (I _C = 10 μA, I _E = 0)	V _{(BR)CBO}	50	—	—	Vdc
Collector-Emitter Breakdown Voltage ⁽³⁾ (I _C = 2.0 mA, I _B = 0)	V _{(BR)CEO}	50	—	—	Vdc

ON CHARACTERISTICS⁽³⁾

DC Current Gain (V _{CE} = 10 V, I _C = 5.0 mA)	h _{FE}	35	60	—	
	MMUN2111LT1	60	100	—	
	MMUN2112LT1	80	140	—	
	MMUN2113LT1	80	140	—	
	MMUN2114LT1	160	250	—	
	MMUN2115LT1	160	250	—	
	MMUN2116LT1	3.0	5.0	—	
	MMUN2130LT1	8.0	15	—	
	MMUN2131LT1	15	27	—	
	MMUN2132LT1	80	140	—	
	MMUN2133LT1	80	130	—	
	MMUN2134LT1				
Collector-Emitter Saturation Voltage (I _C = 10 mA, I _E = 0.3 mA) (I _C = 10 mA, I _B = 5 mA) MMUN2130LT1/MMUN2131LT1 (I _C = 10 mA, I _B = 1 mA) MMUN2115LT1/MMUN2116LT1/ MMUN2132LT1/MMUN2133LT1/MMUN2134LT1	V _{CE(sat)}	—	—	0.25	Vdc
Output Voltage (on) (V _{CC} = 5.0 V, V _B = 2.5 V, R _L = 1.0 kΩ)	V _{OL}	—	—	0.2	Vdc
	MMUN2111LT1	—	—	0.2	
	MMUN2112LT1	—	—	0.2	
	MMUN2114LT1	—	—	0.2	
	MMUN2115LT1	—	—	0.2	
	MMUN2116LT1	—	—	0.2	
	MMUN2130LT1	—	—	0.2	
	MMUN2131LT1	—	—	0.2	
	MMUN2132LT1	—	—	0.2	
	MMUN2133LT1	—	—	0.2	
	MMUN2134LT1	—	—	0.2	
(V _{CC} = 5.0 V, V _B = 3.5 V, R _L = 1.0 kΩ)	MMUN2113LT1	—	—	0.2	

2. New devices. Updated curves to follow in subsequent data sheets.

3. Pulse Test: Pulse Width < 300 μs, Duty Cycle < 2.0%

ELECTRICAL CHARACTERISTICS ($T_A = 25^\circ\text{C}$ unless otherwise noted) (Continued)

Characteristic	Symbol	Min	Typ	Max	Unit
Output Voltage (off) ($V_{CC} = 5.0\text{ V}$, $V_B = 0.5\text{ V}$, $R_L = 1.0\text{ k}\Omega$) ($V_{CC} = 5.0\text{ V}$, $V_B = 0.25\text{ V}$, $R_L = 1.0\text{ k}\Omega$) MMUN2115LT1 MMUN2116LT1 MMUN2131LT1 MMUN2132LT1 ($V_{CC} = 5.0\text{ V}$, $V_B = 0.050\text{ V}$, $R_L = 1.0\text{ k}\Omega$) MMUN2130LT1	V_{OH}	4.9	—	—	Vdc
Input Resistor MMUN2111LT1 MMUN2112LT1 MMUN2113LT1 MMUN2114LT1 MMUN2115LT1 MMUN2116LT1 MMUN2130LT1 MMUN2131LT1 MMUN2132LT1 MMUN2133LT1 MMUN2134LT1	R1	7.0 15.4 32.9 7.0 7.0 3.3 0.7 1.5 3.3 3.3 15.4	10 22 47 10 10 4.7 1.0 2.2 4.7 4.7 22	13 28.6 61.1 13 13 6.1 1.3 2.9 6.1 6.1 28.6	k Ω
Resistor Ratio MMUN2111LT1/MMUN2112LT1/MMUN2113LT1 MMUN2114LT1 MMUN2115LT1/MMUN2116LT1 MMUN2130LT1/MMUN2131LT1/MMUN2132LT1 MMUN2133LT1	R_1/R_2	0.8 0.17 — 0.8 0.055	1.0 0.21 — 1.0 0.1	1.2 0.25 — 1.2 0.185	

TYPICAL ELECTRICAL CHARACTERISTICS
MMUN2111LT1

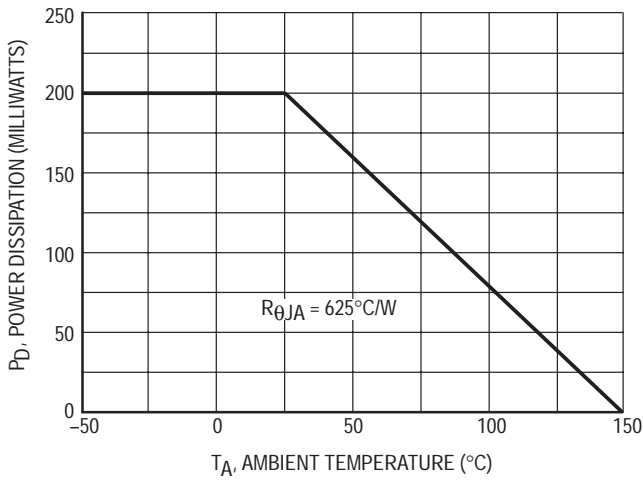


Figure 1. Derating Curve

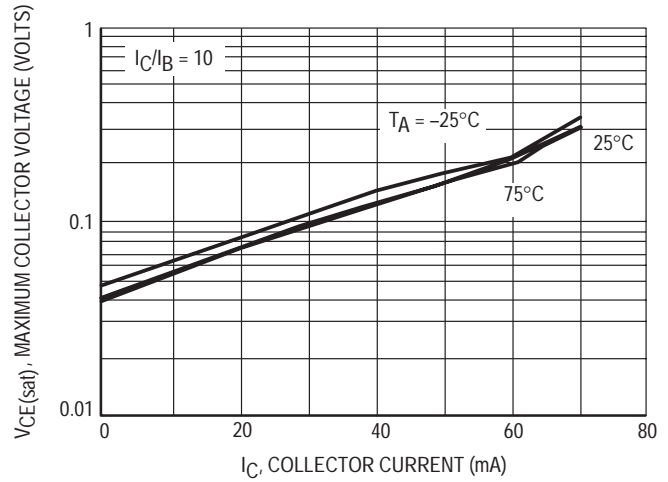


Figure 2. $V_{CE(sat)}$ versus I_C

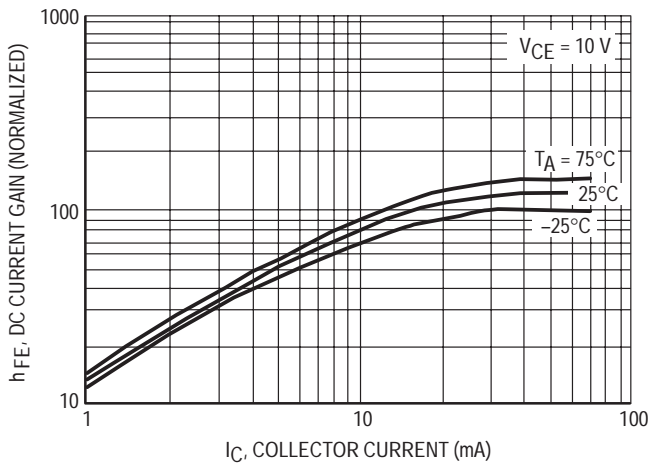


Figure 3. DC Current Gain

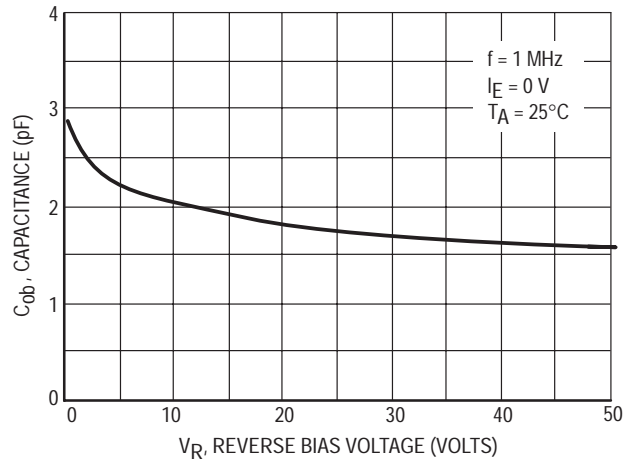


Figure 4. Output Capacitance

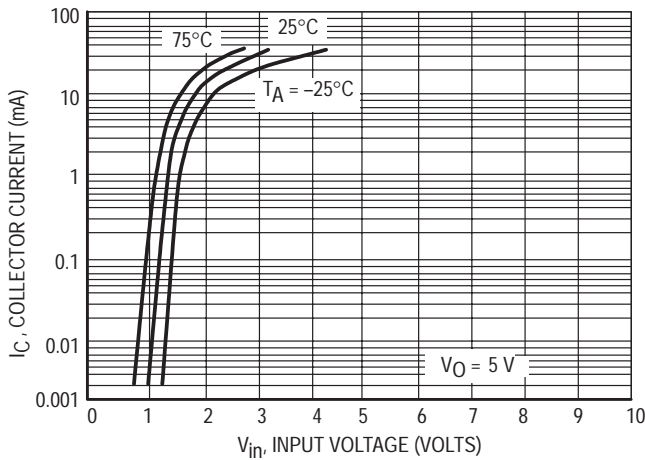


Figure 5. Output Current versus Input Voltage

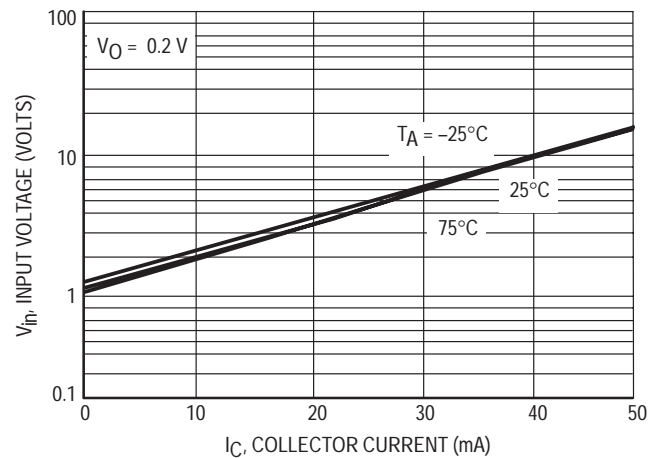


Figure 6. Input Voltage versus Output Current

TYPICAL ELECTRICAL CHARACTERISTICS
MMUN2112LT1

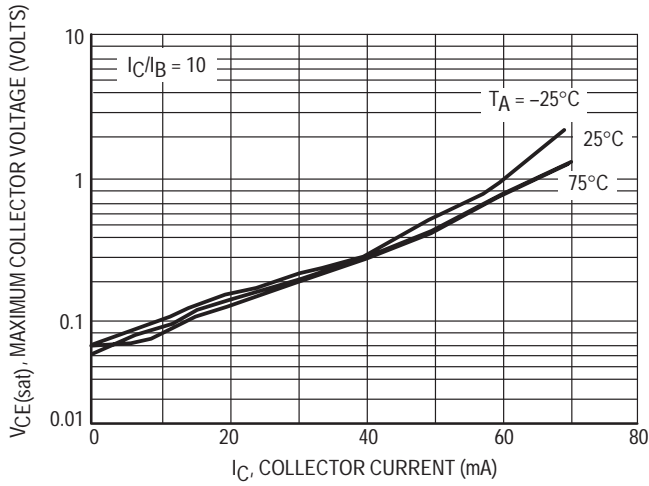


Figure 7. $V_{CE(sat)}$ versus I_C

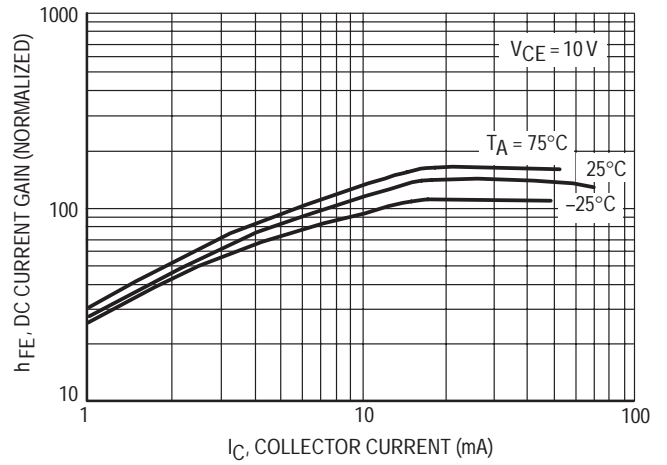


Figure 8. DC Current Gain

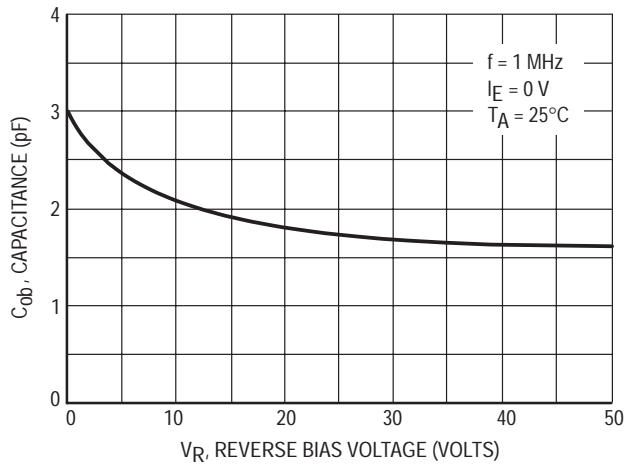


Figure 9. Output Capacitance

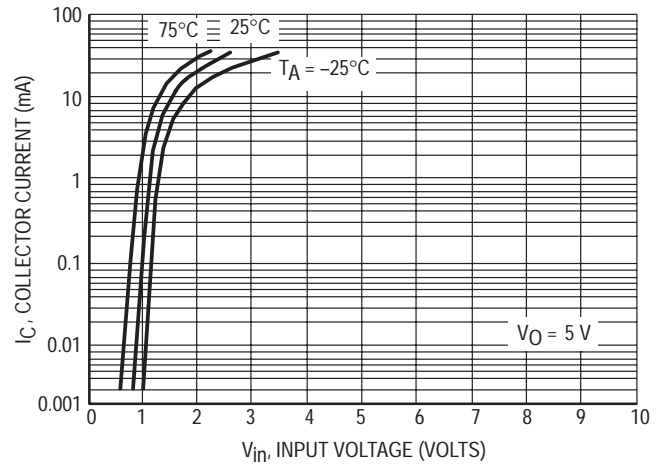


Figure 10. Output Current versus Input Voltage

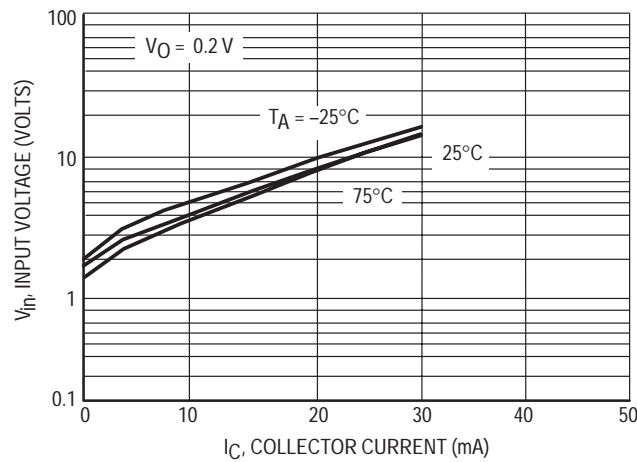


Figure 11. Input Voltage versus Output Current

TYPICAL ELECTRICAL CHARACTERISTICS
MMUN2113LT1

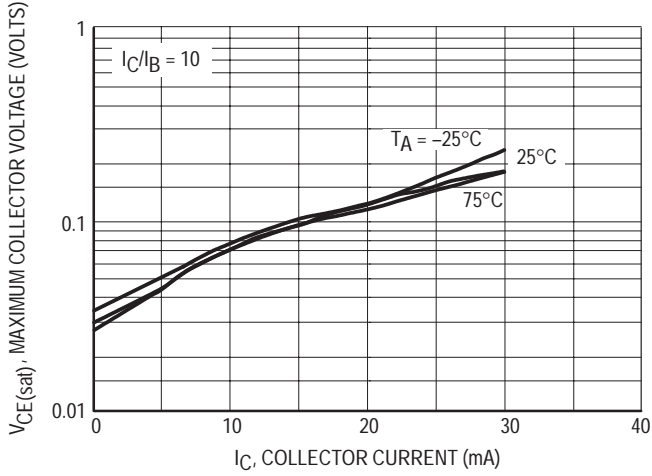


Figure 12. $V_{CE(sat)}$ versus I_C

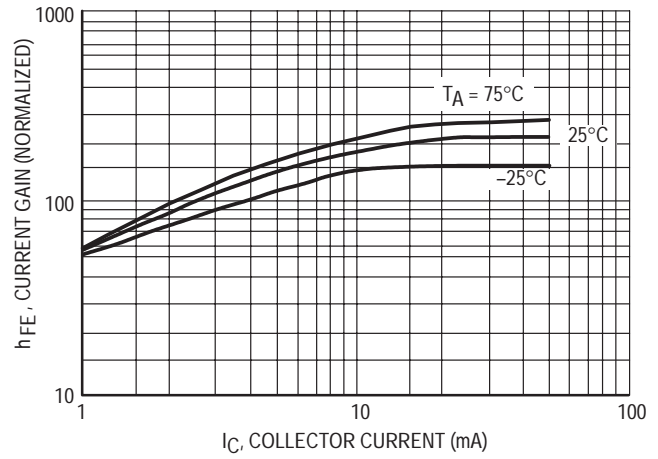


Figure 13. DC Current Gain

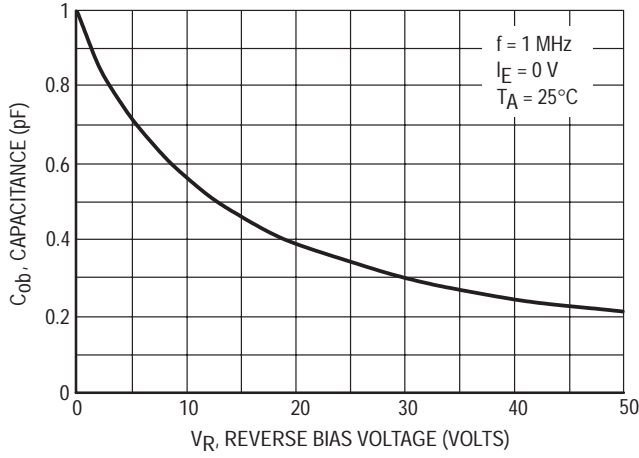


Figure 14. Output Capacitance

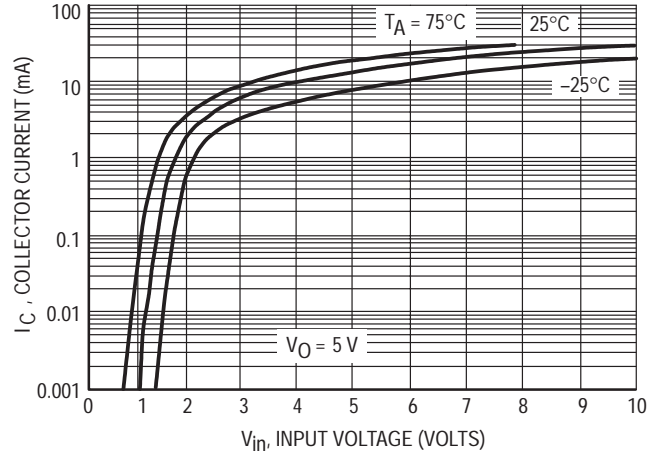


Figure 15. Output Current versus Input Voltage

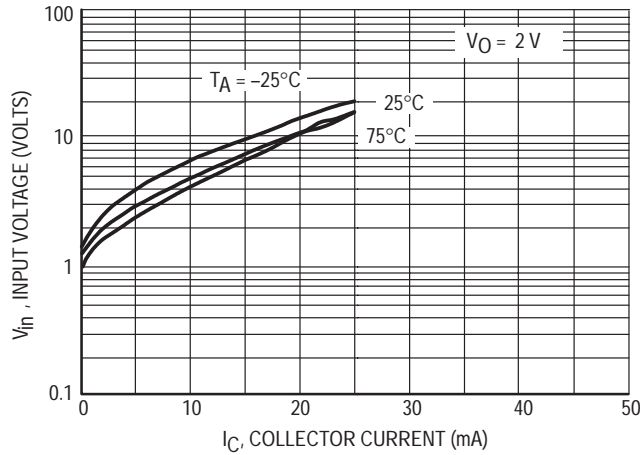


Figure 16. Input Voltage versus Output Current

TYPICAL ELECTRICAL CHARACTERISTICS
MMUN2114LT1

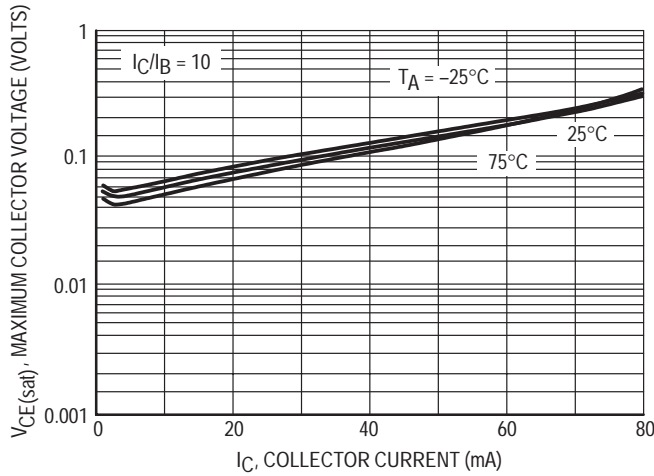


Figure 17. $V_{CE(sat)}$ versus I_C

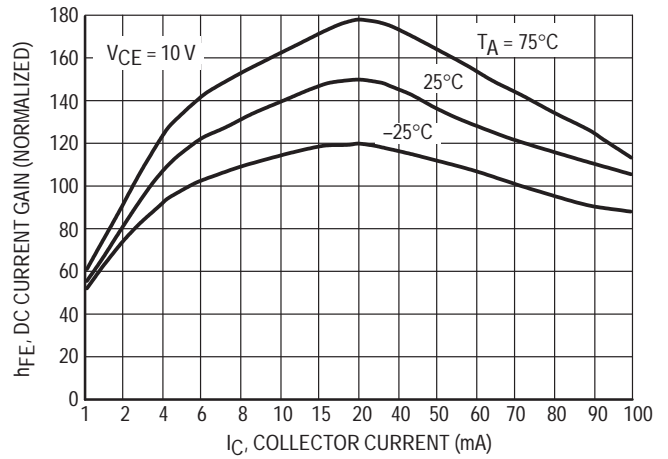


Figure 18. DC Current Gain

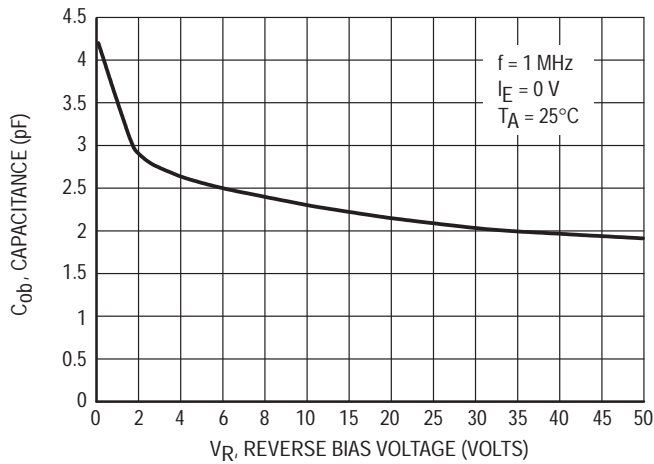


Figure 19. Output Capacitance

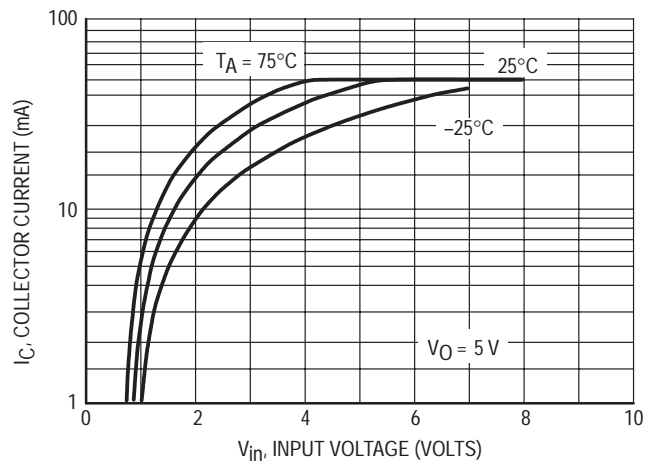


Figure 20. Output Current versus Input Voltage

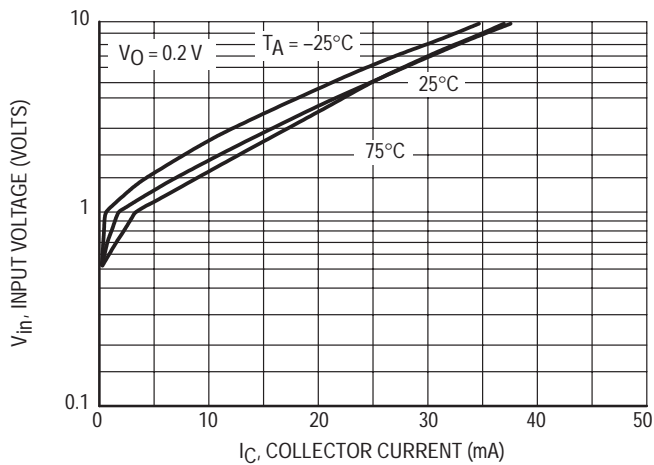


Figure 21. Input Voltage versus Output Current

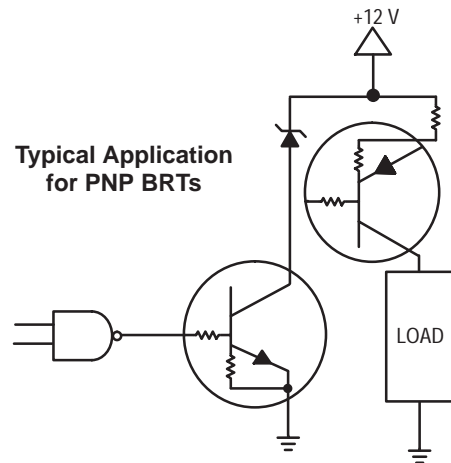


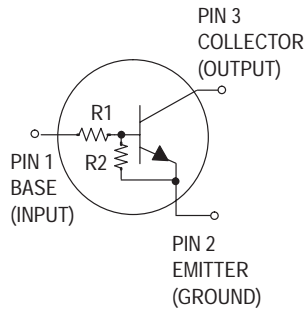
Figure 22. Inexpensive, Unregulated Current Source

Bias Resistor Transistor

NPN Silicon Surface Mount Transistor with Monolithic Bias Resistor Network

This new series of digital transistors is designed to replace a single device and its external resistor bias network. The BRT (Bias Resistor Transistor) contains a single transistor with a monolithic bias network consisting of two resistors; a series base resistor and a base-emitter resistor. The BRT eliminates these individual components by integrating them into a single device. The use of a BRT can reduce both system cost and board space. The device is housed in the SOT-23 package which is designed for low power surface mount applications.

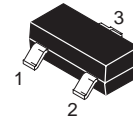
- Simplifies Circuit Design
- Reduces Board Space
- Reduces Component Count
- The SOT-23 package can be soldered using wave or reflow. The modified gull-winged leads absorb thermal stress during soldering eliminating the possibility of damage to the die.
- Available in 8 mm embossed tape and reel. Use the Device Number to order the 7 inch/3000 unit reel. Replace "T1" with "T3" in the Device Number to order the 13 inch/10,000 unit reel.



MMUN2211LT1 SERIES

Motorola Preferred Devices

NPN SILICON BIAS RESISTOR TRANSISTOR



CASE 318-08, STYLE 6
SOT-23 (TO-236AB)

MAXIMUM RATINGS ($T_A = 25^\circ\text{C}$ unless otherwise noted)

Rating	Symbol	Value	Unit
Collector-Base Voltage	V_{CBO}	50	Vdc
Collector-Emitter Voltage	V_{CEO}	50	Vdc
Collector Current	I_C	100	mAdc
Total Power Dissipation @ $T_A = 25^\circ\text{C}$ (1) Derate above 25°C	P_D	200 1.6	mW mW/°C

THERMAL CHARACTERISTICS

Thermal Resistance — Junction-to-Ambient (surface mounted)	$R_{\theta JA}$	625	°C/W
Operating and Storage Temperature Range	T_J, T_{stg}	-65 to +150	°C
Maximum Temperature for Soldering Purposes, Time in Solder Bath	T_L	260 10	°C Sec

DEVICE MARKING AND RESISTOR VALUES

Device	Marking	R1 (K)	R2 (K)
MMUN2211LT1	A8A	10	10
MMUN2212LT1	A8B	22	22
MMUN2213LT1	A8C	47	47
MMUN2214LT1	A8D	10	47
MMUN2215LT1(2)	A8E	10	∞
MMUN2216LT1(2)	A8F	4.7	∞
MMUN2230LT1(2)	A8G	1	1
MMUN2231LT1(2)	A8H	2.2	2.2
MMUN2232LT1(2)	A8J	4.7	4.7
MMUN2233LT1(2)	A8K	4.7	47
MMUN2234LT1(2)	A8L	22	47

1. Device mounted on a FR-4 glass epoxy printed circuit board using the minimum recommended footprint.
2. New devices. Updated curves to follow in subsequent data sheets.

Preferred devices are Motorola recommended choices for future use and best overall value.

(Replaces MMUN2211T1/D)

ELECTRICAL CHARACTERISTICS ($T_A = 25^\circ\text{C}$ unless otherwise noted)

Characteristic	Symbol	Min	Typ	Max	Unit
OFF CHARACTERISTICS					
Collector-Base Cutoff Current ($V_{CB} = 50\text{ V}$, $I_E = 0$)	I_{CBO}	—	—	100	nAdc
Collector-Emitter Cutoff Current ($V_{CE} = 50\text{ V}$, $I_B = 0$)	I_{CEO}	—	—	500	nAdc
Emitter-Base Cutoff Current ($V_{EB} = 6.0\text{ V}$, $I_C = 0$)	I_{EBO}	—	—	0.5	mAdc
	MMUN2211LT1	—	—	0.2	
	MMUN2212LT1	—	—	0.1	
	MMUN2213LT1	—	—	0.2	
	MMUN2214LT1	—	—	0.9	
	MMUN2215LT1	—	—	1.9	
	MMUN2216LT1	—	—	4.3	
	MMUN2230LT1	—	—	2.3	
	MMUN2231LT1	—	—	1.5	
	MMUN2232LT1	—	—	0.18	
	MMUN2233LT1	—	—	0.13	
	MMUN2234LT1	—	—		
Collector-Base Breakdown Voltage ($I_C = 10\ \mu\text{A}$, $I_E = 0$)	$V_{(BR)CBO}$	50	—	—	Vdc
Collector-Emitter Breakdown Voltage ⁽³⁾ ($I_C = 2.0\text{ mA}$, $I_B = 0$)	$V_{(BR)CEO}$	50	—	—	Vdc

ON CHARACTERISTICS⁽³⁾

DC Current Gain ($V_{CE} = 10\text{ V}$, $I_C = 5.0\text{ mA}$)	MMUN2211LT1 MMUN2212LT1 MMUN2213LT1 MMUN2214LT1 MMUN2215LT1 MMUN2216LT1 MMUN2230LT1 MMUN2231LT1 MMUN2232LT1 MMUN2233LT1 MMUN2234LT1	h_{FE}	35 60 80 80 160 160 3.0 8.0 15 80 80	60 100 140 140 350 350 5.0 15 30 200 150	— — — — — — — — — — —	
Collector-Emitter Saturation Voltage ($I_C = 10\text{ mA}$, $I_B = 0.3\text{ mA}$) ($I_C = 10\text{ mA}$, $I_B = 5\text{ mA}$) MMUN2230LT1/MMUN2231LT1 ($I_C = 10\text{ mA}$, $I_B = 1\text{ mA}$) MMUN2215LT1/MMUN2216LT1 MMUN2232LT1/MMUN2233LT1/MMUN2234LT1		$V_{CE(sat)}$	—	—	0.25	Vdc
Output Voltage (on) ($V_{CC} = 5.0\text{ V}$, $V_B = 2.5\text{ V}$, $R_L = 1.0\text{ k}\Omega$)	MMUN2211LT1 MMUN2212LT1 MMUN2214LT1 MMUN2215LT1 MMUN2216LT1 MMUN2230LT1 MMUN2231LT1 MMUN2232LT1 MMUN2233LT1 MMUN2234LT1 MMUN2213LT1	V_{OL}	— — — — — — — — — — —	— — — — — — — — — — —	0.2 0.2 0.2 0.2 0.2 0.2 0.2 0.2 0.2 0.2 0.2	Vdc
Output Voltage (off) ($V_{CC} = 5.0\text{ V}$, $V_B = 0.5\text{ V}$, $R_L = 1.0\text{ k}\Omega$) ($V_{CC} = 5.0\text{ V}$, $V_B = 0.050\text{ V}$, $R_L = 1.0\text{ k}\Omega$) ($V_{CC} = 5.0\text{ V}$, $V_B = 0.25\text{ V}$, $R_L = 1.0\text{ k}\Omega$)	MMUN2230LT1 MMUN2215LT1 MMUN2216LT1 MMUN2233LT1	V_{OH}	4.9	—	—	Vdc

 3. Pulse Test: Pulse Width < 300 μs , Duty Cycle < 2.0%.

MMUN2211LT1 SERIES

ELECTRICAL CHARACTERISTICS (T_A = 25°C unless otherwise noted) (Continued)

Characteristic		Symbol	Min	Typ	Max	Unit
ON CHARACTERISTICS(3)						
Input Resistor	MMUN2211LT1	R1	7.0	10	13	k Ω
	MMUN2212LT1		15.4	22	28.6	
	MMUN2213LT1		32.9	47	61.1	
	MMUN2214LT1		7.0	10	13	
	MMUN2215LT1		7.0	10	13	
	MMUN2216LT1		3.3	4.7	6.1	
	MMUN2230LT1		0.7	1.0	1.3	
	MMUN2231LT1		1.5	2.2	2.9	
	MMUN2232LT1		3.3	4.7	6.1	
	MMUN2233LT1		3.3	4.7	6.1	
	MMUN2234LT1		15.4	22	28.6	
Resistor Ratio	MMUN2211LT1/MMUN2212LT1/MMUN2213LT1	R1/R2	0.8	1.0	1.2	
	MMUN2214LT1		0.17	0.21	0.25	
	MMUN2215LT1/MMUN2216LT1		—	—	—	
	MMUN2230LT1/MMUN2231LT1/MMUN2232LT1		0.8	1.0	1.2	
	MMUN2233LT1		0.055	0.1	0.185	
	MMUN2234LT1		0.38	0.47	0.56	

3. Pulse Test: Pulse Width < 300 μs, Duty Cycle < 2.0%.

TYPICAL ELECTRICAL CHARACTERISTICS
MMUN2211LT1

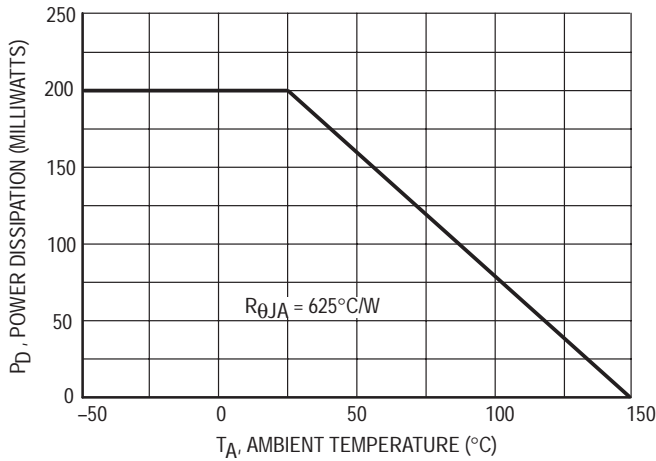


Figure 1. Derating Curve

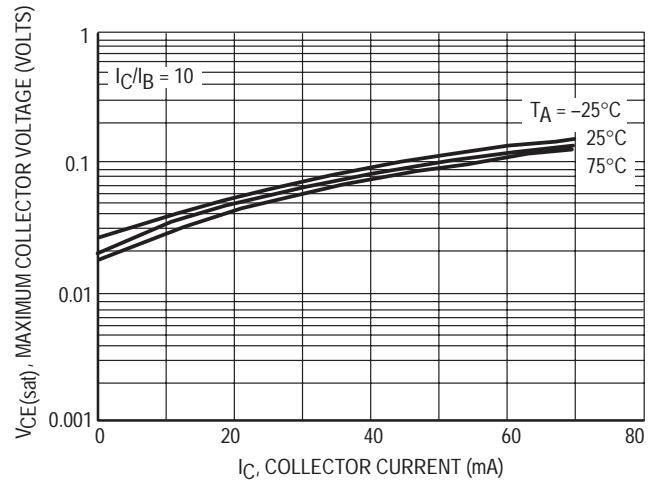


Figure 2. $V_{CE(sat)}$ versus I_C

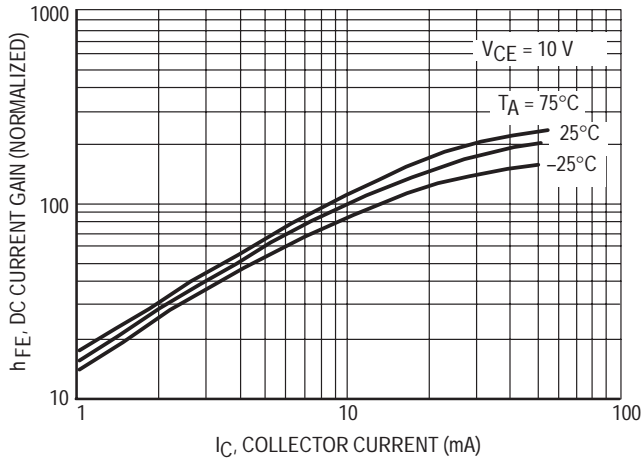


Figure 3. DC Current Gain

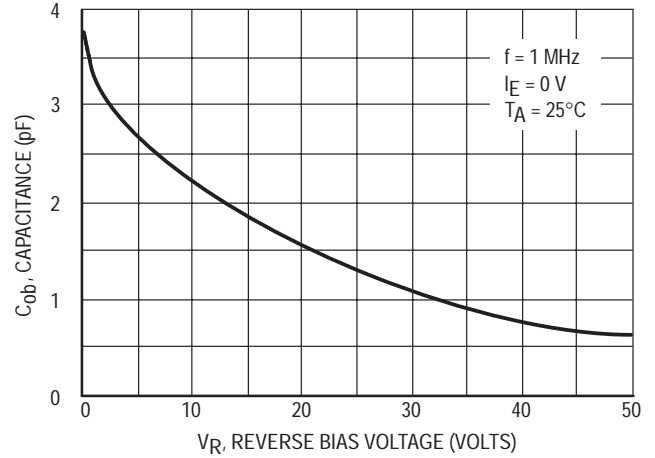


Figure 4. Output Capacitance

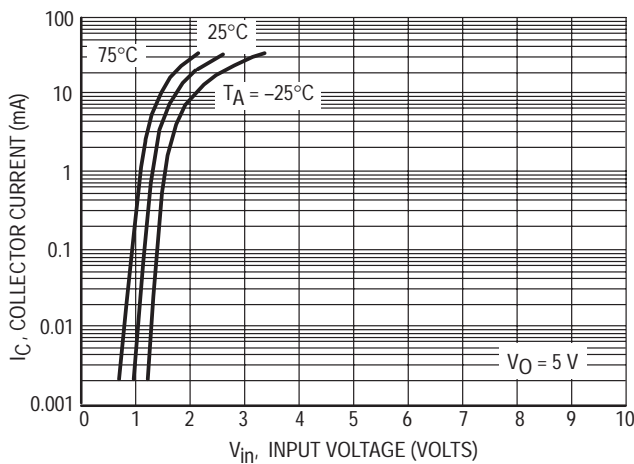


Figure 5. $V_{CE(sat)}$ versus I_C

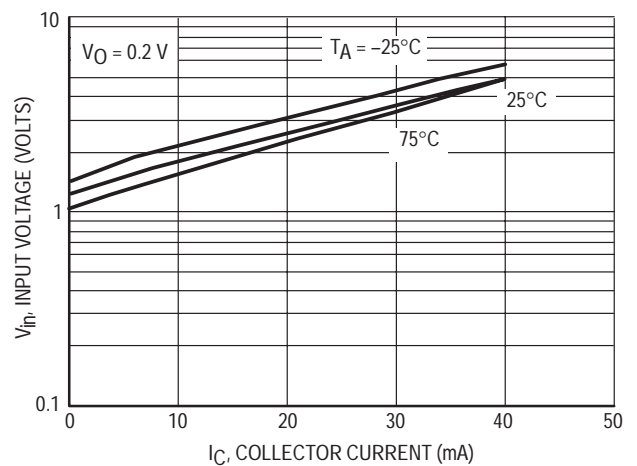


Figure 6. $V_{CE(sat)}$ versus I_C

TYPICAL ELECTRICAL CHARACTERISTICS
MMUN2212LT1

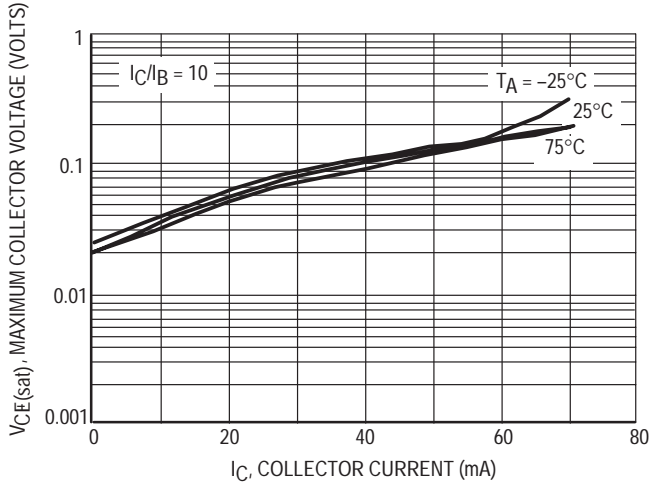


Figure 7. $V_{CE(sat)}$ versus I_C

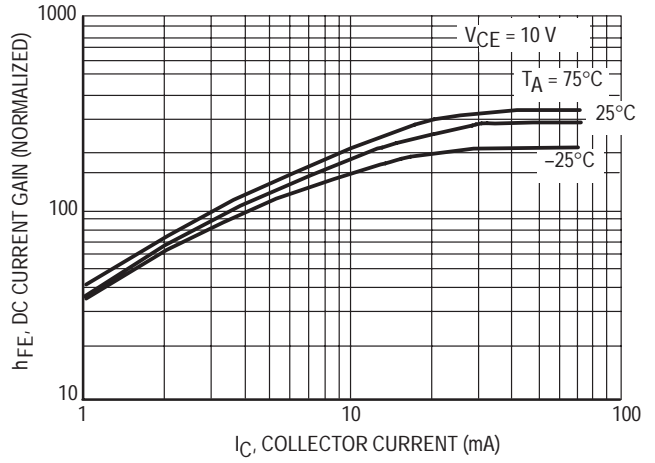


Figure 8. DC Current Gain

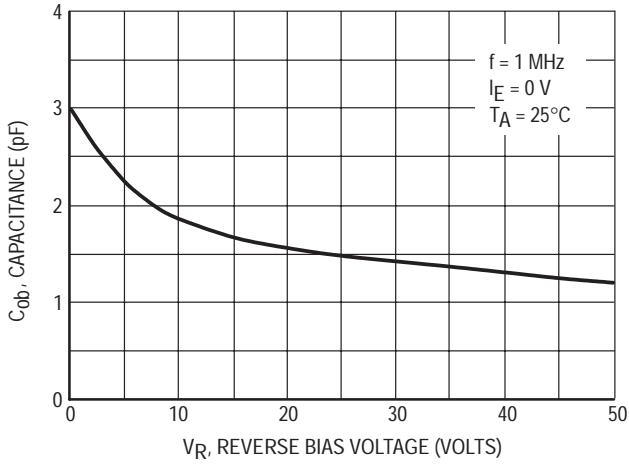


Figure 9. Output Capacitance

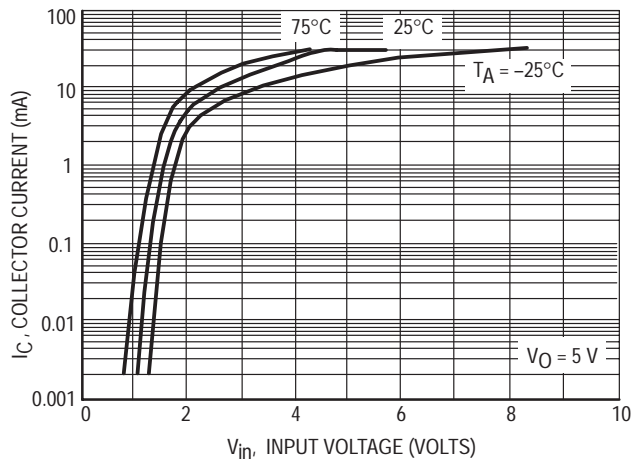


Figure 10. Output Current versus Input Voltage

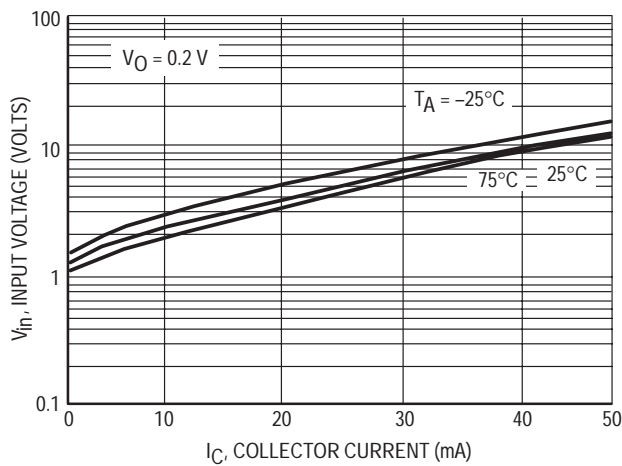


Figure 11. Input Voltage versus Output Current

TYPICAL ELECTRICAL CHARACTERISTICS
MMUN2213LT1

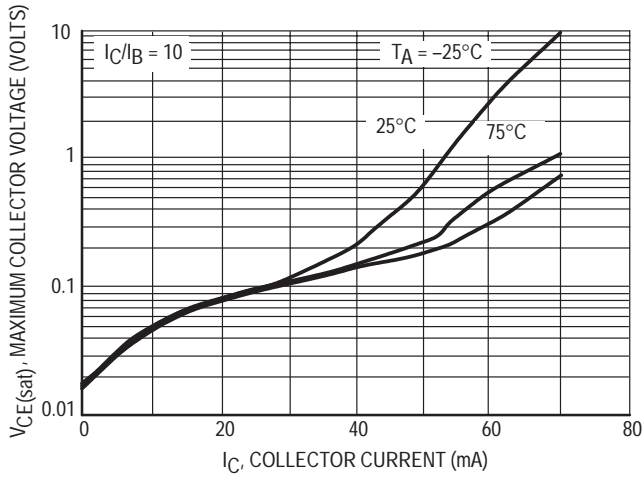


Figure 12. $V_{CE(sat)}$ versus I_C

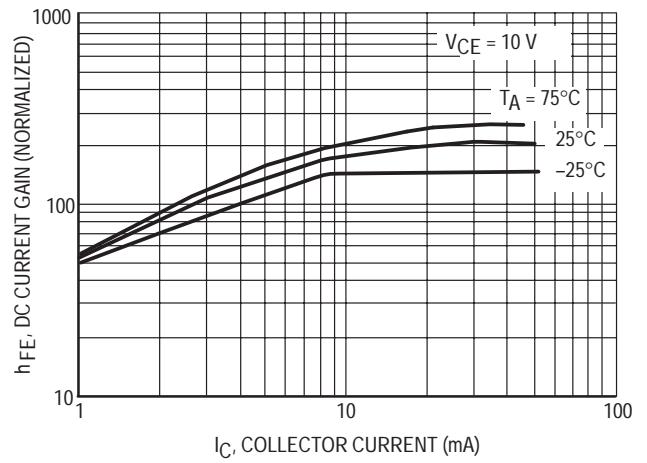


Figure 13. DC Current Gain

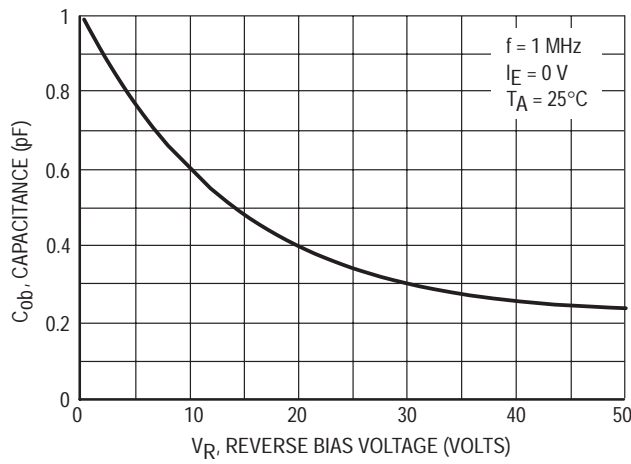


Figure 14. Output Capacitance

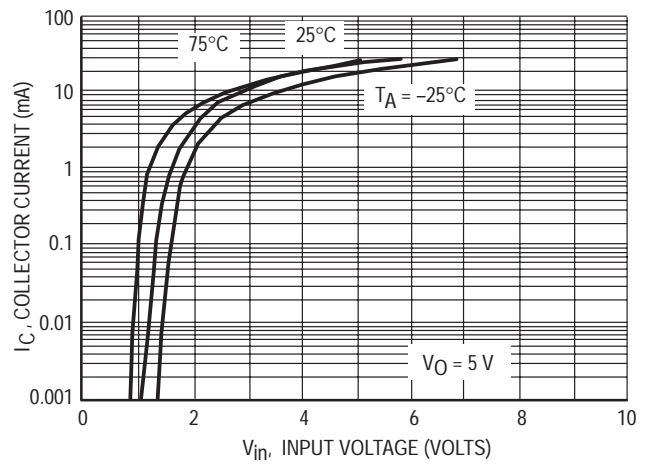


Figure 15. Output Current versus Input Voltage

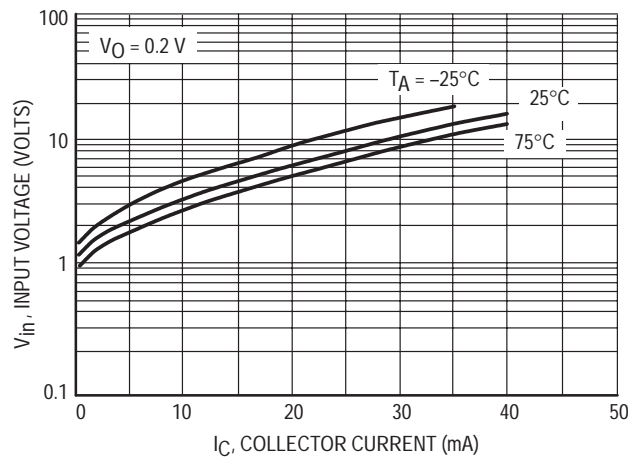


Figure 16. Input Voltage versus Output Current

TYPICAL ELECTRICAL CHARACTERISTICS
MMUN2214LT1

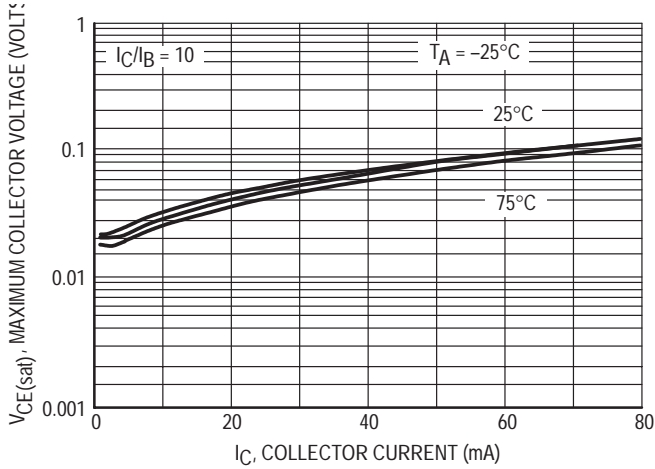


Figure 17. $V_{CE(sat)}$ versus I_C

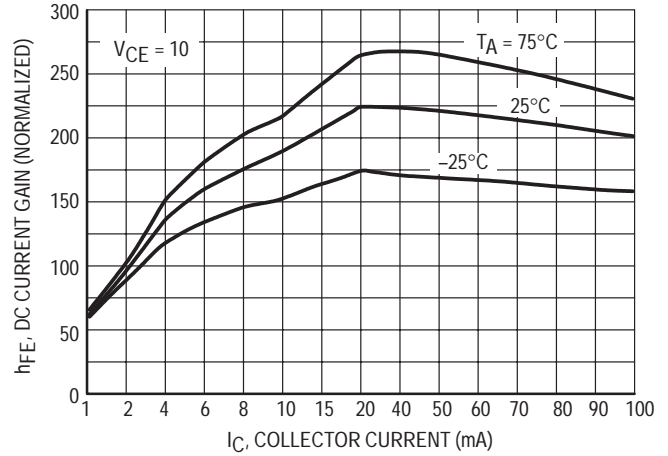


Figure 18. DC Current Gain

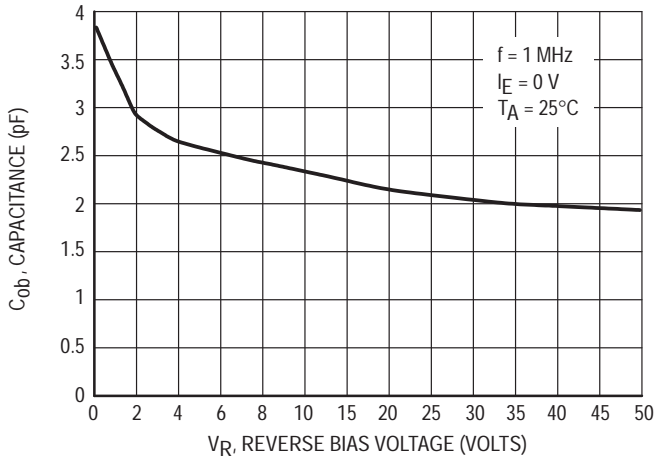


Figure 19. Output Capacitance

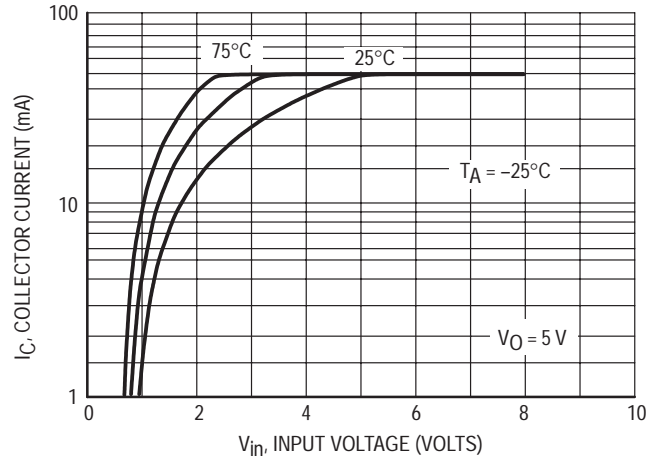


Figure 20. Output Current versus Input Voltage

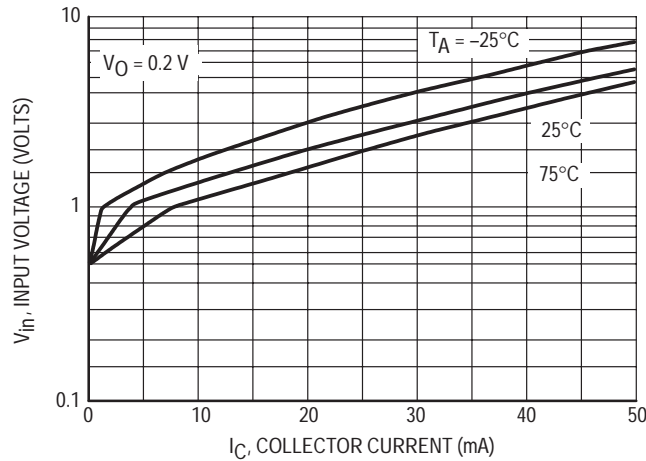


Figure 21. Input Voltage versus Output Current

TYPICAL APPLICATIONS FOR NPN BRTs

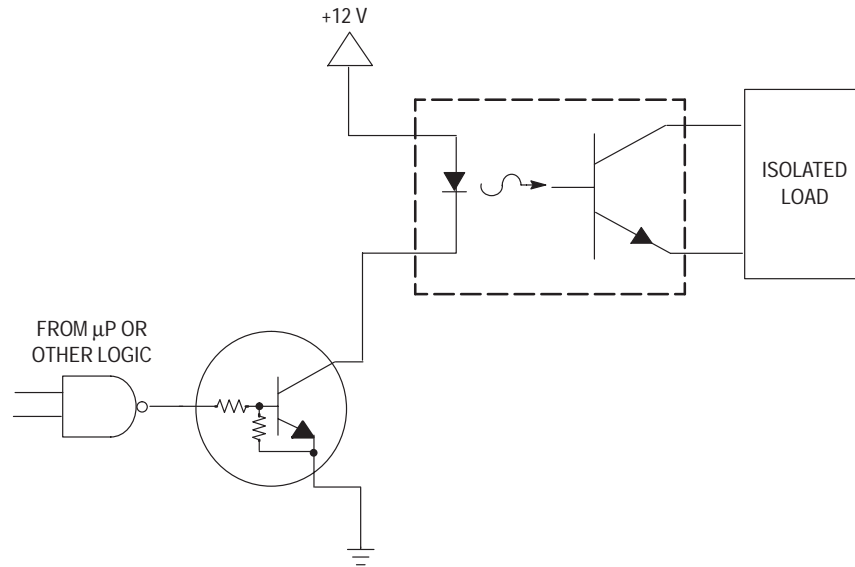


Figure 22. Level Shifter: Connects 12 or 24 Volt Circuits to Logic

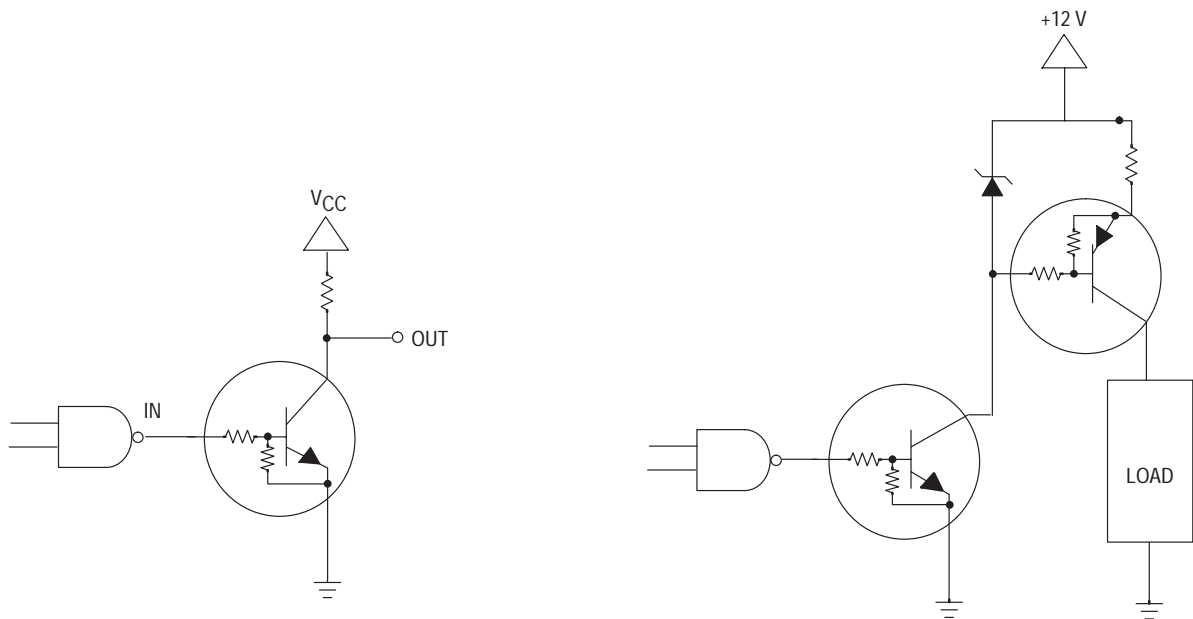
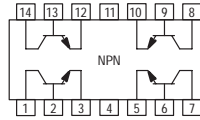


Figure 23. Open Collector Inverter: Inverts the Input Signal

Figure 24. Inexpensive, Unregulated Current Source

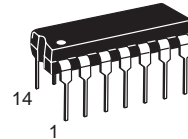
Quad General Purpose Transistors

NPN Silicon



MPQ2222
MPQ2222A*

*Motorola Preferred Device



CASE 646-06, STYLE 1
TO-116

MAXIMUM RATINGS

Rating	Symbol	MPQ2222	MPQ2222A	Unit
Collector–Emitter Voltage	V_{CEO}	30	40	Vdc
Collector–Base Voltage	V_{CBO}	60		Vdc
Emitter–Base Voltage	V_{EBO}	5.0		Vdc
Collector Current — Continuous	I_C	500		mAdc
		Each Transistor	Total Device	
Total Device Dissipation @ $T_A = 25^\circ\text{C}$ Derate above 25°C	P_D	0.65 5.2	1.9 15.2	Watts mW/ $^\circ\text{C}$
Operating and Storage Junction Temperature Range	T_J, T_{stg}	–55 to +150		$^\circ\text{C}$

THERMAL CHARACTERISTICS

Characteristic	Symbol	Max	Unit
Thermal Resistance, Junction to Ambient	$R_{\theta JA}$	66	$^\circ\text{C}/\text{W}$

ELECTRICAL CHARACTERISTICS ($T_A = 25^\circ\text{C}$ unless otherwise noted)

Characteristic	Symbol	Min	Max	Unit
----------------	--------	-----	-----	------

OFF CHARACTERISTICS

Collector–Emitter Breakdown Voltage ⁽¹⁾ ($I_C = 10 \text{ mAdc}, I_B = 0$)	MPQ2222 MPQ2222A	$V_{(BR)CEO}$	40 40	— —	Vdc
Collector–Base Breakdown Voltage ($I_C = 10 \mu\text{Adc}, I_E = 0$)	MPQ2222 MPQ2222A	$V_{(BR)CBO}$	60 75	— —	Vdc
Emitter–Base Breakdown Voltage ($I_E = 10 \mu\text{Adc}, I_C = 0$)	MPQ2222 MPQ2222A	$V_{(BR)EBO}$	5.0 6.0	— —	Vdc
Collector Cutoff Current ($V_{CB} = 50 \text{ Vdc}, I_E = 0$) ($V_{CB} = 60 \text{ Vdc}, I_E = 0$)	MPQ2222 MPQ2222A	I_{CBO}	— —	50 10	nAdc
Emitter Cutoff Current ($V_{EB} = 3.0 \text{ Vdc}, I_C = 0$)		I_{EBO}	—	100	nAdc

1. Pulse Test: Pulse Width $\leq 300 \mu\text{s}$, Duty Cycle $\leq 2.0\%$.

Preferred devices are Motorola recommended choices for future use and best overall value.

(Replaces MPQ2221/D)

ELECTRICAL CHARACTERISTICS (T_A = 25°C unless otherwise noted) (Continued)

Characteristic	Symbol	Min	Max	Unit
ON CHARACTERISTICS				
DC Current Gain ⁽¹⁾ (I _C = 100 μAdc, V _{CE} = 10 Vdc) (I _C = 1.0 mAdc, V _{CE} = 10 Vdc) (I _C = 10 mAdc, V _{CE} = 10 Vdc) (I _C = 150 mAdc, V _{CE} = 10 Vdc) (I _C = 300 mAdc, V _{CE} = 10 Vdc) (I _C = 500 mAdc, V _{CE} = 10 Vdc)	MPQ2222A MPQ2222A MPQ2222,A MPQ2222,A MPQ2222 MPQ2222A	h _{FE}	35 50 75 100 30 40	— — — 300 — —
Collector–Emitter Saturation Voltage (I _C = 150 mAdc, I _B = 15 mAdc) (I _C = 300 mAdc, I _B = 30 mAdc) (I _C = 500 mA, I _B = 50 mA)	MPQ2222 MPQ2222A MPQ2222 MPQ2222A	V _{CE(sat)}	— — — —	0.4 0.3 1.6 1.0
Base–Emitter Saturation Voltage (I _C = 150 mAdc, I _B = 15 mAdc) (I _C = 300 mAdc, I _B = 30 mAdc) (I _C = 500 mA, I _B = 50 mA)	MPQ2222 MPQ2222A MPQ2222 MPQ2222A	V _{BE(sat)}	— 0.6 — —	1.3 1.2 2.6 2.0

SMALL-SIGNAL CHARACTERISTICS

Current–Gain — Bandwidth Product ⁽¹⁾ (I _C = 20 mAdc, V _{CE} = 20 Vdc, f = 100 MHz)	f _T	200	—	MHz
Output Capacitance (V _{CB} = 10 Vdc, I _E = 0, f = 1.0 MHz)	C _{obo}	—	8.0	pF
Input Capacitance (V _{EB} = 0.5 Vdc, I _C = 0, f = 1.0 MHz)	C _{ibo}	—	30	pF

SWITCHING CHARACTERISTICS

Turn–On Time (V _{CC} = 30 Vdc, V _{BE(off)} = –0.5 Vdc, I _C = 150 mAdc, I _{B1} = 15 mAdc)	t _{on}	—	35	ns
Turn–Off Time (V _{CC} = 30 Vdc, I _C = 150 mAdc, I _{B1} = I _{B2} = 15 mAdc)	t _{off}	—	285	ns

1. Pulse Test: Pulse Width ≤ 300 μs, Duty Cycle ≤ 2.0%.

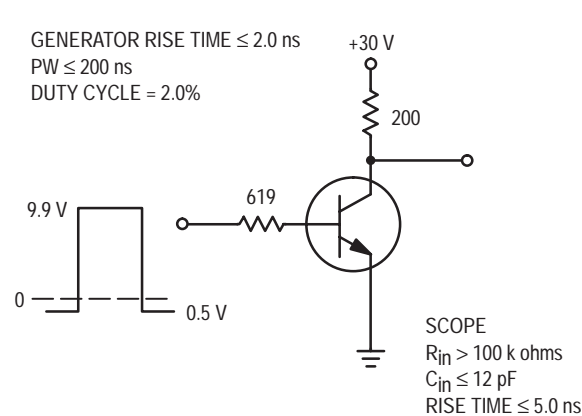


Figure 1. Delay and Rise Time Equivalent Test Circuit

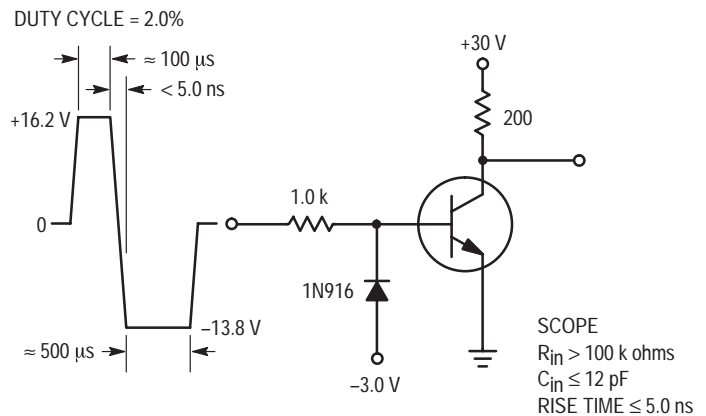


Figure 2. Storage Time and Fall Time Equivalent Test Circuit

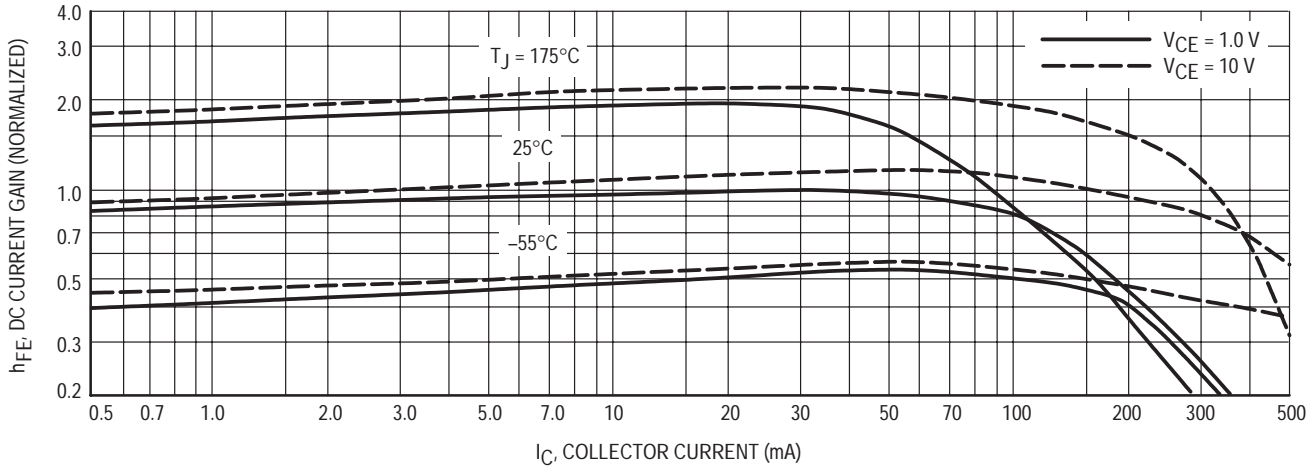


Figure 3. Normalized DC Current Gain

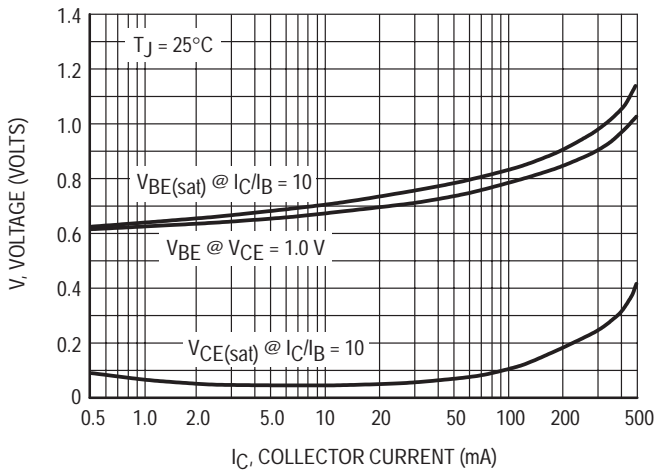


Figure 4. "ON" Voltages

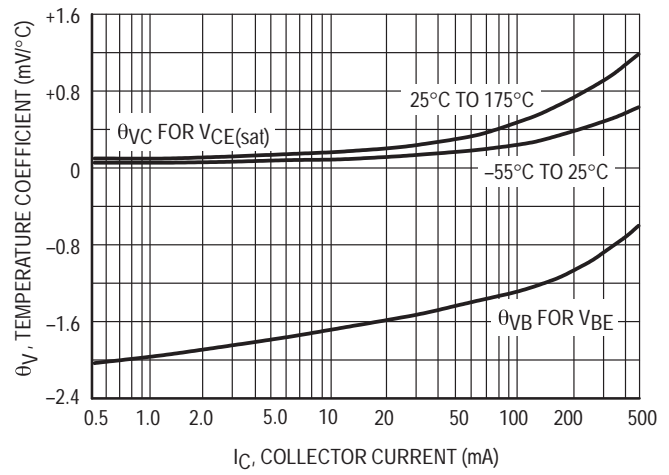


Figure 5. Temperature Coefficients

NOISE FIGURE
($V_{CE} = 10 \text{ Vdc}$, $T_A = 25^\circ\text{C}$)

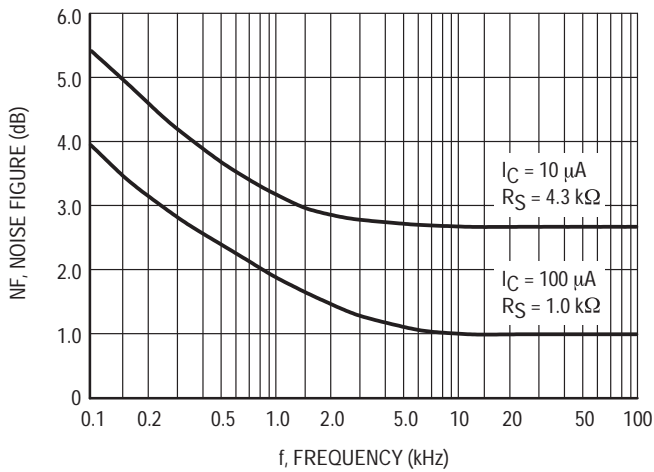


Figure 6. Frequency Effects

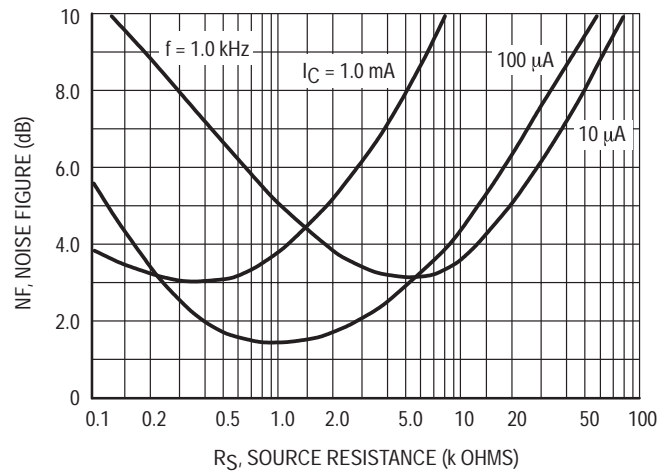


Figure 7. Source Resistance Effects

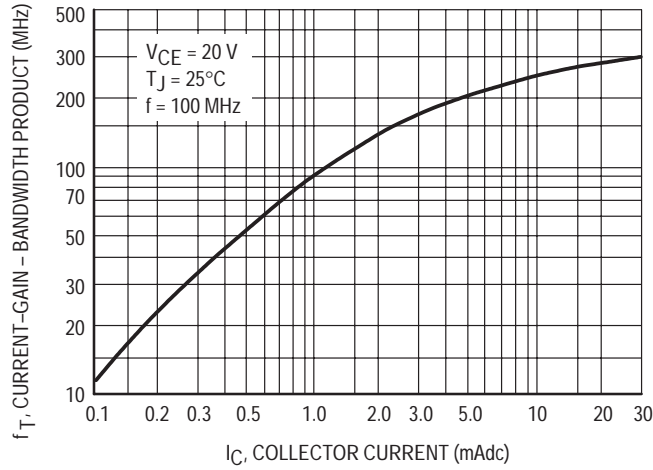


Figure 8. Current-Gain — Bandwidth Product

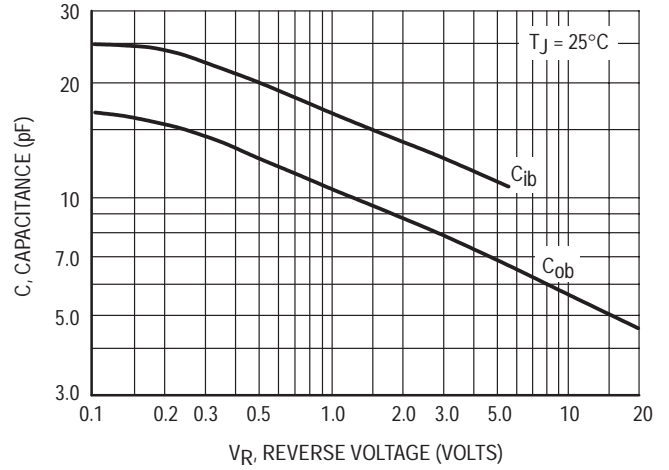


Figure 9. Capacitances

SWITCHING TIME CHARACTERISTICS

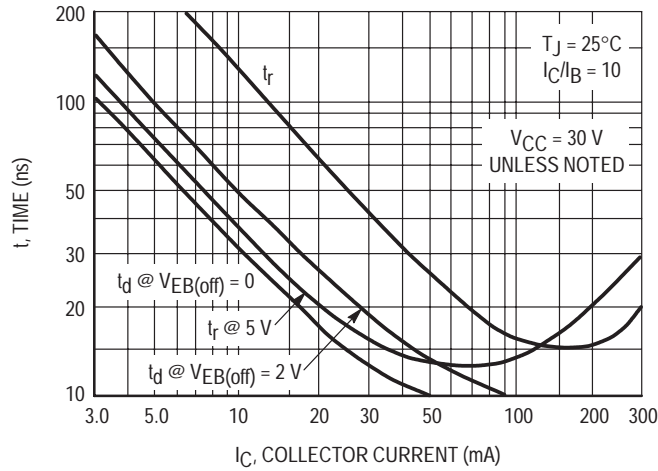


Figure 10. Turn-On Time

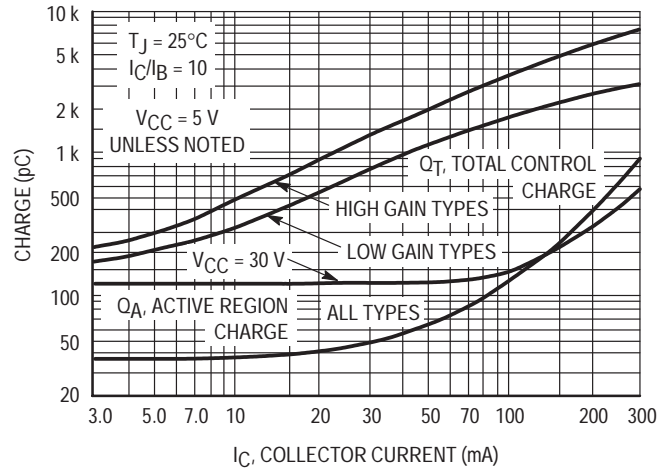


Figure 11. Charge Data

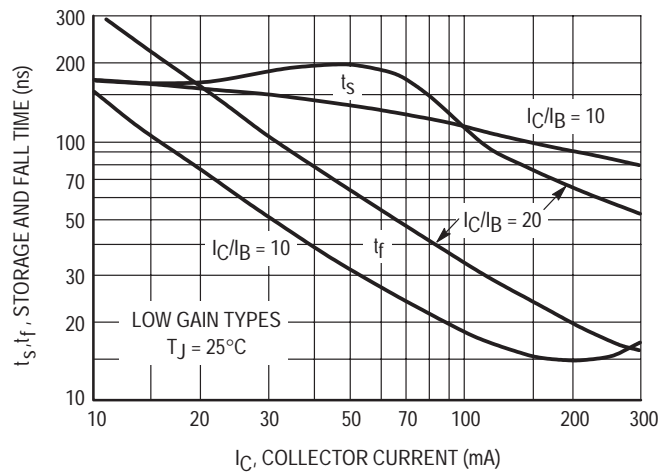


Figure 12. Turn-Off Behavior

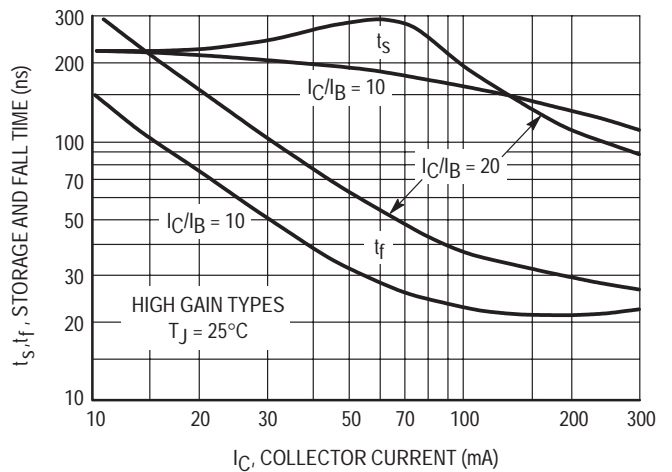


Figure 13. Turn-Off Behavior

MPQ2222 MPQ2222A

GENERATOR RISE TIME ≤ 2.0 ns
PW ≤ 200 ns
DUTY CYCLE = 2.0%

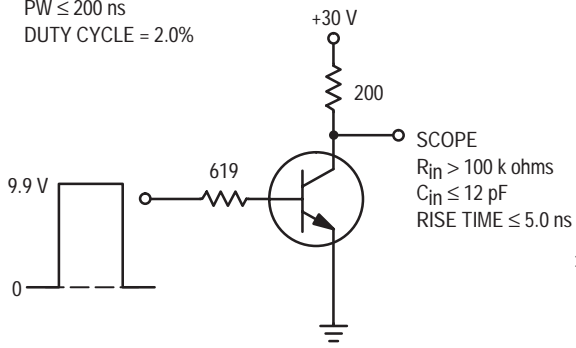


Figure 14. Delay and Rise Time Equivalent Test Circuit

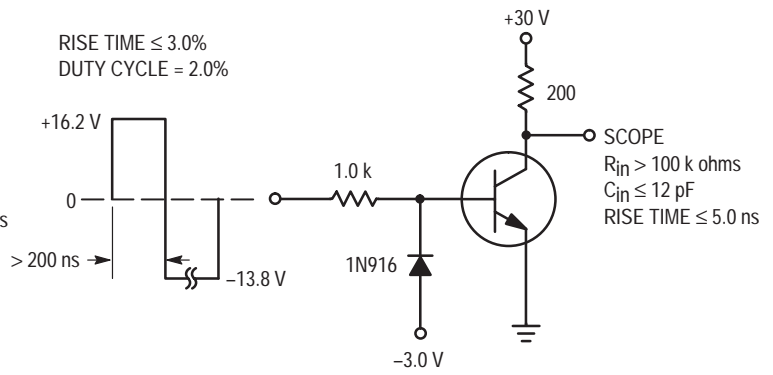
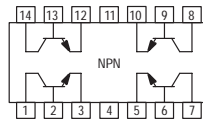


Figure 15. Storage Time and Fall Time Equivalent Test Circuit

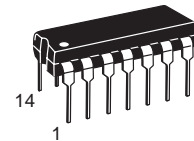
Quad Switching Transistor

NPN Silicon



MPQ2369

Motorola Preferred Device



CASE 646-06, STYLE 1
TO-116

MAXIMUM RATINGS

Rating	Symbol	Value	Unit
Collector-Emitter Voltage	V_{CEO}	15	Vdc
Collector-Base Voltage	V_{CBO}	40	Vdc
Emitter-Base Voltage	V_{EBO}	4.5	Vdc
Collector Current — Continuous	I_C	500	mAdc
		Each Transistor	Total Device
Total Device Dissipation @ $T_A = 25^\circ\text{C}$ Derate above 25°C	P_D	0.5 5.0	1.5 15 Watts mW/ $^\circ\text{C}$
Operating and Storage Junction Temperature Range	T_J, T_{stg}	-55 to +125	$^\circ\text{C}$

THERMAL CHARACTERISTICS

Characteristic	Symbol	Max	Unit
Thermal Resistance, Junction to Ambient	$R_{\theta JA}$	83	$^\circ\text{C}/\text{W}$

ELECTRICAL CHARACTERISTICS ($T_A = 25^\circ\text{C}$ unless otherwise noted)

Characteristic	Symbol	Min	Typ	Max	Unit
----------------	--------	-----	-----	-----	------

OFF CHARACTERISTICS

Collector-Emitter Breakdown Voltage ⁽¹⁾ ($I_C = 10 \text{ mAdc}, I_B = 0$)	$V_{(BR)CEO}$	15	—	—	Vdc
Collector-Base Breakdown Voltage ($I_C = 10 \mu\text{Adc}, I_E = 0$)	$V_{(BR)CBO}$	40	—	—	Vdc
Emitter-Base Breakdown Voltage ($I_E = 10 \mu\text{Adc}, I_C = 0$)	$V_{(BR)EBO}$	4.5	—	—	Vdc
Collector Cutoff Current ($V_{CB} = 20 \text{ Vdc}, I_E = 0$)	I_{CBO}	—	—	0.4	μAdc

1. Pulse Test: Pulse Width $\leq 300 \mu\text{s}$; Duty Cycle $\leq 2.0\%$.

Preferred devices are Motorola recommended choices for future use and best overall value.

MPQ2369**ELECTRICAL CHARACTERISTICS** ($T_A = 25^\circ\text{C}$ unless otherwise noted) (Continued)

Characteristic	Symbol	Min	Typ	Max	Unit
ON CHARACTERISTICS					
DC Current Gain ⁽¹⁾ ($I_C = 10\text{ mAdc}$, $V_{CE} = 1.0\text{ Vdc}$) ($I_C = 100\text{ mAdc}$, $V_{CE} = 2.0\text{ Vdc}$)	h_{FE}	40 20	— —	— —	—
Collector–Emitter Saturation Voltage ($I_C = 10\text{ mAdc}$, $I_B = 1.0\text{ mAdc}$)	$V_{CE(sat)}$	—	—	0.25	Vdc
Base–Emitter Saturation Voltage ($I_C = 10\text{ mAdc}$, $I_B = 1.0\text{ mAdc}$)	$V_{BE(sat)}$	—	—	0.9	Vdc

SMALL–SIGNAL CHARACTERISTICS

Current–Gain — Bandwidth Product ($I_C = 10\text{ mAdc}$, $V_{CE} = 10\text{ Vdc}$, $f = 100\text{ MHz}$)	f_T	450	550	—	MHz
Output Capacitance ($V_{CB} = 5.0\text{ Vdc}$, $I_E = 0$, $f = 1.0\text{ MHz}$)	C_{obo}	—	2.5	4.0	pF
Input Capacitance ($V_{EB} = 0.5\text{ Vdc}$, $I_C = 0$, $f = 1.0\text{ MHz}$)	C_{ibo}	—	3.0	5.0	pF

SWITCHING CHARACTERISTICS

Turn–On Time ($V_{CC} = 3.0\text{ Vdc}$, $V_{BE} = 1.5\text{ Vdc}$, $I_C = 10\text{ mAdc}$, $I_{B1} = 3.0\text{ mAdc}$)	t_{on}	—	9.0	—	ns
Turn–Off Time ($V_{CC} = 3.0\text{ Vdc}$, $I_C = 10\text{ mAdc}$, $I_{B1} = 3.0\text{ mAdc}$, $I_{B2} = 1.5\text{ mAdc}$)	t_{off}	—	15	—	ns

1. Pulse Test: Pulse Width $\leq 300\ \mu\text{s}$; Duty Cycle $\leq 2.0\%$.

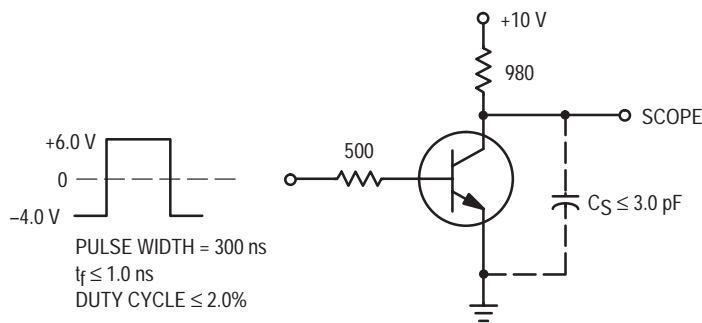


Figure 1. Storage Time Test Circuit

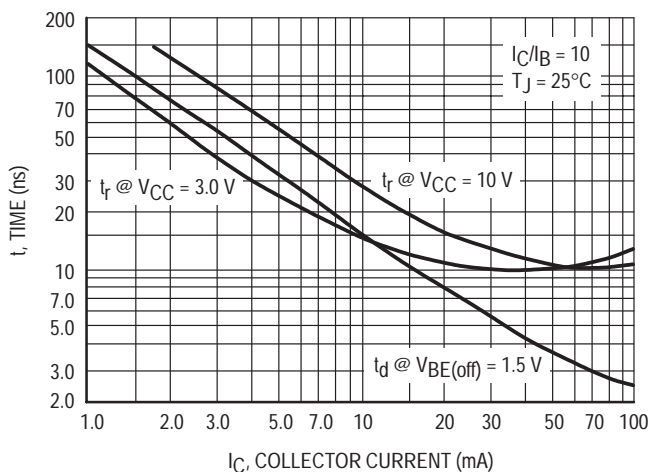


Figure 2. Turn-On Time

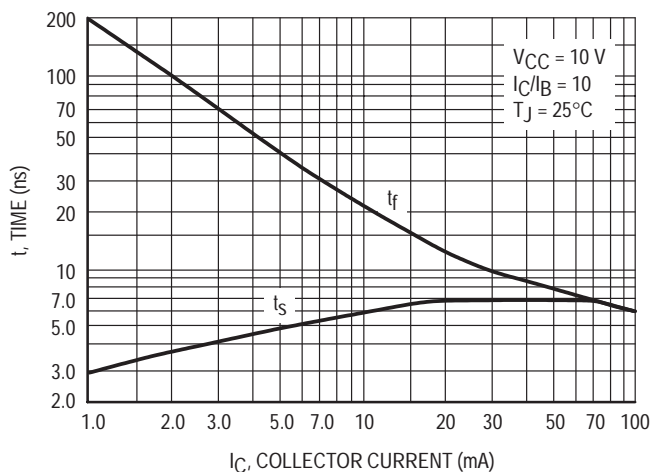


Figure 3. Turn-Off Time

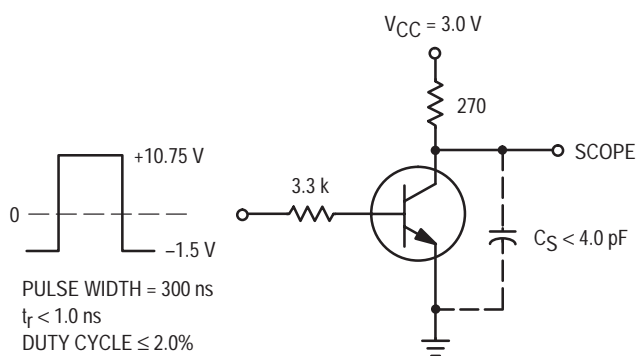


Figure 4. Turn-On Test Circuit

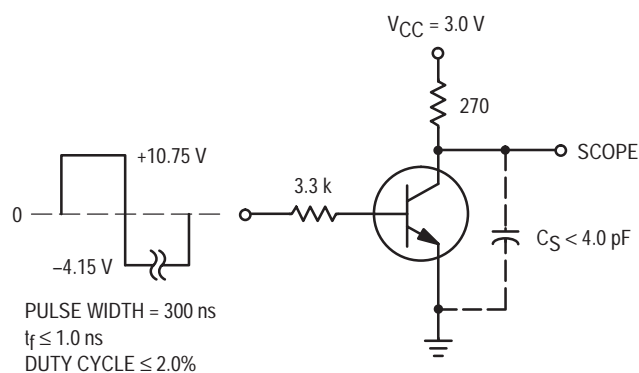


Figure 5. Turn-Off Test Circuit

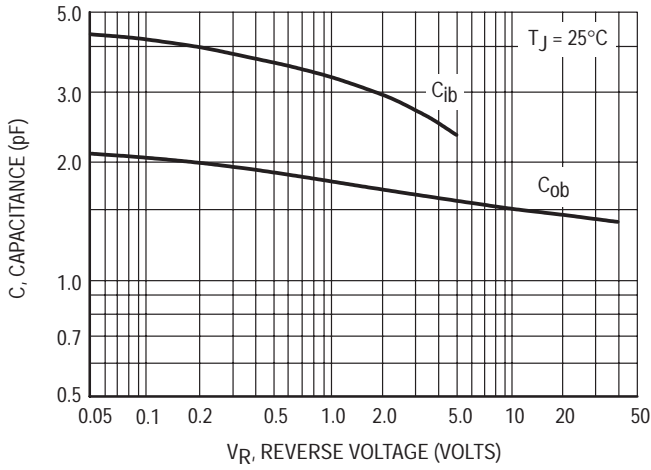


Figure 6. Capacitance

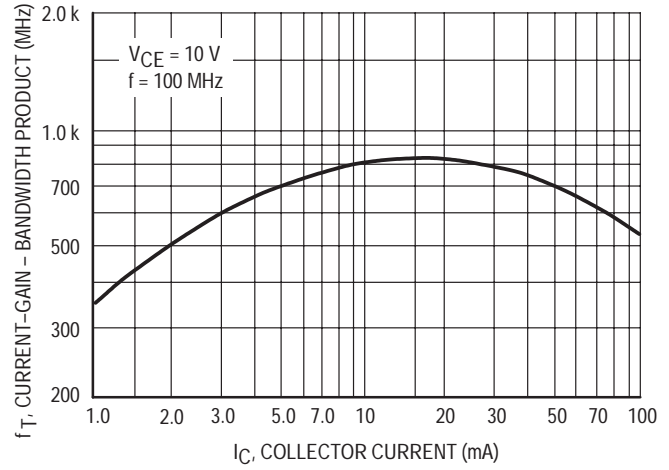


Figure 7. Current-Gain — Bandwidth Product

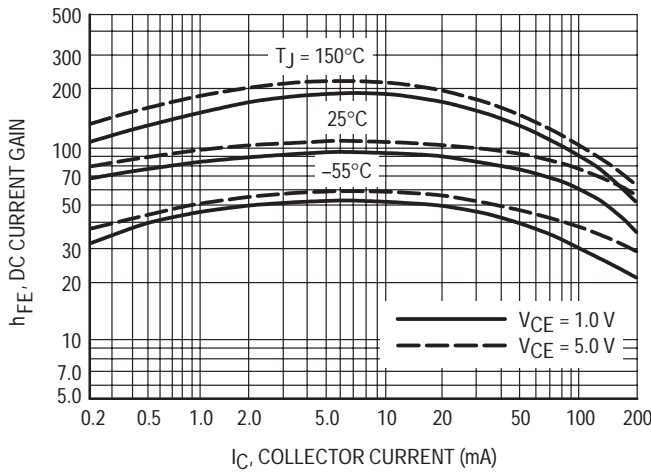


Figure 8. DC Current Gain

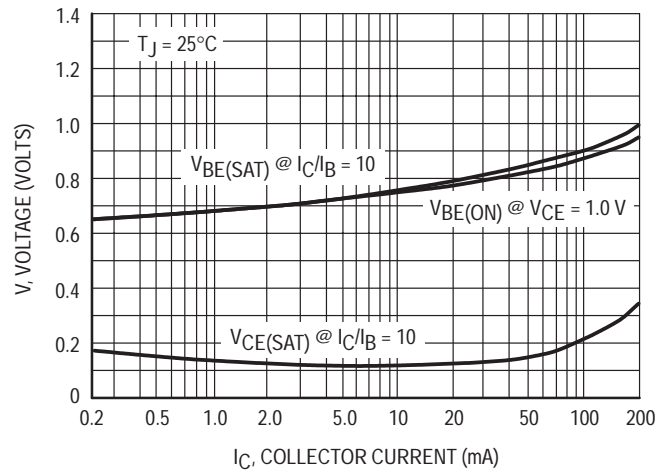


Figure 9. "ON" Voltages

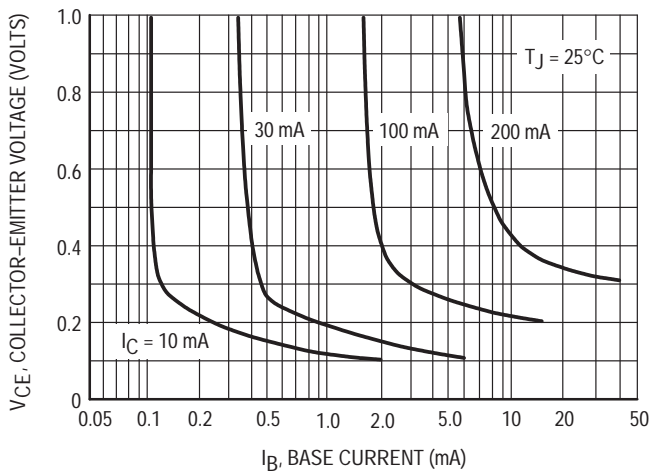


Figure 10. Collector Saturation Region

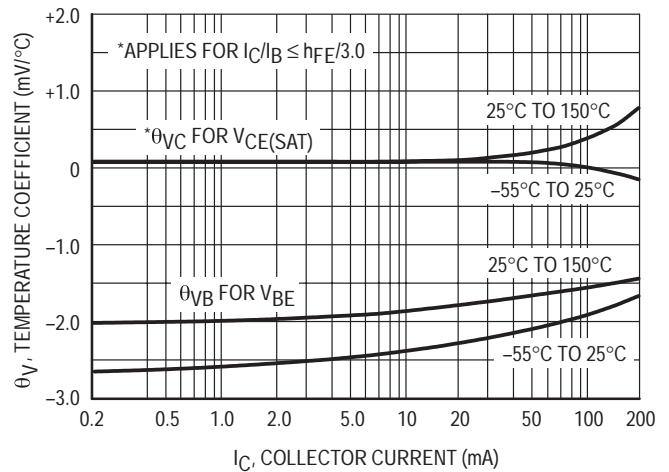
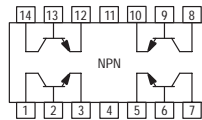


Figure 11. Temperature Coefficients

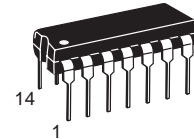
Quad Amplifier Transistors

NPN Silicon



MPQ2483
MPQ2484*

*Motorola Preferred Device



CASE 646-06, STYLE 1
TO-116

MAXIMUM RATINGS

Rating	Symbol	Value		Unit
Collector-Emitter Voltage	V_{CEO}	40		Vdc
Collector-Base Voltage	V_{CBO}	60		Vdc
Emitter-Base Voltage	V_{EBO}	6.0		Vdc
Collector Current — Continuous	I_C	50		mAdc
		Each Transistor	Four Transistors Equal Power	
Total Device Dissipation @ $T_A = 25^\circ\text{C}$ (1) Derate above 25°C	P_D	500 4.0	900 7.2	mW mW/ $^\circ\text{C}$
Total Device Dissipation @ $T_C = 25^\circ\text{C}$ Derate above 25°C	P_D	0.825 6.7	2.4 19.2	Watts mW/ $^\circ\text{C}$
Operating and Storage Junction Temperature Range	T_J, T_{stg}	-55 to +150		$^\circ\text{C}$

THERMAL CHARACTERISTICS

Characteristic		Junction to Case	Junction to Ambient	Unit
Thermal Resistance	Each Die	151	250	$^\circ\text{C}/\text{W}$
	Effective, 4 Die	52	134	$^\circ\text{C}/\text{W}$
Coupling Factors	Q1-Q4 or Q2-Q3	34	70	%
	Q1-Q2 or Q3-Q4	2.0	26	%

ELECTRICAL CHARACTERISTICS ($T_A = 25^\circ\text{C}$ unless otherwise noted)

Characteristic	Symbol	Min	Typ	Max	Unit
----------------	--------	-----	-----	-----	------

OFF CHARACTERISTICS

Collector-Emitter Breakdown Voltage ⁽²⁾ ($I_C = 10 \text{ mAdc}, I_B = 0$)	$V_{(BR)CEO}$	40	—	—	Vdc
Collector-Base Breakdown Voltage ($I_C = 10 \mu\text{Adc}, I_E = 0$)	$V_{(BR)CBO}$	60	—	—	Vdc
Emitter-Base Breakdown Voltage ($I_E = 10 \mu\text{Adc}, I_C = 0$)	$V_{(BR)EBO}$	6.0	—	—	Vdc
Collector Cutoff Current ($V_{CB} = 45 \text{ Vdc}, I_E = 0$)	I_{CBO}	—	—	20	nAdc
Emitter Cutoff Current ($V_{EB} = 3.0 \text{ Vdc}, I_C = 0$)	I_{EBO}	—	—	20	nAdc

- Second Breakdown occurs at power levels greater than 3 times the power dissipation rating.
- Pulse Test: Pulse Width $\leq 300 \mu\text{s}$; Duty Cycle $\leq 2.0\%$.

Preferred devices are Motorola recommended choices for future use and best overall value.

MPQ2483 MPQ2484**ELECTRICAL CHARACTERISTICS** ($T_A = 25^\circ\text{C}$ unless otherwise noted) (Continued)

Characteristic	Symbol	Min	Typ	Max	Unit
ON CHARACTERISTICS					
DC Current Gain ⁽²⁾ ($I_C = 0.1 \text{ mAdc}$, $V_{CE} = 5.0 \text{ Vdc}$)	h_{FE}	100	—	—	—
MPQ2483		200	—	—	
MPQ2484					
($I_C = 1.0 \text{ mAdc}$, $V_{CE} = 5.0 \text{ Vdc}$)		150	—	—	
MPQ2483		300	—	—	
MPQ2484					
($I_C = 10 \text{ mAdc}$, $V_{CE} = 5.0 \text{ Vdc}$)		150	—	—	
MPQ2483		300	—	—	
MPQ2484					
Collector–Emitter Saturation Voltage ($I_C = 1.0 \text{ mAdc}$, $I_B = 0.1 \text{ mAdc}$) ($I_C = 10 \text{ mAdc}$, $I_B = 1.0 \text{ mAdc}$)	$V_{CE(sat)}$	—	0.13	0.35	Vdc
		—	0.15	0.5	
Base–Emitter Saturation Voltage ⁽²⁾ ($I_C = 100 \mu\text{A}$, $V_{CE} = 5.0 \text{ Vdc}$) ($I_C = 10 \text{ mAdc}$, $V_{CE} = 5.0 \text{ Vdc}$)	$V_{BE(sat)}$	—	0.58	0.7	Vdc
		—	0.70	0.8	

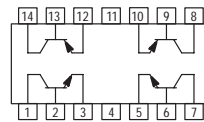
SMALL–SIGNAL CHARACTERISTICS

Current–Gain — Bandwidth Product ($I_C = 500 \mu\text{A}$, $V_{CE} = 5.0 \text{ Vdc}$, $f = 20 \text{ MHz}$)	f_T	50	100	—	MHz
Input Capacitance ($V_{EB} = 0.5 \text{ Vdc}$, $I_C = 0$, $f = 1.0 \text{ MHz}$)	C_{ibo}	—	4.0	8.0	pF
Collector–Base Capacitance ($V_{CB} = 5.0 \text{ Vdc}$, $I_E = 0$, $f = 1.0 \text{ MHz}$)	C_{cb}	—	1.8	6.0	pF
Noise Figure ($I_C = 10 \mu\text{A}$, $V_{CE} = 5.0 \text{ Vdc}$, $R_S = 10 \text{ k ohms}$, $f = 1.0 \text{ kHz}$, $BW = 10 \text{ kHz}$)	NF	—	3.0	—	dB
		—	2.0	—	

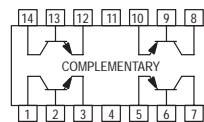
2. Pulse Test: Pulse Width $\leq 300 \mu\text{s}$; Duty Cycle $\leq 2.0\%$.

Quad Complementary Pair Transistors

NPN/PNP Silicon



MPQ6100A
TYPE A

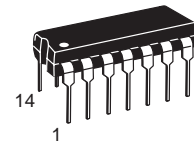


MPQ6600A1
TYPE B

MPQ6100A
MPQ6600A1*

Voltage and Current are negative
for PNP Transistors

*Motorola Preferred Device



CASE 646-06, STYLE 1
TO-116

MAXIMUM RATINGS

Rating	Symbol	MPQ6100A MPQ6600A1		Unit
Collector-Emitter Voltage	V_{CEO}	45		Vdc
Collector-Base Voltage	V_{CBO}	60		Vdc
Emitter-Base Voltage	V_{EBO}	5.0		Vdc
Collector Current — Continuous	I_C	50		mAdc
		Each Transistor	Four Transistors Equal Power	
Total Device Dissipation @ $T_A = 25^\circ\text{C}$ Derate above 25°C	P_D	500 4.0	900 7.2	mW mW/ $^\circ\text{C}$
Total Device Dissipation @ $T_C = 25^\circ\text{C}$ Derate above 25°C	P_D	0.825 6.7	2.4 19.2	Watts mW/ $^\circ\text{C}$
Operating and Storage Junction Temperature Range	T_J, T_{stg}	-55 to +150		$^\circ\text{C}$

THERMAL CHARACTERISTICS

Characteristic	Junction to Case	Junction to Ambient	Unit
Thermal Resistance ⁽¹⁾	Each Die	250	$^\circ\text{C}/\text{W}$
	Effective, 4 Die	139	$^\circ\text{C}/\text{W}$
Coupling Factors	Q1-Q4 or Q2-Q3	70	%
	Q1-Q2 or Q3-Q4	26	%

1. $R_{\theta JA}$ is measured with the device soldered into a typical printed circuit board.

Preferred devices are Motorola recommended choices for future use and best overall value.

MPQ6100A MPQ6600A1

ELECTRICAL CHARACTERISTICS (T_A = 25°C unless otherwise noted)

Characteristic	Symbol	Min	Typ	Max	Unit
OFF CHARACTERISTICS					
Collector–Emitter Breakdown Voltage ⁽²⁾ (I _C = 10 mA _{dc} , I _B = 0)	V _{(BR)CEO}	45	—	—	V _{dc}
Collector–Base Breakdown Voltage (I _C = 10 μA _{dc} , I _E = 0)	V _{(BR)CBO}	60	—	—	V _{dc}
Emitter–Base Breakdown Voltage (I _E = 10 μA _{dc} , I _C = 0)	V _{(BR)EBO}	5.0	—	—	V _{dc}
Collector Cutoff Current (V _{CB} = 50 V _{dc} , I _E = 0)	I _{CBO}	—	—	10	nA _{dc}

ON CHARACTERISTICS⁽²⁾

DC Current Gain (I _C = 100 μA _{dc} , V _{CE} = 5.0 V _{dc}) (I _C = 500 μA _{dc} , V _{CE} = 5.0 V _{dc}) (I _C = 1.0 mA _{dc} , V _{CE} = 5.0 V _{dc}) (I _C = 10 mA _{dc} , V _{CE} = 5.0 V _{dc})	MPQ6100A, 6600A1 MPQ6100A, 6600A1 MPQ6100A, 6600A1 MPQ6100A, 6600A1	h _{FE}	100 150 150 125	— — — —	— — — —	—
Collector–Emitter Saturation Voltage (I _C = 1.0 mA _{dc} , I _B = 100 μA _{dc})		V _{CE(sat)}	—	—	0.25	V _{dc}
Base–Emitter Saturation Voltage (I _C = 1.0 mA _{dc} , I _B = 100 μA _{dc})		V _{BE(sat)}	—	—	0.8	V _{dc}

SMALL–SIGNAL CHARACTERISTICS

Current–Gain — Bandwidth Product (I _C = 500 μA _{dc} , V _{CE} = 5.0 V _{dc} , f = 20 MHz)		f _T	50	—	—	MHz
Output Capacitance (V _{CB} = 5.0 V _{dc} , I _E = 0, f = 1.0 MHz)	PNP NPN	C _{obo}	— —	1.2 1.8	4.0 4.0	pF
Input Capacitance (V _{EB} = 0.5 V _{dc} , I _C = 0, f = 1.0 MHz)	PNP NPN	C _{ibo}	— —	— —	8.0 8.0	pF
Noise Figure (I _C = 100 μA _{dc} , V _{CE} = 5.0 V _{dc} , R _S = 10 kΩ, f = 1.0 kHz, BW = 10 kHz)		NF	—	4.0	—	dB

MATCHING CHARACTERISTICS (MPQ6600A1 ONLY)

DC Current Gain Ratio (I _C = 100 μA _{dc} , V _{CE} = 5.0 V _{dc})		h _{FE1} /h _{FE2}	0.8	—	1.0	—
Base–Emitter Voltage Differential (I _C = 100 μA _{dc} , V _{CE} = 5.0 V _{dc})		V _{BE1} –V _{BE2}	—	—	20	mV _{dc}

2. Pulse Test: Pulse Width ≤ 300 μs; Duty Cycle ≤ 2.0%.

SPOT NOISE FIGURE
($V_{CE} = 10 \text{ Vdc}$, $T_A = 25^\circ\text{C}$)

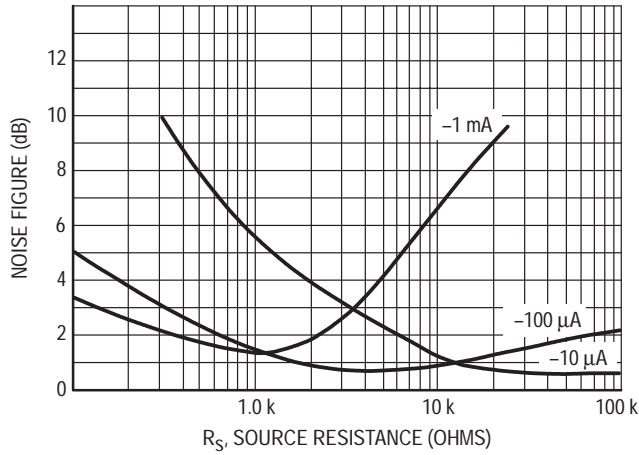


Figure 1. Source Resistance Effects, $f = 1.0 \text{ kHz}$

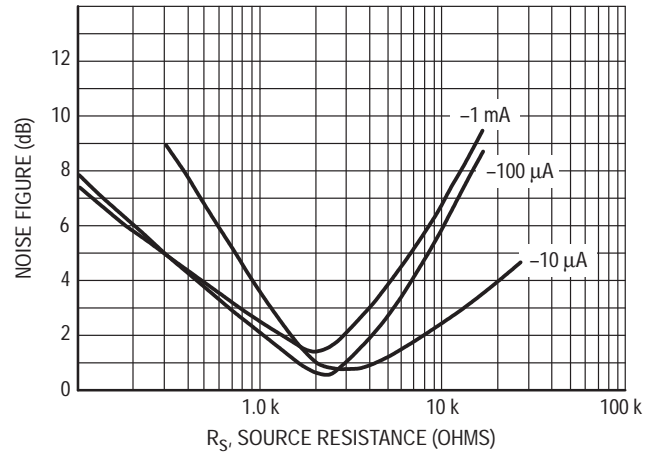


Figure 2. Source Resistance Effects, $f = 10 \text{ Hz}$

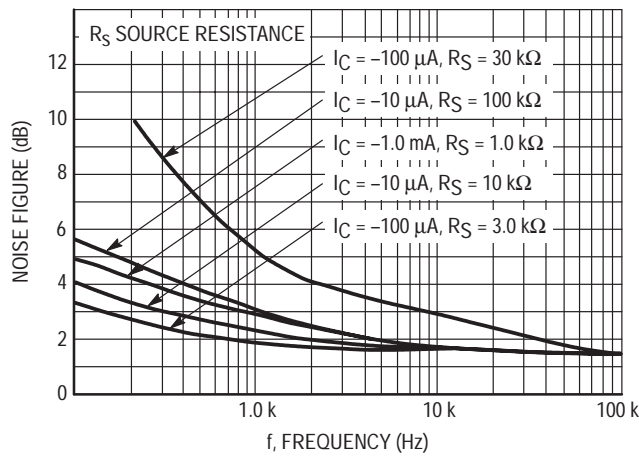


Figure 3. Frequency Effects

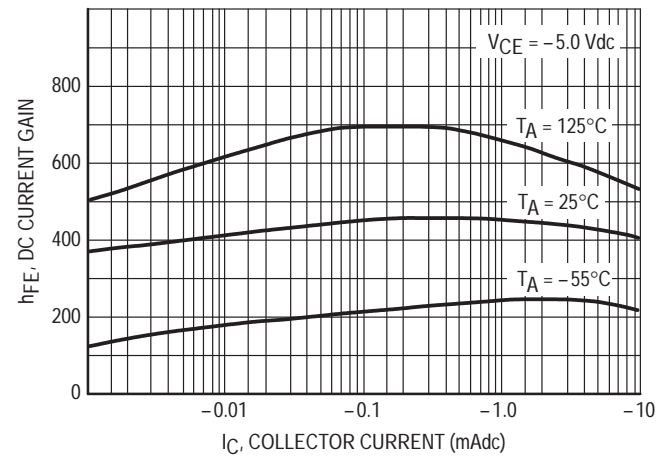
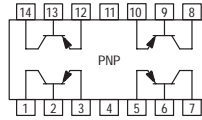


Figure 4. Typical Current Gain Characteristics

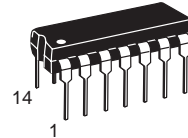
Quad General Purpose Transistors

PNP Silicon



MPQ2906
MPQ2907
MPQ2907A*

*Motorola Preferred Device



CASE 646-06, STYLE 1
TO-116

MAXIMUM RATINGS

Rating	Symbol	MPQ2906 MPQ2907	MPQ2907A	Unit
Collector-Emitter Voltage	V_{CEO}	-40	-60	Vdc
Collector-Base Voltage	V_{CBO}	-60		Vdc
Emitter-Base Voltage	V_{EBO}	-5.0		Vdc
Collector Current — Continuous	I_C	-600		mAdc
		Each Transistor	Total Device	
Total Device Dissipation @ $T_A = 25^\circ\text{C}$ Derate above 25°C	P_D	0.65 6.5	1.9 19	Watts mW/ $^\circ\text{C}$
Operating and Storage Junction Temperature Range	T_J, T_{stg}	-55 to +125		$^\circ\text{C}$

THERMAL CHARACTERISTICS

Characteristic	Symbol	Max	Unit
Thermal Resistance, Junction to Ambient	$R_{\theta JA}$	66	$^\circ\text{C}/\text{W}$

ELECTRICAL CHARACTERISTICS ($T_A = 25^\circ\text{C}$ unless otherwise noted)

Characteristic	Symbol	Min	Max	Unit
----------------	--------	-----	-----	------

OFF CHARACTERISTICS

Collector-Emitter Breakdown Voltage ⁽¹⁾ ($I_C = -10 \text{ mAdc}, I_E = 0$)	MPQ2906, MPQ2907 MPQ2907A	$V_{(BR)CEO}$	-40 -60	— —	Vdc
Collector-Base Breakdown Voltage ($I_C = -10 \mu\text{Adc}, I_E = 0$)		$V_{(BR)CBO}$	-60	—	Vdc
Emitter-Base Breakdown Voltage ($I_E = -10 \mu\text{Adc}, I_C = 0$)		$V_{(BR)EBO}$	-5.0	—	Vdc
Collector Cutoff Current ($V_{CB} = -30 \text{ Vdc}, I_E = 0$) ($V_{CB} = -50 \text{ Vdc}, I_E = 0$)	MPQ2906, MPQ2907 MPQ2907A	I_{CBO}	—	-50	nAdc
Emitter Cutoff Current ($V_{EB} = -3.0 \text{ Vdc}, I_E = 0$)	MPQ2906,7 Only	I_{EBO}	—	-50	nAdc

1. Pulse Test: Pulse Width $\leq 300 \mu\text{s}$, Duty Cycle $\leq 2.0\%$.

Preferred devices are Motorola recommended choices for future use and best overall value.

ELECTRICAL CHARACTERISTICS ($T_A = 25^\circ\text{C}$ unless otherwise noted) (Continued)

Characteristic	Symbol	Min	Max	Unit
ON CHARACTERISTICS				
DC Current Gain ⁽¹⁾ ($I_C = -100 \mu\text{A}$, $V_{CE} = -10 \text{ Vdc}$) ($I_C = -1.0 \text{ mA}$, $V_{CE} = -10 \text{ Vdc}$) ($I_C = -10 \text{ mA}$, $V_{CE} = -10 \text{ Vdc}$)	MPQ2907A MPQ2907A MPQ2906 MPQ2907	h_{FE}	75 100 35 75	— — — —
($I_C = -10 \text{ mA}$, $V_{CE} = -10 \text{ Vdc}$) ($I_C = -150 \text{ mA}$, $V_{CE} = -10 \text{ Vdc}$) ($I_C = -150 \text{ mA}$, $V_{CE} = -10 \text{ Vdc}$)	MPQ2907A MPQ2907A MPQ2906 MPQ2907		100 100 40 100	— 300 — —
($I_C = -300 \text{ mA}$, $V_{CE} = -10 \text{ Vdc}$) ($I_C = -500 \text{ mA}$, $V_{CE} = -10 \text{ Vdc}$)	MPQ2906 MPQ2907 MPQ2906 MPQ2907A		20 30 50	— — —
Collector–Emitter Saturation Voltage ⁽¹⁾ ($I_C = -150 \text{ mA}$, $I_B = -15 \text{ mA}$) ($I_C = -300 \text{ mA}$, $I_B = -30 \text{ mA}$) ($I_C = -500 \text{ mA}$, $I_B = -50 \text{ mA}$)	MPQ2906, MPQ2907 MPQ2907A	$V_{CE(sat)}$	— — —	Vdc -0.4 -1.6 -1.6
Base–Emitter Saturation Voltage ⁽¹⁾ ($I_C = -150 \text{ mA}$, $I_B = -15 \text{ mA}$) ($I_C = -300 \text{ mA}$, $I_B = -30 \text{ mA}$) ($I_C = -500 \text{ mA}$, $I_B = -50 \text{ mA}$)	MPQ2906, MPQ2907 MPQ2906, MPQ2907 MPQ2907A	$V_{BE(sat)}$	— — —	Vdc -1.3 -2.6 -2.6

SMALL–SIGNAL CHARACTERISTICS

Current–Gain — Bandwidth Product ($I_C = -50 \text{ mA}$, $V_{CE} = -20 \text{ Vdc}$, $f = 100 \text{ MHz}$)	f_T	200	—	MHz
Output Capacitance ($V_{CB} = -10 \text{ Vdc}$, $I_E = 0$, $f = 1.0 \text{ MHz}$)	C_{obo}	—	8.0	pF
Input Capacitance ($V_{EB} = 2.0 \text{ Vdc}$, $I_C = 0$, $f = 1.0 \text{ MHz}$)	C_{ibo}	—	30	pF

SWITCHING CHARACTERISTICS

Turn–On Time ($V_{CC} = -30 \text{ Vdc}$, $I_C = -150 \text{ mA}$, $I_{B1} = 15 \text{ mA}$)	MPQ2907A Only	t_{on}	—	45	ns
Turn–Off Time ($V_{CC} = -6.0 \text{ Vdc}$, $I_C = -150 \text{ mA}$, $I_{B1} = I_{B2} = 15 \text{ mA}$)	MPQ2907A Only	t_{off}	—	180	ns

1. Pulse Test: Pulse Width $\leq 300 \mu\text{s}$, Duty Cycle $\leq 2.0\%$.

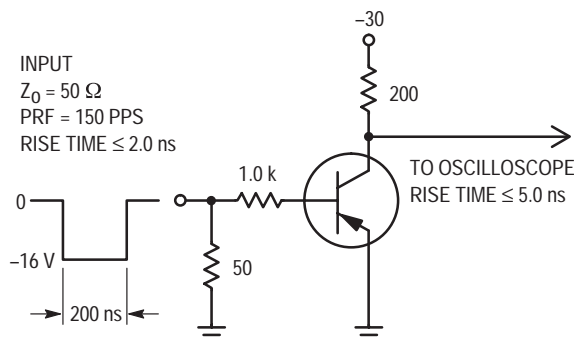


Figure 1. Delay and Rise Time Test Circuit

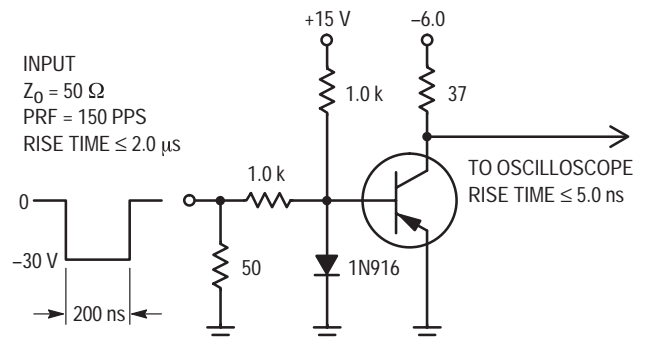


Figure 2. Storage and Fall Time Test Circuit

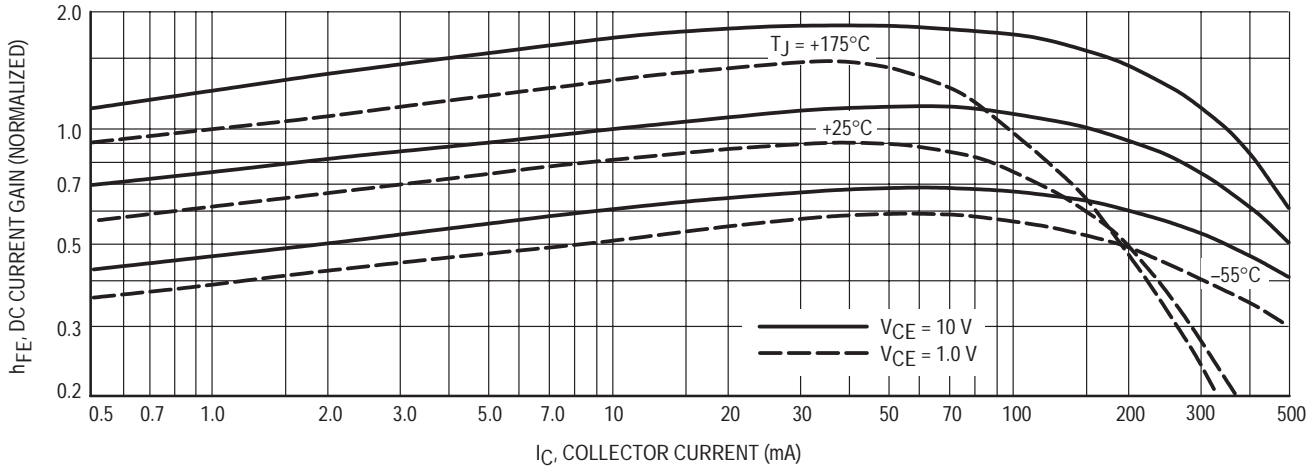


Figure 3. DC Current Gain

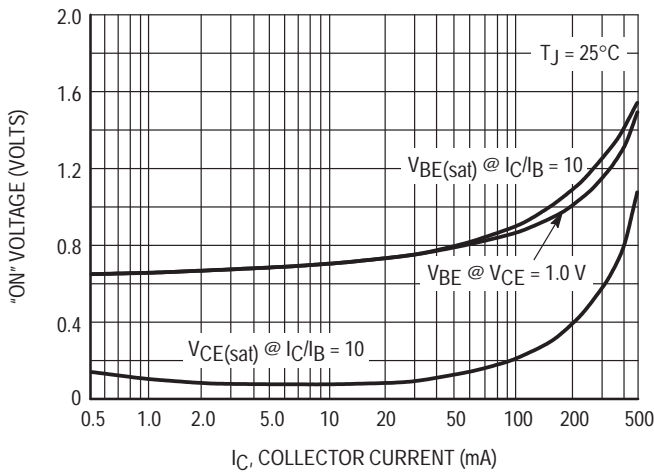


Figure 4. "ON" Voltages

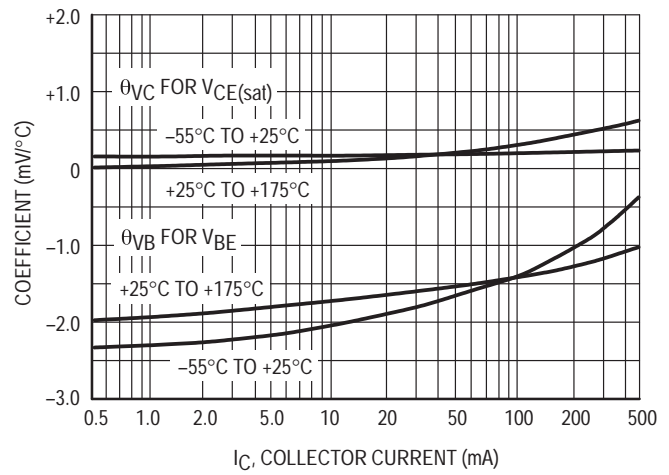


Figure 5. Temperature Coefficients

NOISE FIGURE
($V_{CE} = 10\text{ V}$, $T_A = 25^\circ\text{C}$)

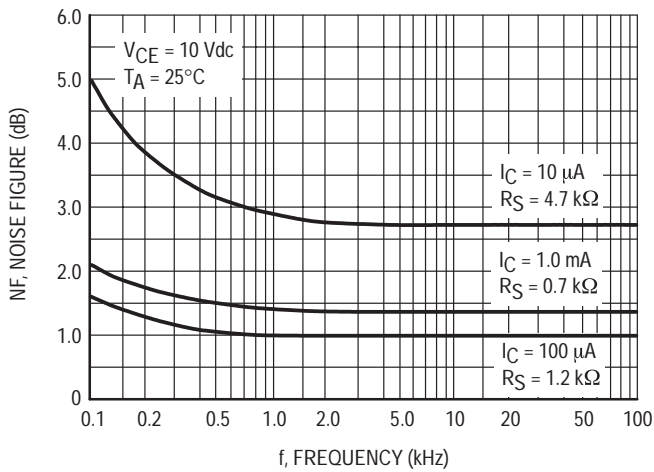


Figure 6. Frequency Effects

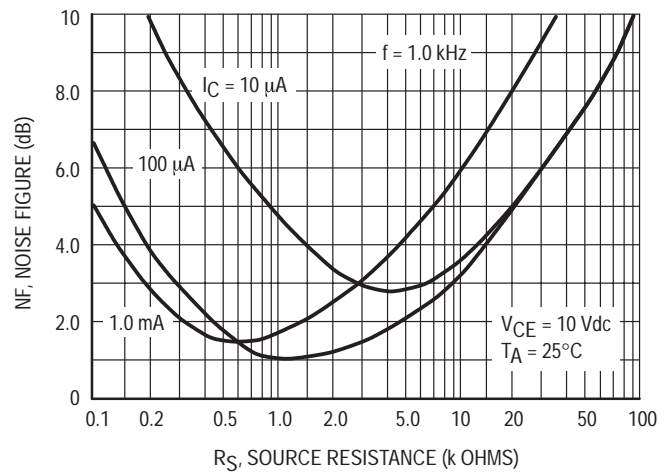


Figure 7. Source Resistance Effects

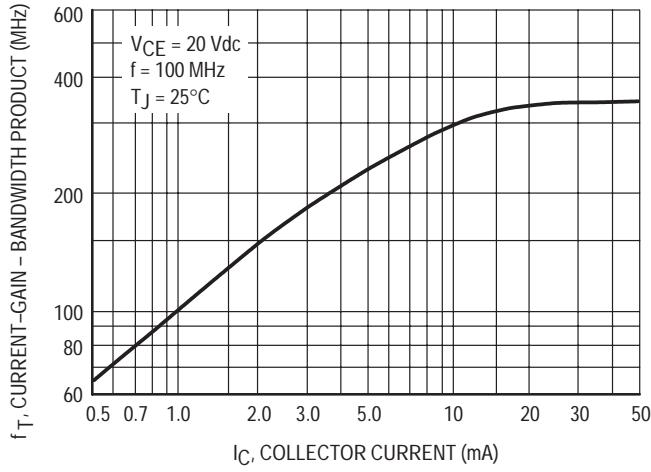


Figure 8. Current-Gain — Bandwidth Product

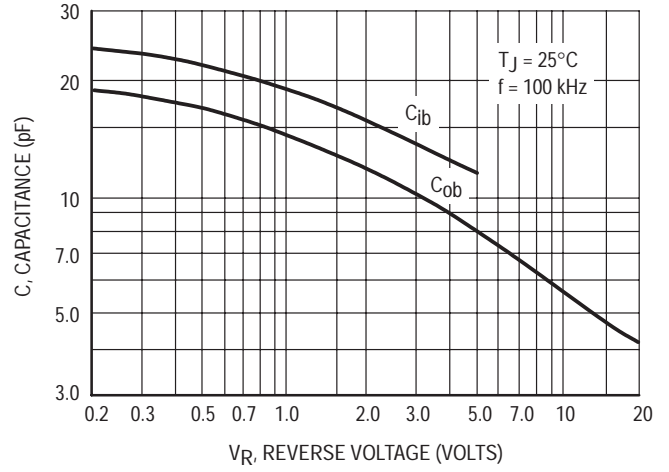


Figure 9. Capacitance

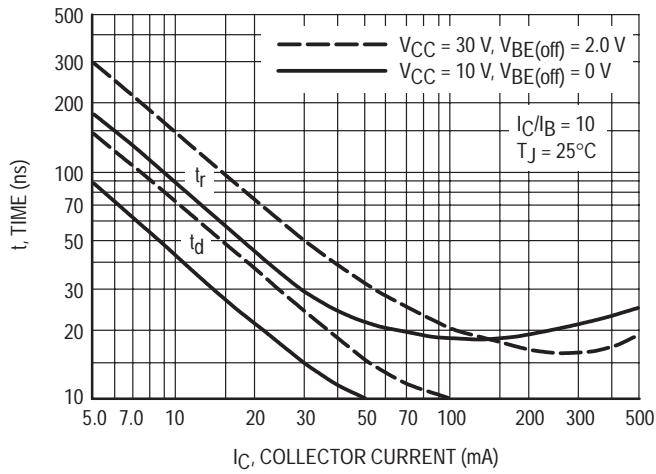


Figure 10. Turn-On Time

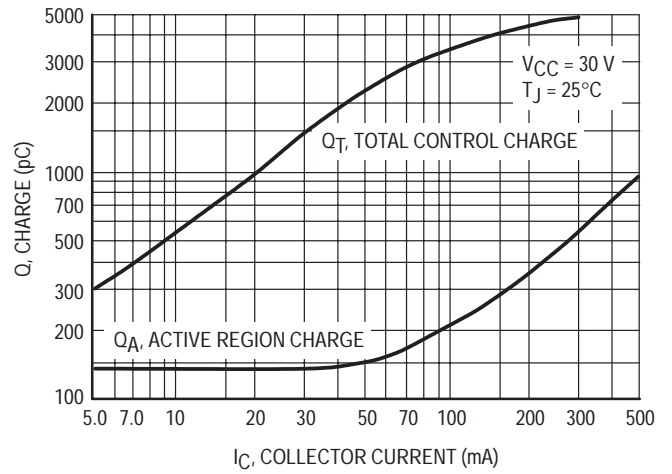


Figure 11. Charge Data

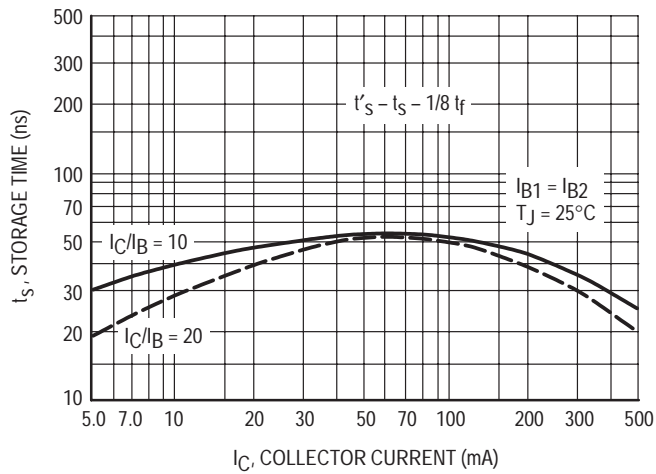


Figure 12. Storage Time

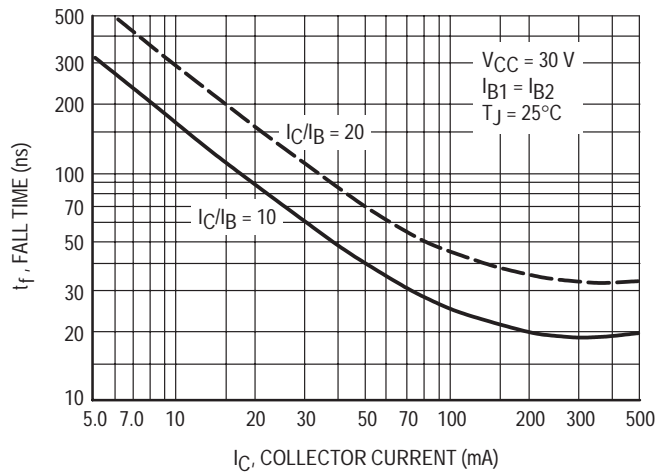


Figure 13. Fall Time

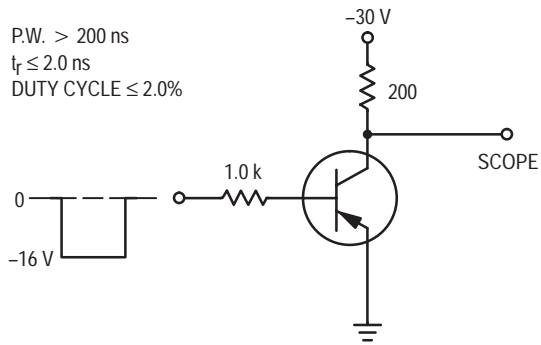


Figure 14. Delay and Rise Time Test Circuit

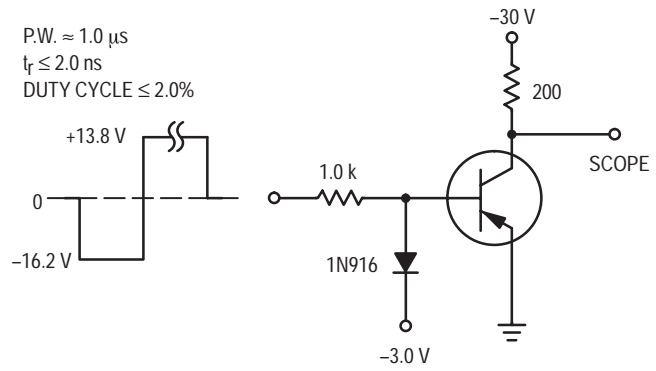
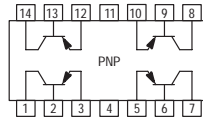


Figure 15. Storage and Fall Time Test Circuit

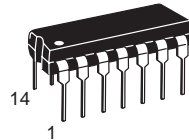
Quad Memory Driver Transistor

PNP Silicon



MPQ3467

Motorola Preferred Device



CASE 646-06, STYLE 1
TO-116

MAXIMUM RATINGS

Rating	Symbol	Value		Unit
Collector-Emitter Voltage	V_{CEO}	-40		Vdc
Collector-Base Voltage	V_{CBO}	-40		Vdc
Emitter-Base Voltage	V_{EBO}	-5.0		Vdc
Collector Current — Continuous	I_C	-1.0		Adc
		Each Transistor	Four Transistors Equal Power	
Total Device Dissipation @ $T_A = 25^\circ\text{C}$ ⁽¹⁾ Derate above 25°C	P_D	650 5.2	1500 12	mW mW/ $^\circ\text{C}$
Total Device Dissipation @ $T_C = 25^\circ\text{C}$ Derate above 25°C	P_D	1.25 10	3.2 25.6	Watts mW/ $^\circ\text{C}$
Operating and Storage Junction Temperature Range	T_J, T_{stg}	-55 to +150		$^\circ\text{C}$

THERMAL CHARACTERISTICS

Characteristic		$R_{\theta JC}$ Junction to Case	$R_{\theta JA}$ Junction to Ambient	Unit
Thermal Resistance	Each Die	100	193	$^\circ\text{C}/\text{W}$
	Effective, 4 Die	39	83.2	$^\circ\text{C}/\text{W}$
Coupling Factors	Q1-Q4 or Q2-Q3	45	55	%
	Q1-Q2 or Q3-Q4	5.0	10	%

ELECTRICAL CHARACTERISTICS ($T_A = 25^\circ\text{C}$ unless otherwise noted)

Characteristic	Symbol	Min	Typ	Max	Unit
----------------	--------	-----	-----	-----	------

OFF CHARACTERISTICS

Collector-Emitter Breakdown Voltage ⁽²⁾ ($I_C = -10 \text{ mAdc}, I_E = 0$)	$V_{(BR)CEO}$	-40	—	—	Vdc
Collector-Base Breakdown Voltage ($I_C = -10 \mu\text{Adc}, I_E = 0$)	$V_{(BR)CBO}$	-40	—	—	Vdc
Emitter-Base Breakdown Voltage ($I_E = -10 \mu\text{Adc}, I_C = 0$)	$V_{(BR)EBO}$	-5.0	—	—	Vdc
Collector Cutoff Current ($V_{CB} = -30 \text{ Vdc}, I_E = 0$)	I_{CBO}	—	—	-200	nAdc
Emitter Cutoff Current ($V_{EB} = -3.0 \text{ Vdc}, I_C = 0$)	I_{EBO}	—	—	-200	nAdc

1. Second Breakdown occurs at power levels greater than 2 times the power dissipation rating.
2. Pulse Test: Pulse Width $\leq 300 \mu\text{s}$; Duty Cycle $\leq 2.0\%$.

Preferred devices are Motorola recommended choices for future use and best overall value.

MPQ3467**ELECTRICAL CHARACTERISTICS** ($T_A = 25^\circ\text{C}$ unless otherwise noted) (Continued)

Characteristic	Symbol	Min	Typ	Max	Unit
ON CHARACTERISTICS					
DC Current Gain ⁽²⁾ ($I_C = -500\text{ mAdc}$, $V_{CE} = -1.0\text{ Vdc}$)	h_{FE}	-20	—	—	—
Collector–Emitter Saturation Voltage ⁽²⁾ ($I_C = -500\text{ mAdc}$, $I_B = -50\text{ mAdc}$)	$V_{CE(sat)}$	—	-0.23	-0.5	Vdc
Base–Emitter Saturation Voltage ⁽²⁾ ($I_C = -500\text{ mAdc}$, $I_B = -50\text{ mAdc}$)	$V_{BE(sat)}$	—	-0.90	-1.2	Vdc
SMALL–SIGNAL CHARACTERISTICS					
Current–Gain — Bandwidth Product ($I_C = -50\text{ mAdc}$, $V_{CE} = -10\text{ Vdc}$, $f = 100\text{ MHz}$)	f_T	125	190	—	MHz
Output Capacitance ($V_{CB} = -10\text{ Vdc}$, $I_E = 0$, $f = 1.0\text{ MHz}$)	C_{obo}	—	10	25	pF
Input Capacitance ($V_{EB} = -0.5\text{ Vdc}$, $I_C = 0$, $f = 1.0\text{ MHz}$)	C_{ibo}	—	55	80	pF
SWITCHING CHARACTERISTICS					
Turn–On Time ($I_C = -500\text{ mAdc}$, $I_{B1} = -50\text{ mAdc}$)	t_{on}	—	—	40	ns
Turn–Off Time ($I_C = -500\text{ mAdc}$, $I_{B1} = I_{B2} = -50\text{ mAdc}$)	t_{off}	—	—	90	ns

2. Pulse Test: Pulse Width $\leq 300\ \mu\text{s}$; Duty Cycle $\leq 2.0\%$.

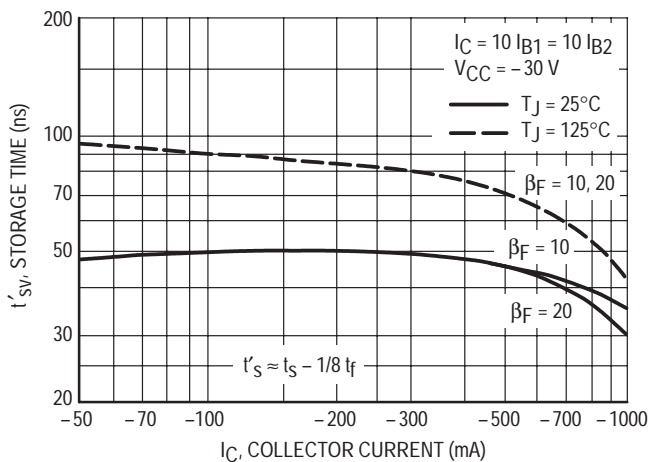


Figure 1. Storage Time Variation with Temperature

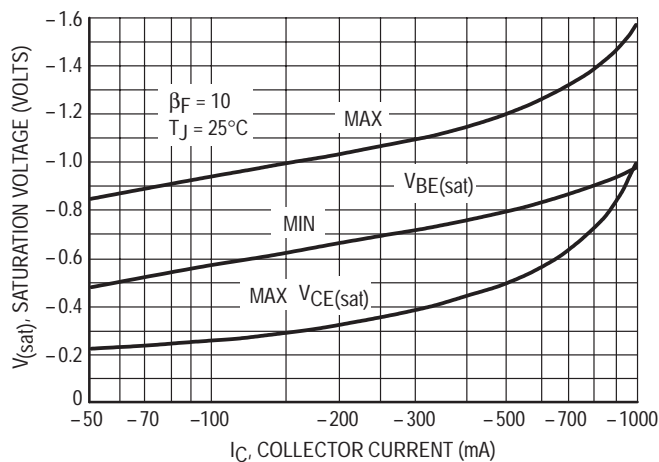


Figure 2. Limits of Saturation Voltage

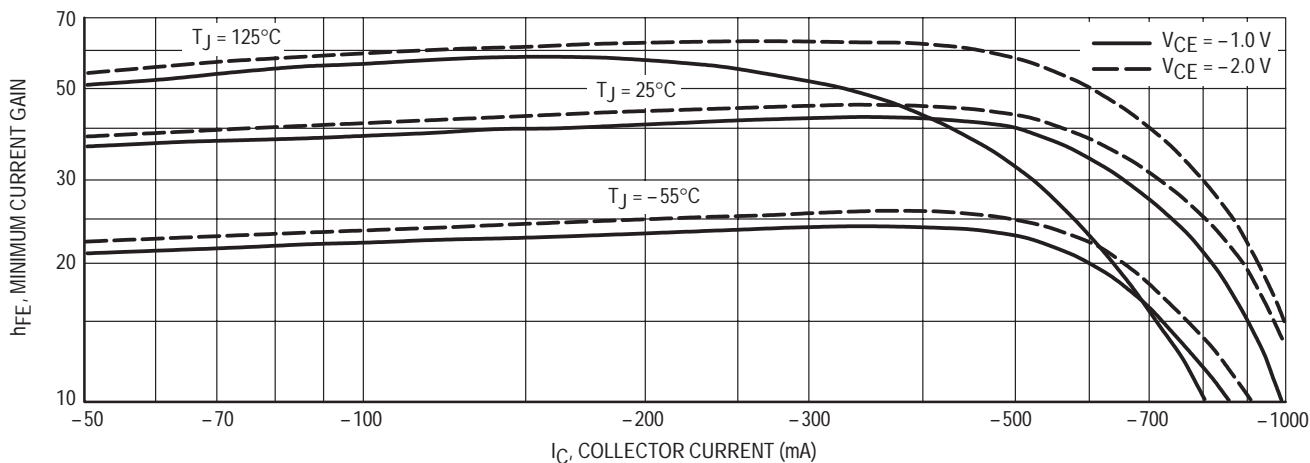
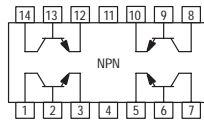


Figure 3. Minimum Current Gain Characteristics

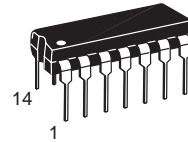
Quad Core Driver Transistor

NPN Silicon



MPQ3725

Motorola Preferred Device



CASE 646-06, STYLE 1
TO-116

MAXIMUM RATINGS

Rating	Symbol	Value		Unit
Collector–Emitter Voltage	V_{CEO}	40		Vdc
Collector–Emitter Voltage	V_{CES}	60		Vdc
Emitter–Base Voltage	V_{EBO}	5.0		Vdc
Collector Current — Continuous	I_C	1.0		Adc
		One Transistor	Four Transistors Equal Power	
Total Device Dissipation @ $T_A = 25^\circ\text{C}$ Derate above 25°C	P_D	1.0 8.0	2.5 20	Watts mW/ $^\circ\text{C}$
Operating and Storage Junction Temperature Range	T_J, T_{stg}	–55 to +150		$^\circ\text{C}$

THERMAL CHARACTERISTICS

Characteristic	Symbol	Max		Unit
		One Transistor	Effective For Four Transistors	
Thermal Resistance, Junction to Ambient(1)	$R_{\theta JA}$	125	50	$^\circ\text{C}/\text{W}$

ELECTRICAL CHARACTERISTICS ($T_A = 25^\circ\text{C}$ unless otherwise noted)

Characteristic	Symbol	Min	Typ	Max	Unit
----------------	--------	-----	-----	-----	------

OFF CHARACTERISTICS

Collector–Emitter Breakdown Voltage(2) ($I_C = 10 \text{ mAdc}, I_B = 0$)	$V_{(BR)CEO}$	40	—	—	Vdc
Collector–Emitter Breakdown Voltage ($I_C = 100 \mu\text{Adc}, V_{BE} = 0$)	$V_{(BR)CES}$	60	—	—	Vdc
Emitter–Base Breakdown Voltage ($I_E = 10 \mu\text{Adc}, I_C = 0$)	$V_{(BR)EBO}$	5.0	—	—	Vdc
Collector Cutoff Current ($V_{CB} = 40 \text{ Vdc}, I_E = 0$)	I_{CBO}	—	—	0.5	μAdc

1. $R_{\theta JA}$ is measured with the device soldered into a typical printed circuit board.

2. Pulse Test: Pulse Width $\leq 300 \mu\text{s}$; Duty Cycle $\leq 2.0\%$.

Preferred devices are Motorola recommended choices for future use and best overall value.

ELECTRICAL CHARACTERISTICS ($T_A = 25^\circ\text{C}$ unless otherwise noted) (Continued)

Characteristic	Symbol	Min	Typ	Max	Unit
ON CHARACTERISTICS(2)					
DC Current Gain ($I_C = 100\text{ mAdc}$, $V_{CE} = 1.0\text{ Vdc}$) ($I_C = 500\text{ mAdc}$, $V_{CE} = 2.0\text{ Vdc}$)	h_{FE}	35 25	75 45	200 —	—
Collector–Emitter Saturation Voltage ($I_C = 500\text{ mAdc}$, $I_B = 50\text{ mAdc}$)	$V_{CE(sat)}$	—	0.32	0.45	Vdc
Base–Emitter Saturation Voltage ($I_C = 500\text{ mAdc}$, $I_B = 50\text{ mAdc}$)	$V_{BE(sat)}$	0.8	0.9	1.1	Vdc

SMALL–SIGNAL CHARACTERISTICS

Current–Gain — Bandwidth Product ($I_C = 50\text{ mAdc}$, $V_{CE} = 10\text{ Vdc}$, $f = 100\text{ MHz}$)	f_T	250	275	—	MHz
Output Capacitance ($V_{CB} = 10\text{ Vdc}$, $I_E = 0$, $f = 1.0\text{ MHz}$)	C_{obo}	—	5.1	10	pF
Input Capacitance ($V_{EB} = 0.5\text{ Vdc}$, $I_C = 0$, $f = 1.0\text{ MHz}$)	C_{ibo}	—	62	80	pF

SWITCHING CHARACTERISTICS

Turn–On Time ($I_C = 500\text{ mAdc}$, $I_{B1} = 50\text{ mAdc}$ $V_{BE(off)} = -3.8\text{ Vdc}$)	t_{on}	—	20	35	ns
Turn–Off Time ($I_C = 500\text{ mAdc}$, $I_{B1} = I_{B2} = 50\text{ mAdc}$)	t_{off}	—	50	60	ns

2. Pulse Test: Pulse Width $\leq 300\ \mu\text{s}$; Duty Cycle $\leq 2.0\%$.

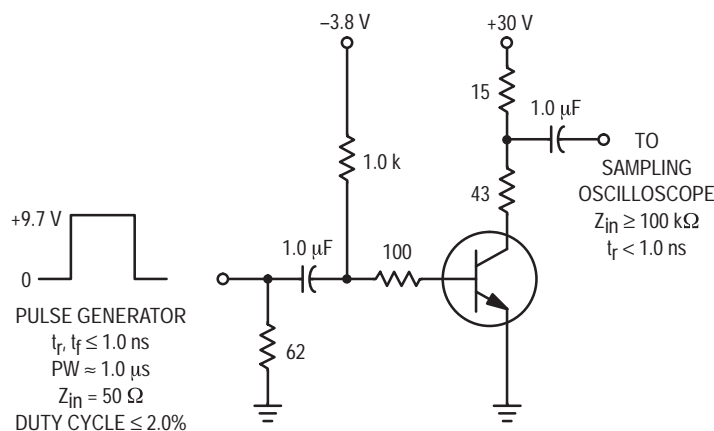


Figure 1. Switching Times Test Circuit

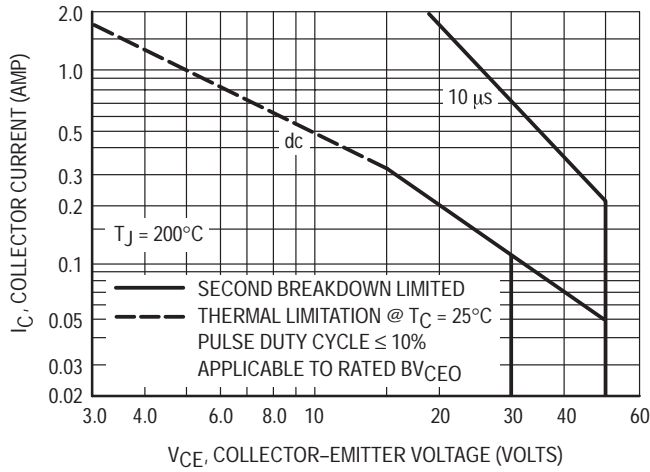


Figure 2. Active-Region Safe Operating Area

TYPICAL DC CHARACTERISTICS

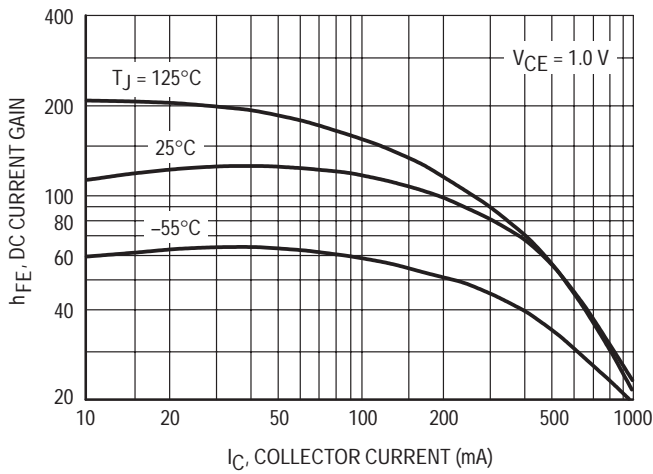


Figure 3. DC Current Gain

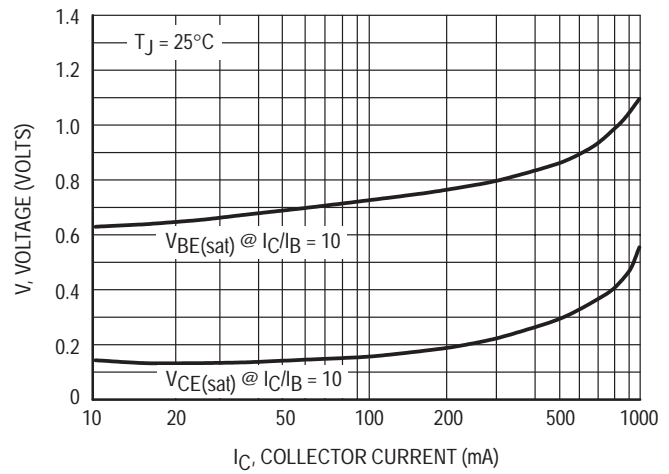


Figure 4. "ON" Voltages

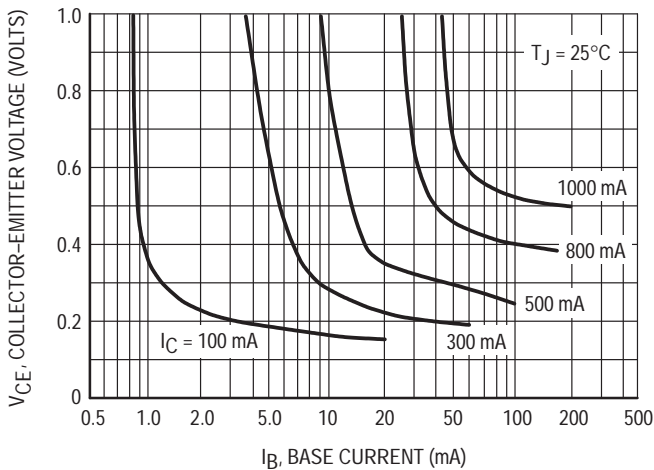


Figure 5. Collector Saturation Region

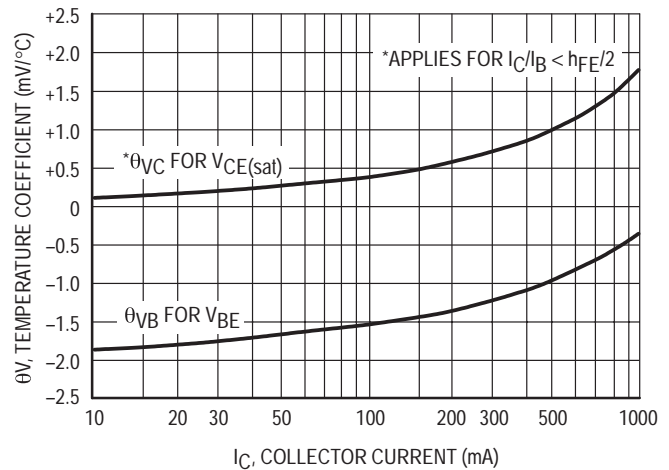


Figure 6. Temperature Coefficients

TYPICAL DYNAMIC CHARACTERISTICS

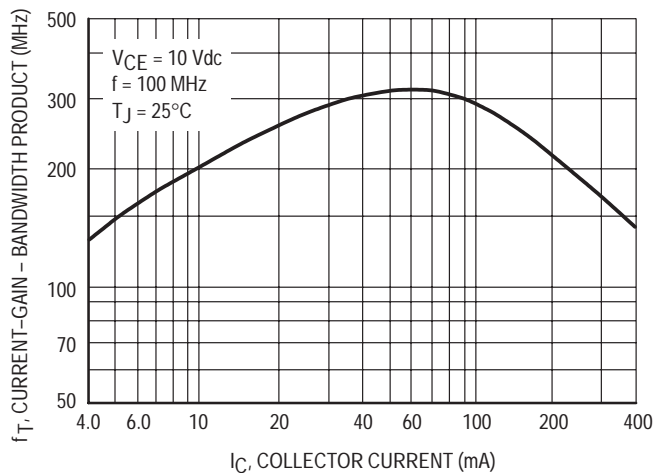


Figure 7. Current-Gain — Bandwidth Product

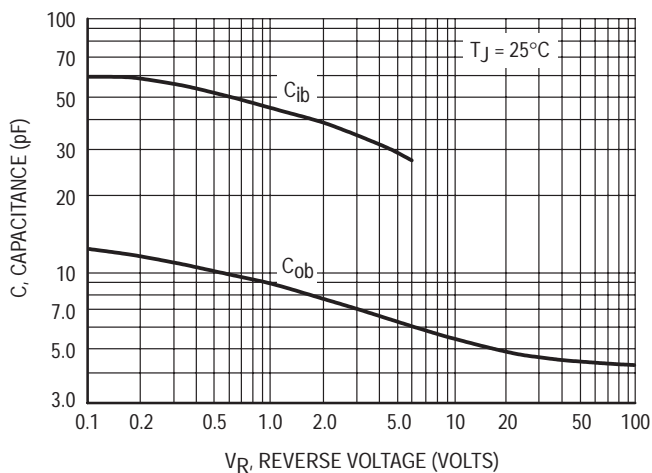


Figure 8. Capacitance

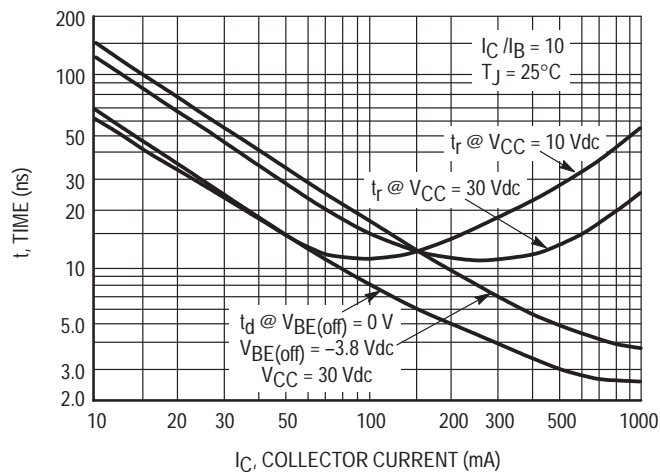


Figure 9. Turn-On Time

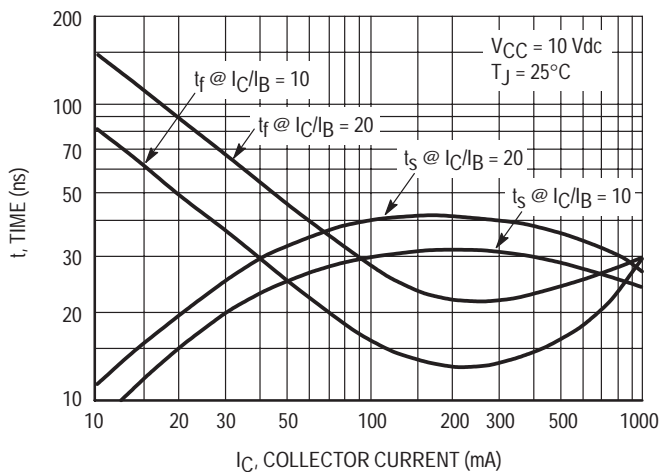


Figure 10. Turn-Off Time

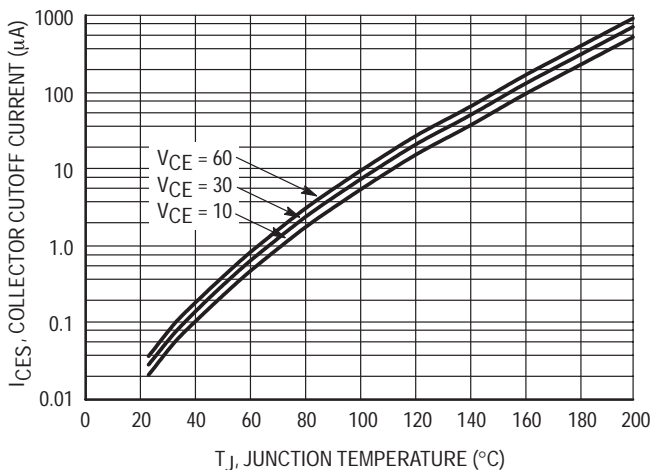
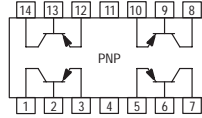


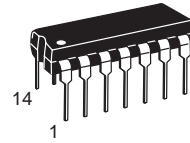
Figure 11. Collector Cutoff Current

Quad Memory Driver Transistor

PNP Silicon



MPQ3762



CASE 646-06, STYLE 1
TO-116

MAXIMUM RATINGS

Rating	Symbol	Value		Unit
Collector-Emitter Voltage	V_{CEO}	-40		Vdc
Collector-Base Voltage	V_{CBO}	-40		Vdc
Emitter-Base Voltage	V_{EBO}	-5.0		Vdc
Collector Current — Continuous	I_C	-1.5		Adc
		Each Transistor	Four Transistors Equal Power	
Total Device Dissipation @ $T_A = 25^\circ\text{C}$ Derate above 25°C	P_D	750 5.98	1700 13.6	mW mW/ $^\circ\text{C}$
Total Device Dissipation @ $T_C = 25^\circ\text{C}$ Derate above 25°C	P_D	1.25 10	3.2 25.6	Watts mW/ $^\circ\text{C}$
Operating and Storage Junction Temperature Range	T_J, T_{stg}	-55 to +150		$^\circ\text{C}$

THERMAL CHARACTERISTICS

Characteristic		Junction to Case	Junction to Ambient	Unit
Thermal Resistance ⁽¹⁾	Each Die	100	167	$^\circ\text{C}/\text{W}$
	Effective, 4 Die	39	73.5	$^\circ\text{C}/\text{W}$
Coupling Factors	Q1-Q4 or Q2-Q3	46	56	%
	Q1-Q2 or Q3-Q4	5.0	10	%

ELECTRICAL CHARACTERISTICS ($T_A = 25^\circ\text{C}$ unless otherwise noted)

Characteristic	Symbol	Min	Typ	Max	Unit
----------------	--------	-----	-----	-----	------

OFF CHARACTERISTICS

Collector-Emitter Breakdown Voltage ⁽²⁾ ($I_C = -10 \text{ mAdc}, I_B = 0$)	$V_{(BR)CEO}$	-40	—	—	Vdc
Collector-Base Breakdown Voltage ($I_C = -10 \mu\text{Adc}, I_E = 0$)	$V_{(BR)CBO}$	-40	—	—	Vdc
Emitter-Base Breakdown Voltage ($I_E = -10 \mu\text{Adc}, I_C = 0$)	$V_{(BR)EBO}$	-5.0	—	—	Vdc
Collector Cutoff Current ($V_{CB} = -30 \text{ Vdc}, I_E = 0$)	I_{CBO}	—	—	-100	nAdc
Emitter Cutoff Current ($V_{EB} = -3.0 \text{ Vdc}, I_C = 0$)	I_{EBO}	—	—	-100	nAdc

- $R_{\theta JA}$ is measured with the device soldered into a typical printed circuit board.
- Pulse Test: Pulse Width $\leq 300 \mu\text{s}$; Duty Cycle $\leq 2.0\%$.

ELECTRICAL CHARACTERISTICS ($T_A = 25^\circ\text{C}$ unless otherwise noted) (Continued)

Characteristic	Symbol	Min	Typ	Max	Unit
ON CHARACTERISTICS(2)					
DC Current Gain ($I_C = -150\text{ mAdc}$, $V_{CE} = -1.0\text{ Vdc}$) ($I_C = -500\text{ mAdc}$, $V_{CE} = -2.0\text{ Vdc}$) ($I_C = -1.0\text{ Adc}$, $V_{CE} = -2.0\text{ Vdc}$)	h_{FE}	35 30 20	70 65 35	— — —	—
Collector–Emitter Saturation Voltage ($I_C = -500\text{ mAdc}$, $I_B = -50\text{ mAdc}$) ($I_C = -1.0\text{ Adc}$, $I_B = -100\text{ mAdc}$)	$V_{CE(sat)}$	— —	-0.3 -0.6	-0.55 -0.9	Vdc
Base–Emitter Saturation Voltage ($I_C = -500\text{ mAdc}$, $I_B = -50\text{ mAdc}$) ($I_C = -1.0\text{ Adc}$, $I_B = -100\text{ mAdc}$)	$V_{BE(sat)}$	— —	-0.9 -1.0	-1.25 -1.4	Vdc
SMALL–SIGNAL CHARACTERISTICS					
Current–Gain — Bandwidth Product(2) ($I_C = -50\text{ mAdc}$, $V_{CE} = -10\text{ Vdc}$, $f = 100\text{ MHz}$)	f_T	150	275	—	MHz
Output Capacitance ($V_{CB} = -10\text{ Vdc}$, $I_E = 0$, $f = 1.0\text{ MHz}$)	C_{obo}	—	9.0	15	pF
Input Capacitance ($V_{EB} = -0.5\text{ Vdc}$, $I_C = 0$, $f = 1.0\text{ MHz}$)	C_{ibo}	—	55	80	pF
SWITCHING CHARACTERISTICS					
Turn–On Time ($V_{CC} = -30\text{ Vdc}$, $I_C = -1.0\text{ Adc}$, $I_{B1} = -100\text{ mAdc}$, $V_{BE(off)} = 2.0\text{ Vdc}$)	t_{on}	—	—	50	ns
Turn–Off Time ($V_{CC} = -30\text{ Vdc}$, $I_C = -1.0\text{ Adc}$, $I_{B1} = I_{B2} = -100\text{ mAdc}$)	t_{off}	—	—	120	ns

2. Pulse Test: Pulse Width $\leq 300\ \mu\text{s}$; Duty Cycle $\leq 2.0\%$.

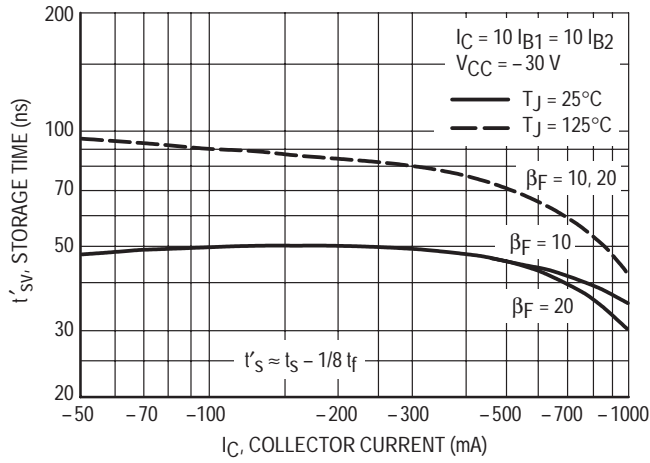


Figure 1. Storage Time Variation with Temperature

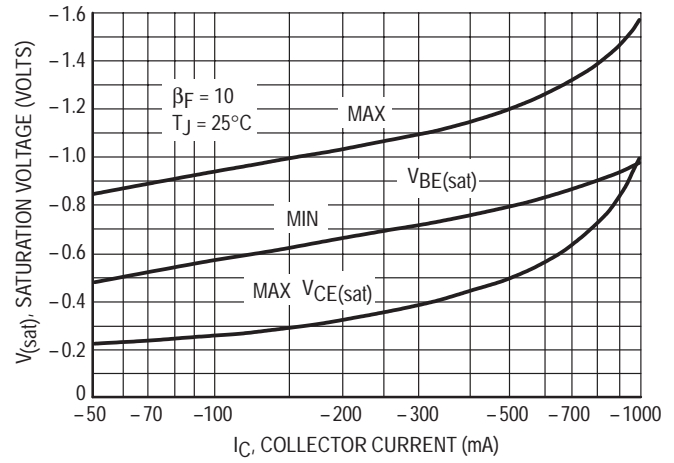


Figure 2. Limits of Saturation Voltage

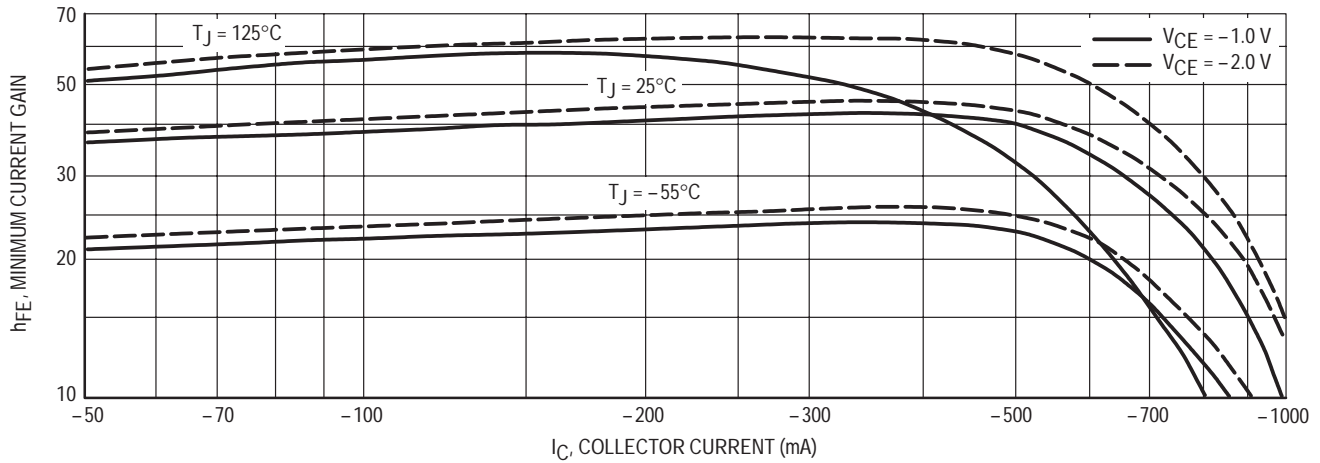
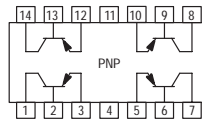


Figure 3. Minimum Current Gain Characteristics

Quad Amplifier Transistors

PNP Silicon

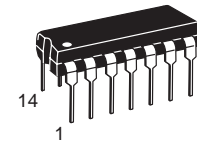


MPQ3798
MPQ3799*

*Motorola Preferred Device

MAXIMUM RATINGS

Rating	Symbol	MPQ3798	MPQ3799	Unit
Collector–Emitter Voltage	V_{CEO}	-40	-60	Vdc
Collector–Base Voltage	V_{CBO}	-60		Vdc
Emitter–Base Voltage	V_{EBO}	-5.0		Vdc
Collector Current — Continuous	I_C	-50		mAdc
		Each Transistor	Four Transistors Equal Power	
Total Device Dissipation @ $T_A = 25^\circ\text{C}$ (1) Derate above 25°C	P_D	0.5 4.0	0.9 7.2	Watts mW/ $^\circ\text{C}$
Total Device Dissipation @ $T_C = 25^\circ\text{C}$ Derate above 25°C	P_D	0.825 6.7	2.4 19.2	Watts m/ $^\circ\text{C}$
Operating and Storage Junction Temperature Range	T_J, T_{stg}	-55 to +150		$^\circ\text{C}$



CASE 646-06, STYLE 1
TO-116

THERMAL CHARACTERISTICS

Characteristic		$R_{\theta JC}$ Junction to Case	$R_{\theta JA}$ Junction to Ambient	Unit
Thermal Resistance	Each Die	151	250	$^\circ\text{C}/\text{W}$
	Effective, 4 Die	52	139	$^\circ\text{C}/\text{W}$
Coupling Factors	Q1–Q4 or Q2–Q3	34	70	%
	Q1–Q2 or Q3–Q4	2.0	26	%

ELECTRICAL CHARACTERISTICS ($T_A = 25^\circ\text{C}$ unless otherwise noted)

Characteristic	Symbol	Min	Typ	Max	Unit
----------------	--------	-----	-----	-----	------

OFF CHARACTERISTICS

Collector–Emitter Breakdown Voltage(2) ($I_C = -10 \text{ mAdc}, I_E = 0$)	MPQ3798 MPQ3799	$V_{(BR)CEO}$	-40 -60	— —	— —	Vdc
Collector–Base Breakdown Voltage ($I_C = -10 \mu\text{Adc}, I_E = 0$)		$V_{(BR)CBO}$	-60	—	—	Vdc
Emitter–Base Breakdown Voltage ($I_E = -10 \mu\text{Adc}, I_C = 0$)		$V_{(BR)EBO}$	-5.0	—	—	Vdc
Collector Cutoff Current ($V_{CB} = -50 \text{ Vdc}, I_E = 0$)		I_{CBO}	—	—	-10	nAdc
Emitter Cutoff Current ($V_{EB} = -3.0 \text{ Vdc}, I_C = 0$)		I_{EBO}	—	—	-20	nAdc

1. Second breakdown occurs at power levels greater than 3 times the power dissipation rating.
2. Pulse Test: Pulse Width $\leq 300 \mu\text{s}$; Duty Cycle $\leq 2.0\%$.

Preferred devices are Motorola recommended choices for future use and best overall value.

MPQ3798 MPQ3799**ELECTRICAL CHARACTERISTICS** ($T_A = 25^\circ\text{C}$ unless otherwise noted) (Continued)

Characteristic	Symbol	Min	Typ	Max	Unit
ON CHARACTERISTICS					
DC Current Gain ($I_C = -10\ \mu\text{Adc}$, $V_{CE} = -5.0\ \text{Vdc}$)	h_{FE}	100	—	—	—
MPQ3798 MPQ3799		225	—	—	
($I_C = -100\ \mu\text{Adc}$, $V_{CE} = -5.0\ \text{Vdc}$)	h_{FE}	150	—	—	—
MPQ3798 MPQ3799		300	—	—	
($I_C = -500\ \mu\text{Adc}$, $V_{CE} = -5.0\ \text{Vdc}$)	h_{FE}	150	—	—	—
MPQ3798 MPQ3799		300	—	—	
($I_C = -10\ \text{mAdc}$, $V_{CE} = -5.0\ \text{Vdc}$)	h_{FE}	125	—	—	—
MPQ3798 MPQ3799		250	—	—	
Collector–Emitter Saturation Voltage ($I_C = -100\ \mu\text{Adc}$, $I_B = -10\ \mu\text{Adc}$) ($I_C = -1.0\ \text{mAdc}$, $I_B = -100\ \mu\text{Adc}$)	$V_{CE(\text{sat})}$	—	-0.12 -0.07	-0.2 -0.25	Vdc
Base–Emitter Saturation Voltage ($I_C = -100\ \mu\text{Adc}$, $I_B = -10\ \mu\text{Adc}$) ($I_C = -1.0\ \text{mAdc}$, $I_B = -100\ \mu\text{Adc}$)	$V_{BE(\text{sat})}$	—	-0.62 -0.68	-0.7 -0.8	Vdc
SMALL–SIGNAL CHARACTERISTICS					
Current–Gain — Bandwidth Product ($I_C = -1.0\ \text{mAdc}$, $V_{CE} = -5.0\ \text{Vdc}$, $f = 100\ \text{MHz}$)	f_T	60	250	—	MHz
Output Capacitance ($V_{CB} = -5.0\ \text{Vdc}$, $I_E = 0$, $f = 1.0\ \text{MHz}$)	C_{obo}	—	2.1	4.0	pF
Input Capacitance ($V_{EB} = -0.5\ \text{Vdc}$, $I_C = 0$, $f = 1.0\ \text{MHz}$)	C_{ibo}	—	5.5	8.0	pF
Noise Figure ($I_C = -100\ \mu\text{Adc}$, $V_{CE} = -10\ \text{Vdc}$, $R_S = 3.0\ \text{k ohms}$, $f = 1.0\ \text{kHz}$)	NF	—	2.5	—	dB
MPQ3798 MPQ3799		—	1.5	—	

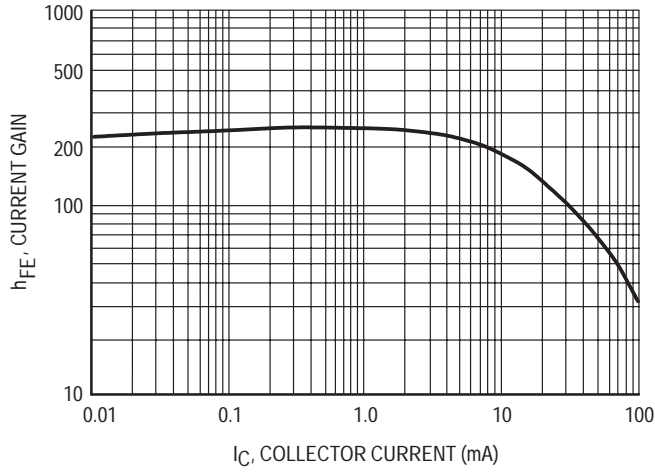


Figure 1. DC Current Gain versus Collector Current

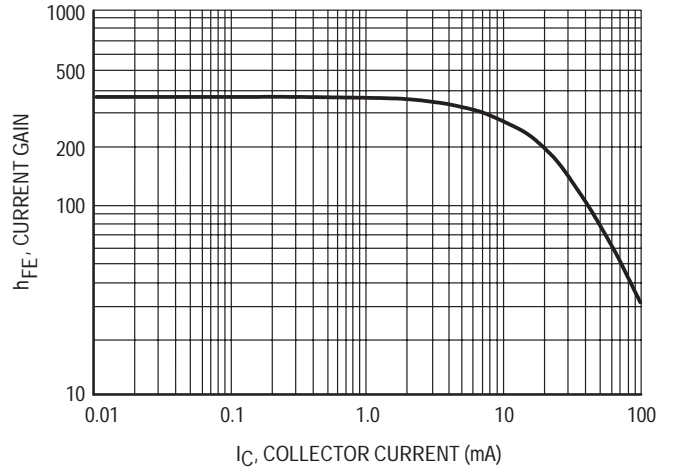


Figure 2. DC Current Gain versus Collector Current

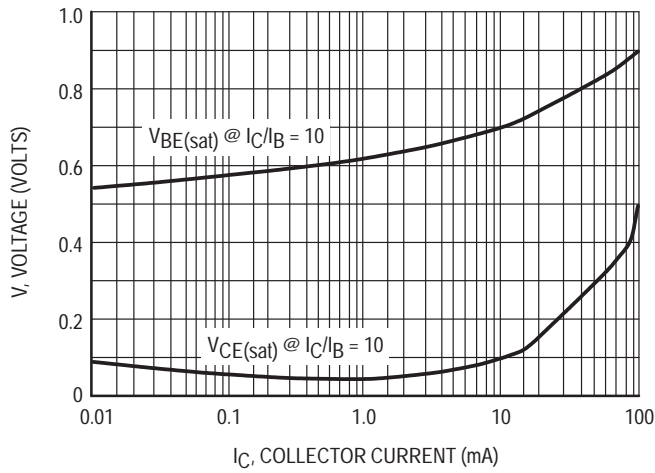


Figure 3. "ON" Voltages

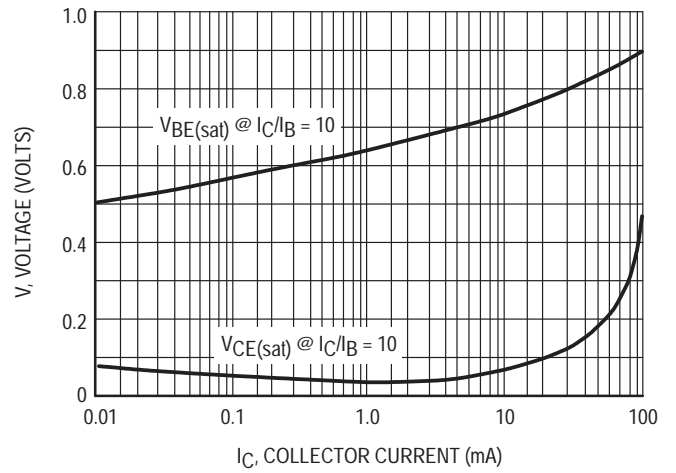
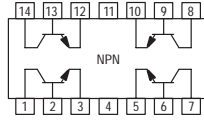


Figure 4. "ON" Voltages

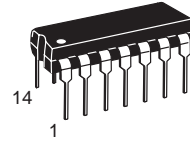
Quad Amplifier Switching Transistor

NPN Silicon



MPQ3904

Motorola Preferred Device



CASE 646-06, STYLE 1
TO-116

MAXIMUM RATINGS

Rating	Symbol	Value	Unit
Collector–Emitter Voltage	V_{CEO}	40	Vdc
Collector–Base Voltage	V_{CBO}	60	Vdc
Emitter–Base Voltage	V_{EBO}	6.0	Vdc
Collector Current — Continuous	I_C	200	mAdc
		Each Transistor	Four Transistors Equal Power
Total Device Dissipation @ $T_A = 25^\circ\text{C}$ Derate above 25°C	P_D	500 4.0	mW mW/ $^\circ\text{C}$
Total Device Dissipation @ $T_C = 25^\circ\text{C}$ Derate above 25°C	P_D	825 6.7	Watts mW/ $^\circ\text{C}$
Operating and Storage Junction Temperature Range	T_J, T_{stg}	–55 to +150	$^\circ\text{C}$

THERMAL CHARACTERISTICS

Characteristic	Junction to Case	Junction to Ambient	Unit
Thermal Resistance	Each Die	151	$^\circ\text{C}/\text{W}$
	Effective, 4 Die	52	$^\circ\text{C}/\text{W}$
Coupling Factors	Q1–Q4 or Q2–Q3	34	%
	Q1–Q2 or Q3–Q4	2.0	%

ELECTRICAL CHARACTERISTICS ($T_A = 25^\circ\text{C}$ unless otherwise noted)

Characteristic	Symbol	Min	Typ	Max	Unit
----------------	--------	-----	-----	-----	------

OFF CHARACTERISTICS

Collector–Emitter Breakdown Voltage ⁽¹⁾ ($I_C = 1.0 \text{ mAdc}, I_E = 0$)	$V_{(BR)CEO}$	40	—	—	Vdc
Collector–Base Breakdown Voltage ($I_C = 10 \mu\text{Adc}, I_E = 0$)	$V_{(BR)CBO}$	60	—	—	Vdc
Emitter–Base Breakdown Voltage ($I_E = 10 \mu\text{Adc}, I_C = 0$)	$V_{(BR)EBO}$	6.0	—	—	Vdc
Collector Cutoff Current ($V_{CB} = 40 \text{ Vdc}, I_E = 0$)	I_{CBO}	—	—	50	nAdc
Emitter Cutoff Current ($V_{EB} = 40 \text{ Vdc}, I_C = 0$)	I_{EBO}	—	—	50	nAdc

1. Pulse Test: Pulse Width $\leq 300 \mu\text{s}$; Duty Cycle $\leq 2.0\%$.

Preferred devices are Motorola recommended choices for future use and best overall value.

ELECTRICAL CHARACTERISTICS ($T_A = 25^\circ\text{C}$ unless otherwise noted) (Continued)

Characteristic	Symbol	Min	Typ	Max	Unit
ON CHARACTERISTICS(1)					
DC Current Gain ($I_C = 0.1 \text{ mAdc}$, $V_{CE} = 1.0 \text{ Vdc}$) ($I_C = 1.0 \text{ mAdc}$, $V_{CE} = 1.0 \text{ Vdc}$) ($I_C = 10 \text{ mAdc}$, $V_{CE} = 1.0 \text{ Vdc}$)	h_{FE}	30 50 75	90 160 200	— — —	—
Collector–Emitter Saturation Voltage ($I_C = 10 \text{ mAdc}$, $I_B = 1.0 \text{ mAdc}$)	$V_{CE(sat)}$	—	0.1	0.2	Vdc
Base–Emitter Saturation Voltage ($I_C = 10 \text{ mAdc}$, $I_B = 1.0 \text{ mAdc}$)	$V_{BE(sat)}$	—	0.65	0.85	Vdc

SMALL–SIGNAL CHARACTERISTICS

Current–Gain — Bandwidth Product ($I_C = 10 \text{ mAdc}$, $V_{CE} = 20 \text{ Vdc}$, $f = 100 \text{ MHz}$)	f_T	250	300	—	MHz
Output Capacitance ($V_{CB} = 5.0 \text{ Vdc}$, $I_E = 0$, $f = 1.0 \text{ MHz}$)	C_{obo}	—	2.0	4.0	pF
Input Capacitance ($V_{EB} = 0.5 \text{ Vdc}$, $I_C = 0$, $f = 1.0 \text{ MHz}$)	C_{ibo}	—	4.0	8.0	pF

SWITCHING CHARACTERISTICS

Turn–On Time ($I_C = 10 \text{ mAdc}$, $V_{BE(off)} = -0.5 \text{ Vdc}$, $I_{B1} = 1.0 \text{ mAdc}$)	t_{on}	—	37	—	ns
Turn–Off Time ($I_C = 10 \text{ mAdc}$, $I_{B1} = I_{B2} = 1.0 \text{ mAdc}$)	t_{off}	—	136	—	ns

1. Pulse Test: Pulse Width $\leq 300 \mu\text{s}$; Duty Cycle $\leq 2.0\%$.

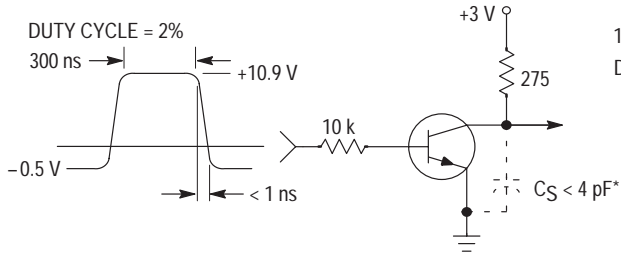


Figure 1. Delay and Rise Time Equivalent Test Circuit

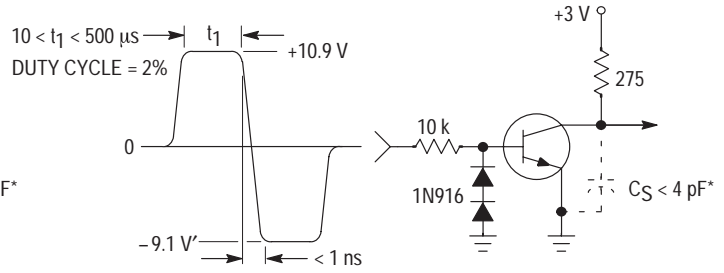


Figure 2. Storage and Fall Time Equivalent Test Circuit

* Total shunt capacitance of test jig and connectors

TYPICAL TRANSIENT CHARACTERISTICS

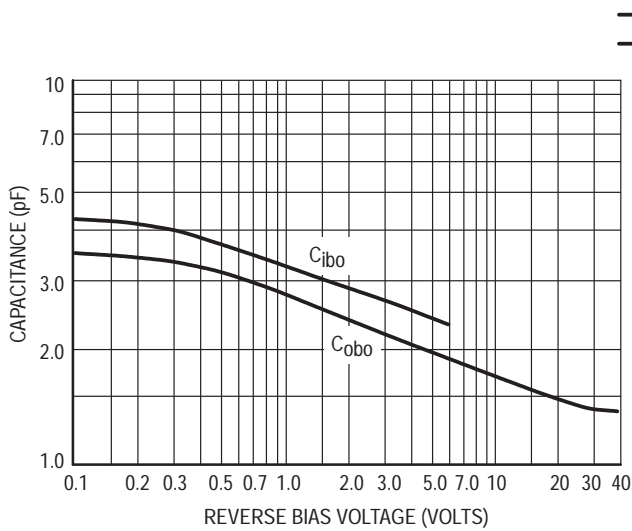


Figure 3. Capacitance

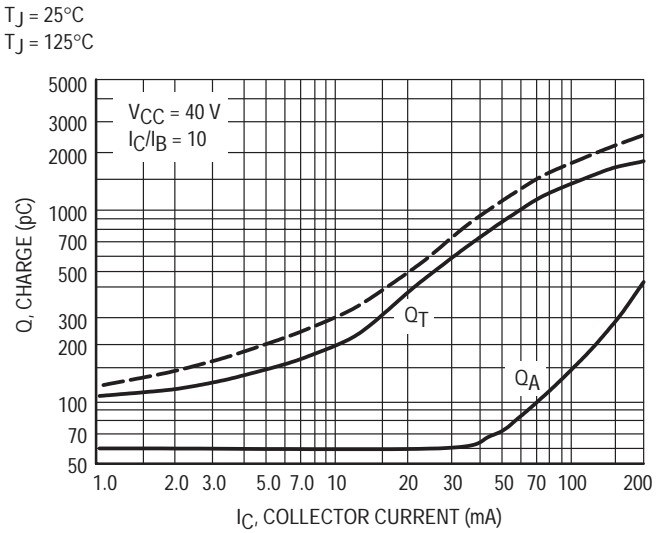


Figure 4. Charge Data

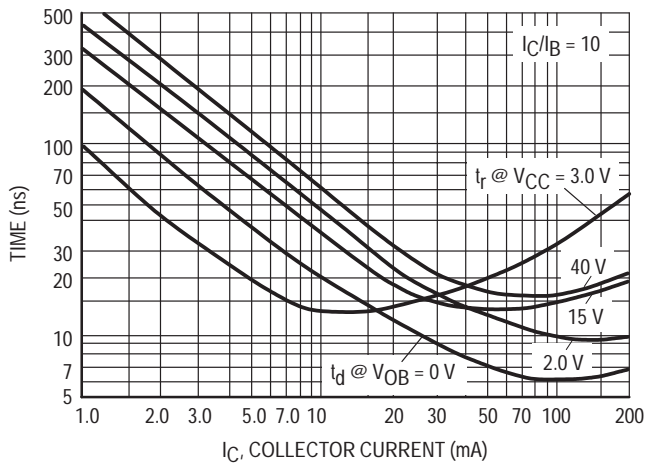


Figure 5. Turn-On Time

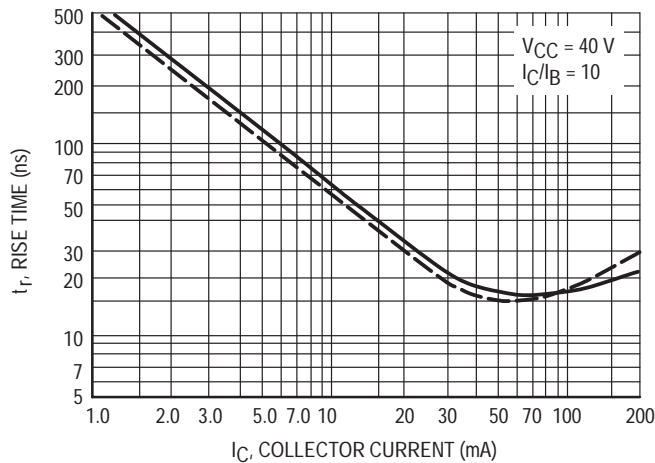


Figure 6. Rise Time

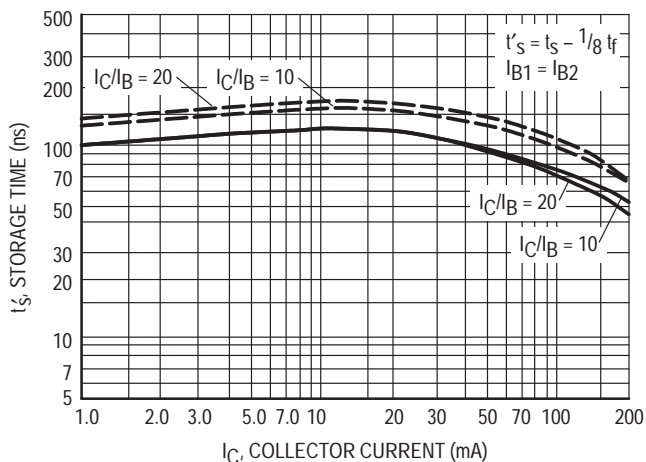


Figure 7. Storage Time

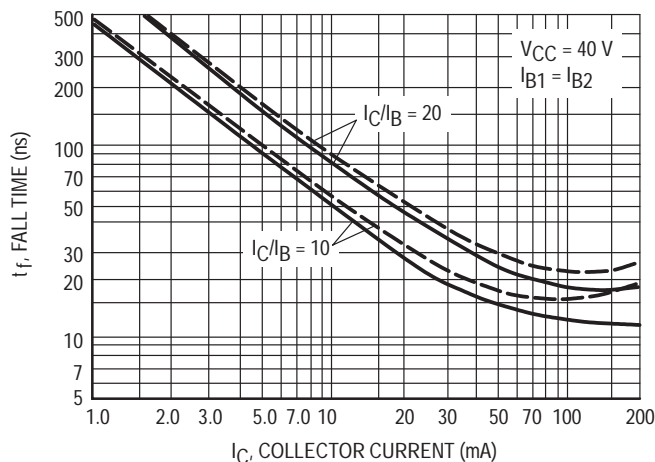


Figure 8. Fall Time

TYPICAL AUDIO SMALL-SIGNAL CHARACTERISTICS
NOISE FIGURE VARIATIONS

(V_{CE} = 5.0 Vdc, T_A = 25°C, Bandwidth = 1.0 Hz)

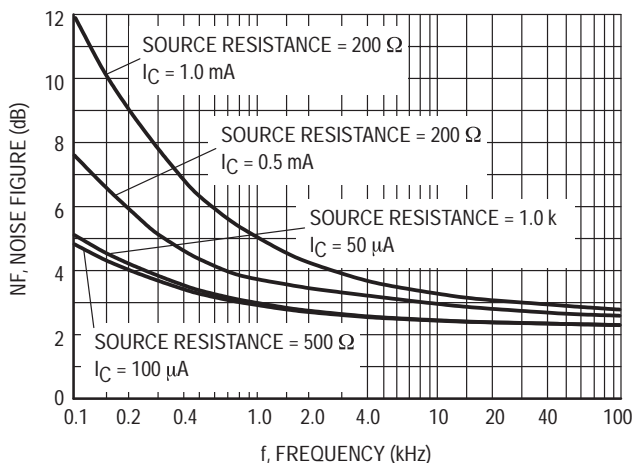


Figure 9.

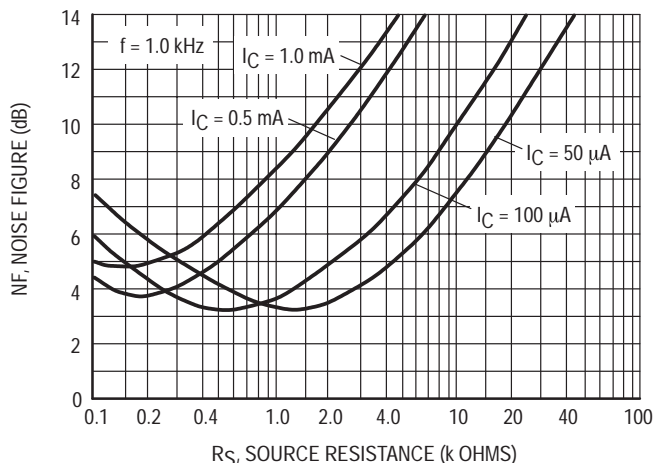


Figure 10.

h PARAMETERS

($V_{CE} = 10 \text{ Vdc}$, $f = 1.0 \text{ kHz}$, $T_A = 25^\circ\text{C}$)

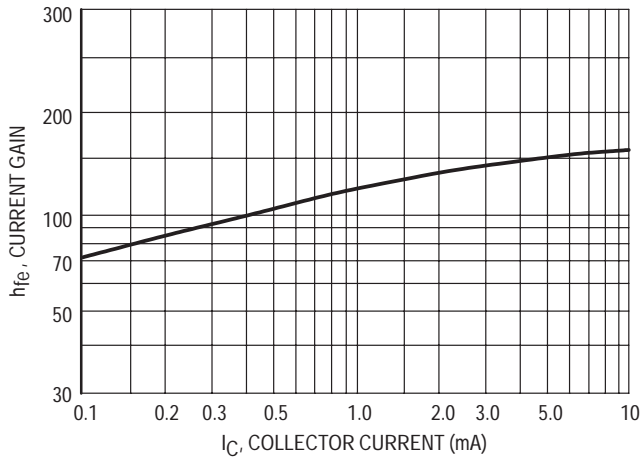


Figure 11. Current Gain

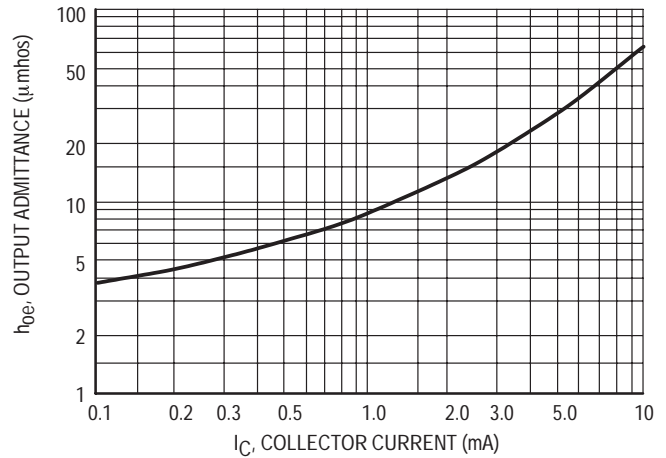


Figure 12. Output Admittance

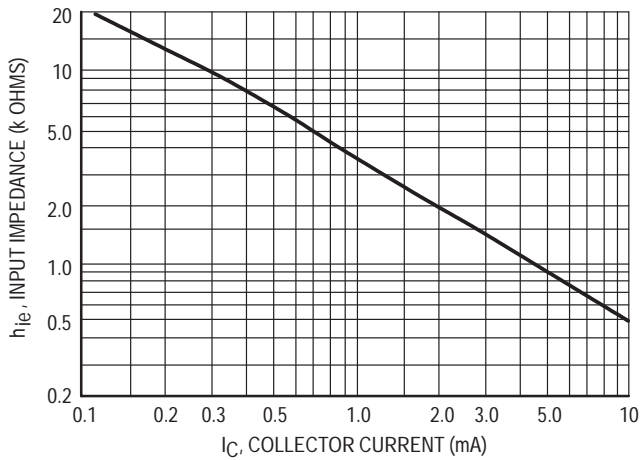


Figure 13. Input Impedance

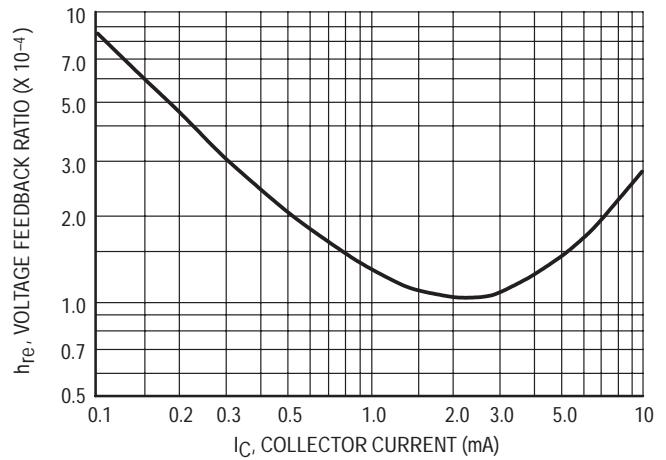


Figure 14. Voltage Feedback Ratio

TYPICAL STATIC CHARACTERISTICS

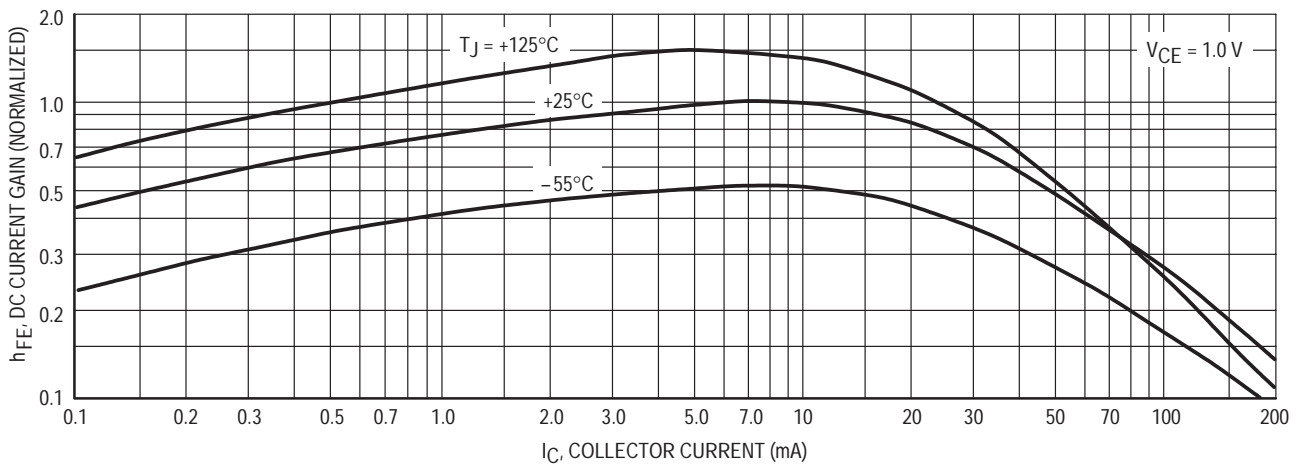


Figure 15. DC Current Gain

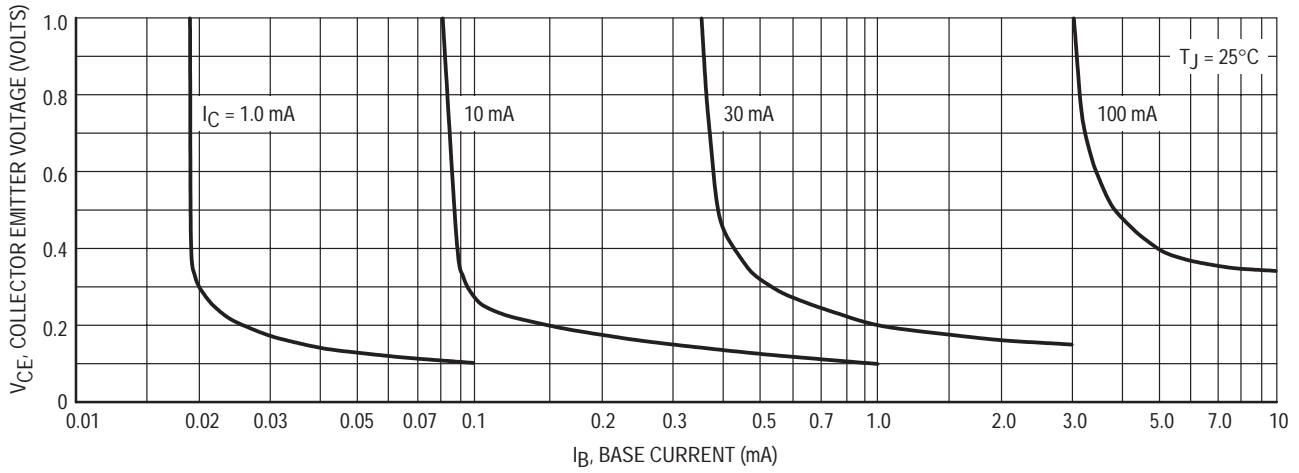


Figure 16. Collector Saturation Region

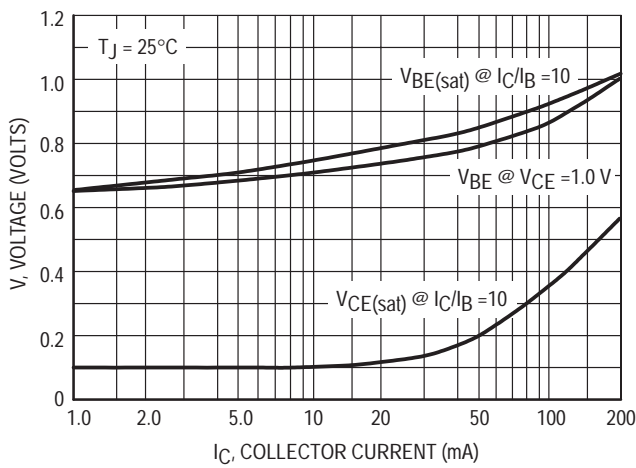


Figure 17. "ON" Voltages

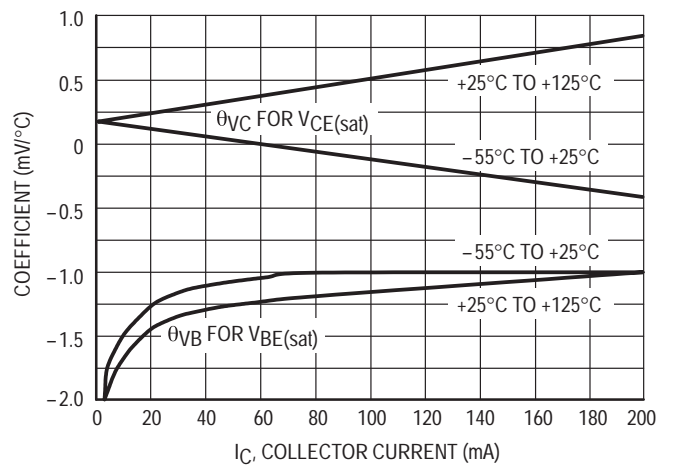
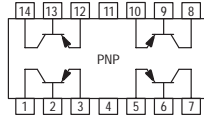


Figure 18. Temperature Coefficients

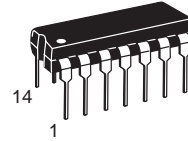
Quad Amplifier Switching Transistor

PNP Silicon



MPQ3906

Motorola Preferred Device



CASE 646-06, STYLE 1
TO-116

MAXIMUM RATINGS

Rating	Symbol	Value	Unit
Collector-Emitter Voltage	V_{CEO}	-40	Vdc
Collector-Base Voltage	V_{CBO}	-40	Vdc
Emitter-Base Voltage	V_{EBO}	-5.0	Vdc
Collector Current — Continuous	I_C	-200	mAdc
		Each Transistor	Four Transistors Equal Power
Total Device Dissipation @ $T_A = 25^\circ\text{C}$ Derate above 25°C	P_D	500 4.0	mW mW/°C
Total Device Dissipation @ $T_C = 25^\circ\text{C}$ Derate above 25°C	P_D	825 6.7	Watts mW/°C
Operating and Storage Junction Temperature Range	T_J, T_{stg}	-55 to +150	°C

THERMAL CHARACTERISTICS

Characteristic		Junction to Case	Junction to Ambient	Unit
Thermal Resistance	Each Die	151	250	°C/W
	Effective, 4 Die	52	139	°C/W
Coupling Factors	Q1-Q4 or Q2-Q3	34	70	%
	Q1-Q2 or Q3-Q4	2.0	26	%

ELECTRICAL CHARACTERISTICS ($T_A = 25^\circ\text{C}$ unless otherwise noted)

Characteristic	Symbol	Min	Typ	Max	Unit
----------------	--------	-----	-----	-----	------

OFF CHARACTERISTICS

Collector-Emitter Breakdown Voltage ⁽¹⁾ ($I_C = -1.0$ mAdc, $I_E = 0$)	$V_{(BR)CEO}$	-40	—	—	Vdc
Collector-Base Breakdown Voltage ($I_C = -10$ μ Adc, $I_E = 0$)	$V_{(BR)CBO}$	-40	—	—	Vdc
Emitter-Base Breakdown Voltage ($I_E = -10$ μ Adc, $I_C = 0$)	$V_{(BR)EBO}$	-5.0	—	—	Vdc
Collector Cutoff Current ($V_{CB} = -30$ Vdc, $I_E = 0$)	I_{CBO}	—	—	-50	nAdc
Emitter Cutoff Current ($V_{EB} = -4.0$ Vdc, $I_C = 0$)	I_{EBO}	—	—	-50	nAdc

1. Pulse Test: Pulse Width ≤ 300 μ s; Duty Cycle $\leq 2.0\%$.

Preferred devices are Motorola recommended choices for future use and best overall value.

ELECTRICAL CHARACTERISTICS ($T_A = 25^\circ\text{C}$ unless otherwise noted) (Continued)

Characteristic	Symbol	Min	Typ	Max	Unit
ON CHARACTERISTICS(1)					
DC Current Gain ($I_C = -0.1\text{ mAdc}$, $V_{CE} = -1.0\text{ Vdc}$) ($I_C = -1.0\text{ mAdc}$, $V_{CE} = -1.0\text{ Vdc}$) ($I_C = -10\text{ mAdc}$, $V_{CE} = -1.0\text{ Vdc}$)	h_{FE}	40 60 75	160 180 200	— — —	—
Collector–Emitter Saturation Voltage ($I_C = -10\text{ mAdc}$, $I_B = -1.0\text{ mAdc}$)	$V_{CE(sat)}$	—	-0.1	-0.25	Vdc
Base–Emitter Saturation Voltage ($I_C = -10\text{ mAdc}$, $I_B = -1.0\text{ mAdc}$)	$V_{BE(sat)}$	—	-0.65	-0.85	Vdc

SMALL-SIGNAL CHARACTERISTICS

Current–Gain — Bandwidth Product ($I_C = -10\text{ mAdc}$, $V_{CE} = -20\text{ Vdc}$, $f = 100\text{ MHz}$)	f_T	200	250	—	MHz
Output Capacitance ($V_{CB} = -5.0\text{ Vdc}$, $I_E = 0$, $f = 1.0\text{ MHz}$)	C_{obo}	—	3.3	4.5	pF
Input Capacitance ($V_{EB} = -0.5\text{ Vdc}$, $I_C = 0$, $f = 1.0\text{ MHz}$)	C_{ibo}	—	4.8	10	pF

SWITCHING CHARACTERISTICS

Turn–On Time ($I_C = -10\text{ mAdc}$, $V_{BE(off)} = 0.5\text{ Vdc}$, $I_{B1} = -1.0\text{ mAdc}$)	t_{on}	—	43	—	ns
Turn–Off Time ($I_C = -10\text{ mAdc}$, $I_{B1} = I_{B2} = -1.0\text{ mAdc}$)	t_{off}	—	155	—	ns

1. Pulse Test: Pulse Width $\leq 300\ \mu\text{s}$; Duty Cycle $\leq 2.0\%$.

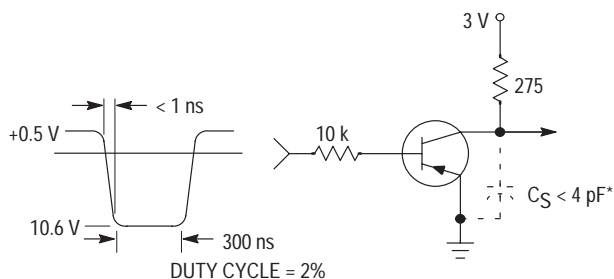


Figure 1. Delay and Rise Time
Equivalent Test Circuit

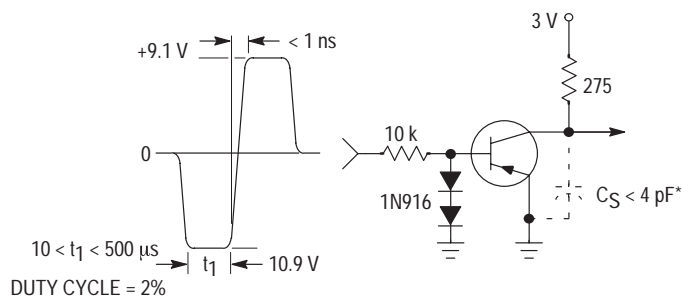


Figure 2. Storage and Fall Time
Equivalent Test Circuit

* Total shunt capacitance of test jig and connectors

TYPICAL TRANSIENT CHARACTERISTICS

— $T_J = 25^\circ\text{C}$
 - - - $T_J = 125^\circ\text{C}$

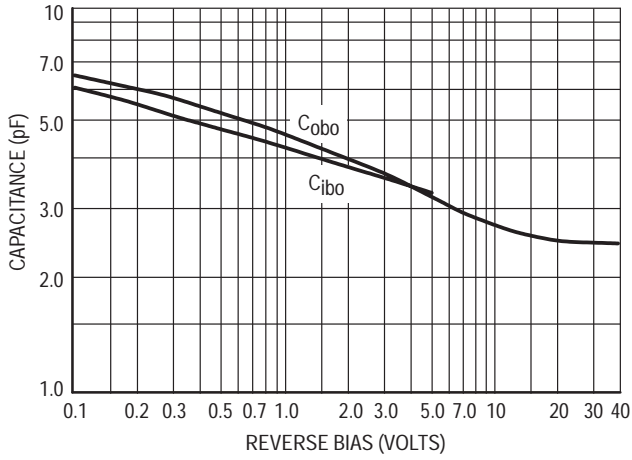


Figure 3. Capacitance

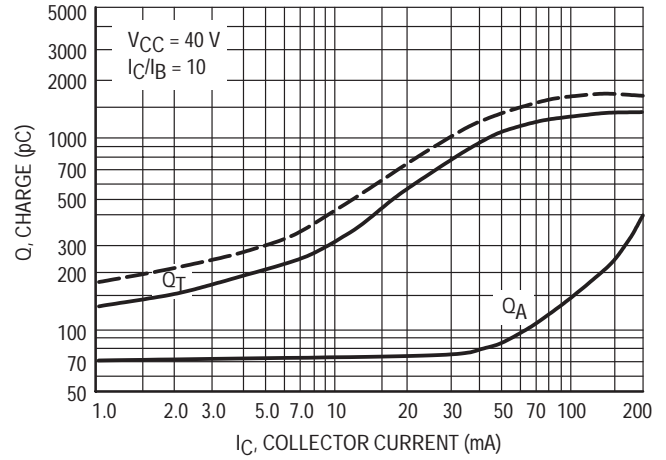


Figure 4. Charge Data

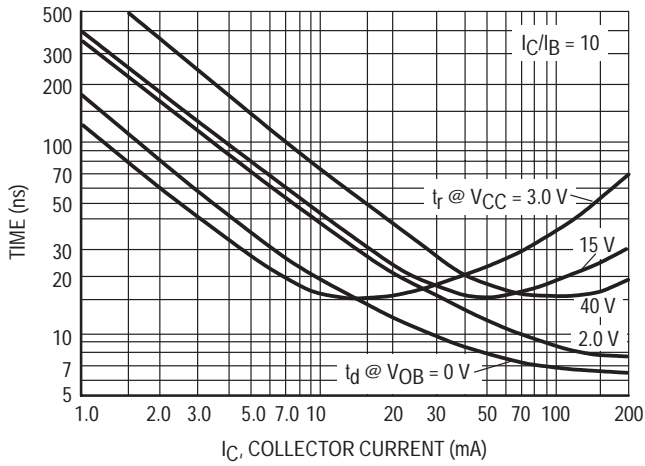


Figure 5. Turn-On Time

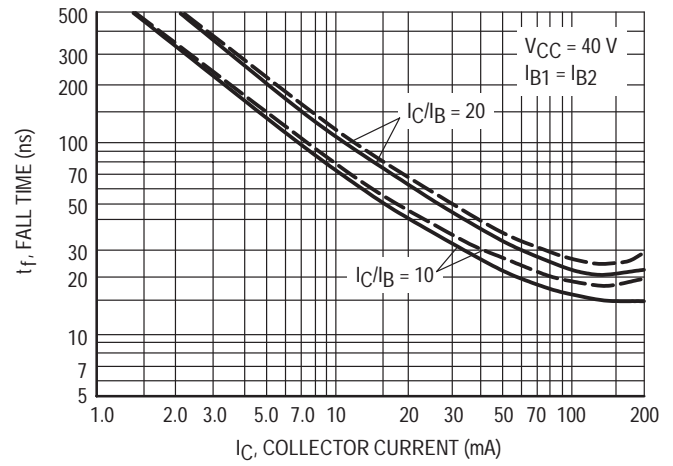


Figure 6. Fall Time

**TYPICAL AUDIO SMALL-SIGNAL CHARACTERISTICS
NOISE FIGURE VARIATIONS**

($V_{CE} = -5.0$ Vdc, $T_A = 25^\circ\text{C}$, Bandwidth = 1.0 Hz)

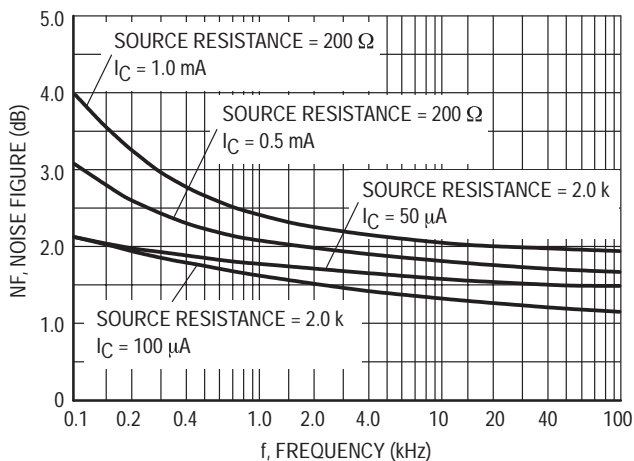


Figure 7.

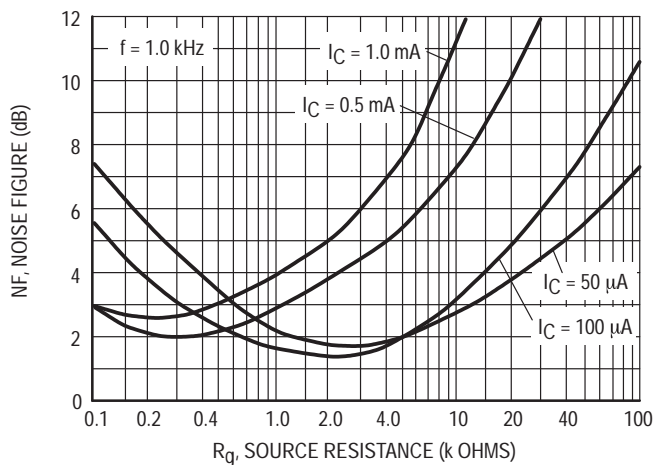


Figure 8.

h PARAMETERS

($V_{CE} = -10$ Vdc, $f = 1.0$ kHz, $T_A = 25^\circ\text{C}$)

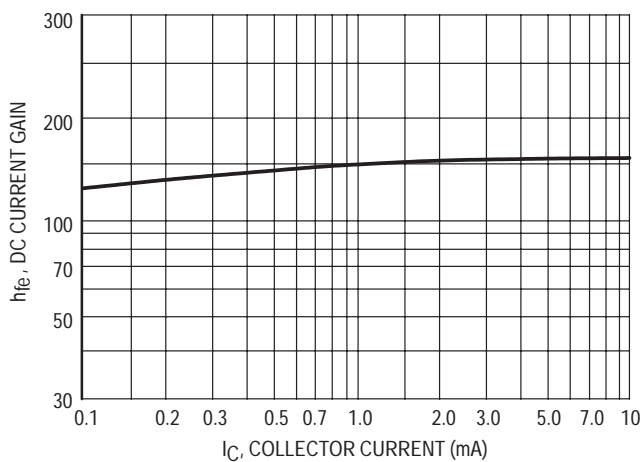


Figure 9. Current Gain

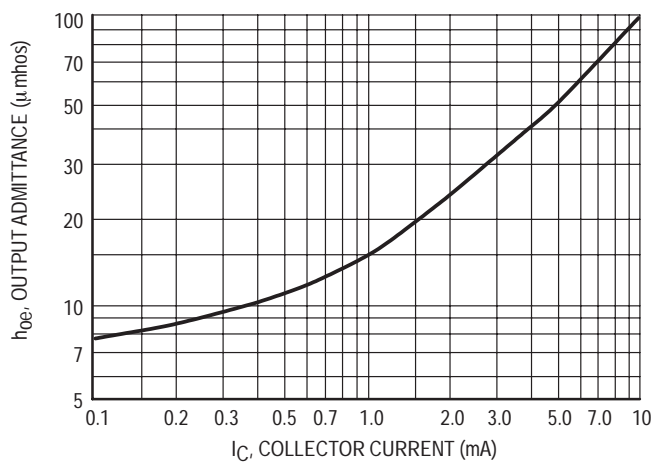


Figure 10. Output Admittance

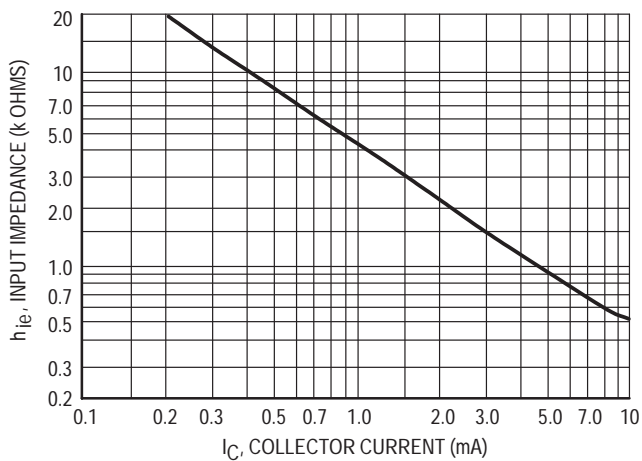


Figure 11. Input Impedance

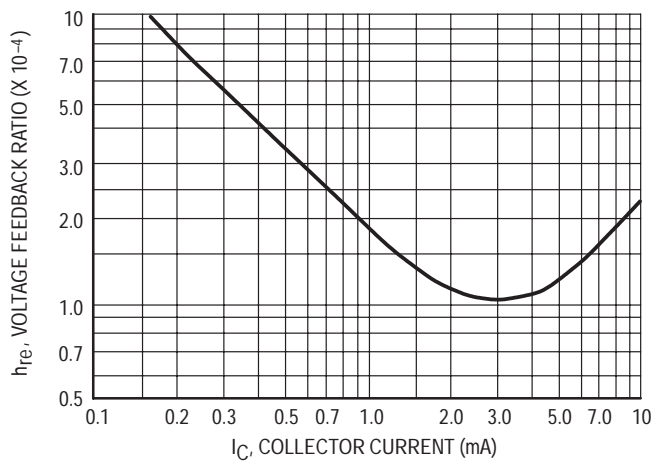


Figure 12. Voltage Feedback Ratio

TYPICAL STATIC CHARACTERISTICS

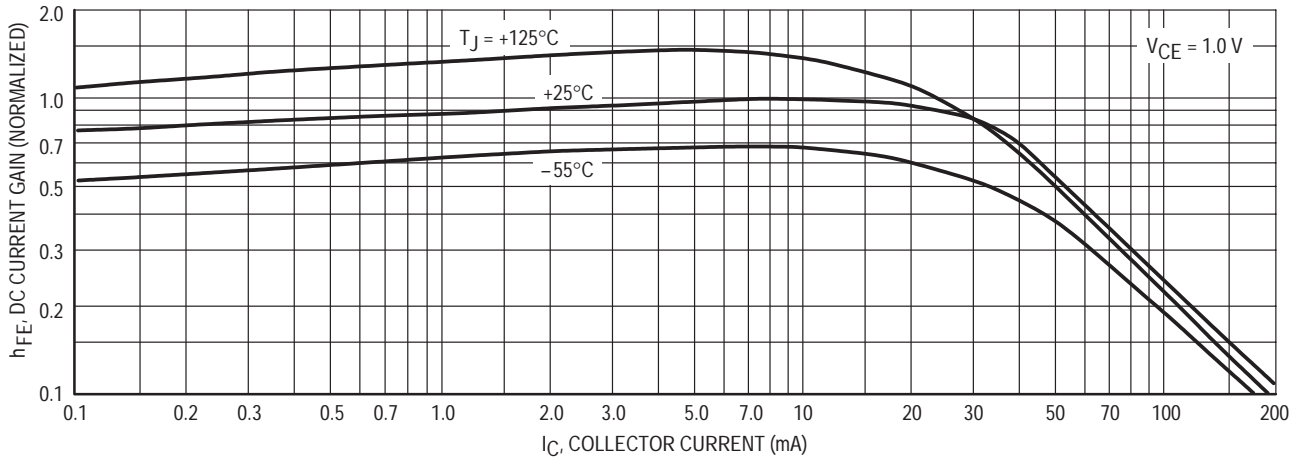


Figure 13. DC Current Gain

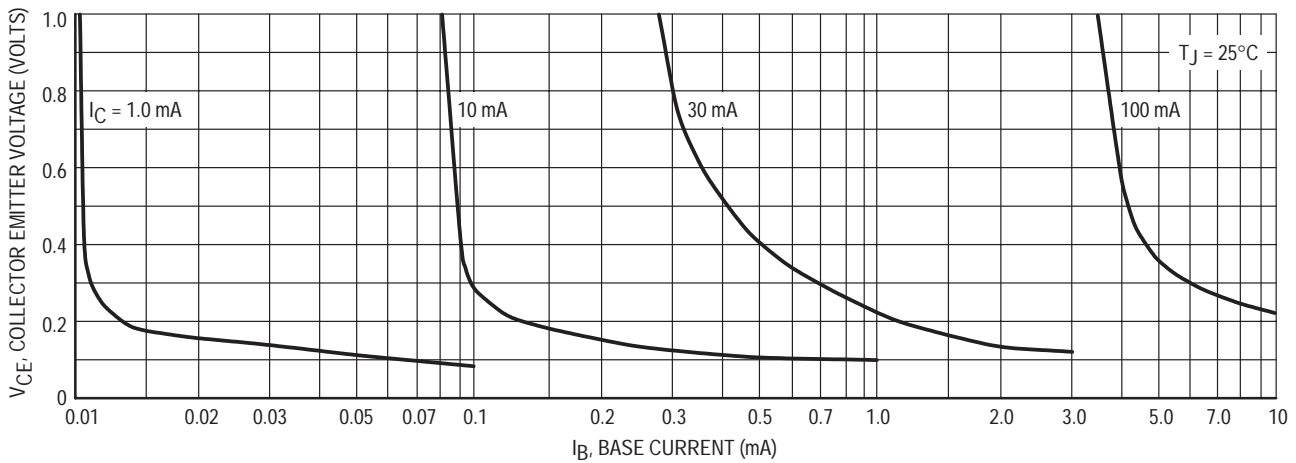


Figure 14. Collector Saturation Region

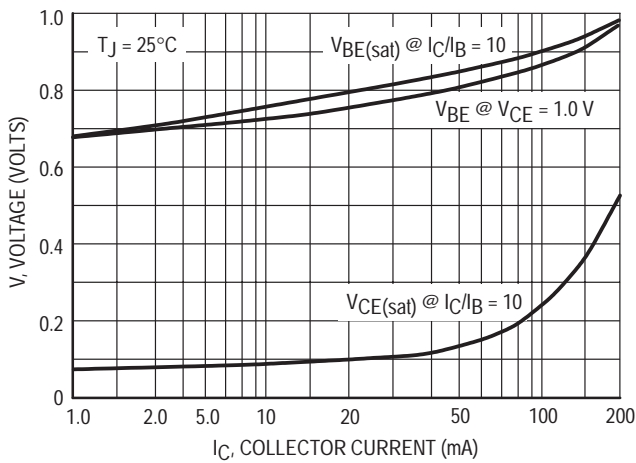


Figure 15. "ON" Voltages

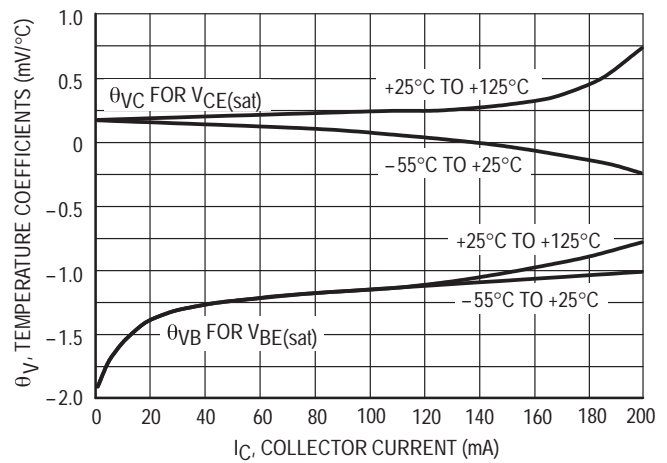
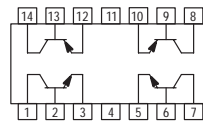


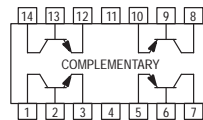
Figure 16. Temperature Coefficients

Quad Complementary Pair Transistors

NPN/PNP Silicon



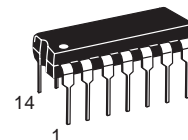
MPQ6001, MPQ6002
TYPE A



MPQ6502
TYPE B

MPQ6001
MPQ6002
MPQ6502

Voltage and current are negative for PNP transistors



CASE 646-06, STYLE 1
TO-116

MAXIMUM RATINGS

Rating	Symbol	Value		Unit
Collector-Emitter Voltage	V_{CEO}	30		Vdc
Collector-Base Voltage	V_{CBO}	60		Vdc
Emitter-Base Voltage	V_{EBO}	5.0		Vdc
Collector Current — Continuous	I_C	500		mAdc
		Each Transistor	Four Transistors Equal Power	
Total Device Dissipation @ $T_A = 25^\circ\text{C}$ (1) MPQ6001, MPQ6002, MPQ6502 Derate above 25°C	P_D	0.65	1.25	Watts
		5.18	10	mW/ $^\circ\text{C}$
Total Device Dissipation @ $T_C = 25^\circ\text{C}$ MPQ6001, MPQ6002, MPQ6502 Derate above 25°C	P_D	1.0	3.0	Watts
		8.0	24	mW/ $^\circ\text{C}$
Operating and Storage Junction Temperature Range	T_J, T_{stg}	-55 to +150		$^\circ\text{C}$

THERMAL CHARACTERISTICS

Characteristic		Junction to Case	Junction to Ambient	Unit
Thermal Resistance	Each Die	125	193	$^\circ\text{C}/\text{W}$
	Effective, 4 Die	41.6	100	
Coupling Factors	Q1-Q4 or Q2-Q3	30	60	%
	Q1-Q2 or Q3-Q4	20	24	

1. Voltage and Current are negative for PNP devices.

MPQ6001 MPQ6002 MPQ6502

ELECTRICAL CHARACTERISTICS (T_A = 25°C unless otherwise noted)

Characteristic	Symbol	Min	Typ	Max	Unit
OFF CHARACTERISTICS					
Collector–Emitter Breakdown Voltage ⁽²⁾ (I _C = 10 mA _{dc} , I _B = 0)	V _{(BR)CEO}	30	—	—	V _{dc}
Collector–Base Breakdown Voltage (I _C = 10 μA _{dc} , I _E = 0)	V _{(BR)CBO}	60	—	—	V _{dc}
Emitter–Base Breakdown Voltage (I _E = 10 μA _{dc} , I _C = 0)	V _{(BR)EBO}	5.0	—	—	V _{dc}
Collector Cutoff Current (V _{CB} = 50 V _{dc} , I _E = 0)	I _{CBO}	—	—	30	nA _{dc}
Emitter Cutoff Current (V _{EB} = 3.0 V _{dc} , I _C = 0)	I _{EBO}	—	—	30	nA _{dc}

ON CHARACTERISTICS

DC Current Gain ⁽²⁾ (I _C = 1.0 mA _{dc} , V _{CE} = 10 V _{dc})	MPQ6001 MPQ6002, MPQ6502	h _{FE}	25	—	—	—	
			50	—	—	—	
			(I _C = 10 mA _{dc} , V _{CE} = 10 V _{dc})	35	—	—	—
				75	—	—	—
(I _C = 150 mA _{dc} , V _{CE} = 10 V _{dc})	MPQ6001 MPQ6002, MPQ6502	h _{FE}	40	—	—	—	
			100	—	—	—	
(I _C = 300 mA _{dc} , V _{CE} = 10 V _{dc})	MPQ6001 MPQ6002, MPQ6502	h _{FE}	20	—	—	—	
			30	—	—	—	
Collector–Emitter Saturation Voltage ⁽²⁾ (I _C = 150 mA _{dc} , I _B = 15 mA _{dc}) (I _C = 300 mA _{dc} , I _B = 30 mA _{dc})	V _{CE(sat)}	—	—	0.4	V _{dc}		
1.4							
Base–Emitter Saturation Voltage ⁽²⁾ (I _C = 150 mA _{dc} , I _B = 15 mA _{dc}) (I _C = 300 mA _{dc} , I _B = 30 mA _{dc})	V _{BE(sat)}	—	—	1.3	V _{dc}		
2.0							

SMALL–SIGNAL CHARACTERISTICS

Current–Gain — Bandwidth Product ⁽²⁾ (I _C = 50 mA _{dc} , V _{CE} = 20 V _{dc} , f = 100 MHz)	f _T	200	350	—	MHz
Output Capacitance (V _{CB} = 10 V _{dc} , I _E = 0, f = 1.0 MHz)	C _{obo}	—	6.0	8.0	pF
			4.5	8.0	
Input Capacitance (V _{EB} = 2.0 V _{dc} , I _C = 0, f = 1.0 MHz)	C _{ibo}	—	20	30	pF
			17	30	

SWITCHING CHARACTERISTICS

Turn–On Time (V _{CC} = 30 V _{dc} , V _{EB} = 0.5 V _{dc} , I _C = 150 mA _{dc} , I _{B1} = 15 mA _{dc} , Figure 1)	t _{on}	—	30	—	ns
Turn–Off Time (V _{CC} = 30 V _{dc} , I _C = 150 mA _{dc} , I _{B1} = I _{B2} = 15 mA _{dc})	t _{off}	—	225	—	ns

2. Pulse Test: Pulse Width ≤ 300 μs; Duty Cycle ≤ 2.0%.

NPN DATA

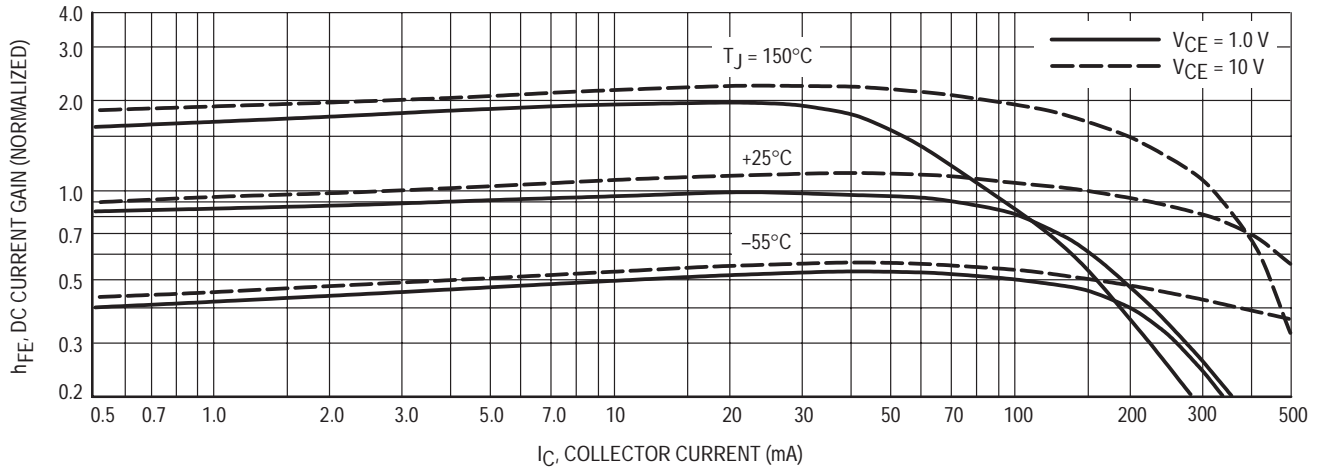


Figure 1. Normalized DC Current Gain

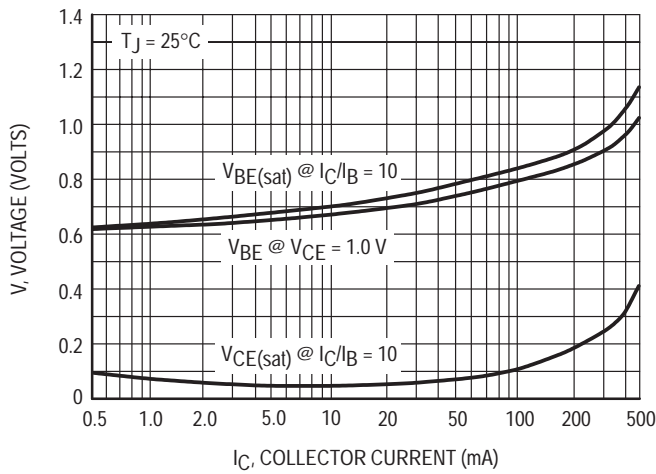


Figure 2. "ON" Voltages

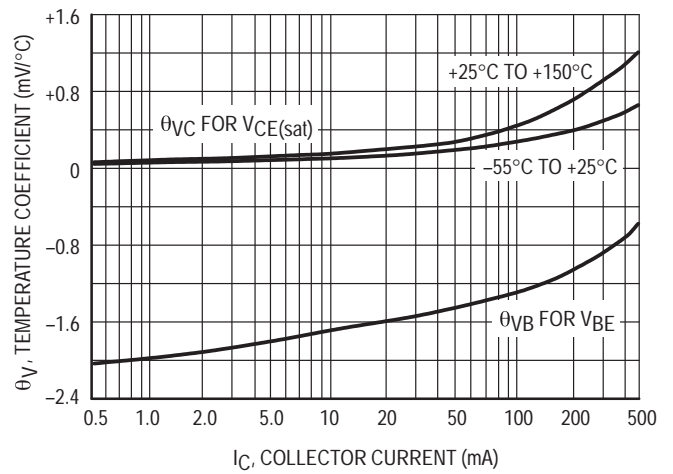


Figure 3. Temperature Coefficients

NOISE FIGURE
(VCE = 10 Vdc, TA = 25°C)

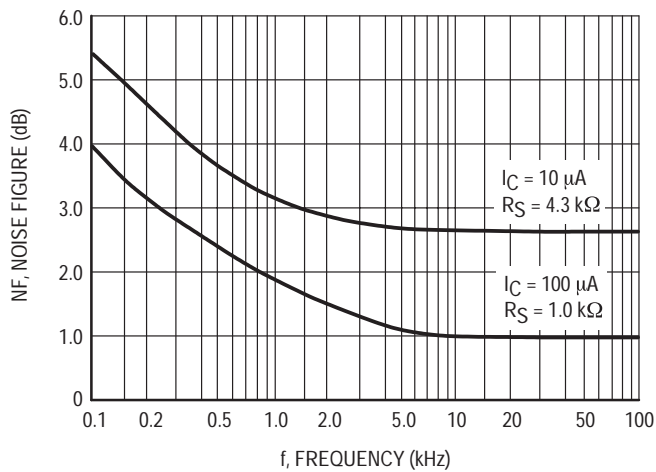


Figure 4. Frequency Effects

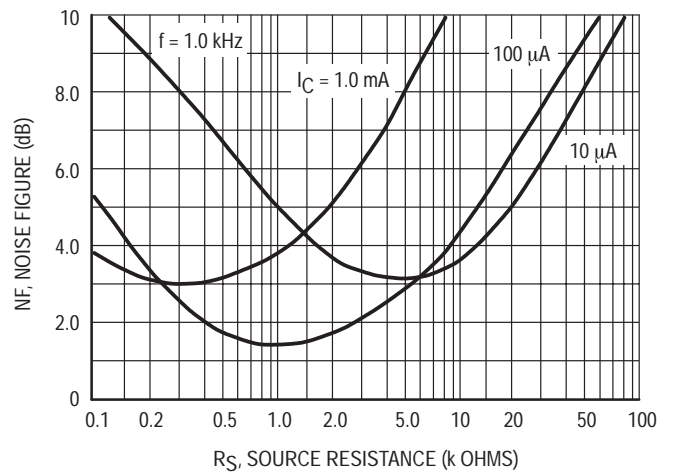
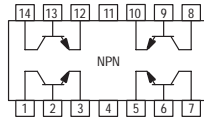


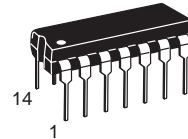
Figure 5. Source Resistance Effects

Quad Darlington Transistor

NPN Silicon



MPQ6426



**CASE 646-06, STYLE 1
TO-116**

MAXIMUM RATINGS

Rating	Symbol	Value	Unit
Collector–Emitter Voltage	V_{CEO}	30	Vdc
Collector–Base Voltage	V_{CBO}	40	Vdc
Emitter–Base Voltage	V_{EBO}	12	Vdc
Collector Current — Continuous	I_C	500	mAdc
		Each Die	Four Die Equal Power
Total Device Dissipation @ $T_A = 25^\circ\text{C}$ (1) Derate above 25°C	P_D	500 4.0	900 7.2 mW mW/°C
Total Device Dissipation @ $T_C = 25^\circ\text{C}$ Derate above 25°C	P_D	825 6.7	2400 19.2 mW mW/°C
Operating and Storage Junction Temperature Range	T_J, T_{stg}	-55 to +150	°C

THERMAL CHARACTERISTICS

Characteristic	Junction to Case	Junction to Ambient	Unit	
Thermal Resistance	Each Die	151	250	°C/W
	Effective, 4 Die	52	139	°C/W
Coupling Factors	Q1–Q4 or Q2–Q3	34	70	%
	Q1–Q2 or Q3–Q4	2.0	26	%

ELECTRICAL CHARACTERISTICS ($T_A = 25^\circ\text{C}$ unless otherwise noted)

Characteristic	Symbol	Min	Max	Unit
----------------	--------	-----	-----	------

OFF CHARACTERISTICS

Collector–Emitter Breakdown Voltage(2) ($I_C = 10 \text{ mAdc}, I_E = 0$)	$V_{(BR)CEO}$	30	—	Vdc
Collector–Base Breakdown Voltage ($I_C = 100 \mu\text{Adc}, I_E = 0$)	$V_{(BR)CBO}$	40	—	Vdc
Emitter–Base Breakdown Voltage ($I_E = 10 \mu\text{Adc}, I_C = 0$)	$V_{(BR)EBO}$	12	—	Vdc
Collector Cutoff Current ($V_{CB} = 30 \text{ Vdc}, I_E = 0$)	I_{CBO}	—	100	nAdc
Emitter Cutoff Current ($V_{EB} = 10 \text{ Vdc}, I_C = 0$)	I_{EBO}	—	100	nAdc

1. Second Breakdown occurs at power levels greater than 3 times the power dissipation rating.
2. Pulse Test: Pulse Width $\leq 300 \mu\text{s}$; Duty Cycle $\leq 2.0\%$.

ELECTRICAL CHARACTERISTICS ($T_A = 25^\circ\text{C}$ unless otherwise noted) (Continued)

Characteristic	Symbol	Min	Max	Unit
ON CHARACTERISTICS(2)				
DC Current Gain ($I_C = 10\text{ mAdc}$, $V_{CE} = 5.0\text{ Vdc}$) ($I_C = 100\text{ mAdc}$, $V_{CE} = 5.0\text{ Vdc}$)	h_{FE}	5000 10,000	— —	—
Collector–Emitter Saturation Voltage ($I_C = 100\text{ mAdc}$, $I_B = 0.1\text{ mAdc}$)	$V_{CE(sat)}$	—	1.5	Vdc
Base–Emitter On Voltage ($I_C = 100\text{ mAdc}$, $V_{CE} = 5.0\text{ Vdc}$)	$V_{BE(on)}$	—	2.0	Vdc

SMALL–SIGNAL CHARACTERISTICS

Current–Gain — Bandwidth Product ($I_C = 10\text{ mAdc}$, $V_{CE} = 5.0\text{ Vdc}$, $f = 100\text{ MHz}$)	f_T	125	—	MHz
Output Capacitance ($V_{CB} = 10\text{ Vdc}$, $I_E = 0$, $f = 1.0\text{ MHz}$)	C_{obo}	—	8.0	pF
Input Capacitance ($V_{EB} = 0.5\text{ Vdc}$, $I_C = 0$, $f = 1.0\text{ MHz}$)	C_{ibo}	—	15	pF

2. Pulse Test: Pulse Width $\leq 300\ \mu\text{s}$; Duty Cycle $\leq 2.0\%$.

NOISE CHARACTERISTICS

($V_{CE} = 5.0 \text{ Vdc}$, $T_A = 25^\circ\text{C}$)

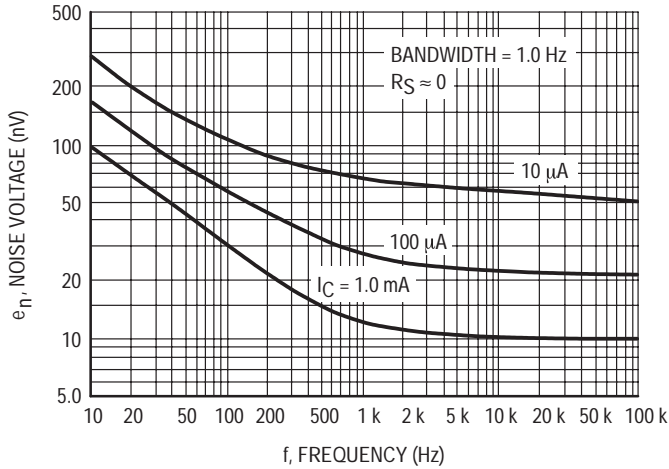


Figure 1. Noise Voltage

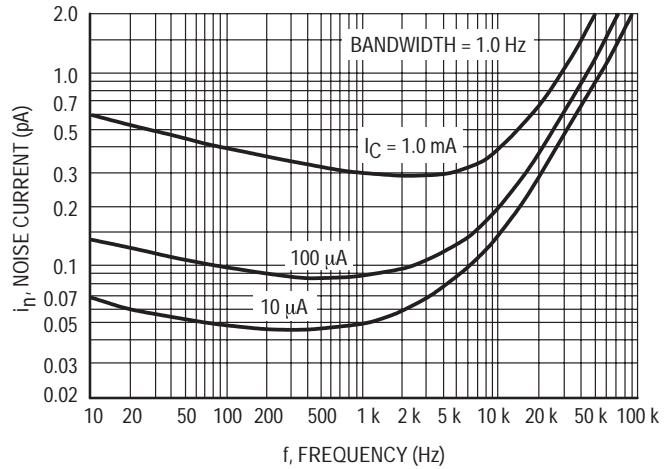


Figure 2. Noise Current

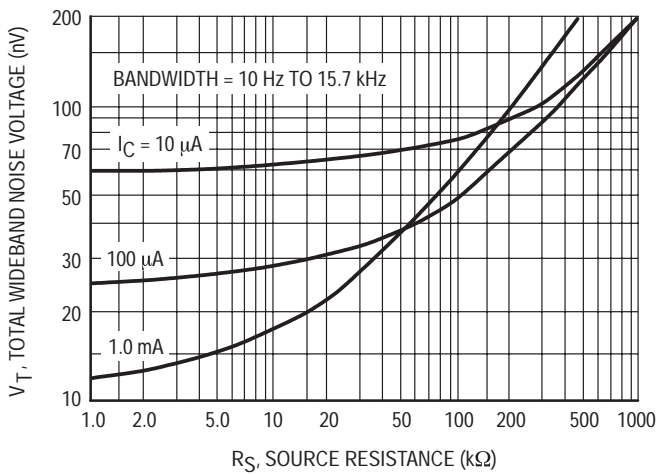


Figure 3. Total Wideband Noise Voltage

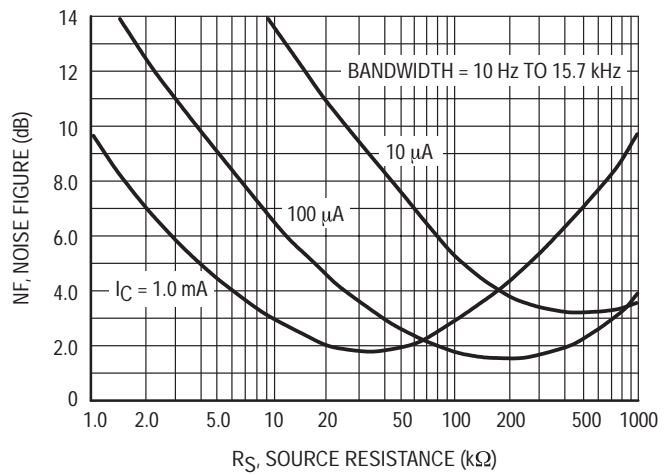


Figure 4. Wideband Noise Figure

DYNAMIC CHARACTERISTICS

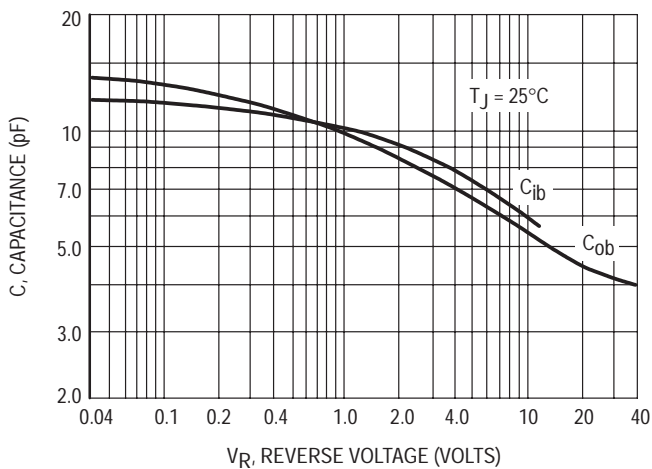


Figure 5. Capacitance

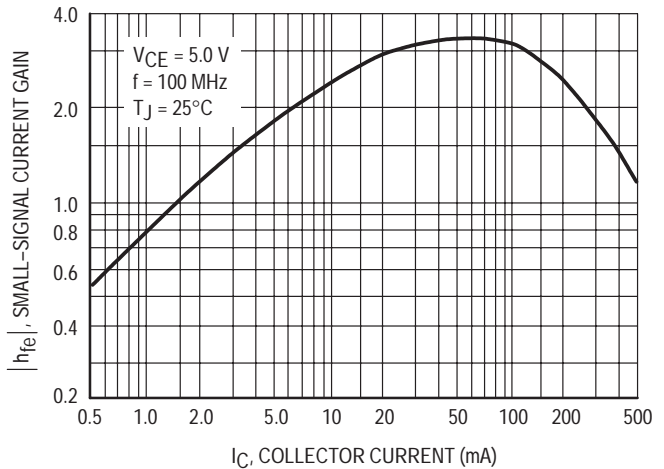
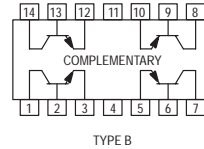


Figure 6. High Frequency Current Gain

Quad Complementary Pair Transistor

NPN/PNP Silicon



MPQ6700

MPQ6502

For Specifications,
See MPQ6001 Data

MPQ6600A1

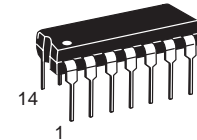
For Specifications,
See MPQ6100A Data

Voltage and current are negative for PNP transistors

Motorola Preferred Device

MAXIMUM RATINGS

Rating	Symbol	Value	Unit
Collector–Emitter Voltage	V_{CEO}	40	Vdc
Collector–Base Voltage	V_{CBO}	40	Vdc
Emitter–Base Voltage	V_{EBO}	5.0	Vdc
Collector Current — Continuous	I_C	200	mAdc
		Each Transistor	Four Transistors Equal Power
Total Device Dissipation @ $T_A = 25^\circ\text{C}$ ⁽¹⁾ Derate above 25°C	P_D	500 4.0	mW mW/ $^\circ\text{C}$
Total Device Dissipation @ $T_C = 25^\circ\text{C}$ Derate above 25°C	P_D	825 6.7	mW mW/ $^\circ\text{C}$
Operating and Storage Junction Temperature Range	T_J, T_{stg}	-55 to +150	$^\circ\text{C}$



CASE 646-06, STYLE 1
TO-116
TYPE B

THERMAL CHARACTERISTICS

Characteristic	Junction to Case	Junction to Ambient	Unit
Thermal Resistance	Each Die	151	$^\circ\text{C}/\text{W}$
	Effective, 4 Die	52	$^\circ\text{C}/\text{W}$
Coupling Factors	Q1–Q4 or Q2–Q3	34	%
	Q1–Q2 or Q3–Q4	2.0	%

ELECTRICAL CHARACTERISTICS ($T_A = 25^\circ\text{C}$ unless otherwise noted)

Characteristic	Symbol	Min	Max	Unit
----------------	--------	-----	-----	------

OFF CHARACTERISTICS

Collector–Emitter Breakdown Voltage ⁽²⁾ ($I_C = 10 \text{ mAdc}, I_B = 0$)	$V_{(BR)CEO}$	40	—	Vdc
Collector–Base Breakdown Voltage ($I_C = 10 \mu\text{Adc}, I_E = 0$)	$V_{(BR)CBO}$	40	—	Vdc
Emitter–Base Breakdown Voltage ($I_E = 10 \mu\text{Adc}, I_C = 0$)	$V_{(BR)EBO}$	5.0	—	Vdc
Collector Cutoff Current ($V_{CB} = 30 \text{ Vdc}, I_E = 0$)	I_{CBO}	—	50	nAdc
Emitter Cutoff Current ($V_{EB} = 4.0 \text{ Vdc}, I_C = 0$)	I_{EBO}	—	50	nAdc

- Second Breakdown occurs at power levels greater than 3 times the power dissipation rating.
- Pulse Test: Pulse Width $\leq 300 \mu\text{s}$; Duty Cycle $\leq 2.0\%$.

Preferred devices are Motorola recommended choices for future use and best overall value.

MPQ6700**ELECTRICAL CHARACTERISTICS** ($T_A = 25^\circ\text{C}$ unless otherwise noted) (Continued)

Characteristic	Symbol	Min	Max	Unit
ON CHARACTERISTICS(2)				
DC Current Gain ($I_C = 0.1 \text{ mAdc}$, $V_{CE} = 1.0 \text{ Vdc}$) ($I_C = 1.0 \text{ mAdc}$, $V_{CE} = 1.0 \text{ Vdc}$) ($I_C = 10 \text{ mAdc}$, $V_{CE} = 1.0 \text{ Vdc}$)	h_{FE}	30 50 70	— — —	—
Collector–Emitter Saturation Voltage ($I_C = 10 \text{ mAdc}$, $I_B = 1.0 \text{ mAdc}$)	$V_{CE(\text{sat})}$	—	0.25	Vdc
Base–Emitter Saturation Voltage ($I_C = 10 \text{ mAdc}$, $I_B = 1.0 \text{ mAdc}$)	$V_{BE(\text{sat})}$	—	0.9	Vdc

SMALL–SIGNAL CHARACTERISTICS

Current–Gain — Bandwidth Product ⁽²⁾ ($I_C = 10 \text{ mAdc}$, $V_{CE} = 20 \text{ Vdc}$, $f = 100 \text{ MHz}$)	f_T	200	—	MHz
Output Capacitance ($V_{CB} = 5.0 \text{ Vdc}$, $I_E = 0$, $f = 1.0 \text{ MHz}$)	C_{obo}	—	4.5	pF
Input Capacitance ($V_{EB} = 0.5 \text{ Vdc}$, $I_C = 0$, $f = 1.0 \text{ MHz}$)	C_{ibo}	— —	10 8.0	pF
		PNP NPN		

2. Pulse Test: Pulse Width $\leq 300 \mu\text{s}$; Duty Cycle $\leq 2.0\%$.

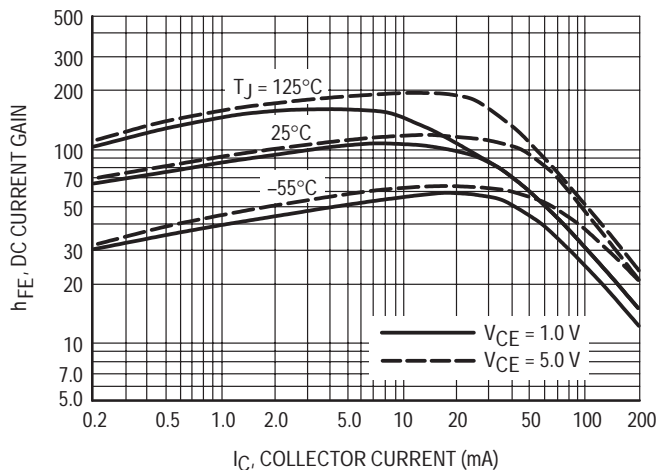


Figure 1. DC Current Gain

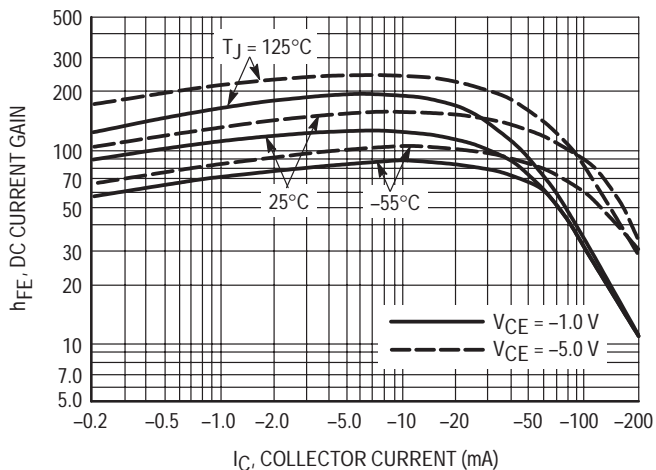


Figure 2. DC Current Gain

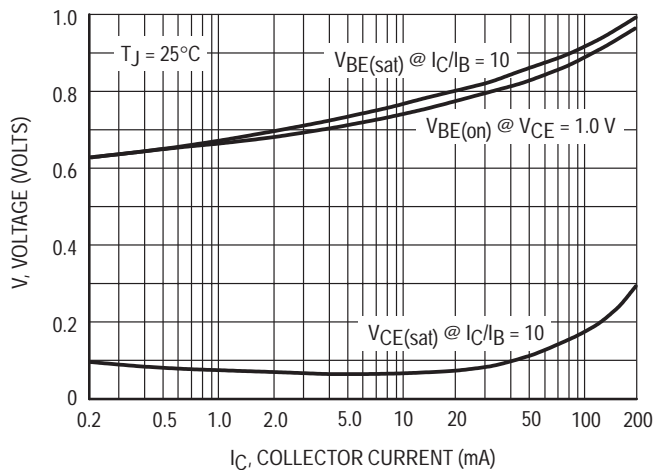


Figure 3. "ON" Voltage

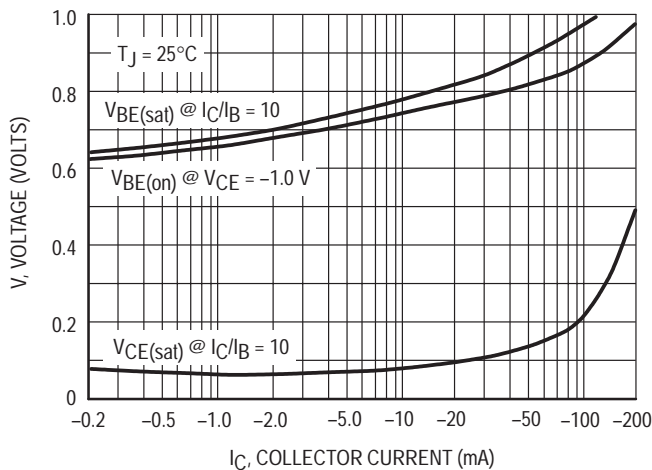


Figure 4. "ON" Voltage

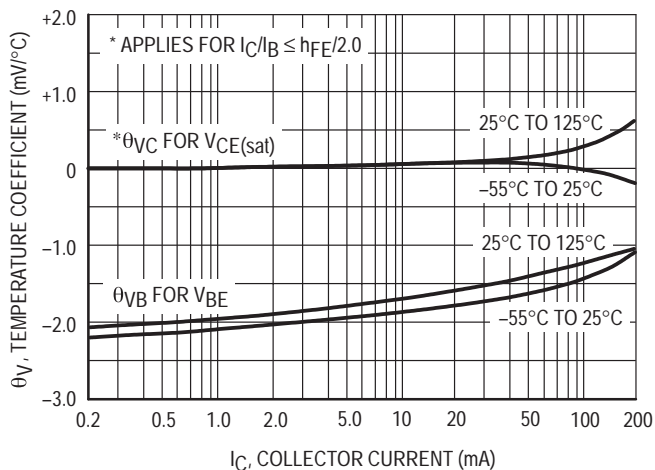


Figure 5. Temperature Coefficients

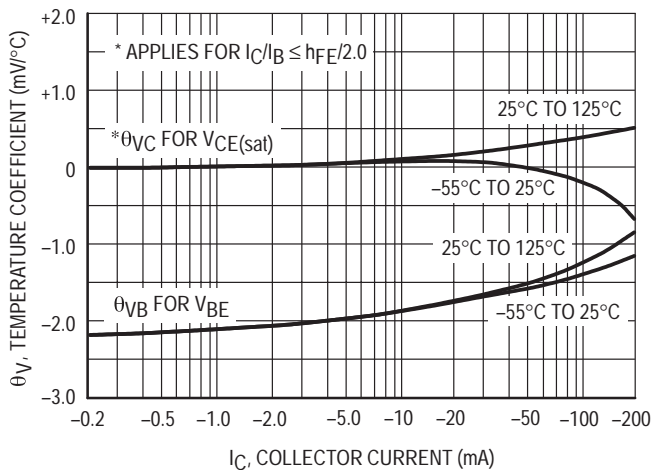


Figure 6. Temperature Coefficients

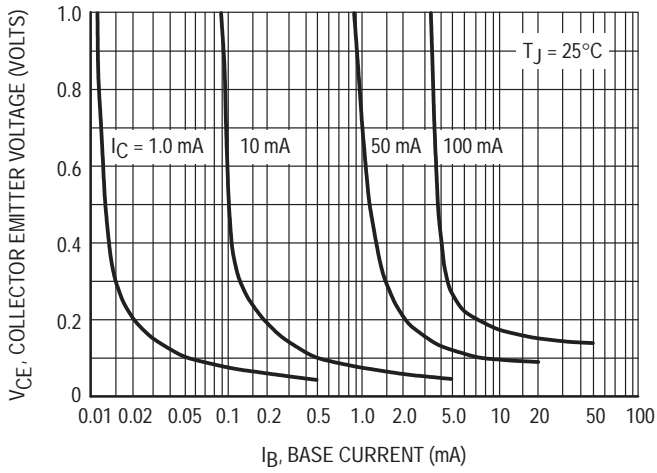


Figure 7. Collector Saturation Region

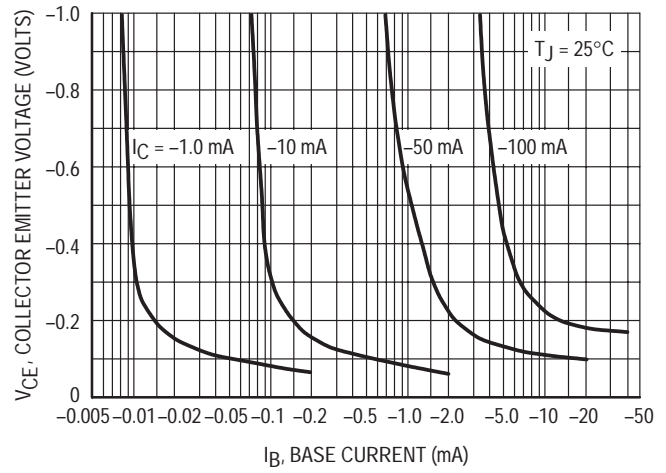


Figure 8. Collector Saturation Region

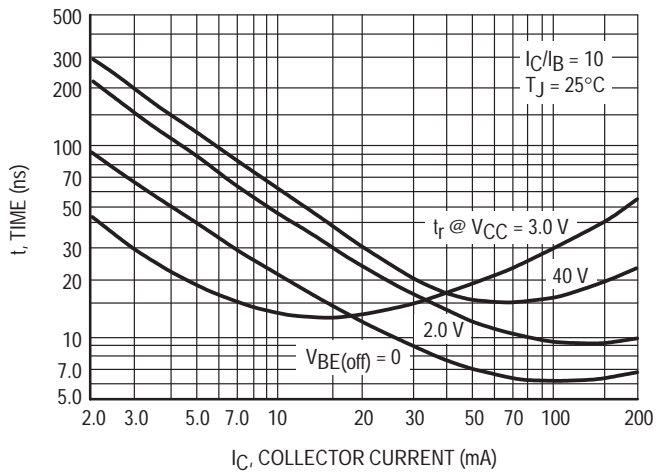


Figure 9. Turn-On Time

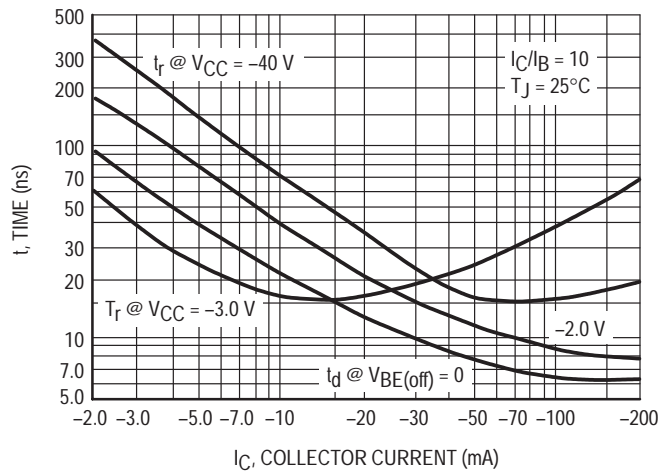


Figure 10. Turn-On Time

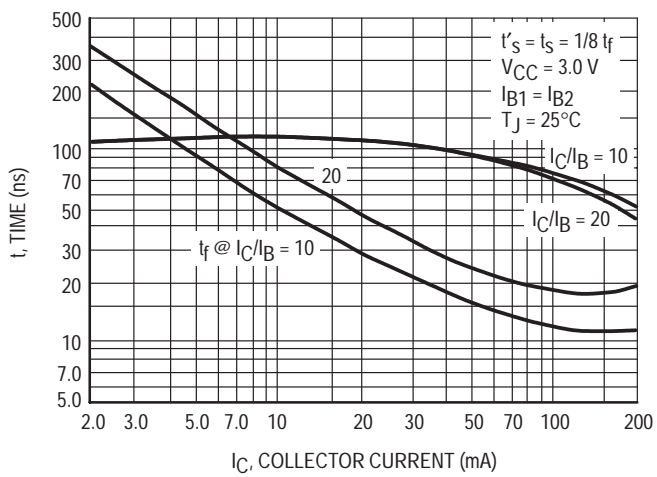


Figure 11. Turn-Off Time

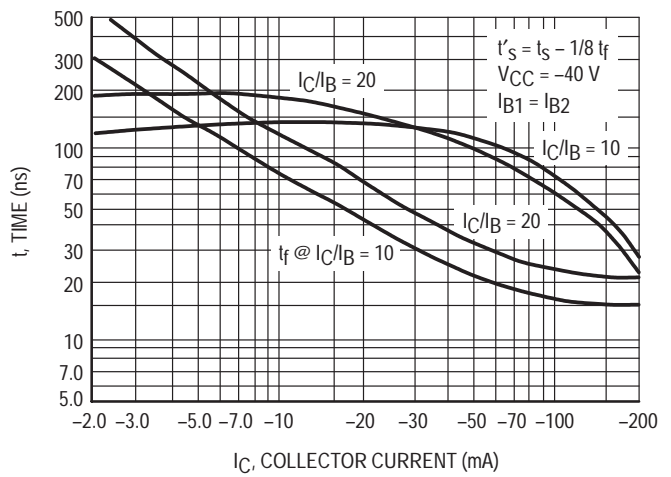


Figure 12. Turn-Off Time

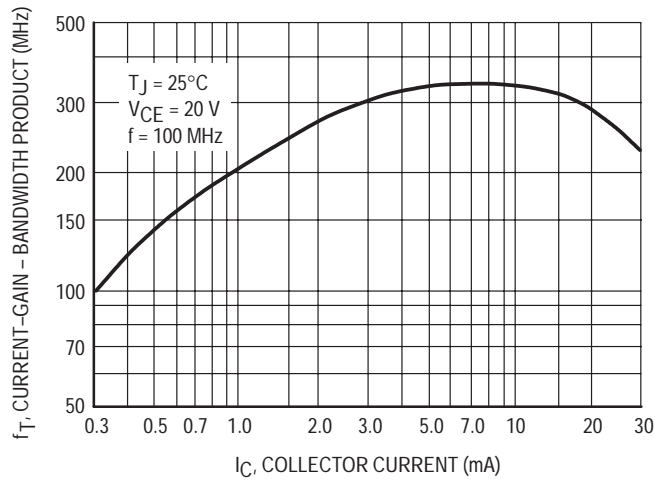


Figure 13. Current-Gain — Bandwidth Product

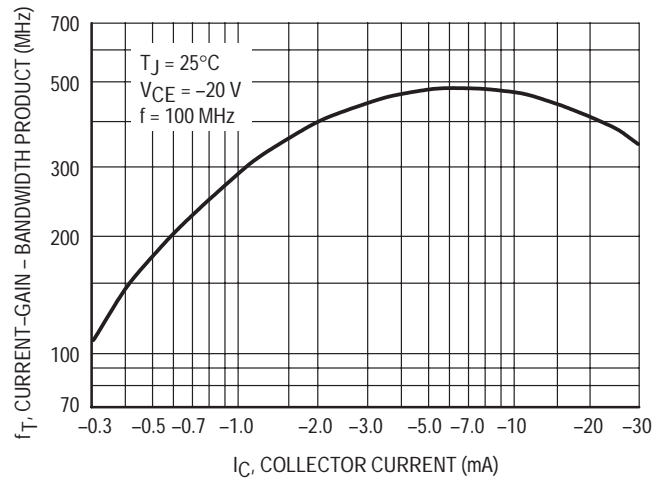


Figure 14. Current-Gain — Bandwidth Product

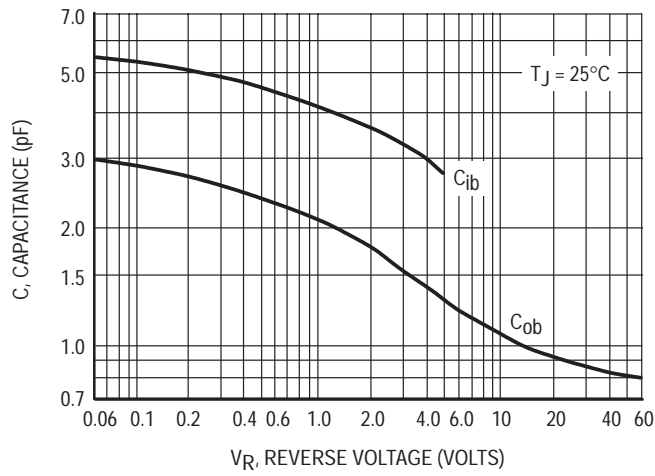


Figure 15. Capacitance

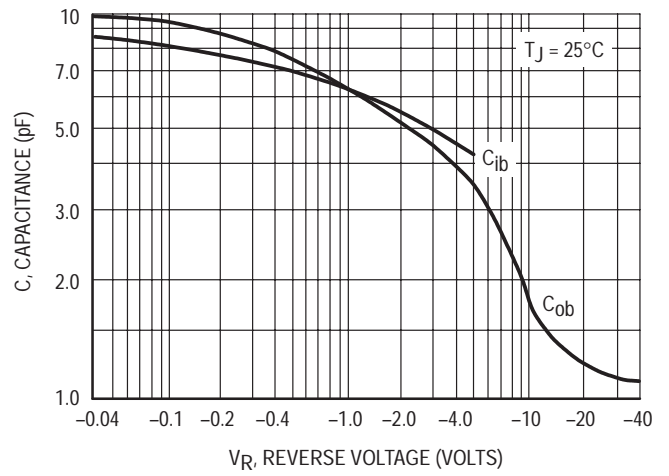
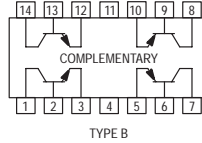


Figure 16. Capacitance

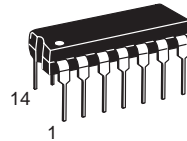
Quad Complementary Pair Transistor

NPN/PNP Silicon



MPQ6842

Voltage and current are negative for PNP transistors



CASE 646-06, STYLE 1
TO-116
TYPE B

MAXIMUM RATINGS

Rating	Symbol	Value	Unit
Collector–Emitter Voltage	V_{CEO}	30	Vdc
Collector–Base Voltage	V_{CBO}	30	Vdc
Emitter–Base Voltage	V_{EBO}	4.0	Vdc
Collector Current — Continuous	I_C	200	mAdc
		Each Transistor	Four Transistors Equal Power
Total Device Dissipation @ $T_A = 25^\circ\text{C}$ (1) Derate above 25°C	P_D	500 4.0	mW mW/°C
Total Device Dissipation @ $T_C = 25^\circ\text{C}$ Derate above 25°C	P_D	825 6.7	mW mW/°C
Operating and Storage Junction Temperature Range	T_J, T_{stg}	-55 to +150	°C

THERMAL CHARACTERISTICS

Characteristic	Junction to Case	Junction to Ambient	Unit
Thermal Resistance	Each Die	250	°C/W
	Effective, 4 Die	139	°C/W
Coupling Factors	Q1–Q4 or Q2–Q3	70	%
	Q1–Q2 or Q3–Q4	26	%

ELECTRICAL CHARACTERISTICS ($T_A = 25^\circ\text{C}$ unless otherwise noted)

Characteristic	Symbol	Min	Typ	Max	Unit
----------------	--------	-----	-----	-----	------

OFF CHARACTERISTICS

Collector–Emitter Breakdown Voltage(2) ($I_C = 10 \text{ mAdc}, I_B = 0$)	$V_{(BR)CEO}$	30	—	—	Vdc
Collector–Base Breakdown Voltage ($I_C = 10 \mu\text{Adc}, I_E = 0$)	$V_{(BR)CBO}$	30	—	—	Vdc
Emitter–Base Breakdown Voltage ($I_E = 10 \mu\text{Adc}, I_C = 0$)	$V_{(BR)EBO}$	4.0	—	—	Vdc
Collector Cutoff Current ($V_{CB} = 20 \text{ Vdc}, I_E = 0$)	I_{CBO}	—	—	50	nAdc
Emitter Cutoff Current ($V_{EB} = 3.0 \text{ Vdc}, I_E = 0$)	I_{EBO}	—	—	50	nAdc

1. Second Breakdown occurs at power levels greater than 3 times the power dissipation rating.
2. Pulse Test: Pulse Width $\leq 300 \mu\text{s}$; Duty Cycle $\leq 2.0\%$.

ELECTRICAL CHARACTERISTICS ($T_A = 25^\circ\text{C}$ unless otherwise noted) (Continued)

Characteristic	Symbol	Min	Typ	Max	Unit
ON CHARACTERISTICS(2)					
DC Current Gain ($I_C = 0.5 \text{ mAdc}$, $V_{CE} = 1.0 \text{ Vdc}$) ($I_C = 1.0 \text{ mAdc}$, $V_{CE} = 1.0 \text{ Vdc}$) ($I_C = 10 \text{ mAdc}$, $V_{CE} = 1.0 \text{ Vdc}$)	h_{FE}	30 50 70	— — —	— — —	—
Collector–Emitter Saturation Voltage ($I_C = 0.5 \text{ mAdc}$, $I_B = 0.05 \text{ mAdc}$, $0^\circ\text{C} \leq T \leq 70^\circ\text{C}$)	$V_{CE(sat)}$	—	0.05	0.15	Vdc
Base–Emitter Saturation Voltage ($I_C = 0.5 \text{ mAdc}$, $I_B = 0.05 \text{ mAdc}$)	$V_{BE(sat)}$	—	0.65	0.9	Vdc

SMALL–SIGNAL CHARACTERISTICS

Current–Gain — Bandwidth Product(2) ($I_C = 10 \text{ mAdc}$, $V_{CE} = 20 \text{ Vdc}$, $f = 100 \text{ MHz}$)	f_T	200	350	—	MHz
Output Capacitance ($V_{CB} = 5.0 \text{ Vdc}$, $I_E = 0$, $f = 1.0 \text{ MHz}$)	C_{obo}	—	3.0	4.5	pF
Input Capacitance ($V_{EB} = 0.5 \text{ Vdc}$, $I_C = 0$, $f = 1.0 \text{ MHz}$)	C_{ibo}	— —	5.0 4.0	10 8.0	pF
					PNP NPN

SWITCHING CHARACTERISTICS ($T_A = 25^\circ\text{C}$, $V_{CC} = 5.0 \text{ Vdc}$)

Propagation Delay Time (50% Points TP1 to TP3) (50% Points TP2 to TP4)	t_{PLH} t_{PHL}	— —	15 6.0	25 15	ns
Rise Time (0.3 V to 4.7 V, TP3 or TP4)	t_r	5.0	25	35	ns
Fall Time (4.7 V to 0.3 V, TP3 or TP4)	t_f	5.0	10	20	ns

2. Pulse Test: Pulse Width $\leq 300 \mu\text{s}$; Duty Cycle $\leq 2.0\%$.

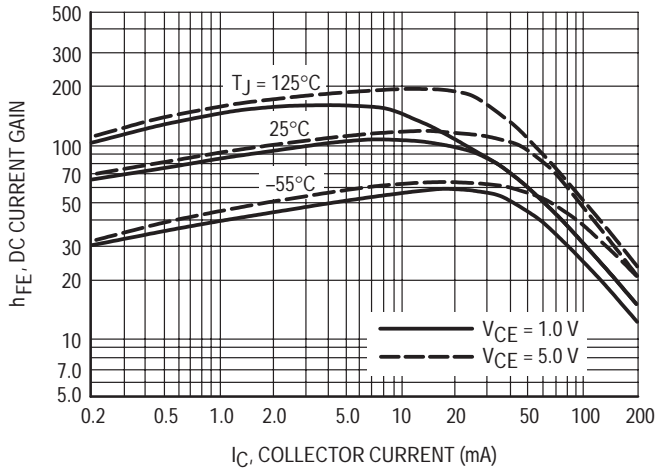


Figure 1. DC Current Gain

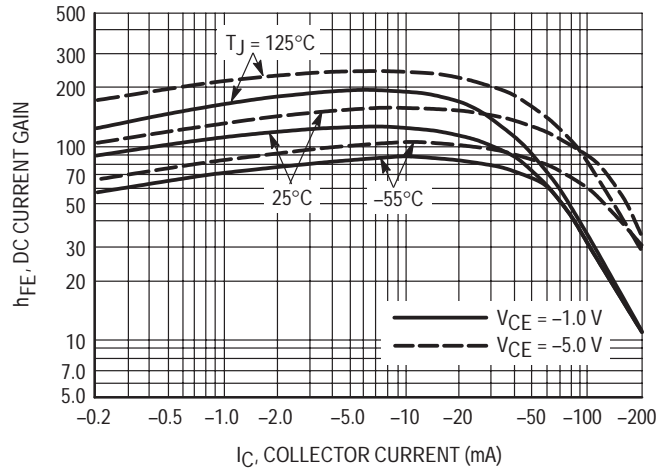


Figure 2. DC Current Gain

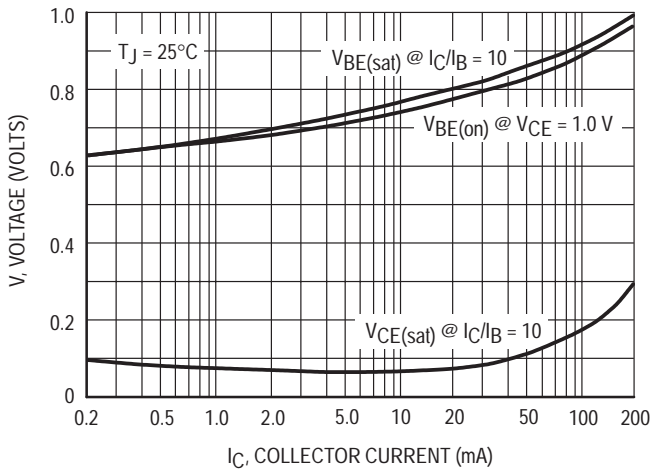


Figure 3. "ON" Voltage

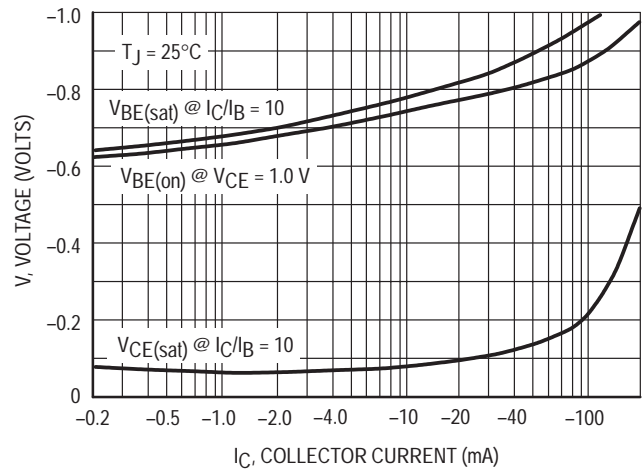


Figure 4. "ON" Voltage

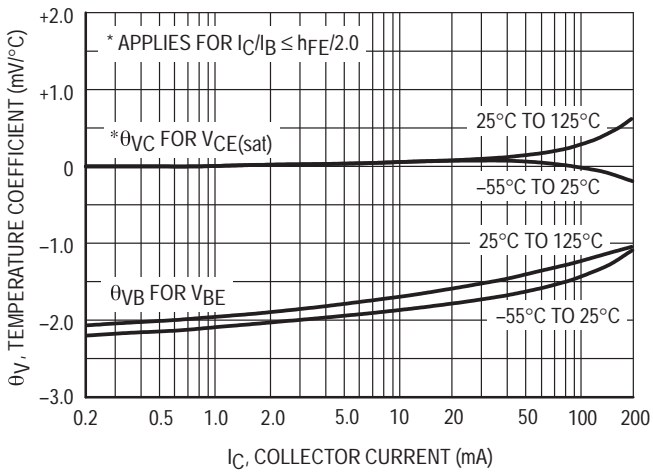


Figure 5. Temperature Coefficients

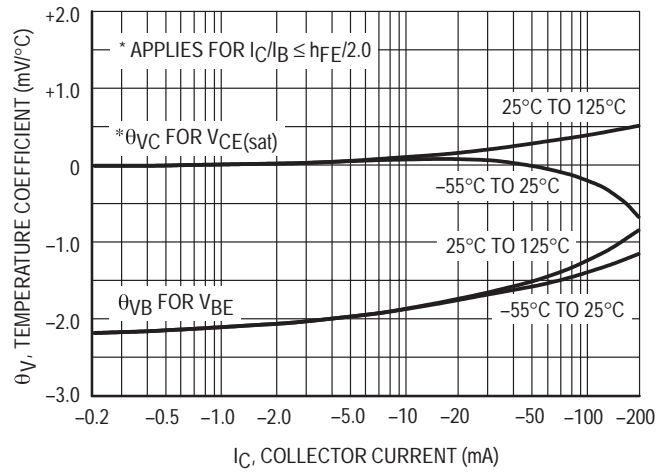


Figure 6. Temperature Coefficients

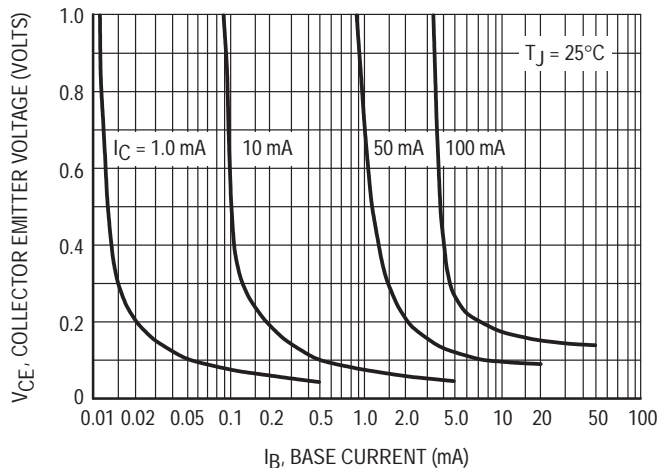


Figure 7. Collector Saturation Region

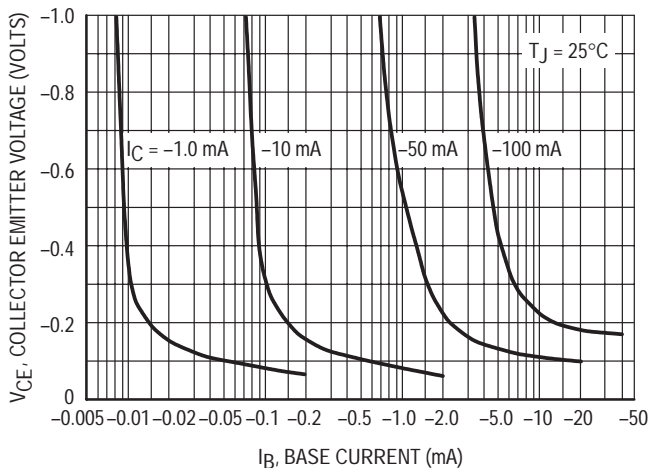
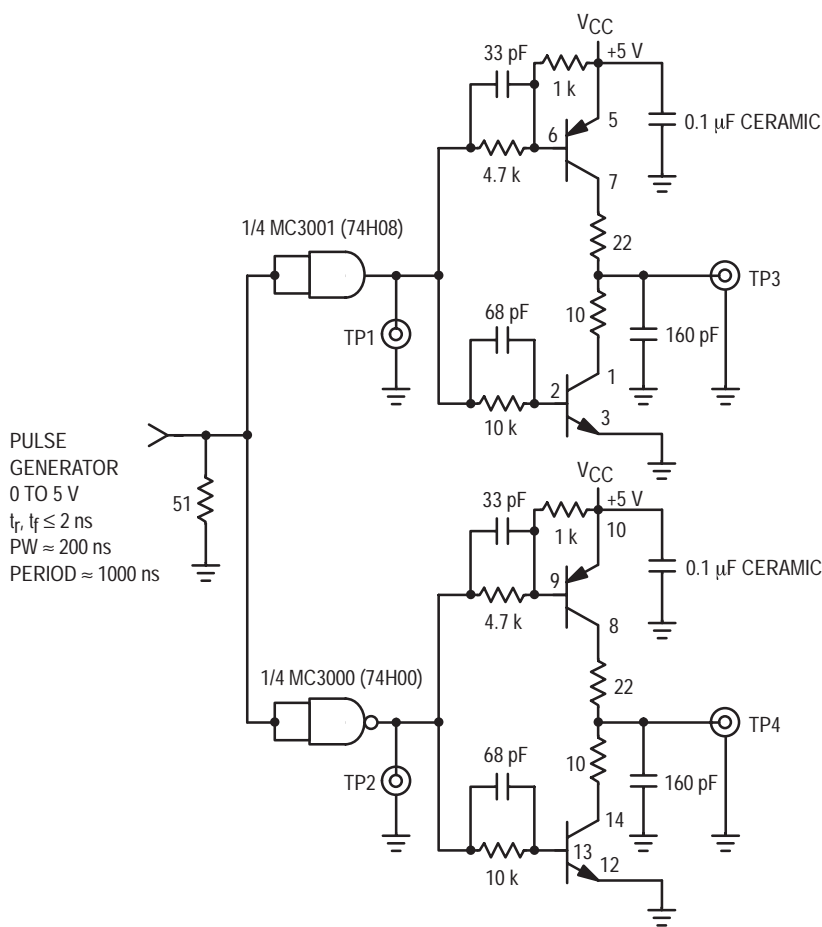


Figure 8. Collector Saturation Region



- NOTES:
1. Unless otherwise noted, all resistors carbon composition $\frac{1}{4}$ W $\pm 5\%$, all capacitors dipped mica $\pm 2\%$.
 2. Use short interconnect wiring with good power and ground buses.
 3. TP1 thru TP4 are coaxial connectors to accept scope probe tip and provide a good ground.
 4. Device under test is MPQ6842.
 5. 160 pF load does not include stray or scope probe capacitance.
 6. Scope probe resistance > 5 k Ω .
Scope probe capacitance < 10 pF.

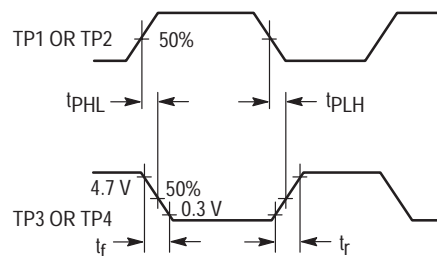
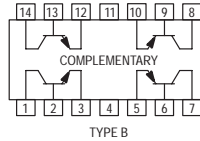


Figure 9. Switching Times Test Circuit and Waveforms

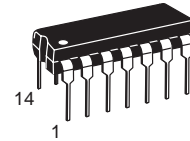
Quad Amplifier Transistors

NPN Silicon



MPQ7041
MPQ7042
MPQ7043*

*Motorola Preferred Device



CASE 646-06, STYLE 1
TO-116

MAXIMUM RATINGS

Rating	Symbol	MPQ7041	MPQ7042	MPQ7043	Unit
Collector-Emitter Voltage	V_{CEO}	150	200	250	Vdc
Collector-Base Voltage	V_{CBO}	150	200	250	Vdc
Emitter-Base Voltage	V_{EBO}	5.0			Vdc
Collector Current—Continuous	I_C	500			mAdc
		Each Die	Four Die Equal Power		
Total Device Dissipation @ $T_A = 25^\circ\text{C}$ Derate above 25°C	P_D	750 5.98	1700 13.6		mW mW/ $^\circ\text{C}$
Total Device Dissipation @ $T_C = 25^\circ\text{C}$ Derate above 25°C	P_D	1.25 10	3.2 25.6		Watts mW/ $^\circ\text{C}$
Operating and Storage Junction Temperature Range	T_J, T_{stg}	-55 to +150			$^\circ\text{C}$

THERMAL CHARACTERISTICS

Characteristic		Junction to Case	Junction to Ambient	Unit
Thermal Resistance	Each Die	100	167	$^\circ\text{C}/\text{W}$
	Effective, 4 Die	39	73.5	$^\circ\text{C}/\text{W}$
Coupling Factors	Q1-Q4 or Q2-Q3	46	56	%
	Q1-Q2 or Q3-Q4	5.0	10	%

ELECTRICAL CHARACTERISTICS ($T_A = 25^\circ\text{C}$ unless otherwise noted)

Characteristic	Symbol	Min	Typ	Max	Unit
----------------	--------	-----	-----	-----	------

OFF CHARACTERISTICS

Collector-Emitter Breakdown Voltage ($I_C = 1.0 \text{ mAdc}, I_E = 0$)	MPQ7041 MPQ7042 MPQ7043	$V_{(BR)CEO}$	150 200 250	— — —	— — —	Vdc
Collector-Base Breakdown Voltage ($I_C = 100 \mu\text{Adc}, I_E = 0$)	MPQ7041 MPQ7042 MPQ7043	$V_{(BR)CBO}$	150 200 250	— — —	— — —	Vdc
Emitter-Base Breakdown Voltage ($I_E = 100 \mu\text{Adc}, I_C = 0$)		$V_{(BR)EBO}$	5.0	—	—	Vdc
Collector Cutoff Current ($V_{CB} = 120 \text{ Vdc}, I_E = 0$) ($V_{CB} = 150 \text{ Vdc}, I_E = 0$) ($V_{CB} = 180 \text{ Vdc}, I_E = 0$)	MPQ7041 MPQ7042 MPQ7043	I_{CBO}	— — —	— — —	100 100 100	nAdc

Preferred devices are Motorola recommended choices for future use and best overall value.

ELECTRICAL CHARACTERISTICS ($T_A = 25^\circ\text{C}$ unless otherwise noted) (Continued)

Characteristic	Symbol	Min	Max	Max	Unit
ON CHARACTERISTICS					
DC Current Gain ($I_C = 1.0\text{ mAdc}$, $V_{CE} = 10\text{ Vdc}$) ($I_C = 10\text{ mAdc}$, $V_{CE} = 10\text{ Vdc}$) ($I_C = 30\text{ mAdc}$, $V_{CE} = 10\text{ Vdc}$)	h_{FE}	25 40 40	45 60 80	— — —	—
Collector–Emitter Saturation Voltage ($I_C = 20\text{ mAdc}$, $I_B = 2.0\text{ mAdc}$)	$V_{CE(sat)}$	—	0.3	0.5	Vdc
Base–Emitter Saturation Voltage ($I_C = 20\text{ mAdc}$, $I_B = 2.0\text{ mAdc}$)	$V_{BE(sat)}$	—	0.7	0.9	Vdc

SMALL–SIGNAL CHARACTERISTICS

Current–Gain — Bandwidth Product ($I_C = 10\text{ mAdc}$, $V_{CE} = 20\text{ Vdc}$, $f = 100\text{ MHz}$)	f_T	50	80	—	MHz
Output Capacitance ($V_{CB} = 20\text{ Vdc}$, $I_E = 0$, $f = 1.0\text{ MHz}$)	C_{obo}	—	2.5	5.0	pF
Input Capacitance ($V_{EB} = 3.0\text{ Vdc}$, $I_C = 0$, $f = 1.0\text{ MHz}$)	C_{ibo}	—	40	50	pF

DC CHARACTERISTICS

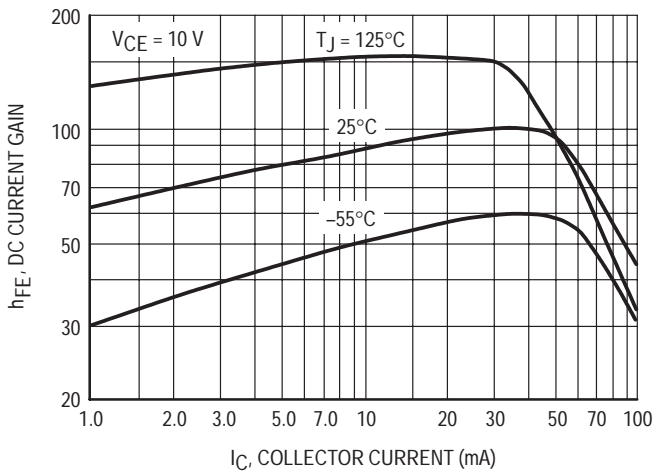


Figure 1. DC Current Gain

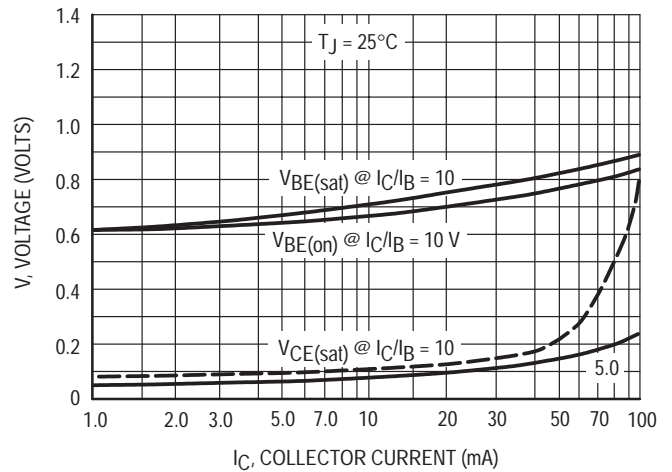


Figure 2. "ON" Voltages

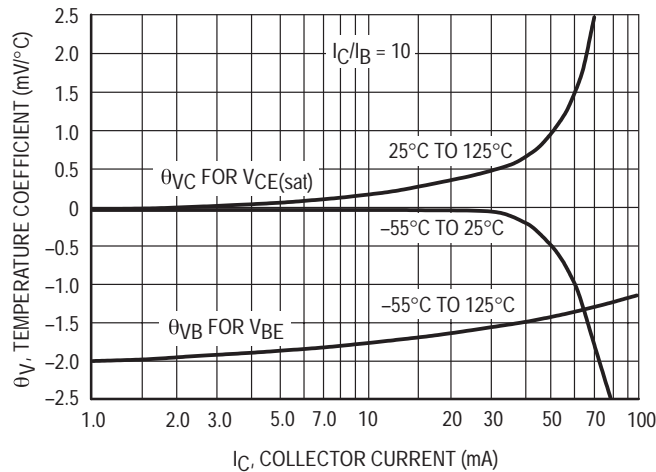
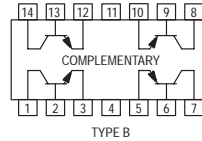


Figure 3. Temperature Coefficients

Quad Complementary Pair Transistor

NPN/PNP Silicon



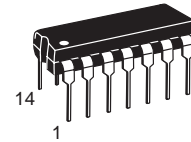
MPQ7051

Voltage and current are negative for PNP transistors

Motorola Preferred Device

MAXIMUM RATINGS

Rating	Symbol	Value	Unit
Collector–Emitter Voltage	V_{CEO}	150	Vdc
Collector–Base Voltage	V_{CBO}	150	Vdc
Emitter–Base Voltage	V_{EBO}	5.0	Vdc
Collector Current — Continuous	I_C	500	mAdc
		Each Die	Four Die Equal Power
Total Device Dissipation @ $T_A = 25^\circ\text{C}$ Derate above 25°C	P_D	750 5.98	1700 13.6 mW mW/ $^\circ\text{C}$
Total Device Dissipation @ $T_C = 25^\circ\text{C}$ Derate above 25°C	P_D	1.25 10	3.2 25.6 Watts mW/ $^\circ\text{C}$
Operating and Storage Junction Temperature Range	T_J, T_{stg}	–55 to +150	$^\circ\text{C}$



CASE 646–06, STYLE 1
TO–116
TYPE B

THERMAL CHARACTERISTICS

Characteristic	Junction to Case	Junction to Ambient	Unit
Thermal Resistance	Each Die	100	$^\circ\text{C}/\text{W}$
	Effective, 4 Die	39	$^\circ\text{C}/\text{W}$
Coupling Factors	Q1–Q4 or Q2–Q3	46	%
	Q1–Q2 or Q3–Q4	5.0	%

ELECTRICAL CHARACTERISTICS ($T_A = 25^\circ\text{C}$ unless otherwise noted)

Characteristic	Symbol	Min	Max	Unit
----------------	--------	-----	-----	------

OFF CHARACTERISTICS

Collector–Emitter Breakdown Voltage ($I_C = 1.0$ mAdc, $I_E = 0$)	$V_{(BR)CEO}$	150	—	Vdc
Collector–Base Breakdown Voltage ($I_C = 100$ μAdc , $I_E = 0$)	$V_{(BR)CBO}$	150	—	Vdc
Emitter–Base Breakdown Voltage ($I_E = 100$ μAdc , $I_C = 0$)	$V_{(BR)EBO}$	5.0	—	Vdc
Collector Cutoff Current ($V_{CB} = 120$ Vdc, $I_E = 0$)	I_{CBO}	—	250	nAdc
Emitter Cutoff Current ($V_{EB} = 3.0$ Vdc, $I_C = 0$)	I_{EBO}	—	100	nAdc

Preferred devices are Motorola recommended choices for future use and best overall value.

ELECTRICAL CHARACTERISTICS ($T_A = 25^\circ\text{C}$ unless otherwise noted) (Continued)

Characteristic	Symbol	Min	Max	Unit
ON CHARACTERISTICS				
DC Current Gain ($I_C = 1.0\text{ mAdc}$, $V_{CE} = 10\text{ Vdc}$) ($I_C = 10\text{ mAdc}$, $V_{CE} = 10\text{ Vdc}$) ($I_C = 30\text{ mAdc}$, $V_{CE} = 10\text{ Vdc}$)	h_{FE}	25 35 25	— — —	—
Collector–Emitter Saturation Voltage ($I_C = 20\text{ mAdc}$, $I_B = 2.0\text{ mAdc}$)	$V_{CE(sat)}$	—	0.7	Vdc
Base–Emitter Saturation Voltage ($I_C = 20\text{ mAdc}$, $I_B = 2.0\text{ mAdc}$)	$V_{BE(sat)}$	—	0.9	Vdc
SMALL–SIGNAL CHARACTERISTICS				
Current–Gain — Bandwidth Product ($I_C = 10\text{ mAdc}$, $V_{CE} = 20\text{ Vdc}$, $f = 100\text{ MHz}$)	f_T	50	—	MHz
Output Capacitance ($V_{CB} = 20\text{ Vdc}$, $I_C = 0$, $f = 1.0\text{ MHz}$)	C_{obo}	—	6.0	pF
Input Capacitance ($V_{EB} = 3.0\text{ Vdc}$, $I_C = 0$, $f = 1.0\text{ MHz}$)	C_{ibo}	— —	50 75	pF
	NPN			
	PNP			

DC CHARACTERISTICS

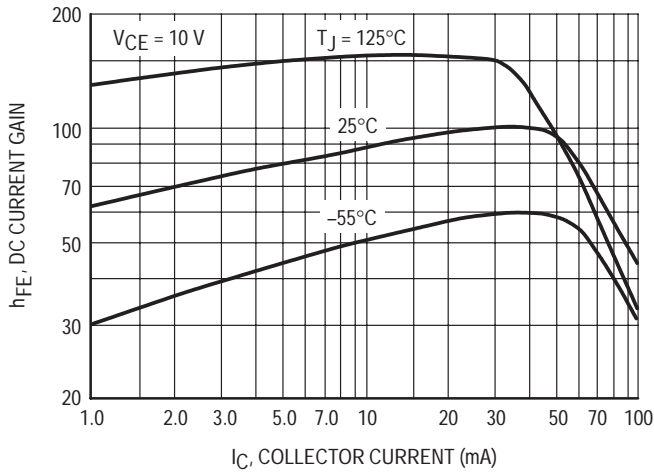


Figure 1. DC Current Gain

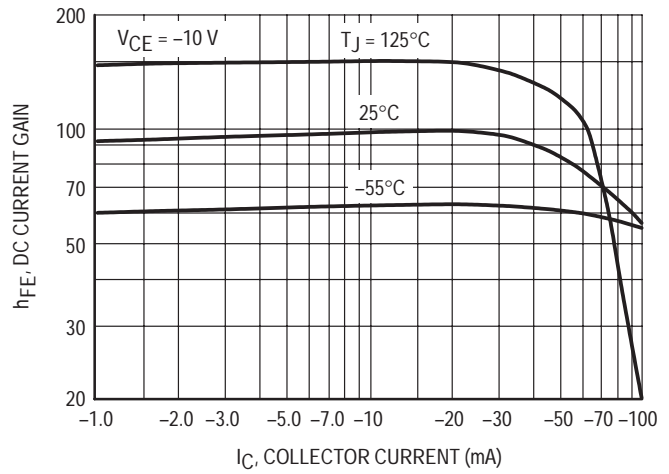


Figure 2. DC Current Gain

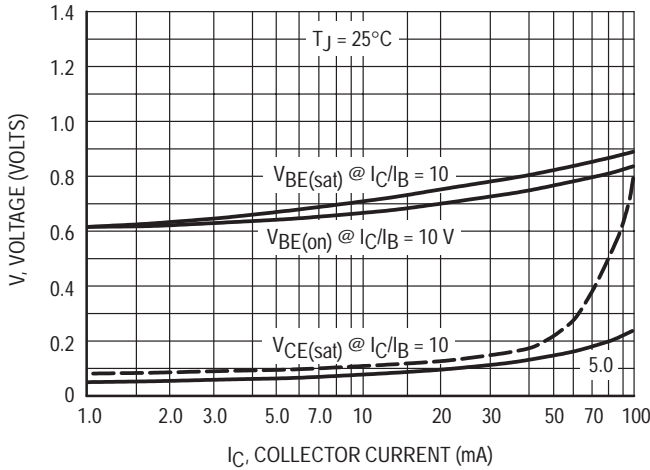


Figure 3. "ON" Voltages

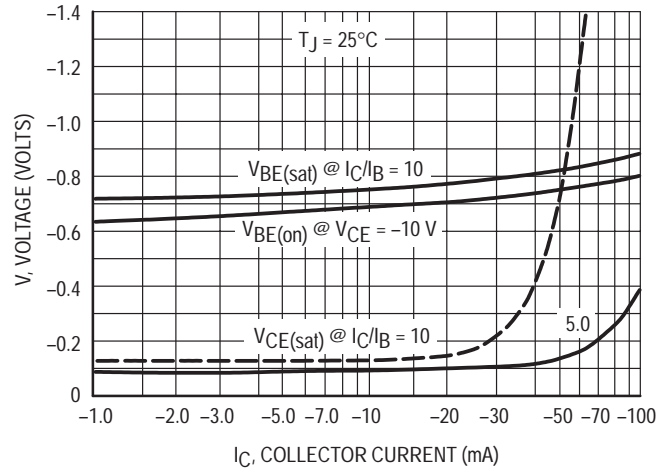


Figure 4. "ON" Voltages

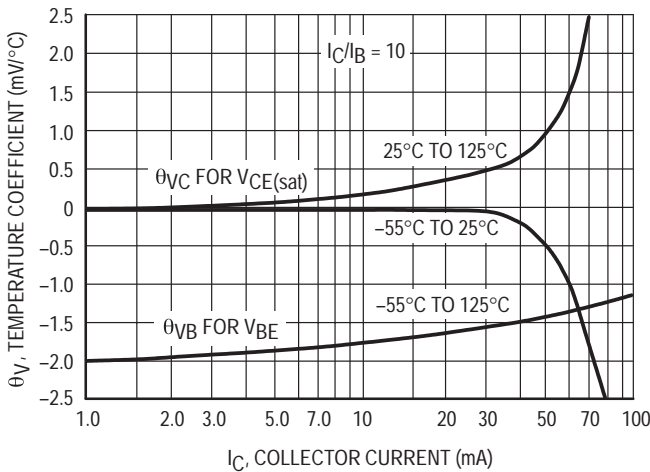


Figure 5. Temperature Coefficients

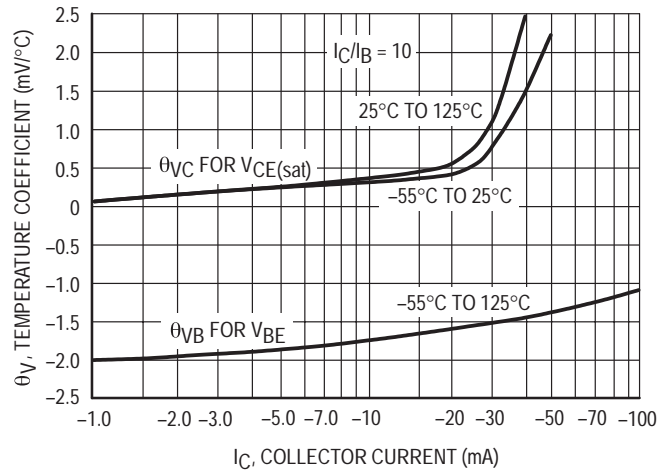
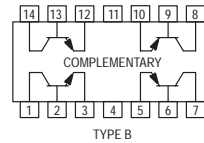


Figure 6. Temperature Coefficients

Quad Amplifier Transistors

PNP Silicon

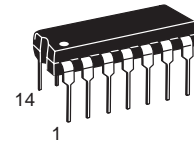


MPQ7091
MPQ7093*

*Motorola Preferred Device

MAXIMUM RATINGS

Rating	Symbol	MPQ7091	MPQ7093	Unit
Collector–Emitter Voltage	V_{CEO}	-150	-250	Vdc
Collector–Base Voltage	V_{CBO}	-150	-250	Vdc
Emitter–Base Voltage	V_{EBO}	-5.0		Vdc
Collector Current — Continuous	I_C	-500		mAdc
		Each Die	Four Die Equal Power	
Total Device Dissipation @ $T_A = 25^\circ\text{C}$ Derate above 25°C	P_D	750 5.98	1700 13.6	mW mW/ $^\circ\text{C}$
Total Device Dissipation @ $T_C = 25^\circ\text{C}$ Derate above 25°C	P_D	1.25 10	3.2 25.6	Watts mW/ $^\circ\text{C}$
Operating and Storage Junction Temperature Range	T_J, T_{stg}	-55 to +150		$^\circ\text{C}$



CASE 646-06, STYLE 1
TO-116

THERMAL CHARACTERISTICS

Characteristic		Junction to Case	Junction to Ambient	Unit
Thermal Resistance	Each Die	100	167	$^\circ\text{C}/\text{W}$
	Effective, 4 Die	39	73.5	$^\circ\text{C}/\text{W}$
Coupling Factors	Q1–Q4 or Q2–Q3	46	56	%
	Q1–Q2 or Q3–Q4	5.0	10	%

ELECTRICAL CHARACTERISTICS ($T_A = 25^\circ\text{C}$ unless otherwise noted)

Characteristic	Symbol	Min	Typ	Max	Unit
----------------	--------	-----	-----	-----	------

OFF CHARACTERISTICS

Collector–Emitter Breakdown Voltage ($I_C = -1.0$ mAdc, $I_B = 0$)	MPQ7091 MPQ7093	$V_{(BR)CEO}$	-150 -250	— —	— —	Vdc
Collector–Base Breakdown Voltage ($I_C = -100$ μAdc , $I_E = 0$)	MPQ7091 MPQ7093	$V_{(BR)CBO}$	-150 -250	— —	— —	Vdc
Emitter–Base Breakdown Voltage ($I_E = -100$ μAdc , $I_C = 0$)		$V_{(BR)EBO}$	-5.0	—	—	Vdc
Collector Cutoff Current ($V_{CB} = -120$ Vdc, $I_E = 0$)	MPQ7091 MPQ7093	I_{CBO}	— —	— —	-250 -250	nAdc
Emitter Cutoff Current ($V_{EB} = -3.0$ Vdc, $I_C = 0$)		I_{EBO}	—	—	-100	nAdc

Preferred devices are Motorola recommended choices for future use and best overall value.

MPQ7091 MPQ7093

ELECTRICAL CHARACTERISTICS ($T_A = 25^\circ\text{C}$ unless otherwise noted) (Continued)

Characteristic	Symbol	Min	Max	Max	Unit
ON CHARACTERISTICS					
DC Current Gain ($I_C = -1.0\text{ mAdc}$, $V_{CE} = -10\text{ Vdc}$) ($I_C = -10\text{ mAdc}$, $V_{CE} = -10\text{ Vdc}$) ($I_C = -30\text{ mAdc}$, $V_{CE} = -10\text{ Vdc}$)	h_{FE}	25 35 25	40 55 50	— — —	—
Collector–Emitter Saturation Voltage ($I_C = -20\text{ mAdc}$, $I_B = -2.0\text{ mAdc}$)	$V_{CE(sat)}$	—	-0.3	-0.5	Vdc
Base–Emitter Saturation Voltage ($I_C = -20\text{ mAdc}$, $I_B = -2.0\text{ mAdc}$)	$V_{BE(sat)}$	—	-0.7	-0.9	Vdc

SMALL–SIGNAL CHARACTERISTICS

Current–Gain — Bandwidth Product ($I_C = -10\text{ mAdc}$, $V_{CE} = -20\text{ Vdc}$, $f = 100\text{ MHz}$)	f_T	50	70	—	MHz
Output Capacitance ($V_{CB} = -20\text{ Vdc}$, $I_E = 0$, $f = 1.0\text{ MHz}$)	C_{obo}	—	3.0	5.0	pF
Input Capacitance ($V_{EB} = -3.0\text{ Vdc}$, $I_C = 0$, $f = 1.0\text{ MHz}$)	C_{ibo}	—	60	75	pF

DC CHARACTERISTICS

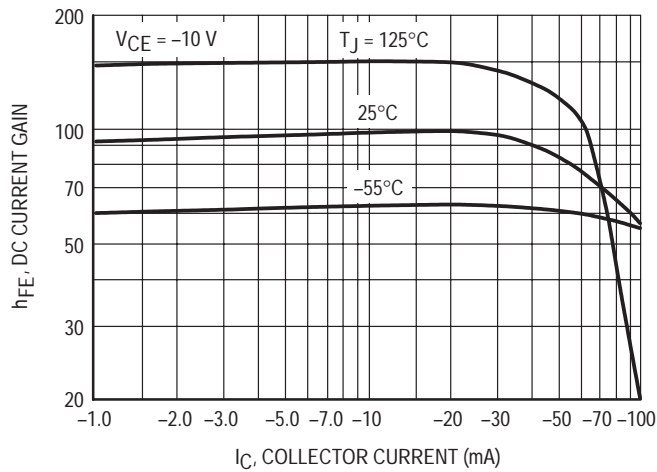


Figure 1. DC Current Gain

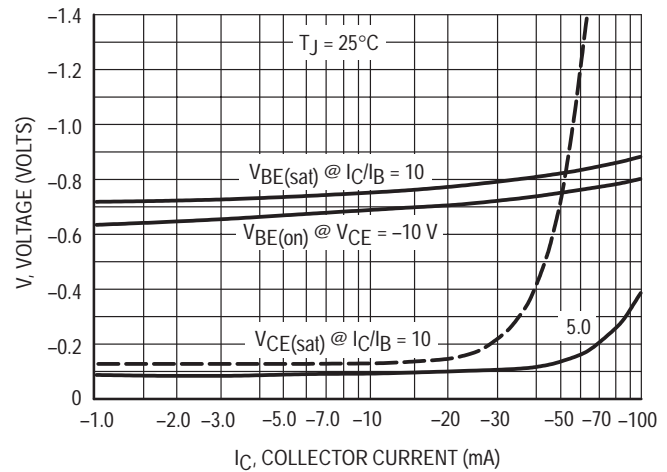


Figure 2. "ON" Voltages

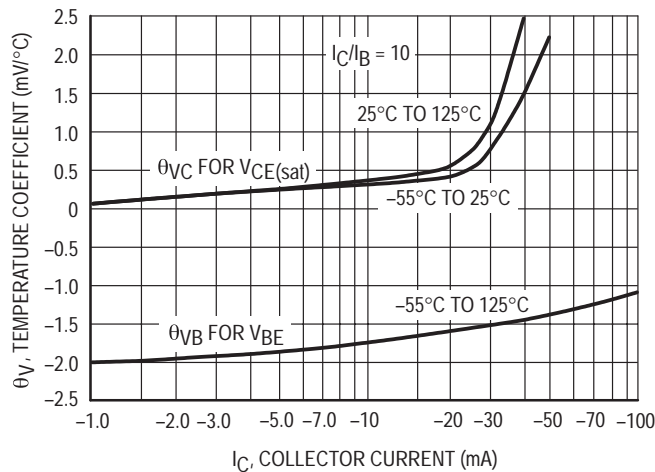


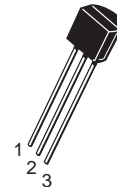
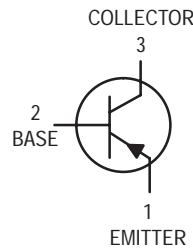
Figure 3. Temperature Coefficients

Chopper Transistor

PNP Silicon

MPS404A

Motorola Preferred Device



CASE 29-04, STYLE 1
TO-92 (TO-226AA)

MAXIMUM RATINGS

Rating	Symbol	Value	Unit
Collector–Emitter Voltage	V_{CEO}	–35	Vdc
Collector–Base Voltage	V_{CBO}	–40	Vdc
Emitter–Base Voltage	V_{EBO}	–25	Vdc
Collector Current — Continuous	I_C	–150	mAdc
Total Device Dissipation @ $T_A = 25^\circ\text{C}$ Derate above 25°C	P_D	625 5.0	mW mW/ $^\circ\text{C}$
Total Device Dissipation @ $T_C = 25^\circ\text{C}$ Derate above 25°C	P_D	1.5 12	Watts mW/ $^\circ\text{C}$
Operating and Storage Junction Temperature Range	T_J, T_{stg}	–55 to +150	$^\circ\text{C}$

THERMAL CHARACTERISTICS

Characteristic	Symbol	Max	Unit
Thermal Resistance, Junction to Ambient	$R_{\theta JA}^{(1)}$	200	$^\circ\text{C}/\text{W}$
Thermal Resistance, Junction to Case	$R_{\theta JC}$	83.3	$^\circ\text{C}/\text{W}$

ELECTRICAL CHARACTERISTICS ($T_A = 25^\circ\text{C}$ unless otherwise noted)

Characteristic	Symbol	Min	Max	Unit
----------------	--------	-----	-----	------

OFF CHARACTERISTICS

Collector–Emitter Breakdown Voltage ⁽²⁾ ($I_C = -10 \text{ mAdc}, I_E = 0$)	$V_{(BR)CEO}$	–35	—	Vdc
Collector–Base Breakdown Voltage ($I_C = -10 \mu\text{Adc}, I_E = 0$)	$V_{(BR)CBO}$	–40	—	Vdc
Emitter–Base Breakdown Voltage ($I_E = -10 \mu\text{Adc}, I_C = 0$)	$V_{(BR)EBO}$	–25	—	Vdc
Collector Cutoff Current ($V_{CB} = -10 \text{ Vdc}, I_E = 0$)	I_{CBO}	—	–100	nAdc
Emitter Cutoff Current ($V_{BE} = -10 \text{ Vdc}, I_C = 0$)	I_{EBO}	—	–100	nAdc

2. Pulse Test: Pulse Width $\leq 300 \mu\text{s}$, Duty Cycle $\leq 2.0\%$.

Preferred devices are Motorola recommended choices for future use and best overall value.

ELECTRICAL CHARACTERISTICS ($T_A = 25^\circ\text{C}$ unless otherwise noted) (Continued)

Characteristic	Symbol	Min	Max	Unit
ON CHARACTERISTICS				
DC Current Gain ($I_C = -12\text{ mAdc}$, $V_{CE} = -0.15\text{ Vdc}$)	h_{FE}	30	400	—
Collector–Emitter Saturation Voltage ($I_C = -12\text{ mAdc}$, $I_B = -0.4\text{ mAdc}$) ($I_C = -24\text{ mAdc}$, $I_B = -1.0\text{ mAdc}$)	$V_{CE(sat)}$	— —	-0.15 -0.2	Vdc
Base–Emitter Saturation Voltage ($I_C = -12\text{ mAdc}$, $I_B = -0.4\text{ mAdc}$) ($I_C = -24\text{ mAdc}$, $I_B = -1.0\text{ mAdc}$)	$V_{BE(sat)}$	— —	-0.85 -1.0	Vdc

SMALL–SIGNAL CHARACTERISTICS

Common–Base Cutoff Frequency ($I_C = -1.0\text{ mAdc}$, $V_{CB} = 6.0\text{ Vdc}$)	f_{ob}	4.0	—	MHz
Output Capacitance ($V_{CB} = -6.0\text{ Vdc}$, $I_E = 0$, $f = 1.0\text{ MHz}$)	C_{obo}	—	20	pF

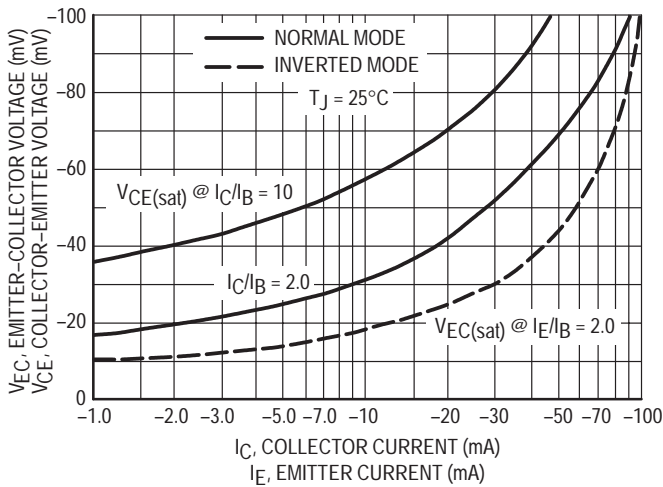


Figure 1. Collector–Emitter Voltage

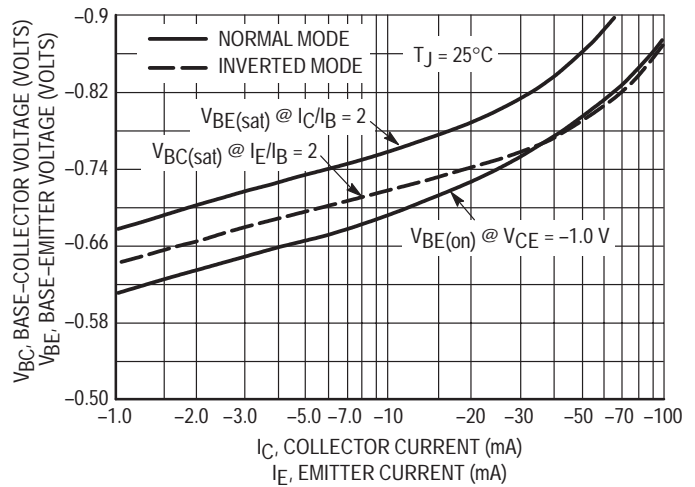


Figure 2. Base “On” Voltage

NORMAL MODE

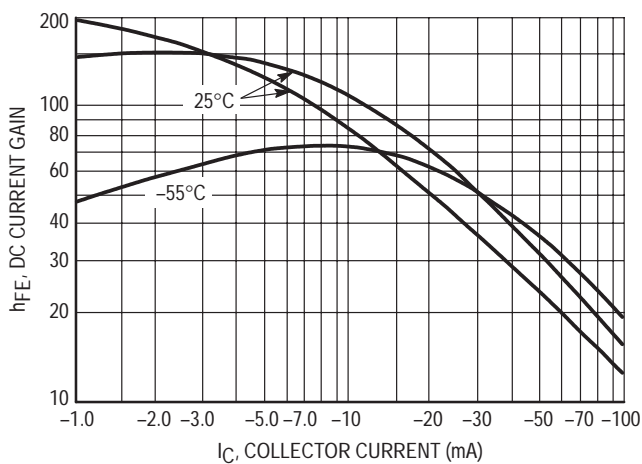


Figure 3. DC Current Gain @ $V_{CE} = -0.15$ Vdc

INVERTED MODE

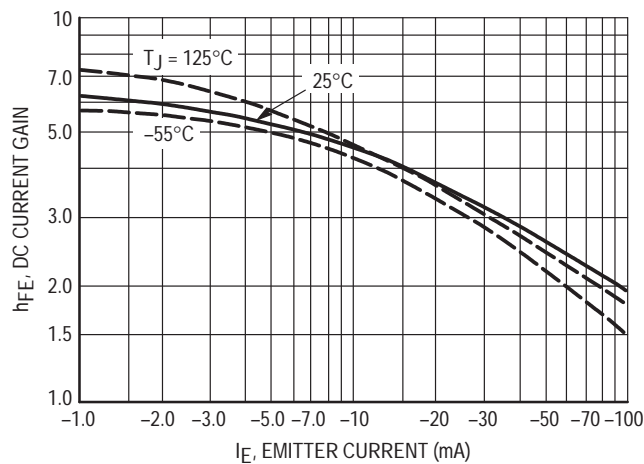


Figure 4. DC Current Gain @ $V_{EC} = -0.15$ Vdc

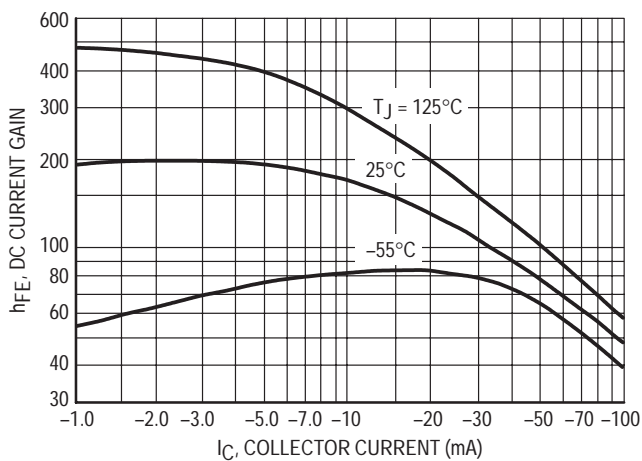


Figure 5. DC Current Gain @ $V_{CE} = -1.0$ Vdc

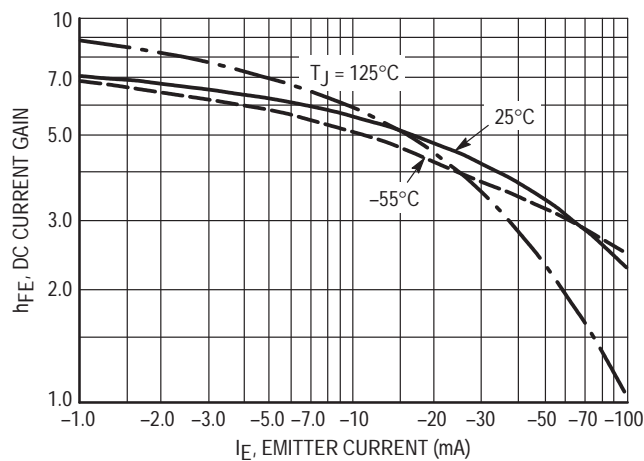


Figure 6. DC Current Gain @ $V_{EC} = -1.0$ Vdc

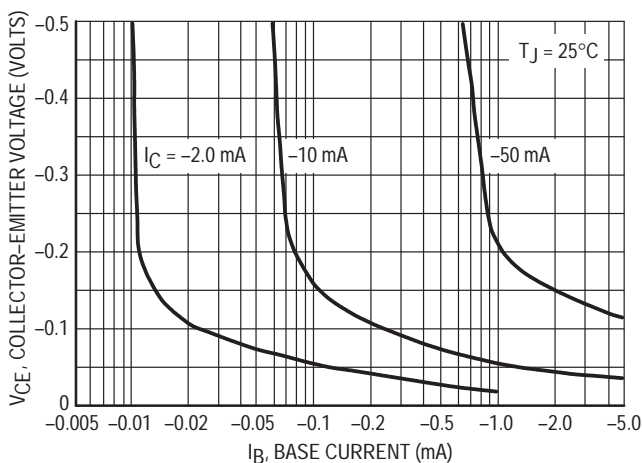


Figure 7. Collector Saturation Region

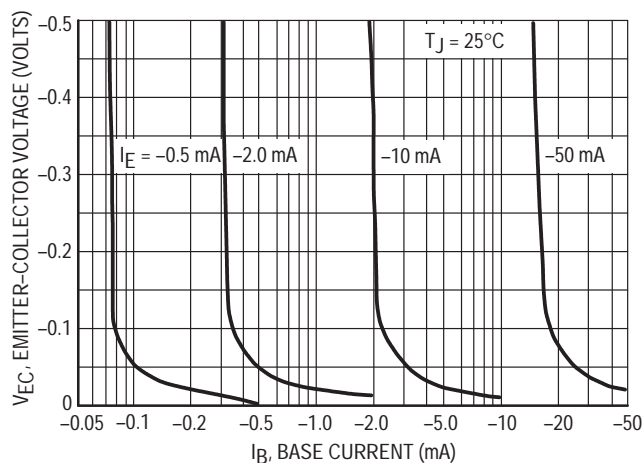


Figure 8. Emitter Saturation Region

MPS404A

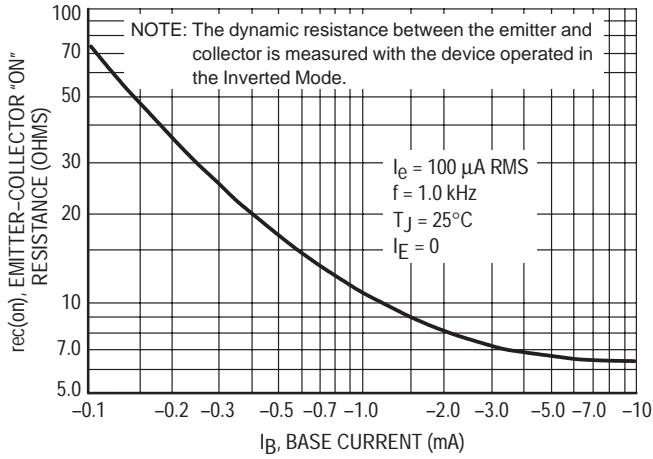


Figure 9. Emitter-Collector "On" Resistance

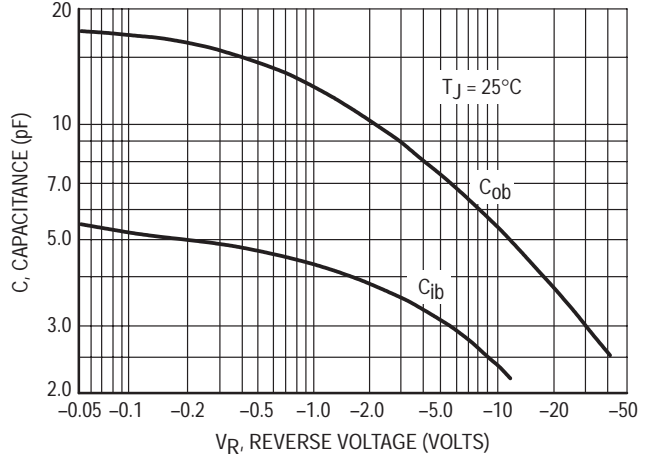


Figure 10. Capacitance

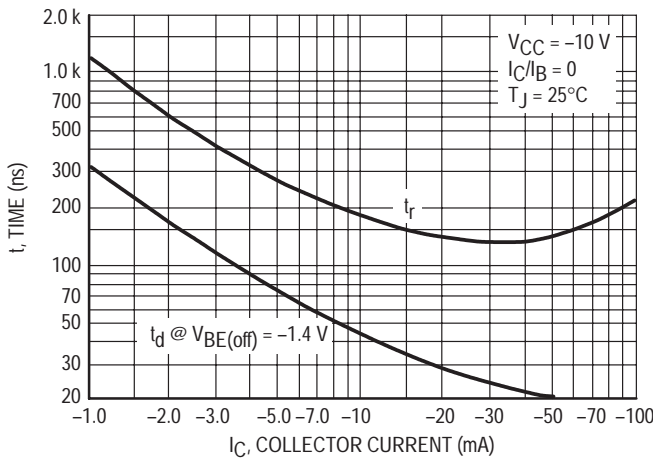


Figure 11. Turn-On Time

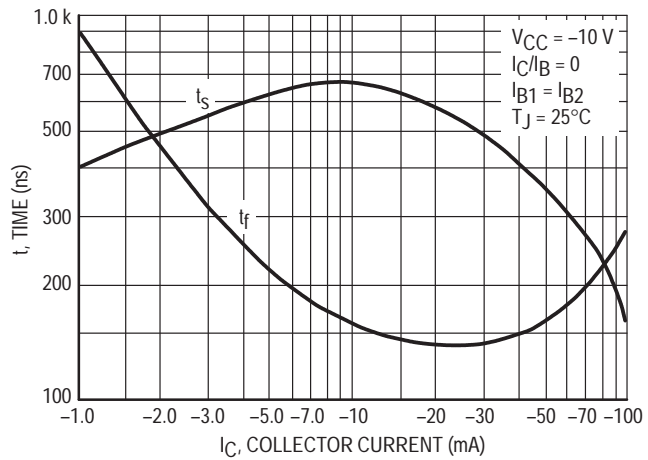
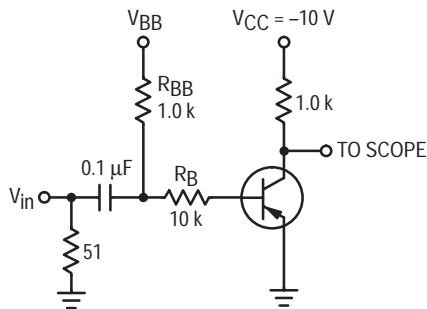


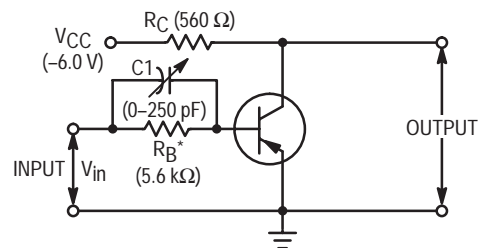
Figure 12. Turn-Off Time



	V _{in} (Volts)	V _{BB} (Volts)
t _{on} , t _d and t _r	-12	+1.4
t _{off} , t _s and t _f	+20.6	-11.6

Voltages and resistor values shown are for I_C = 10 mA, I_C/I_B = 10 and I_{B1} = I_{B2}. Resistor values changed to obtain curves in Figures 11 and 12.

Figure 13. Switching Time Test Circuit



MEASUREMENT PROCEDURE
C₁ is increased until the t_{off} time of the output waveform is decreased to 0.2 μs, Q_S is then calculated by Q_S = C₁ V_{in}. Q_{S3} or Q_{S7} by B-Line Electronics or equivalent may also be used.

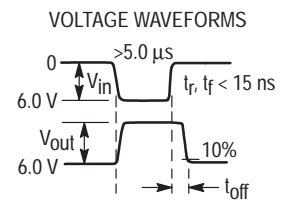
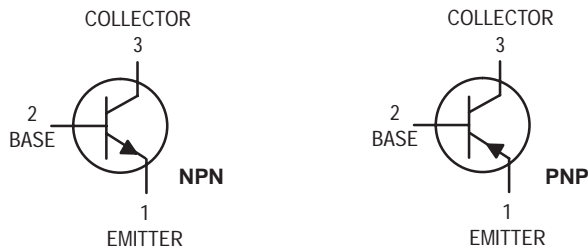


Figure 14. Stored Base Charge Test Circuit

Amplifier Transistors



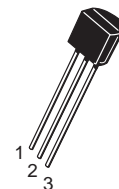
NPN
MPS650
MPS651*
PNP
MPS750
MPS751*

Voltage and current are negative for PNP transistors

*Motorola Preferred Devices

MAXIMUM RATINGS

Rating	Symbol	MPS650 MPS750	MPS651 MPS751	Unit
Collector–Emitter Voltage	V_{CE}	40	60	Vdc
Collector–Base Voltage	V_{CB}	60	80	Vdc
Emitter–Base Voltage	V_{EB}	5.0		Vdc
Collector Current — Continuous	I_C	2.0		Adc
Total Power Dissipation @ $T_A = 25^\circ\text{C}$ Derate above 25°C	P_D	625	5.0	mW mW/°C
Total Power Dissipation @ $T_C = 25^\circ\text{C}$ Derate above 25°C	P_D	1.5	12	Watt mW/°C
Operating and Storage Junction Temperature Range	T_J, T_{stg}	–55 to +150		°C



CASE 29–04, STYLE 1
TO–92 (TO–226AA)

THERMAL CHARACTERISTICS

Characteristic	Symbol	Max	Unit
Thermal Resistance, Junction to Ambient	$R_{\theta JA}$	200	°C/W
Thermal Resistance, Junction to Case	$R_{\theta JC}$	83.3	°C/W

ELECTRICAL CHARACTERISTICS ($T_C = 25^\circ\text{C}$ unless otherwise noted)

Characteristic	Symbol	Min	Max	Unit
----------------	--------	-----	-----	------

OFF CHARACTERISTICS

Collector–Emitter Breakdown Voltage ⁽¹⁾ ($I_C = 10 \text{ mAdc}, I_B = 0$)	MPS650, MPS750 MPS651, MPS751	$V_{(BR)CEO}$	40 60	— —	Vdc
Collector–Base Breakdown Voltage ($I_C = 100 \mu\text{Adc}, I_E = 0$)	MPS650, MPS750 MPS651, MPS751	$V_{(BR)CBO}$	60 80	— —	Vdc
Emitter–Base Breakdown Voltage ($I_C = 0, I_E = 10 \mu\text{Adc}$)		$V_{(BR)EBO}$	5.0	—	Vdc
Collector Cutoff Current ($V_{CB} = 60 \text{ Vdc}, I_E = 0$) ($V_{CB} = 80 \text{ Vdc}, I_E = 0$)	MPS650, MPS750 MPS651, MPS751	I_{CBO}	— —	0.1 0.1	μAdc
Emitter Cutoff Current ($V_{EB} = 4.0 \text{ V}, I_C = 0$)		I_{EBO}	—	0.1	μAdc

1. Pulse Test: Pulse Width $\leq 300 \mu\text{s}$, Duty Cycle = 2.0%.

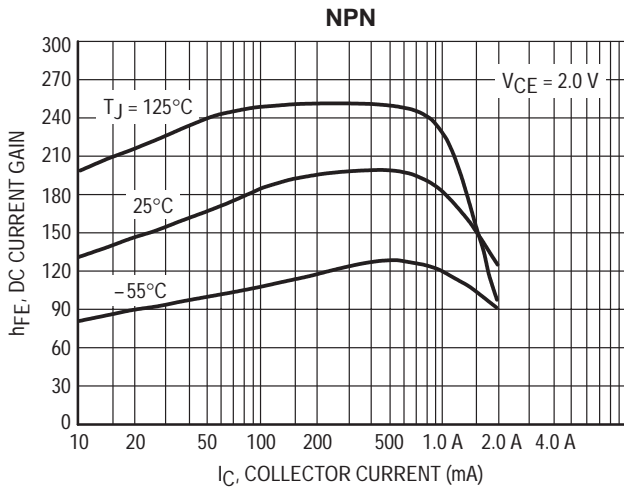
Preferred devices are Motorola recommended choices for future use and best overall value.

NPN MPS650 MPS651 PNP MPS750 MPS751

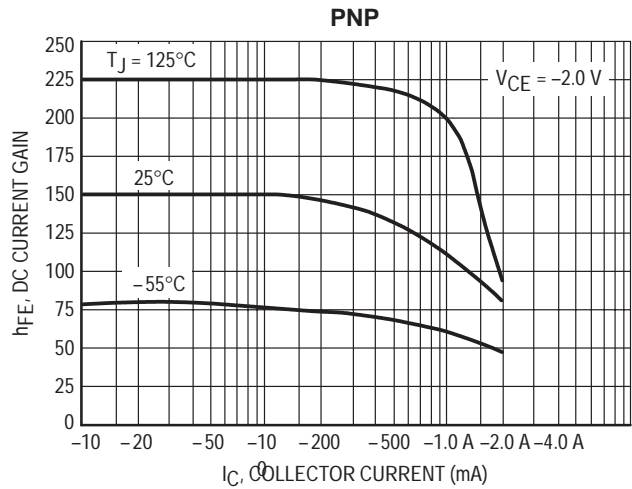
ELECTRICAL CHARACTERISTICS ($T_C = 25^\circ\text{C}$ unless otherwise noted) (Continued)

Characteristic	Symbol	Min	Max	Unit
ON CHARACTERISTICS(1)				
DC Current Gain ($I_C = 50\text{ mA}$, $V_{CE} = 2.0\text{ V}$) ($I_C = 500\text{ mA}$, $V_{CE} = 2.0\text{ V}$) ($I_C = 1.0\text{ A}$, $V_{CE} = 2.0\text{ V}$) ($I_C = 2.0\text{ A}$, $V_{CE} = 2.0\text{ V}$)	h_{FE}	75 75 75 40	— — — —	—
Collector–Emitter Saturation Voltage ($I_C = 2.0\text{ A}$, $I_B = 200\text{ mA}$) ($I_C = 1.0\text{ A}$, $I_B = 100\text{ mA}$)	$V_{CE(sat)}$	— —	0.5 0.3	Vdc
Base–Emitter On Voltage ($I_C = 1.0\text{ A}$, $V_{CE} = 2.0\text{ V}$)	$V_{BE(on)}$	—	1.0	Vdc
Base–Emitter Saturation Voltage ($I_C = 1.0\text{ A}$, $I_B = 100\text{ mA}$)	$V_{BE(sat)}$	—	1.2	Vdc
SMALL–SIGNAL CHARACTERISTICS				
Current–Gain — Bandwidth Product(2) ($I_C = 50\text{ mAdc}$, $V_{CE} = 5.0\text{ Vdc}$, $f = 100\text{ MHz}$)	f_T	75	—	MHz

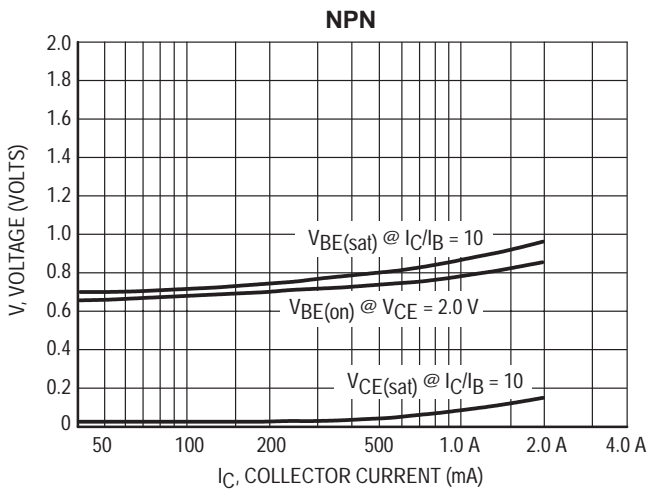
1. Pulse Test: Pulse Width $\leq 300\ \mu\text{s}$, Duty Cycle = 2.0%.
2. f_T is defined as the frequency at which $|h_{fe}|$ extrapolates to unity.



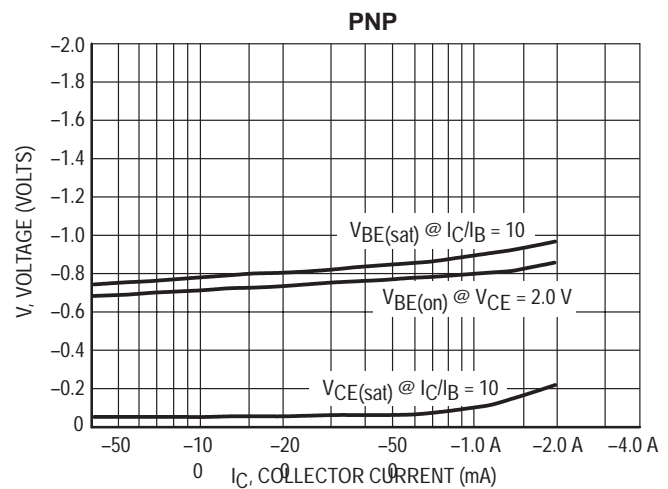
**Figure 1. MPS650, MPS651
Typical DC Current Gain**



**Figure 2. MPS750, MPS751
Typical DC Current Gain**



**Figure 3. MPS650, MPS651
On Voltages**



**Figure 4. MPS750, MPS751
On Voltages**

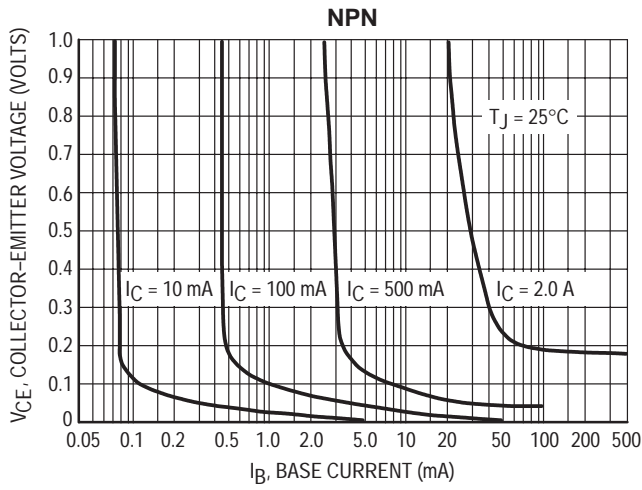


Figure 5. MPS650, MPS651 Collector Saturation Region

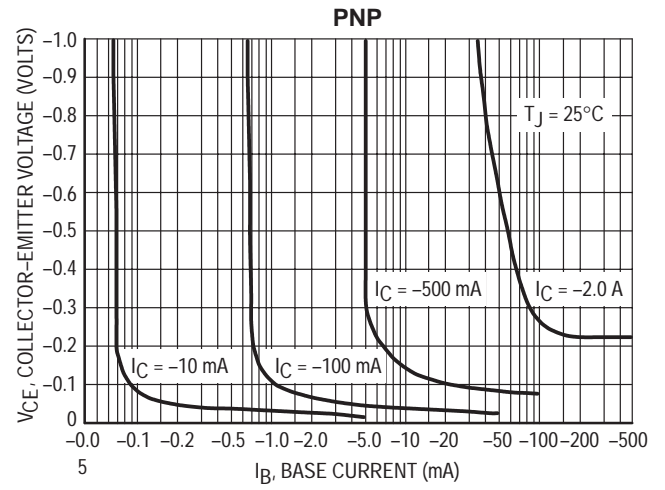


Figure 6. MPS750, MPS751 Collector Saturation Region

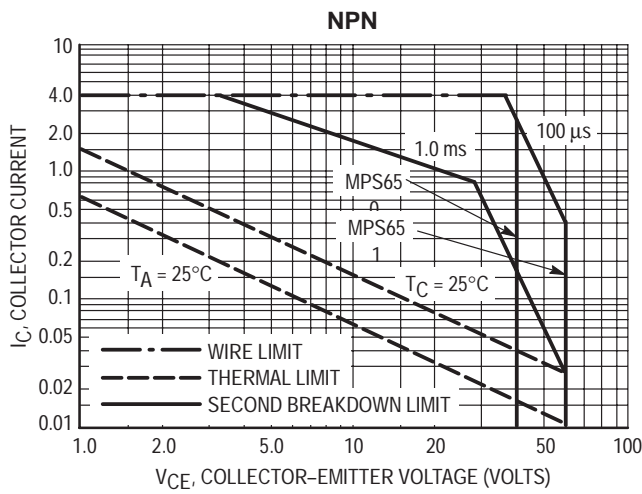


Figure 7. MPS650, MPS651 SOA, Safe Operating Area

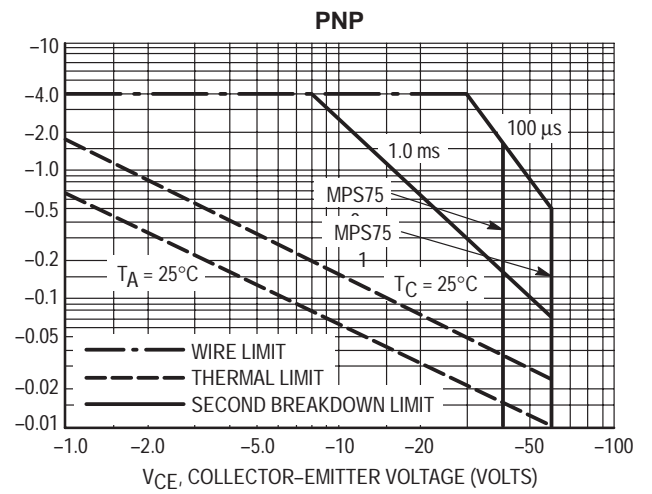


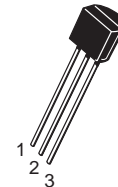
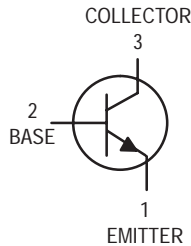
Figure 8. MPS750, MPS751 SOA, Safe Operating Area

Amplifier Transistors

NPN Silicon

MPS918*
MPS3563

*Motorola Preferred Device



CASE 29-04, STYLE 1
TO-92 (TO-226AA)

MAXIMUM RATINGS

Rating	Symbol	MPS918	MPS3563	Unit
Collector–Emitter Voltage	V_{CEO}	15	12	Vdc
Collector–Base Voltage	V_{CBO}	30	30	Vdc
Emitter–Base Voltage	V_{EBO}	3.0	2.0	Vdc
Collector Current — Continuous	I_C	50		mAdc
Total Device Dissipation @ $T_A = 25^\circ\text{C}$ Derate above 25°C	P_D	350	2.8	mW mW/ $^\circ\text{C}$
Total Device Dissipation @ $T_C = 25^\circ\text{C}$ Derate above 25°C	P_D	0.85	6.8	Watts mW/ $^\circ\text{C}$
Operating and Storage Junction Temperature Range	T_J, T_{stg}	–55 to +150		$^\circ\text{C}$

THERMAL CHARACTERISTICS

Characteristic	Symbol	Max	Unit
Thermal Resistance, Junction to Ambient	$R_{\theta JA}^{(1)}$	357	$^\circ\text{C}/\text{W}$
Thermal Resistance, Junction to Case	$R_{\theta JC}$	147	$^\circ\text{C}/\text{W}$

ELECTRICAL CHARACTERISTICS ($T_A = 25^\circ\text{C}$ unless otherwise noted)

Characteristic	Symbol	Min	Max	Unit
----------------	--------	-----	-----	------

OFF CHARACTERISTICS

Collector–Emitter Breakdown Voltage ⁽²⁾ ($I_C = 3.0 \text{ mAdc}, I_E = 0$)	MPS918 MPS3563	$V_{(BR)CEO}$	15 12	— —	Vdc
Collector–Base Breakdown Voltage ($I_C = 1.0 \mu\text{Adc}, I_E = 0$) ($I_C = 100 \mu\text{Adc}, I_E = 0$)	MPS918 MPS3563	$V_{(BR)CBO}$	30 30	— —	Vdc
Emitter–Base Breakdown Voltage ($I_E = 10 \mu\text{Adc}, I_C = 0$)	MPS918 MPS3563	$V_{(BR)EBO}$	3.0 2.0	— —	Vdc
Collector Cutoff Current ($V_{CB} = 15 \text{ Vdc}, I_E = 0$)	MPS918 MPS3563	I_{CBO}	— —	10 50	nAdc

- $R_{\theta JA}$ is measured with the device soldered into a typical printed circuit board.
- Pulse Test: Pulse Width $\leq 300 \mu\text{s}$; Duty Cycle $\leq 1.0\%$.

Preferred devices are Motorola recommended choices for future use and best overall value.

ELECTRICAL CHARACTERISTICS ($T_A = 25^\circ\text{C}$ unless otherwise noted) (Continued)

Characteristic		Symbol	Min	Max	Unit
ON CHARACTERISTICS					
DC Current Gain ⁽²⁾ ($I_C = 3.0\text{ mAdc}$, $V_{CE} = 1.0\text{ Vdc}$) ($I_C = 8.0\text{ mAdc}$, $V_{CE} = 10\text{ Vdc}$)	MPS918 MPS3563	h_{FE}	20 20	— 200	—
Collector–Emitter Saturation Voltage ($I_C = 10\text{ mAdc}$, $I_B = 1.0\text{ mAdc}$)	MPS918	$V_{CE(sat)}$	—	0.4	Vdc
Base–Emitter Saturation Voltage ($I_C = 10\text{ mAdc}$, $I_B = 1.0\text{ mAdc}$)	MPS918	$V_{BE(sat)}$	—	1.0	Vdc

SMALL–SIGNAL CHARACTERISTICS

Current–Gain — Bandwidth Product ⁽²⁾ ($I_C = 4.0\text{ mAdc}$, $V_{CE} = 10\text{ Vdc}$, $f = 100\text{ MHz}$) ($I_C = 8.0\text{ mAdc}$, $V_{CE} = 10\text{ Vdc}$, $f = 100\text{ MHz}$)	MPS918 MPS3563	f_T	600 600	— 1500	MHz
Output Capacitance ($V_{CB} = 0\text{ Vdc}$, $I_E = 0$, $f = 1.0\text{ MHz}$) ($V_{CB} = 10\text{ Vdc}$, $I_E = 0$, $f = 1.0\text{ MHz}$) ($V_{CB} = 10\text{ Vdc}$, $I_E = 0$, $f = 1.0\text{ MHz}$)	MPS918 MPS918 MPS3563	C_{obo}	— — —	3.0 1.7 1.7	pF
Input Capacitance ($V_{EB} = 0.5\text{ Vdc}$, $I_C = 0$, $f = 1.0\text{ MHz}$)	MPS918	C_{ibo}	—	2.0	pF
Small–Signal Current Gain ($I_C = 8.0\text{ mAdc}$, $V_{CE} = 10\text{ Vdc}$, $f = 1.0\text{ kHz}$)	MPS3563	h_{fe}	20	250	—
Noise Figure ($I_C = 1.0\text{ mAdc}$, $V_{CE} = 6.0\text{ Vdc}$, $R_S = 400\text{ k}\Omega$, $f = 60\text{ MHz}$)	MPS918	NF	—	6.0	dB

FUNCTIONAL TEST

Common–Emitter Amplifier Power Gain ($I_C = 6.0\text{ mAdc}$, $V_{CB} = 12\text{ Vdc}$, $f = 200\text{ MHz}$) ($I_C = 8.0\text{ mAdc}$, $V_{CE} = 10\text{ Vdc}$, $f = 200\text{ MHz}$) ($G_{fd} + G_{re} < -20\text{ dB}$)	MPS918 MPS3563	G_{pe}	15 14	— —	dB
Power Output ($I_C = 8.0\text{ mAdc}$, $V_{CB} = 15\text{ Vdc}$, $f = 500\text{ MHz}$)	MPS918	P_{out}	30	—	mW
Oscillator Collector Efficiency ($I_C = 8.0\text{ mAdc}$, $V_{CB} = 15\text{ Vdc}$, $P_{out} = 30\text{ mW}$, $f = 500\text{ MHz}$)	MPS918	η	25	—	%

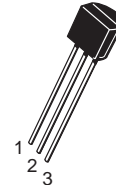
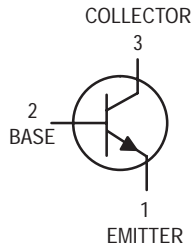
2. Pulse Test: Pulse Width $\leq 300\text{ }\mu\text{s}$; Duty Cycle $\leq 1.0\%$.

General Purpose Transistors

NPN Silicon

MPS2222
MPS2222A*

*Motorola Preferred Device



CASE 29-04, STYLE 1
TO-92 (TO-226AA)

MAXIMUM RATINGS

Rating	Symbol	MPS2222	MPS2222A	Unit
Collector–Emitter Voltage	V_{CEO}	30	40	Vdc
Collector–Base Voltage	V_{CBO}	60	75	Vdc
Emitter–Base Voltage	V_{EBO}	5.0	6.0	Vdc
Collector Current — Continuous	I_C	600		mAdc
Total Device Dissipation @ $T_A = 25^\circ\text{C}$ Derate above 25°C	P_D	625	5.0	mW mW/ $^\circ\text{C}$
Total Device Dissipation @ $T_C = 25^\circ\text{C}$ Derate above 25°C	P_D	1.5	12	Watts mW/ $^\circ\text{C}$
Operating and Storage Junction Temperature Range	T_J, T_{stg}	–55 to +150		$^\circ\text{C}$

THERMAL CHARACTERISTICS

Characteristic	Symbol	Max	Unit
Thermal Resistance, Junction to Ambient	$R_{\theta JA}$	200	$^\circ\text{C}/\text{W}$
Thermal Resistance, Junction to Case	$R_{\theta JC}$	83.3	$^\circ\text{C}/\text{W}$

ELECTRICAL CHARACTERISTICS ($T_A = 25^\circ\text{C}$ unless otherwise noted)

Characteristic	Symbol	Min	Max	Unit
----------------	--------	-----	-----	------

OFF CHARACTERISTICS

Collector–Emitter Breakdown Voltage ($I_C = 10 \text{ mAdc}, I_E = 0$)	MPS2222 MPS2222A	$V_{(BR)CEO}$	30 40	— —	Vdc
Collector–Base Breakdown Voltage ($I_C = 10 \mu\text{Adc}, I_E = 0$)	MPS2222 MPS2222A	$V_{(BR)CBO}$	60 75	— —	Vdc
Emitter–Base Breakdown Voltage ($I_E = 10 \mu\text{Adc}, I_C = 0$)	MPS2222 MPS2222A	$V_{(BR)EBO}$	5.0 6.0	— —	Vdc
Collector Cutoff Current ($V_{CE} = 60 \text{ Vdc}, V_{EB(off)} = 3.0 \text{ Vdc}$)	MPS2222A	I_{CEX}	—	10	nAdc
Collector Cutoff Current ($V_{CB} = 50 \text{ Vdc}, I_E = 0$) ($V_{CB} = 60 \text{ Vdc}, I_E = 0$) ($V_{CB} = 50 \text{ Vdc}, I_E = 0, T_A = 125^\circ\text{C}$) ($V_{CB} = 50 \text{ Vdc}, I_E = 0, T_A = 125^\circ\text{C}$)	MPS2222 MPS2222A MPS2222 MPS2222A	I_{CBO}	— — — —	0.01 0.01 10 10	μAdc
Emitter Cutoff Current ($V_{EB} = 3.0 \text{ Vdc}, I_C = 0$)	MPS2222A	I_{EBO}	—	100	nAdc
Base Cutoff Current ($V_{CE} = 60 \text{ Vdc}, V_{EB(off)} = 3.0 \text{ Vdc}$)	MPS2222A	I_{BL}	—	20	nAdc

Preferred devices are Motorola recommended choices for future use and best overall value.

ELECTRICAL CHARACTERISTICS ($T_A = 25^\circ\text{C}$ unless otherwise noted) (Continued)

Characteristic	Symbol	Min	Max	Unit
ON CHARACTERISTICS				
DC Current Gain ($I_C = 0.1\text{ mAdc}$, $V_{CE} = 10\text{ Vdc}$) ($I_C = 1.0\text{ mAdc}$, $V_{CE} = 10\text{ Vdc}$) ($I_C = 10\text{ mAdc}$, $V_{CE} = 10\text{ Vdc}$) ($I_C = 10\text{ mAdc}$, $V_{CE} = 10\text{ Vdc}$, $T_A = -55^\circ\text{C}$) ($I_C = 150\text{ mAdc}$, $V_{CE} = 10\text{ Vdc}$) ⁽¹⁾ ($I_C = 150\text{ mAdc}$, $V_{CE} = 1.0\text{ Vdc}$) ⁽¹⁾ ($I_C = 500\text{ mAdc}$, $V_{CE} = 10\text{ Vdc}$) ⁽¹⁾	h_{FE}	35 50 75 35 100 50 30 40	— — — — 300 — — —	—
				MPS2222A only
				MPS2222 MPS2222A
Collector–Emitter Saturation Voltage ⁽¹⁾ ($I_C = 150\text{ mAdc}$, $I_B = 15\text{ mAdc}$) ($I_C = 500\text{ mAdc}$, $I_B = 50\text{ mAdc}$)	$V_{CE(sat)}$	— — — —	0.4 0.3 1.6 1.0	Vdc
				MPS2222 MPS2222A
				MPS2222 MPS2222A
Base–Emitter Saturation Voltage ⁽¹⁾ ($I_C = 150\text{ mAdc}$, $I_B = 15\text{ mAdc}$) ($I_C = 500\text{ mAdc}$, $I_B = 50\text{ mAdc}$)	$V_{BE(sat)}$	— 0.6 — —	1.3 1.2 2.6 2.0	Vdc
				MPS2222 MPS2222A
				MPS2222 MPS2222A

SMALL–SIGNAL CHARACTERISTICS

Current–Gain — Bandwidth Product ⁽²⁾ ($I_C = 20\text{ mAdc}$, $V_{CE} = 20\text{ Vdc}$, $f = 100\text{ MHz}$)	f_T	250 300	— —	MHz
				MPS2222 MPS2222A
Output Capacitance ($V_{CB} = 10\text{ Vdc}$, $I_E = 0$, $f = 1.0\text{ MHz}$)	C_{obo}	—	8.0	pF
Input Capacitance ($V_{EB} = 0.5\text{ Vdc}$, $I_C = 0$, $f = 1.0\text{ MHz}$)	C_{ibo}	— —	30 25	pF
				MPS2222 MPS2222A
Input Impedance ($I_C = 1.0\text{ mAdc}$, $V_{CE} = 10\text{ Vdc}$, $f = 1.0\text{ kHz}$) ($I_C = 10\text{ mAdc}$, $V_{CE} = 10\text{ Vdc}$, $f = 1.0\text{ kHz}$)	h_{ie}	2.0 0.25	8.0 1.25	$k\Omega$
				MPS2222A MPS2222A
Voltage Feedback Ratio ($I_C = 1.0\text{ mAdc}$, $V_{CE} = 10\text{ Vdc}$, $f = 1.0\text{ kHz}$) ($I_C = 10\text{ mAdc}$, $V_{CE} = 10\text{ Vdc}$, $f = 1.0\text{ kHz}$)	h_{re}	— —	8.0 4.0	$\times 10^{-4}$
				MPS2222A MPS2222A
Small–Signal Current Gain ($I_C = 1.0\text{ mAdc}$, $V_{CE} = 10\text{ Vdc}$, $f = 1.0\text{ kHz}$) ($I_C = 10\text{ mAdc}$, $V_{CE} = 10\text{ Vdc}$, $f = 1.0\text{ kHz}$)	h_{fe}	50 75	300 375	—
				MPS2222A MPS2222A
Output Admittance ($I_C = 1.0\text{ mAdc}$, $V_{CE} = 10\text{ Vdc}$, $f = 1.0\text{ kHz}$) ($I_C = 10\text{ mAdc}$, $V_{CE} = 10\text{ Vdc}$, $f = 1.0\text{ kHz}$)	h_{oe}	5.0 25	35 200	μmhos
				MPS2222A MPS2222A
Collector Base Time Constant ($I_E = 20\text{ mAdc}$, $V_{CB} = 20\text{ Vdc}$, $f = 31.8\text{ MHz}$)	$r_b' C_C$	—	150	ps
				MPS2222A
Noise Figure ($I_C = 100\text{ }\mu\text{A}$, $V_{CE} = 10\text{ Vdc}$, $R_S = 1.0\text{ k}\Omega$, $f = 1.0\text{ kHz}$)	NF	—	4.0	dB
				MPS2222A

SWITCHING CHARACTERISTICS MPS2222A only

Delay Time	$(V_{CC} = 30\text{ Vdc}$, $V_{BE(off)} = -0.5\text{ Vdc}$, $I_C = 150\text{ mAdc}$, $I_{B1} = 15\text{ mAdc}$) (Figure 1)	t_d	—	10	ns
Rise Time		t_r	—	25	ns
Storage Time	$(V_{CC} = 30\text{ Vdc}$, $I_C = 150\text{ mAdc}$, $I_{B1} = I_{B2} = 15\text{ mAdc}$) (Figure 2)	t_s	—	225	ns
Fall Time		t_f	—	60	ns

1. Pulse Test: Pulse Width $\leq 300\text{ }\mu\text{s}$, Duty Cycle $\leq 2.0\%$.2. f_T is defined as the frequency at which $|h_{fe}|$ extrapolates to unity.

SWITCHING TIME EQUIVALENT TEST CIRCUITS

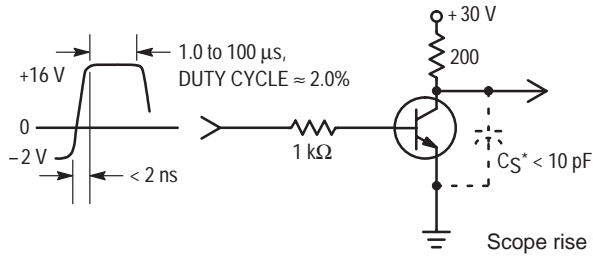


Figure 1. Turn-On Time

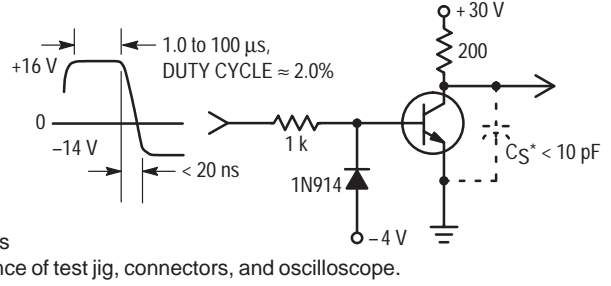


Figure 2. Turn-Off Time

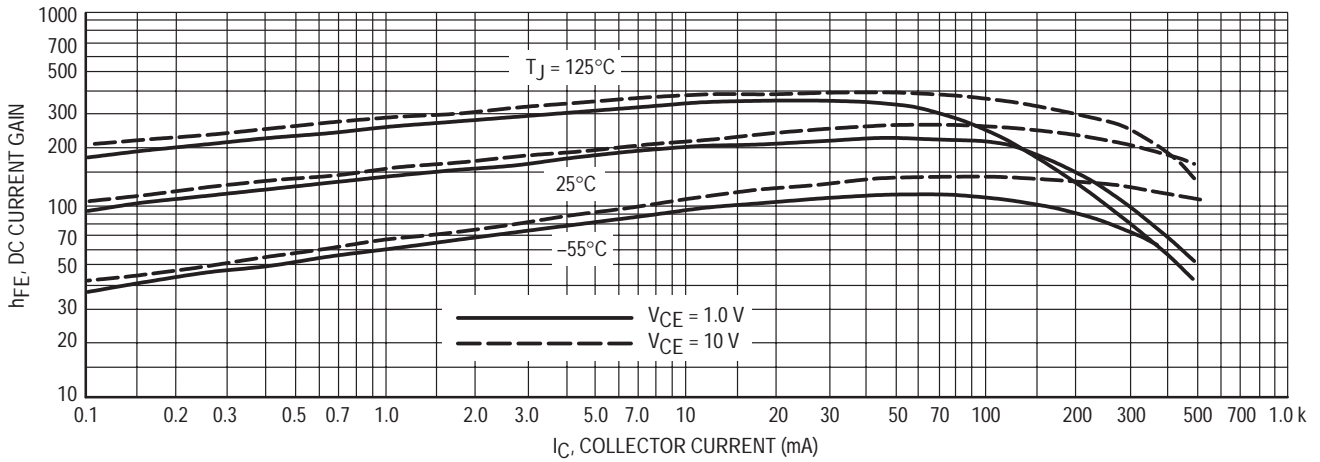


Figure 3. DC Current Gain

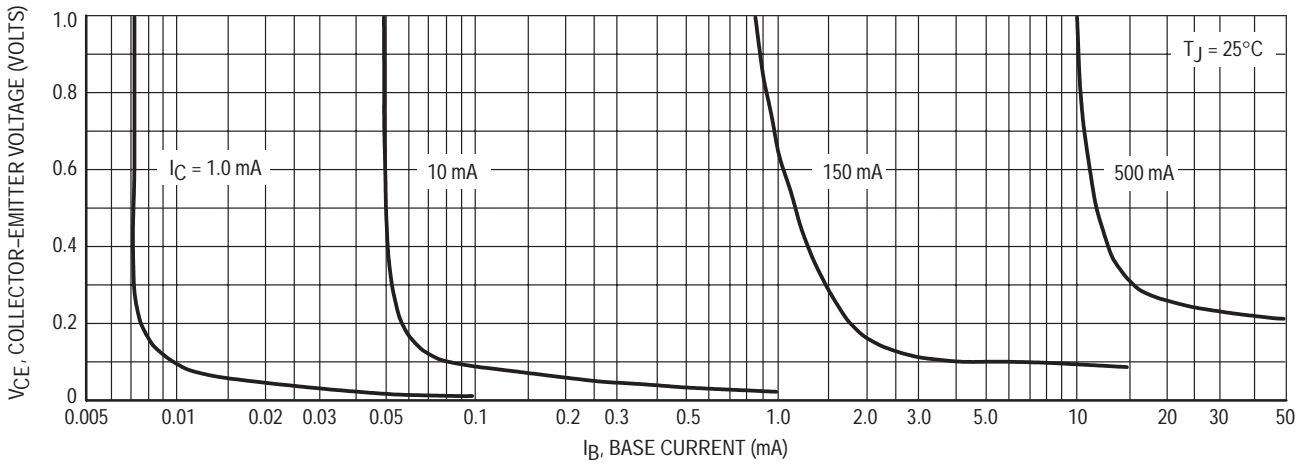


Figure 4. Collector Saturation Region

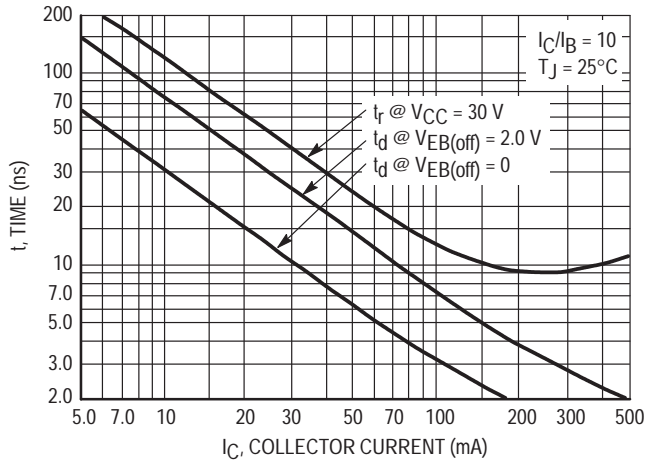


Figure 5. Turn-On Time

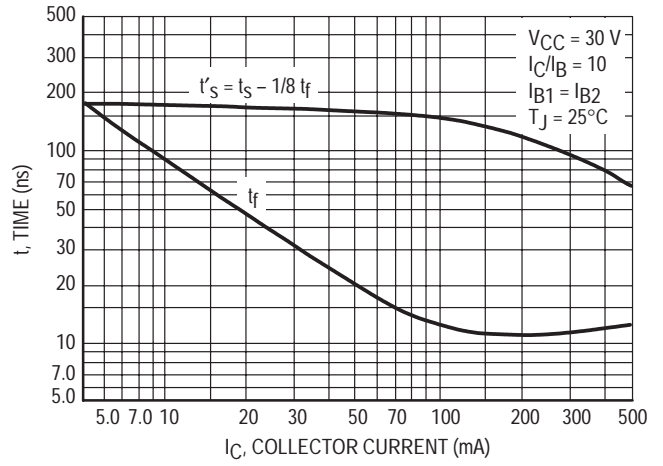


Figure 6. Turn-Off Time

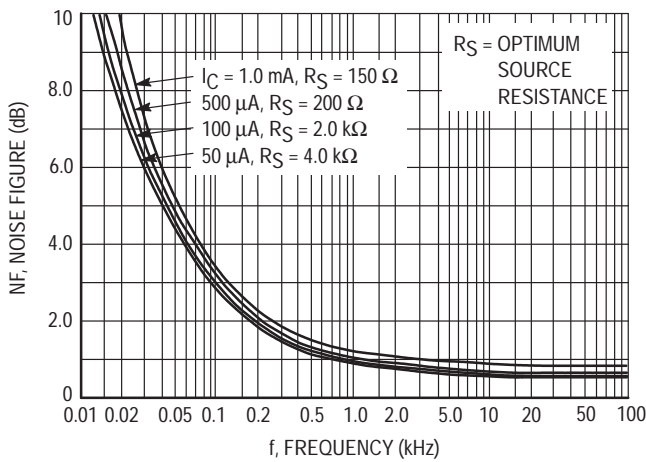


Figure 7. Frequency Effects

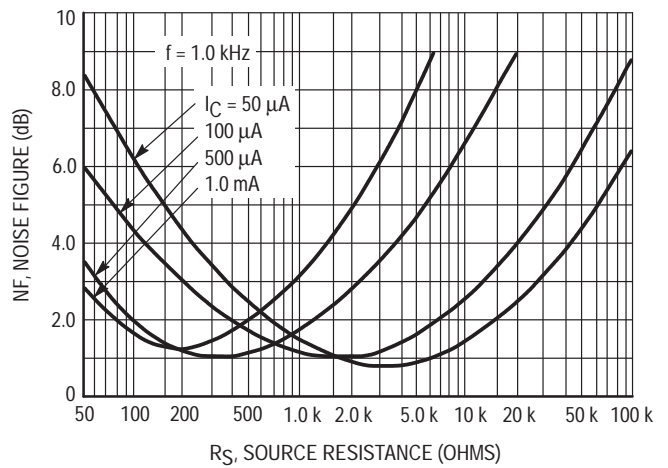


Figure 8. Source Resistance Effects

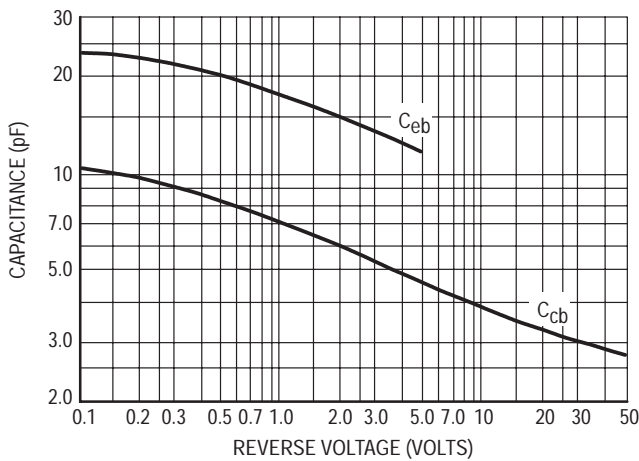


Figure 9. Capacitances

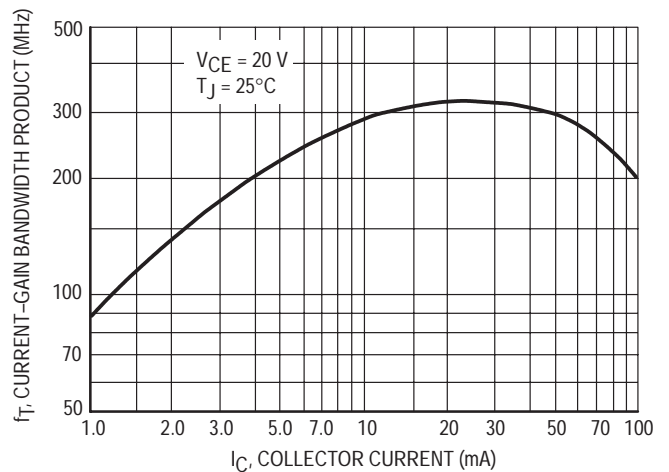


Figure 10. Current-Gain Bandwidth Product

MPS2222 MPS2222A

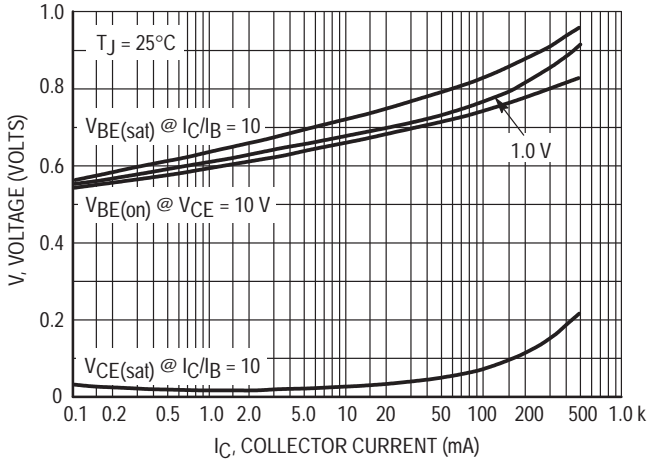


Figure 11. "On" Voltages

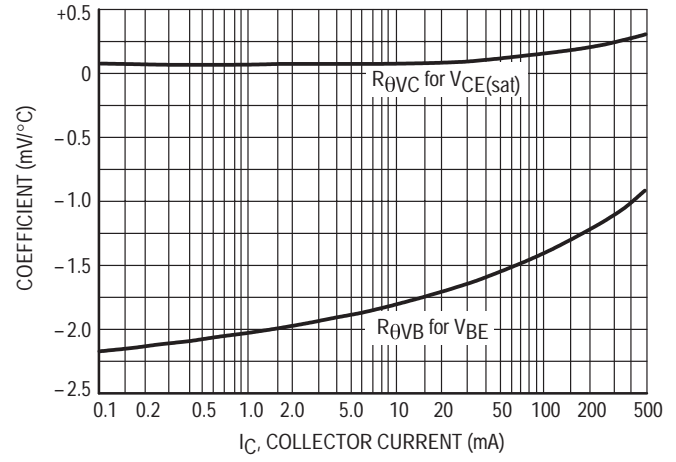


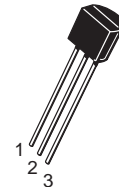
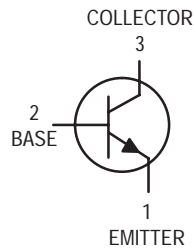
Figure 12. Temperature Coefficients

Switching Transistors

NPN Silicon

MPS2369
MPS2369A*

*Motorola Preferred Device



CASE 29-04, STYLE 1
TO-92 (TO-226AA)

MAXIMUM RATINGS

Rating	Symbol	Value	Unit
Collector–Emitter Voltage	V_{CEO}	15	Vdc
Collector–Emitter Voltage	V_{CES}	40	Vdc
Collector–Base Voltage	V_{CBO}	40	Vdc
Emitter–Base Voltage	V_{EBO}	4.5	Vdc
Collector Current — Continuous	I_C	200	mAdc
Total Device Dissipation @ $T_A = 25^\circ\text{C}$ Derate above 25°C	P_D	625 5.0	mW mW/ $^\circ\text{C}$
Operating and Storage Junction Temperature Range	T_J, T_{stg}	-55 to +150	$^\circ\text{C}$

THERMAL CHARACTERISTICS

Characteristic	Symbol	Max	Unit
Thermal Resistance, Junction to Ambient	$R_{\theta JA}$	200	$^\circ\text{C/W}$

ELECTRICAL CHARACTERISTICS ($T_A = 25^\circ\text{C}$ unless otherwise noted)

Characteristic	Symbol	Min	Typ	Max	Unit
----------------	--------	-----	-----	-----	------

OFF CHARACTERISTICS

Collector–Emitter Breakdown Voltage ⁽¹⁾ ($I_C = 10\text{ mAdc}, I_B = 0$)	MPS2369A	$V_{(BR)CEO}$	15	—	—	Vdc
Collector–Emitter Breakdown Voltage ($I_C = 10\ \mu\text{Adc}, V_{BE} = 0$)	MPS2369,A	$V_{(BR)CES}$	40	—	—	Vdc
Collector–Base Breakdown Voltage ($I_C = 10\ \mu\text{Adc}, I_E = 0$)	MPS2369,A	$V_{(BR)CBO}$	40	—	—	Vdc
Emitter–Base Breakdown Voltage ($I_E = 10\ \mu\text{Adc}, I_C = 0$)	MPS2369,A	$V_{(BR)EBO}$	4.5	—	—	Vdc
Collector Cutoff Current ($V_{CB} = 20\text{ Vdc}, I_E = 0$) ($V_{CB} = 20\text{ Vdc}, I_E = 0, T_A = 125^\circ\text{C}$)	MPS2369,A	I_{CBO}	— —	— —	0.4 30	μAdc
Collector Cutoff Current ($V_{CE} = 20\text{ Vdc}, V_{BE} = 0$)	MPS2369,A	I_{CES}	—	—	0.4	μAdc

1. Pulse Test: Pulse Width $\leq 300\ \mu\text{s}$, Duty Cycle $\leq 2.0\%$.

Preferred devices are Motorola recommended choices for future use and best overall value.

MPS2369 MPS2369A

ELECTRICAL CHARACTERISTICS ($T_A = 25^\circ\text{C}$ unless otherwise noted) (Continued)

Characteristic	Symbol	Min	Typ	Max	Unit	
ON CHARACTERISTICS						
DC Current Gain ⁽¹⁾ ($I_C = 10\text{ mA}$, $V_{CE} = 1.0\text{ Vdc}$) ($I_C = 10\text{ mA}$, $V_{CE} = 1.0\text{ Vdc}$, $T_A = -55^\circ\text{C}$) ($I_C = 10\text{ mA}$, $V_{CE} = 1.0\text{ Vdc}$) ($I_C = 10\text{ mA}$, $V_{CE} = 0.35\text{ Vdc}$) ($I_C = 10\text{ mA}$, $V_{CE} = 0.35\text{ Vdc}$, $T_A = -55^\circ\text{C}$) ($I_C = 30\text{ mA}$, $V_{CE} = 0.4\text{ Vdc}$) ($I_C = 100\text{ mA}$, $V_{CE} = 2.0\text{ Vdc}$) ($I_C = 100\text{ mA}$, $V_{CE} = 1.0\text{ Vdc}$)	MPS2369A MPS2369 MPS2369 MPS2369A MPS2369A MPS2369A MPS2369 MPS2369A	h_{FE}	— 20 40 40 20 30 20 20	— — — — — — — —	120 — 120 — — — — —	—
Collector–Emitter Saturation Voltage ⁽¹⁾ ($I_C = 10\text{ mA}$, $I_B = 1.0\text{ mA}$) ($I_C = 10\text{ mA}$, $I_B = 1.0\text{ mA}$) ($I_C = 10\text{ mA}$, $I_B = 1.0\text{ mA}$, $T_A = +125^\circ\text{C}$) ($I_C = 30\text{ mA}$, $I_B = 3.0\text{ mA}$) ($I_C = 100\text{ mA}$, $I_B = 10\text{ mA}$)	MPS2369 MPS2369A MPS2369A MPS2369A MPS2369A	$V_{CE(sat)}$	— — — — —	— — — — —	0.25 0.20 0.30 0.25 0.50	Vdc
Base–Emitter Saturation Voltage ⁽¹⁾ ($I_C = 10\text{ mA}$, $I_B = 1.0\text{ mA}$) ($I_C = 10\text{ mA}$, $I_B = 1.0\text{ mA}$, $T_A = +125^\circ\text{C}$) ($I_C = 10\text{ mA}$, $I_B = 1.0\text{ mA}$, $T_A = -55^\circ\text{C}$) ($I_C = 30\text{ mA}$, $I_B = 3.0\text{ mA}$) ($I_C = 100\text{ mA}$, $I_B = 10\text{ mA}$)	MPS2369 MPS2369A MPS2369A MPS2369A MPS2369A	$V_{BE(sat)}$	0.7 0.5 — — —	— — — — —	0.85 — 1.02 1.15 1.60	Vdc

SMALL–SIGNAL CHARACTERISTICS

Output Capacitance ($V_{CB} = 5.0\text{ Vdc}$, $I_E = 0$, $f = 1.0\text{ MHz}$)	MPS2369,A	C_{obo}	—	—	4.0	pF
Small–Signal Current Gain ($I_C = 10\text{ mA}$, $V_{CE} = 10\text{ Vdc}$, $f = 100\text{ MHz}$)	MPS2369,A	h_{fe}	5.0	—	—	—

SWITCHING CHARACTERISTICS

Storage Time ($I_{B1} = I_{B2} = I_C = 10\text{ mA}$) (Figure 3)	MPS2369,A	t_s	—	5.0	13	ns
Turn–On Time ($V_{CC} = 3.0\text{ Vdc}$, $I_C = 10\text{ mA}$, $I_{B1} = 3.0\text{ mA}$) (Figure 1)	MPS2369,A	t_{on}	—	8.0	12	ns
Turn–Off Time ($V_{CC} = 3.0\text{ Vdc}$, $I_C = 10\text{ mA}$, $I_{B1} = 3.0\text{ mA}$, $I_{B2} = 1.5\text{ mA}$) (Figure 2)	MPS2369,A	t_{off}	—	10	18	ns

1. Pulse Test: Pulse Width $\leq 300\ \mu\text{s}$, Duty Cycle $\leq 2.0\%$.

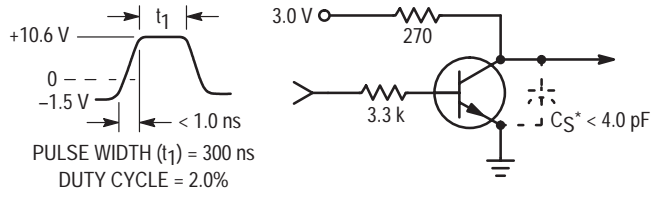


Figure 1. t_{on} Circuit

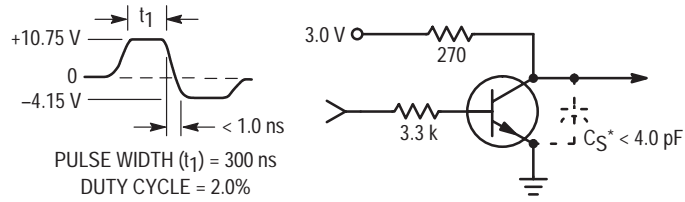


Figure 2. t_{off} Circuit

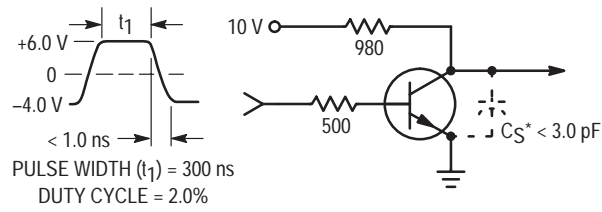
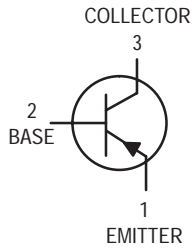


Figure 3. Storage Test Circuit

* Total shunt capacitance of test jig and connectors.

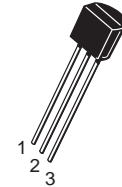
General Purpose Transistors

PNP Silicon



MPS2907 MPS2907A*

*Motorola Preferred Device



CASE 29-04, STYLE 1
TO-92 (TO-226AA)

MAXIMUM RATINGS

Rating	Symbol	MPS2907	MPS2907A	Unit
Collector–Emitter Voltage	V_{CEO}	-40	-60	Vdc
Collector–Base Voltage	V_{CBO}	-60		Vdc
Emitter–Base Voltage	V_{EBO}	-5.0		Vdc
Collector Current — Continuous	I_C	-600		mAdc
Total Device Dissipation @ $T_A = 25^\circ\text{C}$ Derate above 25°C	P_D	625	5.0	mW mW/ $^\circ\text{C}$
Total Device Dissipation @ $T_C = 25^\circ\text{C}$ Derate above 25°C	P_D	1.5	12	Watts mW/ $^\circ\text{C}$
Operating and Storage Junction Temperature Range	T_J, T_{stg}	-500 to +150		$^\circ\text{C}$

THERMAL CHARACTERISTICS

Characteristic	Symbol	Max	Unit
Thermal Resistance, Junction to Ambient	$R_{\theta JA}$	200	$^\circ\text{C}/\text{W}$
Thermal Resistance, Junction to Case	$R_{\theta JC}$	83.3	$^\circ\text{C}/\text{W}$

ELECTRICAL CHARACTERISTICS ($T_A = 25^\circ\text{C}$ unless otherwise noted)

Characteristic	Symbol	Min	Max	Unit
----------------	--------	-----	-----	------

OFF CHARACTERISTICS

Collector–Emitter Breakdown Voltage ⁽¹⁾ ($I_C = -10 \text{ mAdc}, I_E = 0$)	MPS2907 MPS2907A	$V_{(BR)CEO}$	-40 -60	— —	Vdc
Collector–Base Breakdown Voltage ($I_C = -10 \mu\text{Adc}, I_E = 0$)		$V_{(BR)CBO}$	-60	—	Vdc
Emitter–Base Breakdown Voltage ($I_E = -10 \mu\text{Adc}, I_C = 0$)		$V_{(BR)EBO}$	-5.0	—	Vdc
Collector Cutoff Current ($V_{CE} = -30 \text{ Vdc}, V_{EB(off)} = -0.5 \text{ Vdc}$)		I_{CEX}	—	-50	nAdc
Collector Cutoff Current ($V_{CB} = -50 \text{ Vdc}, I_E = 0$)	MPS2907 MPS2907A	I_{CBO}	— —	-0.02 -0.01	μAdc
($V_{CB} = -50 \text{ Vdc}, I_E = 0, T_A = 150^\circ\text{C}$)	MPS2907 MPS2907A		— —	-20 -10	
Base Current ($V_{CE} = -30 \text{ Vdc}, V_{EB(off)} = -0.5 \text{ Vdc}$)		I_B	—	-50	nAdc

1. Pulse Test: Pulse Width $\leq 300 \mu\text{s}$, Duty Cycle $\leq 2.0\%$.

Preferred devices are Motorola recommended choices for future use and best overall value.

ELECTRICAL CHARACTERISTICS ($T_A = 25^\circ\text{C}$ unless otherwise noted) (Continued)

Characteristic	Symbol	Min	Max	Unit	
ON CHARACTERISTICS					
DC Current Gain ($I_C = -0.1\text{ mAdc}$, $V_{CE} = -10\text{ Vdc}$)	h_{FE}	MPS2907	35	—	—
		MPS2907A	75	—	—
($I_C = -1.0\text{ mAdc}$, $V_{CE} = -10\text{ Vdc}$)		MPS2907	50	—	—
		MPS2907A	100	—	—
($I_C = -10\text{ mAdc}$, $V_{CE} = -10\text{ Vdc}$)		MPS2907	75	—	—
	MPS2907A	100	—	—	
($I_C = -150\text{ mAdc}$, $V_{CE} = -10\text{ Vdc}$) ⁽¹⁾ ($I_C = -500\text{ mAdc}$, $V_{CE} = -10\text{ Vdc}$) ⁽¹⁾	MPS2907, MPS2907A	100	300	—	
	MPS2907	30	—	—	
	MPS2907A	50	—	—	
Collector–Emitter Saturation Voltage ⁽¹⁾ ($I_C = -150\text{ mAdc}$, $I_B = -15\text{ mAdc}$) ($I_C = -500\text{ mAdc}$, $I_B = -50\text{ mAdc}$)	$V_{CE(sat)}$	—	-0.4 -1.6	Vdc	
Base–Emitter Saturation Voltage ⁽¹⁾ ($I_C = -150\text{ mAdc}$, $I_B = -15\text{ mAdc}$) ($I_C = -500\text{ mAdc}$, $I_B = -50\text{ mAdc}$)	$V_{BE(sat)}$	—	-1.3 -2.6	Vdc	

SMALL–SIGNAL CHARACTERISTICS

Current–Gain — Bandwidth Product ^{(1), (2)} ($I_C = -50\text{ mAdc}$, $V_{CE} = -20\text{ Vdc}$, $f = 100\text{ MHz}$)	f_T	200	—	MHz
Output Capacitance ($V_{CB} = -10\text{ Vdc}$, $I_E = 0$, $f = 1.0\text{ MHz}$)	C_{obo}	—	8.0	pF
Input Capacitance ($V_{EB} = -2.0\text{ Vdc}$, $I_C = 0$, $f = 1.0\text{ MHz}$)	C_{ibo}	—	30	pF

SWITCHING CHARACTERISTICS

Turn–On Time	$(V_{CC} = -30\text{ Vdc}$, $I_C = -150\text{ mAdc}$, $I_{B1} = -15\text{ mAdc}$) (Figures 1 and 5)	t_{on}	—	45	ns
Delay Time		t_d	—	10	ns
Rise Time		t_r	—	40	ns
Turn–Off Time	$(V_{CC} = -6.0\text{ Vdc}$, $I_C = -150\text{ mAdc}$, $I_{B1} = I_{B2} = 15\text{ mAdc}$) (Figure 2)	t_{off}	—	100	ns
Storage Time		t_s	—	80	ns
Fall Time		t_f	—	30	ns

1. Pulse Test: Pulse Width $\leq 300\ \mu\text{s}$, Duty Cycle $\leq 2.0\%$.
2. f_T is defined as the frequency at which $|h_{fe}|$ extrapolates to unity.

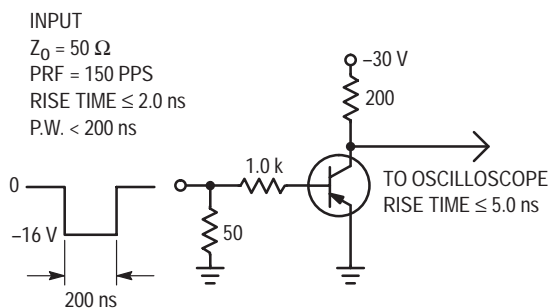


Figure 1. Delay and Rise Time Test Circuit

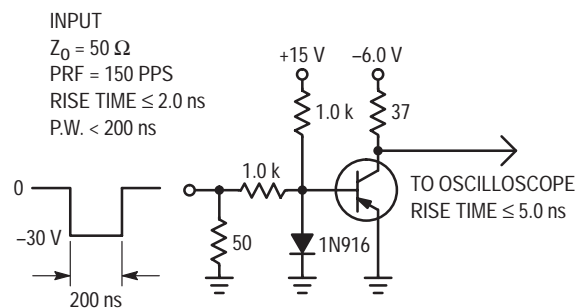


Figure 2. Storage and Fall Time Test Circuit

TYPICAL CHARACTERISTICS

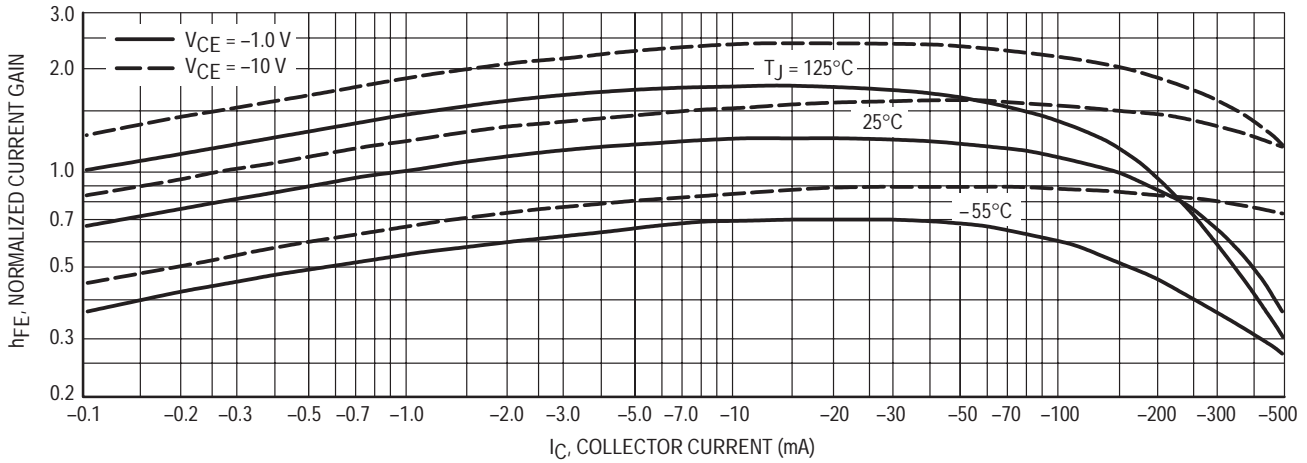


Figure 3. DC Current Gain

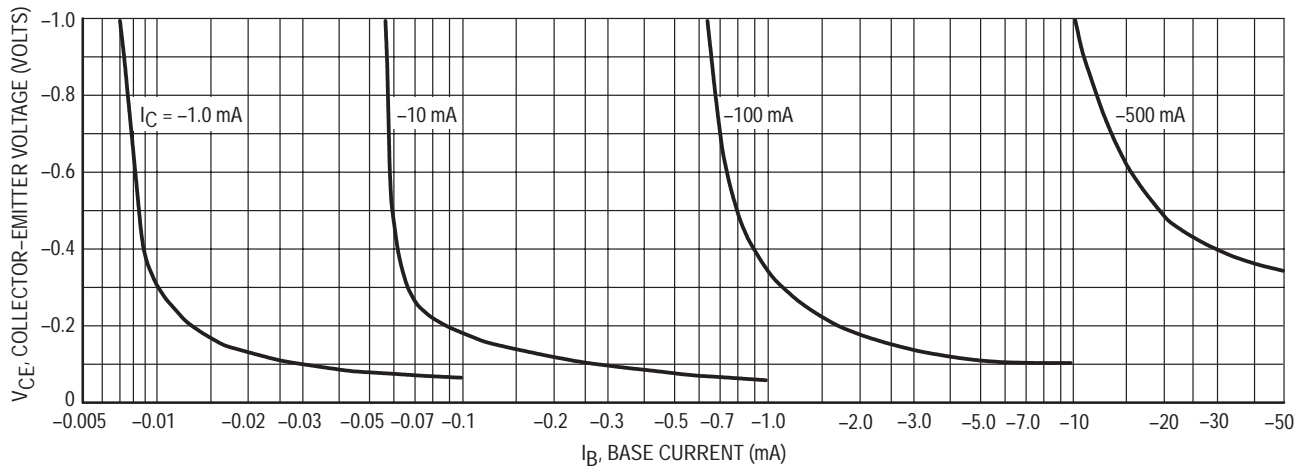


Figure 4. Collector Saturation Region

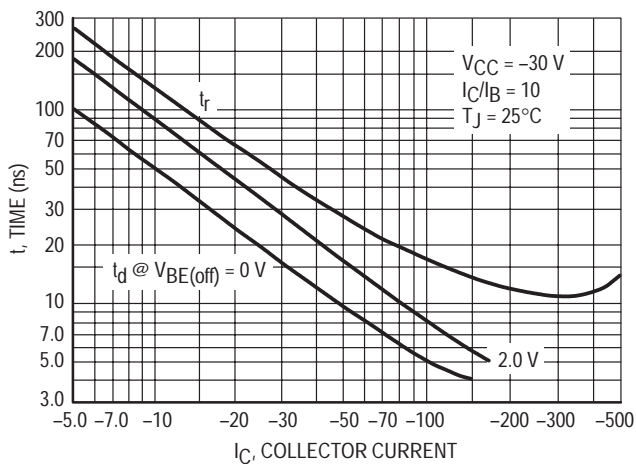


Figure 5. Turn-On Time

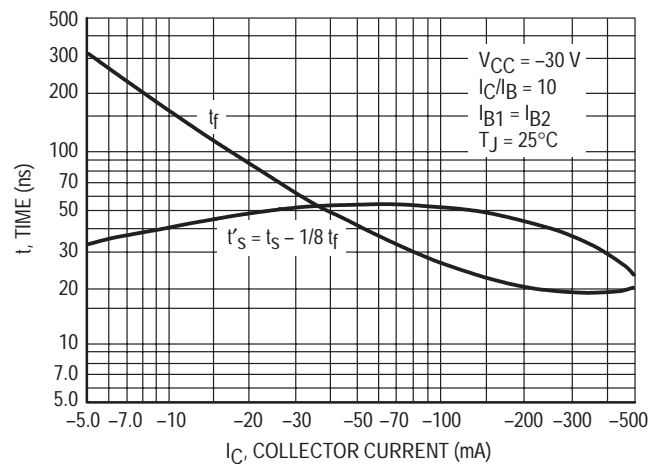


Figure 6. Turn-Off Time

TYPICAL SMALL-SIGNAL CHARACTERISTICS

NOISE FIGURE

$V_{CE} = 10 \text{ Vdc}$, $T_A = 25^\circ\text{C}$

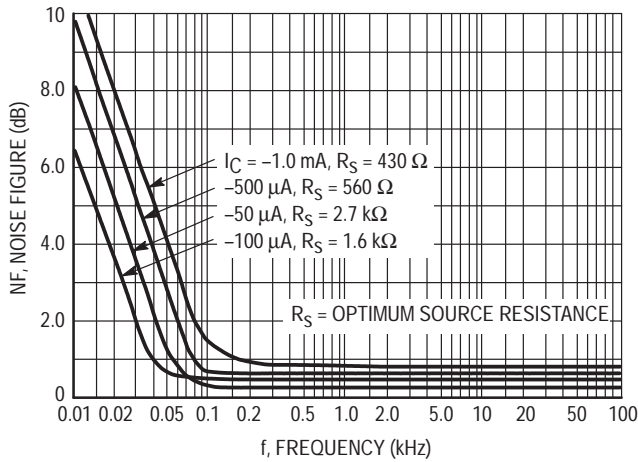


Figure 7. Frequency Effects

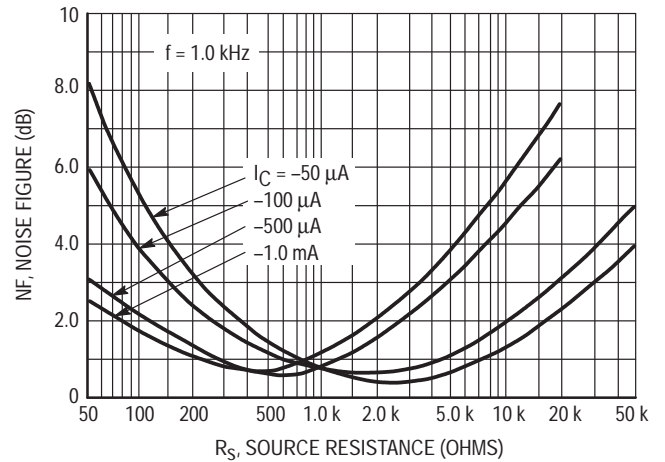


Figure 8. Source Resistance Effects

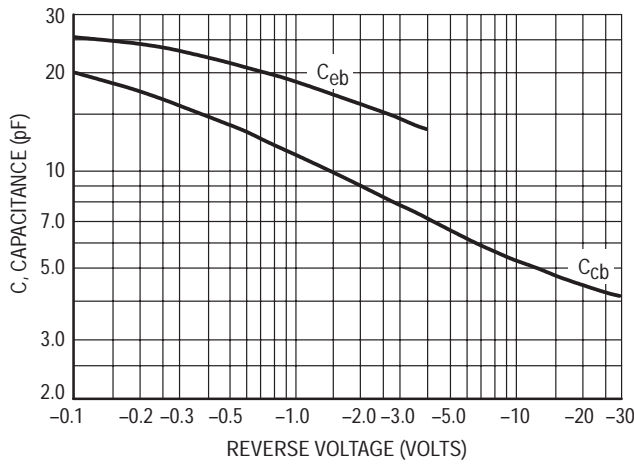


Figure 9. Capacitances

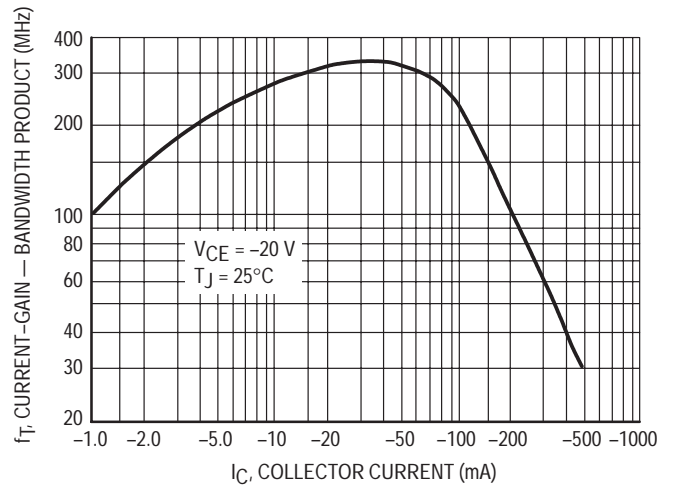


Figure 10. Current-Gain — Bandwidth Product

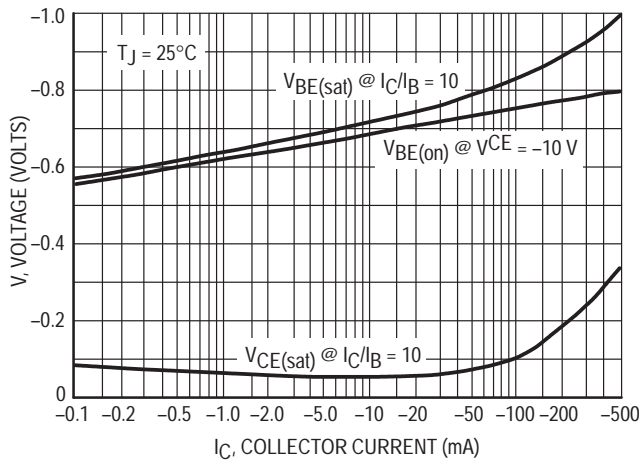


Figure 11. "On" Voltage

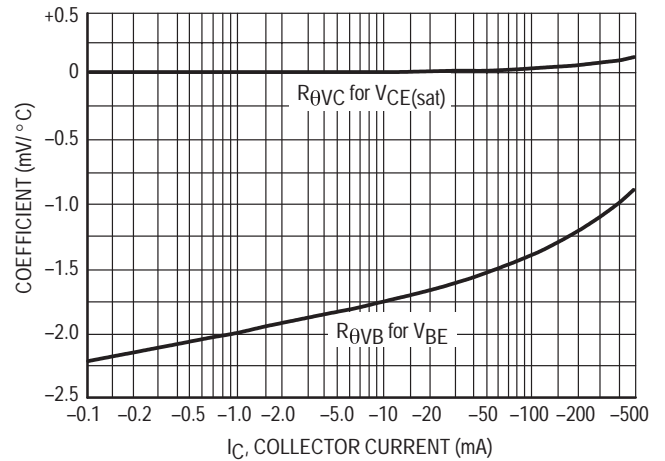
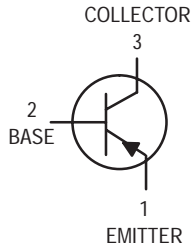


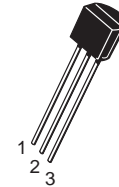
Figure 12. Temperature Coefficients

Switching Transistor

PNP Silicon



MPS3638A



CASE 29-04, STYLE 1
TO-92 (TO-226AA)

MAXIMUM RATINGS

Rating	Symbol	Value	Unit
Collector–Emitter Voltage	V_{CEO}	–25	Vdc
Collector–Emitter Voltage	V_{CES}	–25	Vdc
Collector–Base Voltage	V_{CBO}	–25	Vdc
Emitter–Base Voltage	V_{EBO}	–4.0	Vdc
Collector Current — Continuous	I_C	–500	mAdc
Total Device Dissipation @ $T_A = 25^\circ\text{C}$ Derate above 25°C	P_D	625 5.0	mW mW/ $^\circ\text{C}$
Total Device Dissipation @ $T_C = 25^\circ\text{C}$ Derate above 25°C	P_D	1.5 12	Watts mW/ $^\circ\text{C}$
Operating and Storage Junction Temperature Range	T_J, T_{stg}	–55 to +150	$^\circ\text{C}$

THERMAL CHARACTERISTICS

Characteristic	Symbol	Max	Unit
Thermal Resistance, Junction to Ambient	$R_{\theta JA}^{(1)}$	200	$^\circ\text{C}/\text{W}$
Thermal Resistance, Junction to Case	$R_{\theta JC}$	83.3	$^\circ\text{C}/\text{W}$

ELECTRICAL CHARACTERISTICS ($T_A = 25^\circ\text{C}$ unless otherwise noted)

Characteristic	Symbol	Min	Max	Unit
----------------	--------	-----	-----	------

OFF CHARACTERISTICS

Collector–Emitter Breakdown Voltage ($I_C = -100 \mu\text{Adc}$, $V_{BE} = 0$)	$V_{(BR)CES}$	–25	—	Vdc
Collector–Emitter Sustaining Voltage ⁽²⁾ ($I_C = -10 \text{ mAdc}$, $I_B = 0$)	$V_{CEO(sus)}$	–25	—	Vdc
Collector–Base Breakdown Voltage ($I_C = -100 \mu\text{Adc}$, $I_E = 0$)	$V_{(BR)CBO}$	–25	—	Vdc
Emitter–Base Breakdown Voltage ($I_E = -100 \mu\text{Adc}$, $I_C = 0$)	$V_{(BR)EBO}$	–4.0	—	Vdc
Collector Cutoff Current ($V_{CE} = -15 \text{ Vdc}$, $V_{BE} = 0$) ($V_{CE} = -15 \text{ Vdc}$, $V_{BE} = 0$, $T_A = -65^\circ\text{C}$)	I_{CES}	—	–0.035 –2.0	μAdc
Emitter Cutoff Current ($V_{EB} = -3.0 \text{ V}$, $I_C = 0$)	I_{EBO}	—	–35	nA
Base Current ($V_{CE} = -15 \text{ Vdc}$, $V_{BE} = 0$)	I_B	—	–0.035	μAdc

- $R_{\theta JA}$ is measured with the device soldered into a typical printed circuit board.
- Pulse Test: Pulse Width $\leq 300 \mu\text{s}$; Duty Cycle $\leq 2.0\%$.

(Replaces MPS3638/D)

ELECTRICAL CHARACTERISTICS ($T_A = 25^\circ\text{C}$ unless otherwise noted) (Continued)

Characteristic	Symbol	Min	Max	Unit
ON CHARACTERISTICS(2)				
DC Current Gain ($I_C = -1.0\text{ mAdc}$, $V_{CE} = -10\text{ Vdc}$) ($I_C = -10\text{ mAdc}$, $V_{CE} = -10\text{ Vdc}$) ($I_C = -50\text{ mAdc}$, $V_{CE} = -1.0\text{ Vdc}$) ($I_C = -300\text{ mAdc}$, $V_{CE} = -2.0\text{ Vdc}$)	h_{FE}	80 100 100 20	— — — —	—
Collector–Emitter Saturation Voltage ($I_C = -50\text{ mAdc}$, $I_B = -2.5\text{ mAdc}$) ($I_C = -300\text{ mAdc}$, $I_B = -30\text{ mAdc}$)	$V_{CE(sat)}$	— —	-0.25 -1.0	Vdc
Base–Emitter Saturation Voltage ($I_C = -50\text{ mAdc}$, $I_B = -2.5\text{ mAdc}$) ($I_C = -300\text{ mAdc}$, $I_B = -30\text{ mAdc}$)	$V_{BE(sat)}$	— -0.80	-1.1 -2.0	Vdc

SMALL–SIGNAL CHARACTERISTICS

Current–Gain — Bandwidth Product ($V_{CE} = -3.0\text{ Vdc}$, $I_C = -50\text{ mAdc}$, $f = 100\text{ MHz}$)	f_T	150	—	MHz
Output Capacitance ($V_{CB} = -10\text{ Vdc}$, $I_E = 0$, $f = 1.0\text{ MHz}$)	C_{obo}	—	10	pF
Input Capacitance ($V_{EB} = -0.5\text{ Vdc}$, $I_C = 0$, $f = 1.0\text{ MHz}$)	C_{ibo}	—	25	pF
Input Impedance ($I_C = -10\text{ mAdc}$, $V_{CE} = -10\text{ Vdc}$, $f = 1.0\text{ kHz}$)	h_{ie}	—	2000	k Ω
Voltage Feedback Ratio ($I_C = -10\text{ mAdc}$, $V_{CE} = -10\text{ Vdc}$, $f = 1.0\text{ kHz}$)	h_{re}	—	15	$\times 10^{-4}$
Small–Signal Current Gain ($I_C = -10\text{ mAdc}$, $V_{CE} = -10\text{ Vdc}$, $f = 1.0\text{ kHz}$)	h_{fe}	100	—	—
Output Admittance ($I_C = -10\text{ mAdc}$, $V_{CE} = -10\text{ Vdc}$, $f = 1.0\text{ kHz}$)	h_{oe}	—	1.2	mmhos

SWITCHING CHARACTERISTICS

Delay Time	$(V_{CC} = -10\text{ Vdc}$, $I_C = -300\text{ mAdc}$, $I_{B1} = -30\text{ mAdc}$)	t_d	—	20	ns
Rise Time		t_r	—	70	ns
Storage Time	$(V_{CC} = -10\text{ Vdc}$, $I_C = -300\text{ mAdc}$, $I_{B1} = -30\text{ mAdc}$, $I_{B2} = -30\text{ mAdc}$)	t_s	—	140	ns
Fall Time		t_f	—	70	ns
Turn–On Time	$(I_C = -300\text{ mAdc}$, $I_{B1} = -30\text{ mAdc}$)	t_{on}	—	75	ns
Turn–Off Time	$(I_C = -300\text{ mAdc}$, $I_{B1} = -30\text{ mAdc}$, $I_{B2} = 30\text{ mAdc}$)	t_{off}	—	170	ns

2. Pulse Test: Pulse Width $\leq 300\ \mu\text{s}$; Duty Cycle $\leq 2.0\%$.

SWITCHING TIME EQUIVALENT TEST CIRCUIT

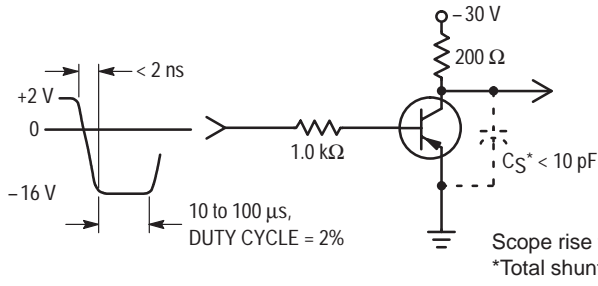


Figure 1. Turn-On Time

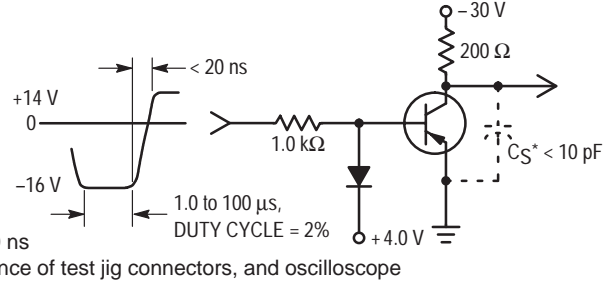


Figure 2. Turn-Off Time

TRANSIENT CHARACTERISTICS

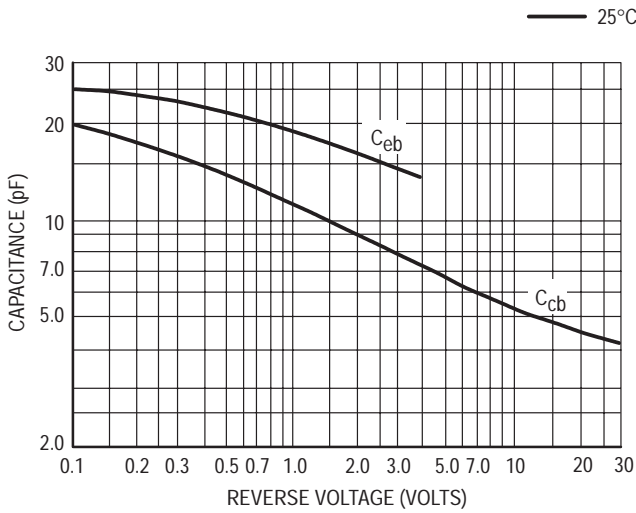


Figure 3. Capacitances

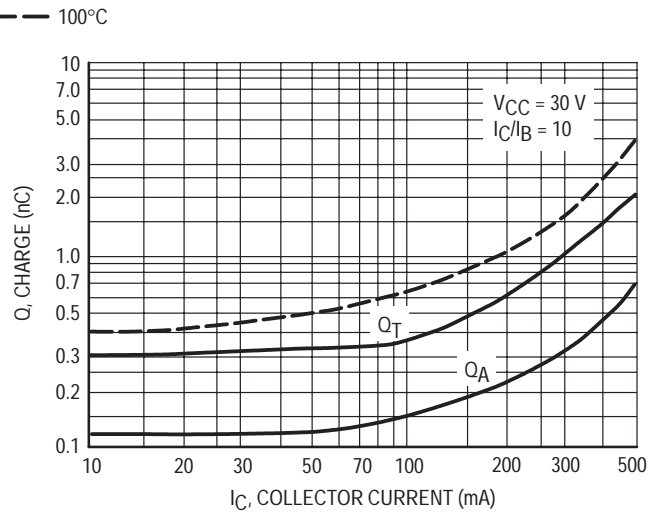


Figure 4. Charge Data

TRANSIENT CHARACTERISTICS (Continued)

— 25°C - - - 100°C

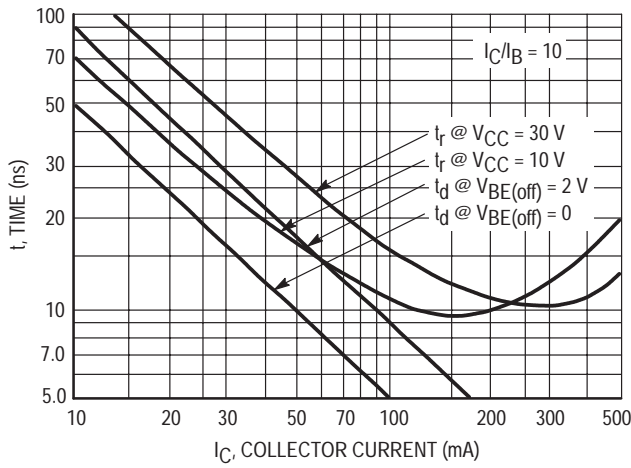


Figure 5. Turn-On Time

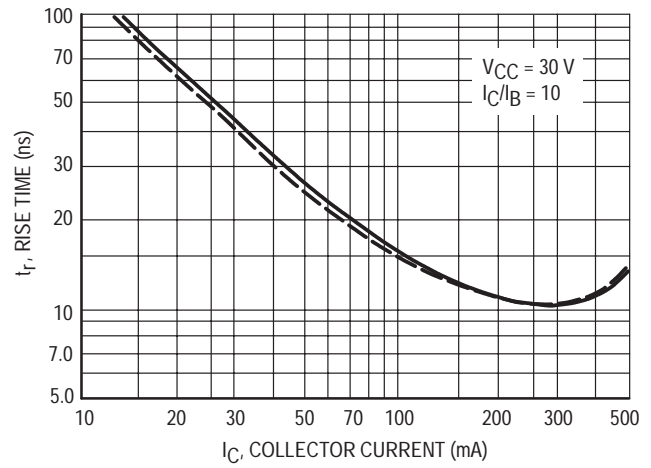


Figure 6. Rise Time

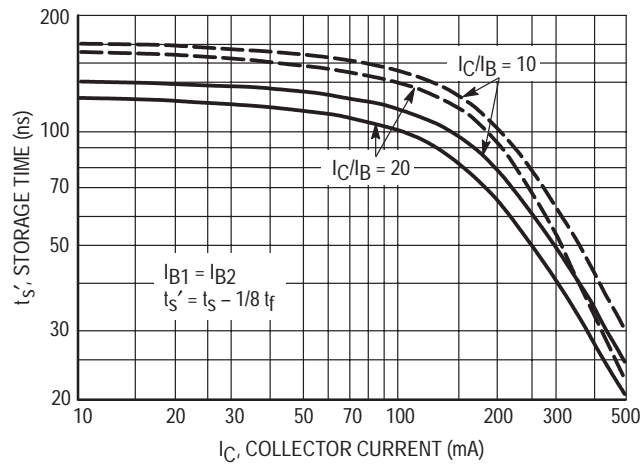


Figure 7. Storage Time

SMALL-SIGNAL CHARACTERISTICS

NOISE FIGURE

$V_{CE} = -10 \text{ Vdc}$, $T_A = 25^\circ\text{C}$

Bandwidth = 1.0 Hz

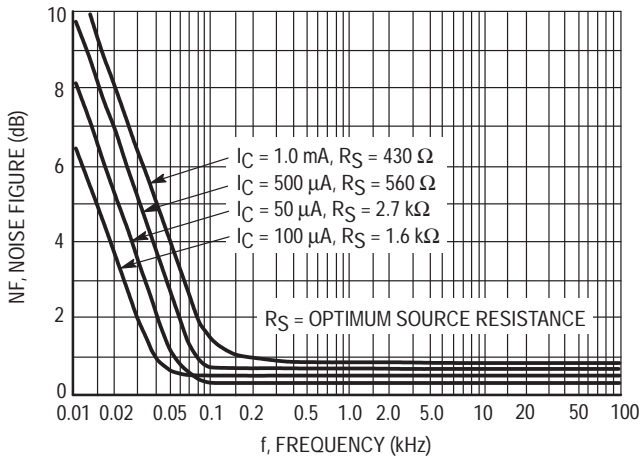


Figure 8. Frequency Effects

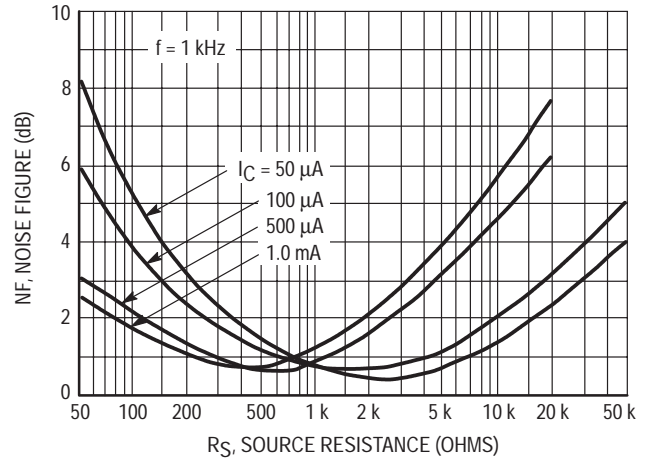


Figure 9. Source Resistance Effects

h PARAMETERS

$V_{CE} = -10 \text{ Vdc}$, $f = 1.0 \text{ kHz}$, $T_A = 25^\circ\text{C}$

This group of graphs illustrates the relationship between h_{fe} and other "h" parameters for this series of transistors. To obtain these curves, a high-gain and a low-gain unit were

selected from the 2N4402 line, and the same units were used to develop the correspondingly-numbered curves on each graph.

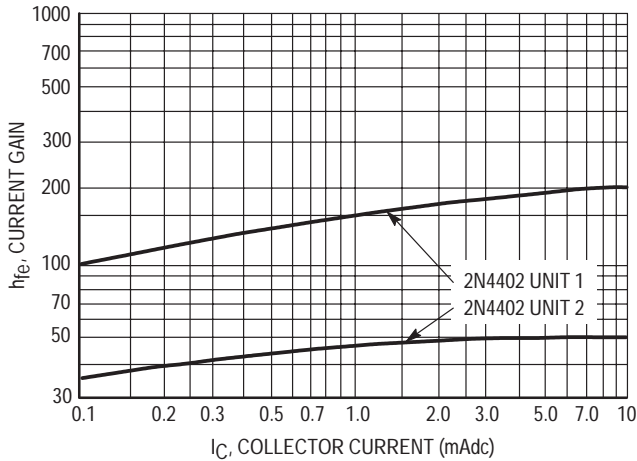


Figure 10. Current Gain

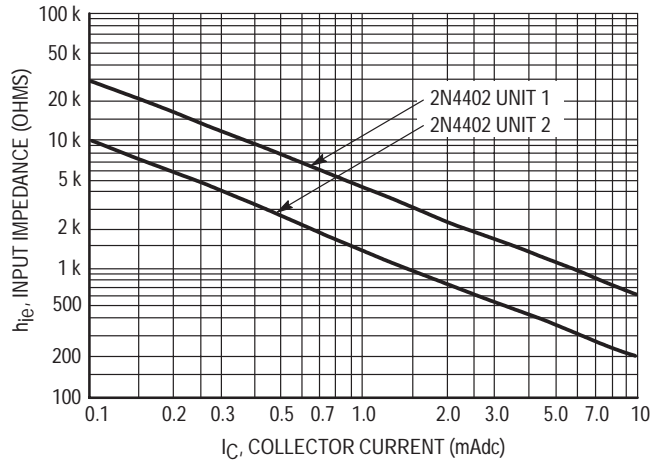


Figure 11. Input Impedance

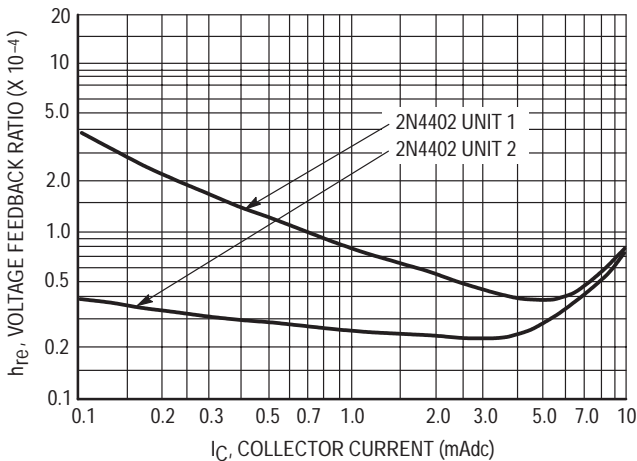


Figure 12. Voltage Feedback Ratio

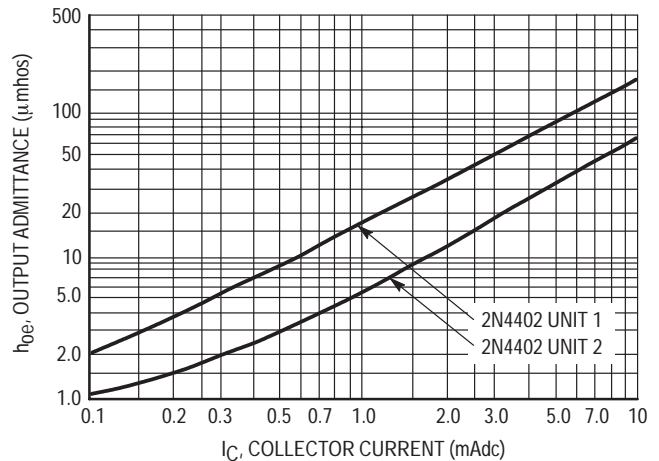


Figure 13. Output Admittance

STATIC CHARACTERISTICS

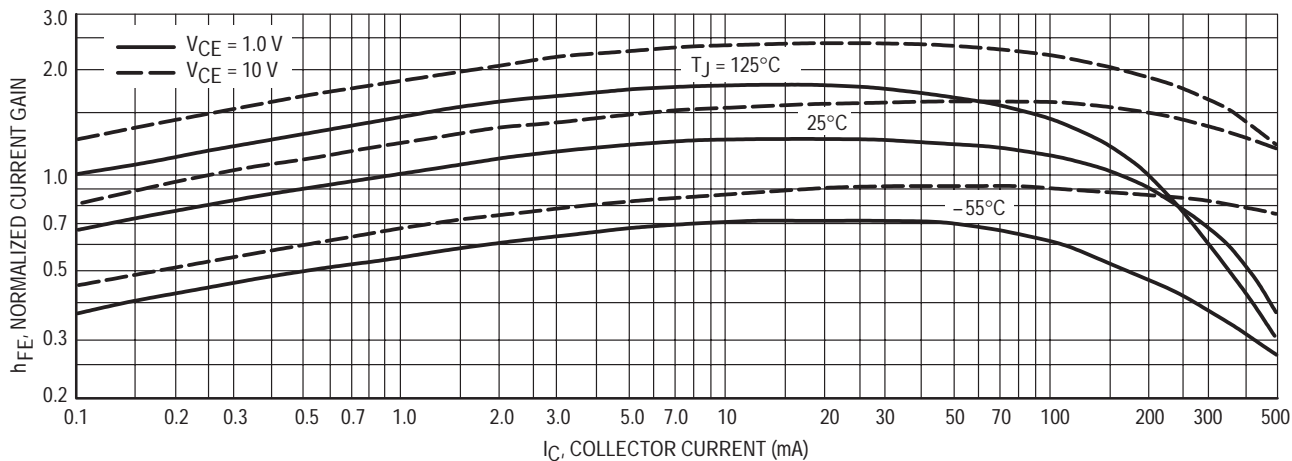


Figure 14. DC Current Gain

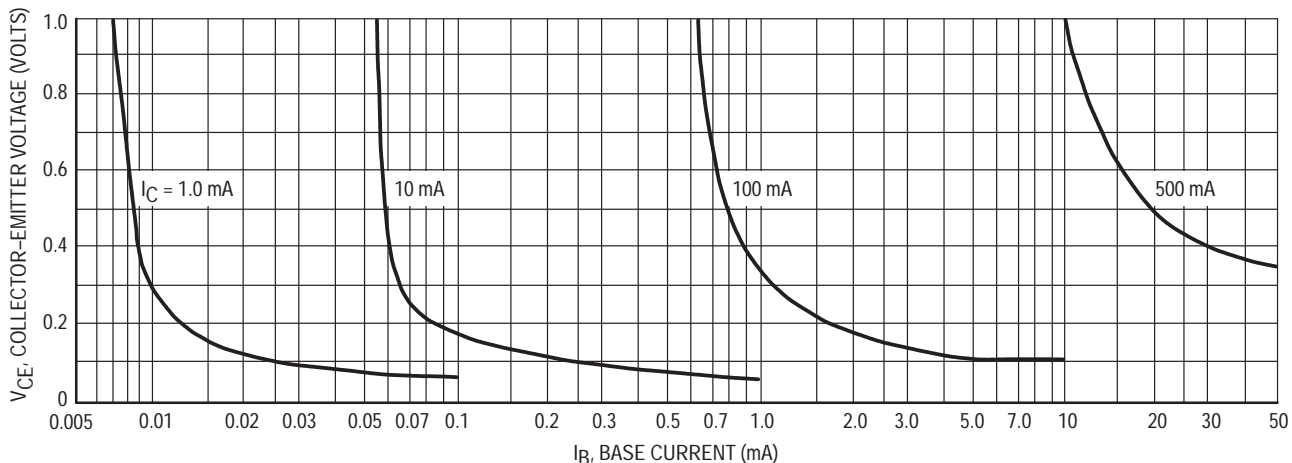


Figure 15. Collector Saturation Region

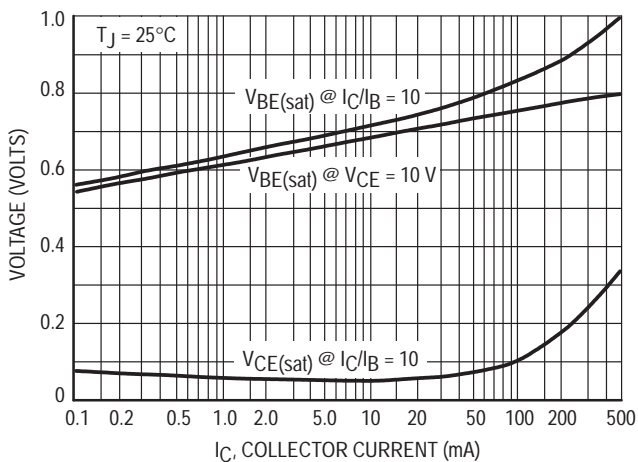


Figure 16. "On" Voltages

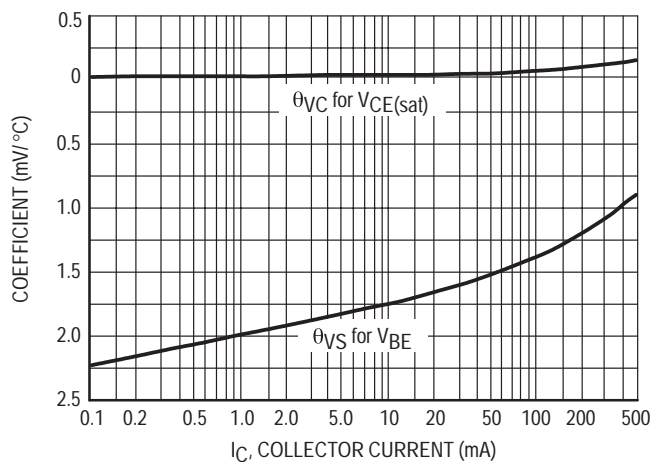
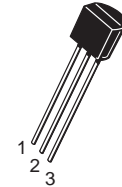
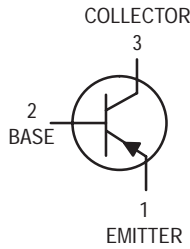


Figure 17. Temperature Coefficients

Switching Transistor

PNP Silicon

MPS3640



CASE 29-04, STYLE 1
TO-92 (TO-226AA)

MAXIMUM RATINGS

Rating	Symbol	Value	Unit
Collector–Emitter Voltage	V_{CEO}	-12	Vdc
Collector–Base Voltage	V_{CBO}	-12	Vdc
Emitter–Base Voltage	V_{EBO}	-4.0	Vdc
Collector Current — Continuous	I_C	-80	mAdc
Total Device Dissipation @ $T_A = 25^\circ\text{C}$ Derate above 25°C	P_D	625 5.0	mW mW/ $^\circ\text{C}$
Total Device Dissipation @ $T_C = 25^\circ\text{C}$ Derate above 25°C	P_D	1.5 12	Watts mW/ $^\circ\text{C}$
Operating and Storage Junction Temperature Range	T_J, T_{stg}	-55 to +150	$^\circ\text{C}$

THERMAL CHARACTERISTICS

Characteristic	Symbol	Max	Unit
Thermal Resistance, Junction to Ambient	$R_{\theta JA}$	200	$^\circ\text{C}/\text{W}$
Thermal Resistance, Junction to Case	$R_{\theta JC}$	83.3	$^\circ\text{C}/\text{W}$

ELECTRICAL CHARACTERISTICS ($T_A = 25^\circ\text{C}$ unless otherwise noted)

Characteristic	Symbol	Min	Max	Unit
----------------	--------	-----	-----	------

OFF CHARACTERISTICS

Collector–Emitter Breakdown Voltage ($I_C = -100 \mu\text{Adc}$, $V_{BE} = 0$)	$V_{(BR)CES}$	-12	—	Vdc
Collector–Emitter Sustaining Voltage ⁽¹⁾ ($I_C = -10 \text{mAdc}$, $I_B = 0$)	$V_{CEO(sus)}$	-12	—	Vdc
Collector–Base Breakdown Voltage ($I_C = -100 \mu\text{Adc}$, $I_E = 0$)	$V_{(BR)CBO}$	-12	—	Vdc
Emitter–Base Breakdown Voltage ($I_E = -100 \mu\text{Adc}$, $I_C = 0$)	$V_{(BR)EBO}$	-4.0	—	Vdc
Collector Cutoff Current ($V_{CE} = -6.0 \text{Vdc}$, $V_{BE} = 0$) ($V_{CE} = -6.0 \text{Vdc}$, $V_{BE} = 0$, $T_A = 65^\circ\text{C}$)	I_{CES}	—	-0.01 -1.0	μAdc
Base Current ($V_{CE} = -6.0 \text{Vdc}$, $V_{EB} = 0$)	I_B	—	-10	nAdc

1. Pulse Test: Pulse Width $\leq 300 \mu\text{s}$, Duty Cycle $\leq 2.0\%$.

ELECTRICAL CHARACTERISTICS ($T_A = 25^\circ\text{C}$ unless otherwise noted) (Continued)

Characteristic	Symbol	Min	Max	Unit
ON CHARACTERISTICS(1)				
DC Current Gain ($I_C = -10\text{ mA}$, $V_{CE} = -0.3\text{ Vdc}$) ($I_C = -50\text{ mA}$, $V_{CE} = -1.0\text{ Vdc}$)	h_{FE}	30 20	120 —	—
Collector–Emitter Saturation Voltage ($I_C = -10\text{ mA}$, $I_B = -1.0\text{ mA}$) ($I_C = -50\text{ mA}$, $I_B = -5.0\text{ mA}$) ($I_C = -10\text{ mA}$, $I_B = -1.0\text{ mA}$, $T_A = 65^\circ\text{C}$)	$V_{CE(sat)}$	— — —	— -0.2 -0.6 -0.25	Vdc
Base–Emitter Saturation Voltage ($I_C = -10\text{ mA}$, $I_B = -0.5\text{ mA}$) ($I_C = -10\text{ mA}$, $I_B = -1.0\text{ mA}$) ($I_C = -50\text{ mA}$, $I_B = -5.0\text{ mA}$)	$V_{BE(sat)}$	-0.75 -0.75 —	-0.95 -1.0 -1.5	Vdc

SMALL–SIGNAL CHARACTERISTICS

Current–Gain — Bandwidth Product ($I_C = -10\text{ mA}$, $V_{CE} = -5.0\text{ Vdc}$, $f = 100\text{ MHz}$)	f_T	500	—	MHz
Output Capacitance ($V_{CB} = -5.0\text{ Vdc}$, $I_E = 0$, $f = 1.0\text{ MHz}$)	C_{obo}	—	3.5	pF
Input Capacitance ($V_{EB} = -0.5\text{ Vdc}$, $I_C = 0$, $f = 1.0\text{ MHz}$)	C_{ibo}	—	3.5	pF

SWITCHING CHARACTERISTICS

Delay Time	($V_{CC} = -6.0\text{ Vdc}$, $I_C = -50\text{ mA}$, $V_{BE(off)} = -1.9\text{ Vdc}$, $I_{B1} = -5.0\text{ mA}$)	t_d	—	10	ns
Rise Time		t_r	—	30	ns
Storage Time	($V_{CC} = -6.0\text{ Vdc}$, $I_C = -50\text{ mA}$, $I_{B1} = I_{B2} = -5.0\text{ mA}$)	t_s	—	20	ns
Fall Time		t_f	—	12	ns
Turn–On Time ($V_{CC} = -6.0\text{ Vdc}$, $I_C = -50\text{ mA}$, $I_{B1} = -5.0\text{ mA}$) ($V_{CC} = -1.5\text{ Vdc}$, $I_C = -10\text{ mA}$, $I_{B1} = -0.5\text{ mA}$)	t_{on}	—	—	25	ns
—		—	—	60	
Turn–Off Time ($V_{CC} = -6.0\text{ Vdc}$, $I_C = -50\text{ mA}$, $I_{B1} = I_{B2} = -5.0\text{ mA}$) ($V_{CC} = -1.5\text{ Vdc}$, $I_C = -10\text{ mA}$, $I_{B1} = I_{B2} = -0.5\text{ mA}$)	t_{off}	—	—	35	ns
—		—	—	75	

1. Pulse Test: Pulse Width $\leq 300\ \mu\text{s}$, Duty Cycle $\leq 2.0\%$.

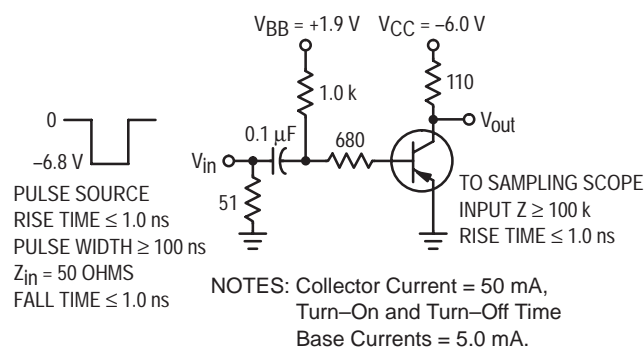


Figure 1.

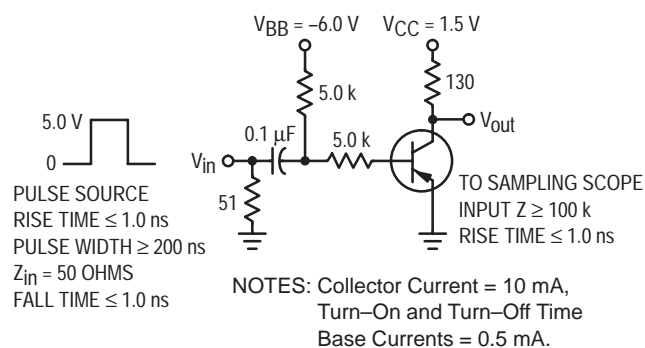


Figure 2.

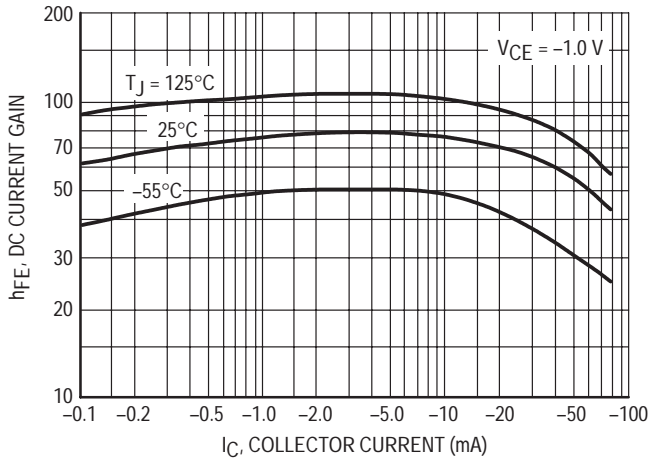


Figure 3. DC Current Gain

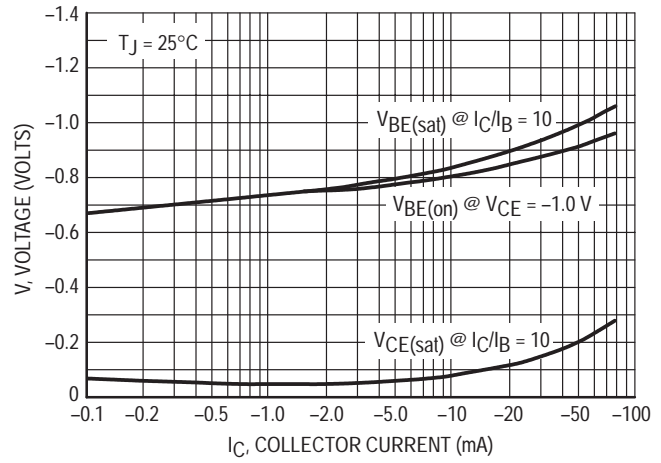


Figure 4. "On" Voltages

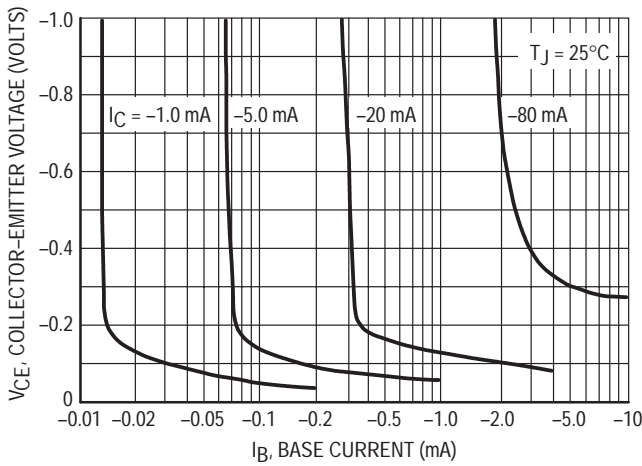


Figure 5. Collector Saturation Region

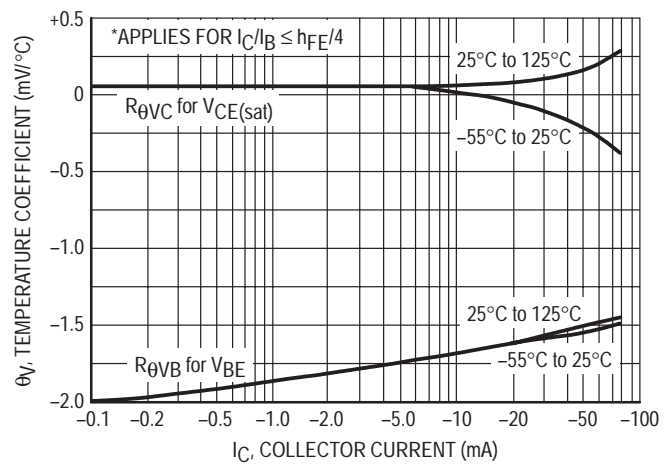


Figure 6. Temperature Coefficients

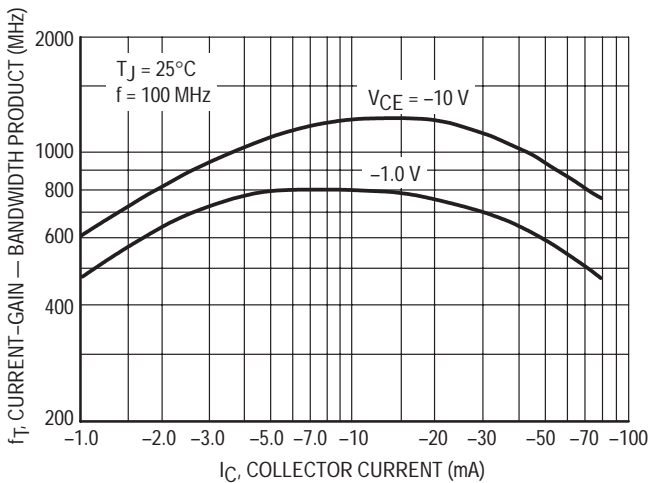


Figure 7. Current-Gain — Bandwidth Product

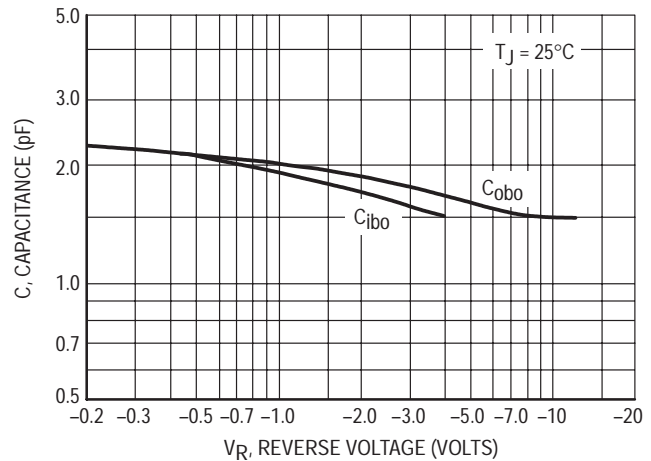


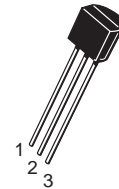
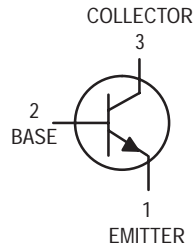
Figure 8. Capacitance

Switching Transistor

NPN Silicon

MPS3646

Motorola Preferred Device



CASE 29-04, STYLE 1
TO-92 (TO-226AA)

MAXIMUM RATINGS

Rating	Symbol	Value	Unit
Collector–Emitter Voltage	V_{CEO}	15	Vdc
Collector–Emitter Voltage	V_{CES}	40	Vdc
Collector–Base Voltage	V_{CBO}	40	Vdc
Emitter–Base Voltage	V_{EBO}	5.0	Vdc
Collector Current — Continuous — 10 μ s Pulse	I_C	300 500	mAdc
Total Device Dissipation @ $T_A = 25^\circ\text{C}$ Derate above 25°C	P_D	625 5.0	mW mW/ $^\circ\text{C}$
Total Device Dissipation @ $T_C = 25^\circ\text{C}$ Derate above 25°C	P_D	1.5 12	Watts mW/ $^\circ\text{C}$
Operating and Storage Junction Temperature Range	T_J, T_{stg}	-55 to +150	$^\circ\text{C}$

THERMAL CHARACTERISTICS

Characteristic	Symbol	Max	Unit
Thermal Resistance, Junction to Ambient	$R_{\theta JA}$	200	$^\circ\text{C}/\text{W}$
Thermal Resistance, Junction to Case	$R_{\theta JC}$	83.3	$^\circ\text{C}/\text{W}$

ELECTRICAL CHARACTERISTICS ($T_A = 25^\circ\text{C}$ unless otherwise noted)

Characteristic	Symbol	Min	Max	Unit
----------------	--------	-----	-----	------

OFF CHARACTERISTICS

Collector–Emitter Breakdown Voltage ($I_C = 100 \mu\text{Adc}, V_{BE} = 0$)	$V_{(BR)CES}$	40	—	Vdc
Collector–Emitter Sustaining Voltage ⁽¹⁾ ($I_C = 10 \text{ mAdc}, I_B = 0$)	$V_{CEO(sus)}$	15	—	Vdc
Collector–Base Breakdown Voltage ($I_C = 100 \mu\text{Adc}, I_E = 0$)	$V_{(BR)CBO}$	40	—	Vdc
Emitter–Base Breakdown Voltage ($I_E = 100 \mu\text{Adc}, I_C = 0$)	$V_{(BR)EBO}$	5.0	—	Vdc
Collector Cutoff Current ($V_{CE} = 20 \text{ Vdc}, V_{BE} = 0$) ($V_{CE} = 20 \text{ Vdc}, V_{BE} = 0, T_A = 65^\circ\text{C}$)	I_{CES}	— —	0.5 3.0	μAdc

1. Pulse Test: Pulse Width $\leq 300 \mu\text{s}$; Duty Cycle $\leq 2.0\%$.

Preferred devices are Motorola recommended choices for future use and best overall value.

ELECTRICAL CHARACTERISTICS ($T_A = 25^\circ\text{C}$ unless otherwise noted) (Continued)

Characteristic	Symbol	Min	Max	Unit
ON CHARACTERISTICS(1)				
DC Current Gain ($I_C = 30\text{ mAdc}$, $V_{CE} = 0.4\text{ Vdc}$) ($I_C = 100\text{ mAdc}$, $V_{CE} = 0.5\text{ Vdc}$) ($I_C = 300\text{ mA}$, $V_{CE} = 1.0\text{ Vdc}$)	h_{FE}	30 25 15	120 — —	—
Collector–Emitter Saturation Voltage ($I_C = 30\text{ mAdc}$, $I_B = 3.0\text{ mAdc}$) ($I_C = 100\text{ mAdc}$, $I_B = 10\text{ mAdc}$) ($I_C = 300\text{ mAdc}$, $I_B = 30\text{ mAdc}$) ($I_C = 30\text{ mA}$, $I_B = 3.0\text{ mA}$, $T_A = 65^\circ\text{C}$)	$V_{CE(sat)}$	— — — —	0.2 0.28 0.5 0.3	Vdc
Base–Emitter Saturation Voltage ($I_C = 30\text{ mAdc}$, $I_B = 3.0\text{ mAdc}$) ($I_C = 100\text{ mAdc}$, $I_B = 10\text{ mAdc}$) ($I_C = 300\text{ mAdc}$, $I_B = 30\text{ mA}$)	$V_{BE(sat)}$	0.73 — —	0.95 1.2 1.7	Vdc

SMALL–SIGNAL CHARACTERISTICS

Current–Gain — Bandwidth Product ($I_C = 30\text{ mAdc}$, $V_{CE} = 10\text{ Vdc}$, $f = 100\text{ MHz}$)	f_T	350	—	MHz
Output Capacitance ($V_{CB} = 5.0\text{ Vdc}$, $I_E = 0$, $f = 1.0\text{ MHz}$)	C_{obo}	—	5.0	pF
Input Capacitance ($V_{EB} = 0.5\text{ Vdc}$, $I_C = 0$, $f = 1.0\text{ MHz}$)	C_{ibo}	—	9.0	pF

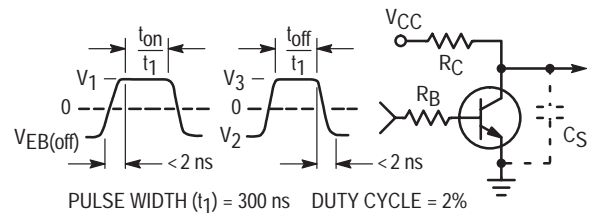
SWITCHING CHARACTERISTICS

Turn–On Time	($V_{CC} = 10\text{ Vdc}$, $I_C = 300\text{ mAdc}$, $I_{B1} = 30\text{ mAdc}$) (Figure 1)	t_{on}	—	18	ns
Delay Time		t_d	—	10	ns
Rise Time		t_r	—	15	ns
Turn–Off Time	($V_{CC} = 10\text{ Vdc}$, $I_C = 300\text{ mAdc}$, $I_{B1} = I_{B2} = 30\text{ mAdc}$) (Figure 1)	t_{off}	—	28	ns
Fall Time		t_f	—	15	ns
Storage Time ($V_{CC} = 10\text{ Vdc}$, $I_C = 10\text{ mAdc}$, $I_{B1} = I_{B2} = 10\text{ mAdc}$) (Figure 2)		t_s	—	18	ns

1. Pulse Test: Pulse Width $\leq 300\ \mu\text{s}$; Duty Cycle $\leq 2.0\%$.

Figure 1. Switching Time Equivalent Test Circuit

Test Condition	I_C	V_{CC}	R_S	R_C	$C_S(\text{max})$	$V_{BE(\text{off})}$	V_1	V_2	V_3
	mA	V	Ω	Ω	pF	V	V	V	V
A	10	3	330	270	4	-1.5	10.55	-4.15	10.70
B	10	10	580	960	4	—	—	-4.65	6.55
C	100	10	560	96	12	-2.0	6.35	-4.65	6.55



CURRENT GAIN CHARACTERISTICS

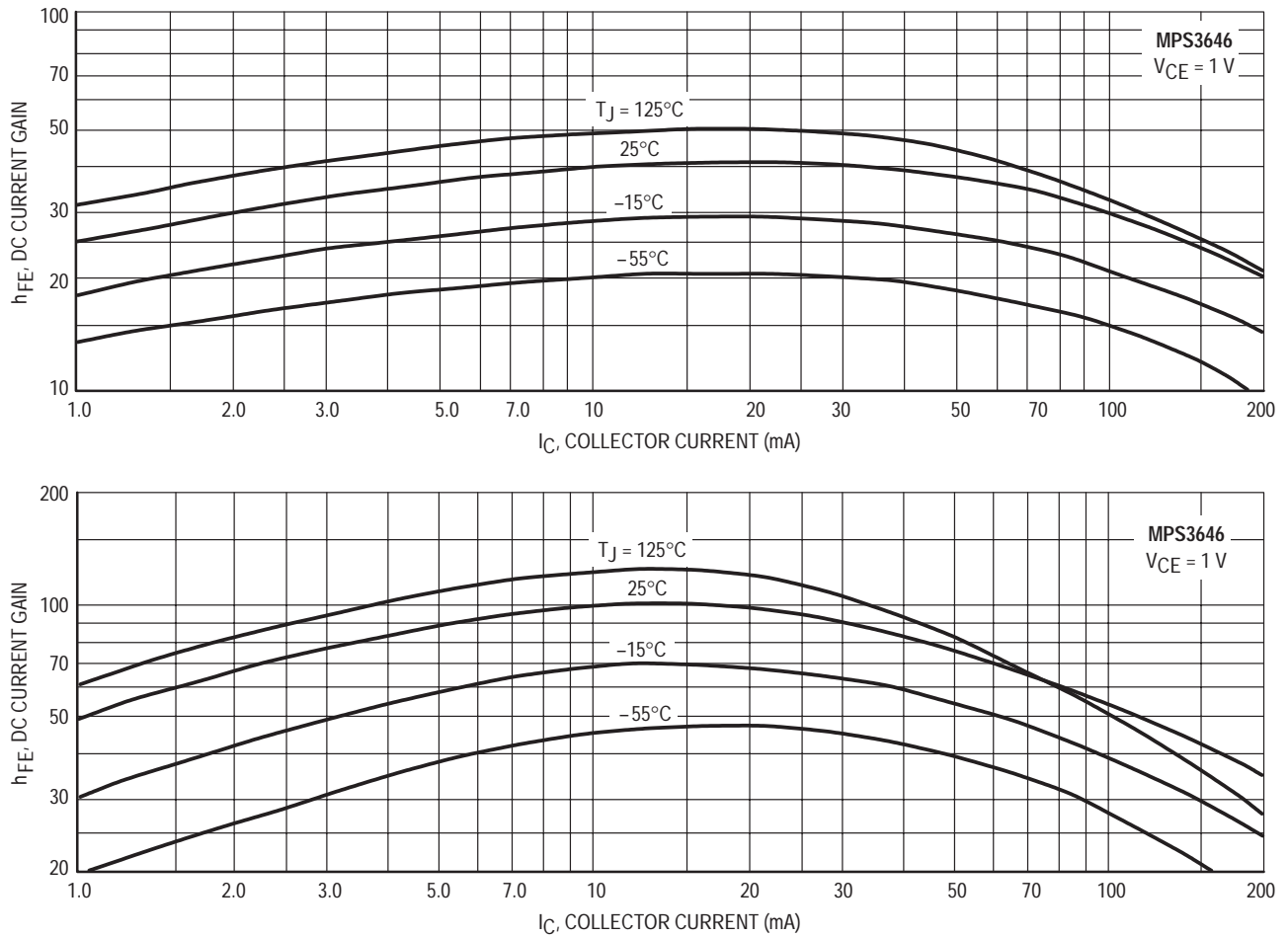


Figure 2. Minimum Current Gain

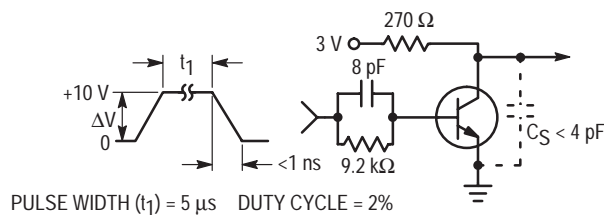


Figure 3. Q_T Test Circuit

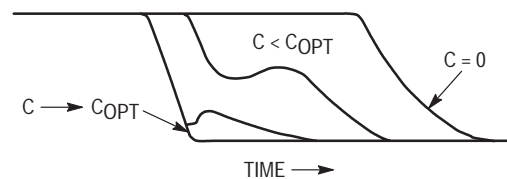


Figure 4. Turn-Off Waveform

NOTE 1

When a transistor is held in a conductive state by a base current, I_B , a charge, Q_S , is developed or "stored" in the transistor. Q_S may be written: $Q_S = Q_1 + Q_V + Q_X$.

Q_1 is the charge required to develop the required collector current. This charge is primarily a function of alpha cutoff frequency. Q_V is the charge required to charge the collector-base feedback capacity. Q_X is excess charge resulting from overdrive, i.e., operation in saturation.

The charge required to turn a transistor "on" to the edge of saturation is the sum of Q_1 and Q_V which is defined as the active region charge, Q_A . $Q_A = I_{B1}t_f$ when the transistor is driven by a constant current step

$$(I_{B1}) \text{ and } I_{B1} < \frac{I_C}{h_{FE}}$$

If I_B were suddenly removed, the transistor would continue to conduct until Q_S is removed from the active regions through an external path or through internal recombination. Since the internal recombination time is long compared to the ultimate capability of a transistor, a charge, Q_T , of opposite polarity, equal in magnitude, can be stored on an external capacitor, C , to neutralize the internal charge and considerably reduce the turn-off time of the transistor. Figure 3 shows the test circuit and Figure 4 the turn-off waveform. Given Q_T from Figure 13, the external C for worst-case turn-off in any circuit is: $C = Q_T/\Delta V$, where ΔV is defined in Figure 3.

“ON” CONDITION CHARACTERISTICS

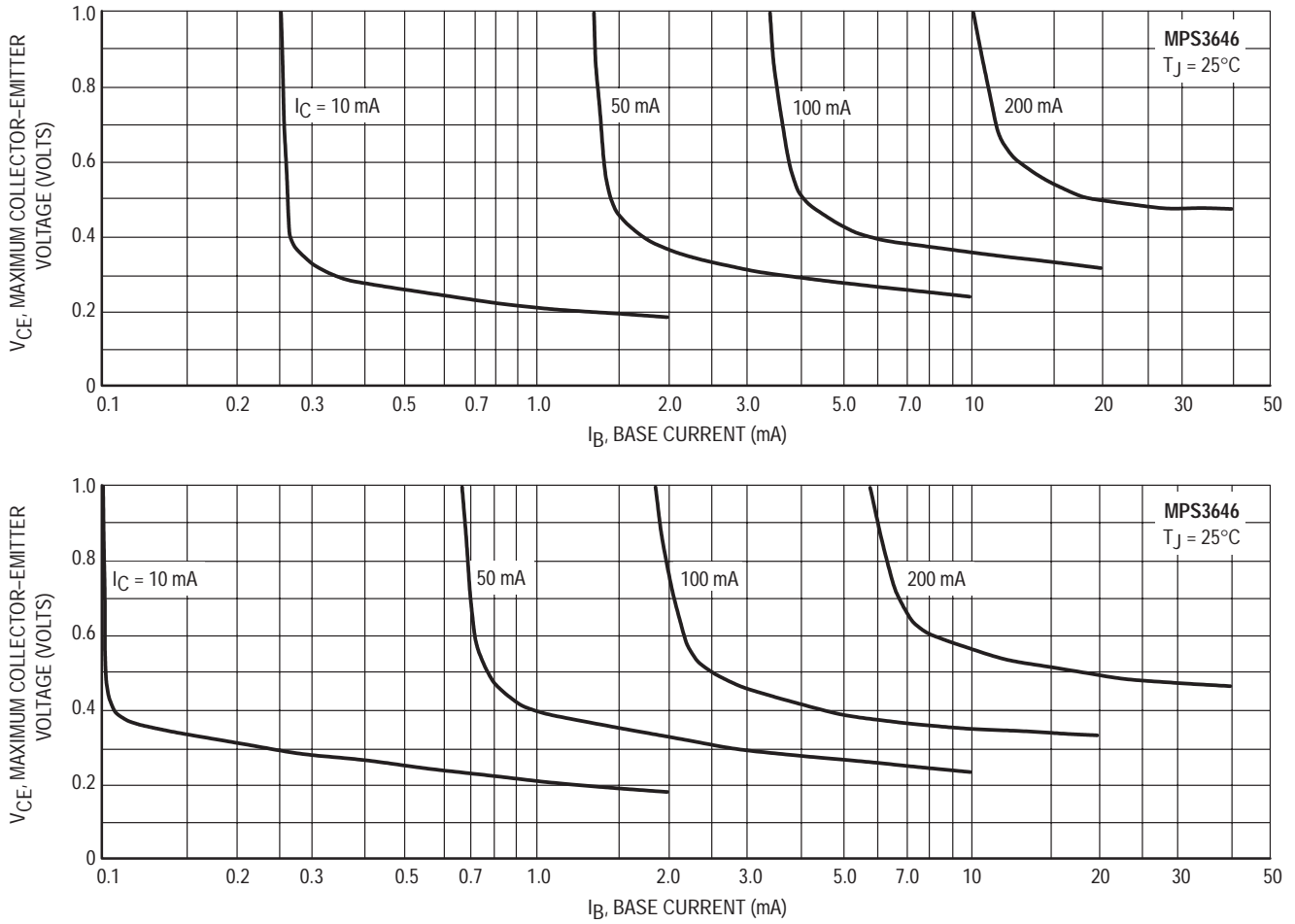


Figure 5. Collector Saturation Region

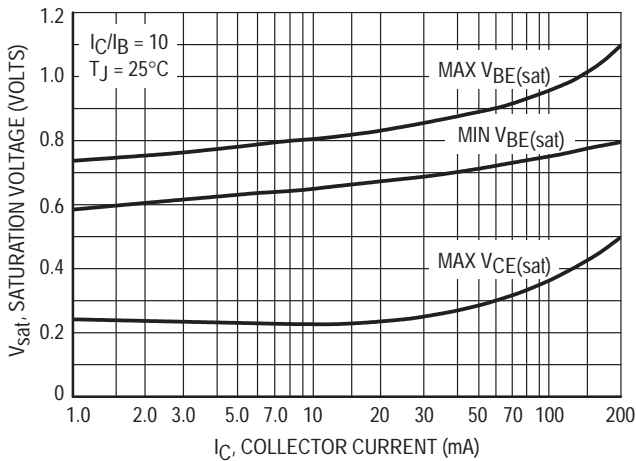


Figure 6. Saturation Voltage Limits

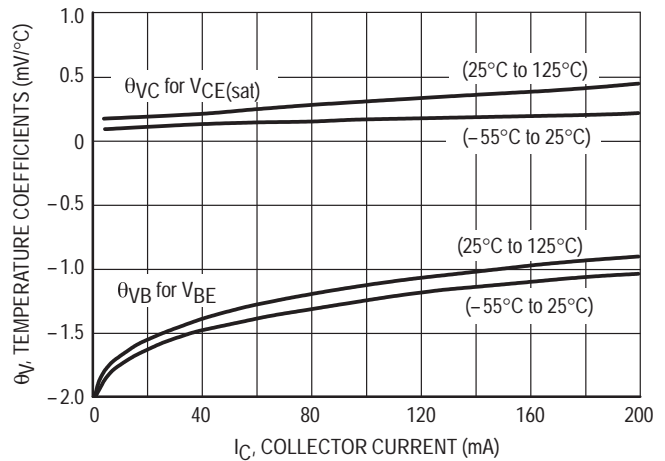


Figure 7. Temperature Coefficients

DYNAMIC CHARACTERISTICS

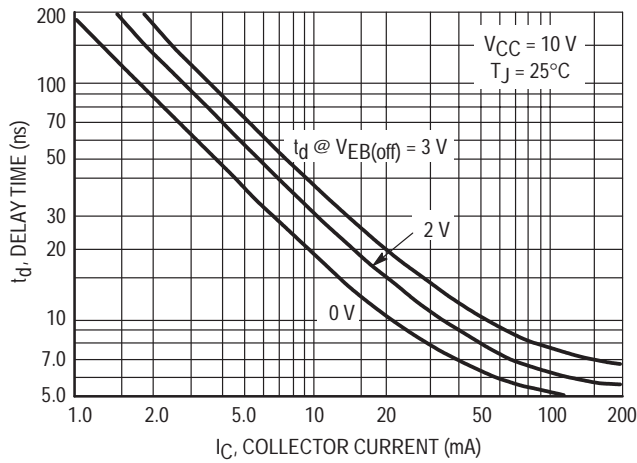


Figure 8. Delay Time

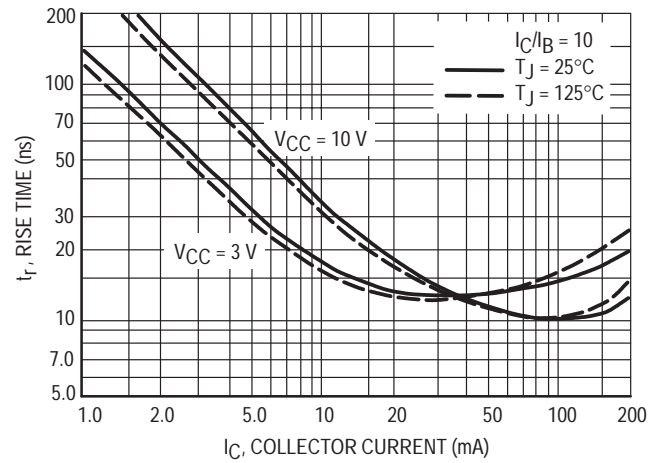


Figure 9. Rise Time

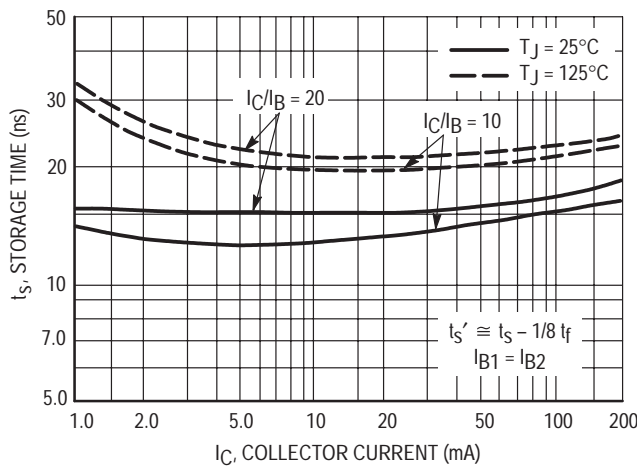


Figure 10. Storage Time

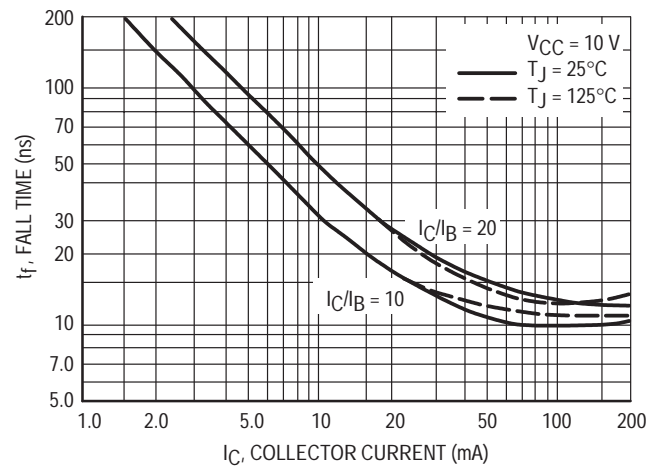


Figure 11. Fall Time

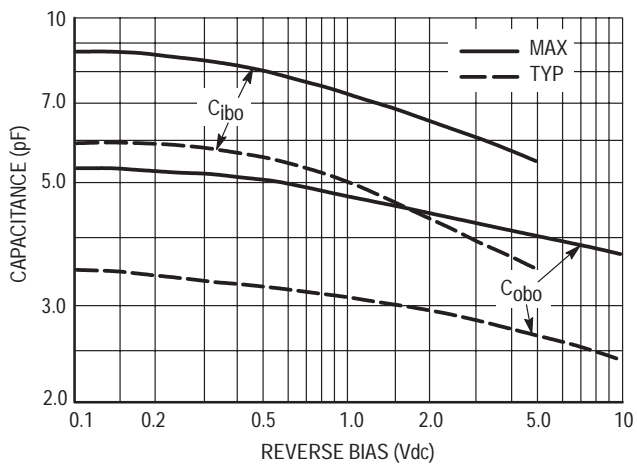


Figure 12. Junction Capacitance

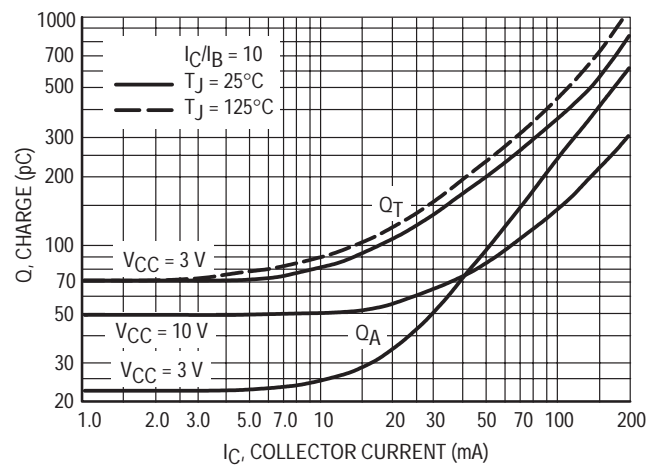
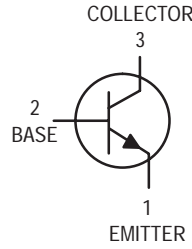


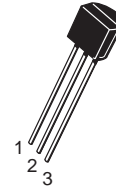
Figure 13. Maximum Charge Data

General Purpose Transistor

NPN Silicon



MPS3904



CASE 29-04, STYLE 1
TO-92 (TO-226AA)

MAXIMUM RATINGS

Rating	Symbol	Value	Unit
Collector–Emitter Voltage	V_{CEO}	40	Vdc
Collector–Base Voltage	V_{CBO}	60	Vdc
Emitter–Base Voltage	V_{EBO}	6.0	Vdc
Collector Current — Continuous	I_C	100	mAdc
Total Device Dissipation @ $T_A = 25^\circ\text{C}$ Derate above 25°C	P_D	625 5.0	mW mW/ $^\circ\text{C}$
Total Power Dissipation @ $T_A = 60^\circ\text{C}$	P_D	450	mW
Total Device Dissipation @ $T_C = 25^\circ\text{C}$ Derate above 25°C	P_D	1.5 12	Watts mW/ $^\circ\text{C}$
Operating and Storage Junction Temperature Range	T_J, T_{stg}	-55 to +150	$^\circ\text{C}$

THERMAL CHARACTERISTICS

Characteristic	Symbol	Max	Unit
Thermal Resistance, Junction to Ambient	$R_{\theta JA}$	200	$^\circ\text{C}/\text{W}$
Thermal Resistance, Junction to Case	$R_{\theta JC}$	83.3	$^\circ\text{C}/\text{W}$

ELECTRICAL CHARACTERISTICS ($T_A = 25^\circ\text{C}$ unless otherwise noted)

Characteristic	Symbol	Min	Max	Unit
----------------	--------	-----	-----	------

OFF CHARACTERISTICS

Collector–Emitter Breakdown Voltage ⁽¹⁾ ($I_C = 1.0 \text{ mAdc}, I_B = 0$)	$V_{(BR)CEO}$	40	—	Vdc
Collector–Base Breakdown Voltage ($I_C = 10 \mu\text{Adc}, I_E = 0$)	$V_{(BR)CBO}$	60	—	Vdc
Emitter–Base Breakdown Voltage ($I_E = 10 \mu\text{Adc}, I_C = 0$)	$V_{(BR)EBO}$	6.0	—	Vdc
Collector Cutoff Current ($V_{CE} = 30 \text{ Vdc}, V_{EB(off)} = 3.0 \text{ Vdc}$)	I_{CEX}	—	50	nAdc
Base Cutoff Current ($V_{CE} = 30 \text{ Vdc}, V_{EB(off)} = 3.0 \text{ Vdc}$)	I_{BL}	—	50	nAdc

1. Pulse Test: Pulse Width $\leq 300 \mu\text{s}$, Duty Cycle $\leq 2.0\%$.

ELECTRICAL CHARACTERISTICS ($T_A = 25^\circ\text{C}$ unless otherwise noted) (Continued)

Characteristic	Symbol	Min	Max	Unit
ON CHARACTERISTICS(1)				
DC Current Gain ($I_C = 0.1 \text{ mAdc}, V_{CE} = 1.0 \text{ Vdc}$) ($I_C = 1.0 \text{ mAdc}, V_{CE} = 1.0 \text{ Vdc}$) ($I_C = 10 \text{ mAdc}, V_{CE} = 1.0 \text{ Vdc}$) ($I_C = 50 \text{ mAdc}, V_{CE} = 1.0 \text{ Vdc}$) ($I_C = 100 \text{ mAdc}, V_{CE} = 1.0 \text{ Vdc}$)	h_{FE}	40 70 100 60 30	— — 300 — —	—
Collector–Emitter Saturation Voltage ($I_C = 10 \text{ mAdc}, I_B = 1.0 \text{ mAdc}$) ($I_C = 50 \text{ mAdc}, I_B = 5.0 \text{ mAdc}$)	$V_{CE(sat)}$	— —	0.2 0.3	Vdc
Base–Emitter Saturation Voltage ($I_C = 10 \text{ mAdc}, I_B = 1.0 \text{ mAdc}$) ($I_C = 50 \text{ mAdc}, I_B = 5.0 \text{ mAdc}$)	$V_{BE(sat)}$	0.65 —	0.85 1.1	Vdc

SMALL–SIGNAL CHARACTERISTICS

Current–Gain — Bandwidth Product ($I_C = 10 \text{ mAdc}, V_{CE} = 20 \text{ Vdc}, f = 100 \text{ MHz}$)	f_T	300	—	MHz
Output Capacitance ($V_{CB} = 5.0 \text{ Vdc}, I_E = 0, f = 1.0 \text{ MHz}$)	C_{obo}	—	4.0	pF
Input Capacitance ($V_{EB} = 0.5 \text{ Vdc}, I_C = 0, f = 1.0 \text{ MHz}$)	C_{ibo}	—	8.0	pF
Input Impedance ($I_C = 1.0 \text{ mAdc}, V_{CE} = 10 \text{ Vdc}, f = 1.0 \text{ kHz}$)	h_{ie}	1.0	10	k Ω
Voltage Feedback Ratio ($I_C = 1.0 \text{ mAdc}, V_{CE} = 10 \text{ Vdc}, f = 1.0 \text{ kHz}$)	h_{re}	0.5	8.0	$\times 10^{-4}$
Small–Signal Current Gain ($I_C = 1.0 \text{ mAdc}, V_{CE} = 10 \text{ Vdc}, f = 1.0 \text{ kHz}$)	h_{fe}	100	400	—
Output Admittance ($I_C = 1.0 \text{ mAdc}, V_{CE} = 10 \text{ Vdc}, f = 1.0 \text{ kHz}$)	h_{oe}	1.0	40	μmhos
Noise Figure ($I_C = 100 \mu\text{Adc}, V_{CE} = 5.0 \text{ Vdc}, R_S = 1.0 \text{ k}\Omega, f = 1.0 \text{ kHz}$)	NF	—	5.0	dB

SWITCHING CHARACTERISTICS

Delay Time	$(V_{CC} = 3.0 \text{ Vdc}, V_{BE(off)} = -0.5 \text{ Vdc}, I_C = 10 \text{ mAdc}, I_{B1} = 1.0 \text{ mAdc})$	t_d	—	35	ns
Rise Time		t_r	—	50	ns
Storage Time	$(V_{CC} = 3.0 \text{ Vdc}, I_C = 10 \text{ mAdc}, I_{B1} = I_{B2} = 1.0 \text{ mAdc})$	t_s	—	900	ns
Fall Time		t_f	—	90	ns

1. Pulse Test: Pulse Width $\leq 300 \mu\text{s}$, Duty Cycle $\leq 2.0\%$.

EQUIVALENT SWITCHING TIME TEST CIRCUITS

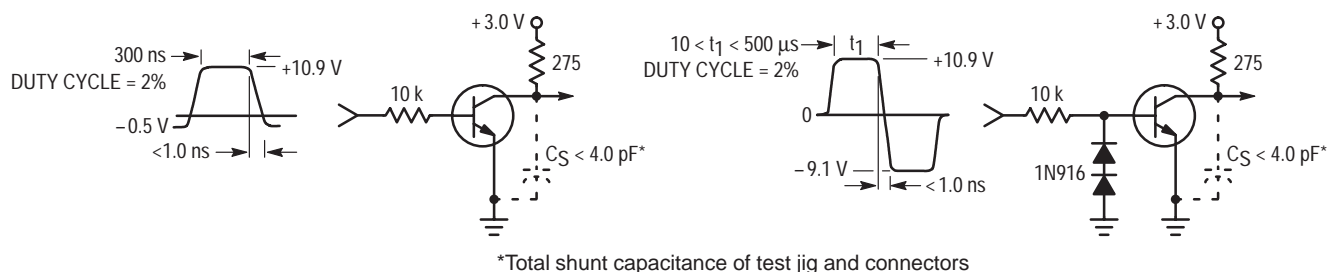


Figure 1. Turn–On Time

Figure 2. Turn–Off Time

TYPICAL NOISE CHARACTERISTICS

($V_{CE} = 5.0 \text{ Vdc}$, $T_A = 25^\circ\text{C}$)

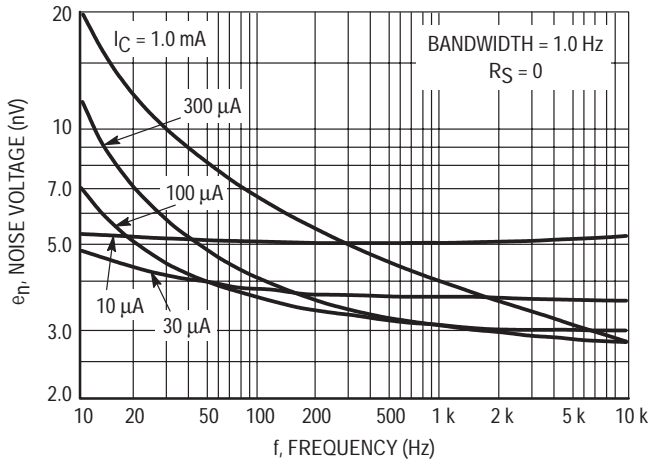


Figure 3. Noise Voltage

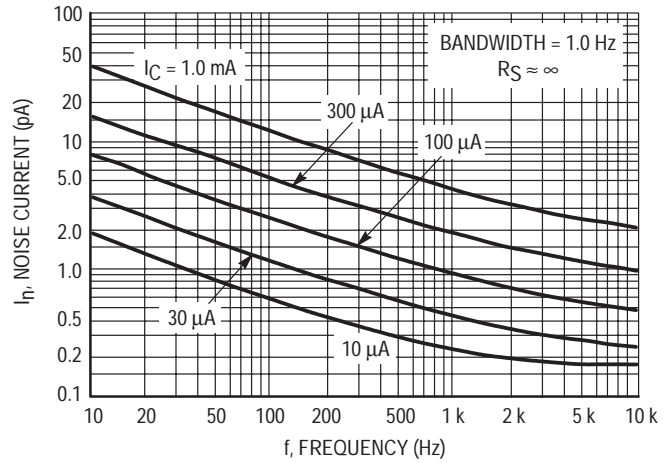


Figure 4. Noise Current

NOISE FIGURE CONTOURS

($V_{CE} = 5.0 \text{ Vdc}$, $T_A = 25^\circ\text{C}$)

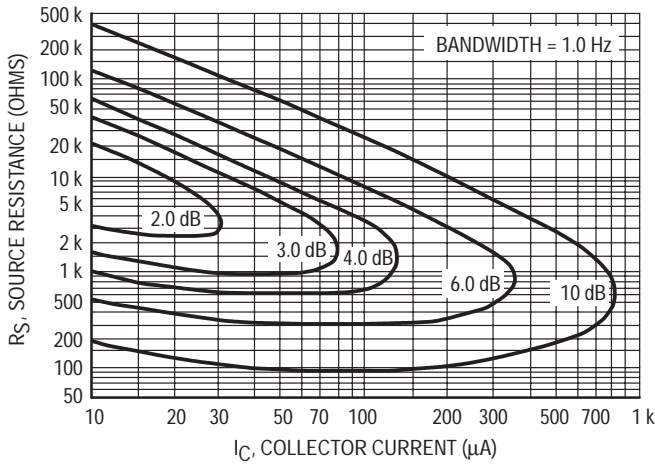


Figure 5. Narrow Band, 100 Hz

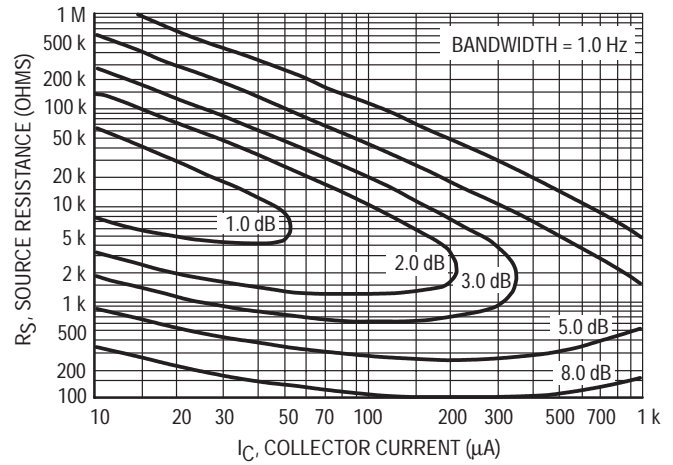


Figure 6. Narrow Band, 1.0 kHz

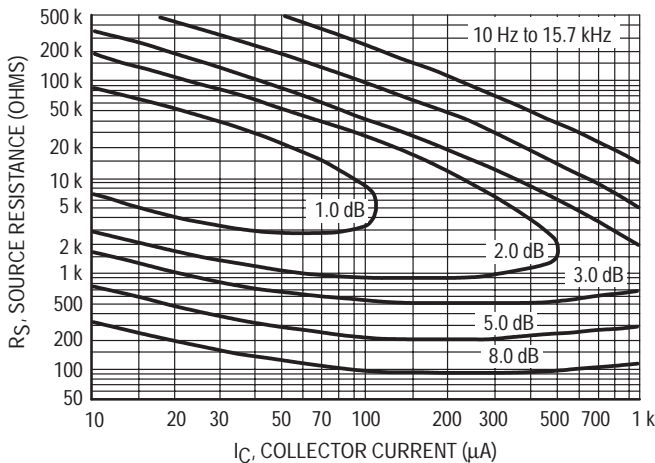


Figure 7. Wideband

Noise Figure is defined as:

$$NF = 20 \log_{10} \left(\frac{e_n^2 + 4KTR_S + I_n^2 R_S^2}{4KTR_S} \right)^{1/2}$$

e_n = Noise Voltage of the Transistor referred to the input. (Figure 3)

I_n = Noise Current of the Transistor referred to the input. (Figure 4)

K = Boltzman's Constant ($1.38 \times 10^{-23} \text{ j}^\circ\text{K}$)

T = Temperature of the Source Resistance ($^\circ\text{K}$)

R_S = Source Resistance (Ohms)

TYPICAL STATIC CHARACTERISTICS

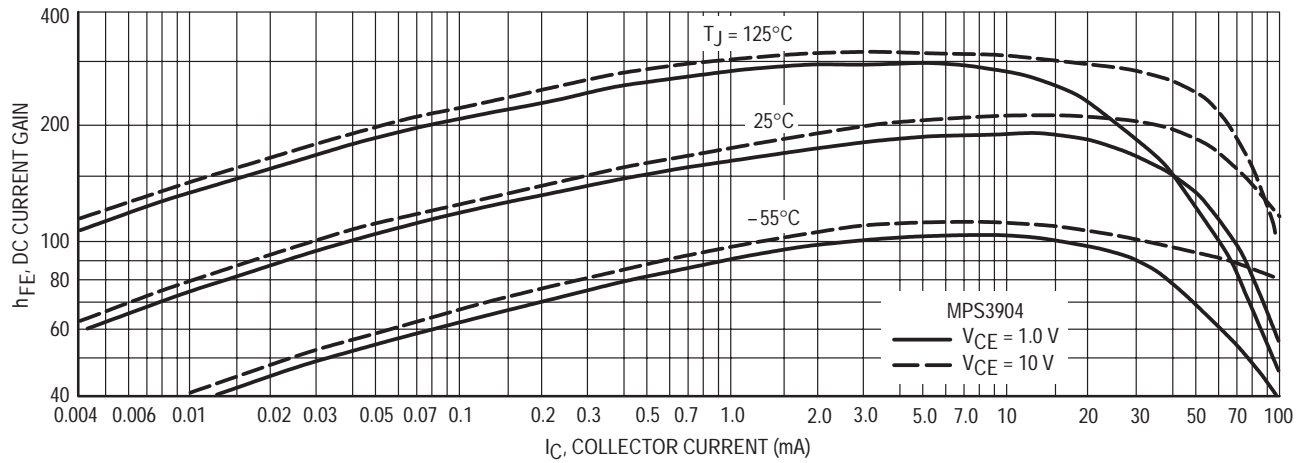


Figure 8. DC Current Gain

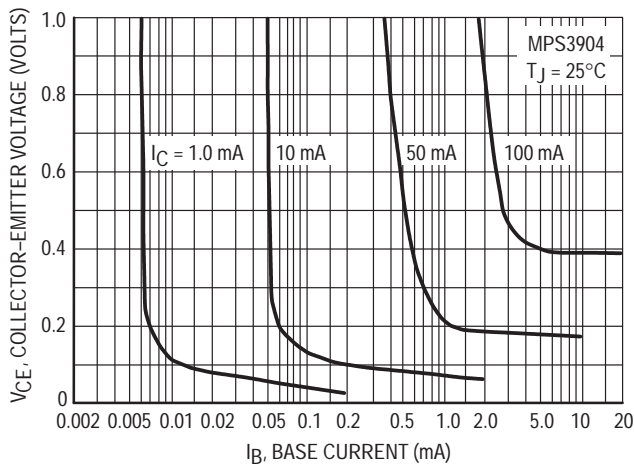


Figure 9. Collector Saturation Region

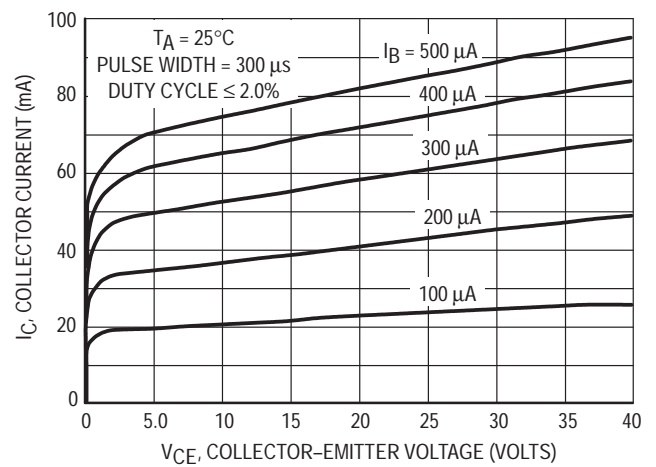


Figure 10. Collector Characteristics

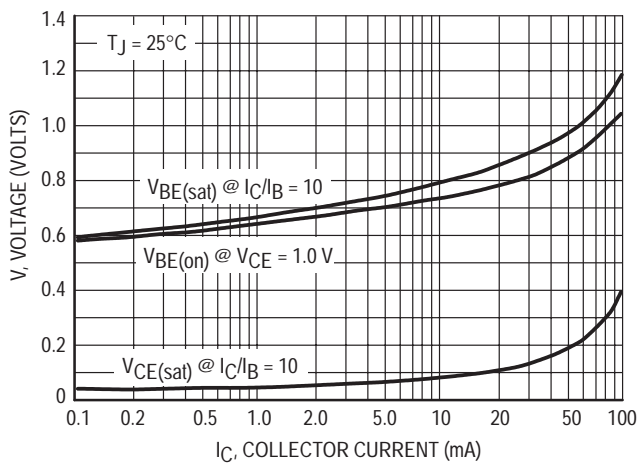


Figure 11. "On" Voltages

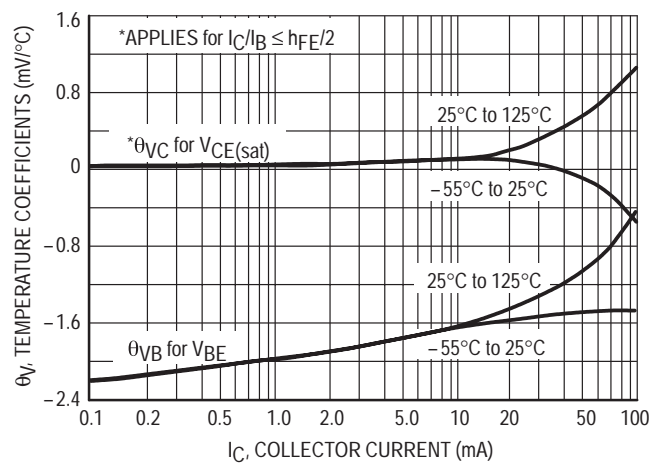


Figure 12. Temperature Coefficients

TYPICAL DYNAMIC CHARACTERISTICS

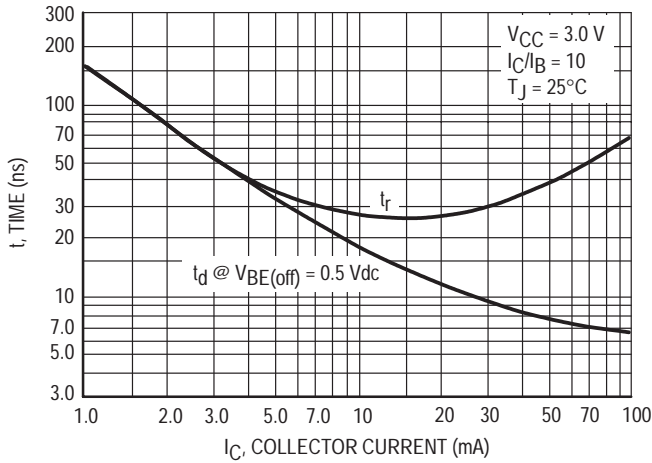


Figure 13. Turn-On Time

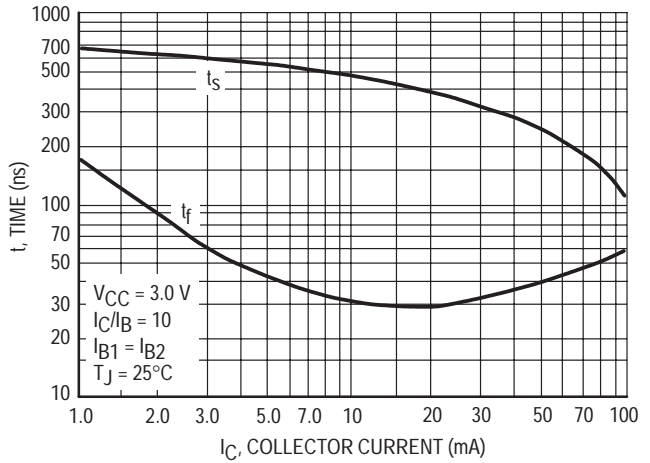


Figure 14. Turn-Off Time

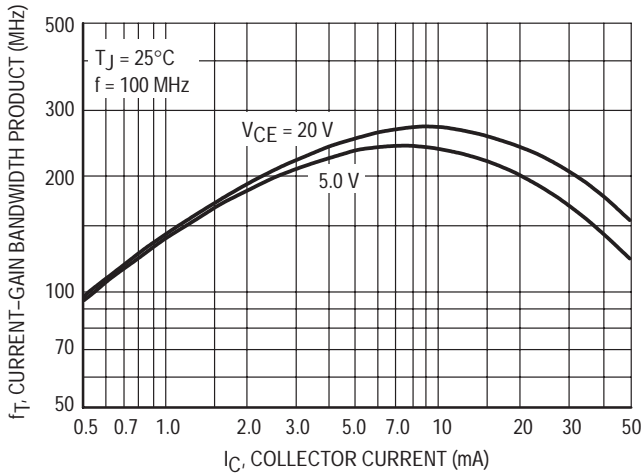


Figure 15. Current-Gain — Bandwidth Product

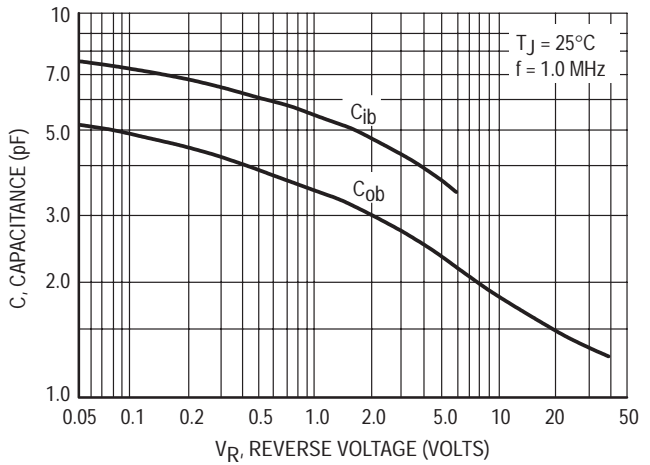


Figure 16. Capacitance

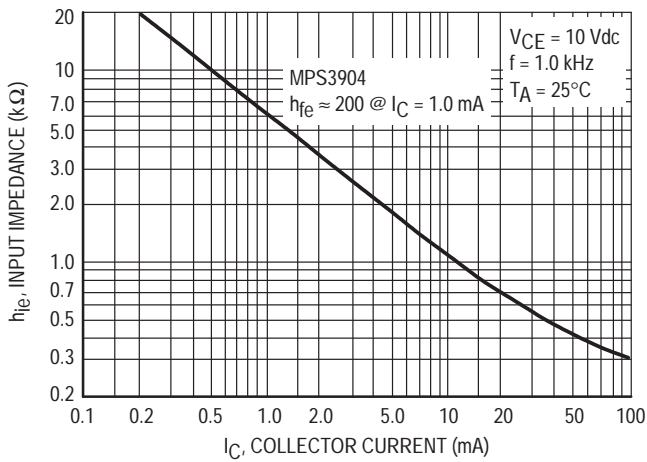


Figure 17. Input Impedance

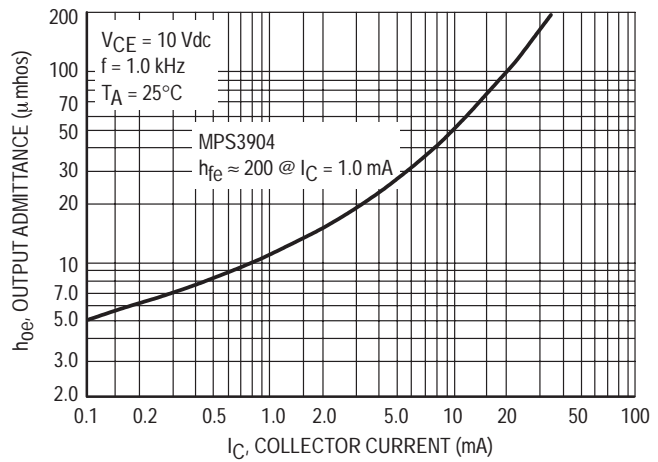


Figure 18. Output Admittance

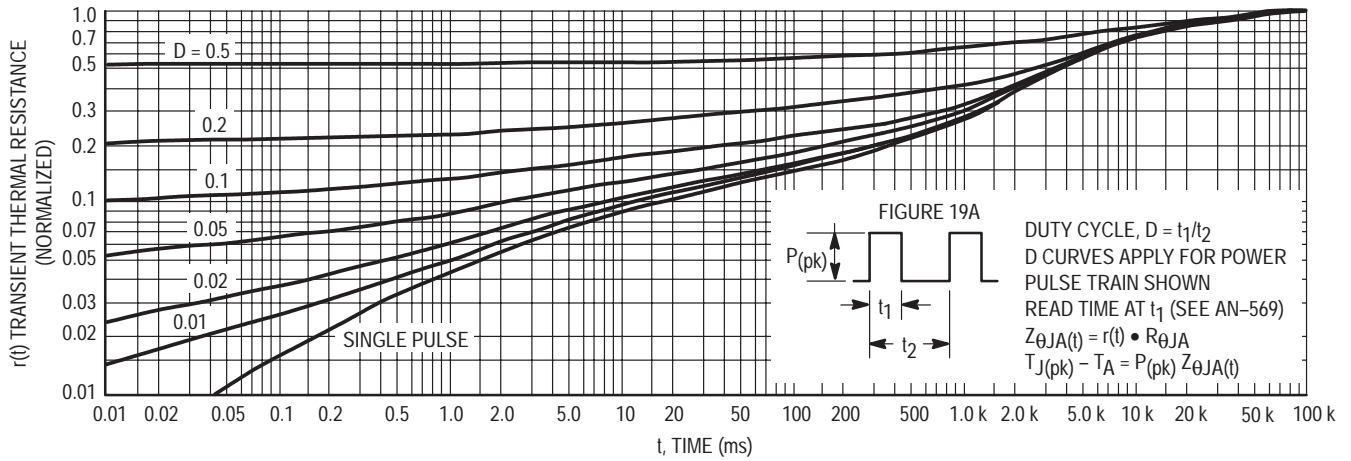


Figure 19. Thermal Response

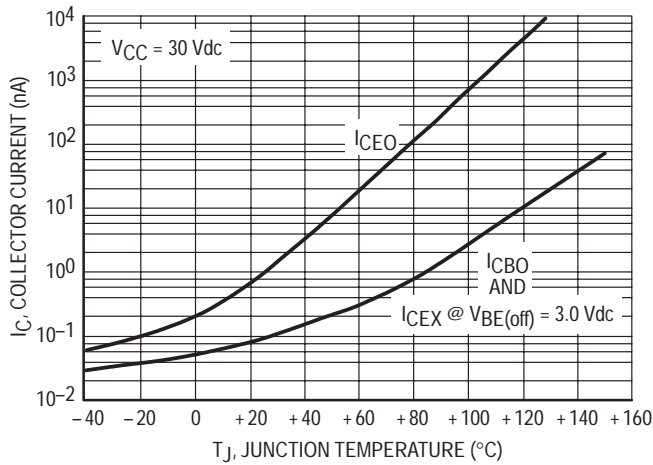


Figure 19A.

DESIGN NOTE: USE OF THERMAL RESPONSE DATA

A train of periodical power pulses can be represented by the model as shown in Figure 19A. Using the model and the device thermal response the normalized effective transient thermal resistance of Figure 19 was calculated for various duty cycles.

To find $Z_{\theta JA}(t)$, multiply the value obtained from Figure 19 by the steady state value $R_{\theta JA}$.

Example:

The MPS3904 is dissipating 2.0 watts peak under the following conditions:

$t_1 = 1.0$ ms, $t_2 = 5.0$ ms. ($D = 0.2$)

Using Figure 19 at a pulse width of 1.0 ms and $D = 0.2$, the reading of $r(t)$ is 0.22.

The peak rise in junction temperature is therefore

$\Delta T = r(t) \times P(pk) \times R_{\theta JA} = 0.22 \times 2.0 \times 200 = 88^\circ\text{C}$.

For more information, see AN-569.

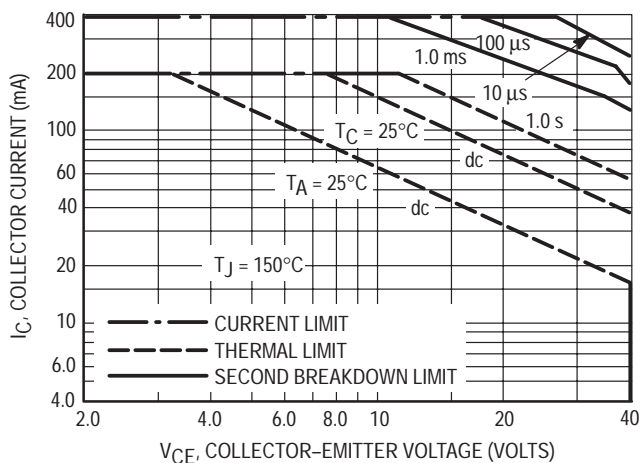


Figure 20.

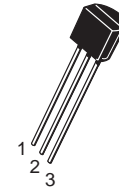
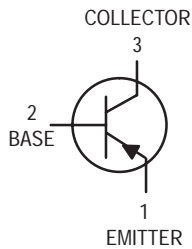
The safe operating area curves indicate I_C - V_{CE} limits of the transistor that must be observed for reliable operation. Collector load lines for specific circuits must fall below the limits indicated by the applicable curve.

The data of Figure 20 is based upon $T_{J(pk)} = 150^\circ\text{C}$; T_C or T_A is variable depending upon conditions. Pulse curves are valid for duty cycles to 10% provided $T_{J(pk)} \leq 150^\circ\text{C}$. $T_{J(pk)}$ may be calculated from the data in Figure 19. At high case or ambient temperatures, thermal limitations will reduce the power that can be handled to values less than the limitations imposed by second breakdown.

General Purpose Transistor

PNP Silicon

MPS3906



CASE 29-04, STYLE 1
TO-92 (TO-226AA)

MAXIMUM RATINGS

Rating	Symbol	Value	Unit
Collector–Emitter Voltage	V_{CEO}	–40	Vdc
Collector–Base Voltage	V_{CBO}	–40	Vdc
Emitter–Base Voltage	V_{EBO}	–5.0	Vdc
Collector Current — Continuous	I_C	–200	mAdc
Total Device Dissipation @ $T_A = 25^\circ\text{C}$ Derate above 25°C	P_D	625 5.0	mW mW/ $^\circ\text{C}$
Total Device Dissipation @ $T_C = 25^\circ\text{C}$ Derate above 25°C	P_D	1.5 12	Watts mW/ $^\circ\text{C}$
Operating and Storage Junction Temperature Range	T_J, T_{stg}	–55 to +150	$^\circ\text{C}$

THERMAL CHARACTERISTICS

Characteristic	Symbol	Max	Unit
Thermal Resistance, Junction to Ambient	$R_{\theta JA}$	200	$^\circ\text{C}/\text{W}$
Thermal Resistance, Junction to Case	$R_{\theta JC}$	83.3	$^\circ\text{C}/\text{W}$

ELECTRICAL CHARACTERISTICS ($T_A = 25^\circ\text{C}$ unless otherwise noted)

Characteristic	Symbol	Min	Max	Unit
----------------	--------	-----	-----	------

OFF CHARACTERISTICS

Collector–Emitter Breakdown Voltage ⁽¹⁾ ($I_C = -1.0$ mAdc, $I_B = 0$)	$V_{(BR)CEO}$	–40	—	Vdc
Collector–Base Breakdown Voltage ($I_C = -10$ μAdc , $I_E = 0$)	$V_{(BR)CBO}$	–40	—	Vdc
Emitter–Base Breakdown Voltage ($I_E = -10$ μAdc , $I_C = 0$)	$V_{(BR)EBO}$	–5.0	—	Vdc
Collector Cutoff Current ($V_{CE} = -30$ Vdc, $V_{EB(off)} = -3.0$ Vdc)	I_{CEX}	—	–50	nAdc
Base Cutoff Current ($V_{CE} = -30$ Vdc, $V_{EB(off)} = -3.0$ Vdc)	I_{BL}	—	–50	nAdc

1. Pulse Test: Pulse Width = 300 μs ; Duty Cycle = 2.0%.

ELECTRICAL CHARACTERISTICS ($T_A = 25^\circ\text{C}$ unless otherwise noted) (Continued)

Characteristic	Symbol	Min	Max	Unit
ON CHARACTERISTICS(1)				
DC Current Gain ($I_C = -0.1 \text{ mAdc}$, $V_{CE} = -1.0 \text{ Vdc}$) ($I_C = -1.0 \text{ mAdc}$, $V_{CE} = -1.0 \text{ Vdc}$) ($I_C = -10 \text{ mAdc}$, $V_{CE} = -1.0 \text{ Vdc}$) ($I_C = -50 \text{ mAdc}$, $V_{CE} = -1.0 \text{ Vdc}$) ($I_C = -100 \text{ mAdc}$, $V_{CE} = -1.0 \text{ Vdc}$)	h_{FE}	60 80 100 60 30	— — 300 — —	—
Collector–Emitter Saturation Voltage ($I_C = -10 \text{ mAdc}$, $I_B = -1.0 \text{ mAdc}$) ($I_C = -50 \text{ mAdc}$, $I_B = -5.0 \text{ mAdc}$)	$V_{CE(sat)}$	— —	-0.25 -0.4	Vdc
Base–Emitter Saturation Voltage ($I_C = -10 \text{ mAdc}$, $I_B = -1.0 \text{ mAdc}$) ($I_C = -50 \text{ mAdc}$, $I_B = -5.0 \text{ mAdc}$)	$V_{BE(sat)}$	-0.65 —	-0.85 -0.95	Vdc

SMALL–SIGNAL CHARACTERISTICS

Current–Gain — Bandwidth Product ($I_C = -10 \text{ mAdc}$, $V_{CE} = -20 \text{ V}$, $f = 100 \text{ MHz}$)	f_T	250	—	MHz
Output Capacitance ($V_{CB} = -5.0 \text{ Vdc}$, $I_E = 0$, $f = 1.0 \text{ MHz}$)	C_{obo}	—	4.5	pF
Input Capacitance ($V_{EB} = -0.5 \text{ Vdc}$, $I_C = 0$, $f = 1.0 \text{ MHz}$)	C_{ibo}	—	10	pF
Input Impedance ($I_C = -1.0 \text{ mAdc}$, $V_{CE} = -10 \text{ Vdc}$, $f = 1.0 \text{ kHz}$)	h_{ie}	2.0	12	k Ω
Voltage Feedback Ratio ($I_C = -1.0 \text{ mAdc}$, $V_{CE} = -10 \text{ Vdc}$, $f = 1.0 \text{ kHz}$)	h_{re}	1.0	10	$\times 10^{-4}$
Small–Signal Current Gain ($I_C = -1.0 \text{ mAdc}$, $V_{CE} = -10 \text{ Vdc}$, $f = 1.0 \text{ kHz}$)	h_{fe}	100	400	—
Output Admittance ($I_C = -1.0 \text{ mAdc}$, $V_{CE} = -10 \text{ Vdc}$, $f = 1.0 \text{ kHz}$)	h_{oe}	3.0	60	μmhos
Noise Figure ($I_C = -100 \mu\text{Adc}$, $V_{CE} = -5.0 \text{ Vdc}$, $R_S = 1.0 \text{ k } \Omega$, $f = 1.0 \text{ kHz}$)	NF	—	4.0	dB

SWITCHING CHARACTERISTICS

Delay Time	$(V_{CC} = -3.0 \text{ Vdc}$, $V_{BE(off)} = +0.5 \text{ Vdc}$, $I_C = -10 \text{ mAdc}$, $I_{B1} = 1.0 \text{ mAdc}$)	t_d	—	35	ns
Rise Time		t_r	—	50	ns
Storage Time	$(V_{CC} = -3.0 \text{ Vdc}$, $I_C = -10 \text{ mAdc}$, $I_{B1} = I_{B2} = -1.0 \text{ mAdc}$)	t_s	—	600	ns
Fall Time		t_f	—	90	ns

1. Pulse Test: Pulse Width = 300 μs ; Duty Cycle = 2.0%.

TYPICAL NOISE CHARACTERISTICS

($V_{CE} = -5.0$ Vdc, $T_A = 25^\circ\text{C}$)

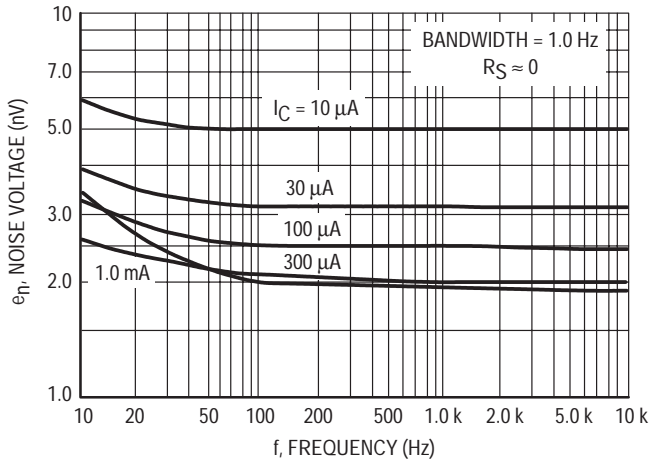


Figure 1. Noise Voltage

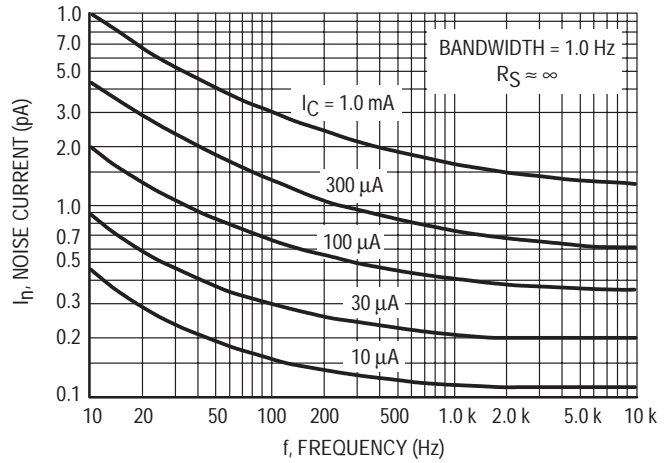


Figure 2. Noise Current

NOISE FIGURE CONTOURS

($V_{CE} = -5.0$ Vdc, $T_A = 25^\circ\text{C}$)

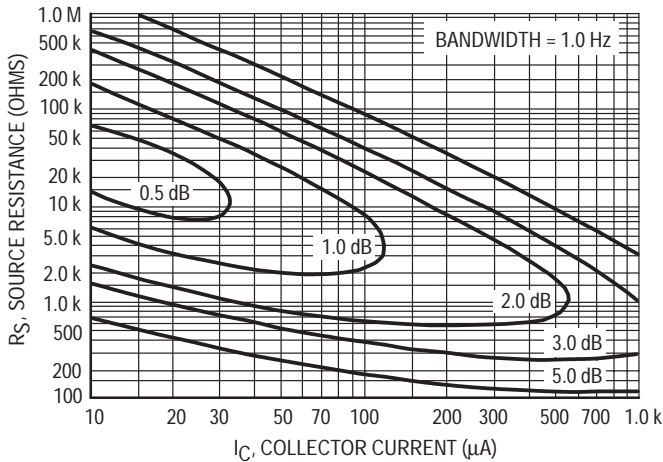


Figure 3. Narrow Band, 100 Hz

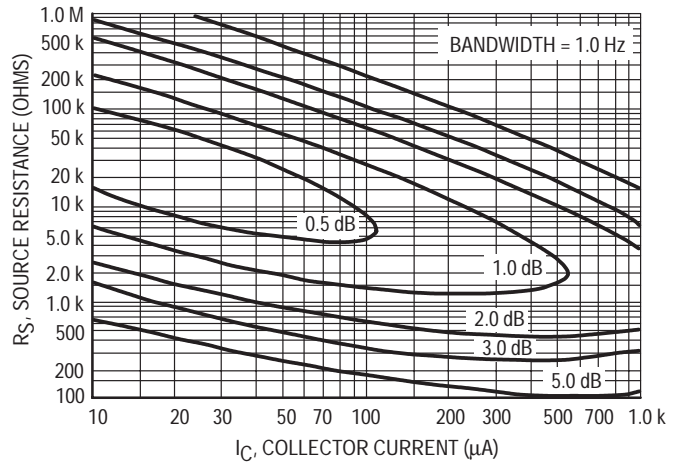


Figure 4. Narrow Band, 1.0 kHz

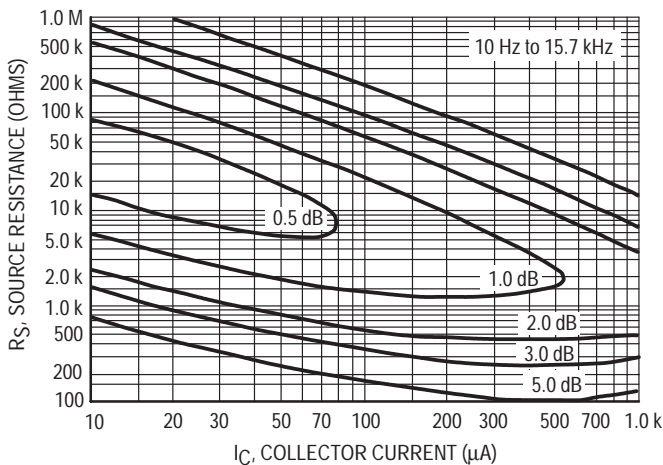


Figure 5. Wideband

Noise Figure is Defined as:

$$NF = 20 \log_{10} \left[\frac{e_n^2 + 4KTR_S + I_n^2 R_S^2}{4KTR_S} \right]^{1/2}$$

e_n = Noise Voltage of the Transistor referred to the input. (Figure 3)

I_n = Noise Current of the Transistor referred to the input. (Figure 4)

K = Boltzman's Constant (1.38×10^{-23} j/°K)

T = Temperature of the Source Resistance (°K)

R_S = Source Resistance (Ohms)

TYPICAL STATIC CHARACTERISTICS

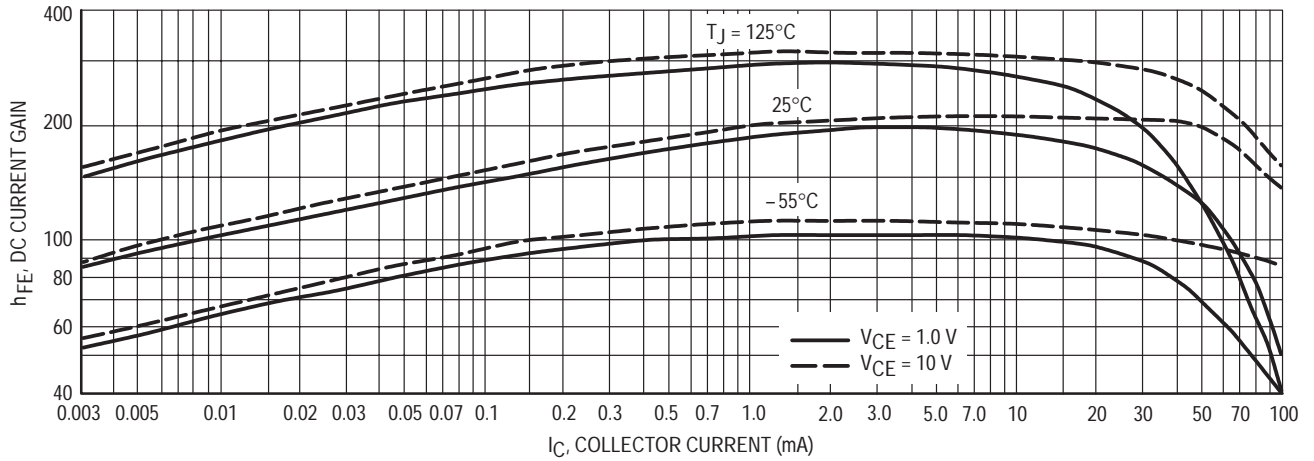


Figure 6. DC Current Gain

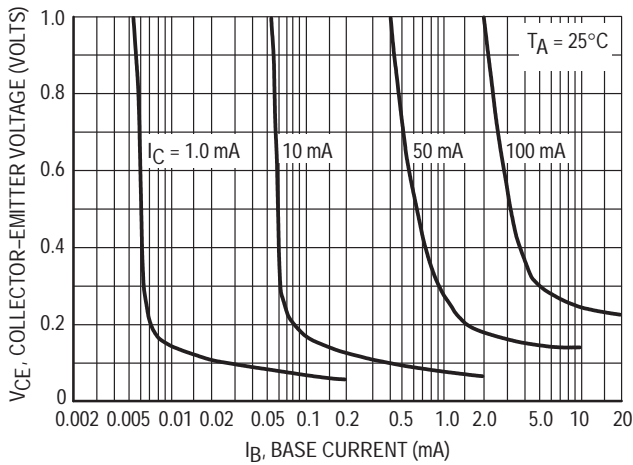


Figure 7. Collector Saturation Region

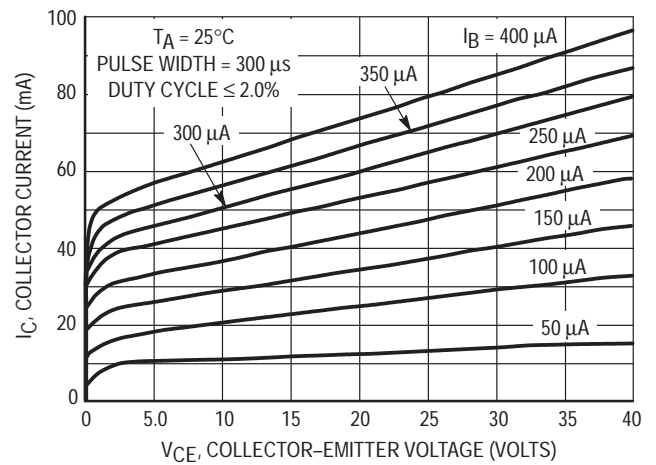


Figure 8. Collector Characteristics

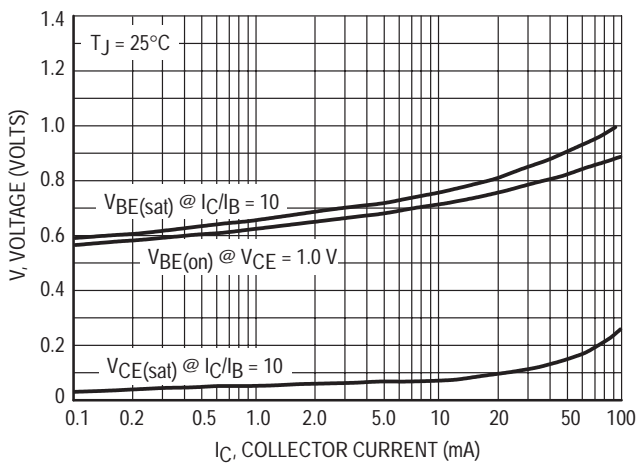


Figure 9. "On" Voltages

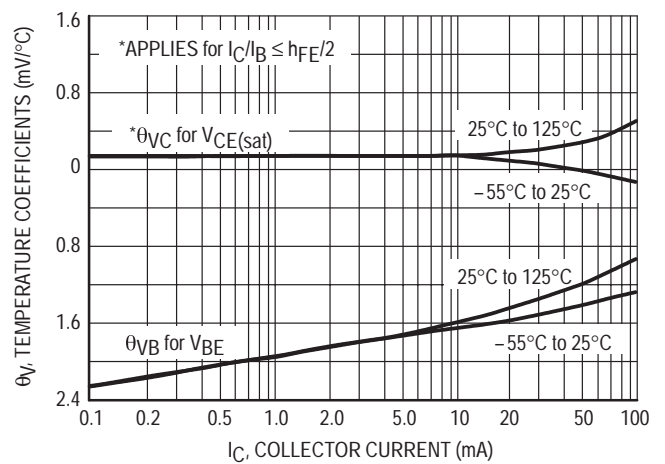


Figure 10. Temperature Coefficients

TYPICAL DYNAMIC CHARACTERISTICS

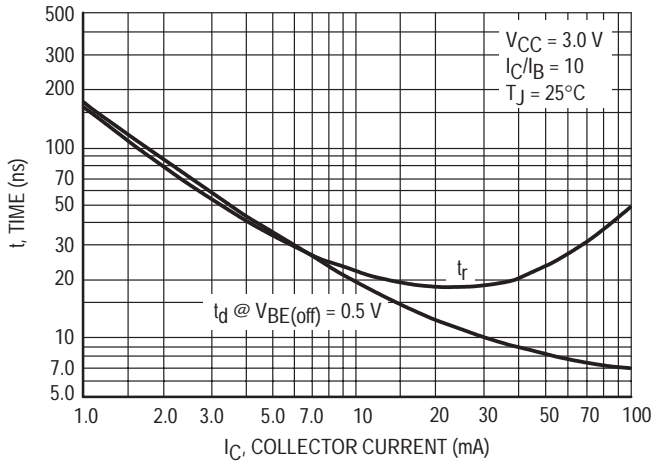


Figure 11. Turn-On Time

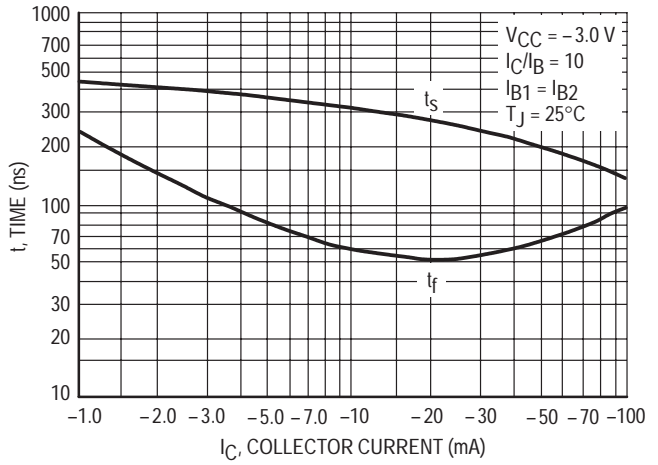


Figure 12. Turn-Off Time

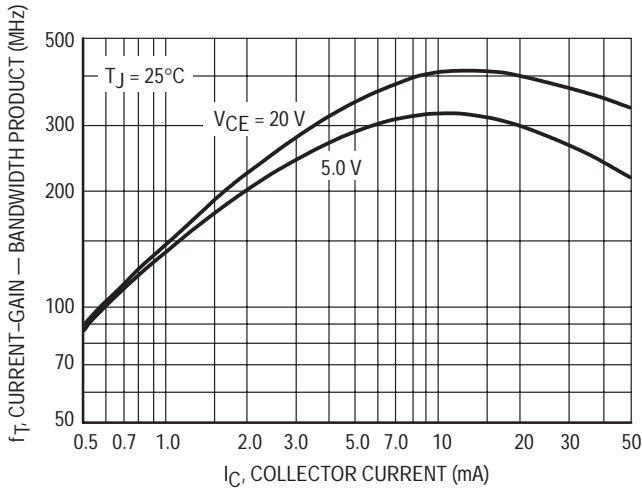


Figure 13. Current-Gain — Bandwidth Product

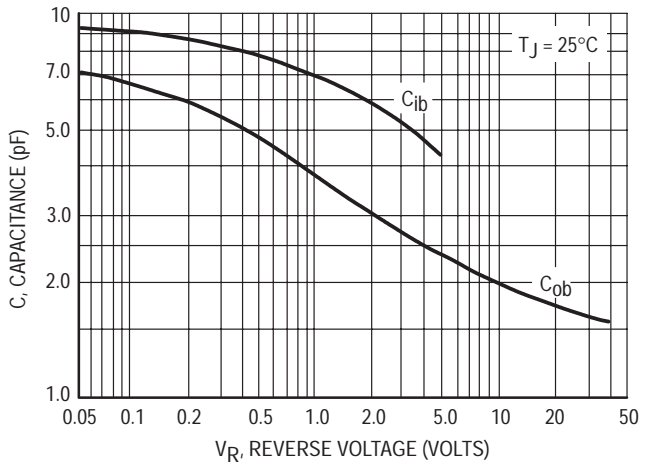


Figure 14. Capacitance

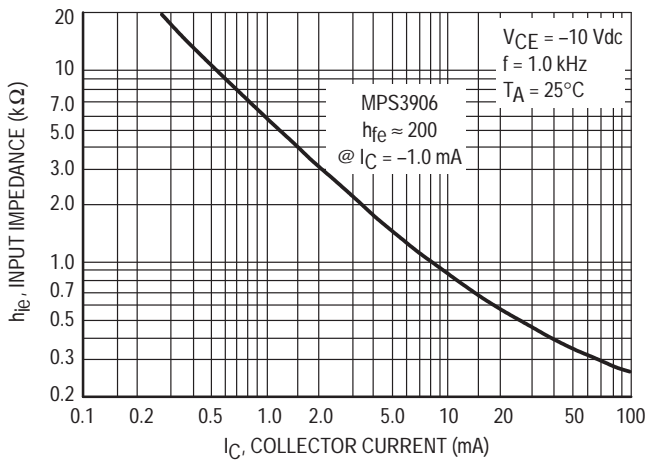


Figure 15. Input Impedance

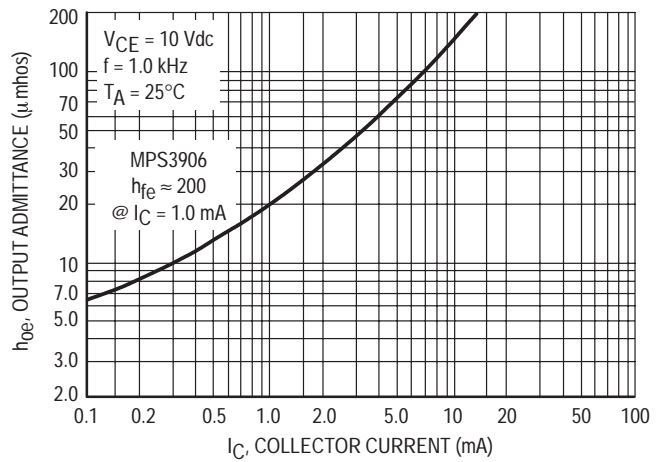


Figure 16. Output Admittance

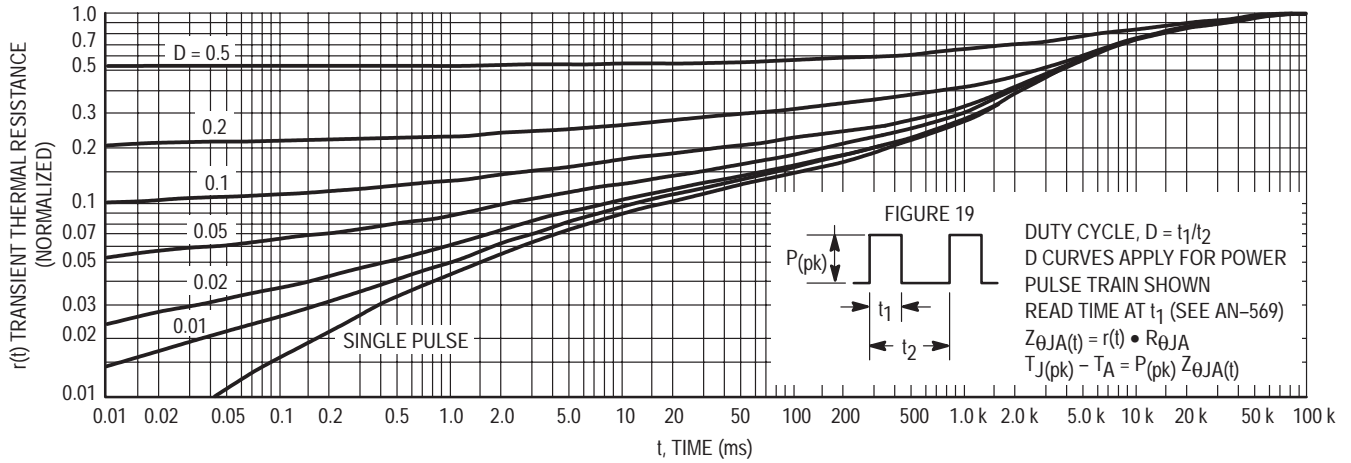


Figure 17. Thermal Response

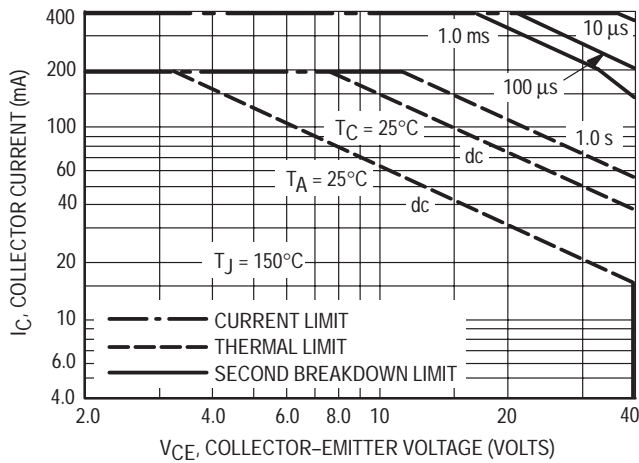


Figure 18. Active-Region Safe Operating Area

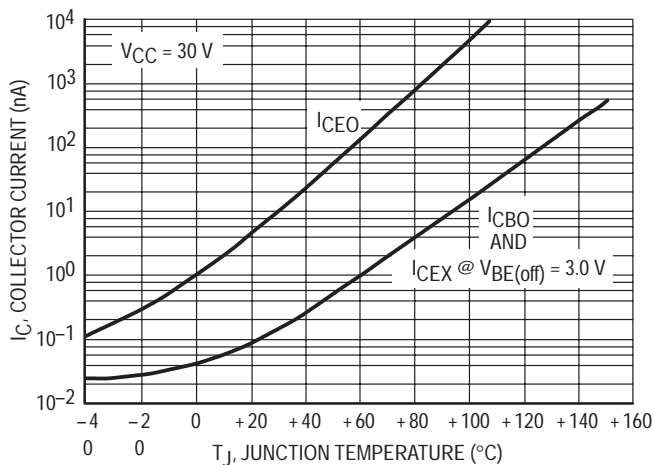


Figure 19. Typical Collector Leakage Current

The safe operating area curves indicate I_C - V_{CE} limits of the transistor that must be observed for reliable operation. Collector load lines for specific circuits must fall below the limits indicated by the applicable curve.

The data of Figure 18 is based upon $T_{J(pk)} = 150^\circ C$; T_C or T_A is variable depending upon conditions. Pulse curves are valid for duty cycles to 10% provided $T_{J(pk)} \leq 150^\circ C$. $T_{J(pk)}$ may be calculated from the data in Figure 17. At high case or ambient temperatures, thermal limitations will reduce the power than can be handled to values less than the limitations imposed by second breakdown.

DESIGN NOTE: USE OF THERMAL RESPONSE DATA

A train of periodical power pulses can be represented by the model as shown in Figure 19. Using the model and the device thermal response the normalized effective transient thermal resistance of Figure 17 was calculated for various duty cycles.

To find $Z_{\theta JA}(t)$, multiply the value obtained from Figure 17 by the steady state value $R_{\theta JA}$.

Example:

Dissipating 2.0 watts peak under the following conditions:

$$t_1 = 1.0 \text{ ms}, t_2 = 5.0 \text{ ms} (D = 0.2)$$

Using Figure 17 at a pulse width of 1.0 ms and $D = 0.2$, the reading of $r(t)$ is 0.22.

The peak rise in junction temperature is therefore

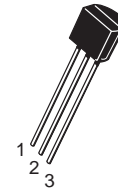
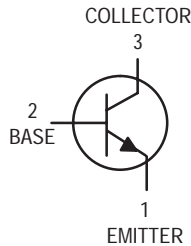
$$\Delta T = r(t) \times P(pk) \times R_{\theta JA} = 0.22 \times 2.0 \times 200 = 88^\circ C.$$

For more information, see AN-569.

Amplifier Transistor

NPN Silicon

MPS4124



CASE 29-04, STYLE 1
TO-92 (TO-226AA)

MAXIMUM RATINGS

Rating	Symbol	Value	Unit
Collector–Emitter Voltage	V_{CE}	25	Vdc
Collector–Base Voltage	V_{CB}	30	Vdc
Emitter–Base Voltage	V_{EB}	5.0	Vdc
Collector Current — Continuous	I_C	200	mAdc
Total Power Dissipation @ $T_A = 25^\circ\text{C}$ Derate above 25°C	P_D	625 5.0	mW mW/ $^\circ\text{C}$
Total Power Dissipation @ $T_C = 25^\circ\text{C}$ Derate above 25°C	P_D	1.5 12	W mW/ $^\circ\text{C}$
Operating and Storage Junction Temperature Range	T_J, T_{stg}	-55 to +150	$^\circ\text{C}$

THERMAL CHARACTERISTICS

Characteristic	Symbol	Max	Unit
Thermal Resistance, Junction to Ambient	$R_{\theta JA}$	200	$^\circ\text{C}/\text{W}$
Thermal Resistance, Junction to Case	$R_{\theta JC}$	83.3	$^\circ\text{C}/\text{W}$

ELECTRICAL CHARACTERISTICS ($T_A = 25^\circ\text{C}$ unless otherwise noted)

Characteristic	Symbol	Min	Max	Unit
----------------	--------	-----	-----	------

OFF CHARACTERISTICS

Collector–Emitter Breakdown Voltage ($I_C = 1.0\text{ mA}, I_B = 0$)	$V_{(BR)CEO}$	25	—	Vdc
Collector–Base Breakdown Voltage ($I_C = 10\ \mu\text{A}, I_E = 0$)	$V_{(BR)CBO}$	30	—	Vdc
Emitter–Base Breakdown Voltage ($I_C = 0, I_E = 10\ \mu\text{A}$)	$V_{(BR)EBO}$	5.0	—	Vdc
Collector Cutoff Current ($V_{CB} = 20\text{ V}, I_E = 0$)	I_{CBO}	—	50	nAdc
Emitter Cutoff Current ($V_{EB} = 3.0\text{ V}, I_C = 0$)	I_{EBO}	—	50	nAdc

(Replaces MPS4123/D)

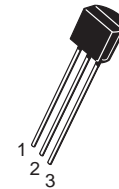
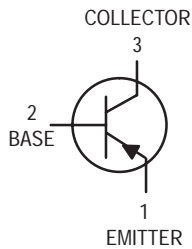
ELECTRICAL CHARACTERISTICS ($T_A = 25^\circ\text{C}$ unless otherwise noted) (Continued)

Characteristic	Symbol	Min	Max	Unit
ON CHARACTERISTICS				
DC Current Gain ($I_C = 2.0\text{ mA}$, $V_{CE} = 1.0\text{ V}$) ($I_C = 50\text{ mA}$, $V_{CE} = 1.0\text{ V}$)	h_{FE}	120 60	360 —	—
Collector–Emitter Saturation Voltage ($I_C = 50\text{ mA}$, $I_B = 5.0\text{ mA}$)	$V_{CE(sat)}$	—	0.3	Vdc
Base–Emitter Saturation Voltage ($I_C = 50\text{ mA}$, $I_B = 5.0\text{ mA}$)	$V_{BE(sat)}$	—	0.95	Vdc
SMALL–SIGNAL CHARACTERISTICS				
Current–Gain — Bandwidth Product ($I_C = 10\text{ mA}$, $V_{CE} = 20\text{ V}$, $f = 100\text{ MHz}$)	f_T	170	—	MHz
Output Capacitance ($V_{CB} = 5.0\text{ V}$, $I_E = 0$, $f = 1.0\text{ MHz}$)	C_{ob}	—	4.0	pF
Input Capacitance ($V_{EB} = 0.5\text{ V}$, $I_C = 0$, $f = 1.0\text{ MHz}$)	C_{ib}	—	13.5	pF
Small–Signal Current Gain ($I_C = 2.0\text{ mA}$, $V_{CE} = 1.0\text{ V}$, $f = 1.0\text{ kHz}$)	h_{fe}	120	480	—
Noise Figure ($I_C = 100\text{ }\mu\text{A}$, $V_{CE} = 5.0\text{ V}$, $R_S = 1.0\text{ k}\Omega$, $f = 1.0\text{ kHz}$)	NF	—	5.0	dB

Amplifier Transistor

PNP Silicon

MPS4126



CASE 29-04, STYLE 1
TO-92 (TO-226AA)

MAXIMUM RATINGS

Rating	Symbol	Value	Unit
Collector–Emitter Voltage	V_{CE}	–25	Vdc
Collector–Base Voltage	V_{CB}	–25	Vdc
Emitter–Base Voltage	V_{EB}	–4.0	Vdc
Collector Current — Continuous	I_C	–200	mAdc
Total Power Dissipation @ $T_A = 25^\circ\text{C}$ Derate above 25°C	P_D	625 5.0	mW mW/ $^\circ\text{C}$
Total Power Dissipation @ $T_C = 25^\circ\text{C}$ Derate above 25°C	P_D	1.5 12	W mW/ $^\circ\text{C}$
Operating and Storage Junction Temperature Range	T_J, T_{stg}	–55 to +150	$^\circ\text{C}$

THERMAL CHARACTERISTICS

Characteristic	Symbol	Max	Unit
Thermal Resistance, Junction to Ambient	$R_{\theta JA}$	200	$^\circ\text{C}/\text{W}$
Thermal Resistance, Junction to Case	$R_{\theta JC}$	83.3	$^\circ\text{C}/\text{W}$

ELECTRICAL CHARACTERISTICS ($T_A = 25^\circ\text{C}$ unless otherwise noted)

Characteristic	Symbol	Min	Max	Unit
----------------	--------	-----	-----	------

OFF CHARACTERISTICS

Collector–Emitter Breakdown Voltage ($I_C = -1.0\text{ mA}, I_B = 0$)	$V_{(BR)CEO}$	–25	—	Vdc
Collector–Base Breakdown Voltage ($I_C = -10\text{ }\mu\text{A}, I_E = 0$)	$V_{(BR)CBO}$	–25	—	Vdc
Emitter–Base Breakdown Voltage ($I_C = 0, I_E = -10\text{ }\mu\text{A}$)	$V_{(BR)EBO}$	–4.0	—	Vdc
Collector Cutoff Current ($V_{CB} = -20\text{ V}, I_E = 0$)	I_{CBO}	—	–50	nAdc
Emitter Cutoff Current ($V_{EB} = -3.0\text{ V}, I_C = 0$)	I_{EBO}	—	–50	nAdc

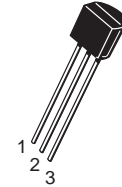
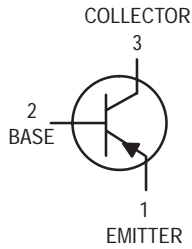
(Replaces MPS4125/D)

ELECTRICAL CHARACTERISTICS ($T_A = 25^\circ\text{C}$ unless otherwise noted) (Continued)

Characteristic	Symbol	Min	Max	Unit
ON CHARACTERISTICS				
DC Current Gain ($I_C = -2.0\text{ mA}$, $V_{CE} = -1.0\text{ V}$) ($I_C = -50\text{ mA}$, $V_{CE} = -1.0\text{ V}$)	h_{FE}	120 60	360 —	—
Collector–Emitter Saturation Voltage ($I_C = -50\text{ mA}$, $I_B = -5.0\text{ mA}$)	$V_{CE(sat)}$	—	-0.4	Vdc
Base–Emitter Saturation Voltage ($I_C = -50\text{ mA}$, $I_B = -5.0\text{ mA}$)	$V_{BE(sat)}$	—	-0.95	Vdc
SMALL–SIGNAL CHARACTERISTICS				
Current–Gain — Bandwidth Product ($I_C = -10\text{ mA}$, $V_{CE} = -20\text{ V}$, $f = 100\text{ MHz}$)	f_T	170	—	MHz
Output Capacitance ($V_{CB} = -5.0\text{ V}$, $I_E = 0$, $f = 1.0\text{ MHz}$)	C_{ob}	—	4.5	pF
Input Capacitance ($V_{EB} = -0.5\text{ V}$, $I_C = 0$, $f = 1.0\text{ MHz}$)	C_{ib}	—	11.5	pF
Small–Signal Current Gain ($I_C = -2.0\text{ mA}$, $V_{CE} = 1.0\text{ V}$, $f = 1.0\text{ kHz}$)	h_{fe}	120	480	—
Noise Figure ($I_C = -100\text{ }\mu\text{A}$, $V_{CE} = -5.0\text{ V}$, $R_S = 1.0\text{ k}\Omega$, $f = 1.0\text{ kHz}$)	NF	—	4.0	dB

Transistor
PNP Silicon

MPS4250



CASE 29-04, STYLE 1
TO-92 (TO-226AA)

MAXIMUM RATINGS

Rating	Symbol	Value	Unit
Collector–Emitter Voltage	V_{CEO}	–40	Vdc
Collector–Emitter Voltage	V_{CES}	–40	Vdc
Collector–Base Voltage	V_{CBO}	–40	Vdc
Emitter–Base Voltage	V_{EBO}	–5.0	Vdc
Collector Current — Continuous	I_C	—	mAdc
Total Device Dissipation @ $T_A = 25^\circ\text{C}$ Derate above 25°C	P_D	625 5.0	mW mW/ $^\circ\text{C}$
Total Device Dissipation @ $T_C = 25^\circ\text{C}$ Derate above 25°C	P_D	1.5 12	mW mW/ $^\circ\text{C}$
Operating and Storage Junction Temperature Range	T_J, T_{stg}	–55 to +150	$^\circ\text{C}$

THERMAL CHARACTERISTICS

Characteristic	Symbol	Max	Unit
Thermal Resistance, Junction to Ambient	$R_{\theta JA}$	200	$^\circ\text{C}/\text{W}$
Thermal Resistance, Junction to Case	$R_{\theta JC}$	83.3	$^\circ\text{C}/\text{W}$

ELECTRICAL CHARACTERISTICS ($T_A = 25^\circ\text{C}$ unless otherwise noted)

Characteristic	Symbol	Min	Max	Unit
----------------	--------	-----	-----	------

OFF CHARACTERISTICS

Collector–Emitter Breakdown Voltage ($I_C = -5.0\text{ mA}$)	$V_{(BR)CES}$	–40	—	Vdc
Collector–Emitter Sustaining Voltage ⁽¹⁾ ($I_C = -5.0$)	$V_{(BR)CEO(sus)}$	–40	—	Vdc
Collector–Base Breakdown Voltage ($I_C = -10\ \mu\text{A}$)	$V_{(BR)CBO}$	–40	—	Vdc
Emitter–Base Breakdown Voltage ($I_E = -10\ \mu\text{A}$)	$V_{(BR)EBO}$	–5.0	—	Vdc
Collector Cutoff Current ($V_{CB} = -50\text{ V}$) ($V_{CB} = -40\text{ V}, T_A = 65^\circ\text{C}$)	I_{CBO}	—	–10 –3.0	nA μA
Emitter Cutoff Current ($V_{EB} = -3.0\text{ V}$)	I_{EBO}	—	–20	nA

1. Pulse Test: Pulse Width = 300 μs ; Duty Cycle = 2.0%.

ELECTRICAL CHARACTERISTICS ($T_A = 25^\circ\text{C}$ unless otherwise noted) (Continued)

Characteristic	Symbol	Min	Max	Unit
ON CHARACTERISTICS				
DC Current Gain ($I_C = -1.0\text{ mA}$, $V_{CE} = -5.0\text{ V}$) ($I_C = -10\text{ mA}$, $V_{CE} = -5.0\text{ V}$)	h_{FE}	250 250	— —	—
Collector–Emitter Saturation Voltage ⁽¹⁾ ($I_C = -10\text{ mA}$, $I_B = -0.5\text{ mA}$)	$V_{CE(sat)}$	—	-0.25	Vdc
Base–Emitter Saturation Voltage ⁽¹⁾ ($I_C = -10\text{ mA}$, $I_B = -0.5\text{ mA}$)	$V_{BE(sat)}$	—	-0.9	Vdc
SMALL–SIGNAL CHARACTERISTICS				
Output Capacitance ($V_{CB} = -5.0\text{ V}$, $f = 1.0\text{ MHz}$)	C_{obo}	—	6.0	pF
Input Capacitance ($V_{EB} = -0.5\text{ V}$, $f = 1.0\text{ MHz}$)	C_{ibo}	—	16	pF
Small–Signal Current Gain ($I_C = -1.0\text{ mA}$, $V_{CE} = -5.0\text{ V}$, $f = 1.0\text{ kHz}$) ($I_C = -0.5\text{ mA}$, $V_{CE} = -5.0\text{ V}$, $f = 20\text{ MHz}$)	h_{fe}	250 2.0	800 —	—
Noise Figure ($I_C = -20\text{ }\mu\text{A}$, $V_{CE} = -5.0\text{ V}$, $R_S = 10\text{ k}\Omega$, $f = 1.0\text{ kHz}$, $P_{BW} = 150\text{ Hz}$) ($I_C = -250\text{ }\mu\text{A}$, $V_{CE} = -5.0\text{ V}$, $R_S = 1.0\text{ k}\Omega$, $f = 1.0\text{ kHz}$, $P_{BW} = 150\text{ Hz}$)	NF	— —	2.0 2.0	dB

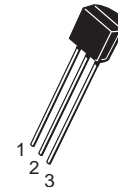
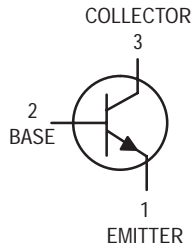
1. Pulse Test: Pulse Width = 300 μs ; Duty Cycle = 2.0%.

High Frequency Transistor

NPN Silicon

MPS5179

Motorola Preferred Device



CASE 29-04, STYLE 1
TO-92 (TO-226AA)

MAXIMUM RATINGS

Rating	Symbol	Value	Unit
Collector–Emitter Voltage	V_{CEO}	12	Vdc
Collector–Base Voltage	V_{CBO}	20	Vdc
Emitter–Base Voltage	V_{EBO}	2.5	Vdc
Collector Current — Continuous	I_C	50	mAdc
Total Device Dissipation @ $T_A = 25^\circ\text{C}$ Derate above 25°C	P_D	200 1.14	mW mW/ $^\circ\text{C}$
Total Device Dissipation @ $T_C = 25^\circ\text{C}$ Derate above 25°C	P_D	300 1.71	mW mW/ $^\circ\text{C}$
Storage Temperature Range	T_{stg}	-55 to +150	$^\circ\text{C}$

ELECTRICAL CHARACTERISTICS ($T_A = 25^\circ\text{C}$ unless otherwise noted)

Characteristic	Symbol	Min	Max	Unit
----------------	--------	-----	-----	------

OFF CHARACTERISTICS

Collector–Emitter Sustaining Voltage ($I_C = 3.0$ mAdc, $I_B = 0$)	$V_{CEO(sus)}$	12	—	Vdc
Collector–Base Breakdown Voltage ($I_C = 0.001$ mAdc, $I_E = 0$)	$V_{(BR)CBO}$	20	—	Vdc
Emitter–Base Breakdown Voltage ($I_E = 0.01$ mAdc, $I_C = 0$)	$V_{(BR)EBO}$	2.5	—	Vdc
Collector Cutoff Current ($V_{CB} = 15$ Vdc, $I_E = 0$) ($V_{CB} = 15$ Vdc, $I_E = 0$, $T_A = 150^\circ\text{C}$)	I_{CBO}	— —	0.02 1.0	μAdc

ON CHARACTERISTICS

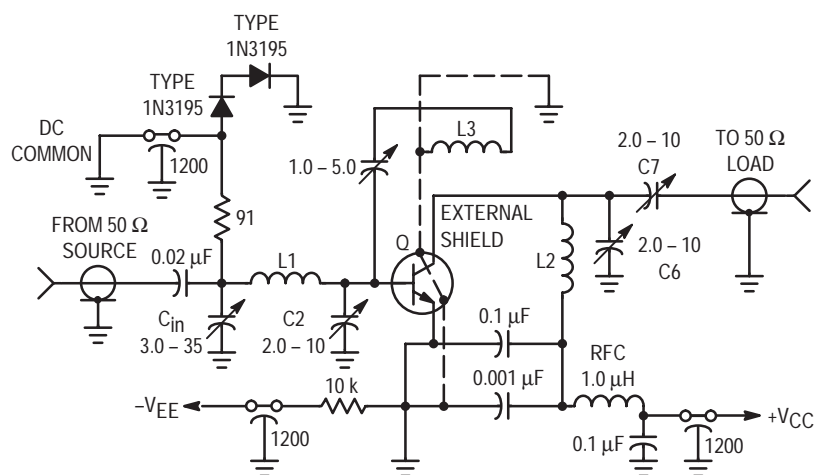
DC Current Gain ($I_C = 3.0$ mAdc, $V_{CE} = 1.0$ Vdc)	h_{FE}	25	250	—
Collector–Emitter Saturation Voltage ($I_C = 10$ mAdc, $I_B = 1.0$ mAdc)	$V_{CE(sat)}$	—	0.4	Vdc
Base–Emitter Saturation Voltage ($I_C = 10$ mAdc, $I_B = 1.0$ mAdc)	$V_{BE(sat)}$	—	1.0	Vdc

Preferred devices are Motorola recommended choices for future use and best overall value.

ELECTRICAL CHARACTERISTICS ($T_A = 25^\circ\text{C}$ unless otherwise noted) (Continued)

Characteristic	Symbol	Min	Max	Unit
SMALL-SIGNAL CHARACTERISTICS				
Current-Gain — Bandwidth Product ⁽¹⁾ ($I_C = 5.0 \text{ mA dc}$, $V_{CE} = 6.0 \text{ V dc}$, $f = 100 \text{ MHz}$)	f_T	900	2000	MHz
Collector-Base Capacitance ($V_{CB} = 10 \text{ V dc}$, $I_E = 0$, $f = 0.1$ to 1.0 MHz)	C_{cb}	—	1.0	pF
Small Signal Current Gain ($I_C = 2.0 \text{ mA dc}$, $V_{CE} = 6.0 \text{ V dc}$, $f = 1.0 \text{ kHz}$)	h_{fe}	25	300	—
Collector Base Time Constant ($I_E = 2.0 \text{ mA dc}$, $V_{CB} = 6.0 \text{ V dc}$, $f = 31.9 \text{ MHz}$)	$r_b' C_C$	3.0	14	ps
Noise Figure (See Figure 1) ($I_C = 1.5 \text{ mA dc}$, $V_{CE} = 6.0 \text{ V dc}$, $R_S = 50 \text{ ohms}$, $f = 200 \text{ MHz}$)	NF	—	5.0	dB
Common-Emitter Amplifier Power Gain (See Figure 1) ($V_{CE} = 6.0 \text{ V dc}$, $I_C = 5.0 \text{ mA dc}$, $f = 200 \text{ MHz}$)	G_{pe}	15	—	dB

1. f_T is defined as the frequency at which $|h_{fe}|$ extrapolates to unity.



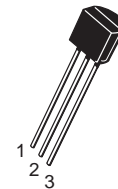
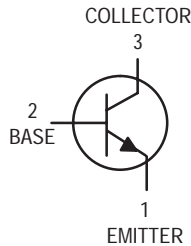
- L1 1-3/4 Turns, #18 AWG, 0.5" L, 0.5" Diameter
 L2 2 Turns, #16 AWG, 0.5" L, 0.5" Diameter
 L3 2 Turns, #13 AWG, 0.25" L, 0.5" Diameter (Position 1/4" from L2)

Figure 1. 200 MHz Amplifier Power Gain and Noise Figure Circuit

Amplifier Transistor

NPN Silicon

MPS6428



CASE 29-04, STYLE 1
TO-92 (TO-226AA)

MAXIMUM RATINGS

Rating	Symbol	Value	Unit
Collector–Emitter Voltage	V_{CEO}	50	Vdc
Collector–Base Voltage	V_{CBO}	60	Vdc
Emitter–Base Voltage	V_{EBO}	6.0	Vdc
Collector Current — Continuous	I_C	200	mAdc
Total Device Dissipation @ $T_A = 25^\circ\text{C}$ Derate above 25°C	P_D	625 5.0	mW mW/ $^\circ\text{C}$
Total Device Dissipation @ $T_C = 25^\circ\text{C}$ Derate above 25°C	P_D	1.5 12	Watts mW/ $^\circ\text{C}$
Operating and Storage Junction Temperature Range	T_J, T_{stg}	-55 to +150	$^\circ\text{C}$

THERMAL CHARACTERISTICS

Characteristic	Symbol	Max	Unit
Thermal Resistance, Junction to Ambient	$R_{\theta JA}$	200	$^\circ\text{C}/\text{W}$
Thermal Resistance, Junction to Case	$R_{\theta JC}$	83.3	$^\circ\text{C}/\text{W}$

ELECTRICAL CHARACTERISTICS ($T_A = 25^\circ\text{C}$ unless otherwise noted)

Characteristic	Symbol	Min	Max	Unit
----------------	--------	-----	-----	------

OFF CHARACTERISTICS

Collector–Emitter Breakdown Voltage ($I_C = 1.0$ mAdc, $I_B = 0$)	$V_{(BR)CEO}$	50	—	Vdc
Collector–Base Breakdown Voltage ($I_C = 0.1$ mAdc, $I_E = 0$)	$V_{(BR)CBO}$	60	—	Vdc
Collector Cutoff Current ($V_{CE} = 30$ Vdc)	I_{CES}	—	0.025	μA
Collector Cutoff Current ($V_{CB} = 30$ Vdc, $I_E = 0$)	I_{CBO}	—	0.01	μA
Emitter Cutoff Current ($V_{EB} = 5.0$ Vdc, $I_C = 0$)	I_{EBO}	—	0.01	μA

ELECTRICAL CHARACTERISTICS ($T_A = 25^\circ\text{C}$ unless otherwise noted) (Continued)

Characteristic	Symbol	Min	Max	Unit
ON CHARACTERISTICS				
DC Current Gain ($V_{CE} = 5.0\text{ Vdc}$, $I_C = 0.01\text{ mA}$) ($V_{CE} = 5.0\text{ Vdc}$, $I_C = 0.1\text{ mA}$) ($V_{CE} = 5.0\text{ Vdc}$, $I_C = 1.0\text{ mA}$) ($V_{CE} = 5.0\text{ Vdc}$, $I_C = 10\text{ mA}$)	h_{FE}	250 250 250 250	— 650 — —	—
Collector–Emitter Saturation Voltage ($I_C = 10\text{ mA}$, $I_B = 0.5\text{ mA}$) ($I_C = 100\text{ mA}$, $I_B = 5.0\text{ mA}$)	$V_{CE(sat)}$	— —	0.2 0.6	Vdc
Base–Emitter On Voltage ($I_C = 1.0\text{ mA}$, $V_{CE} = 5.0\text{ Vdc}$)	$V_{BE(on)}$	0.56	0.66	Vdc

SMALL–SIGNAL CHARACTERISTICS

Current–Gain — Bandwidth Product ($I_C = 1.0\text{ mA}$, $V_{CE} = 5.0\text{ V}$, $f = 100\text{ MHz}$)	f_T	100	700	MHz
Output Capacitance ($V_{CB} = 10\text{ Vdc}$, $I_E = 0$, $f = 1.0\text{ MHz}$)	C_{obo}	—	3.0	pF
Input Capacitance ($V_{EB} = 0.5\text{ Vdc}$, $I_C = 0$, $f = 1.0\text{ MHz}$)	C_{ibo}	—	8.0	pF
Input Impedance ($I_C = 1.0\text{ mA}$, $V_{CE} = 5.0\text{ Vdc}$, $f = 1.0\text{ kHz}$)	h_{ie}	3.0	30	k Ω
Voltage Feedback Ratio ($I_C = 1.0\text{ mA}$, $V_{CE} = 5.0\text{ Vdc}$, $f = 1.0\text{ kHz}$)	h_{re}	2.0	20	$\times 10^{-4}$
Small–Signal Current Gain ($I_C = 1.0\text{ mA}$, $V_{CE} = 5.0\text{ Vdc}$, $f = 1.0\text{ kHz}$)	h_{fe}	200	800	—
Output Admittance ($I_C = 1.0\text{ mA}$, $V_{CE} = 5.0\text{ Vdc}$, $f = 1.0\text{ kHz}$)	h_{oe}	5.0	50	μmhos

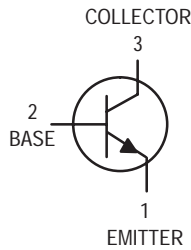
NOISE FIGURE/TOTAL NOISE VOLTAGE CHARACTERISTICS

	NF VT		NF VT		NF VT		Unit	
	Max (1)		Max (2)		Max (3)			
Noise Figure/Voltage ($V_{CE} = 5.0\text{ V}$, $I_C = 0.1\text{ mA}$, $T_A = 25^\circ\text{C}$)	7.0	18.1	6.0	5700	3.5	4.3	dB	nV

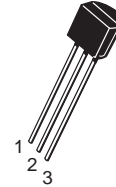
- $R_S = 10\text{ k}\Omega$, BW = 1.0 Hz, $f = 100\text{ Hz}$
- $R_S = 50\text{ k}\Omega$, BW = 15.7 kHz, $f = 10\text{ Hz}–10\text{ kHz}$
- $R_S = 500\ \Omega$, BW = 1.0 Hz, $f = 10\text{ Hz}$

Amplifier Transistor

NPN Silicon



MPS6507



CASE 29-04, STYLE 1
TO-92 (TO-226AA)

MAXIMUM RATINGS

Rating	Symbol	Value	Unit
Collector–Emitter Voltage	V_{CEO}	20	Vdc
Collector–Base Voltage	V_{CBO}	30	Vdc
Emitter–Base Voltage	V_{EBO}	3.0	Vdc
Collector Current — Continuous	I_C	50	mAdc
Total Device Dissipation @ $T_A = 25^\circ\text{C}$ Derate above 25°C	P_D	625 5.0	mW mW/ $^\circ\text{C}$
Total Device Dissipation @ $T_C = 25^\circ\text{C}$ Derate above 25°C	P_D	1.5 12	Watts mW/ $^\circ\text{C}$
Operating and Storage Junction Temperature Range	T_J, T_{stg}	-55 to +150	$^\circ\text{C}$

THERMAL CHARACTERISTICS

Characteristic	Symbol	Max	Unit
Thermal Resistance, Junction to Ambient	$R_{\theta JA}^{(1)}$	200	$^\circ\text{C}/\text{W}$
Thermal Resistance, Junction to Case	$R_{\theta JC}$	83.3	$^\circ\text{C}/\text{W}$

ELECTRICAL CHARACTERISTICS ($T_A = 25^\circ\text{C}$ unless otherwise noted)

Characteristic	Symbol	Min	Typ	Max	Unit
----------------	--------	-----	-----	-----	------

OFF CHARACTERISTICS

Collector–Emitter Breakdown Voltage (2) ($I_C = 1.0$ mAdc, $I_B = 0$)	$V_{(BR)CEO}$	20	—	—	Vdc
Collector–Base Breakdown Voltage ($I_C = 100$ μAdc , $I_E = 0$)	$V_{(BR)CBO}$	30	—	—	Vdc
Emitter–Base Breakdown Voltage ($I_E = 100$ μAdc , $I_C = 0$)	$V_{(BR)EBO}$	3.0	—	—	Vdc
Collector Cutoff Current ($V_{CB} = 15$ Vdc, $I_E = 0$) ($V_{CB} = 15$ Vdc, $I_E = 0$, $T_A = 60^\circ\text{C}$)	I_{CBO}	— —	— —	50 1.0	nAdc μAdc

ON CHARACTERISTICS

DC Current Gain(2) ($I_C = 2.0$ mAdc, $V_{CE} = 10$ Vdc)	h_{FE}	25	75	—	—
--------------------------------------------------------------	----------	----	----	---	---

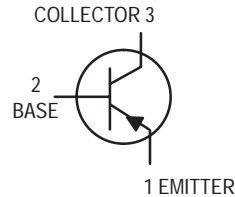
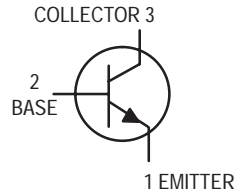
SMALL-SIGNAL CHARACTERISTICS

Current–Gain — Bandwidth Product ($I_C = 10$ mAdc, $V_{CE} = 10$ Vdc, $f = 100$ MHz)	f_T	700	800	—	MHz
Output Capacitance ($V_{CB} = 10$ Vdc, $I_E = 0$, $f = 1.0$ MHz)	C_{obo}	—	1.25	2.5	pF
Small–Signal Current Gain ($I_C = 2.0$ mAdc, $V_{CE} = 10$ Vdc, $f = 20$ MHz)	h_{fe}	20	—	—	—

1. $R_{\theta JA}$ is measured with the device soldered into a typical printed circuit board.

2. Pulse Test: Pulse Width ≤ 300 μs ; Duty Cycle $\leq 2.0\%$.

Amplifier Transistors



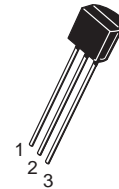
NPN
MPS6521*
PNP
MPS6523

Voltage and current are negative
for PNP transistors

*Motorola Preferred Device

MAXIMUM RATINGS

Rating	Symbol	NPN	PNP	Unit
Collector–Emitter Voltage MPS6521 MPS6523	V_{CEO}	25 —	— 25	Vdc
Collector–Base Voltage MPS6521 MPS6523	V_{CBO}	40 —	— 25	Vdc
Emitter–Base Voltage	V_{EBO}	4.0		Vdc
Collector Current — Continuous	I_C	100		mAdc
Total Device Dissipation @ $T_A = 25^\circ\text{C}$ Derate above 25°C	P_D	625 5.0		mW mW/ $^\circ\text{C}$
Total Device Dissipation @ $T_C = 25^\circ\text{C}$ Derate above 25°C	P_D	1.5 12		Watts mW/ $^\circ\text{C}$
Operating and Storage Junction Temperature Range	T_J, T_{stg}	–55 to +150		$^\circ\text{C}$



CASE 29–04, STYLE 1
TO–92 (TO–226AA)

THERMAL CHARACTERISTICS

Characteristic	Symbol	Max	Unit
Thermal Resistance, Junction to Ambient (Printed Circuit Board Mounting)	$R_{\theta JA}$	200	$^\circ\text{C}/\text{W}$
Thermal Resistance, Junction to Case	$R_{\theta JC}$	83.3	$^\circ\text{C}/\text{W}$

ELECTRICAL CHARACTERISTICS ($T_A = 25^\circ\text{C}$ unless otherwise noted)

Characteristic	Symbol	Min	Max	Unit
----------------	--------	-----	-----	------

OFF CHARACTERISTICS

Collector–Emitter Breakdown Voltage ($I_C = 0.5 \text{ mAdc}$, $I_E = 0$)	$V_{(BR)CEO}$	25	—	Vdc
Emitter–Base Breakdown Voltage ($I_E = 10 \mu\text{Adc}$, $I_C = 0$)	$V_{(BR)EBO}$	4.0	—	Vdc
Collector Cutoff Current ($V_{CB} = 30 \text{ Vdc}$, $I_E = 0$) ($V_{CB} = 20 \text{ Vdc}$, $I_E = 0$)	I_{CBO}	— —	0.05 0.05	μAdc

Preferred devices are Motorola recommended choices for future use and best overall value.

(Replaces MPS6520/D)

NPN MPS6521 PNP MPS6523**ELECTRICAL CHARACTERISTICS** ($T_A = 25^\circ\text{C}$ unless otherwise noted) (Continued)

Characteristic	Symbol	Min	Max	Unit
ON CHARACTERISTICS				
DC Current Gain ($I_C = 100 \mu\text{A}$, $V_{CE} = 10 \text{ Vdc}$)	h_{FE}	150	—	—
($I_C = 2.0 \text{ mA}$, $V_{CE} = 10 \text{ Vdc}$)		300	600	
($I_C = 100 \mu\text{A}$, $V_{CE} = 10 \text{ Vdc}$)		150	—	
($I_C = 2.0 \text{ mA}$, $V_{CE} = 10 \text{ Vdc}$)		300	600	
Collector–Emitter Saturation Voltage ($I_C = 50 \text{ mA}$, $I_B = 5.0 \text{ mA}$)	$V_{CE(sat)}$	—	0.5	Vdc
SMALL–SIGNAL CHARACTERISTICS				
Output Capacitance ($V_{CB} = 10 \text{ Vdc}$, $I_E = 0$, $f = 1.0 \text{ MHz}$)	C_{obo}	—	3.5	pF
Noise Figure ($I_C = 10 \mu\text{A}$, $V_{CE} = 5.0 \text{ Vdc}$, $R_S = 10 \text{ k}\Omega$, Power Bandwidth = 15.7 kHz, 3.0 dB points @ 10 Hz and 10 kHz)	NF	—	3.0	dB

NPN
MPS6521

EQUIVALENT SWITCHING TIME TEST CIRCUITS

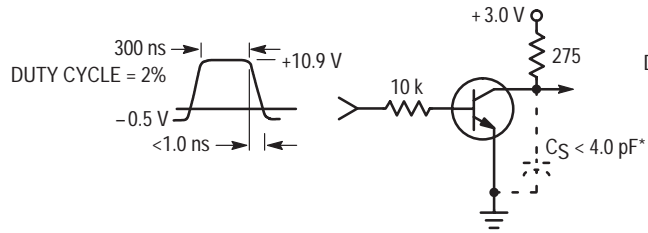


Figure 1. Turn-On Time

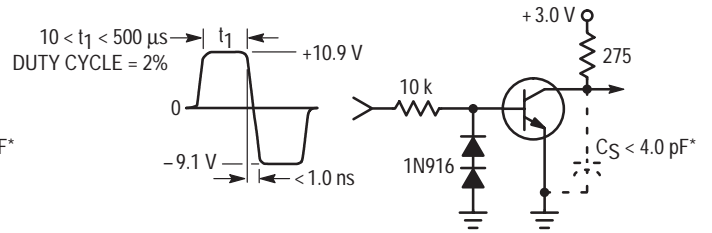


Figure 2. Turn-Off Time

*Total shunt capacitance of test jig and connectors

TYPICAL NOISE CHARACTERISTICS

($V_{CE} = 5.0$ Vdc, $T_A = 25^\circ\text{C}$)

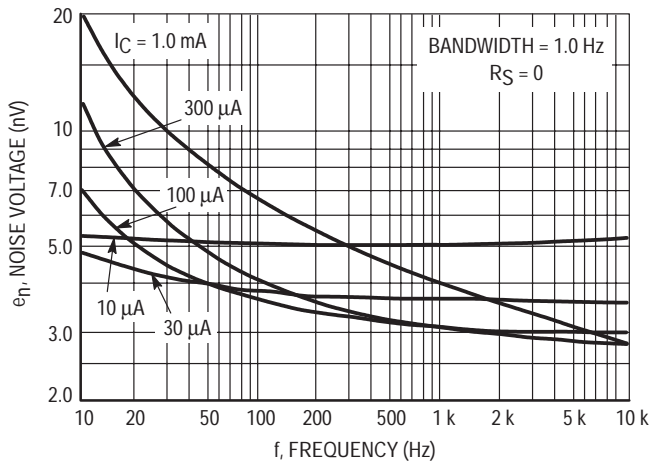


Figure 3. Noise Voltage

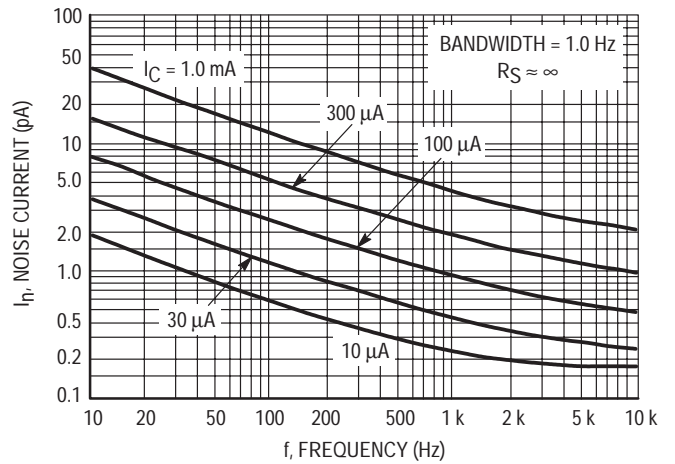


Figure 4. Noise Current

NPN
MPS6521

NOISE FIGURE CONTOURS
(V_{CE} = 5.0 Vdc, T_A = 25°C)

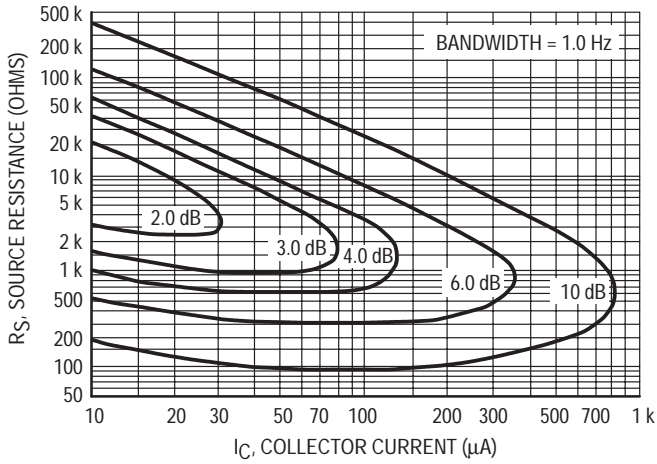


Figure 5. Narrow Band, 100 Hz

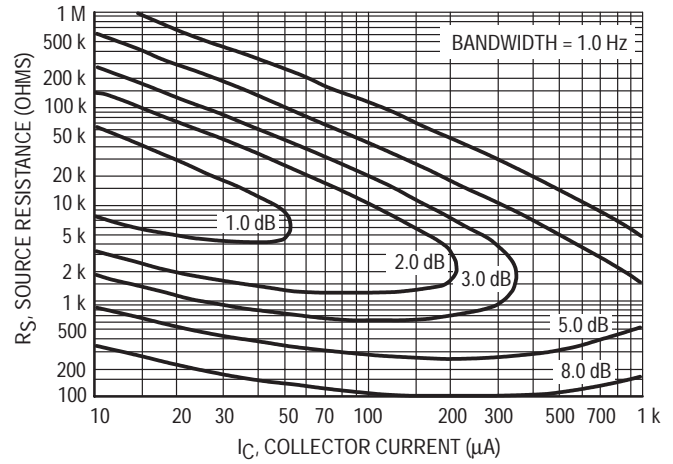


Figure 6. Narrow Band, 1.0 kHz

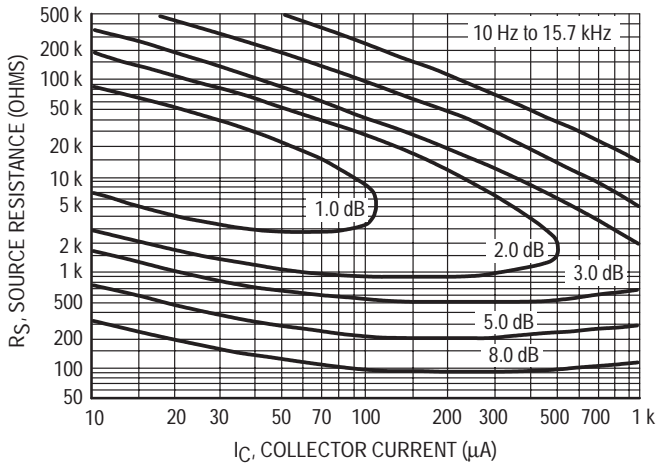


Figure 7. Wideband

Noise Figure is defined as:

$$NF = 20 \log_{10} \left(\frac{e_n^2 + 4KTR_S + I_n^2 R_S^2}{4KTR_S} \right)^{1/2}$$

e_n = Noise Voltage of the Transistor referred to the input. (Figure 3)

I_n = Noise Current of the Transistor referred to the input. (Figure 4)

K = Boltzman's Constant (1.38 x 10⁻²³ j/°K)

T = Temperature of the Source Resistance (°K)

R_S = Source Resistance (Ohms)

NPN
MPS6521

TYPICAL STATIC CHARACTERISTICS

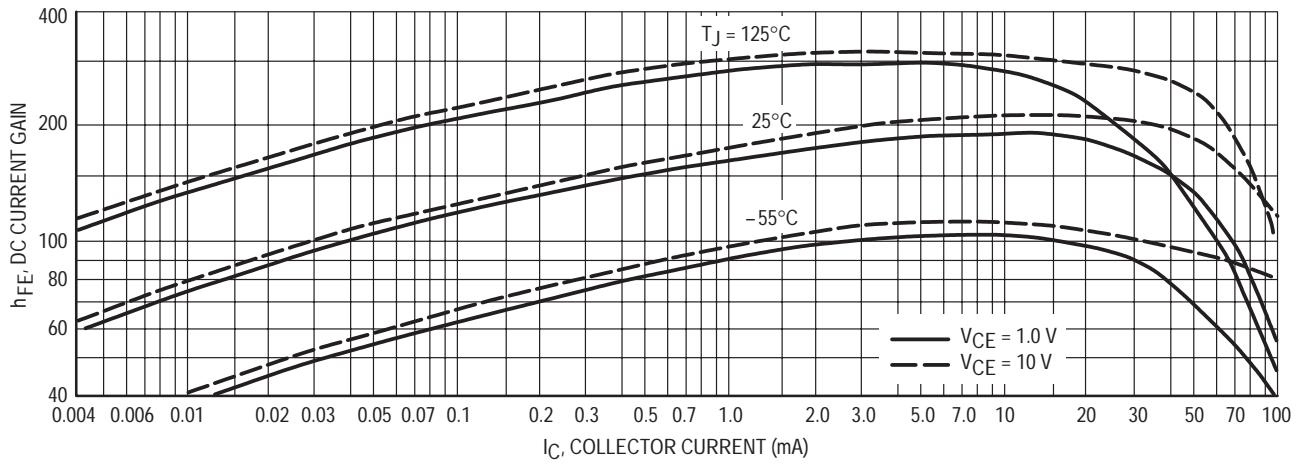


Figure 8. DC Current Gain

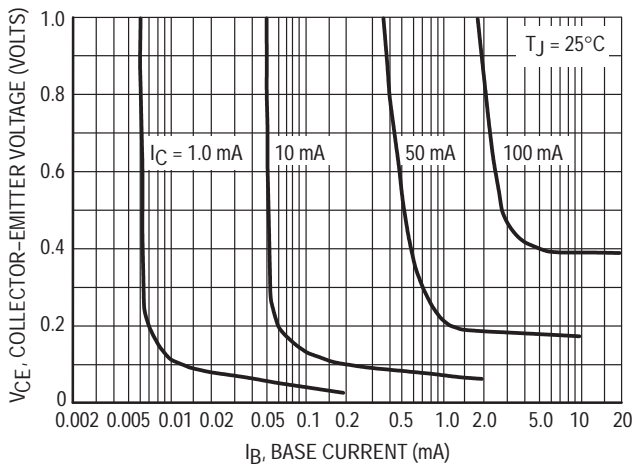


Figure 9. Collector Saturation Region

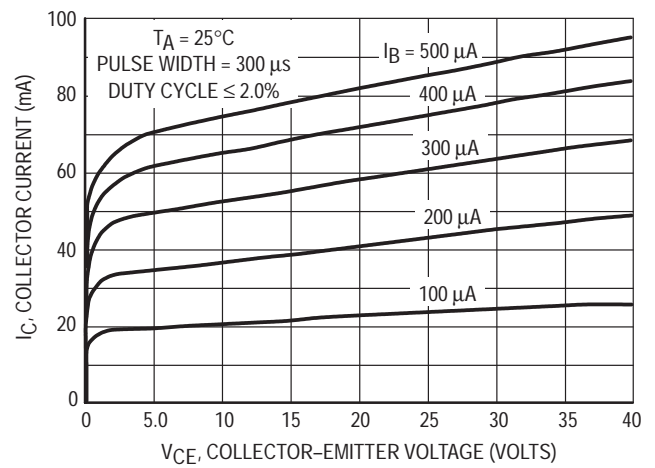


Figure 10. Collector Characteristics

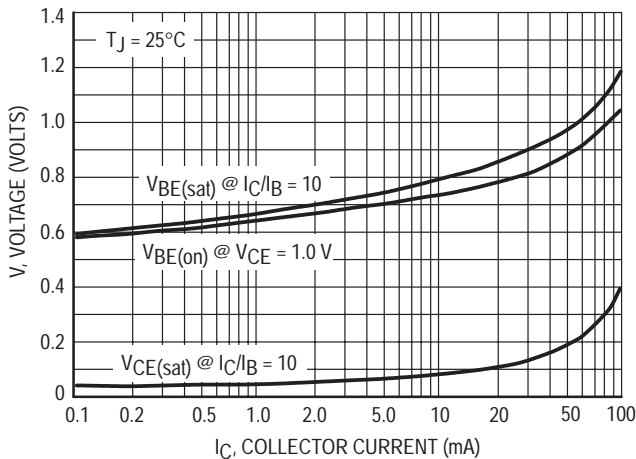


Figure 11. "On" Voltages

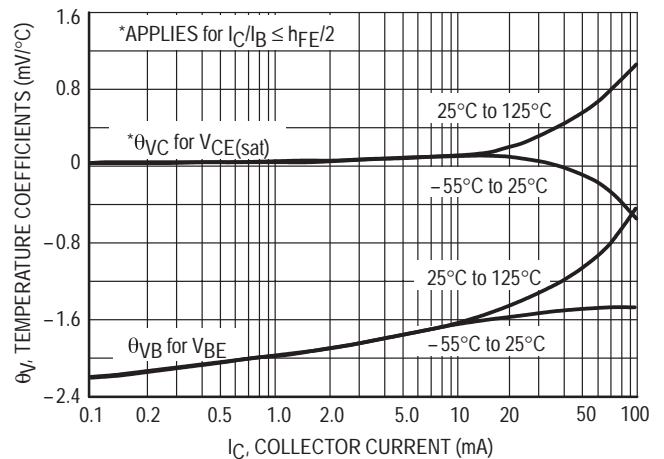


Figure 12. Temperature Coefficients

NPN
MPS6521

TYPICAL DYNAMIC CHARACTERISTICS

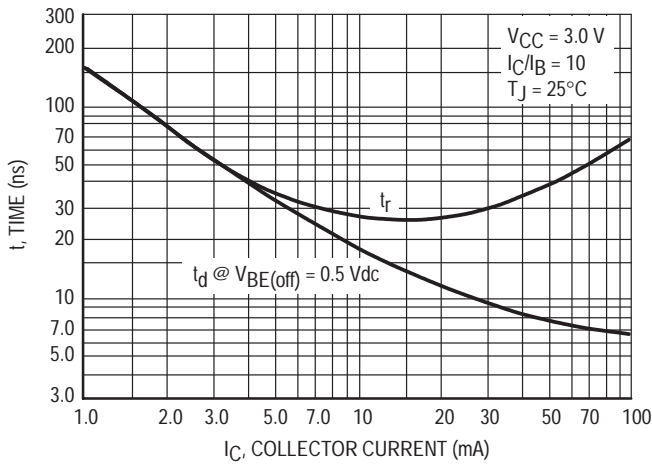


Figure 13. Turn-On Time

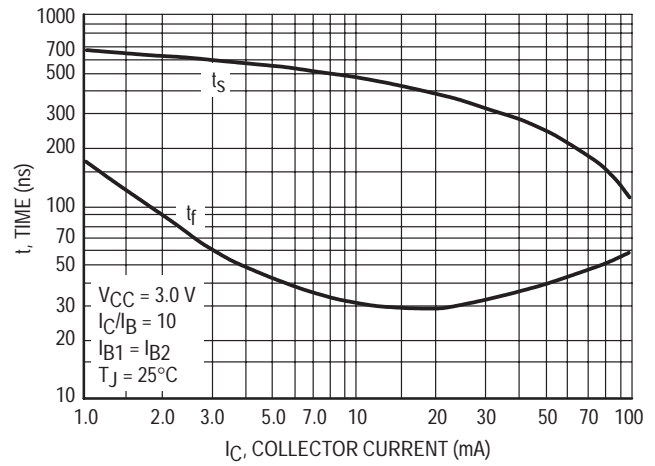


Figure 14. Turn-Off Time

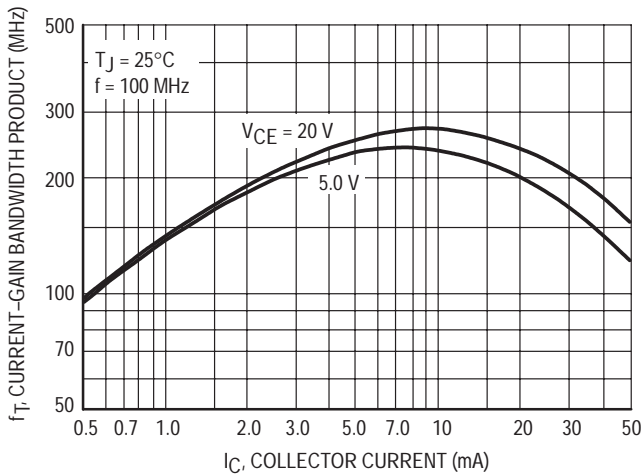


Figure 15. Current-Gain — Bandwidth Product

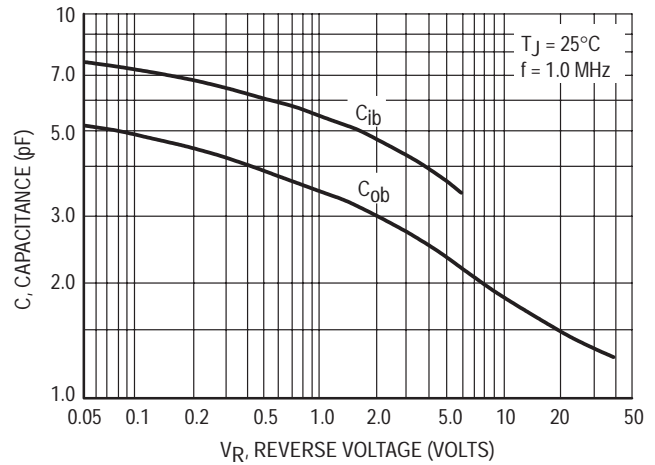


Figure 16. Capacitance

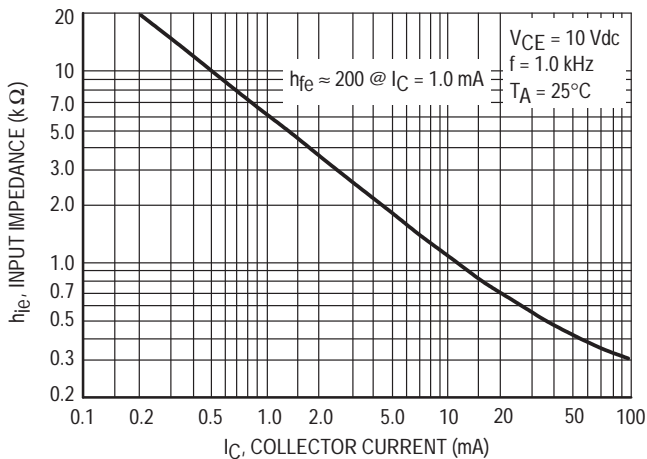


Figure 17. Input Impedance

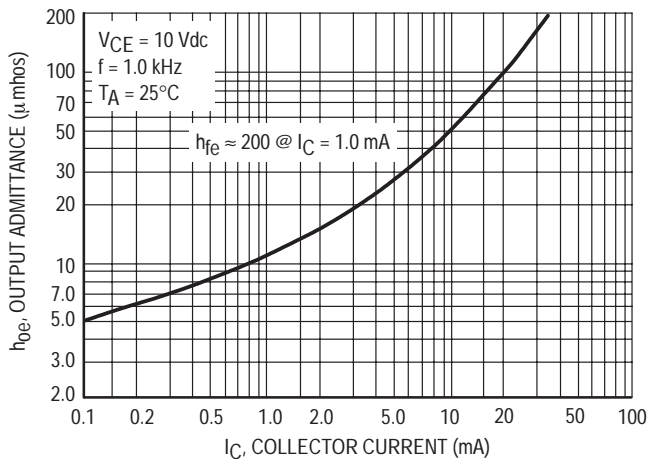


Figure 18. Output Admittance

NPN
MPS6521

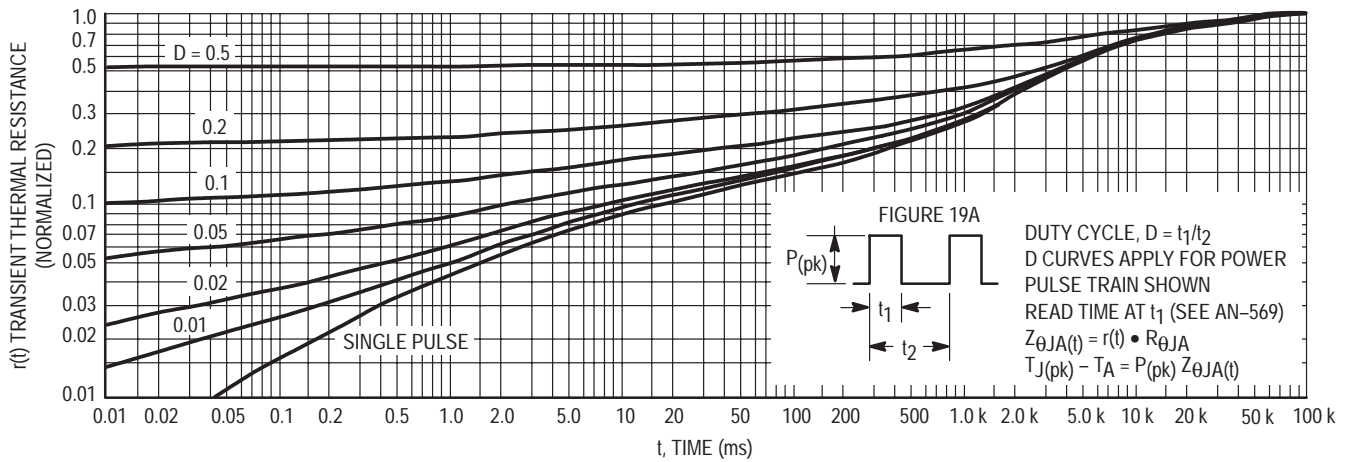


Figure 19. Thermal Response

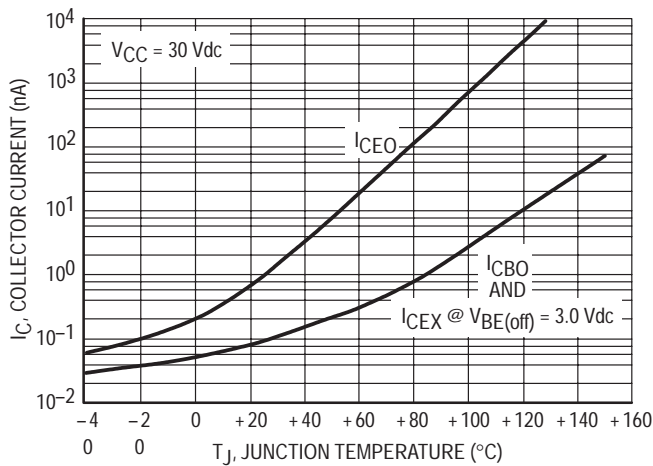


Figure 19A.

DESIGN NOTE: USE OF THERMAL RESPONSE DATA

A train of periodical power pulses can be represented by the model as shown in Figure 19A. Using the model and the device thermal response the normalized effective transient thermal resistance of Figure 19 was calculated for various duty cycles.

To find $Z_{\theta JA}(t)$, multiply the value obtained from Figure 19 by the steady state value $R_{\theta JA}$.

Example:

The MPS6521 is dissipating 2.0 watts peak under the following conditions:

$t_1 = 1.0 \text{ ms}$, $t_2 = 5.0 \text{ ms}$. ($D = 0.2$)

Using Figure 19 at a pulse width of 1.0 ms and $D = 0.2$, the reading of $r(t)$ is 0.22.

The peak rise in junction temperature is therefore $\Delta T = r(t) \times P_{(pk)} \times R_{\theta JA} = 0.22 \times 2.0 \times 200 = 88^\circ\text{C}$.

For more information, see AN-569.

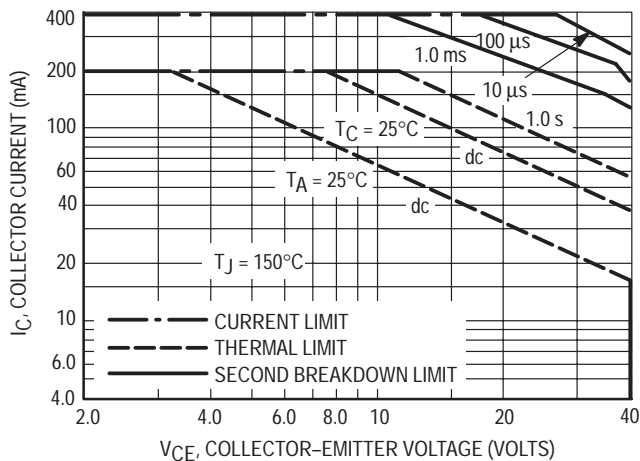


Figure 20.

The safe operating area curves indicate I_C - V_{CE} limits of the transistor that must be observed for reliable operation. Collector load lines for specific circuits must fall below the limits indicated by the applicable curve.

The data of Figure 20 is based upon $T_{J(pk)} = 150^\circ\text{C}$; T_C or T_A is variable depending upon conditions. Pulse curves are valid for duty cycles to 10% provided $T_{J(pk)} \leq 150^\circ\text{C}$. $T_{J(pk)}$ may be calculated from the data in Figure 19. At high case or ambient temperatures, thermal limitations will reduce the power that can be handled to values less than the limitations imposed by second breakdown.

PNP
MPS6523

TYPICAL NOISE CHARACTERISTICS

($V_{CE} = -5.0$ Vdc, $T_A = 25^\circ\text{C}$)

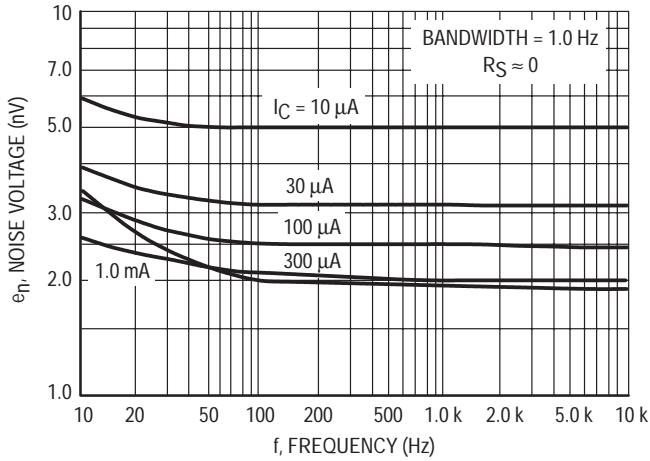


Figure 21. Noise Voltage

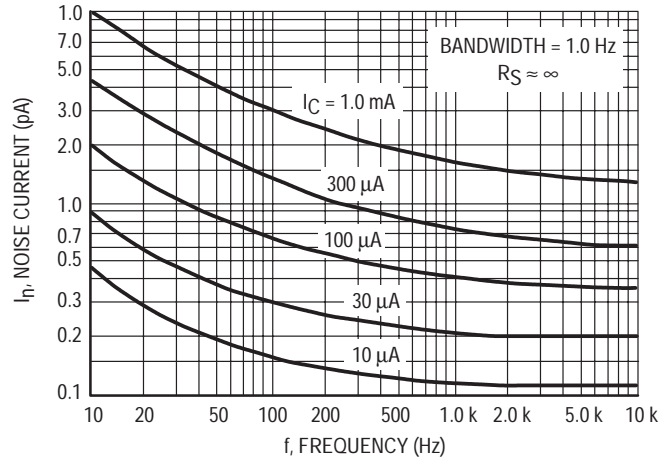


Figure 22. Noise Current

NOISE FIGURE CONTOURS

($V_{CE} = -5.0$ Vdc, $T_A = 25^\circ\text{C}$)

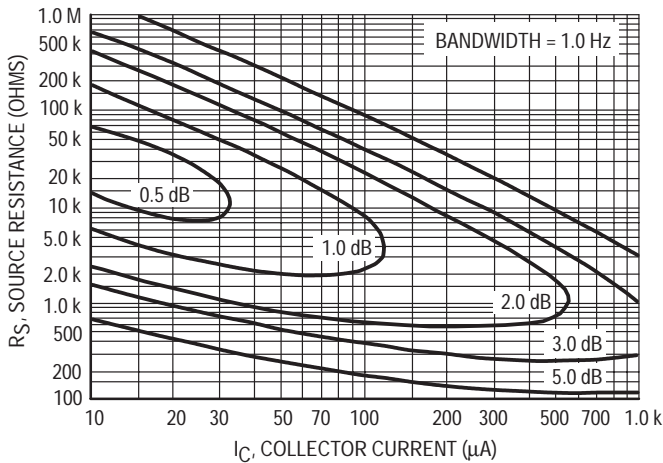


Figure 23. Narrow Band, 100 Hz

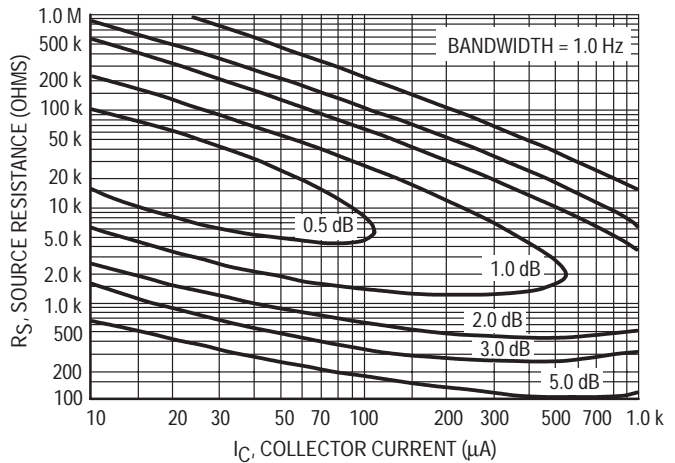


Figure 24. Narrow Band, 1.0 kHz

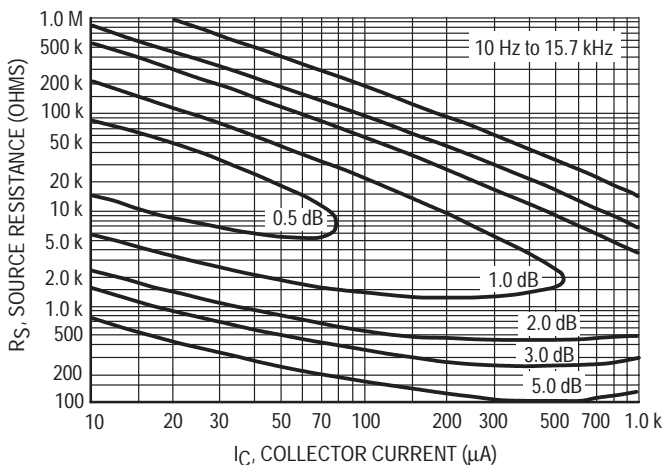


Figure 25. Wideband

Noise Figure is Defined as:

$$NF = 20 \log_{10} \left[\frac{e_n^2 + 4KTR_S + I_n^2 R_S^2}{4KTR_S} \right]^{1/2}$$

e_n = Noise Voltage of the Transistor referred to the input. (Figure 3)

I_n = Noise Current of the Transistor referred to the input. (Figure 4)

K = Boltzman's Constant (1.38×10^{-23} j/°K)

T = Temperature of the Source Resistance (°K)

R_S = Source Resistance (Ohms)

PNP
MPS6523

TYPICAL STATIC CHARACTERISTICS

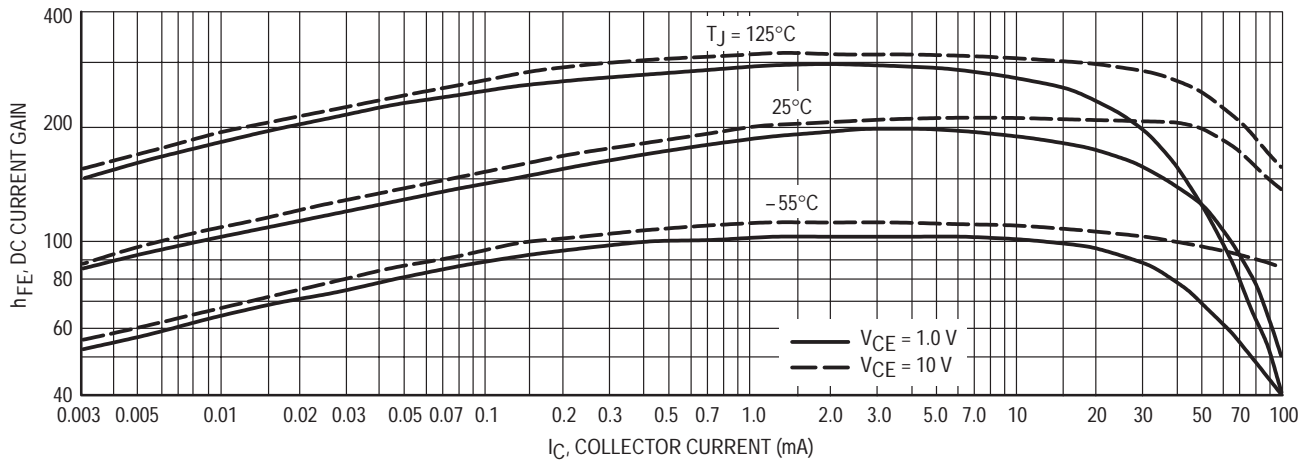


Figure 26. DC Current Gain

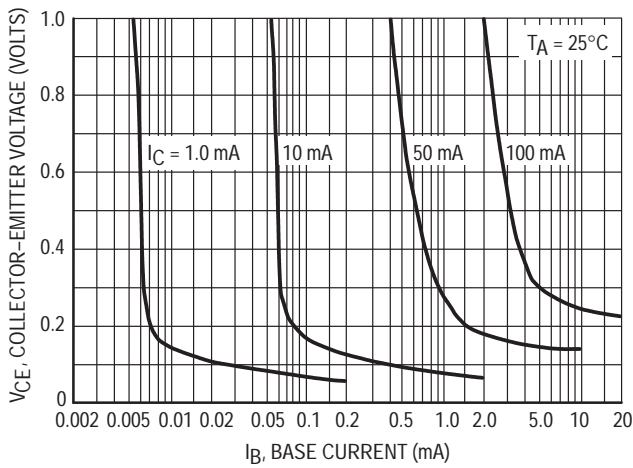


Figure 27. Collector Saturation Region

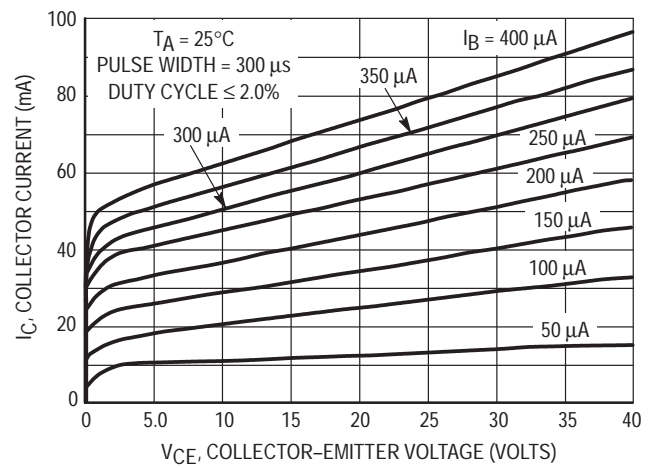


Figure 28. Collector Characteristics

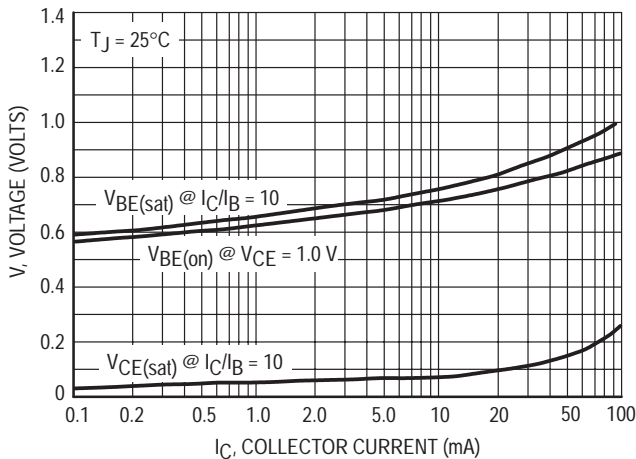


Figure 29. "On" Voltages

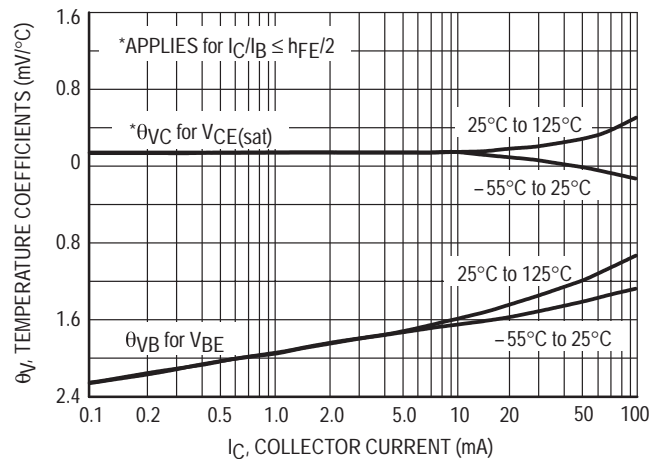


Figure 30. Temperature Coefficients

PNP
MPS6523

TYPICAL DYNAMIC CHARACTERISTICS

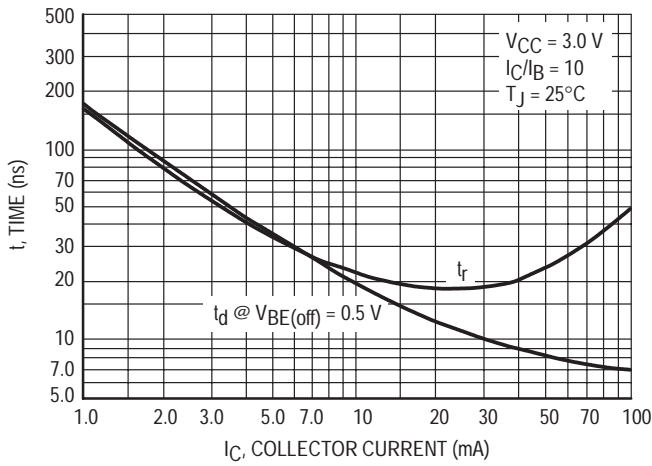


Figure 31. Turn-On Time

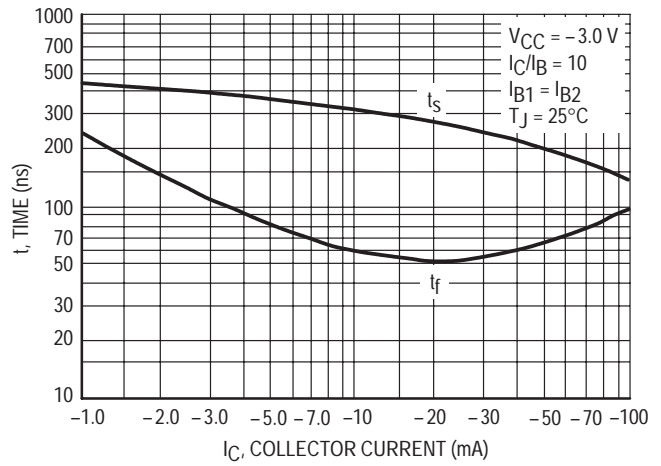


Figure 32. Turn-Off Time

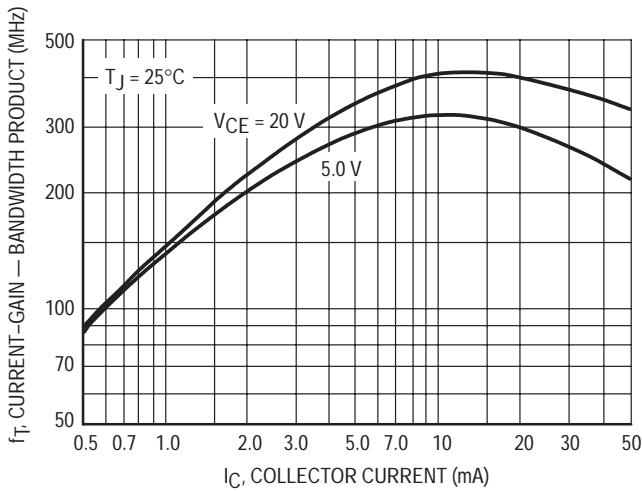


Figure 33. Current-Gain — Bandwidth Product

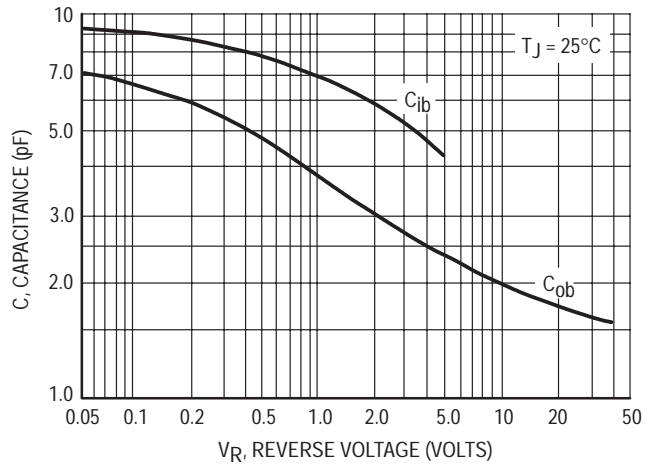


Figure 34. Capacitance

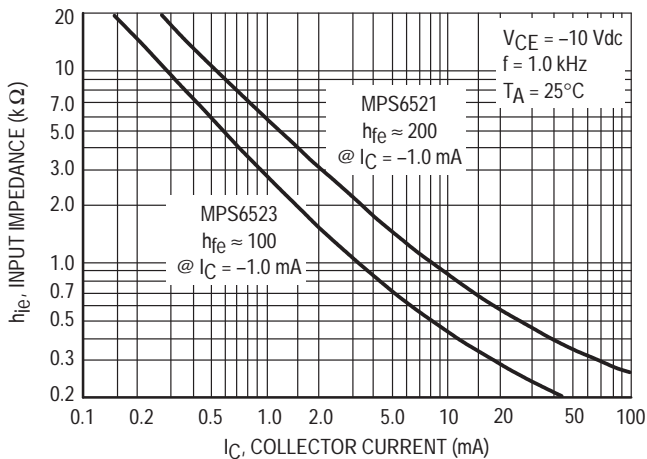


Figure 35. Input Impedance

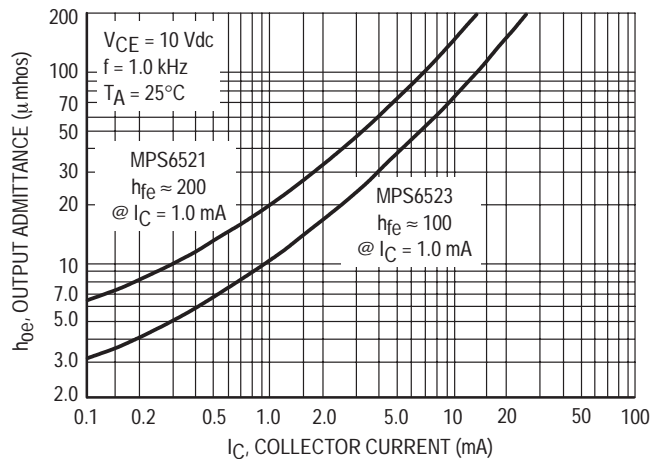


Figure 36. Output Admittance

PNP
MPS6523

TYPICAL DYNAMIC CHARACTERISTICS

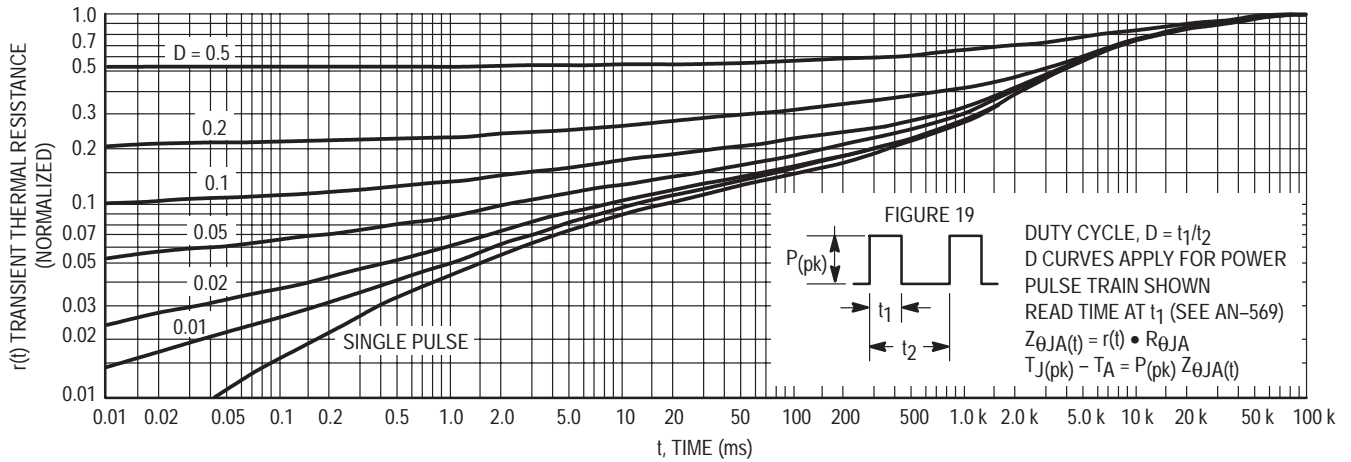


Figure 37. Thermal Response

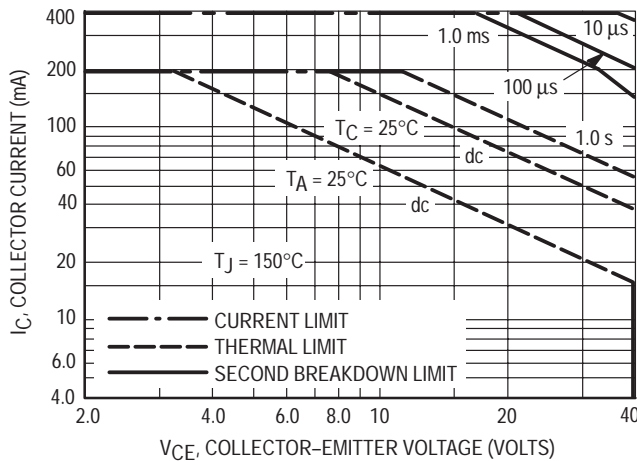


Figure 38. Active-Region Safe Operating Area

The safe operating area curves indicate I_C - V_{CE} limits of the transistor that must be observed for reliable operation. Collector load lines for specific circuits must fall below the limits indicated by the applicable curve.

The data of Figure 18 is based upon $T_{J(pk)} = 150^\circ\text{C}$; T_C or T_A is variable depending upon conditions. Pulse curves are valid for duty cycles to 10% provided $T_{J(pk)} \leq 150^\circ\text{C}$. $T_{J(pk)}$ may be calculated from the data in Figure 17. At high case or ambient temperatures, thermal limitations will reduce the power than can be handled to values less than the limitations imposed by second breakdown.

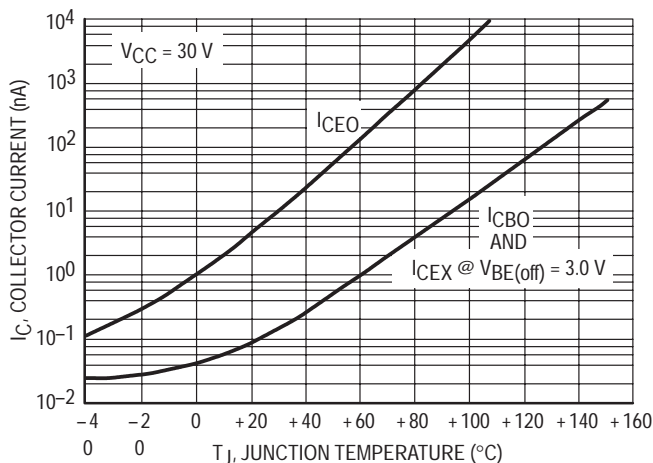


Figure 39. Typical Collector Leakage Current

DESIGN NOTE: USE OF THERMAL RESPONSE DATA

A train of periodical power pulses can be represented by the model as shown in Figure 19. Using the model and the device thermal response the normalized effective transient thermal resistance of Figure 17 was calculated for various duty cycles.

To find $Z_{\theta JA}(t)$, multiply the value obtained from Figure 17 by the steady state value $R_{\theta JA}$.

Example:

The MPS6523 is dissipating 2.0 watts peak under the following conditions:

$$t_1 = 1.0\text{ ms}, t_2 = 5.0\text{ ms} (D = 0.2)$$

Using Figure 17 at a pulse width of 1.0 ms and $D = 0.2$, the reading of $r(t)$ is 0.22.

The peak rise in junction temperature is therefore

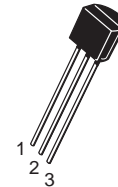
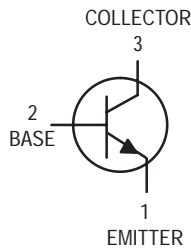
$$\Delta T = r(t) \times P(pk) \times R_{\theta JA} = 0.22 \times 2.0 \times 200 = 88^\circ\text{C}.$$

For more information, see AN-569.

Audio Transistor

NPN Silicon

MPS6560



CASE 29-04, STYLE 1
TO-92 (TO-226AA)

MAXIMUM RATINGS

Rating	Symbol	Value	Unit
Collector–Emitter Voltage	V_{CEO}	25	Vdc
Collector–Base Voltage	V_{CBO}	25	Vdc
Emitter–Base Voltage	V_{EBO}	5.0	Vdc
Collector Current — Continuous	I_C	500	mAdc
Total Device Dissipation @ $T_A = 25^\circ\text{C}$ Derate above 25°C	P_D	625 5.0	mW mW/ $^\circ\text{C}$
Total Device Dissipation @ $T_C = 25^\circ\text{C}$ Derate above 25°C	P_D	1.5 12	Watts mW/ $^\circ\text{C}$
Operating and Storage Junction Temperature Range	T_J, T_{stg}	-55 to +150	$^\circ\text{C}$

THERMAL CHARACTERISTICS

Characteristic	Symbol	Max	Unit
Thermal Resistance, Junction to Ambient	$R_{\theta JA}^{(1)}$	200	$^\circ\text{C}/\text{mW}$
Thermal Resistance, Junction to Case	$R_{\theta JC}$	83.3	$^\circ\text{C}/\text{mW}$

ELECTRICAL CHARACTERISTICS ($T_A = 25^\circ\text{C}$ unless otherwise noted)

Characteristic	Symbol	Min	Max	Unit
----------------	--------	-----	-----	------

OFF CHARACTERISTICS

Collector–Emitter Breakdown Voltage ⁽²⁾ ($I_C = 10 \text{ mAdc}, I_B = 0$)	$V_{(BR)CEO}$	25	—	Vdc
Collector–Base Breakdown Voltage ($I_C = 100 \mu\text{Adc}, I_E = 0$)	$V_{(BR)CBO}$	25	—	Vdc
Emitter–Base Breakdown Voltage ($I_E = 100 \mu\text{Adc}, I_C = 0$)	$V_{(BR)EBO}$	5.0	—	Vdc
Collector Cutoff Current ($V_{CE} = 25 \text{ Vdc}, I_B = 0$)	I_{CES}	—	100	nAdc
Collector Cutoff Current ($V_{CB} = 20 \text{ Vdc}, I_E = 0$)	I_{CBO}	—	100	nAdc
Emitter Cutoff Current ($V_{EB(off)} = 4.0 \text{ Vdc}, I_C = 0$)	I_{EBO}	—	100	nAdc

1. $R_{\theta JA}$ is measured with the device soldered into a typical printed circuit board.

2. Pulse Test: Pulse Width $\leq 300 \mu\text{s}$; Duty Cycle $\leq 2.0\%$.

ELECTRICAL CHARACTERISTICS ($T_A = 25^\circ\text{C}$ unless otherwise noted) (Continued)

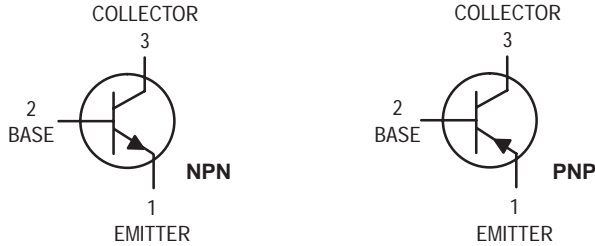
Characteristic	Symbol	Min	Max	Unit
ON CHARACTERISTICS(2)				
DC Current Gain ($I_C = 10\text{ mAdc}$, $V_{CE} = 1.0\text{ Vdc}$) ($I_C = 100\text{ mAdc}$, $V_{CE} = 1.0\text{ Vdc}$) ($I_C = 500\text{ mAdc}$, $V_{CE} = 1.0\text{ Vdc}$)	h_{FE}	35 50 50	— — 200	—
Collector–Emitter Saturation Voltage ($I_C = 500\text{ mAdc}$, $I_B = 50\text{ mAdc}$)	$V_{CE(sat)}$	—	0.5	Vdc
Base–Emitter On Voltage ($I_C = 500\text{ mAdc}$, $V_{CE} = 1.0\text{ Vdc}$)	$V_{BE(on)}$	—	1.2	Vdc

SMALL–SIGNAL CHARACTERISTICS

Current–Gain — Bandwidth Product ($I_C = 10\text{ mAdc}$, $V_{CE} = 10\text{ Vdc}$, $f = 20\text{ MHz}$)	f_T	60	—	MHz
Output Capacitance ($V_{CB} = 10\text{ Vdc}$, $I_E = 0$, $f = 1.0\text{ MHz}$)	C_{obo}	—	30	pF

2. Pulse Test: Pulse Width $\leq 300\ \mu\text{s}$; Duty Cycle $\leq 2.0\%$.

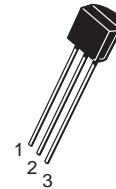
Amplifier Transistors



NPN
MPS6601
MPS6602*
PNP
MPS6651
MPS6652*

Voltage and current are negative for PNP transistors

*Motorola Preferred Device



CASE 29-04, STYLE 1
TO-92 (TO-226AA)

MAXIMUM RATINGS

Rating	Symbol	Value	Unit
Collector–Emitter Voltage MPS6601/6651 MPS6602/6652	V_{CEO}	25 40	Vdc
Collector–Base Voltage MPS6601/6651 MPS6602/6652	V_{CBO}	25 30	Vdc
Emitter–Base Voltage	V_{EBO}	4.0	Vdc
Collector Current — Continuous	I_C	1000	mAdc
Total Device Dissipation @ $T_A = 25^\circ\text{C}$ Derate above 25°C	P_D	625 5.0	mW mW/ $^\circ\text{C}$
Total Device Dissipation @ $T_C = 25^\circ\text{C}$ Derate above 25°C	P_D	1.5 12	Watts mW/ $^\circ\text{C}$
Operating and Storage Junction Temperature Range	T_J, T_{stg}	-55 to +150	$^\circ\text{C}$

THERMAL CHARACTERISTICS

Characteristic	Symbol	Max	Unit
Thermal Resistance, Junction to Ambient	$R_{\theta JA}^{(1)}$	200	$^\circ\text{C}/\text{W}$
Thermal Resistance, Junction to Case	$R_{\theta JC}$	83.3	$^\circ\text{C}/\text{W}$

ELECTRICAL CHARACTERISTICS ($T_A = 25^\circ\text{C}$ unless otherwise noted)

Characteristic	Symbol	Min	Max	Unit
----------------	--------	-----	-----	------

OFF CHARACTERISTICS

Collector–Emitter Breakdown Voltage ($I_C = 1.0 \text{ mAdc}, I_E = 0$)	MPS6601/6651 MPS6602/6652	$V_{(BR)CEO}$	25 40	— —	Vdc
Collector–Base Breakdown Voltage ($I_C = 100 \mu\text{Adc}, I_E = 0$)	MPS6601/6651 MPS6602/6652	$V_{(BR)CBO}$	25 40	— —	Vdc
Emitter–Base Breakdown Voltage ($I_E = 10 \mu\text{Adc}, I_C = 0$)		$V_{(BR)EBO}$	4.0	—	Vdc
Collector Cutoff Current ($V_{CE} = 25 \text{ Vdc}, I_E = 0$) ($V_{CE} = 30 \text{ Vdc}, I_E = 0$)	MPS6601/6651 MPS6602/6652	I_{CES}	— —	0.1 0.1	μAdc
Collector Cutoff Current ($V_{CB} = 25 \text{ Vdc}, I_E = 0$) ($V_{CB} = 30 \text{ Vdc}, I_E = 0$)	MPS6601/6651 MPS6602/6652	I_{CBO}	— —	0.1 0.1	μAdc

1. $R_{\theta JA}$ is measured with the device soldered into a typical printed circuit board.

Preferred devices are Motorola recommended choices for future use and best overall value.

ELECTRICAL CHARACTERISTICS ($T_A = 25^\circ\text{C}$ unless otherwise noted) (Continued)

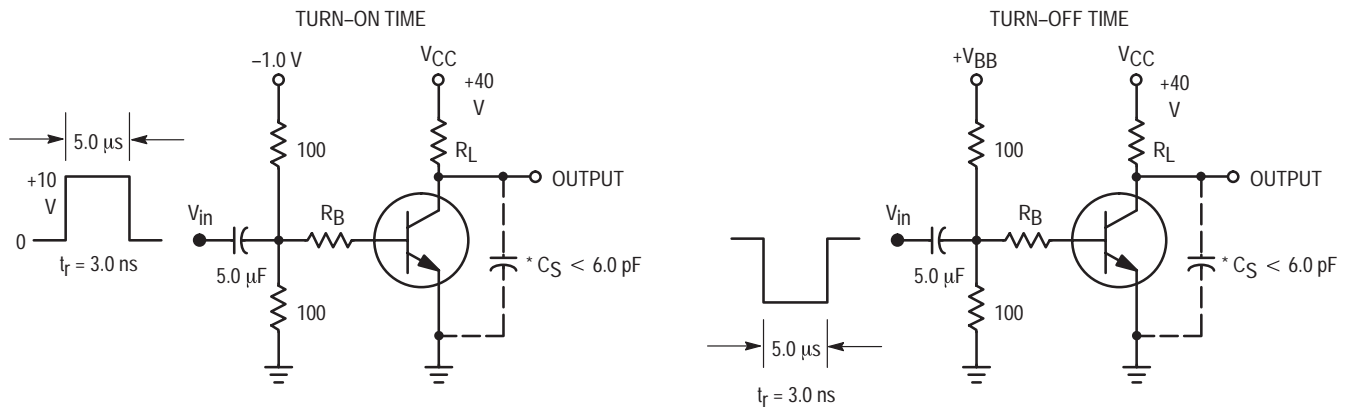
Characteristic	Symbol	Min	Max	Unit
ON CHARACTERISTICS				
DC Current Gain ($I_C = 100\text{ mAdc}$, $V_{CE} = 1.0\text{ Vdc}$) ($I_C = 500\text{ mAdc}$, $V_{CE} = 1.0\text{ Vdc}$) ($I_C = 1000\text{ mAdc}$, $V_{CE} = 1.0\text{ Vdc}$)	h_{FE}	50 50 30	— — —	—
Collector–Emitter Saturation Voltage ($I_C = 1000\text{ mAdc}$, $I_B = 100\text{ mAdc}$)	$V_{CE(sat)}$	—	0.6	Vdc
Base–Emitter On Voltage ($I_C = 500\text{ mAdc}$, $V_{CE} = 1.0\text{ Vdc}$)	$V_{BE(on)}$	—	1.2	Vdc

SMALL–SIGNAL CHARACTERISTICS

Current–Gain — Bandwidth Product ($I_C = 50\text{ mAdc}$, $V_{CE} = 10\text{ Vdc}$, $f = 100\text{ MHz}$)	f_T	100	—	MHz
Output Capacitance ($V_{CB} = 10\text{ Vdc}$, $I_E = 0$, $f = 1.0\text{ MHz}$)	C_{obo}	—	30	pF

SWITCHING CHARACTERISTICS

Delay Time	$(V_{CC} = 40\text{ Vdc}$, $I_C = 500\text{ mAdc}$, $I_{B1} = 50\text{ mAdc}$, $t_p \geq 300\text{ ns}$ Duty Cycle)	t_d	—	25	ns
Rise Time		t_r	—	30	ns
Storage Time		t_s	—	250	ns
Fall Time		t_f	—	50	ns



* Total Shunt Capacitance of Test Jig and Connectors
For PNP Test Circuits, Reverse All Voltage Polarities

Figure 1. Switching Time Test Circuits

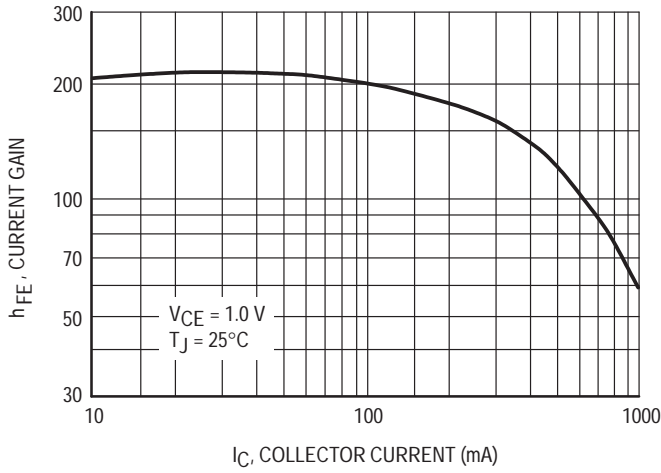


Figure 2. MPS6601/6602 DC Current Gain

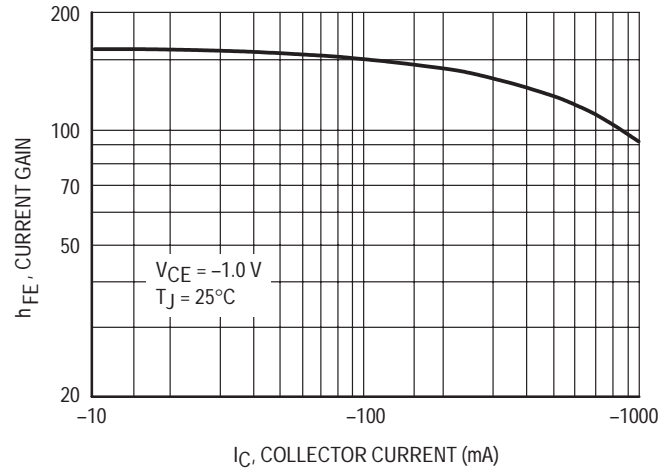


Figure 3. MPS6651/6652 DC Current Gain

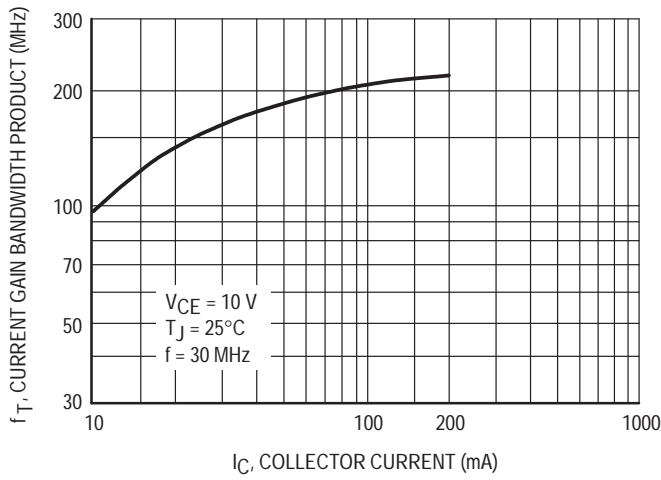


Figure 4. Current Gain Bandwidth Product

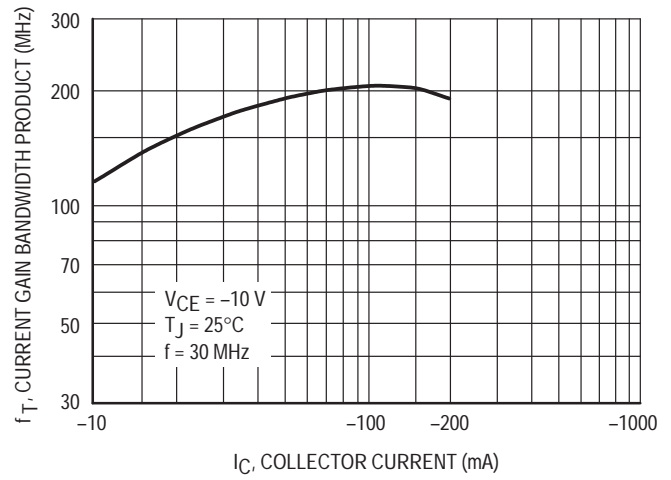


Figure 5. Current Gain Bandwidth Product

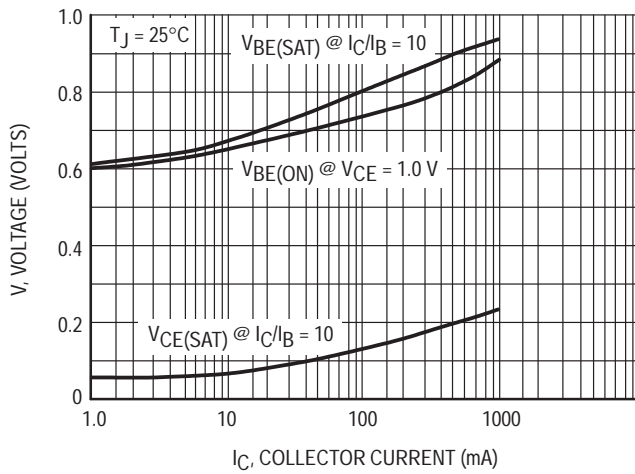


Figure 6. On Voltages

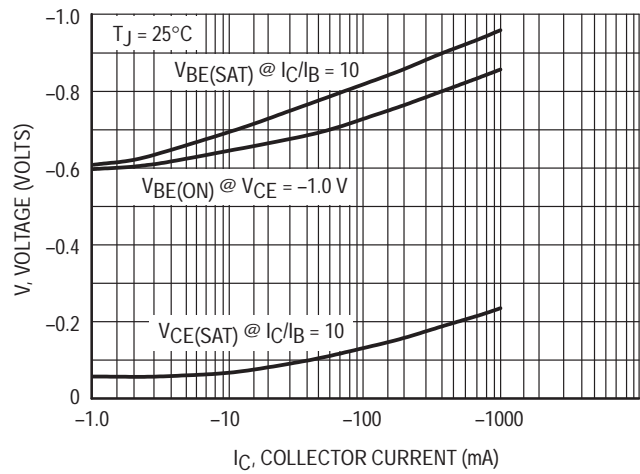


Figure 7. On Voltages

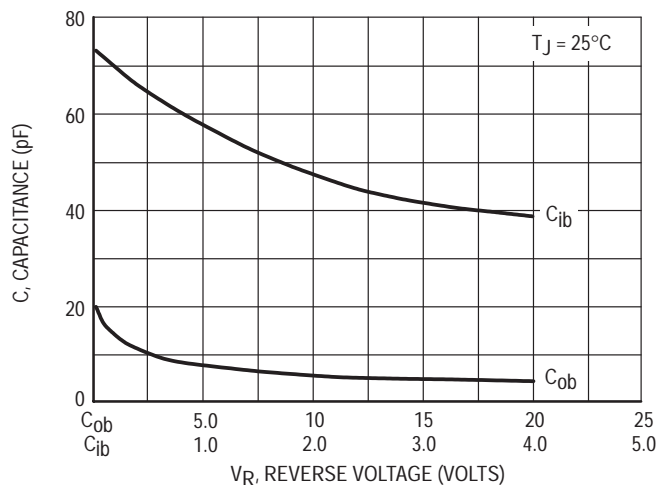


Figure 8. Capacitance

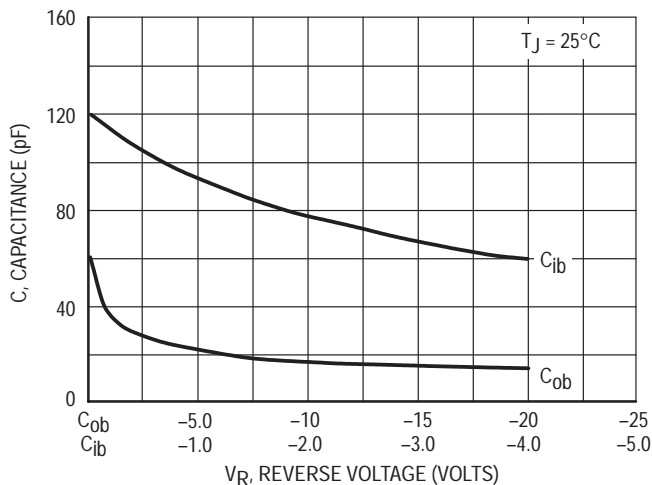


Figure 9. Capacitance

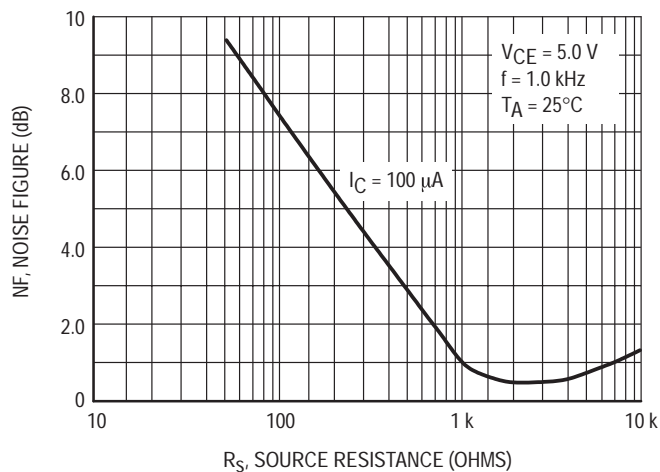


Figure 10. MPS6601/6602 Noise Figure

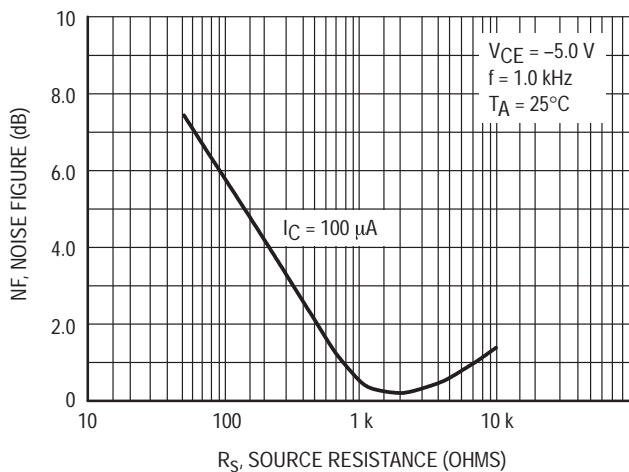


Figure 11. MPS6651/6652 Noise Figure

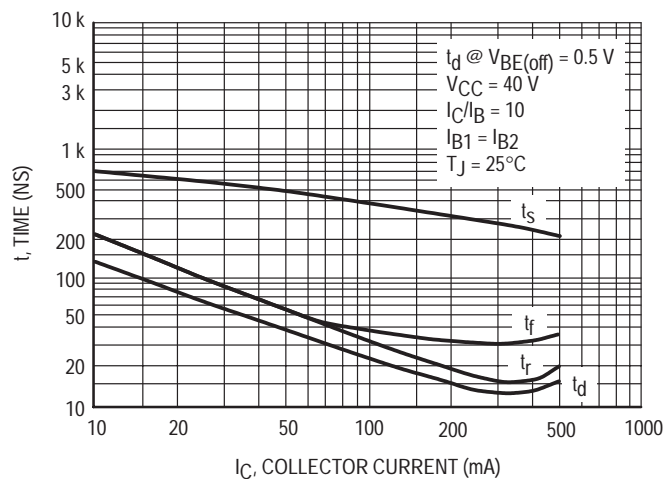


Figure 12. MPS6601/6602 Switching Times

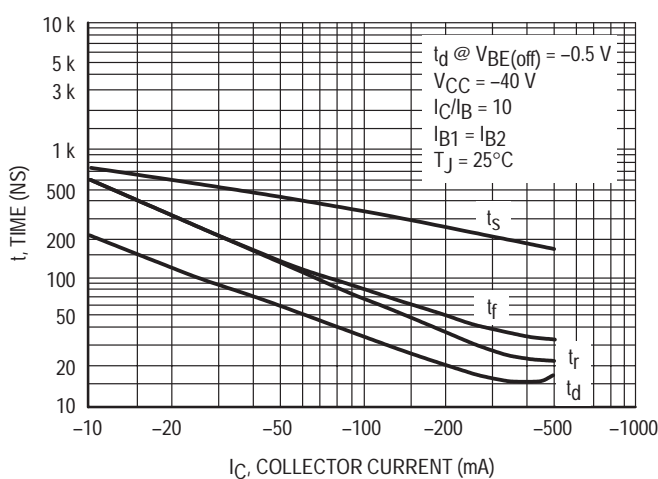


Figure 13. MPS6651/6652 Switching Times

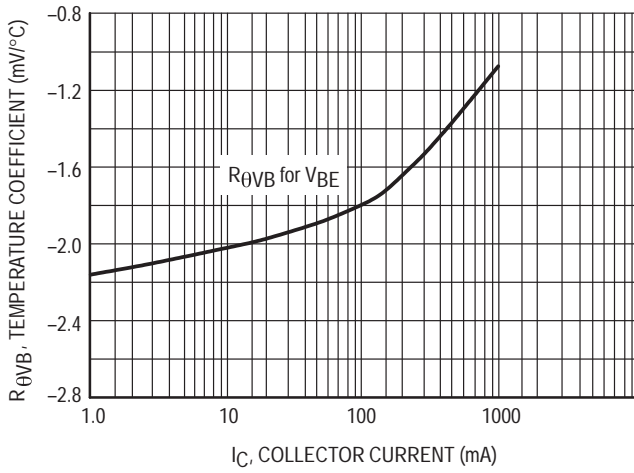


Figure 14. Base-Emitter Temperature Coefficient

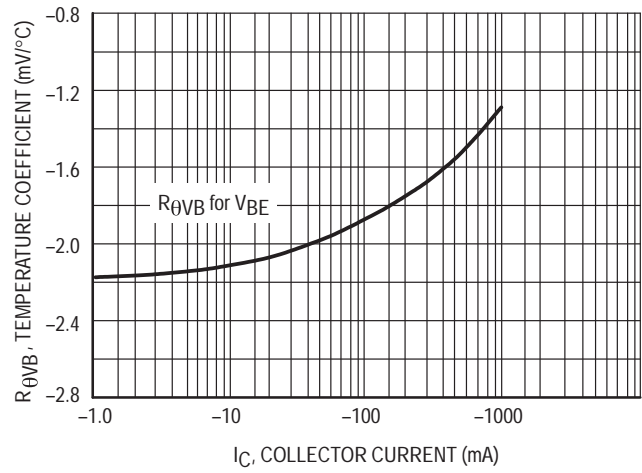


Figure 15. Base-Emitter Temperature Coefficient

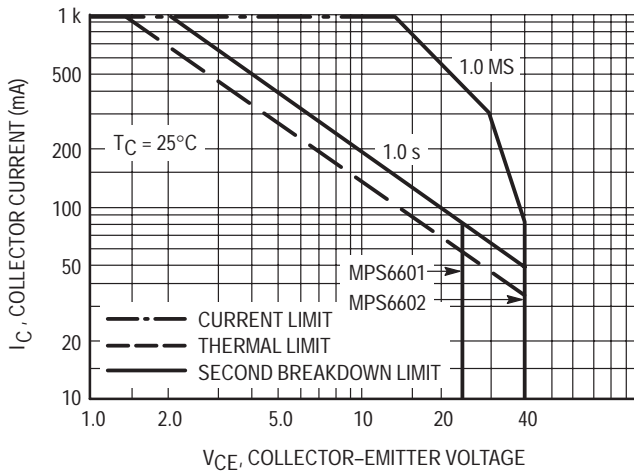


Figure 16. Safe Operating Area

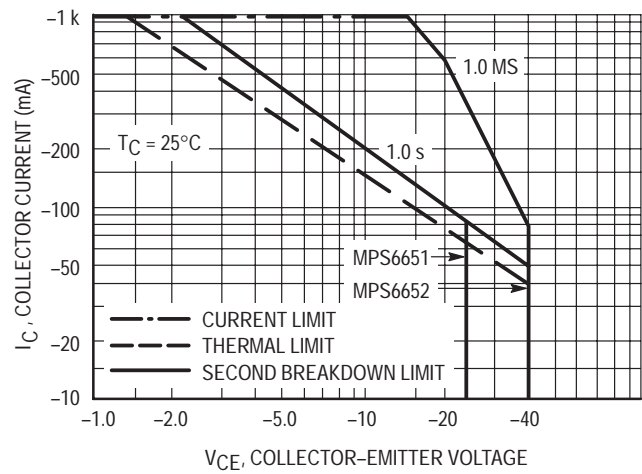


Figure 17. Safe Operating Area

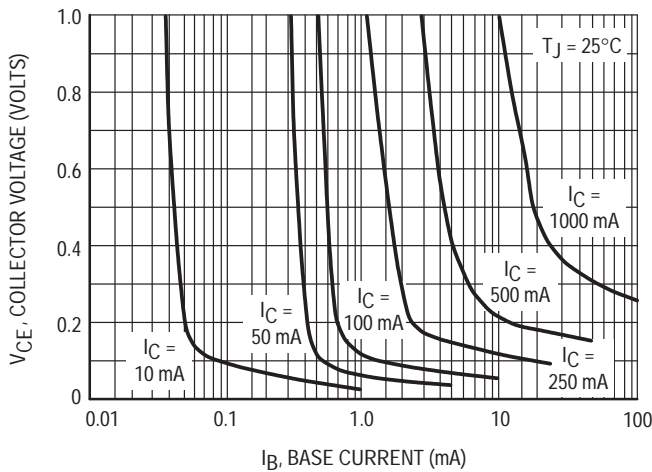


Figure 18. MPS6601/6602 Saturation Region

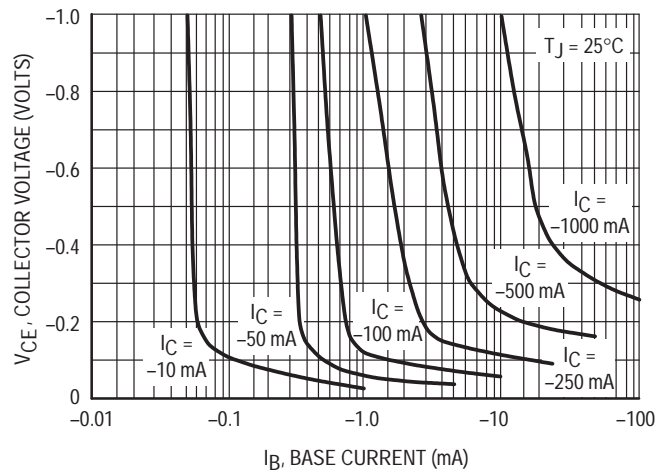


Figure 19. MPS6651/6652 Saturation Region

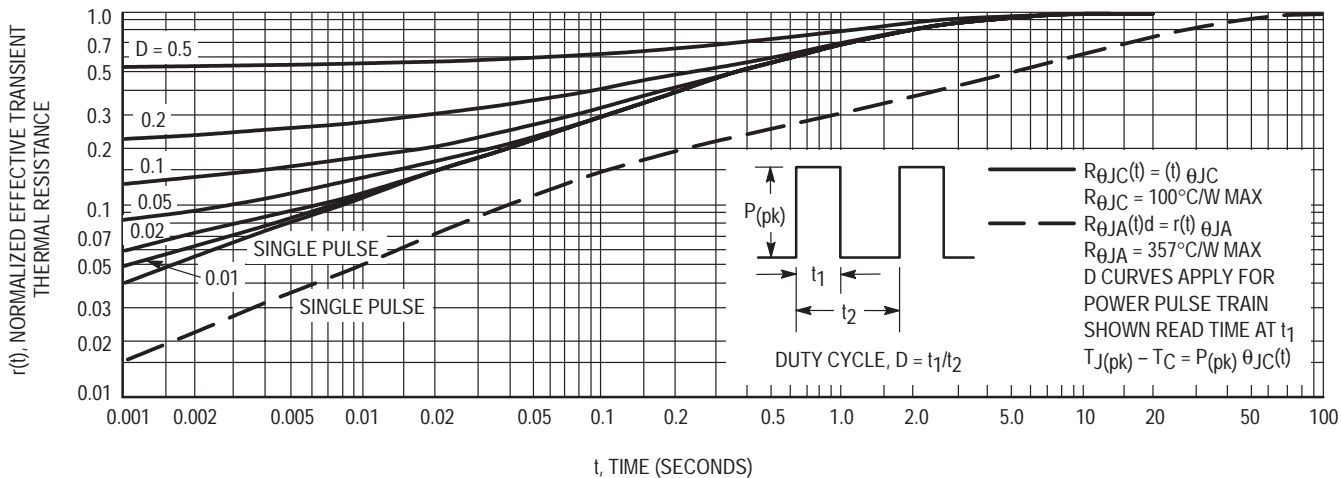
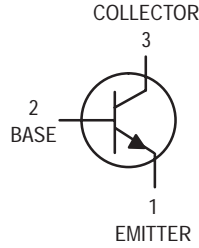


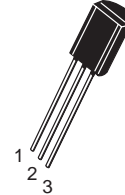
Figure 20. Thermal Response

One Watt Amplifier Transistors

NPN Silicon



MPS6714
MPS6715



CASE 29-05, STYLE 1
TO-92 (TO-226AE)

MAXIMUM RATINGS

Rating	Symbol	Value	Unit
Collector–Emitter Voltage MPS6714 MPS6715	V_{CEO}	30 40	Vdc
Collector–Base Voltage MPS6714 MPS6715	V_{CBO}	40 50	Vdc
Emitter–Base Voltage	V_{EBO}	5.0	Vdc
Collector Current — Continuous	I_C	1.0	Adc
Total Device Dissipation @ $T_A = 25^\circ\text{C}$ Derate above 25°C	P_D	1.0 8.0	Watts mW/ $^\circ\text{C}$
Total Device Dissipation @ $T_C = 25^\circ\text{C}$ Derate above 25°C	P_D	2.5 20	Watts mW/ $^\circ\text{C}$
Operating and Storage Junction Temperature Range	T_J, T_{stg}	-55 to +150	$^\circ\text{C}$

THERMAL CHARACTERISTICS

Characteristic	Symbol	Max	Unit
Thermal Resistance, Junction to Ambient	$R_{\theta JA}$	125	$^\circ\text{C}/\text{W}$
Thermal Resistance, Junction to Case	$R_{\theta JC}$	50	$^\circ\text{C}/\text{W}$

ELECTRICAL CHARACTERISTICS ($T_A = 25^\circ\text{C}$ unless otherwise noted)

Characteristic	Symbol	Min	Max	Unit
----------------	--------	-----	-----	------

OFF CHARACTERISTICS

Collector–Emitter Breakdown Voltage ⁽¹⁾ ($I_C = 10 \text{ mAdc}, I_E = 0$)	MPS6714 MPS6715	$V_{(BR)CEO}$	30 40	— —	Vdc
Collector–Base Breakdown Voltage ($I_C = 100 \mu\text{Adc}, I_E = 0$)	MPS6714 MPS6715	$V_{(BR)CBO}$	40 50	— —	Vdc
Emitter–Base Breakdown Voltage ($I_E = 100 \mu\text{Adc}, I_C = 0$)		$V_{(BR)EBO}$	5.0	—	Vdc
Collector Cutoff Current ($V_{CB} = 40 \text{ Vdc}, I_E = 0$) ($V_{CB} = 50 \text{ Vdc}, I_E = 0$)	MPS6714 MPS6715	I_{CBO}	— —	0.1 0.1	μAdc
Emitter Cutoff Current ($V_{EB} = 5.0 \text{ Vdc}, I_C = 0$)		I_{EBO}	—	0.1	μAdc

1. Pulse Test: Pulse Width $\leq 30 \mu\text{s}$; Duty Cycle $\leq 2.0\%$.

ELECTRICAL CHARACTERISTICS ($T_A = 25^\circ\text{C}$ unless otherwise noted) (Continued)

Characteristic	Symbol	Min	Max	Unit
ON CHARACTERISTICS(1)				
DC Current Gain ($I_C = 100\text{ mAdc}$, $V_{CE} = 1.0\text{ Vdc}$) ($I_C = 1000\text{ mAdc}$, $V_{CE} = 1.0\text{ Vdc}$)	h_{FE}	60 50	— 250	—
Collector–Emitter Saturation Voltage ($I_C = 1000\text{ mAdc}$, $I_B = 100\text{ mAdc}$)	$V_{CE(sat)}$	—	0.5	Vdc
Base–Emitter On Voltage ($I_C = 1000\text{ mAdc}$, $V_{CE} = 1.0\text{ Vdc}$)	$V_{BE(on)}$	—	1.2	Vdc

SMALL–SIGNAL CHARACTERISTICS

Collector–Base Capacitance ($V_{CB} = 10\text{ Vdc}$, $I_E = 0$, $f = 1.0\text{ MHz}$)	C_{cb}	—	30	pF
Small–Signal Current Gain ($I_C = 50\text{ mAdc}$, $V_{CE} = 10\text{ Vdc}$, $f = 20\text{ MHz}$)	h_{fe}	2.5	25	—

1. Pulse Test: Pulse Width $\leq 30\ \mu\text{s}$; Duty Cycle $\leq 2.0\%$.

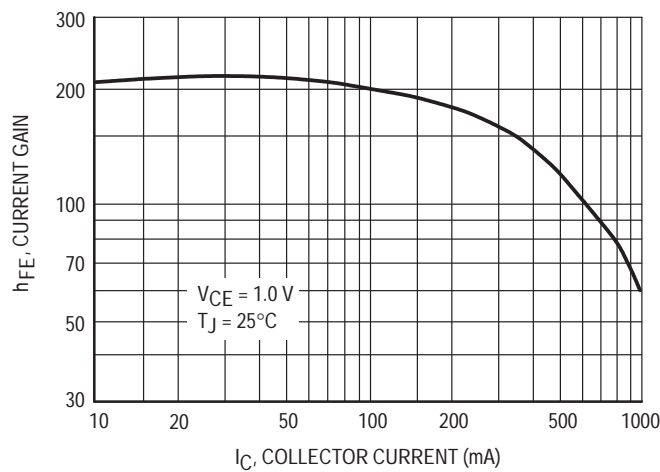


Figure 1. DC Current Gain

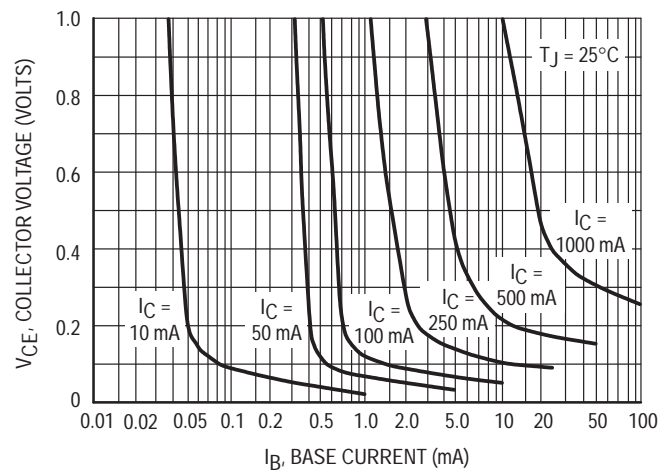


Figure 2. Collector Saturation Region

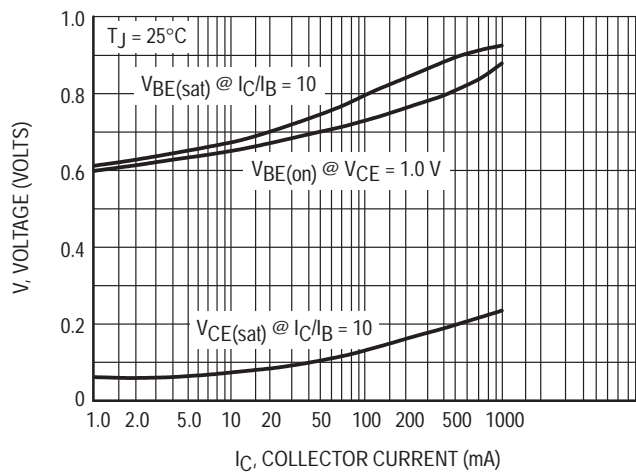


Figure 3. "ON" Voltages

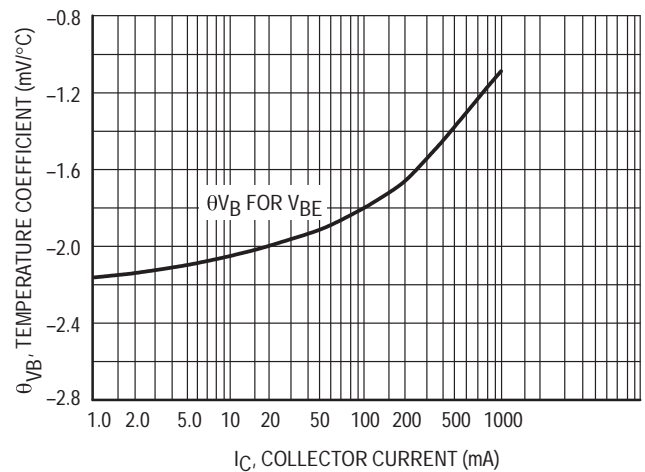


Figure 4. Temperature Coefficient

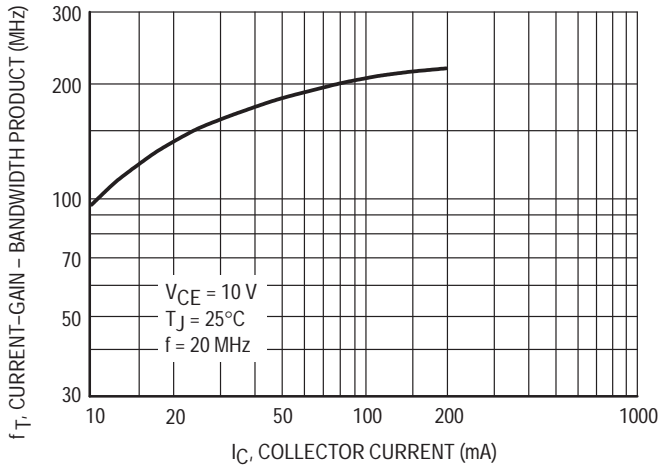


Figure 5. Current Gain — Bandwidth Product

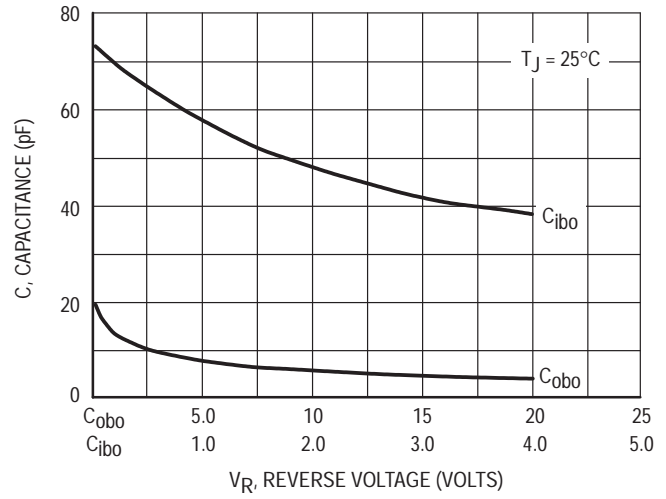


Figure 6. Capacitance

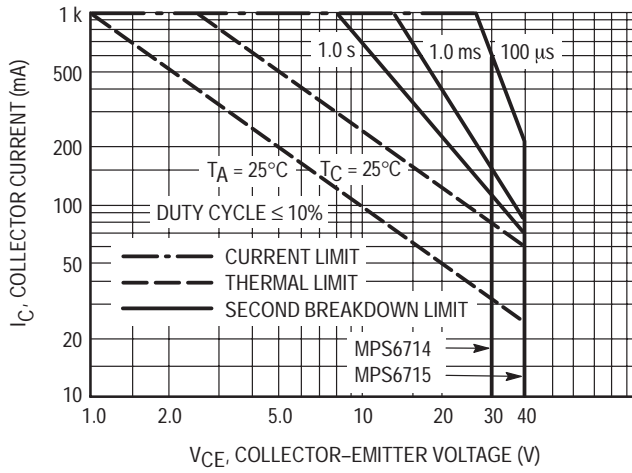
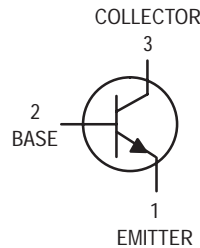


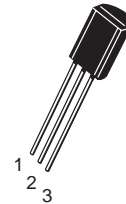
Figure 7. Active Region — Safe Operating Area

One Watt Amplifier Transistor

NPN Silicon



MPS6717



CASE 29-05, STYLE 1
TO-92 (TO-226AE)

MAXIMUM RATINGS

Rating	Symbol	Value	Unit
Collector–Emitter Voltage	V_{CEO}	80	Vdc
Collector–Base Voltage	V_{CBO}	80	Vdc
Emitter–Base Voltage	V_{EBO}	5.0	Vdc
Collector Current — Continuous	I_C	500	mAdc
Total Device Dissipation @ $T_A = 25^\circ\text{C}$ Derate above 25°C	P_D	1.0 8.0	Watts mW/ $^\circ\text{C}$
Total Device Dissipation @ $T_C = 25^\circ\text{C}$ Derate above 25°C	P_D	2.5 20	Watts mW/ $^\circ\text{C}$
Operating and Storage Junction Temperature Range	T_J, T_{stg}	-55 to +150	$^\circ\text{C}$

THERMAL CHARACTERISTICS

Characteristic	Symbol	Max	Unit
Thermal Resistance, Junction to Ambient	$R_{\theta JA}$	125	$^\circ\text{C}/\text{W}$
Thermal Resistance, Junction to Case	$R_{\theta JC}$	50	$^\circ\text{C}/\text{W}$

ELECTRICAL CHARACTERISTICS ($T_A = 25^\circ\text{C}$ unless otherwise noted)

Characteristic	Symbol	Min	Max	Unit
----------------	--------	-----	-----	------

OFF CHARACTERISTICS

Collector–Emitter Breakdown Voltage ⁽¹⁾ ($I_C = 1.0 \text{ mAdc}, I_E = 0$)	$V_{(BR)CEO}$	80	—	Vdc
Collector–Base Breakdown Voltage ($I_C = 100 \mu\text{Adc}, I_E = 0$)	$V_{(BR)CBO}$	80	—	Vdc
Emitter–Base Breakdown Voltage ($I_E = 10 \mu\text{Adc}, I_C = 0$)	$V_{(BR)EBO}$	5.0	—	Vdc
Collector Cutoff Current ($V_{CB} = 60 \text{ Vdc}, I_E = 0$)	I_{CBO}	—	0.1	μAdc
Emitter Cutoff Current ($V_{EB} = 5.0 \text{ Vdc}, I_C = 0$)	I_{EBO}	—	10	μAdc

1. Pulse Test: Pulse Width $\leq 300 \mu\text{s}$; Duty Cycle $\leq 2.0\%$.

ELECTRICAL CHARACTERISTICS ($T_A = 25^\circ\text{C}$ unless otherwise noted) (Continued)

Characteristic	Symbol	Min	Max	Unit
ON CHARACTERISTICS				
DC Current Gain ($I_C = 50\text{ mAdc}$, $V_{CE} = 1.0\text{ Vdc}$) ($I_C = 250\text{ mAdc}$, $V_{CE} = 1.0\text{ Vdc}$)	h_{FE}	80 50	— 250	—
Collector–Emitter Saturation Voltage ($I_C = 250\text{ mAdc}$, $I_B = 10\text{ mAdc}$)	$V_{CE(sat)}$	—	0.5	Vdc
Base–Emitter On Voltage ($I_C = 250\text{ mAdc}$, $V_{CE} = 1.0\text{ Vdc}$)	$V_{BE(on)}$	—	1.2	Vdc
SMALL–SIGNAL CHARACTERISTICS				
Collector–Base Capacitance ($V_{CB} = 10\text{ Vdc}$, $I_E = 0$, $f = 1.0\text{ MHz}$)	C_{cb}	—	30	pF
Small–Signal Current Gain ($I_C = 200\text{ mAdc}$, $V_{CE} = 5.0\text{ Vdc}$, $f = 20\text{ MHz}$)	h_{fe}	2.5	25	—

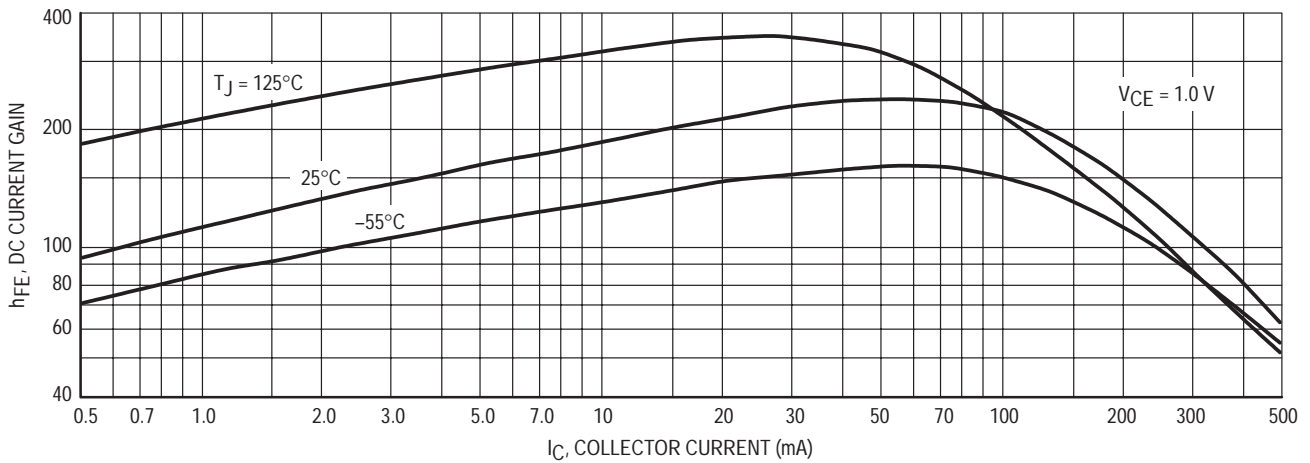


Figure 1. DC Current Gain

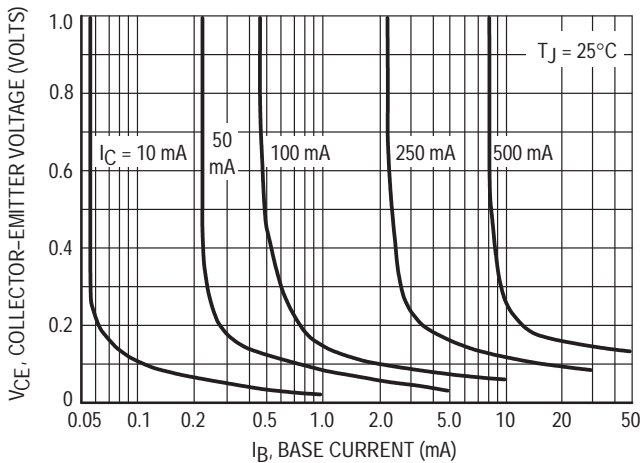


Figure 2. Collector Saturation Region

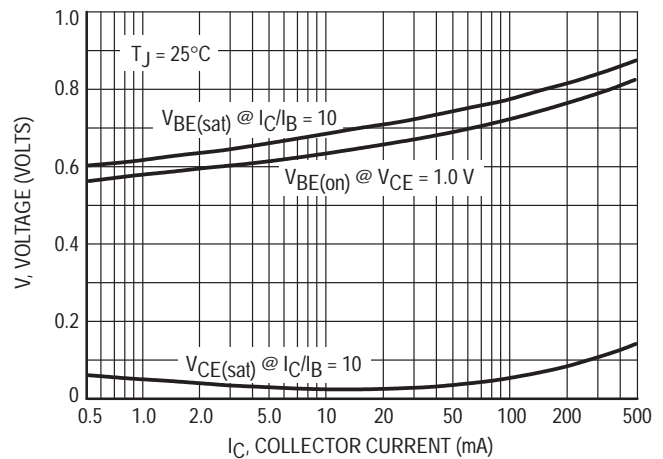


Figure 3. “On” Voltages

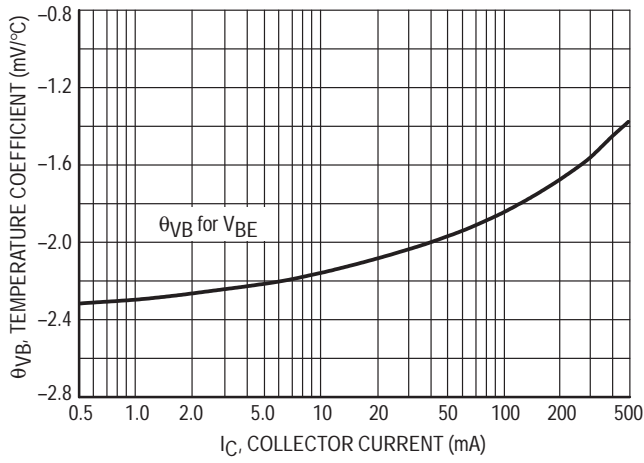


Figure 4. Base-Emitter Temperature Coefficient

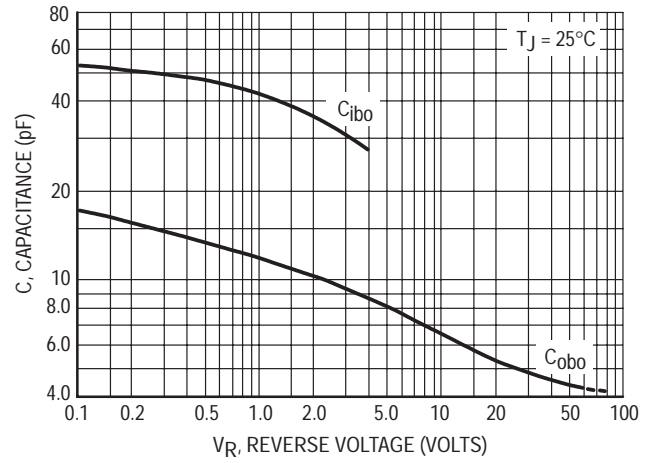


Figure 5. Capacitance

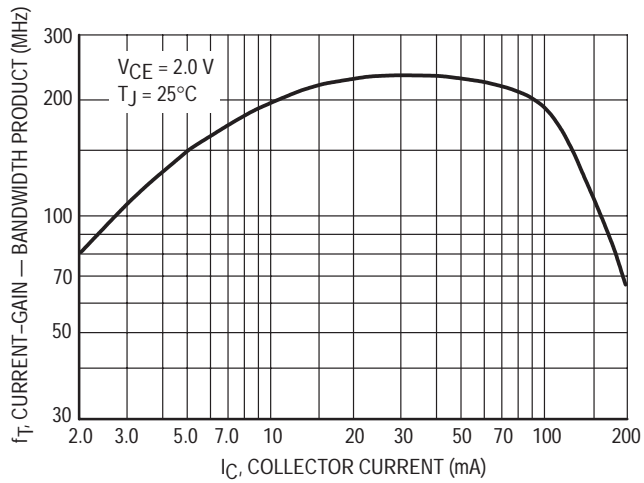


Figure 6. Current-Gain — Bandwidth Product

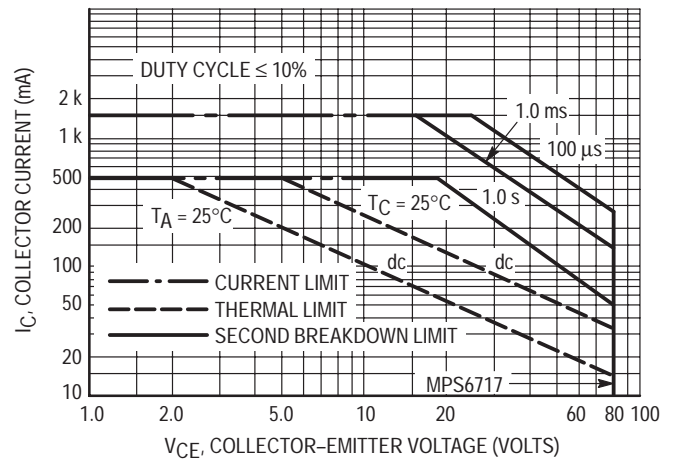
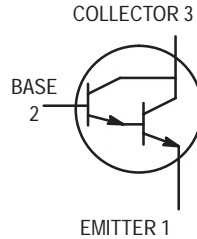


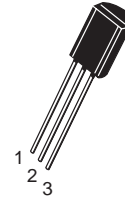
Figure 7. Active Region — Safe Operating Area

One Watt Darlington Transistors

NPN Silicon



MPS6724
MPS6725



CASE 29-05, STYLE 1
TO-92 (TO-226AE)

MAXIMUM RATINGS

Rating	Symbol	MPS6724	MPS6725	Unit
Collector–Emitter Voltage	V_{CES}	40	50	Vdc
Collector–Base Voltage	V_{CBO}	50	60	Vdc
Emitter–Base Voltage	V_{EBO}	12		Vdc
Collector Current — Continuous	I_C	1000		mAdc
Total Device Dissipation @ $T_A = 25^\circ\text{C}$ Derate above 25°C	P_D	1.0	8.0	Watts mW/ $^\circ\text{C}$
Total Device Dissipation @ $T_C = 25^\circ\text{C}$ Derate above 25°C	P_D	2.5	20	Watts mW/ $^\circ\text{C}$
Operating and Storage Junction Temperature Range	T_J, T_{stg}	–55 to +150		$^\circ\text{C}$

THERMAL CHARACTERISTICS

Characteristic	Symbol	Max	Unit
Thermal Resistance, Junction to Ambient	$R_{\theta JA}$	125	$^\circ\text{C}/\text{W}$
Thermal Resistance, Junction to Case	$R_{\theta JC}$	50	$^\circ\text{C}/\text{W}$

ELECTRICAL CHARACTERISTICS ($T_A = 25^\circ\text{C}$ unless otherwise noted)

Characteristic	Symbol	Min	Max	Unit
----------------	--------	-----	-----	------

OFF CHARACTERISTICS

Collector–Emitter Breakdown Voltage (1) ($I_C = 1.0 \text{ mAdc}, I_B = 0$)	MPS6724 MPS6725	$V_{(BR)CES}$	40 50	— —	Vdc
Collector–Base Breakdown Voltage ($I_C = 1.0 \mu\text{Adc}, I_E = 0$)	MPS6724 MPS6725	$V_{(BR)CBO}$	50 60	— —	Vdc
Emitter–Base Breakdown Voltage ($I_E = 10 \mu\text{Adc}, I_C = 0$)		$V_{(BR)EBO}$	12	—	Vdc
Collector Cutoff Current ($V_{CB} = 30 \text{ Vdc}, I_E = 0$) ($V_{CB} = 40 \text{ Vdc}, I_E = 0$)	MPS6724 MPS6725	I_{CBO}	— —	100 100	nAdc
Emitter Cutoff Current ($V_{EB} = 10 \text{ Vdc}, I_C = 0$)		I_{EBO}	—	100	nAdc

1. Pulse Test: Pulse Width $\leq 300 \mu\text{s}$; Duty Cycle $\leq 2.0\%$.

ELECTRICAL CHARACTERISTICS ($T_A = 25^\circ\text{C}$ unless otherwise noted) (Continued)

Characteristic	Symbol	Min	Max	Unit
ON CHARACTERISTICS(1)				
DC Current Gain ($I_C = 200\text{ mA}$, $V_{CE} = 5.0\text{ Vdc}$) ($I_C = 1000\text{ mA}$, $V_{CE} = 5.0\text{ Vdc}$)	h_{FE}	25,000 4,000	— 40,000	—
Collector–Emitter Saturation Voltage ($I_C = 1000\text{ mA}$, $I_B = 2.0\text{ mA}$)	$V_{CE(sat)}$	—	1.5	Vdc
Base–Emitter On Voltage ($I_C = 1000\text{ mA}$, $V_{CE} = 5.0\text{ Vdc}$)	$V_{BE(on)}$	—	2.0	Vdc

SMALL–SIGNAL CHARACTERISTICS

Current–Gain – Bandwidth Product ($I_C = 200\text{ mA}$, $V_{CE} = 5.0\text{ Vdc}$, $f = 100\text{ MHz}$)	f_T	100	1000	MHz
Collector–Base Capacitance ($V_{CB} = 10\text{ Vdc}$, $I_E = 0$, $f = 1.0\text{ MHz}$)	C_{cb}	—	10	pF

1. Pulse Test: Pulse Width $\leq 300\ \mu\text{s}$; Duty Cycle $\leq 2.0\%$.

TYPICAL CHARACTERISTICS

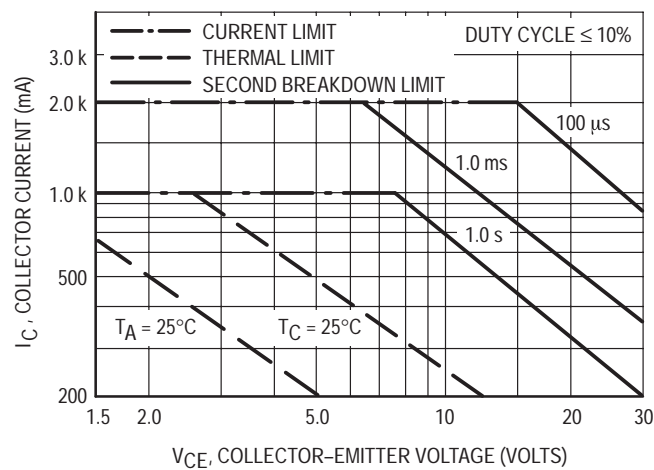


Figure 1. Active Region — Safe Operating Area

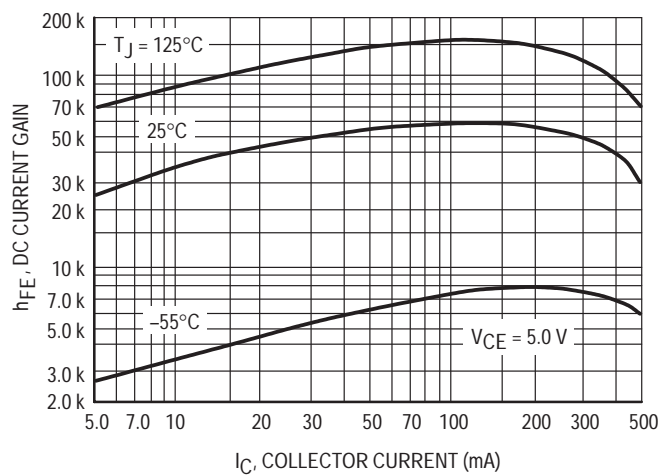


Figure 2. DC Current Gain

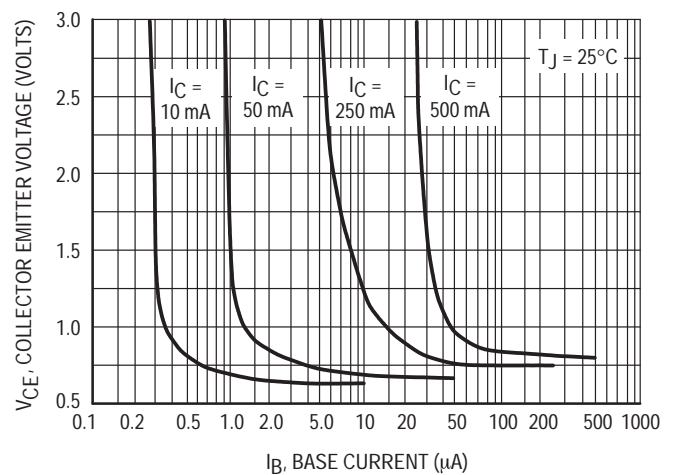


Figure 3. Collector Saturation Region

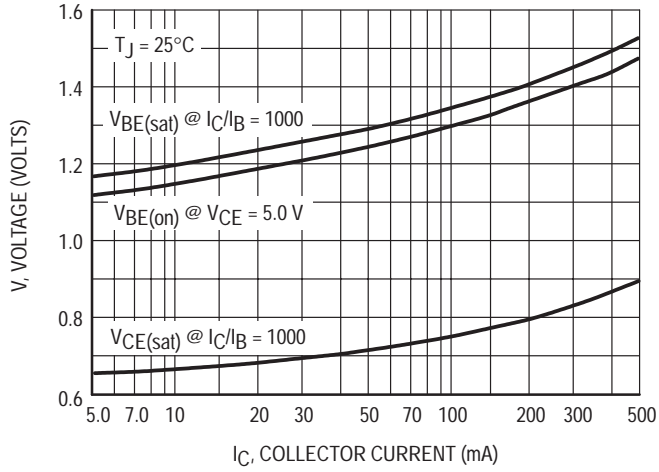


Figure 4. "ON" Voltages

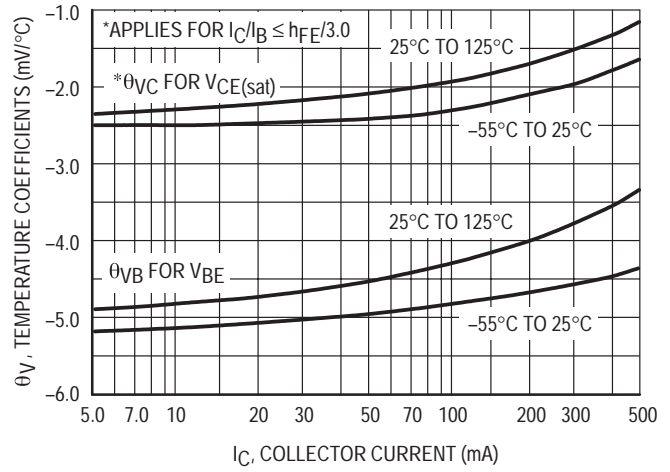


Figure 5. Temperature Coefficients

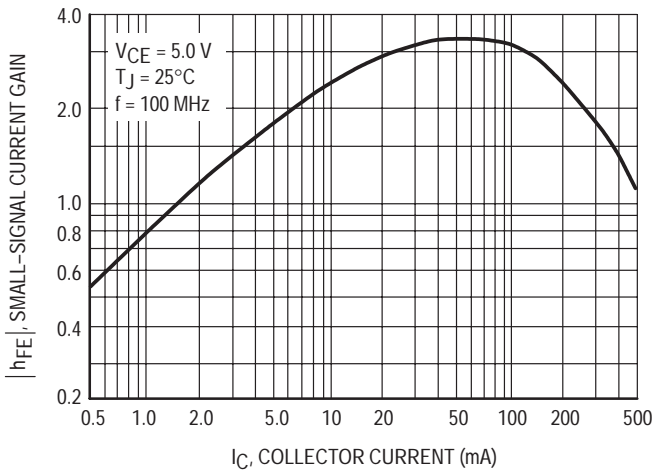


Figure 6. High Frequency Current Gain

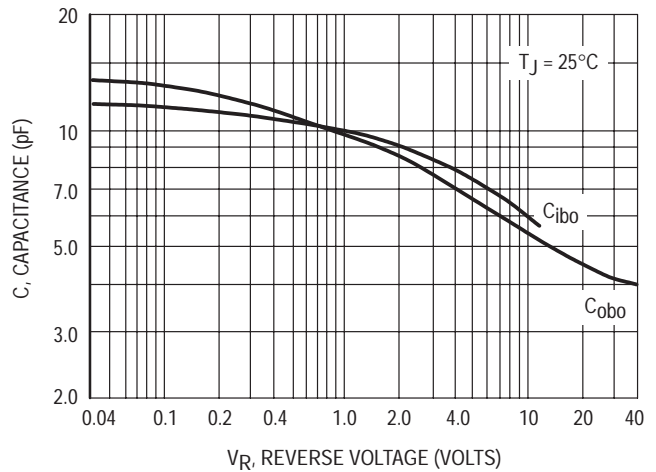
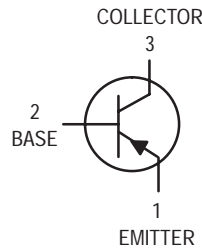


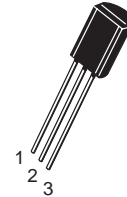
Figure 7. Capacitance

One Watt Amplifier Transistor

PNP Silicon



MPS6726
MPS6727



CASE 29-05, STYLE 1
TO-92 (TO-226AE)

MAXIMUM RATINGS

Rating	Symbol	Value	Unit
Collector–Emitter Voltage MPS6726 MPS6727	V_{CEO}	–30 –40	Vdc
Collector–Base Voltage MPS6726 MPS6727	V_{CBO}	–40 –50	Vdc
Emitter–Base Voltage	V_{EBO}	–5.0	Vdc
Collector Current — Continuous	I_C	–1.0	Adc
Total Device Dissipation @ $T_A = 25^\circ\text{C}$ Derate above 25°C	P_D	1.0 8.0	Watts mW/ $^\circ\text{C}$
Total Device Dissipation @ $T_C = 25^\circ\text{C}$ Derate above 25°C	P_D	2.5 20	Watts mW/ $^\circ\text{C}$
Operating and Storage Junction Temperature Range	T_J, T_{stg}	–55 to +150	$^\circ\text{C}$

THERMAL CHARACTERISTICS

Characteristic	Symbol	Max	Unit
Thermal Resistance, Junction to Ambient	$R_{\theta JA}$	125	$^\circ\text{C}/\text{W}$
Thermal Resistance, Junction to Case	$R_{\theta JC}$	50	$^\circ\text{C}/\text{W}$

ELECTRICAL CHARACTERISTICS ($T_A = 25^\circ\text{C}$ unless otherwise noted)

Characteristic	Symbol	Min	Max	Unit
----------------	--------	-----	-----	------

OFF CHARACTERISTICS

Collector–Emitter Breakdown Voltage ($I_C = -10 \text{ mAdc}, I_E = 0$)	MPS6726 MPS6727	$V_{(BR)CEO}$	–30 –40	— —	Vdc
Collector–Base Breakdown Voltage ($I_C = -100 \mu\text{Adc}, I_E = 0$)	MPS6726 MPS6727	$V_{(BR)CBO}$	–40 –50	— —	Vdc
Emitter–Base Breakdown Voltage ($I_E = -100 \mu\text{Adc}, I_C = 0$)		$V_{(BR)EBO}$	–5.0	—	Vdc
Collector Cutoff Current ($V_{CB} = -40 \text{ Vdc}, I_E = 0$) ($V_{CB} = -50 \text{ Vdc}, I_E = 0$)	MPS6726 MPS6727	I_{CBO}	— —	–0.1 –0.1	μAdc
Emitter Cutoff Current ($V_{EB} = -5.0 \text{ Vdc}, I_C = 0$)		I_{EBO}	—	–0.1	μAdc

ELECTRICAL CHARACTERISTICS ($T_A = 25^\circ\text{C}$ unless otherwise noted) (Continued)

Characteristic	Symbol	Min	Max	Unit
ON CHARACTERISTICS(1)				
DC Current Gain ($I_C = -100 \text{ mAdc}$, $V_{CE} = -1.0 \text{ Vdc}$) ($I_C = -1000 \text{ mAdc}$, $V_{CE} = -1.0 \text{ Vdc}$)	h_{FE}	60 50	— 250	—
Collector–Emitter Saturation Voltage ($I_C = -1000 \text{ mAdc}$, $I_B = -100 \text{ mAdc}$)	$V_{CE(sat)}$	—	-0.5	Vdc
Base–Emitter On Voltage ($I_C = -1000 \text{ mAdc}$, $V_{CE} = -1.0 \text{ Vdc}$)	$V_{BE(on)}$	—	-1.2	Vdc

SMALL–SIGNAL CHARACTERISTICS

Collector–Base Capacitance ($V_{CB} = -10 \text{ Vdc}$, $I_E = 0$, $f = 1.0 \text{ MHz}$)	C_{cb}	—	30	pF
Small–Signal Current Gain ($I_C = -50 \text{ mAdc}$, $V_{CE} = -10 \text{ Vdc}$, $f = 20 \text{ MHz}$)	h_{fe}	2.5	25	—

1. Pulse Test: Pulse Width $\leq 300 \mu\text{s}$; Duty Cycle $\leq 2.0\%$.

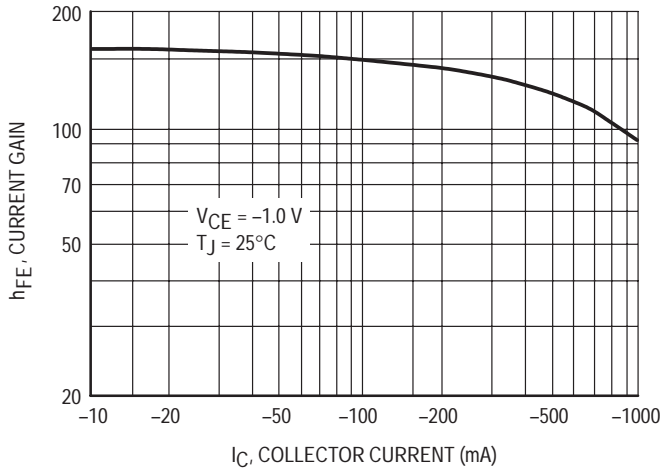


Figure 1. DC Current Gain

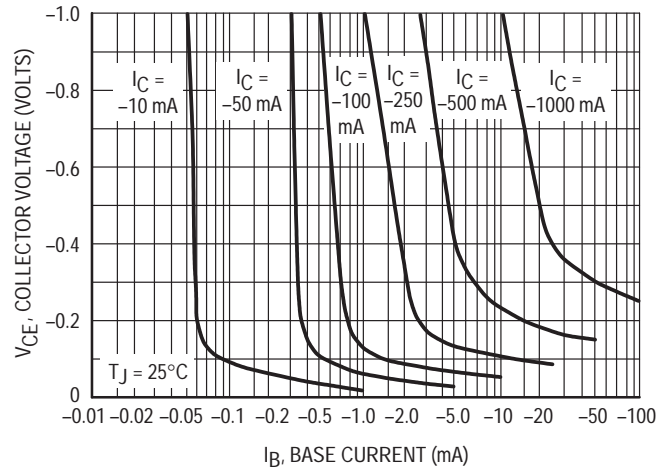


Figure 2. Collector Saturation Region

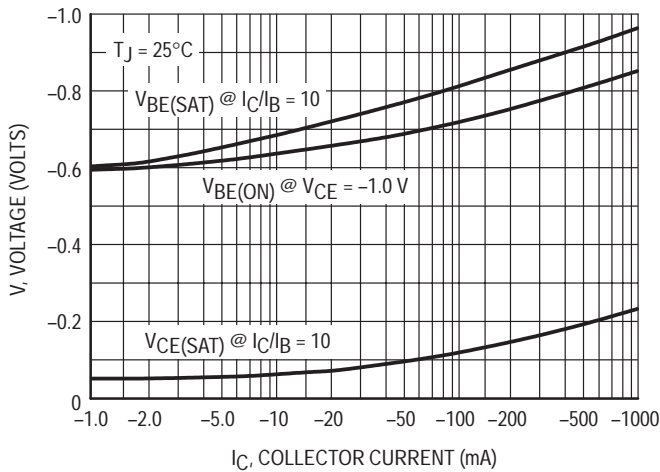


Figure 3. "ON" Voltages

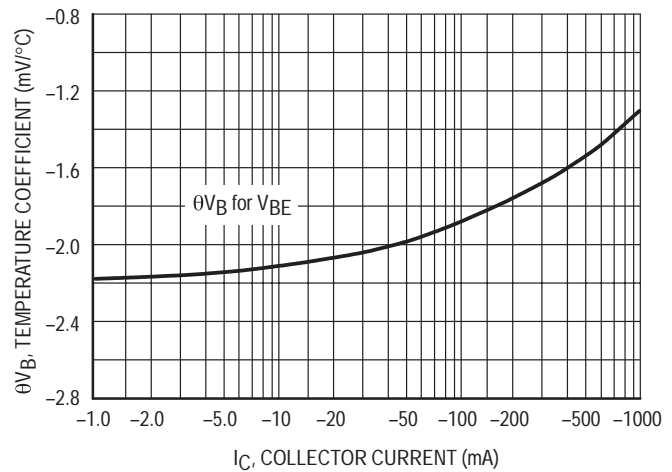


Figure 4. Temperature Coefficient

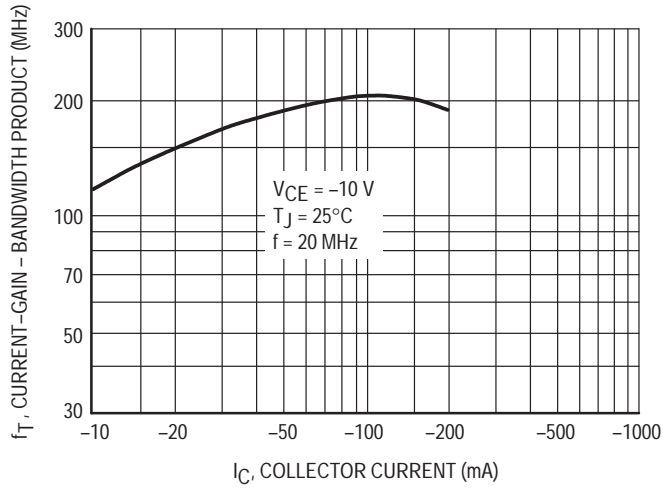


Figure 5. Current Gain — Bandwidth Product

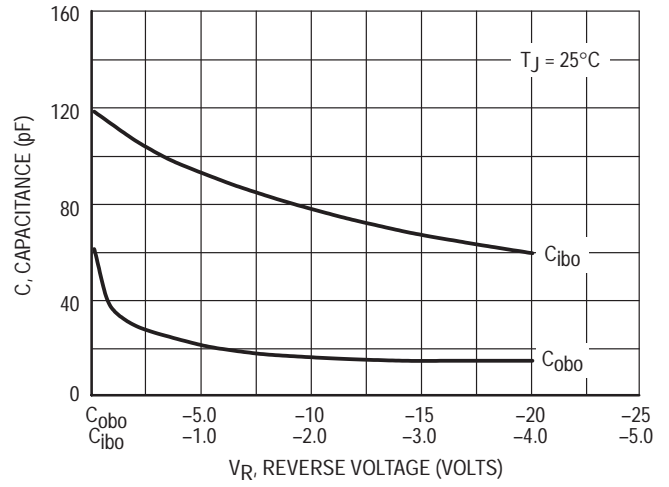


Figure 6. Capacitance

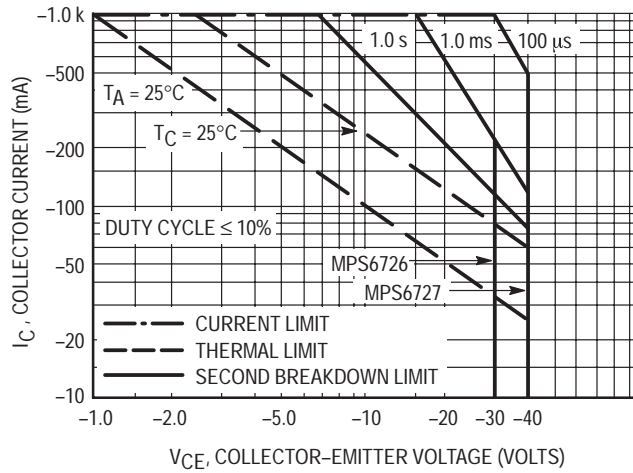
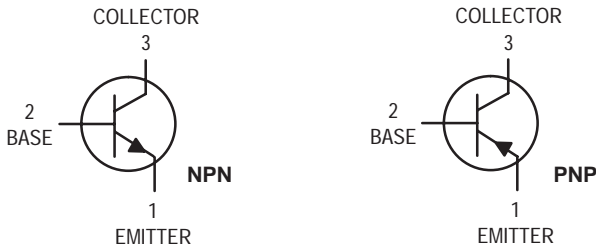


Figure 7. Active Region — Safe Operating Area

Amplifier Transistors



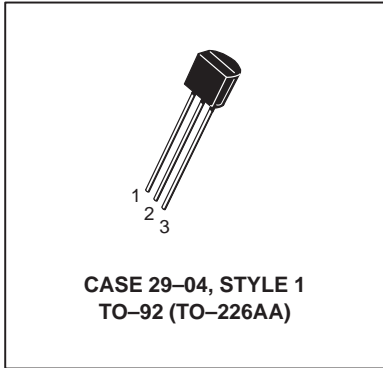
NPN
MPS8098
MPS8099*
PNP
MPS8598
MPS8599*

Voltage and current are negative
for PNP transistors

*Motorola Preferred Device

MAXIMUM RATINGS

Rating	Symbol	MPS8098 MPS8598	MPS8099 MPS8599	Unit
Collector–Emitter Voltage	V_{CEO}	60	80	Vdc
Collector–Base Voltage	V_{CBO}	60	80	Vdc
		MPS8099	MPS8598 MPS8599	
Emitter–Base Voltage	V_{EBO}	6.0	5.0	Vdc
Collector Current – Continuous	I_C	500		mAdc
Total Device Dissipation @ $T_A = 25^\circ\text{C}$ Derate above 25°C	P_D	625	5.0	mW mW/°C
Total Device Dissipation @ $T_C = 25^\circ\text{C}$ Derate above 25°C	P_D	1.5	12	Watts mW/°C
Operating and Storage Junction Temperature Range	T_J, T_{stg}	–55 to +150		°C



THERMAL CHARACTERISTICS

Characteristic	Symbol	Max	Unit
Thermal Resistance, Junction to Ambient	$R_{\theta JA}$	200	°C/W
Thermal Resistance, Junction to Case	$R_{\theta JC}$	83.3	°C/W

ELECTRICAL CHARACTERISTICS ($T_A = 25^\circ\text{C}$ unless otherwise noted)

Characteristic	Symbol	Min	Max	Unit
----------------	--------	-----	-----	------

OFF CHARACTERISTICS

Collector–Emitter Breakdown Voltage ⁽¹⁾ ($I_C = 10 \text{ mAdc}, I_B = 0$)	MPS8098, MPS8598 MPS8099, MPS8599	$V_{(BR)CEO}$	60 80	— —	Vdc
Collector–Base Breakdown Voltage ($I_C = 100 \mu\text{Adc}, I_E = 0$)	MPS8098, MPS8598 MPS8099, MPS8599	$V_{(BR)CBO}$	60 80	— —	Vdc
Emitter–Base Breakdown Voltage ($I_E = 10 \mu\text{Adc}, I_C = 0$)	MPS8098, MPS8099 MPS8598, MPS8599	$V_{(BR)EBO}$	6.0 5.0	— —	Vdc
Collector Cutoff Current ($V_{CE} = 60 \text{ Vdc}, I_B = 0$)		I_{CES}	—	0.1	μAdc
Collector Cutoff Current ($V_{CB} = 60 \text{ Vdc}, I_E = 0$) ($V_{CB} = 80 \text{ Vdc}, I_E = 0$)	MPS8098, MPS8598 MPS8099, MPS8599	I_{CBO}	— —	0.1 0.1	μAdc
Emitter Cutoff Current ($V_{EB} = 6.0 \text{ Vdc}, I_C = 0$) ($V_{EB} = 4.0 \text{ Vdc}, I_C = 0$)	MPS8098, MPS8099 MPS8598, MPS8599	I_{EBO}	— —	0.1 0.1	μAdc

1. Pulse Test: Pulse Width $\leq 300 \mu\text{s}$, Duty Cycle = 2.0%.

Preferred devices are Motorola recommended choices for future use and best overall value.

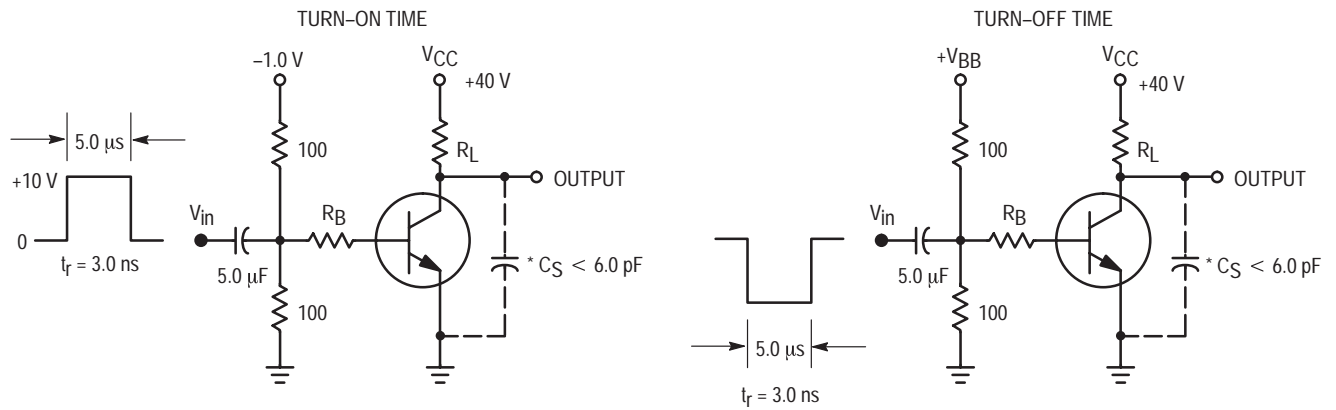
ELECTRICAL CHARACTERISTICS ($T_A = 25^\circ\text{C}$ unless otherwise noted) (Continued)

Characteristic	Symbol	Min	Max	Unit
ON CHARACTERISTICS(1)				
DC Current Gain ($I_C = 1.0\text{ mAdc}$, $V_{CE} = 5.0\text{ Vdc}$) ($I_C = 10\text{ mAdc}$, $V_{CE} = 5.0\text{ Vdc}$) ($I_C = 100\text{ mAdc}$, $V_{CE} = 5.0\text{ Vdc}$)	h_{FE}	100 100 75	300 — —	—
Collector–Emitter Saturation Voltage ($I_C = 100\text{ mAdc}$, $I_B = 5.0\text{ mAdc}$) ($I_C = 100\text{ mAdc}$, $I_B = 10\text{ mAdc}$)	$V_{CE(sat)}$	— —	0.4 0.3	Vdc
Base–Emitter On Voltage ($I_C = 1.0\text{ mAdc}$, $V_{CE} = 5.0\text{ Vdc}$) ($I_C = 10\text{ mAdc}$, $V_{CE} = 5.0\text{ Vdc}$)	$V_{BE(on)}$	0.5 0.6	0.7 0.8	Vdc
		MPS8098, MPS8598 MPS8099, MPS8599		

SMALL–SIGNAL CHARACTERISTICS

Current–Gain — Bandwidth Product ($I_C = 10\text{ mAdc}$, $V_{CE} = 5.0\text{ Vdc}$, $f = 100\text{ MHz}$)	f_T	150	—	MHz
Output Capacitance ($V_{CB} = 5.0\text{ Vdc}$, $I_E = 0$, $f = 1.0\text{ MHz}$)	C_{obo}	— —	6.0 8.0	pF
Input Capacitance ($V_{EB} = 0.5\text{ Vdc}$, $I_C = 0$, $f = 1.0\text{ MHz}$)	C_{ibo}	— —	25 30	pF

1. Pulse Test: Pulse Width $\leq 300\ \mu\text{s}$, Duty Cycle = 2.0%.



* Total Shunt Capacitance of Test Jig and Connectors
For PNP Test Circuits, Reverse All Voltage Polarities

Figure 1. Switching Time Test Circuits

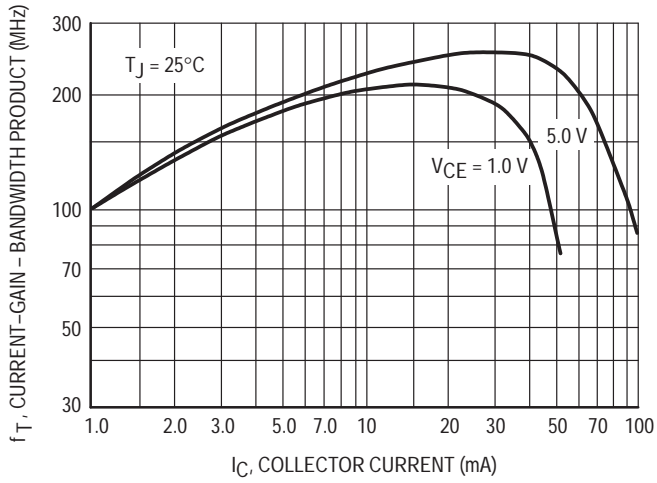


Figure 2. MPS8098/99 Current-Gain — Bandwidth Product

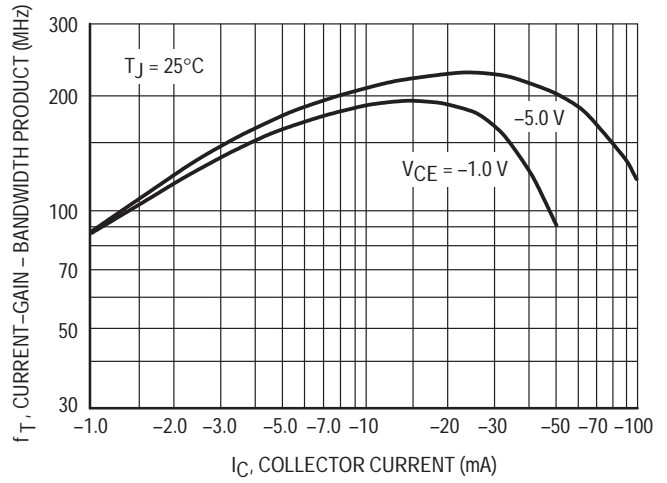


Figure 3. MPS8598/99 Current-Gain — Bandwidth Product

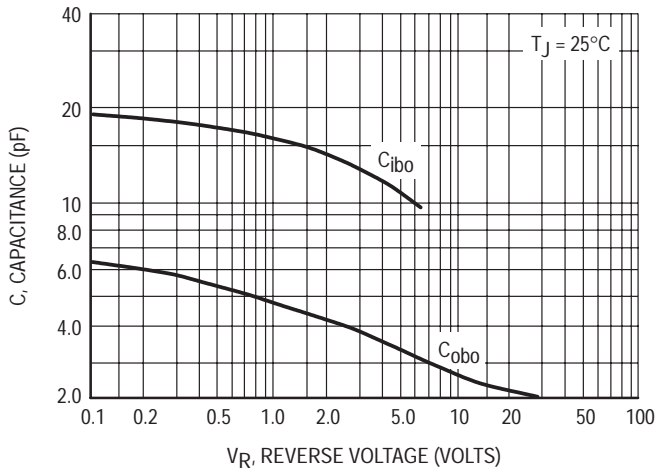


Figure 4. MPS8098/99 Capacitance

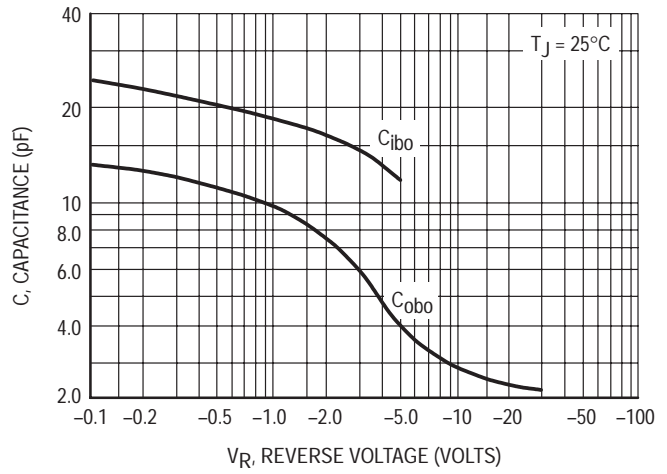


Figure 5. MPS8598/99 Capacitance

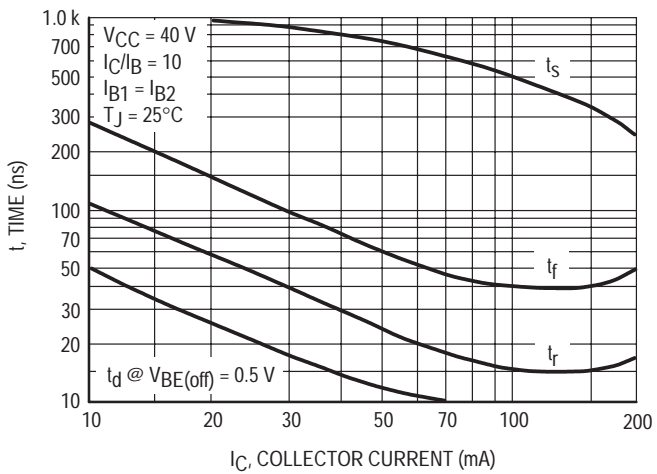


Figure 6. MPS8098/99 Switching Times

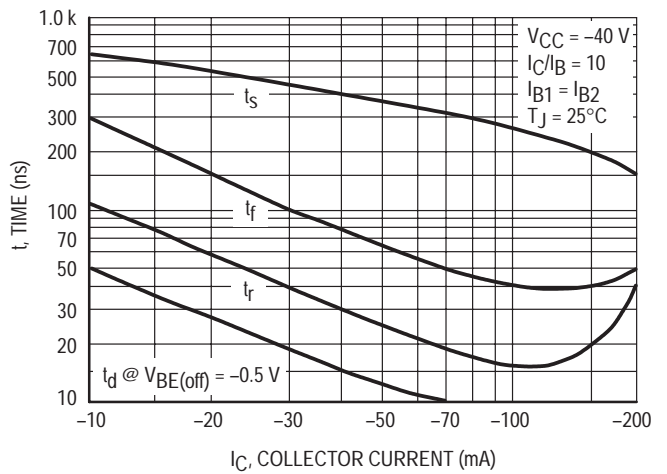


Figure 7. MPS8598/99 Switching Times

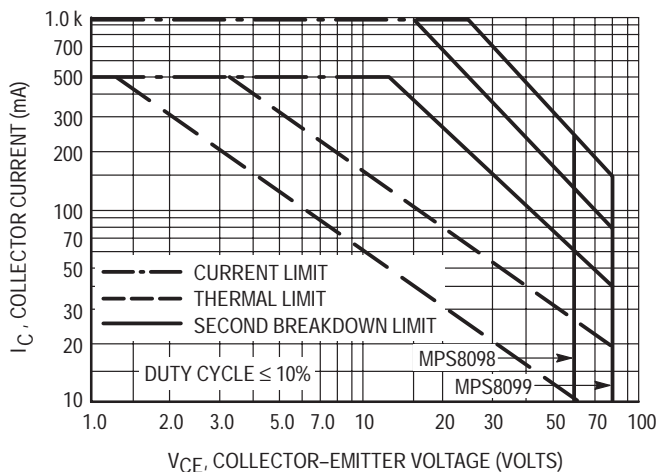


Figure 8. MPS8098/99 Active-Region Safe Operating Area

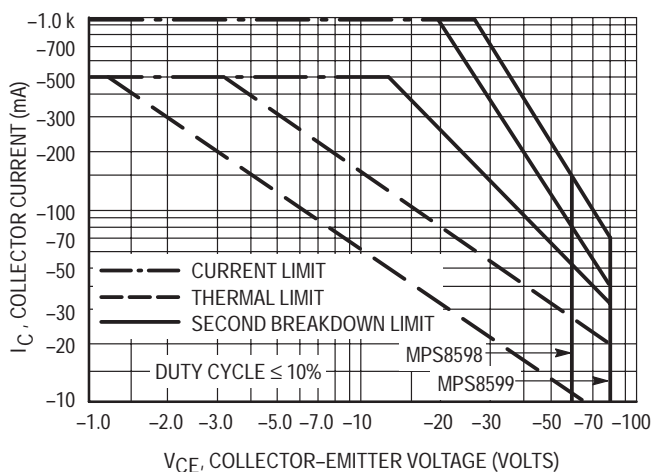


Figure 9. MPS8598/99 Active-Region Safe Operating Area

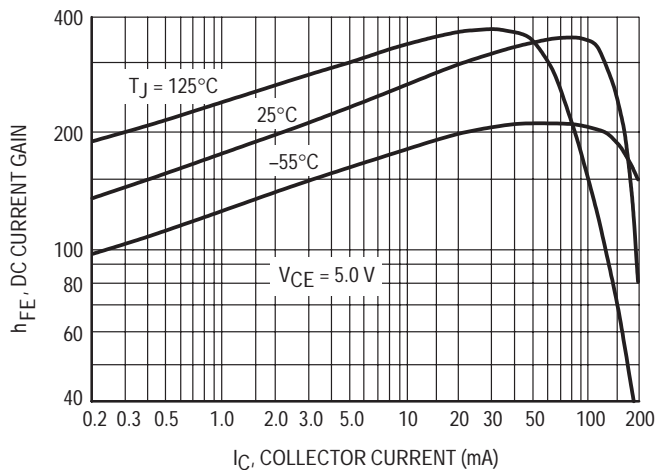


Figure 10. MPS8098/99 DC Current Gain

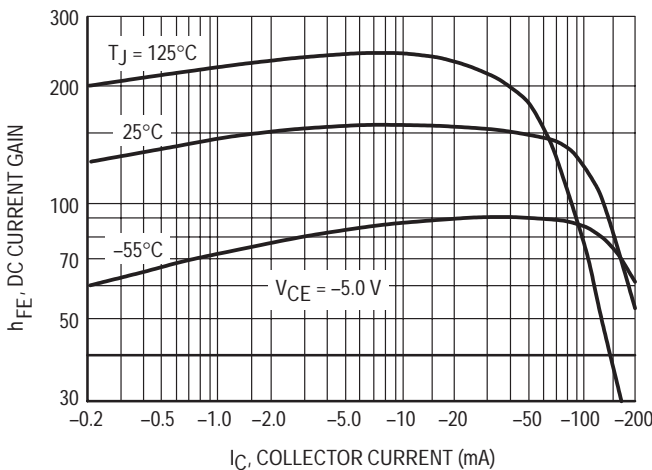


Figure 11. MPS8598/99 DC Current Gain

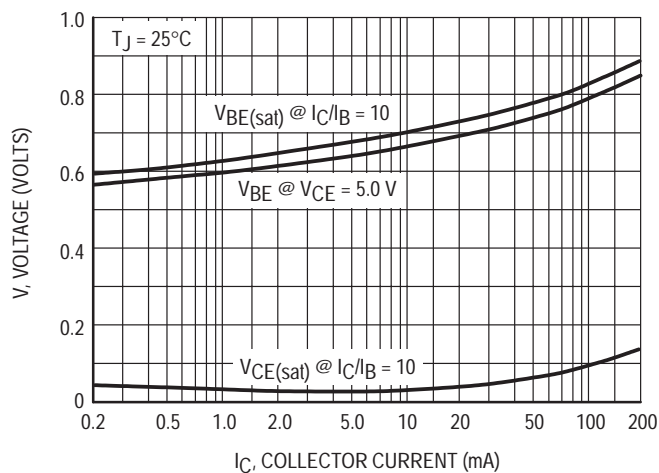


Figure 12. MPS8098/99 "ON" Voltages

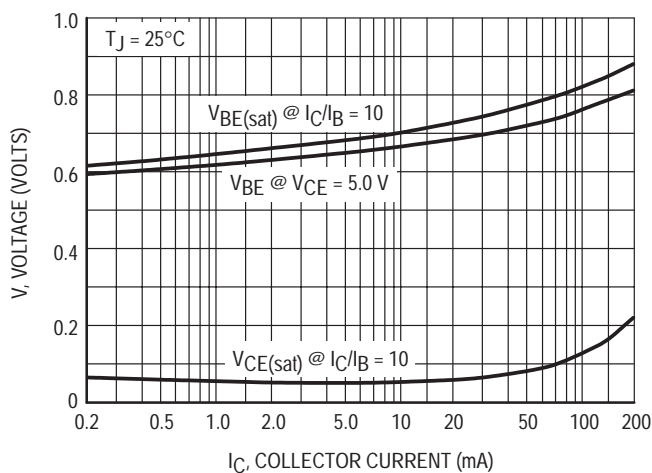


Figure 13. MPS8598/99 "ON" Voltages

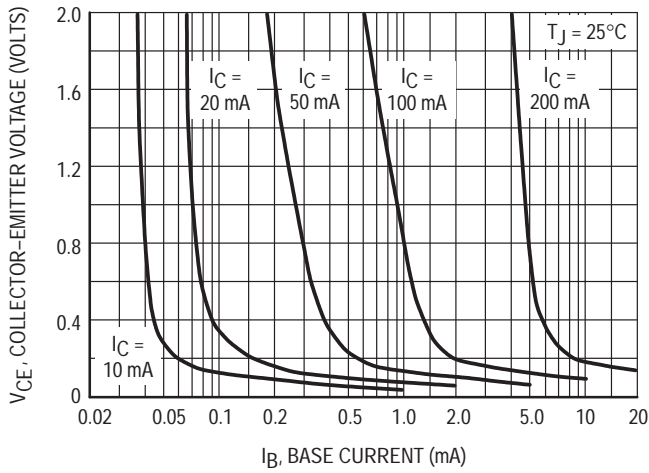


Figure 14. MPS8098/99 Collector Saturation Region

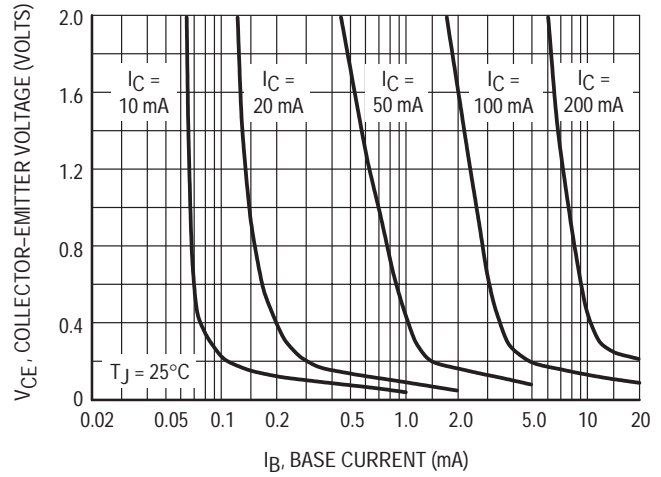


Figure 15. MPS8598/99 Collector Saturation Region

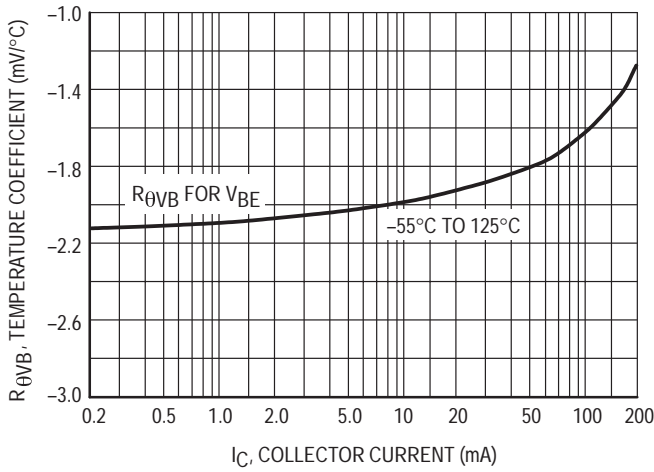


Figure 16. MPS8098/99 Base-Emitter Temperature Coefficient

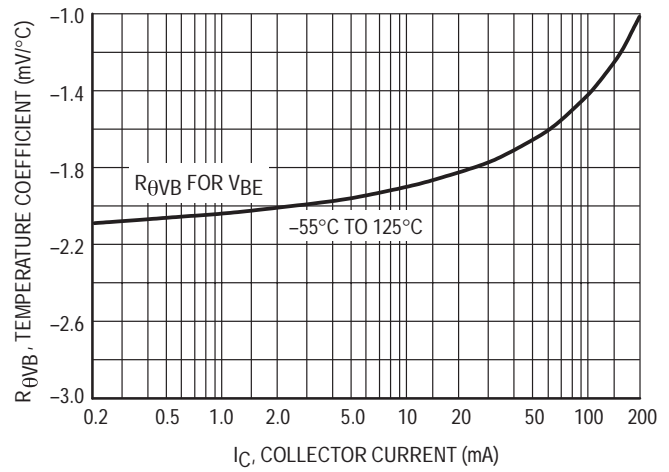


Figure 17. MPS8598/99 Base-Emitter Temperature Coefficient

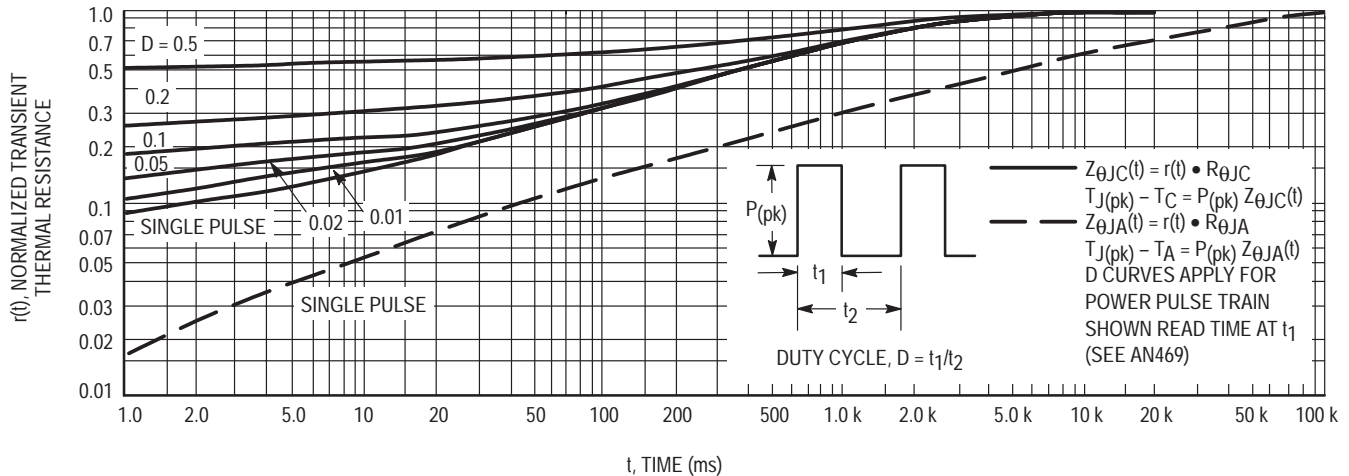
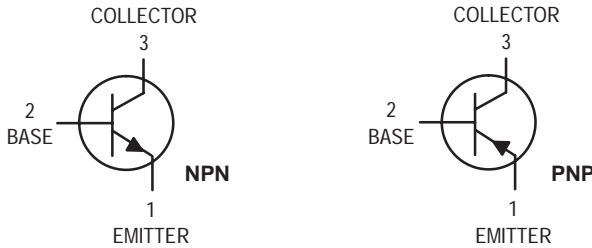


Figure 18. MPS8098, MPS8099, MPS8598 and MPS8599 Thermal Response

Amplifier Transistors



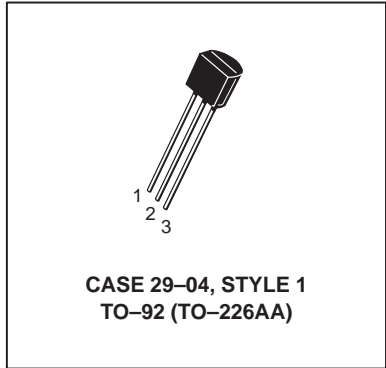
NPN
MPSA05
MPSA06*
PNP
MPSA55
MPSA56*

Voltage and current are negative for PNP transistors

*Motorola Preferred Device

MAXIMUM RATINGS

Rating	Symbol	MPSA05 MPSA55	MPSA06 MPSA56	Unit
Collector–Emitter Voltage	V_{CEO}	60	80	Vdc
Collector–Base Voltage	V_{CBO}	60	80	Vdc
Emitter–Base Voltage	V_{EBO}	4.0		Vdc
Collector Current – Continuous	I_C	500		mAdc
Total Device Dissipation @ $T_A = 25^\circ\text{C}$ Derate above 25°C	P_D	625	5.0	mW mW/°C
Total Device Dissipation @ $T_C = 25^\circ\text{C}$ Derate above 25°C	P_D	1.5	12	Watts mW/°C
Operating and Storage Junction Temperature Range	T_J, T_{stg}	–55 to +150		°C



THERMAL CHARACTERISTICS

Characteristic	Symbol	Max	Unit
Thermal Resistance, Junction to Ambient	$R_{\theta JA}^{(1)}$	200	°C/W
Thermal Resistance, Junction to Case	$R_{\theta JC}$	83.3	°C/W

ELECTRICAL CHARACTERISTICS ($T_A = 25^\circ\text{C}$ unless otherwise noted)

Characteristic	Symbol	Min	Max	Unit
----------------	--------	-----	-----	------

OFF CHARACTERISTICS

Collector–Emitter Breakdown Voltage ⁽²⁾ ($I_C = 1.0 \text{ mAdc}, I_B = 0$)	MPSA05, MPSA55 MPSA06, MPSA56	$V_{(BR)CEO}$	60 80	— —	Vdc
Emitter–Base Breakdown Voltage ($I_E = 100 \mu\text{Adc}, I_C = 0$)		$V_{(BR)EBO}$	4.0	—	Vdc
Collector Cutoff Current ($V_{CE} = 60 \text{ Vdc}, I_B = 0$)		I_{CES}	—	0.1	μAdc
Collector Cutoff Current ($V_{CB} = 60 \text{ Vdc}, I_E = 0$) ($V_{CB} = 80 \text{ Vdc}, I_E = 0$)	MPSA05, MPSA55 MPSA06, MPSA56	I_{CBO}	— —	0.1 0.1	μAdc

- $R_{\theta JA}$ is measured with the device soldered into a typical printed circuit board.
- Pulse Test: Pulse Width $\leq 300 \mu\text{s}$, Duty Cycle $\leq 2.0\%$.

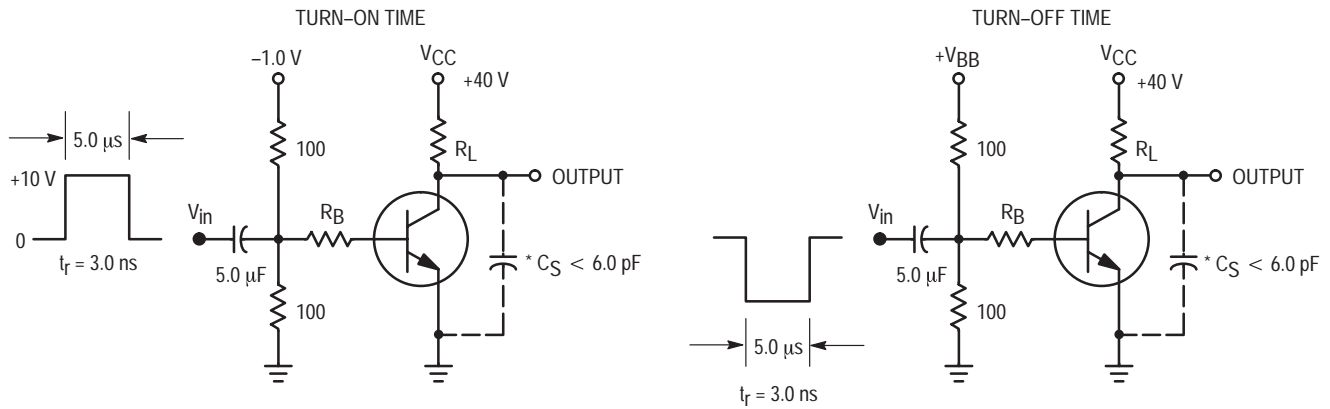
Preferred devices are Motorola recommended choices for future use and best overall value.

NPN MPSA05 MPSA06 PNP MPSA55 MPSA56

ELECTRICAL CHARACTERISTICS ($T_A = 25^\circ\text{C}$ unless otherwise noted) (Continued)

Characteristic	Symbol	Min	Max	Unit
ON CHARACTERISTICS				
DC Current Gain ($I_C = 10\text{ mA}$, $V_{CE} = 1.0\text{ Vdc}$) ($I_C = 100\text{ mA}$, $V_{CE} = 1.0\text{ Vdc}$)	h_{FE}	100 100	— —	—
Collector–Emitter Saturation Voltage ($I_C = 100\text{ mA}$, $I_B = 10\text{ mA}$)	$V_{CE(sat)}$	—	0.25	Vdc
Base–Emitter On Voltage ($I_C = 100\text{ mA}$, $V_{CE} = 1.0\text{ Vdc}$)	$V_{BE(on)}$	—	1.2	Vdc
SMALL–SIGNAL CHARACTERISTICS				
Current–Gain — Bandwidth Product ⁽³⁾ ($I_C = 10\text{ mA}$, $V_{CE} = 2.0\text{ V}$, $f = 100\text{ MHz}$) ($I_C = 100\text{ mA}$, $V_{CE} = 1.0\text{ Vdc}$, $f = 100\text{ MHz}$)	f_T	100 50	— —	MHz
		MPSA05 MPSA06		
		MPSA55 MPSA56		

3. f_T is defined as the frequency at which $|h_{fe}|$ extrapolates to unity.



* Total Shunt Capacitance of Test Jig and Connectors
For PNP Test Circuits, Reverse All Voltage Polarities

Figure 1. Switching Time Test Circuits

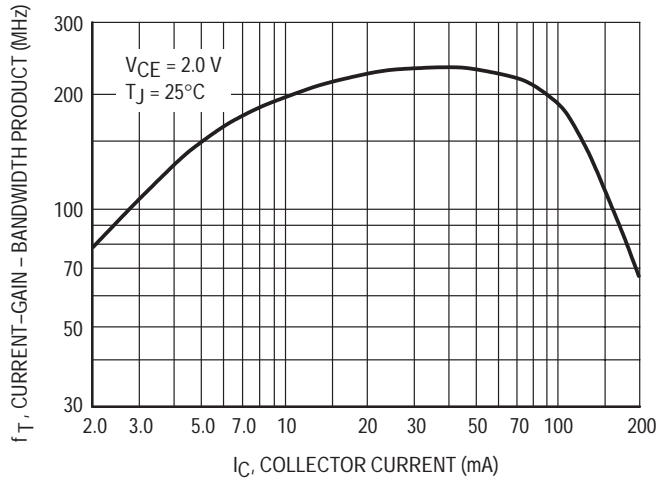


Figure 2. MPSA05/06 Current-Gain — Bandwidth Product

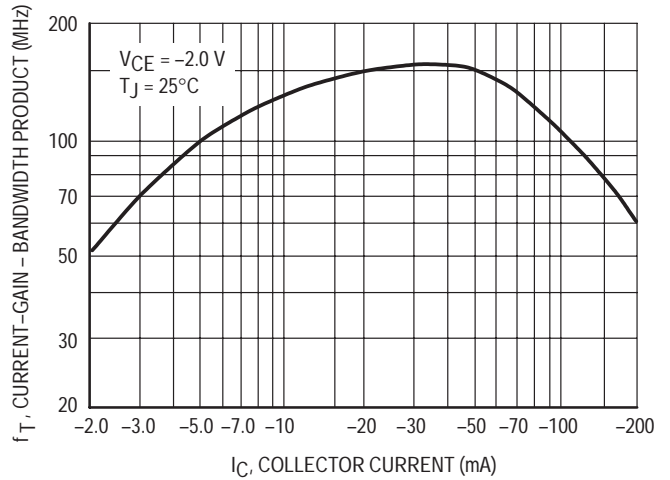


Figure 3. MPSA55/56 Current-Gain — Bandwidth Product

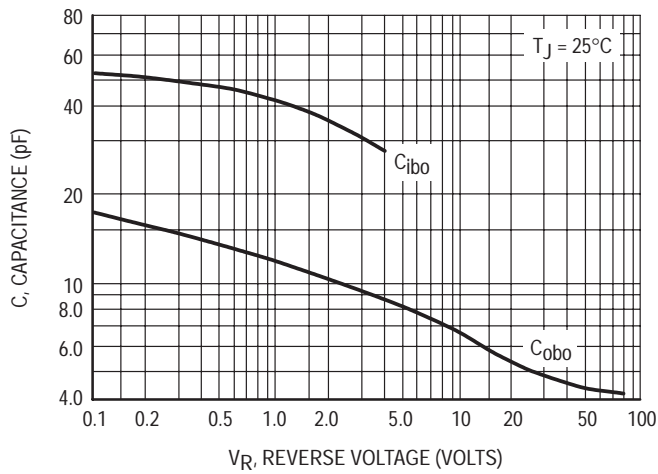


Figure 4. MPSA05/06 Capacitance

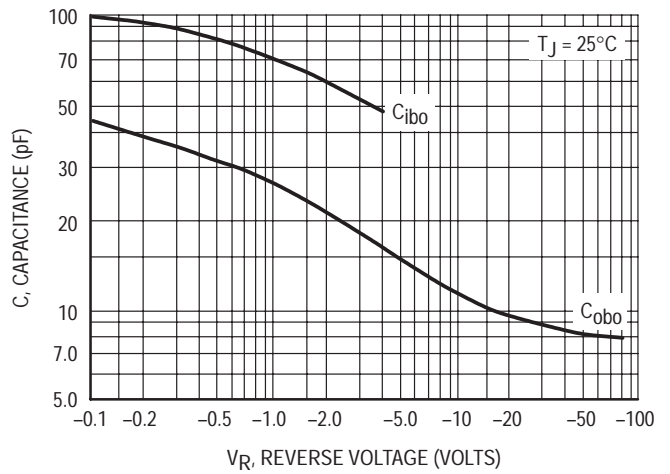


Figure 5. MPSA55/56 Capacitance

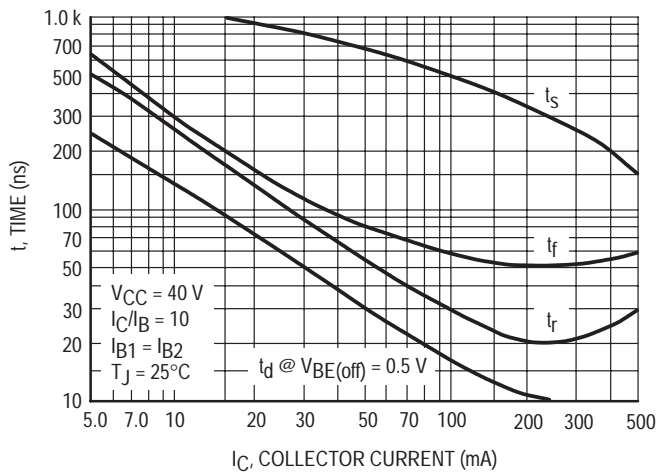


Figure 6. MPSA05/06 Switching Time

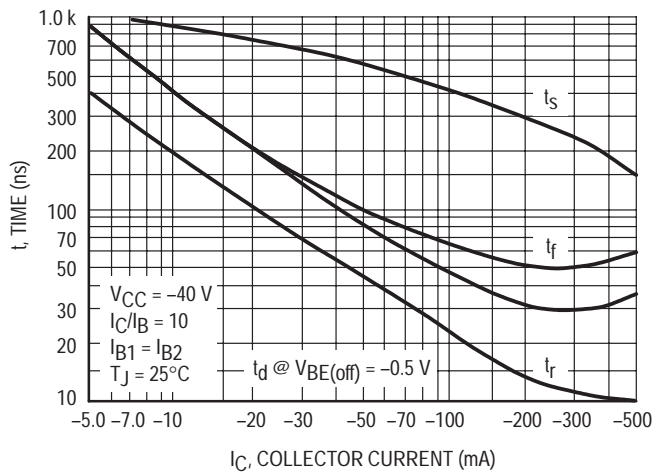


Figure 7. MPSA55/56 Switching Time

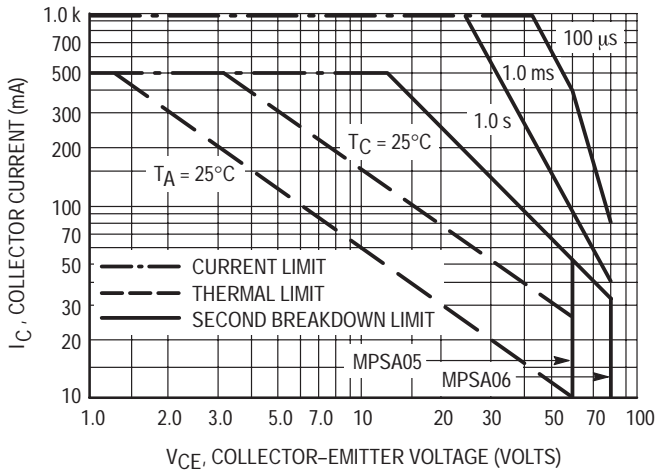


Figure 8. MPSA05/06 Active-Region Safe Operating Area

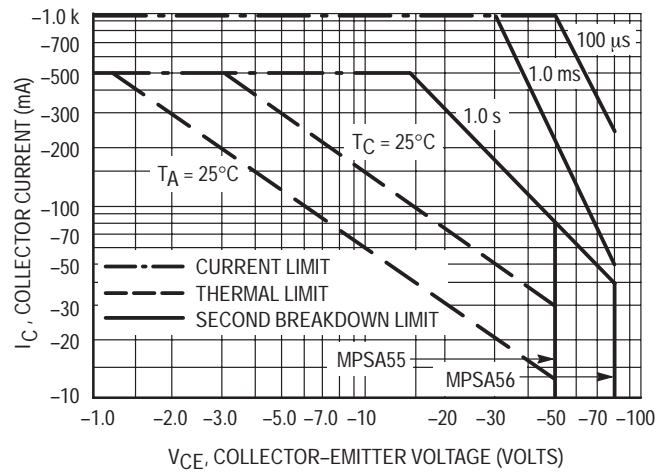


Figure 9. MPSA55/56 Active-Region Safe Operating Area

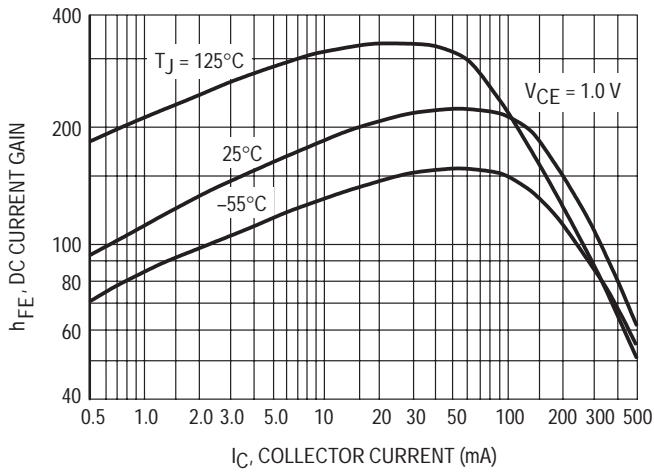


Figure 10. MPSA05/06 DC Current Gain

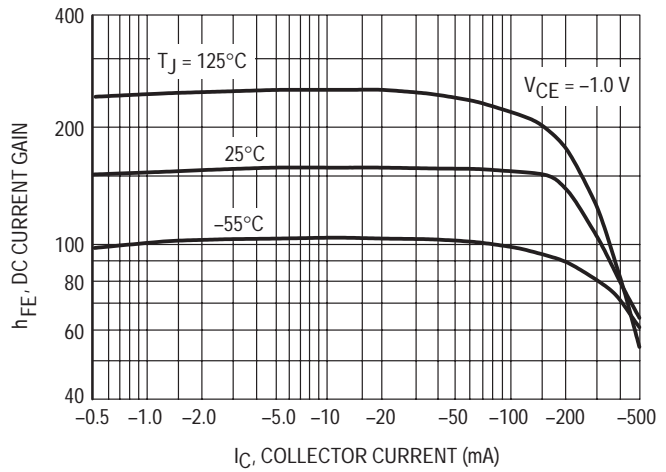


Figure 11. MPSA55/56 DC Current Gain

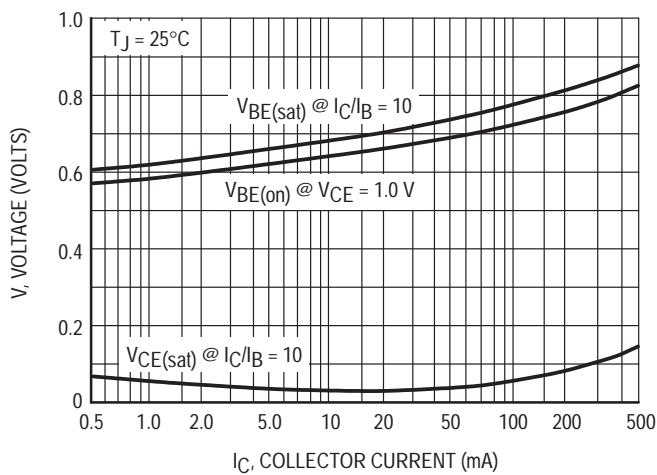


Figure 12. MPSA05/06 "ON" Voltages

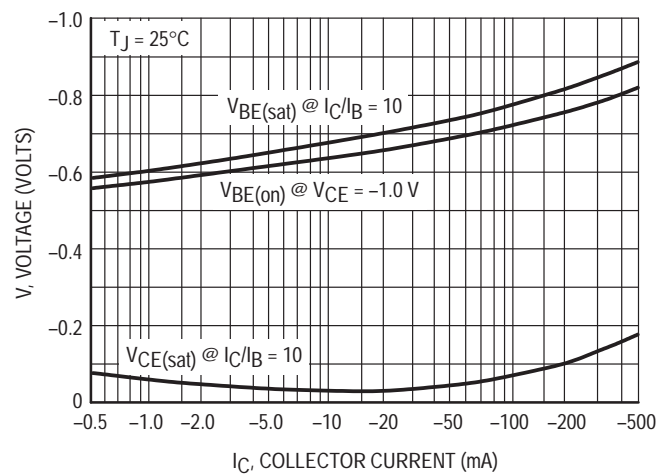


Figure 13. MPSA55/56 "ON" Voltages

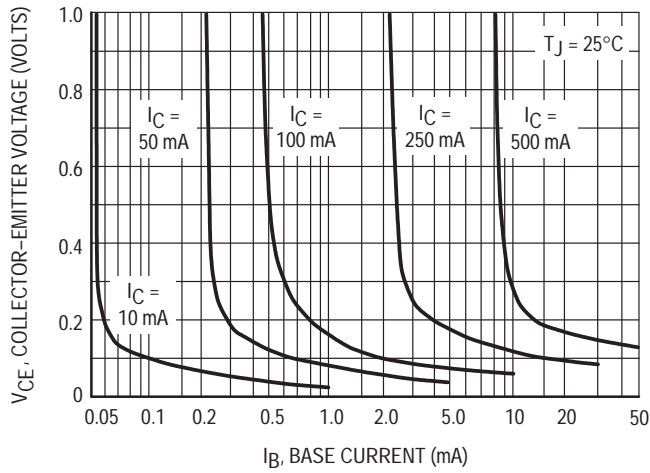


Figure 14. MPSA05/06 Collector Saturation Region

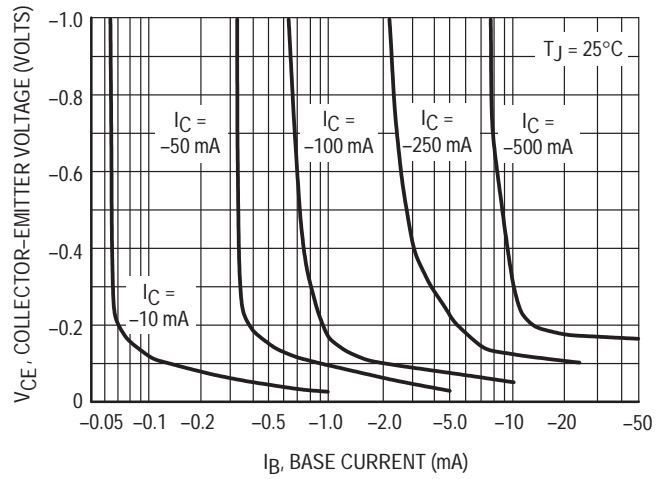


Figure 15. MPSA55/56 Collector Saturation Region

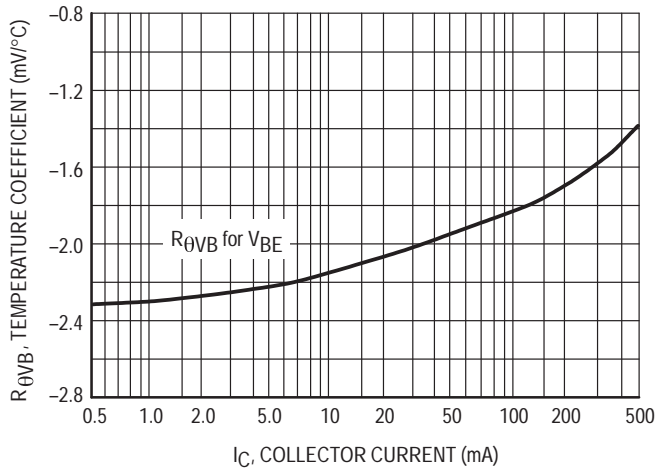


Figure 16. MPSA05/06 Base-Emitter Temperature Coefficient

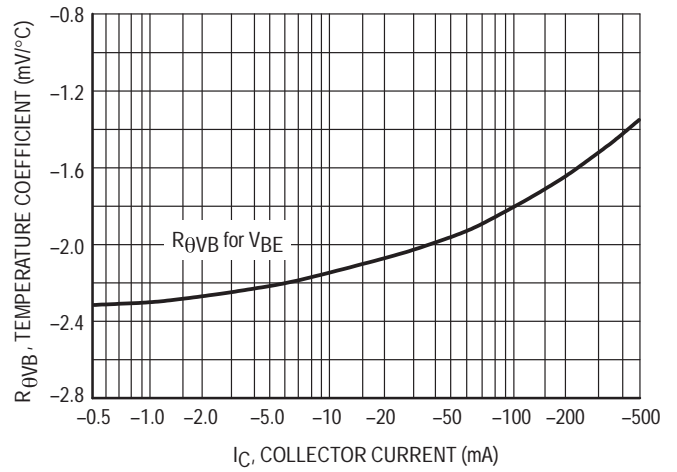


Figure 17. MPSA55/56 Base-Emitter Temperature Coefficient

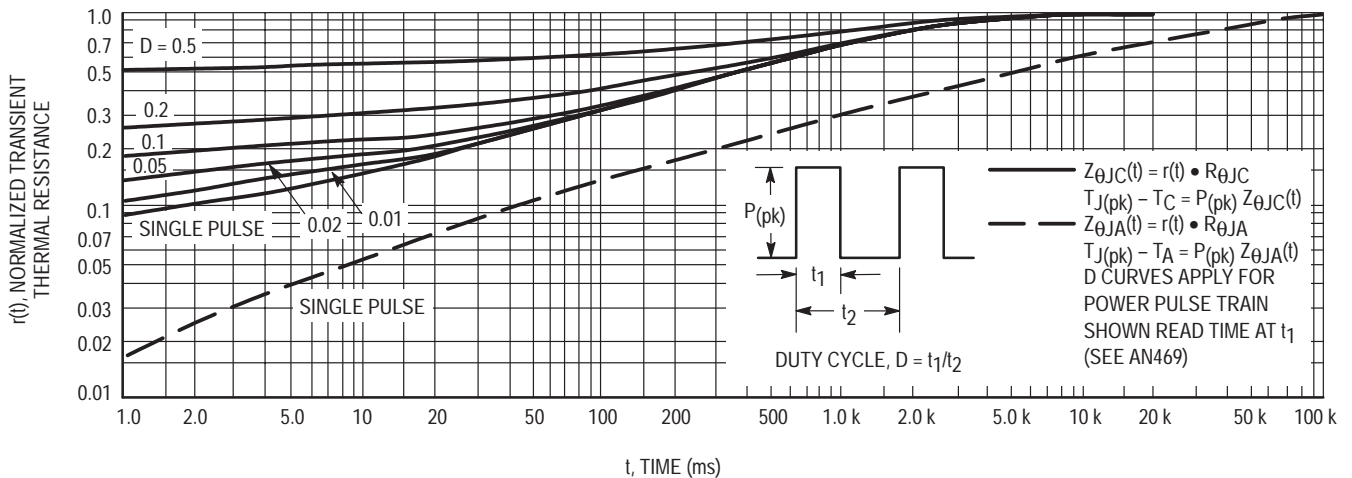
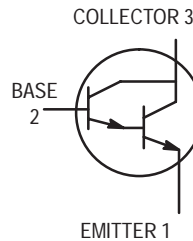


Figure 18. MPSA05, MPSA06, MPSA55 and MPSA56 Thermal Response

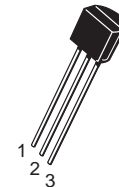
Darlington Transistors

NPN Silicon



MPSA13
MPSA14*

*Motorola Preferred Device



CASE 29-04, STYLE 1
TO-92 (TO-226AA)

MAXIMUM RATINGS

Rating	Symbol	Value	Unit
Collector–Emitter Voltage	V_{CES}	30	Vdc
Collector–Base Voltage	V_{CBO}	30	Vdc
Emitter–Base Voltage	V_{EBO}	10	Vdc
Collector Current — Continuous	I_C	500	mAdc
Total Device Dissipation @ $T_A = 25^\circ\text{C}$ Derate above 25°C	P_D	625 5.0	mW mW/ $^\circ\text{C}$
Total Device Dissipation @ $T_C = 25^\circ\text{C}$ Derate above 25°C	P_D	1.5 12	Watts mW/ $^\circ\text{C}$
Operating and Storage Junction Temperature Range	T_J, T_{stg}	-55 to +150	$^\circ\text{C}$

THERMAL CHARACTERISTICS

Characteristic	Symbol	Max	Unit
Thermal Resistance, Junction to Ambient	$R_{\theta JA}$	200	$^\circ\text{C}/\text{W}$
Thermal Resistance, Junction to Case	$R_{\theta JC}$	83.3	$^\circ\text{C}/\text{W}$

ELECTRICAL CHARACTERISTICS ($T_A = 25^\circ\text{C}$ unless otherwise noted)

Characteristic	Symbol	Min	Max	Unit
----------------	--------	-----	-----	------

OFF CHARACTERISTICS

Collector–Emitter Breakdown Voltage ($I_C = 100 \mu\text{Adc}, I_B = 0$)	$V_{(BR)CES}$	30	—	Vdc
Collector Cutoff Current ($V_{CB} = 30 \text{ Vdc}, I_E = 0$)	I_{CBO}	—	100	nAdc
Emitter Cutoff Current ($V_{EB} = 10 \text{ Vdc}, I_C = 0$)	I_{EBO}	—	100	nAdc

Preferred devices are Motorola recommended choices for future use and best overall value.

ELECTRICAL CHARACTERISTICS ($T_A = 25^\circ\text{C}$ unless otherwise noted) (Continued)

Characteristic	Symbol	Min	Max	Unit
ON CHARACTERISTICS(1)				
DC Current Gain ($I_C = 10\text{ mAdc}$, $V_{CE} = 5.0\text{ Vdc}$)	MPSA13	5,000	—	—
	MPSA14	10,000	—	—
($I_C = 100\text{ mAdc}$, $V_{CE} = 5.0\text{ Vdc}$)	MPSA13	10,000	—	—
	MPSA14	20,000	—	—
Collector–Emitter Saturation Voltage ($I_C = 100\text{ mAdc}$, $I_B = 0.1\text{ mAdc}$)	$V_{CE(sat)}$	—	1.5	Vdc
Base–Emitter On Voltage ($I_C = 100\text{ mAdc}$, $V_{CE} = 5.0\text{ Vdc}$)	$V_{BE(on)}$	—	2.0	Vdc
SMALL–SIGNAL CHARACTERISTICS				
Current–Gain – Bandwidth Product(2) ($I_C = 10\text{ mAdc}$, $V_{CE} = 5.0\text{ Vdc}$, $f = 100\text{ MHz}$)	f_T	125	—	MHz

1. Pulse Test: Pulse Width $\leq 300\ \mu\text{s}$; Duty Cycle $\leq 2.0\%$.
2. $f_T = |h_{fe}| \cdot f_{test}$.

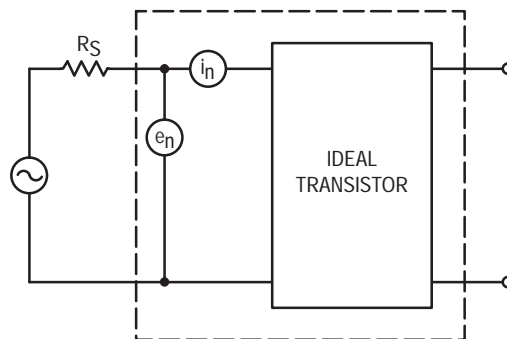


Figure 1. Transistor Noise Model

NOISE CHARACTERISTICS

($V_{CE} = 5.0 \text{ Vdc}$, $T_A = 25^\circ\text{C}$)

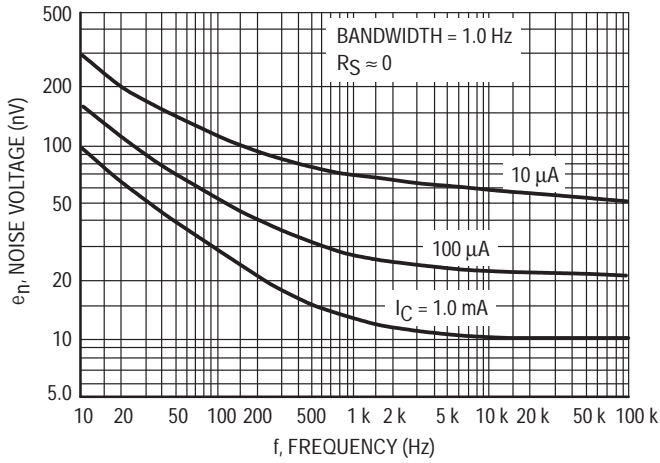


Figure 2. Noise Voltage

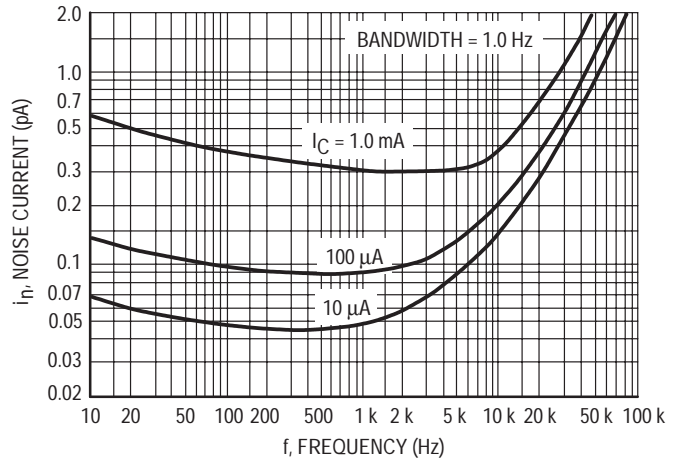


Figure 3. Noise Current

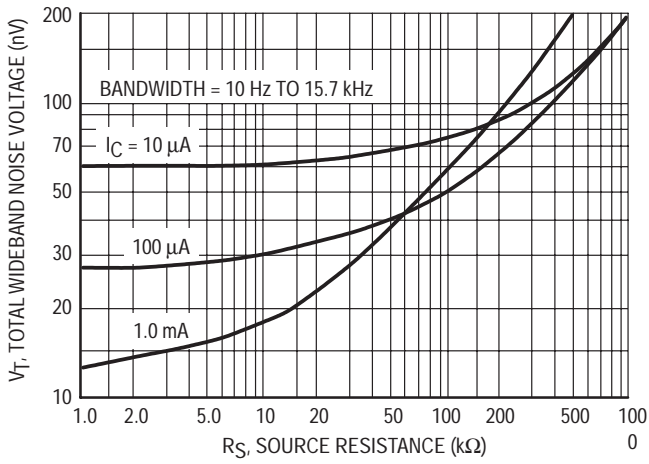


Figure 4. Total Wideband Noise Voltage

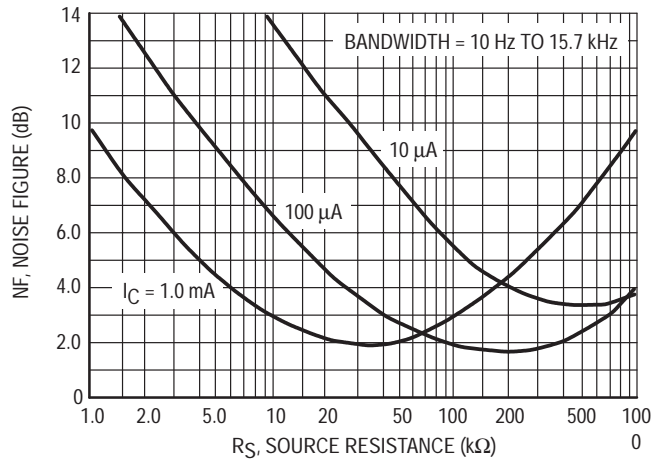


Figure 5. Wideband Noise Figure

SMALL-SIGNAL CHARACTERISTICS

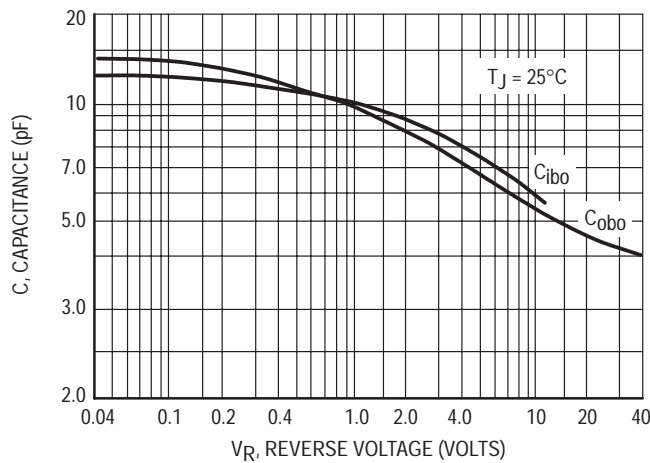


Figure 6. Capacitance

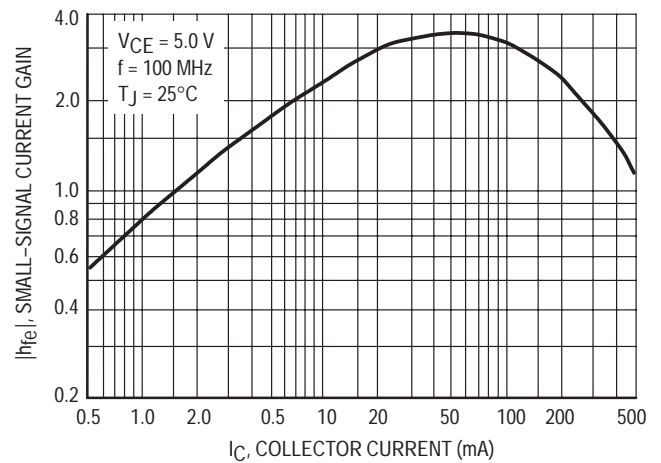


Figure 7. High Frequency Current Gain

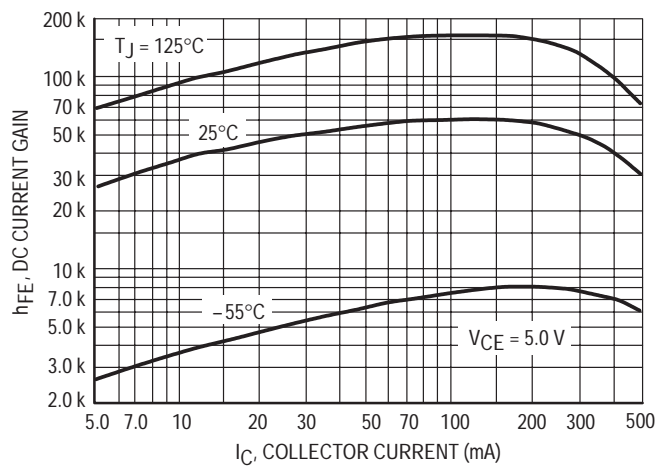


Figure 8. DC Current Gain

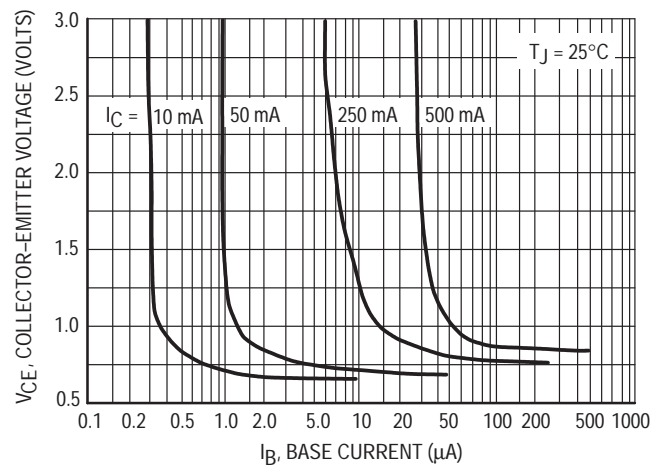


Figure 9. Collector Saturation Region

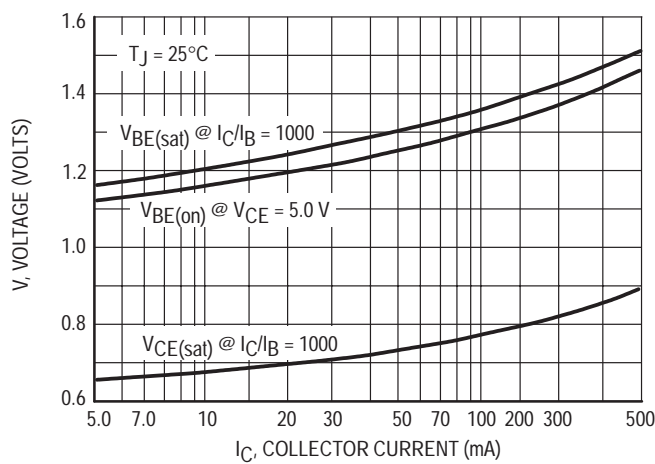


Figure 10. "On" Voltages

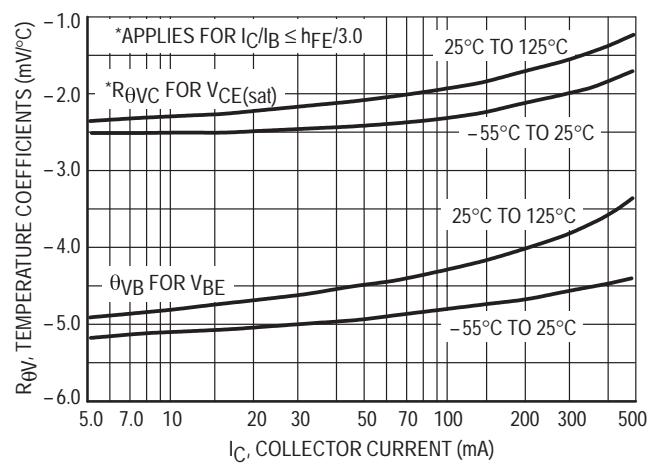


Figure 11. Temperature Coefficients

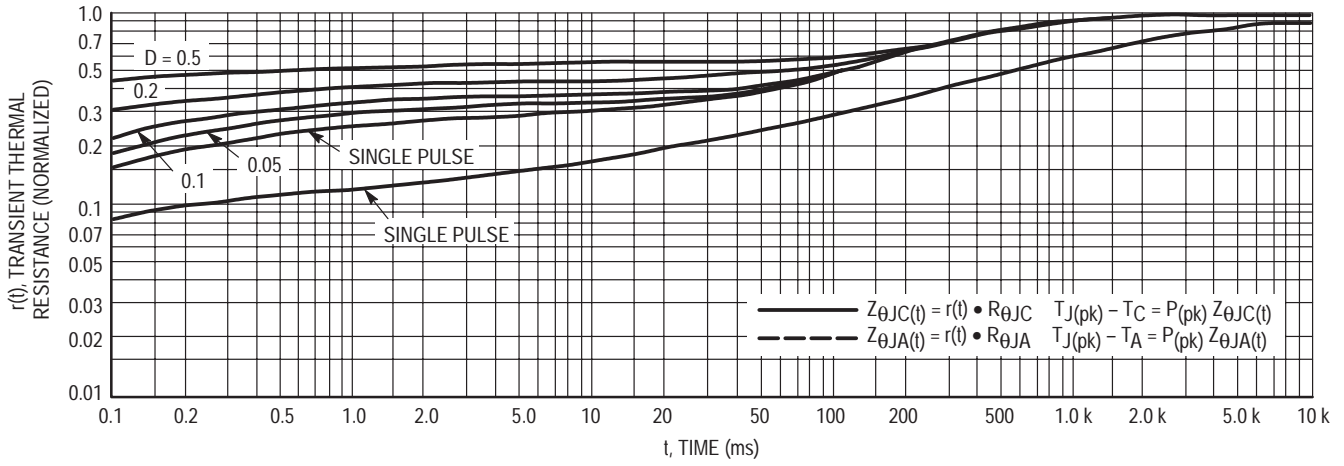


Figure 12. Thermal Response

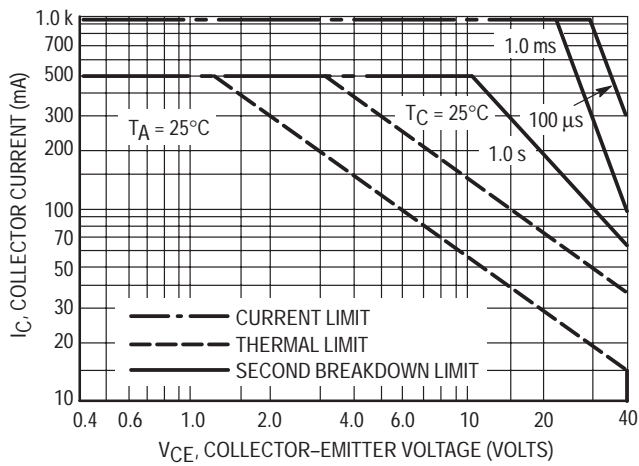
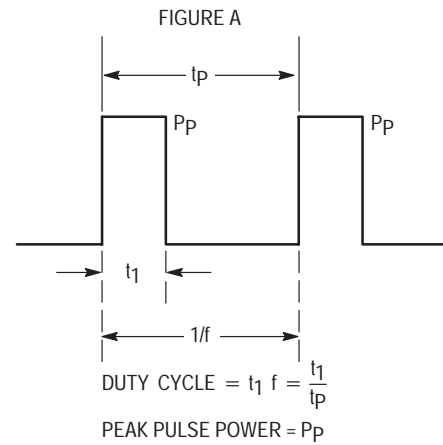


Figure 13. Active Region Safe Operating Area



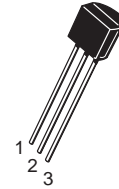
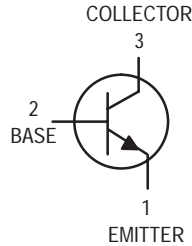
Design Note: Use of Transient Thermal Resistance Data

Chopper Transistor

NPN Silicon

MPSA17

Motorola Preferred Device



CASE 29-04, STYLE 1
TO-92 (TO-226AA)

MAXIMUM RATINGS

Rating	Symbol	Value	Unit
Collector–Emitter Voltage	V_{CEO}	40	Vdc
Emitter–Base Voltage	V_{EBO}	15	Vdc
Collector Current – Continuous	I_C	100	mAdc
Total Device Dissipation @ $T_A = 25^\circ\text{C}$ Derate above 25°C	P_D	350 2.8	mW mW/ $^\circ\text{C}$
Total Device Dissipation @ $T_C = 25^\circ\text{C}$ Derate above 25°C	P_D	1.0 8.0	Watts mW/ $^\circ\text{C}$
Operating and Storage Junction Temperature Range	T_J, T_{stg}	-55 to +150	$^\circ\text{C}$

THERMAL CHARACTERISTICS

Characteristic	Symbol	Max	Unit
Thermal Resistance, Junction to Ambient	$R_{\theta JA}$	357	$^\circ\text{C}/\text{W}$
Thermal Resistance, Junction to Case	$R_{\theta JC}$	125	$^\circ\text{C}/\text{W}$

ELECTRICAL CHARACTERISTICS ($T_A = 25^\circ\text{C}$ unless otherwise noted)

Characteristic	Symbol	Min	Max	Unit
----------------	--------	-----	-----	------

OFF CHARACTERISTICS

Collector–Emitter Breakdown Voltage ($I_C = 1.0 \text{ mAdc}, I_B = 0$)	$V_{(BR)CEO}$	40	—	Vdc
Emitter–Base Breakdown Voltage ($I_E = 0.1 \text{ mAdc}, I_C = 0$)	$V_{(BR)EBO}$	15	—	Vdc
Collector Cutoff Current ($V_{CB} = 30 \text{ Vdc}, I_E = 0$)	I_{CBO}	—	100	nAdc
Emitter Cutoff Current ($V_{EB} = 10 \text{ Vdc}, I_C = 0$)	I_{EBO}	—	100	nAdc

Preferred devices are Motorola recommended choices for future use and best overall value.

(Replaces MPSA16/D)

MPSA17**ELECTRICAL CHARACTERISTICS** ($T_A = 25^\circ\text{C}$ unless otherwise noted) (Continued)

Characteristic	Symbol	Min	Max	Unit
ON CHARACTERISTICS				
DC Current Gain ($I_C = 5.0 \text{ mA}_{dc}$, $V_{CE} = 10 \text{ V}_{dc}$)	h_{FE}	200	600	—
Collector–Emitter Saturation Voltage ($I_C = 10 \text{ mA}_{dc}$, $I_B = 1.0 \text{ mA}_{dc}$)	$V_{CE(sat)}$	—	0.25	V _{dc}
SMALL–SIGNAL CHARACTERISTICS				
Current–Gain — Bandwidth Product ($I_C = 5.0 \text{ mA}_{dc}$, $V_{CE} = 10 \text{ V}_{dc}$, $f = 100 \text{ MHz}$)	f_T	80	—	MHz
Output Capacitance ($V_{CB} = 10 \text{ V}_{dc}$, $I_E = 0$, $f = 1.0 \text{ MHz}$)	C_{obo}	—	4.0	pF

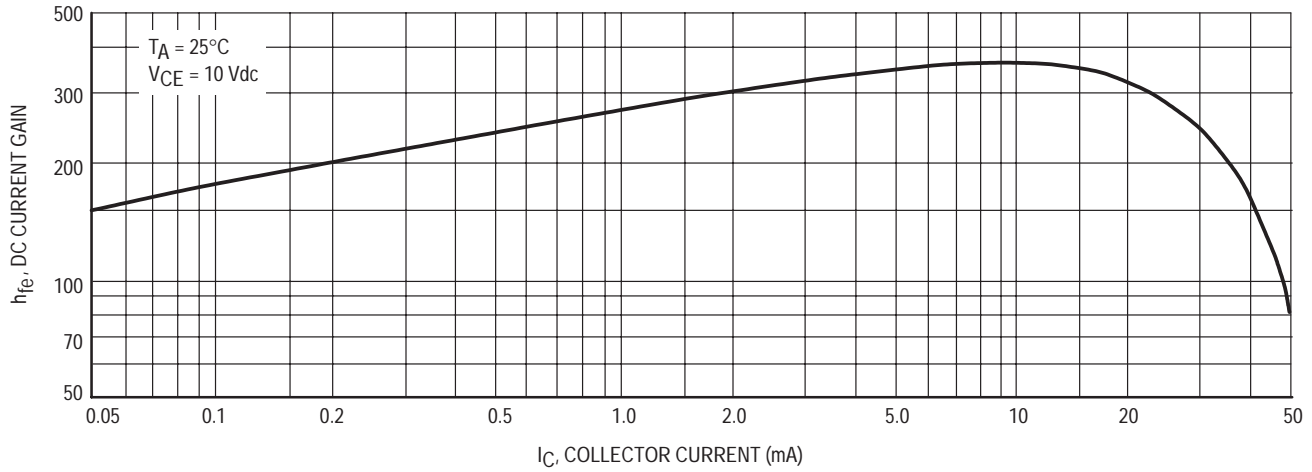


Figure 1. DC Current Gain

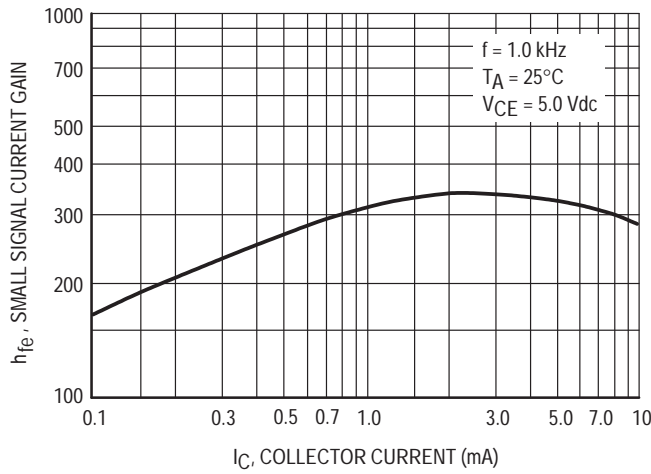


Figure 2. Small Signal Current Gain

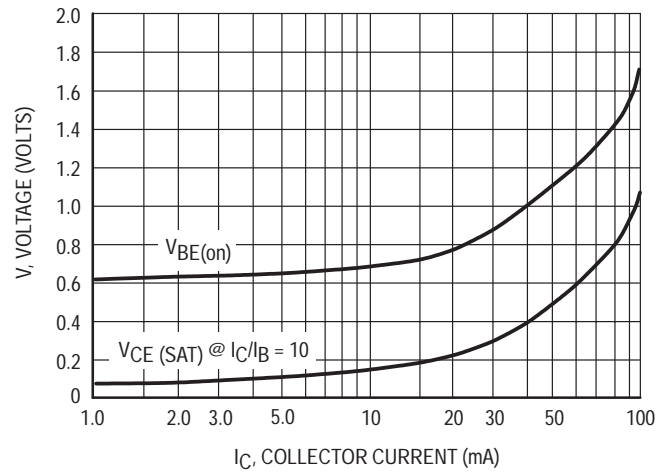


Figure 3. Saturation and On Voltages

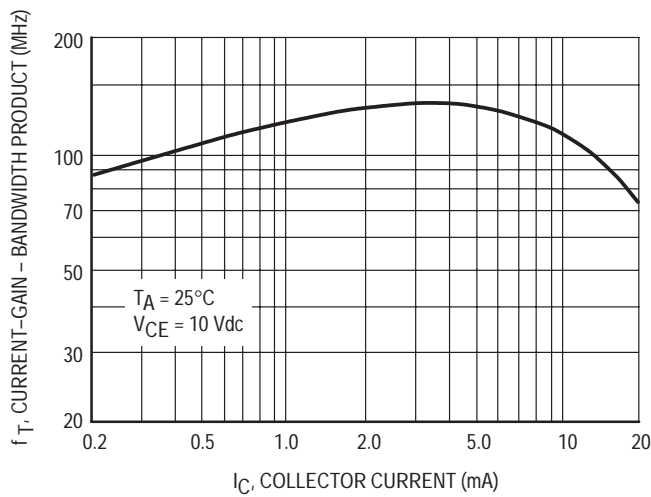


Figure 4. Current-Gain — Bandwidth Product

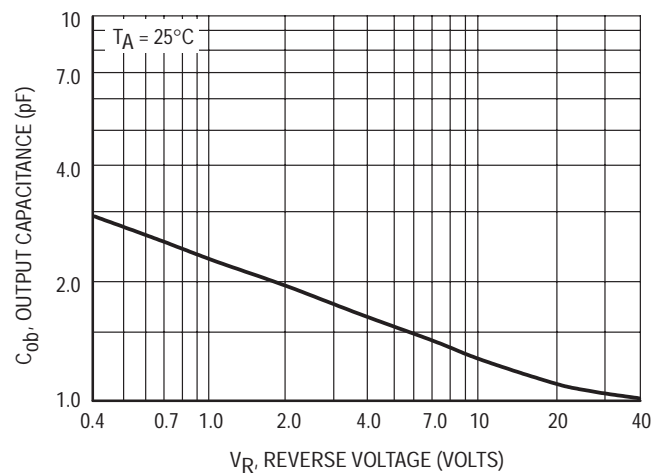


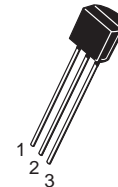
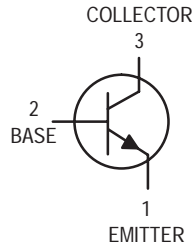
Figure 5. Output Capacitance

Low Noise Transistor

NPN Silicon

MPSA18

Motorola Preferred Device



CASE 29-04, STYLE 1
TO-92 (TO-226AA)

MAXIMUM RATINGS

Rating	Symbol	Value	Unit
Collector–Emitter Voltage	V_{CEO}	45	Vdc
Collector–Base Voltage	V_{CBO}	45	Vdc
Emitter–Base Voltage	V_{EBO}	6.5	Vdc
Collector Current — Continuous	I_C	200	mAdc
Total Device Dissipation @ $T_A = 25^\circ\text{C}$ Derate above 25°C	P_D	625 5.0	mW mW/ $^\circ\text{C}$
Total Device Dissipation @ $T_C = 25^\circ\text{C}$ Derate above 25°C	P_D	1.5 12	Watts mW/ $^\circ\text{C}$
Operating and Storage Junction Temperature Range	T_J, T_{stg}	-55 to +150	$^\circ\text{C}$

THERMAL CHARACTERISTICS

Characteristic	Symbol	Max	Unit
Thermal Resistance, Junction to Ambient	$R_{\theta JA}^{(1)}$	200	$^\circ\text{C/W}$
Thermal Resistance, Junction to Case	$R_{\theta JC}$	83.3	$^\circ\text{C/W}$

ELECTRICAL CHARACTERISTICS ($T_A = 25^\circ\text{C}$ unless otherwise noted)

Characteristic	Symbol	Min	Typ	Max	Unit
----------------	--------	-----	-----	-----	------

OFF CHARACTERISTICS

Collector–Emitter Breakdown Voltage ⁽²⁾ ($I_C = 10 \text{ mAdc}, I_B = 0$)	$V_{(BR)CEO}$	45	—	—	Vdc
Collector–Base Breakdown Voltage ($I_C = 100 \mu\text{Adc}, I_E = 0$)	$V_{(BR)CBO}$	45	—	—	Vdc
Emitter–Base Breakdown Voltage ($I_E = 10 \mu\text{Adc}, I_C = 0$)	$V_{(BR)EBO}$	6.5	—	—	Vdc
Collector Cutoff Current ($V_{CB} = 30 \text{ Vdc}, I_E = 0$)	I_{CBO}	—	1.0	50	nAdc

- $R_{\theta JA}$ is measured with the device soldered into a typical printed circuit board.
- Pulse Test: Pulse Width $\leq 300 \mu\text{s}$, Duty Cycle $\leq 2.0\%$.

Preferred devices are Motorola recommended choices for future use and best overall value.

ELECTRICAL CHARACTERISTICS ($T_A = 25^\circ\text{C}$ unless otherwise noted) (Continued)

Characteristic	Symbol	Min	Typ	Max	Unit
ON CHARACTERISTICS(2)					
DC Current Gain ($I_C = 10 \mu\text{Adc}$, $V_{CE} = 5.0 \text{ Vdc}$) ($I_C = 100 \mu\text{Adc}$, $V_{CE} = 5.0 \text{ Vdc}$) ($I_C = 1.0 \text{ mAdc}$, $V_{CE} = 5.0 \text{ Vdc}$) ($I_C = 10 \text{ mAdc}$, $V_{CE} = 5.0 \text{ Vdc}$)	h_{FE}	400 500 500 500	580 850 1100 1150	— — — 1500	—
Collector–Emitter Saturation Voltage ($I_C = 10 \text{ mAdc}$, $I_B = 0.5 \text{ mAdc}$) ($I_C = 50 \text{ mAdc}$, $I_B = 5.0 \text{ mAdc}$)	$V_{CE(sat)}$	— —	— 0.08	0.2 0.3	Vdc
Base–Emitter On Voltage ($I_C = 1.0 \text{ mAdc}$, $V_{CE} = 5.0 \text{ Vdc}$)	$V_{BE(on)}$	—	0.6	0.7	Vdc

SMALL–SIGNAL CHARACTERISTICS

Current–Gain — Bandwidth Product ($I_C = 1.0 \text{ mAdc}$, $V_{CE} = 5.0 \text{ Vdc}$, $f = 100 \text{ MHz}$)	f_T	100	160	—	MHz
Collector–Base Capacitance ($V_{CB} = 5.0 \text{ Vdc}$, $I_E = 0$, $f = 1.0 \text{ MHz}$)	C_{cb}	—	1.7	3.0	pF
Emitter–Base Capacitance ($V_{EB} = 0.5 \text{ Vdc}$, $I_C = 0$, $f = 1.0 \text{ MHz}$)	C_{eb}	—	5.6	6.5	pF
Noise Figure ($I_C = 100 \mu\text{Adc}$, $V_{CE} = 5.0 \text{ Vdc}$, $R_S = 10 \text{ k}\Omega$, $f = 1.0 \text{ kHz}$) ($I_C = 100 \mu\text{Adc}$, $V_{CE} = 5.0 \text{ Vdc}$, $R_S = 1.0 \text{ k}\Omega$, $f = 100 \text{ Hz}$)	NF	— —	0.5 4.0	1.5 —	dB
Equivalent Short Circuit Noise Voltage ($I_C = 100 \mu\text{Adc}$, $V_{CE} = 5.0 \text{ Vdc}$, $R_S = 1.0 \text{ k}\Omega$, $f = 100 \text{ Hz}$)	V_T	—	6.5	—	$\text{nV}/\sqrt{\text{Hz}}$

2. Pulse Test: Pulse Width $\leq 300 \mu\text{s}$, Duty Cycle $\leq 2.0\%$.

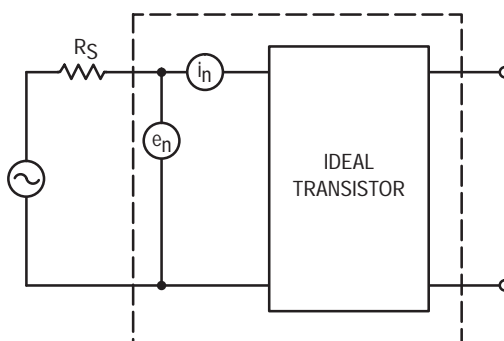


Figure 1. Transistor Noise Model

NOISE CHARACTERISTICS

($V_{CE} = 5.0 \text{ Vdc}$, $T_A = 25^\circ\text{C}$)

NOISE VOLTAGE

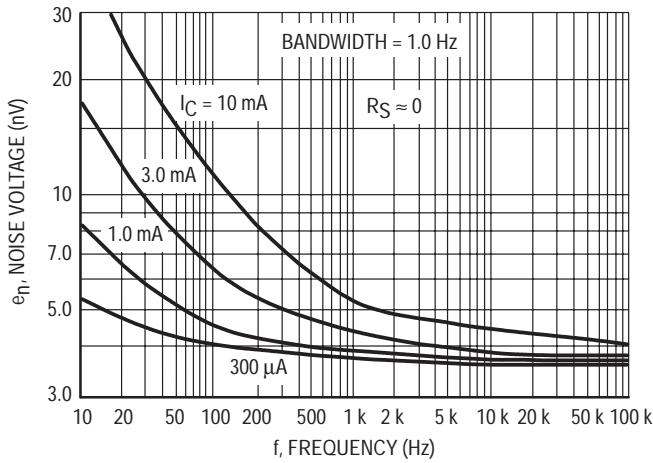


Figure 2. Effects of Frequency

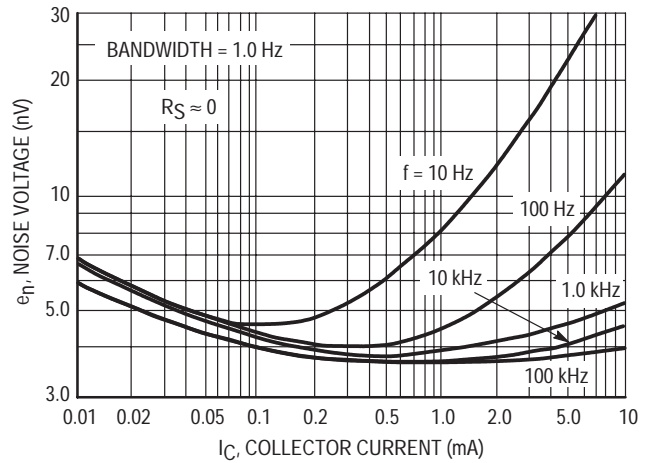


Figure 3. Effects of Collector Current

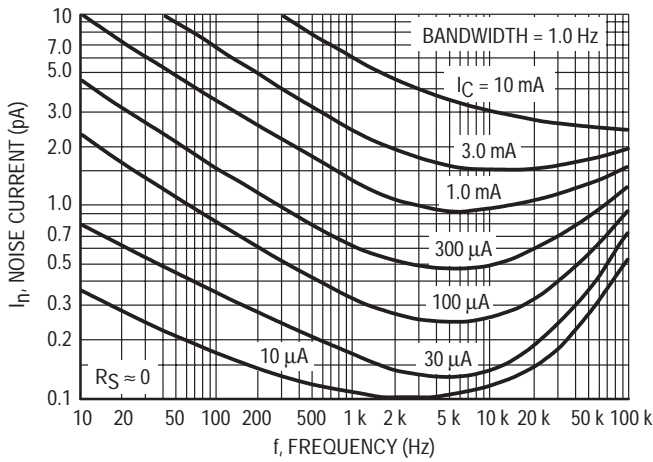


Figure 4. Noise Current

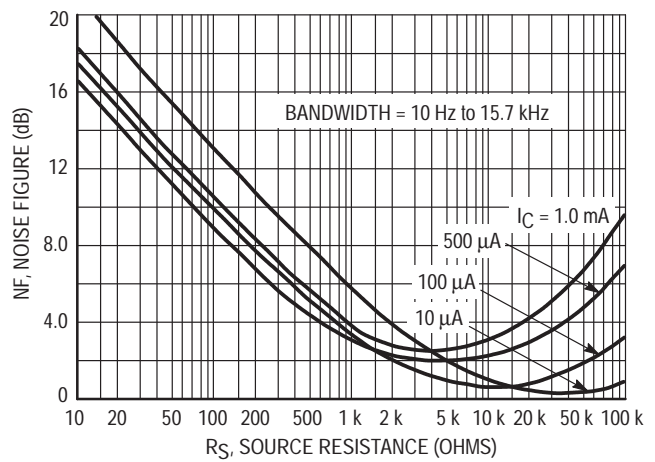


Figure 5. Wideband Noise Figure

100 Hz NOISE DATA

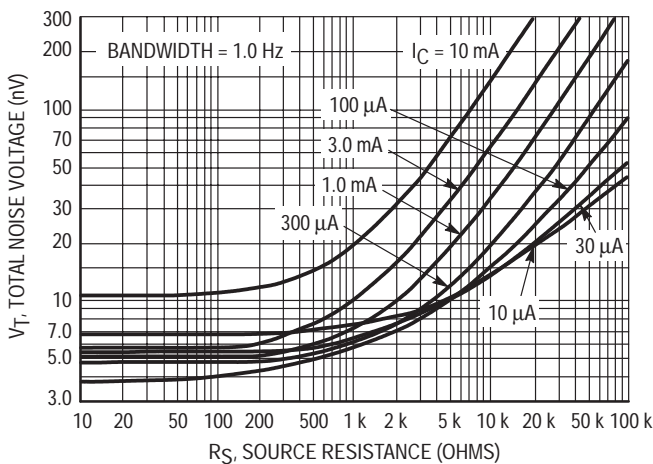


Figure 6. Total Noise Voltage

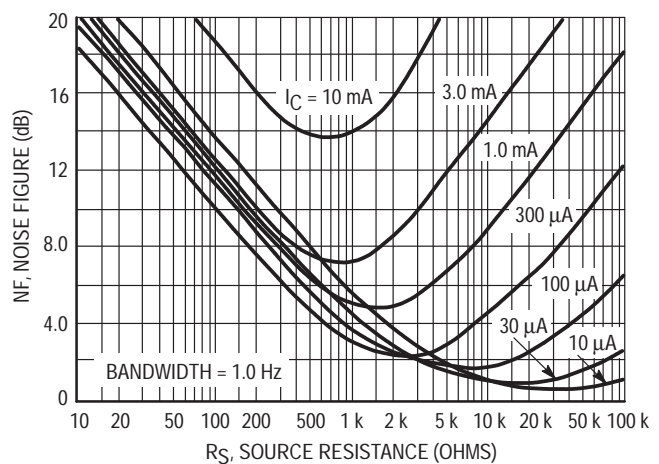


Figure 7. Noise Figure

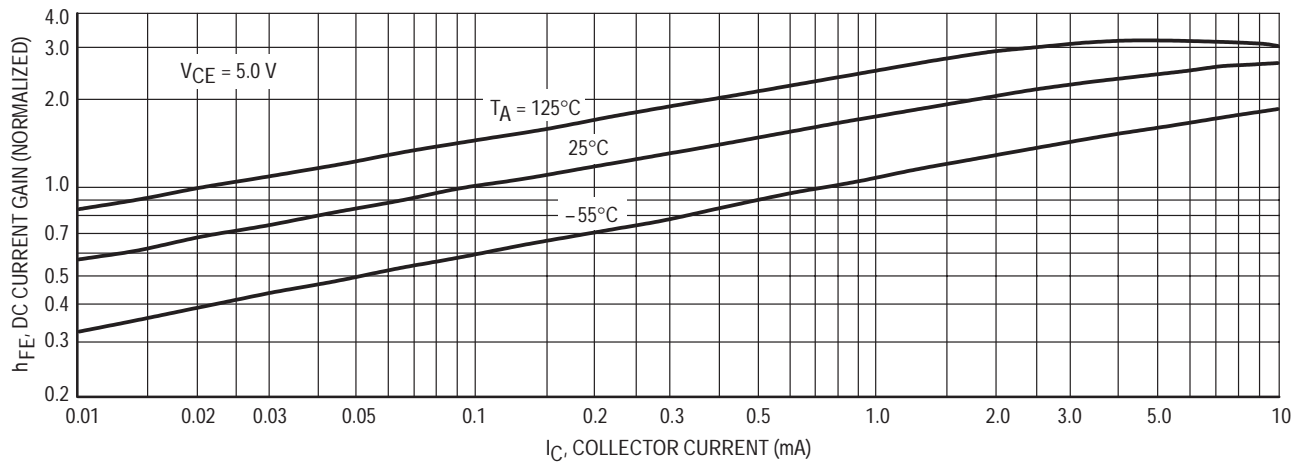


Figure 8. DC Current Gain

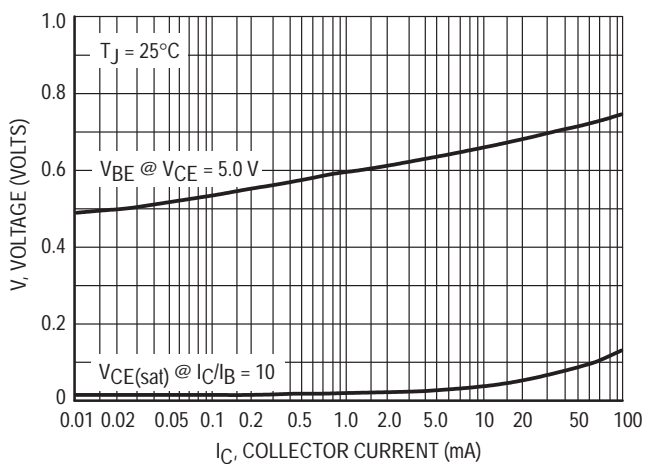


Figure 9. "On" Voltages

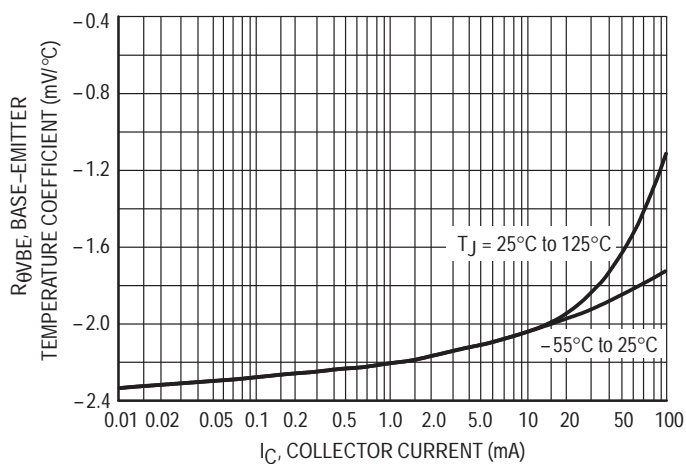


Figure 10. Temperature Coefficients

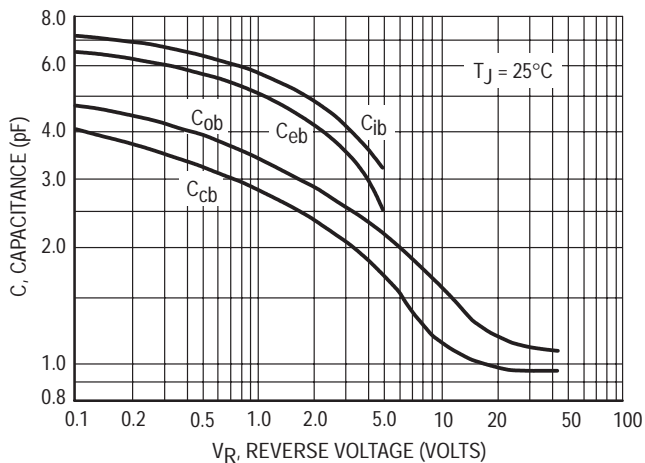


Figure 11. Capacitance

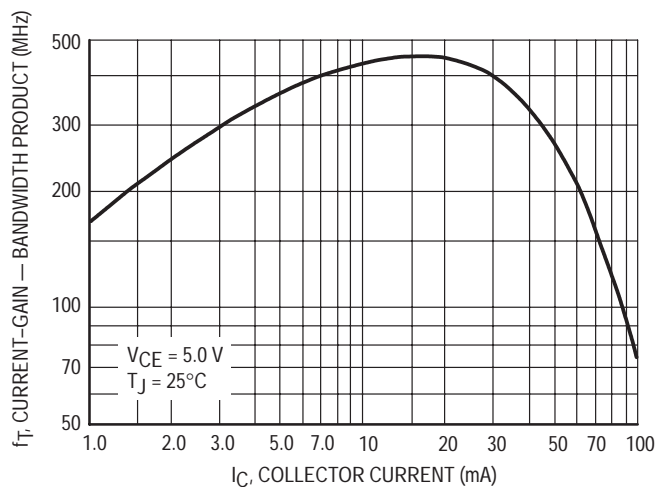
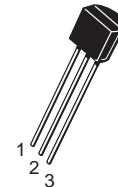
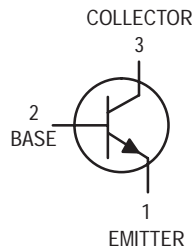


Figure 12. Current-Gain — Bandwidth Product

Amplifier Transistor

NPN Silicon

MPSA20



CASE 29-04, STYLE 1
TO-92 (TO-226AA)

MAXIMUM RATINGS

Rating	Symbol	Value	Unit
Collector–Emitter Voltage	V_{CEO}	40	Vdc
Collector–Base Voltage	V_{CBO}	4.0	Vdc
Collector Current — Continuous	I_C	100	mAdc
Total Device Dissipation @ $T_A = 25^\circ\text{C}$ Derate above 25°C	P_D	625 5.0	mW mW/ $^\circ\text{C}$
Total Device Dissipation @ $T_C = 25^\circ\text{C}$ Derate above 25°C	P_D	1.5 12	Watts mW/ $^\circ\text{C}$
Operating and Storage Junction Temperature Range	T_J, T_{stg}	-55 to +150	$^\circ\text{C}$

THERMAL CHARACTERISTICS

Characteristic	Symbol	Max	Unit
Thermal Resistance, Junction to Ambient	$R_{\theta JA}^{(1)}$	200	$^\circ\text{C}/\text{W}$
Thermal Resistance, Junction to Case	$R_{\theta JC}$	83.3	$^\circ\text{C}/\text{W}$

ELECTRICAL CHARACTERISTICS ($T_A = 25^\circ\text{C}$ unless otherwise noted)

Characteristic	Symbol	Min	Max	Unit
----------------	--------	-----	-----	------

OFF CHARACTERISTICS

Collector–Emitter Breakdown Voltage ⁽²⁾ ($I_C = 1.0 \text{ mAdc}, I_B = 0$)	$V_{(BR)CEO}$	40	—	Vdc
Emitter–Base Breakdown Voltage ($I_E = 100 \mu\text{Adc}, I_C = 0$)	$V_{(BR)EBO}$	4.0	—	Vdc
Collector Cutoff Current ($V_{CB} = 30 \text{ Vdc}, I_E = 0$)	I_{CBO}	—	100	nAdc

- $R_{\theta JA}$ is measured with the device soldered into a typical printed circuit board.
- Pulse Test: Pulse Width $\leq 300 \mu\text{s}$, Duty Cycle $\leq 2.0\%$.

ELECTRICAL CHARACTERISTICS ($T_A = 25^\circ\text{C}$ unless otherwise noted) (Continued)

Characteristic	Symbol	Min	Max	Unit
ON CHARACTERISTICS				
DC Current Gain ⁽²⁾ ($I_C = 5.0 \text{ mAdc}$, $V_{CE} = 10 \text{ Vdc}$)	h_{FE}	40	400	—
Collector–Emitter Saturation Voltage ($I_C = 10 \text{ mAdc}$, $I_B = 1.0 \text{ mAdc}$)	$V_{CE(sat)}$	—	0.25	Vdc

SMALL–SIGNAL CHARACTERISTICS

Current–Gain — Bandwidth Product ⁽²⁾ ($I_C = 5.0 \text{ mAdc}$, $V_{CE} = 10 \text{ Vdc}$, $f = 100 \text{ MHz}$)	f_T	125	—	MHz
Output Capacitance ($V_{CB} = 10 \text{ Vdc}$, $I_E = 0$, $f = 1.0 \text{ MHz}$)	C_{obo}	—	4.0	pF

2. Pulse Test: Pulse Width $\leq 300 \mu\text{s}$, Duty Cycle $\leq 2.0\%$.

EQUIVALENT SWITCHING TIME TEST CIRCUITS

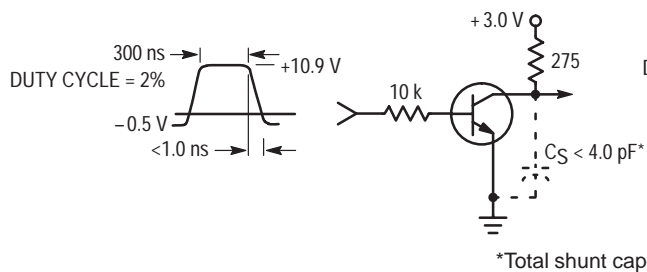


Figure 1. Turn–On Time

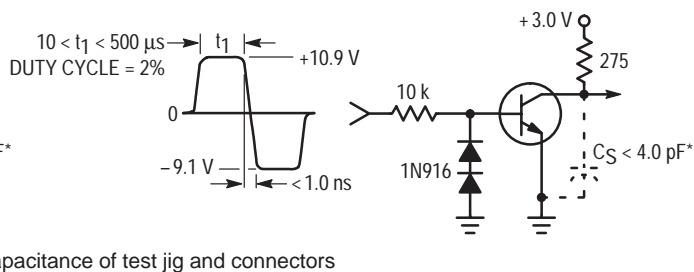


Figure 2. Turn–Off Time

TYPICAL NOISE CHARACTERISTICS

($V_{CE} = 5.0 \text{ Vdc}$, $T_A = 25^\circ\text{C}$)

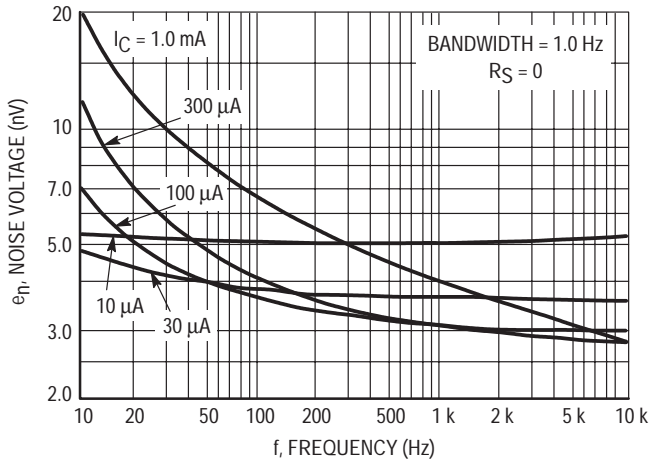


Figure 3. Noise Voltage

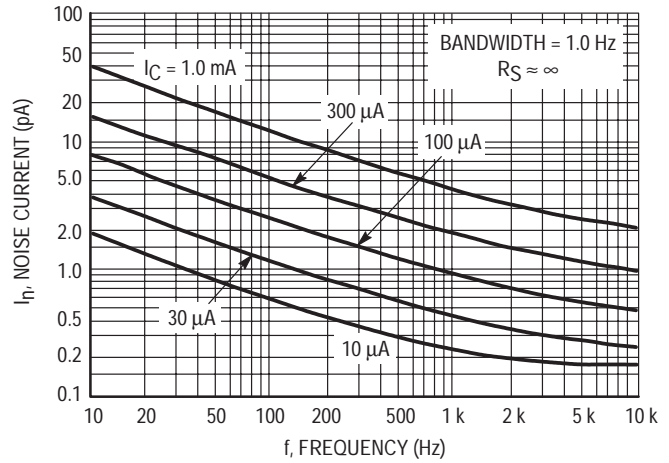


Figure 4. Noise Current

NOISE FIGURE CONTOURS

($V_{CE} = 5.0 \text{ Vdc}$, $T_A = 25^\circ\text{C}$)

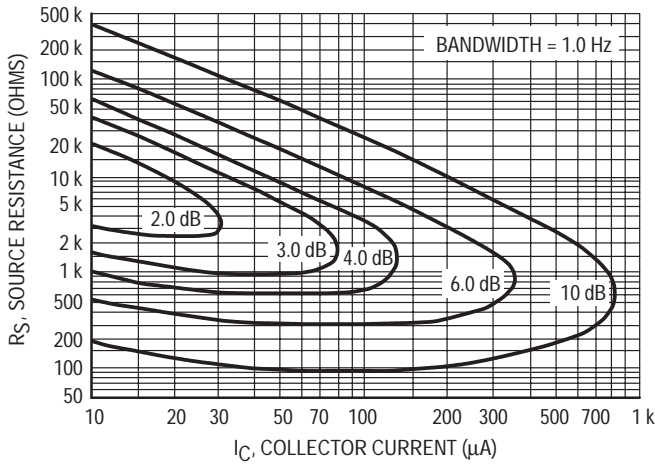


Figure 5. Narrow Band, 100 Hz

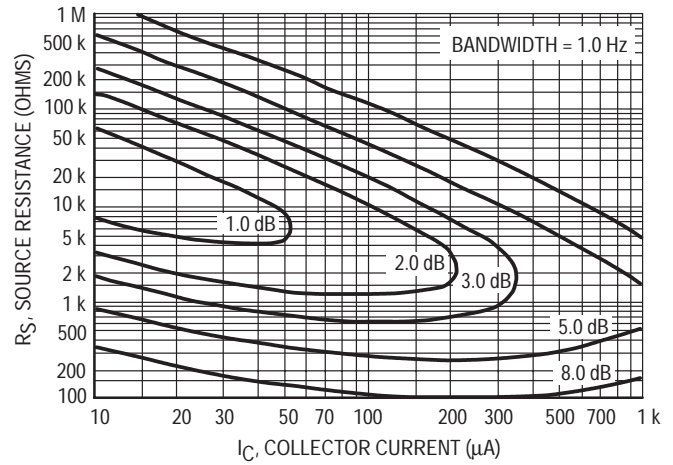


Figure 6. Narrow Band, 1.0 kHz

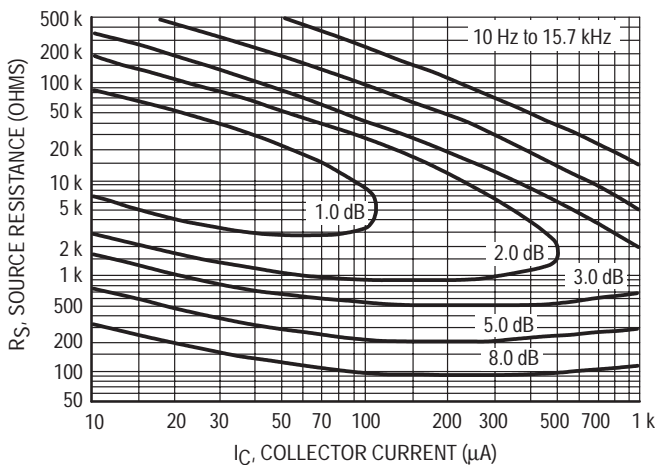


Figure 7. Wideband

Noise Figure is defined as:

$$NF = 20 \log_{10} \left(\frac{e_n^2 + 4KTR_S + I_n^2 R_S^2}{4KTR_S} \right)^{1/2}$$

e_n = Noise Voltage of the Transistor referred to the input. (Figure 3)

I_n = Noise Current of the Transistor referred to the input. (Figure 4)

K = Boltzman's Constant ($1.38 \times 10^{-23} \text{ J/}^\circ\text{K}$)

T = Temperature of the Source Resistance ($^\circ\text{K}$)

R_S = Source Resistance (Ohms)

TYPICAL STATIC CHARACTERISTICS

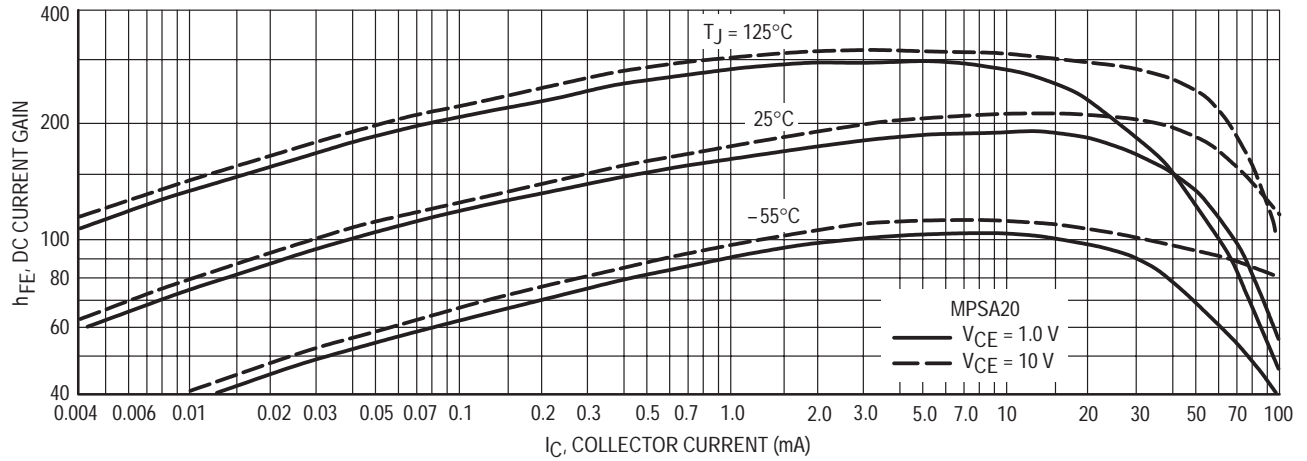


Figure 8. DC Current Gain

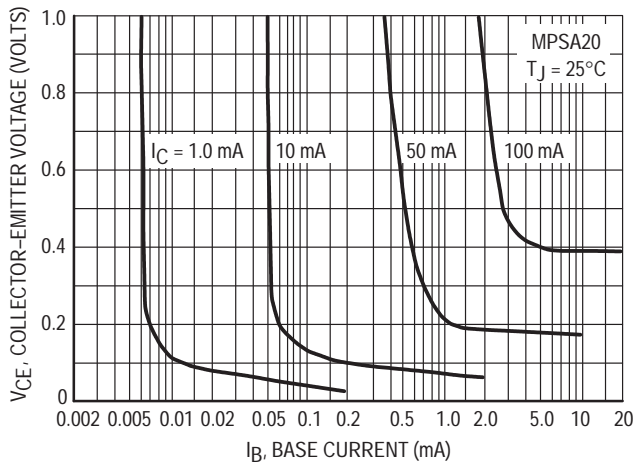


Figure 9. Collector Saturation Region

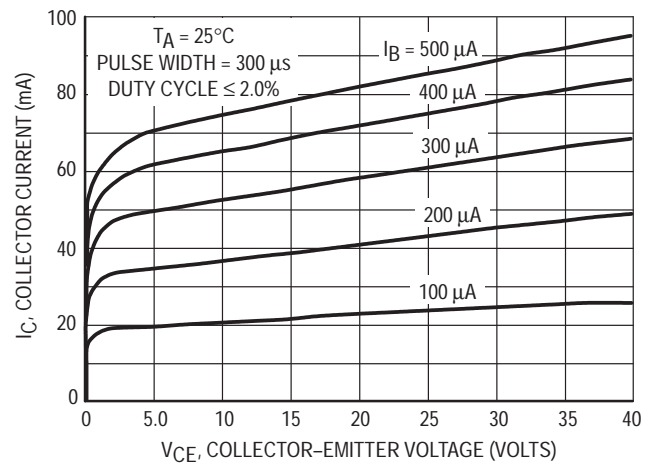


Figure 10. Collector Characteristics

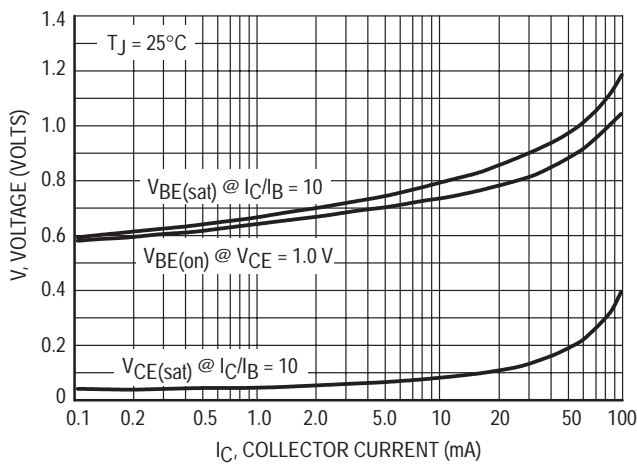


Figure 11. "On" Voltages

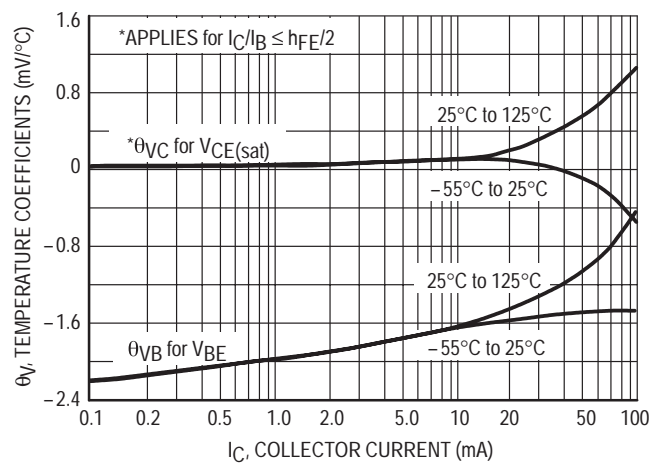


Figure 12. Temperature Coefficients

TYPICAL DYNAMIC CHARACTERISTICS

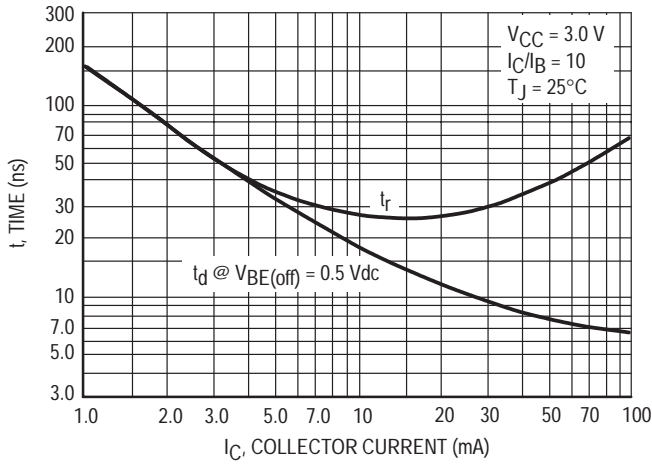


Figure 13. Turn-On Time

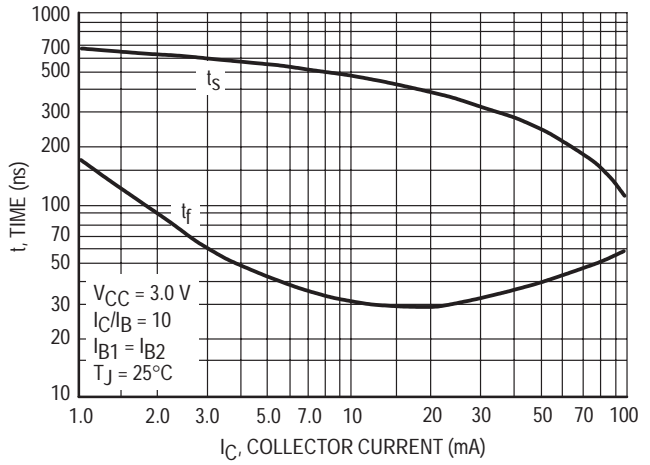


Figure 14. Turn-Off Time

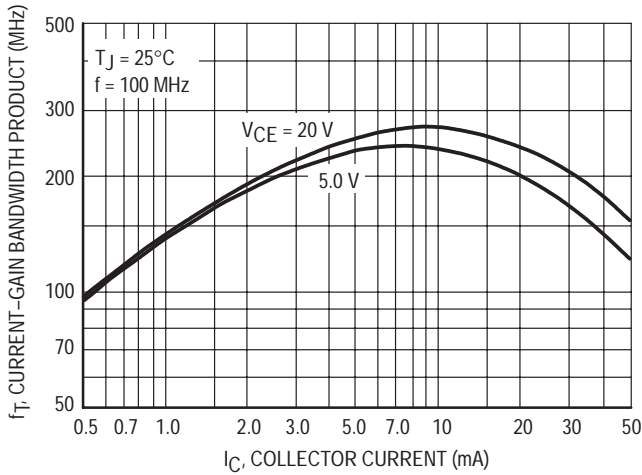


Figure 15. Current-Gain — Bandwidth Product

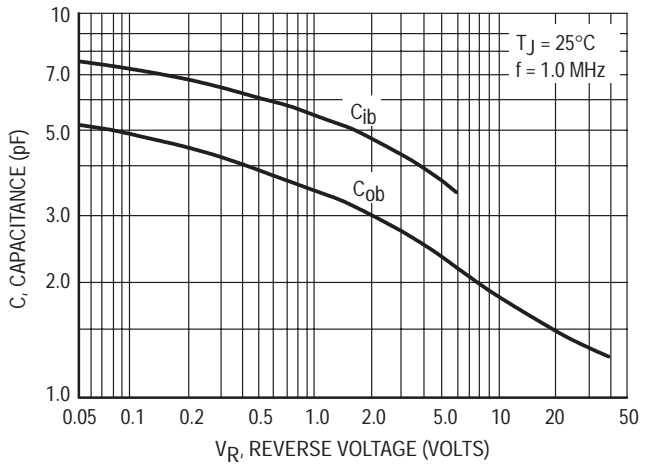


Figure 16. Capacitance

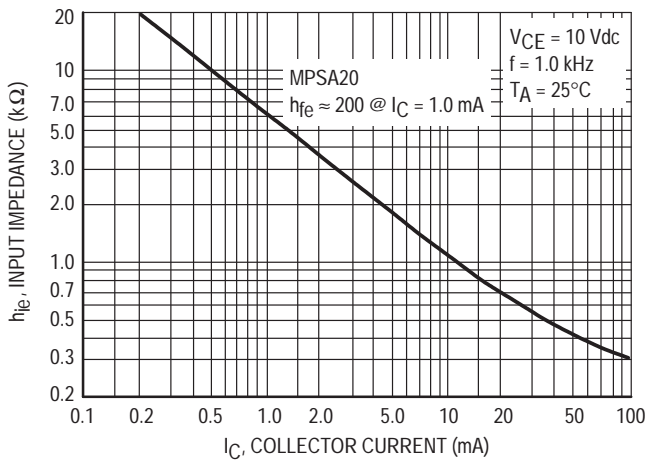


Figure 17. Input Impedance

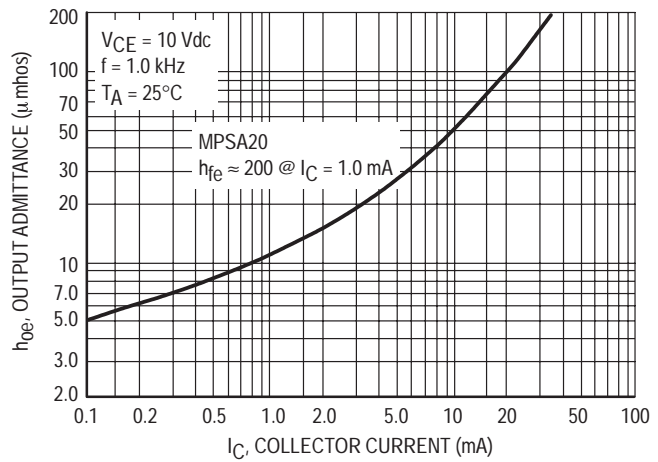


Figure 18. Output Admittance

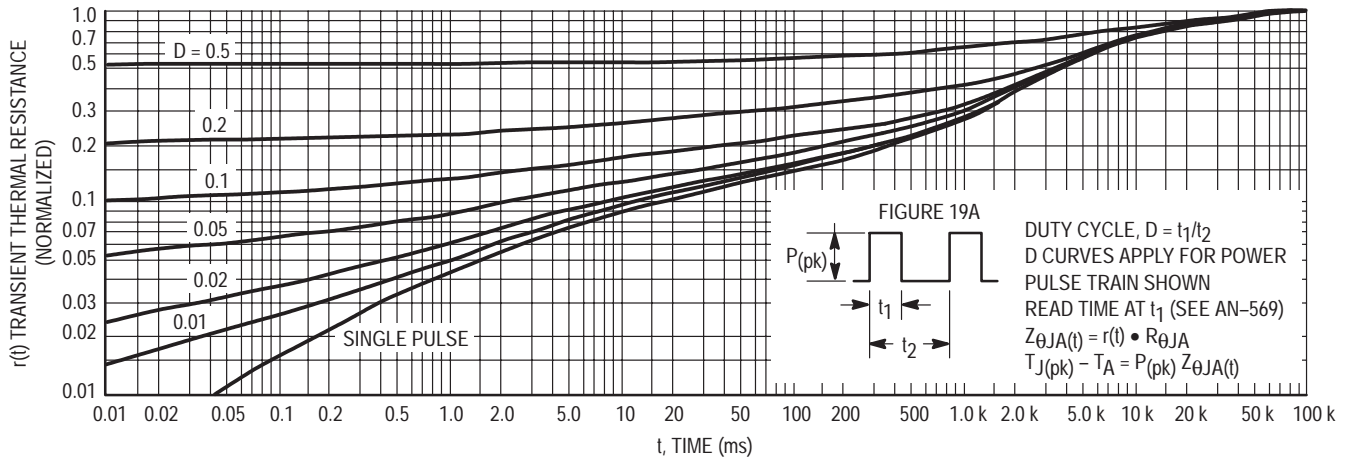


Figure 19. Thermal Response

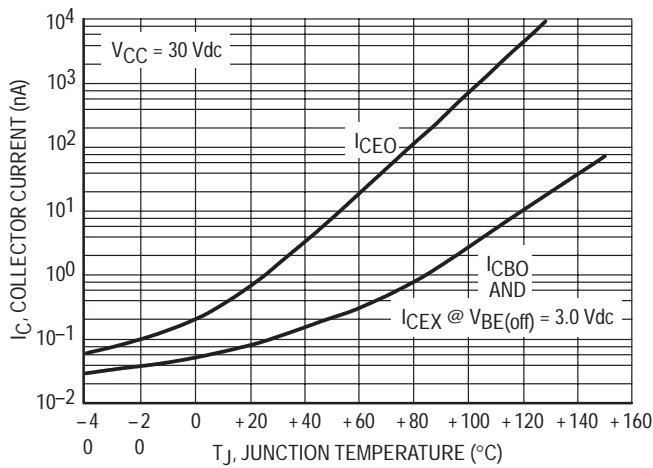


Figure 19A.

DESIGN NOTE: USE OF THERMAL RESPONSE DATA

A train of periodical power pulses can be represented by the model as shown in Figure 19A. Using the model and the device thermal response the normalized effective transient thermal resistance of Figure 19 was calculated for various duty cycles.

To find $Z_{\theta JA}(t)$, multiply the value obtained from Figure 19 by the steady state value $R_{\theta JA}$.

Example:

Dissipating 2.0 watts peak under the following conditions:

$t_1 = 1.0$ ms, $t_2 = 5.0$ ms. ($D = 0.2$)

Using Figure 19 at a pulse width of 1.0 ms and $D = 0.2$, the reading of $r(t)$ is 0.22.

The peak rise in junction temperature is therefore

$$\Delta T = r(t) \times P(pk) \times R_{\theta JA} = 0.22 \times 2.0 \times 200 = 88^\circ C.$$

For more information, see AN-569.

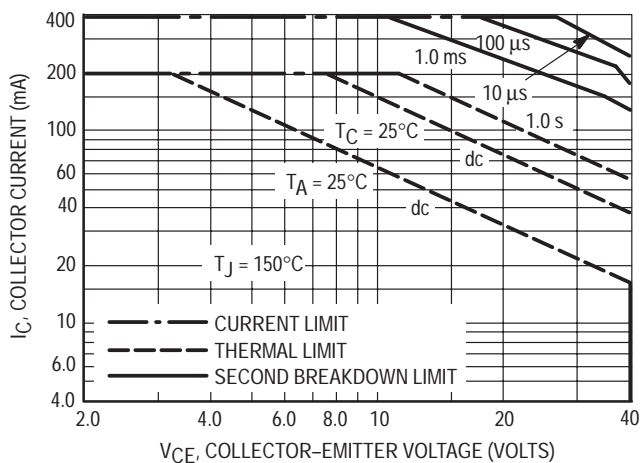


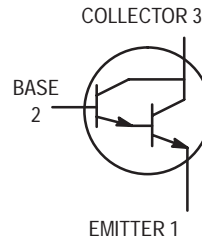
Figure 20.

The safe operating area curves indicate I_C - V_{CE} limits of the transistor that must be observed for reliable operation. Collector load lines for specific circuits must fall below the limits indicated by the applicable curve.

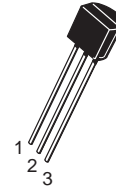
The data of Figure 20 is based upon $T_{J(pk)} = 150^\circ C$; T_C or T_A is variable depending upon conditions. Pulse curves are valid for duty cycles to 10% provided $T_{J(pk)} \leq 150^\circ C$. $T_{J(pk)}$ may be calculated from the data in Figure 19. At high case or ambient temperatures, thermal limitations will reduce the power that can be handled to values less than the limitations imposed by second breakdown.

Darlington Transistor

NPN Silicon



MPSA27



CASE 29-04, STYLE 1
TO-92 (TO-226AA)

MAXIMUM RATINGS

Rating	Symbol	MPSA27	Unit
Collector–Emitter Voltage	V_{CES}	60	Vdc
Emitter–Base Voltage	V_{EBO}	10	Vdc
Collector Current — Continuous	I_C	500	mAdc
Total Device Dissipation @ $T_A = 25^\circ\text{C}$ Derate above 25°C	P_D	625 5.0	mW mW/ $^\circ\text{C}$
Operating and Storage Junction Temperature Range	T_J, T_{stg}	–55 to +150	$^\circ\text{C}$

THERMAL CHARACTERISTICS

Characteristic	Symbol	Max	Unit
Thermal Resistance, Junction to Ambient	$R_{\theta JA}$	200	$^\circ\text{C}/\text{W}$

ELECTRICAL CHARACTERISTICS ($T_A = 25^\circ\text{C}$ unless otherwise noted)

Characteristic	Symbol	Min	Typ	Max	Unit
----------------	--------	-----	-----	-----	------

OFF CHARACTERISTICS

Collector–Emitter Breakdown Voltage ($I_C = 100 \mu\text{Adc}$, $V_{BE} = 0$)	$V_{(BR)CES}$	60	—	—	Vdc
Collector–Base Breakdown Voltage ($I_C = 100 \mu\text{Adc}$, $I_E = 0$)	$V_{(BR)CBO}$	60	—	—	Vdc
Collector Cutoff Current ($V_{CB} = 30 \text{ V}$, $I_E = 0$) ($V_{CB} = 40 \text{ V}$, $I_E = 0$) ($V_{CB} = 50 \text{ V}$, $I_E = 0$)	I_{CBO}	—	—	100	nAdc
Collector Cutoff Current ($V_{CE} = 30 \text{ V}$, $V_{BE} = 0$) ($V_{CE} = 40 \text{ V}$, $V_{BE} = 0$) ($V_{CE} = 50 \text{ V}$, $V_{BE} = 0$)	I_{CES}	—	—	500	nAdc
Emitter Cutoff Current ($V_{EB} = 10 \text{ Vdc}$)	I_{EBO}	—	—	100	nAdc

ELECTRICAL CHARACTERISTICS ($T_A = 25^\circ\text{C}$ unless otherwise noted) (Continued)

Characteristic	Symbol	Min	Typ	Max	Unit
ON CHARACTERISTICS(1)					
DC Current Gain ($I_C = 10\text{ mA}$, $V_{CE} = 5.0\text{ V}$) ($I_C = 100\text{ mA}$, $V_{CE} = 5.0\text{ V}$)	h_{FE}	10,000 10,000	— —	— —	—
Collector–Emitter Saturation Voltage ($I_C = 100\text{ mA}$, $I_B = 0.1\text{ mA}_{dc}$)	$V_{CE(sat)}$	—	—	1.5	Vdc
Base–Emitter On Voltage ($I_C = 100\text{ mA}$, $V_{CE} = 5.0\text{ V}_{dc}$)	$V_{BE(on)}$	—	—	2.0	Vdc
SMALL–SIGNAL CHARACTERISTICS					
Small Signal Current Gain ($I_C = 10\text{ mA}$, $V_{CE} = 5.0\text{ V}$, $f = 100\text{ MHz}$)	h_{fe}	1.25	2.4	—	—

1. Pulse Test: Pulse Width $\leq 300\ \mu\text{s}$, Duty Cycle $\leq 2.0\%$.

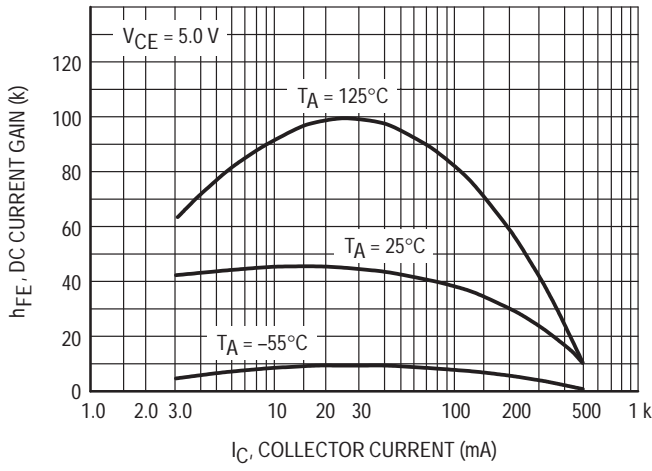


Figure 1. DC Current Gain

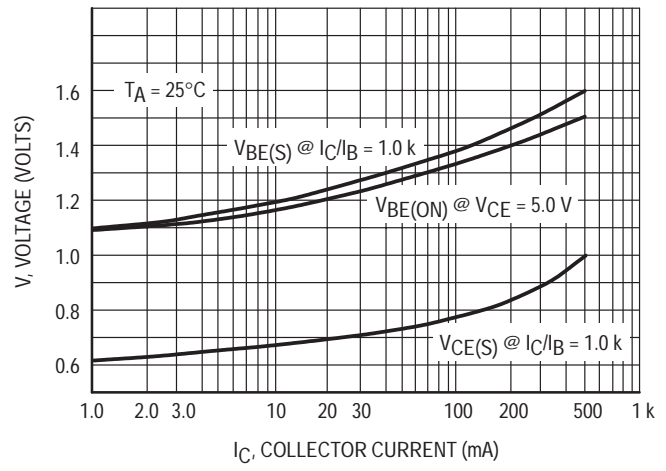


Figure 2. "ON" Voltages

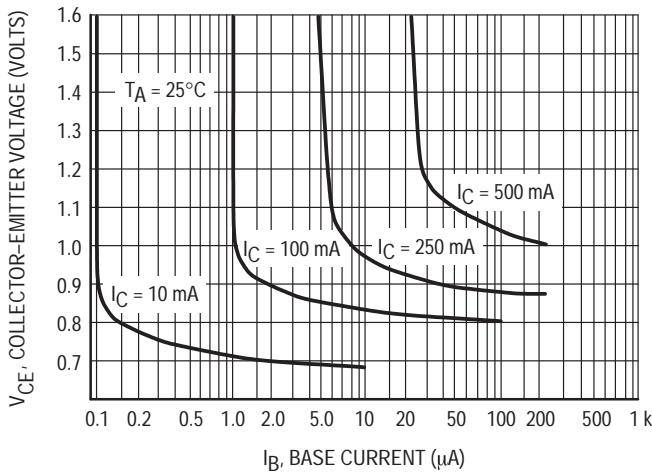


Figure 3. Collector Saturation Region

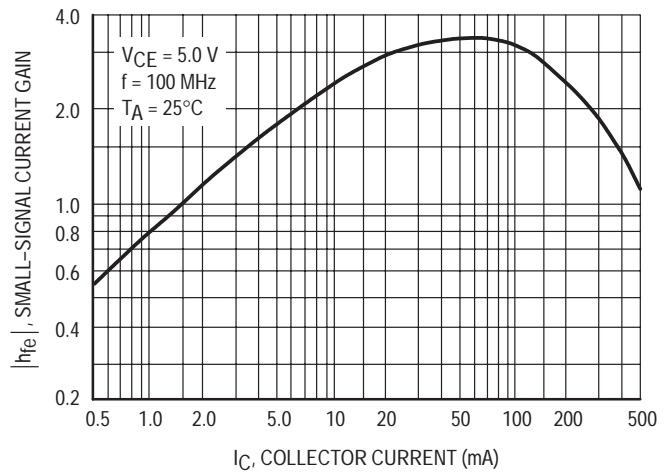


Figure 4. High Frequency Current Gain

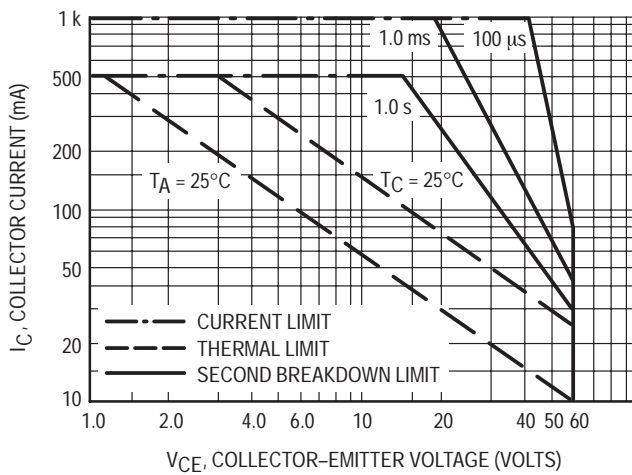
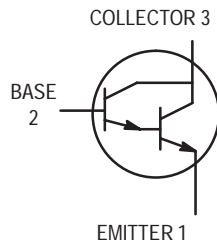


Figure 5. Active Region — Safe Operating Area

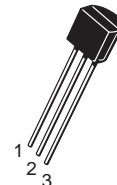
Darlington Transistors

NPN Silicon



MPSA28 MPSA29*

*Motorola Preferred Device



CASE 29-04, STYLE 1
TO-92 (TO-226AA)

MAXIMUM RATINGS

Rating	Symbol	MPSA28	MPSA29	Unit
Collector–Emitter Voltage	V_{CES}	80	100	Vdc
Collector–Base Voltage	V_{CBO}	80	100	Vdc
Emitter–Base Voltage	V_{EBO}	12		Vdc
Collector Current — Continuous	I_C	500		mAdc
Total Device Dissipation @ $T_A = 25^\circ\text{C}$ Derate above 25°C	P_D	625		mW
		5.0		mW/ $^\circ\text{C}$
Total Device Dissipation @ $T_C = 25^\circ\text{C}$ Derate above 25°C	P_D	1.5		Watts
		12		mW/ $^\circ\text{C}$
Operating and Storage Junction Temperature Range	T_J, T_{stg}	–55 to +150		$^\circ\text{C}$

THERMAL CHARACTERISTICS

Characteristic	Symbol	Max	Unit
Thermal Resistance, Junction to Ambient	$R_{\theta JA}$	200	$^\circ\text{C}/\text{W}$
Thermal Resistance, Junction to Case	$R_{\theta JC}$	83.3	$^\circ\text{C}/\text{W}$

ELECTRICAL CHARACTERISTICS ($T_A = 25^\circ\text{C}$ unless otherwise noted)

Characteristic	Symbol	Min	Typ	Max	Unit
----------------	--------	-----	-----	-----	------

OFF CHARACTERISTICS

Collector–Emitter Breakdown Voltage ($I_C = 100 \mu\text{Adc}, V_{BE} = 0$)	MPSA28 MPSA29	$V_{(BR)CES}$	80 100	— —	— —	Vdc
Collector–Base Breakdown Voltage ($I_C = 100 \mu\text{Adc}, I_E = 0$)	MPSA28 MPSA29	$V_{(BR)CBO}$	80 100	— —	— —	Vdc
Emitter–Base Breakdown Voltage ($I_E = 10 \mu\text{Adc}, I_C = 0$)		$V_{(BR)EBO}$	12	—	—	Vdc
Collector Cutoff Current ($V_{CB} = 60 \text{Vdc}, I_E = 0$) ($V_{CB} = 80 \text{Vdc}, I_E = 0$)	MPSA28 MPSA29	I_{CBO}	— —	— —	100 100	nAdc
Collector Cutoff Current ($V_{CE} = 60 \text{Vdc}, V_{BE} = 0$) ($V_{CE} = 80 \text{Vdc}, V_{BE} = 0$)	MPSA28 MPSA29	I_{CES}	— —	— —	500 500	nAdc
Emitter Cutoff Current ($V_{EB} = 10 \text{Vdc}, I_C = 0$)		I_{EBO}	—	—	100	nAdc

Preferred devices are Motorola recommended choices for future use and best overall value.

MPSA28 MPSA29**ELECTRICAL CHARACTERISTICS** ($T_A = 25^\circ\text{C}$ unless otherwise noted) (Continued)

Characteristic	Symbol	Min	Typ	Max	Unit
ON CHARACTERISTICS(1)					
DC Current Gain ($I_C = 10\text{ mAdc}$, $V_{CE} = 5.0\text{ Vdc}$) ($I_C = 100\text{ mAdc}$, $V_{CE} = 5.0\text{ Vdc}$)	h_{FE}	10,000 10,000	— —	— —	—
Collector–Emitter Saturation Voltage ($I_C = 10\text{ mAdc}$, $I_B = 0.01\text{ mAdc}$) ($I_C = 100\text{ mAdc}$, $I_B = 0.1\text{ mAdc}$)	$V_{CE(sat)}$	— —	0.7 0.8	1.2 1.5	Vdc
Base–Emitter On Voltage ($I_C = 100\text{ mAdc}$, $V_{CE} = 5.0\text{ Vdc}$)	$V_{BE(on)}$	—	1.4	2.0	Vdc

SMALL–SIGNAL CHARACTERISTICS

Current–Gain – Bandwidth Product ⁽²⁾ ($I_C = 10\text{ mAdc}$, $V_{CE} = 5.0\text{ Vdc}$, $f = 100\text{ MHz}$)	f_T	125	200	—	MHz
Output Capacitance ($V_{CB} = 10\text{ Vdc}$, $I_E = 0$, $f = 1.0\text{ MHz}$)	C_{obo}	—	5.0	8.0	pF

1. Pulse Test: Pulse Width $\leq 300\ \mu\text{s}$, Duty Cycle $\leq 2.0\%$.
2. $f_T = h_{fe} \cdot f_{test}$.

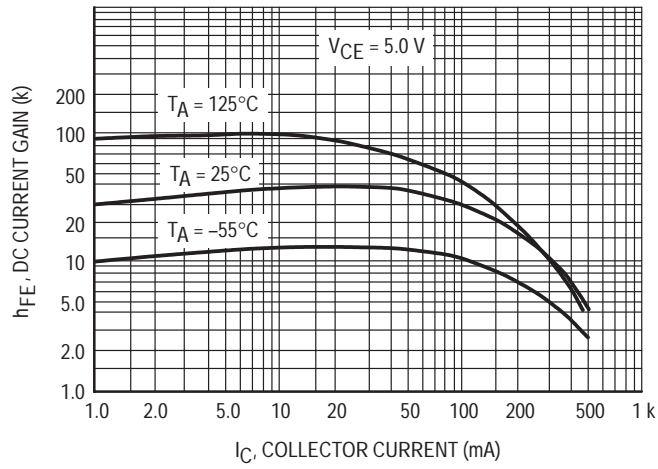


Figure 1. DC Current Gain

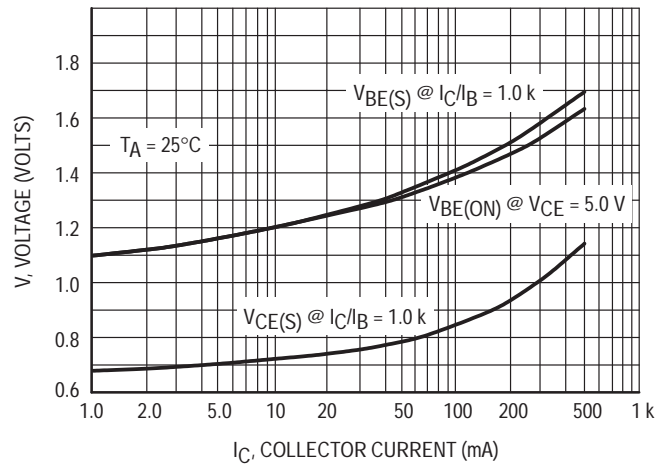


Figure 2. "ON" Voltages

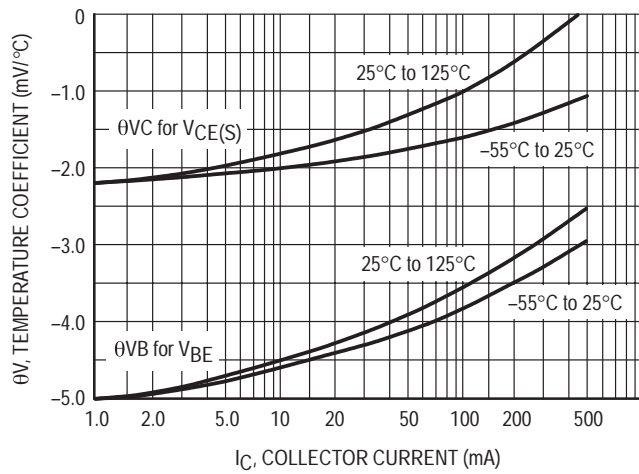


Figure 3. Temperature Coefficients

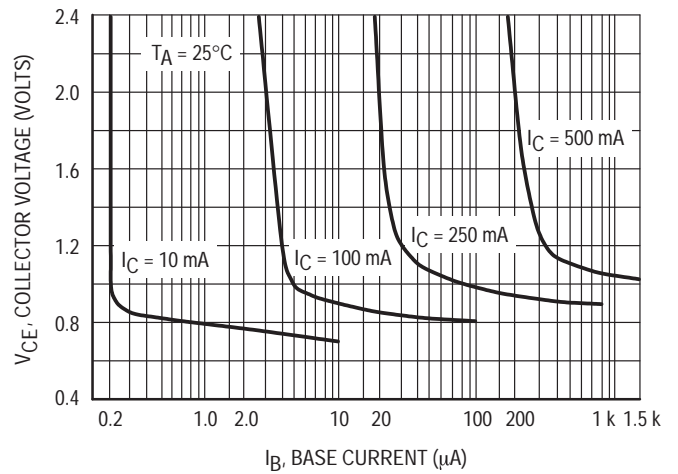


Figure 4. Collector Saturation Region

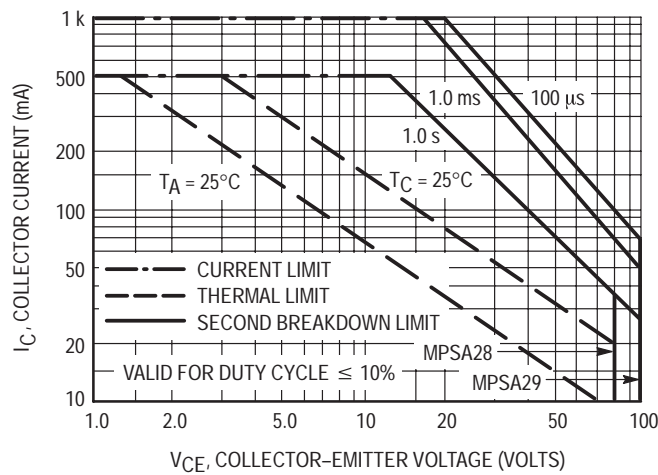


Figure 5. Active Region — Safe Operating Area

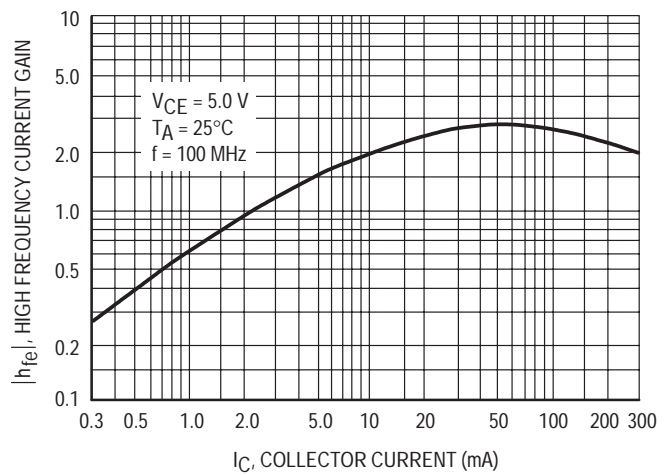
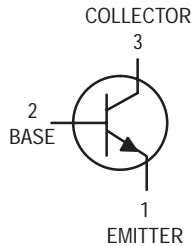


Figure 6. High Frequency Current Gain

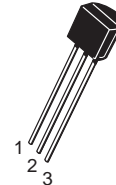
High Voltage Transistors

NPN Silicon



MPSA42*
MPSA43

*Motorola Preferred Device



CASE 29-04, STYLE 1
TO-92 (TO-226AA)

MAXIMUM RATINGS

Rating	Symbol	MPSA42	MPSA43	Unit
Collector–Emitter Voltage	V_{CEO}	300	200	Vdc
Collector–Base Voltage	V_{CBO}	300	200	Vdc
Emitter–Base Voltage	V_{EBO}	6.0	6.0	Vdc
Collector Current — Continuous	I_C	500		mAdc
Total Device Dissipation @ $T_A = 25^\circ\text{C}$ Derate above 25°C	P_D	625	5.0	mW mW/ $^\circ\text{C}$
Total Device Dissipation @ $T_C = 25^\circ\text{C}$ Derate above 25°C	P_D	1.5	12	Watts mW/ $^\circ\text{C}$
Operating and Storage Junction Temperature Range	T_J, T_{stg}	–55 to +150		$^\circ\text{C}$

THERMAL CHARACTERISTICS

Characteristic	Symbol	Max	Unit
Thermal Resistance, Junction to Ambient	$R_{\theta JA}$	200	$^\circ\text{C}/\text{mW}$
Thermal Resistance, Junction to Case	$R_{\theta JC}$	83.3	$^\circ\text{C}/\text{mW}$

ELECTRICAL CHARACTERISTICS ($T_A = 25^\circ\text{C}$ unless otherwise noted)

Characteristic	Symbol	Min	Max	Unit
----------------	--------	-----	-----	------

OFF CHARACTERISTICS

Collector–Emitter Breakdown Voltage ⁽¹⁾ ($I_C = 1.0 \text{ mAdc}, I_E = 0$)	MPSA42 MPSA43	$V_{(BR)CEO}$	300 200	— —	Vdc
Collector–Base Breakdown Voltage ($I_C = 100 \mu\text{Adc}, I_E = 0$)	MPSA42 MPSA43	$V_{(BR)CBO}$	300 200	— —	Vdc
Emitter–Base Breakdown Voltage ($I_E = 100 \mu\text{Adc}, I_C = 0$)		$V_{(BR)EBO}$	6.0	—	Vdc
Collector Cutoff Current ($V_{CB} = 200 \text{ Vdc}, I_E = 0$) ($V_{CB} = 160 \text{ Vdc}, I_E = 0$)	MPSA42 MPSA43	I_{CBO}	— —	0.1 0.1	μAdc
Emitter Cutoff Current ($V_{EB} = 6.0 \text{ Vdc}, I_C = 0$) ($V_{EB} = 4.0 \text{ Vdc}, I_C = 0$)	MPSA42 MPSA43	I_{EBO}	— —	0.1 0.1	μAdc

1. Pulse Test: Pulse Width $\leq 300 \mu\text{s}$, Duty Cycle $\leq 2.0\%$.

Preferred devices are Motorola recommended choices for future use and best overall value.

ELECTRICAL CHARACTERISTICS ($T_A = 25^\circ\text{C}$ unless otherwise noted) (Continued)

Characteristic	Symbol	Min	Max	Unit
ON CHARACTERISTICS(1)				
DC Current Gain ($I_C = 1.0\text{ mAdc}$, $V_{CE} = 10\text{ Vdc}$) ($I_C = 10\text{ mAdc}$, $V_{CE} = 10\text{ Vdc}$) ($I_C = 30\text{ mAdc}$, $V_{CE} = 10\text{ Vdc}$)	h_{FE}	25 40 40	— — —	—
Collector–Emitter Saturation Voltage ($I_C = 20\text{ mAdc}$, $I_B = 2.0\text{ mAdc}$)	$V_{CE(sat)}$	— —	0.5 0.4	Vdc
Base–Emitter Saturation Voltage ($I_C = 20\text{ mAdc}$, $I_B = 2.0\text{ mAdc}$)	$V_{BE(sat)}$	—	0.9	Vdc
SMALL–SIGNAL CHARACTERISTICS				
Current–Gain — Bandwidth Product ($I_C = 10\text{ mAdc}$, $V_{CE} = 20\text{ Vdc}$, $f = 100\text{ MHz}$)	f_T	50	—	MHz
Collector–Base Capacitance ($V_{CB} = 20\text{ Vdc}$, $I_E = 0$, $f = 1.0\text{ MHz}$)	C_{cb}	— —	3.0 4.0	pF

1. Pulse Test: Pulse Width $\leq 300\ \mu\text{s}$, Duty Cycle $\leq 2.0\%$.

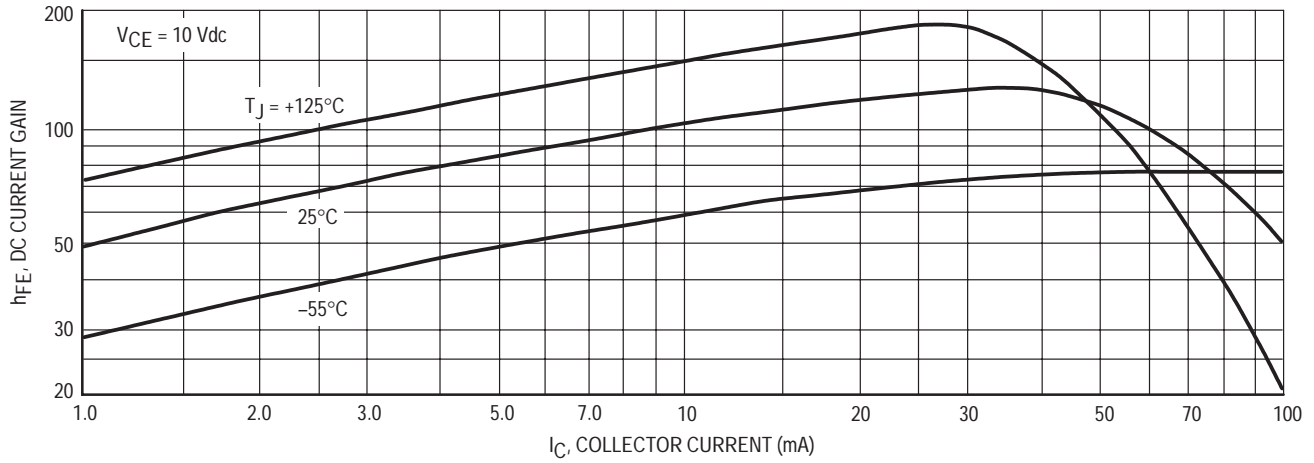


Figure 1. DC Current Gain

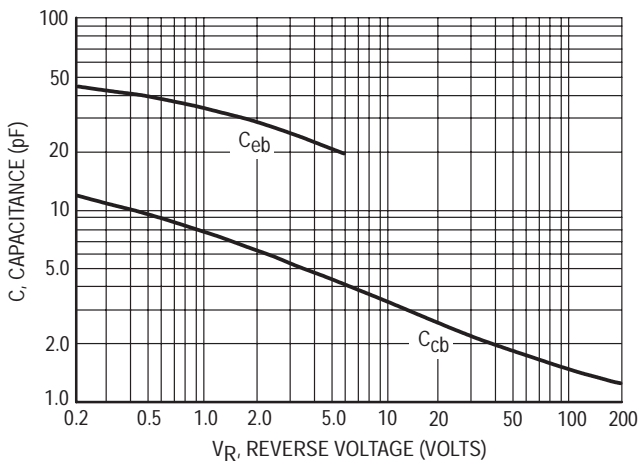


Figure 2. Capacitances

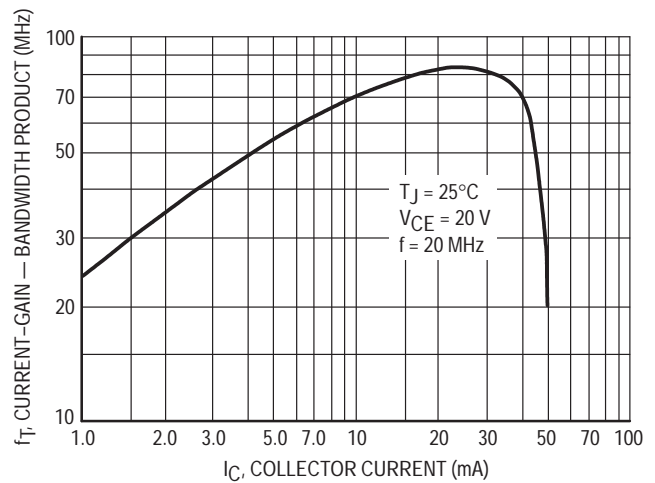


Figure 3. Current-Gain — Bandwidth Product

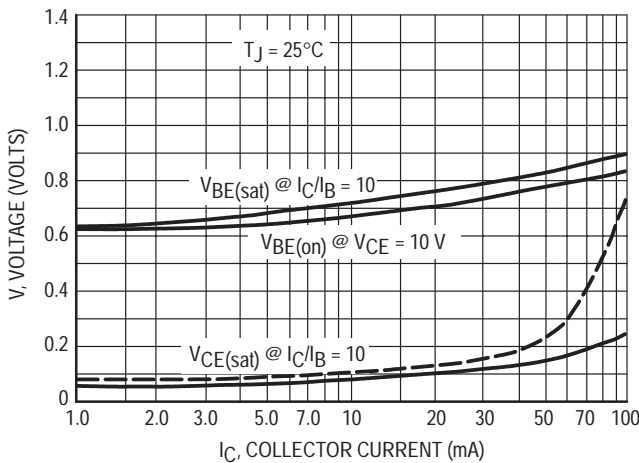


Figure 4. "On" Voltages

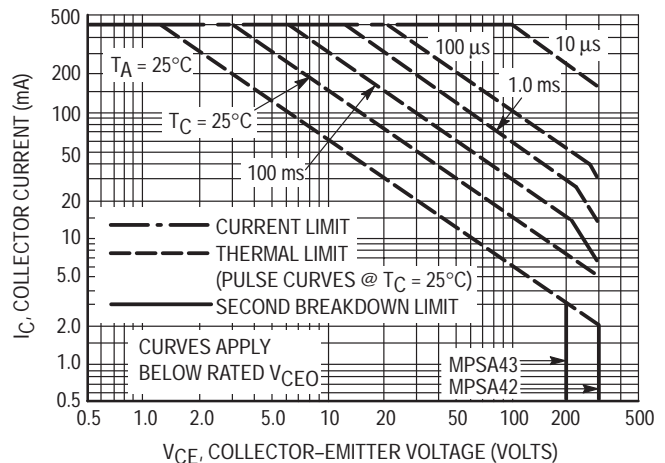


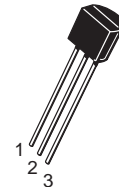
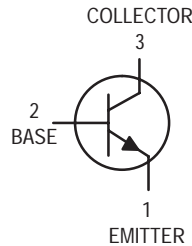
Figure 5. Maximum Forward Bias Safe Operating Area

High Voltage Transistor

NPN Silicon

MPSA44

Motorola Preferred Device



CASE 29-04, STYLE 1
TO-92 (TO-226AA)

MAXIMUM RATINGS

Rating	Symbol	Value	Unit
Collector–Emitter Voltage	V_{CEO}	400	Vdc
Collector–Base Voltage	V_{CBO}	500	Vdc
Emitter–Base Voltage	V_{EBO}	6.0	Vdc
Collector Current — Continuous	I_C	300	mAdc
Total Device Dissipation @ $T_A = 25^\circ\text{C}$ Derate above 25°C	P_D	625 5.0	mW mW/ $^\circ\text{C}$
Total Device Dissipation @ $T_C = 25^\circ\text{C}$ Derate above 25°C	P_D	1.5 12	Watts mW/ $^\circ\text{C}$
Operating and Storage Junction Temperature Range	T_J, T_{stg}	-55 to +150	$^\circ\text{C}$

THERMAL CHARACTERISTICS

Characteristic	Symbol	Max	Unit
Thermal Resistance, Junction to Ambient	$R_{\theta JA}$	200	$^\circ\text{C}/\text{W}$
Thermal Resistance, Junction to Case	$R_{\theta JC}$	83.3	$^\circ\text{C}/\text{W}$

ELECTRICAL CHARACTERISTICS ($T_A = 25^\circ\text{C}$ unless otherwise noted)

Characteristic	Symbol	Min	Max	Unit
----------------	--------	-----	-----	------

OFF CHARACTERISTICS

Collector–Emitter Breakdown Voltage ⁽¹⁾ ($I_C = 1.0 \text{ mAdc}, I_B = 0$)	$V_{(BR)CEO}$	400	—	Vdc
Collector–Emitter Breakdown Voltage ($I_C = 100 \mu\text{Adc}, V_{BE} = 0$)	$V_{(BR)CES}$	500	—	Vdc
Collector–Base Breakdown Voltage ($I_C = 100 \mu\text{Adc}, I_E = 0$)	$V_{(BR)CBO}$	500	—	Vdc
Emitter–Base Breakdown Voltage ($I_E = 10 \mu\text{Adc}, I_C = 0$)	$V_{(BR)EBO}$	6.0	—	Vdc
Collector Cutoff Current ($V_{CB} = 400 \text{ Vdc}, I_E = 0$)	I_{CBO}	—	0.1	μAdc
Collector Cutoff Current ($V_{CE} = 400 \text{ Vdc}, V_{BE} = 0$)	I_{CES}	—	500	nAdc
Emitter Cutoff Current ($V_{EB} = 4.0 \text{ Vdc}, I_C = 0$)	I_{EBO}	—	0.1	μAdc

1. Pulse Test: Pulse Width $\leq 300 \mu\text{s}$, Duty Cycle $\leq 2.0\%$.

Preferred devices are Motorola recommended choices for future use and best overall value.

MPSA44**ELECTRICAL CHARACTERISTICS** ($T_A = 25^\circ\text{C}$ unless otherwise noted) (Continued)

Characteristic	Symbol	Min	Max	Unit
ON CHARACTERISTICS(1)				
DC Current Gain ⁽¹⁾ ($I_C = 1.0 \text{ mA}$, $V_{CE} = 10 \text{ Vdc}$) ($I_C = 10 \text{ mA}$, $V_{CE} = 10 \text{ Vdc}$) ($I_C = 50 \text{ mA}$, $V_{CE} = 10 \text{ Vdc}$) ($I_C = 100 \text{ mA}$, $V_{CE} = 10 \text{ Vdc}$)	h_{FE}	40 50 45 40	— 200 — —	—
Collector–Emitter Saturation Voltage ⁽¹⁾ ($I_C = 1.0 \text{ mA}$, $I_B = 0.1 \text{ mA}$) ($I_C = 10 \text{ mA}$, $I_B = 1.0 \text{ mA}$) ($I_C = 50 \text{ mA}$, $I_B = 5.0 \text{ mA}$)	$V_{CE(sat)}$	— — —	0.4 0.5 0.75	Vdc
Base–Emitter Saturation Voltage ($I_C = 10 \text{ mA}$, $I_B = 1.0 \text{ mA}$)	$V_{BE(sat)}$	—	0.75	Vdc

SMALL–SIGNAL CHARACTERISTICS

Output Capacitance ($V_{CB} = 20 \text{ Vdc}$, $I_E = 0$, $f = 1.0 \text{ MHz}$)	C_{obo}	—	7.0	pF
Input Capacitance ($V_{EB} = 0.5 \text{ Vdc}$, $I_C = 0$, $f = 1.0 \text{ MHz}$)	C_{ibo}	—	130	pF
Small–Signal Current Gain ($I_C = 10 \text{ mA}$, $V_{CE} = 10 \text{ Vdc}$, $f = 20 \text{ MHz}$)	h_{fe}	1.0	—	—

1. Pulse Test: Pulse Width $\leq 300 \mu\text{s}$, Duty Cycle $\leq 2.0\%$.

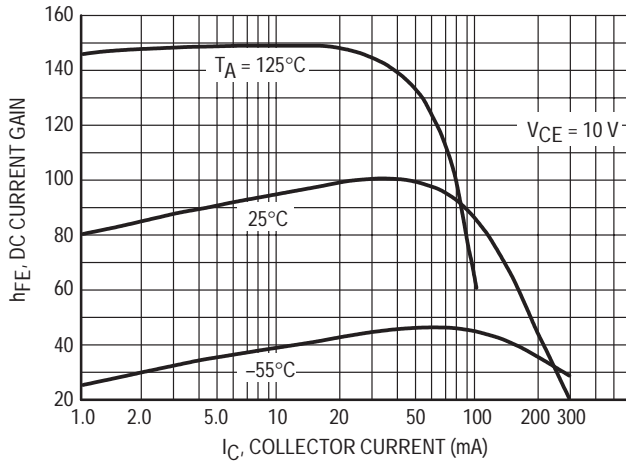


Figure 1. DC Current Gain

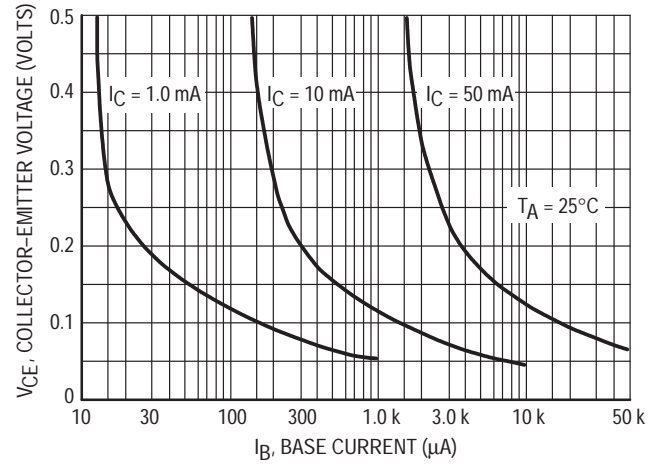


Figure 2. Collector Saturation Region

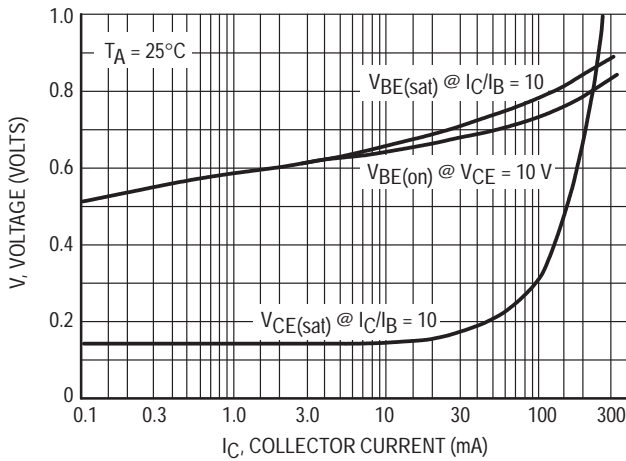


Figure 3. "On" Voltages

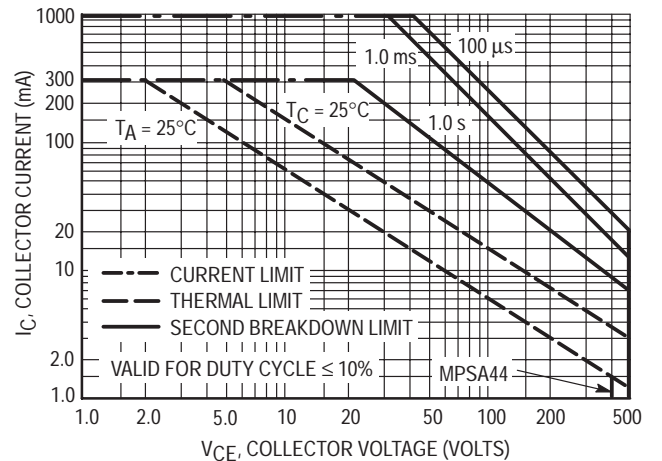


Figure 4. Active Region — Safe Operating Area

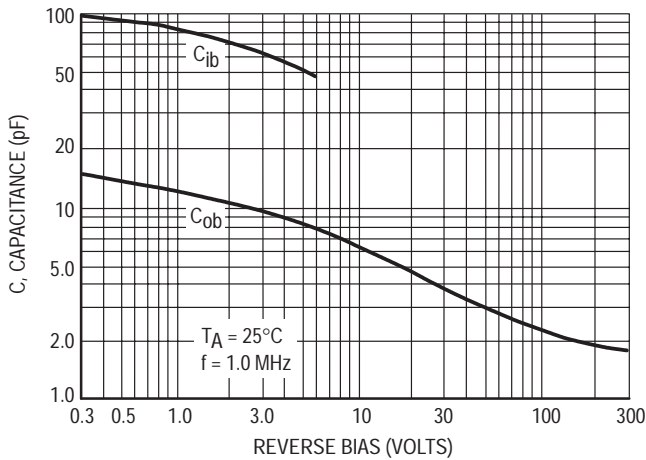


Figure 5. Capacitance

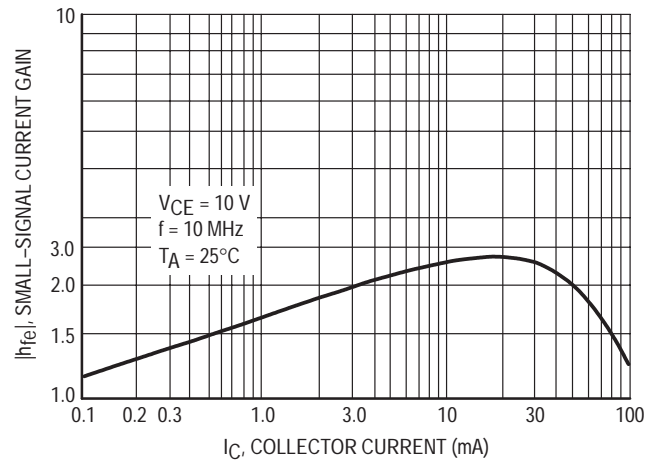


Figure 6. High Frequency Current Gain

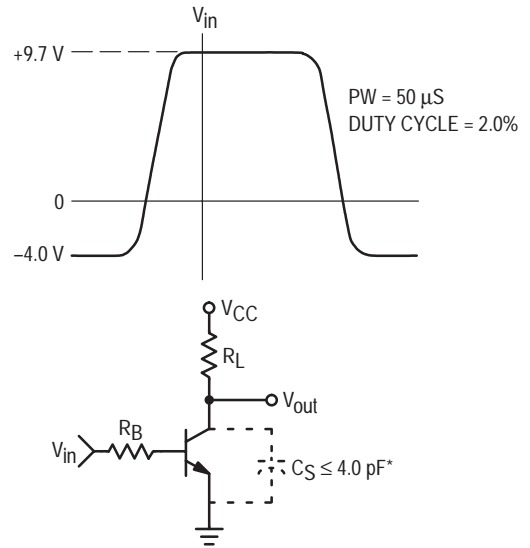
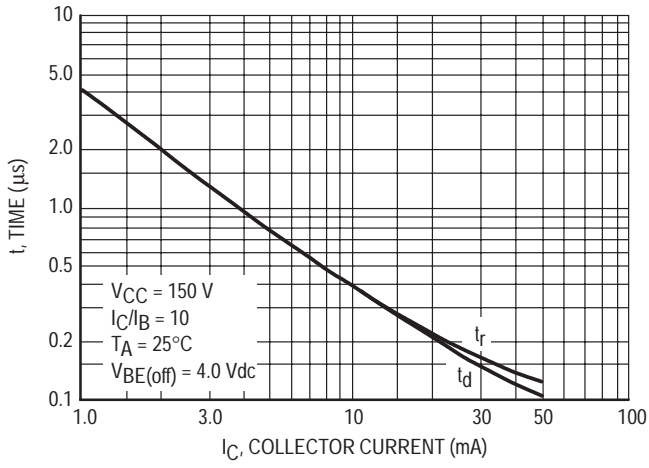


Figure 7. Turn-On Switching Times and Test Circuit

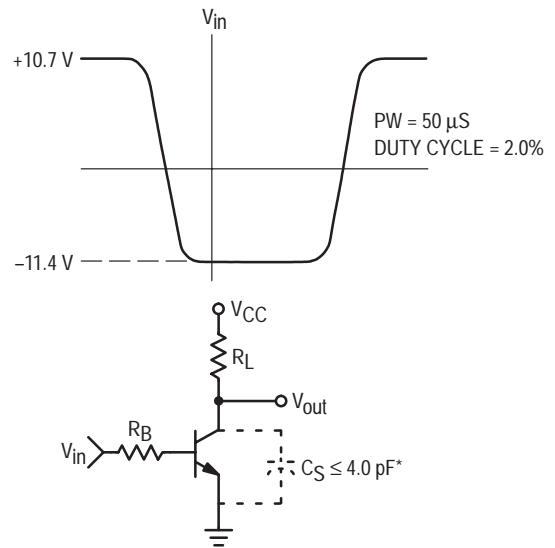
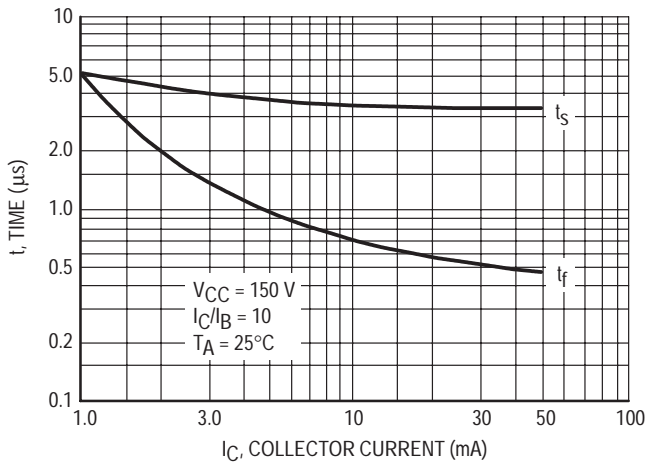
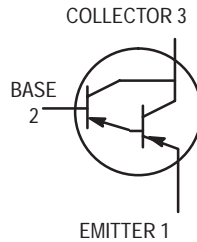


Figure 8. Turn-Off Switching Times and Test Circuit

* Total Shunt Capacitance or Test Jig and Connectors.

Darlington Transistors

PNP Silicon



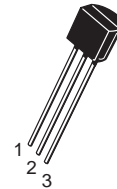
MPSA62 MPSA63 MPSA64*

MPSA55, MPSA56
For Specifications,
See MPSA05, MPSA06 Data

*Motorola Preferred Device

MAXIMUM RATINGS

Rating	Symbol	MPSA62	MPSA63 MPSA64	Unit
Collector–Emitter Voltage	V_{CES}	-20	-30	Vdc
Collector–Base Voltage	V_{CBO}	-20	-30	Vdc
Emitter–Base Voltage	V_{EBO}	-10		Vdc
Collector Current — Continuous	I_C	-500		mAdc
Total Device Dissipation @ $T_A = 25^\circ\text{C}$ Derate above 25°C	P_D	625	5.0	mW mW/ $^\circ\text{C}$
Total Device Dissipation @ $T_A = 25^\circ\text{C}$ Derate above 25°C	P_D	1.5	12	Watts mW/ $^\circ\text{C}$
Operating and Storage Junction Temperature Range	T_J, T_{stg}	-55 to +150		$^\circ\text{C}$



CASE 29-04, STYLE 1
TO-92 (TO-226AA)

THERMAL CHARACTERISTICS

Characteristic	Symbol	Max	Unit
Thermal Resistance, Junction to Ambient	$R_{\theta JA}$	200	$^\circ\text{C}/\text{W}$
Thermal Resistance, Junction to Case	$R_{\theta JC}$	83.3	$^\circ\text{C}/\text{W}$

ELECTRICAL CHARACTERISTICS ($T_A = 25^\circ\text{C}$ unless otherwise noted)

Characteristic	Symbol	Min	Max	Unit
----------------	--------	-----	-----	------

OFF CHARACTERISTICS

Collector–Emitter Breakdown Voltage ($I_C = -100 \mu\text{Adc}$, $V_{BE} = 0$)	MPSA62 MPSA63, MPSA64	$V_{(BR)CES}$	-20 -30	— —	Vdc
Collector Cutoff Current ($V_{CB} = -15 \text{Vdc}$, $I_E = 0$) ($V_{CB} = -30 \text{Vdc}$, $I_E = 0$)	MPSA62 MPSA63, MPSA64	I_{CBO}	— —	-100 -100	nAdc
Emitter Cutoff Current ($V_{EB} = -10 \text{Vdc}$, $I_C = 0$)		I_{EBO}	—	-100	nAdc

Preferred devices are Motorola recommended choices for future use and best overall value.

MPSA62 MPSA63 MPSA64

ELECTRICAL CHARACTERISTICS ($T_A = 25^\circ\text{C}$ unless otherwise noted) (Continued)

Characteristic	Symbol	Min	Max	Unit
ON CHARACTERISTICS(1)				
DC Current Gain ($I_C = -10 \text{ mAdc}$, $V_{CE} = -5.0 \text{ Vdc}$)	MPSA63 MPSA64 MPSA62	5,000 10,000 20,000	— — —	—
($I_C = -100 \text{ mAdc}$, $V_{CE} = -5.0 \text{ Vdc}$)	MPSA63 MPSA64	10,000 20,000	— —	—
Collector–Emitter Saturation Voltage ($I_C = -10 \text{ mAdc}$, $I_B = -0.01 \text{ mAdc}$) ($I_C = -100 \text{ mAdc}$, $I_B = -0.1 \text{ mAdc}$)	MPSA62 MPSA63, MPSA64	— —	-1.0 -1.5	Vdc
Base–Emitter On Voltage ($I_C = -10 \text{ mAdc}$, $V_{CE} = -5.0 \text{ Vdc}$) ($I_C = -100 \text{ mAdc}$, $V_{CE} = -5.0 \text{ Vdc}$)	MPSA62 MPSA63, MPSA64	— —	-1.4 -2.0	Vdc
SMALL–SIGNAL CHARACTERISTICS				
Current–Gain — Bandwidth Product(2) ($I_C = -100 \text{ mAdc}$, $V_{CE} = -5.0 \text{ Vdc}$, $f = 100 \text{ MHz}$)	MPSA63, MPSA64	125	—	MHz

1. Pulse Test: Pulse Width $\leq 300 \mu\text{s}$; Duty Cycle $\leq 2.0\%$.

2. $f_T = |h_{fe}| \cdot f_{\text{test}}$.

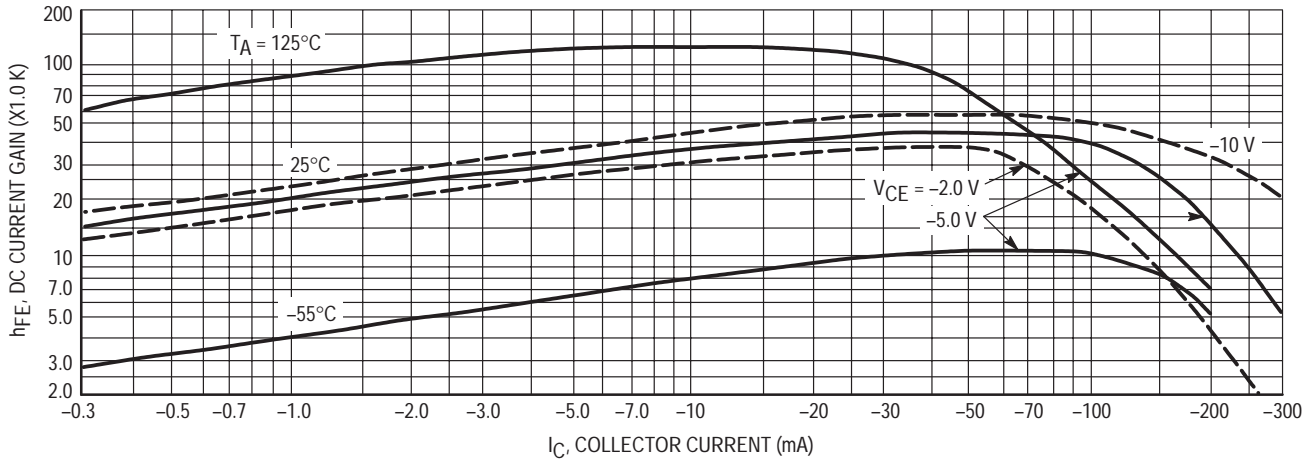


Figure 1. DC Current Gain

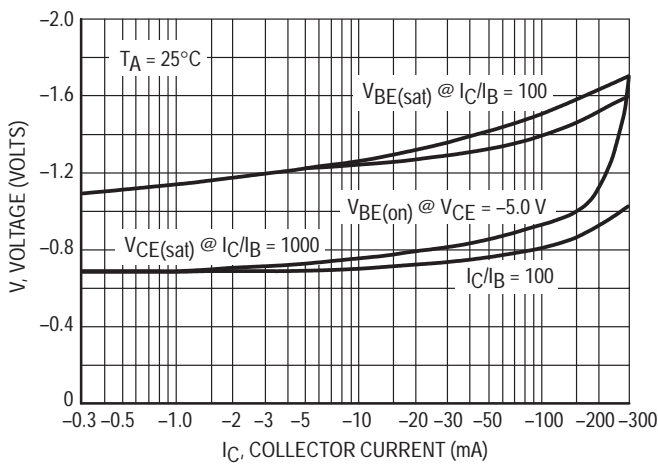


Figure 2. "On" Voltage

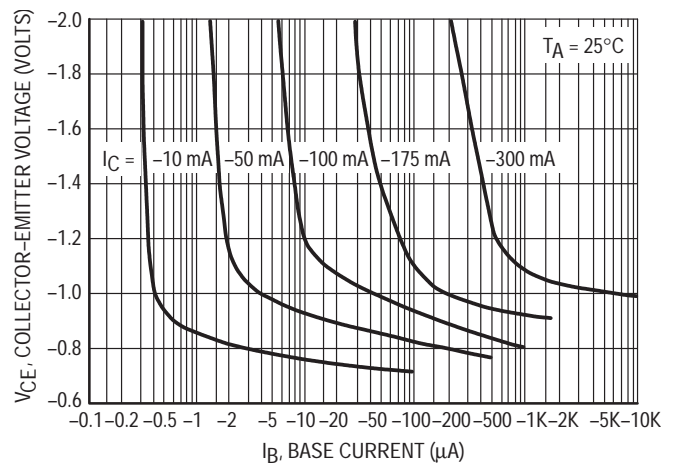


Figure 3. Collector Saturation Region

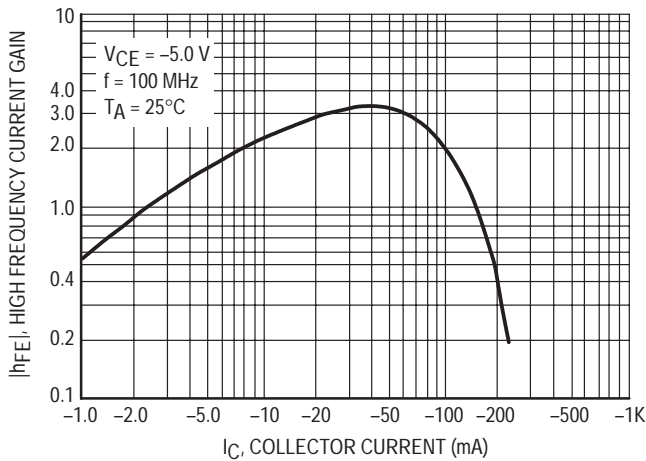


Figure 4. High Frequency Current Gain

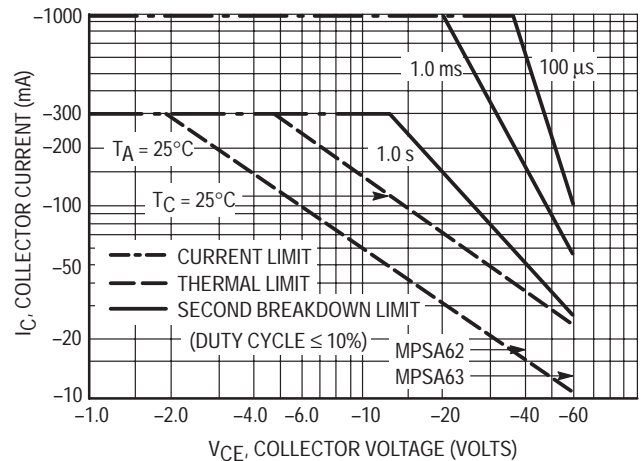
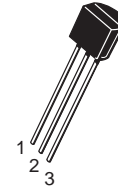
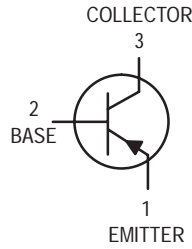


Figure 5. Active Region, Safe Operating Area

Amplifier Transistor

PNP Silicon

MPSA70



CASE 29-04, STYLE 1
TO-92 (TO-226AA)

MAXIMUM RATINGS

Rating	Symbol	Value	Unit
Collector–Emitter Voltage	V_{CEO}	–40	Vdc
Emitter–Base Voltage	V_{EBO}	–4.0	Vdc
Collector Current — Continuous	I_C	–100	mAdc
Total Device Dissipation @ $T_A = 25^\circ\text{C}$ Derate above 25°C	P_D	625 5.0	mW mW/ $^\circ\text{C}$
Total Device Dissipation @ $T_C = 25^\circ\text{C}$ Derate above 25°C	P_D	1.5 12	Watts mW/ $^\circ\text{C}$
Operating and Storage Junction Temperature Range	T_J, T_{stg}	–55 to +150	$^\circ\text{C}$

THERMAL CHARACTERISTICS

Characteristic	Symbol	Max	Unit
Thermal Resistance, Junction to Ambient	$R_{\theta JA}$	200	$^\circ\text{C}/\text{W}$
Thermal Resistance, Junction to Case	$R_{\theta JC}$	83.3	$^\circ\text{C}/\text{W}$

ELECTRICAL CHARACTERISTICS ($T_A = 25^\circ\text{C}$ unless otherwise noted)

Characteristic	Symbol	Min	Max	Unit
----------------	--------	-----	-----	------

OFF CHARACTERISTICS

Collector–Emitter Breakdown Voltage ⁽¹⁾ ($I_C = -1.0$ mAdc, $I_B = 0$)	$V_{(BR)CEO}$	–40	—	Vdc
Emitter–Base Breakdown Voltage ($I_E = -100$ μAdc , $I_C = 0$)	$V_{(BR)EBO}$	–4.0	—	Vdc
Collector Cutoff Current ($V_{CB} = -30$ Vdc, $I_E = 0$)	I_{CBO}	—	–100	nAdc

1. Pulse Test: Pulse Width ≤ 300 μs ; Duty Cycle $\leq 2.0\%$.

ELECTRICAL CHARACTERISTICS ($T_A = 25^\circ\text{C}$ unless otherwise noted) (Continued)

Characteristic	Symbol	Min	Max	Unit
ON CHARACTERISTICS				
DC Current Gain ($I_C = -5.0 \text{ mAdc}$, $V_{CE} = -10 \text{ Vdc}$)	h_{FE}	40	400	—
Collector–Emitter Saturation Voltage ($I_C = -10 \text{ mAdc}$, $I_B = -1.0 \text{ mAdc}$)	$V_{CE(\text{sat})}$	—	-0.25	Vdc
SMALL–SIGNAL CHARACTERISTICS				
Current–Gain — Bandwidth Product ($I_C = -5.0 \text{ mAdc}$, $V_{CE} = -10 \text{ Vdc}$, $f = 100 \text{ MHz}$)	f_T	125	—	MHz
Output Capacitance ($V_{CB} = -10 \text{ Vdc}$, $I_E = 0$, $f = 1.0 \text{ MHz}$)	C_{obo}	—	4.0	pF

TYPICAL NOISE CHARACTERISTICS

($V_{CE} = -5.0$ Vdc, $T_A = 25^\circ\text{C}$)

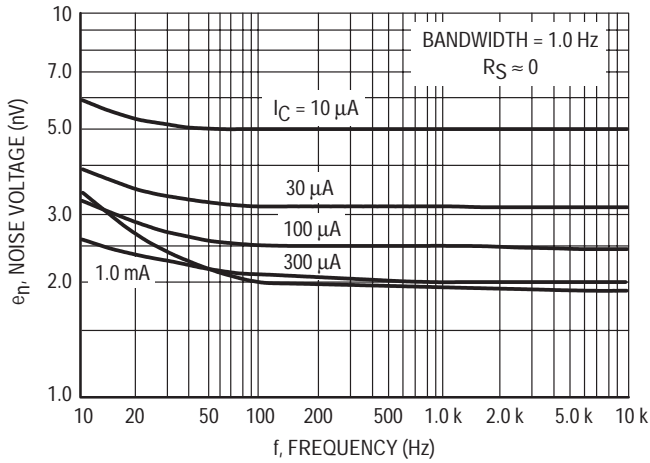


Figure 1. Noise Voltage

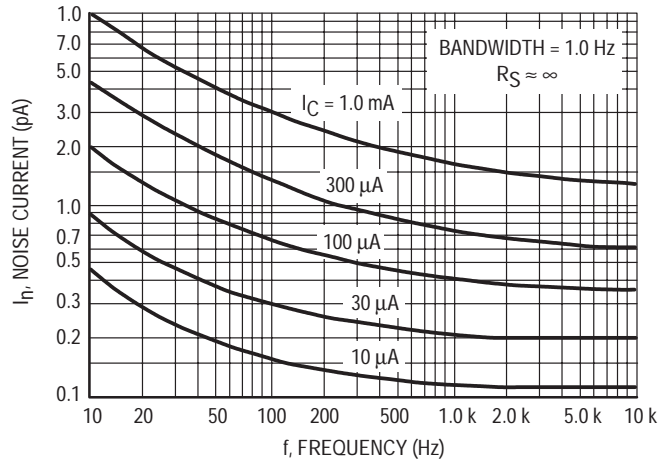


Figure 2. Noise Current

NOISE FIGURE CONTOURS

($V_{CE} = -5.0$ Vdc, $T_A = 25^\circ\text{C}$)

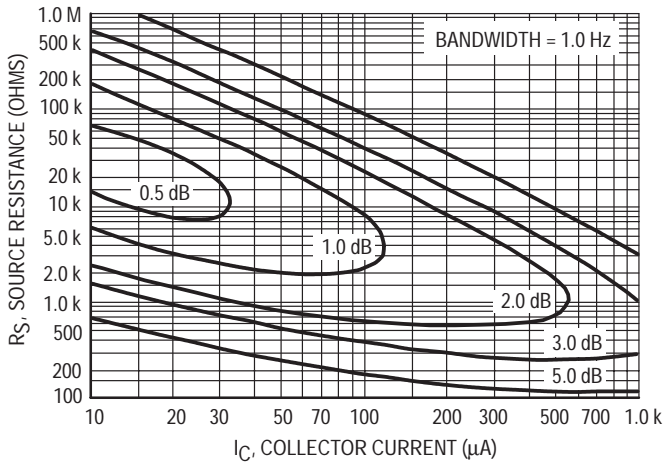


Figure 3. Narrow Band, 100 Hz

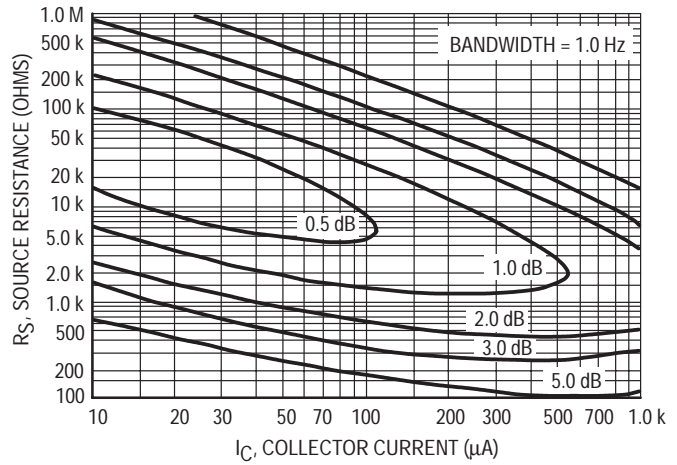


Figure 4. Narrow Band, 1.0 kHz

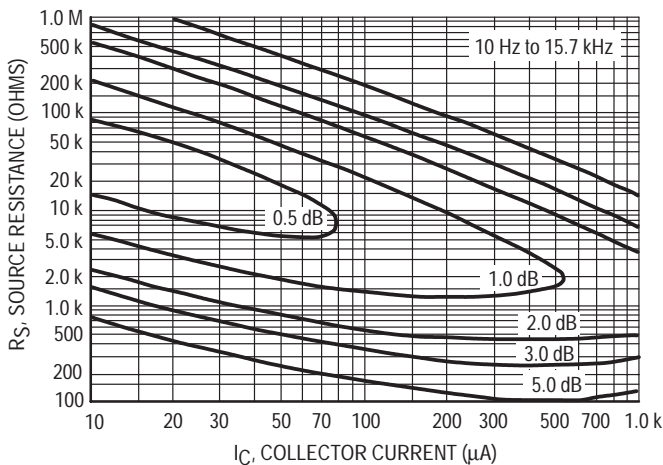


Figure 5. Wideband

Noise Figure is Defined as:

$$NF = 20 \log_{10} \left[\frac{e_n^2 + 4KTR_S + I_n^2 R_S^2}{4KTR_S} \right]^{1/2}$$

e_n = Noise Voltage of the Transistor referred to the input. (Figure 3)

I_n = Noise Current of the Transistor referred to the input. (Figure 4)

K = Boltzman's Constant (1.38×10^{-23} j/°K)

T = Temperature of the Source Resistance (°K)

R_S = Source Resistance (Ohms)

TYPICAL STATIC CHARACTERISTICS

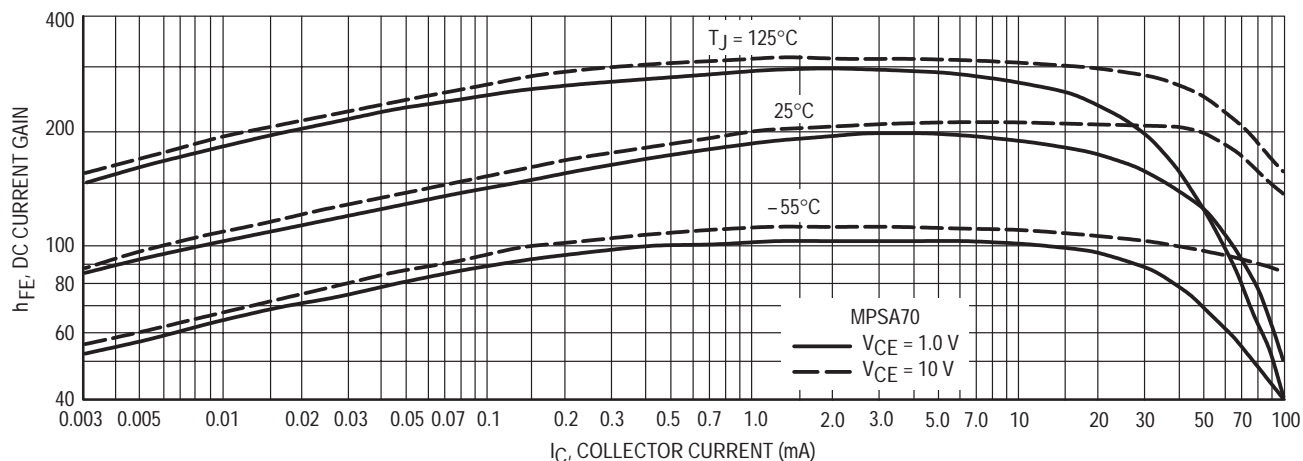


Figure 6. DC Current Gain

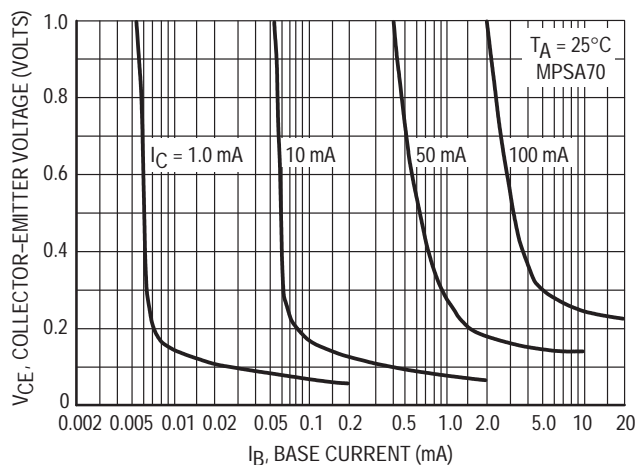


Figure 7. Collector Saturation Region

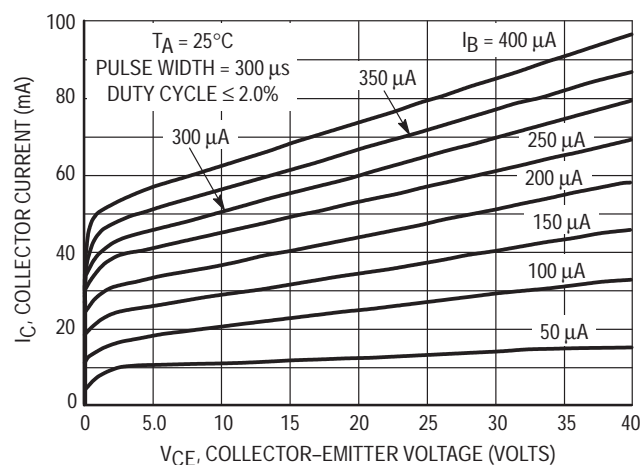


Figure 8. Collector Characteristics

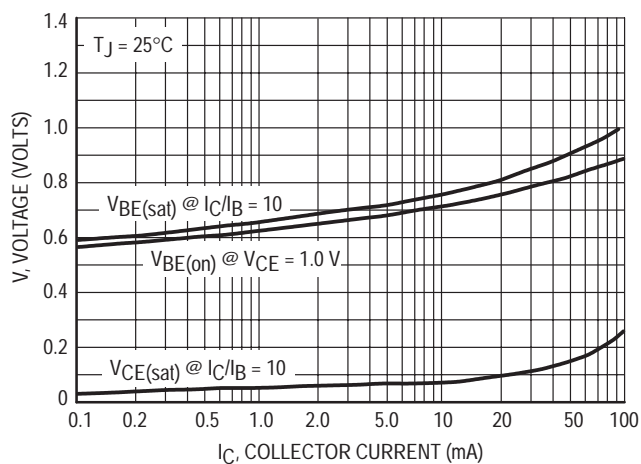


Figure 9. "On" Voltages

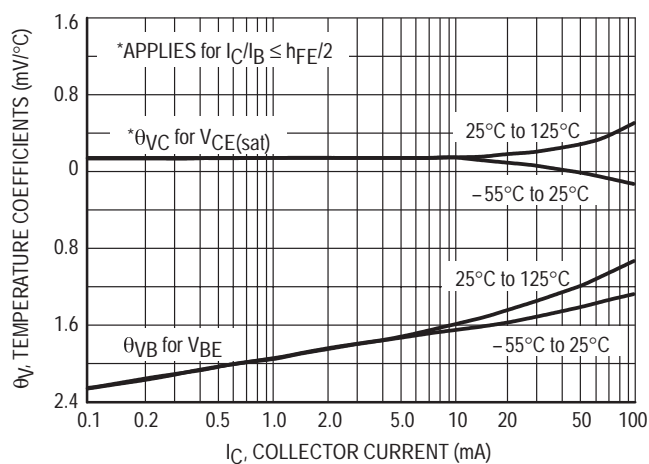


Figure 10. Temperature Coefficients

TYPICAL DYNAMIC CHARACTERISTICS

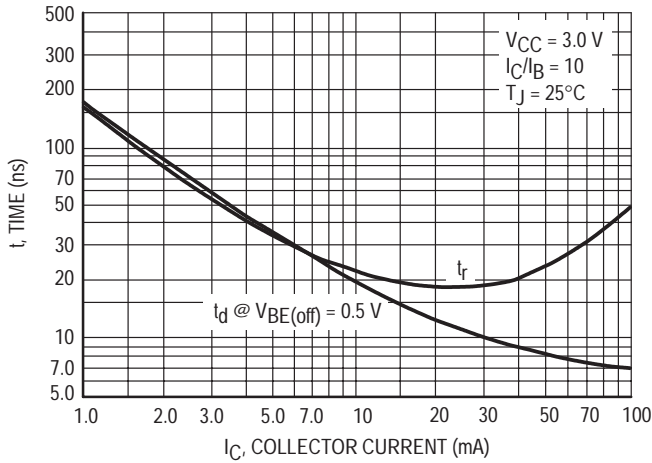


Figure 11. Turn-On Time

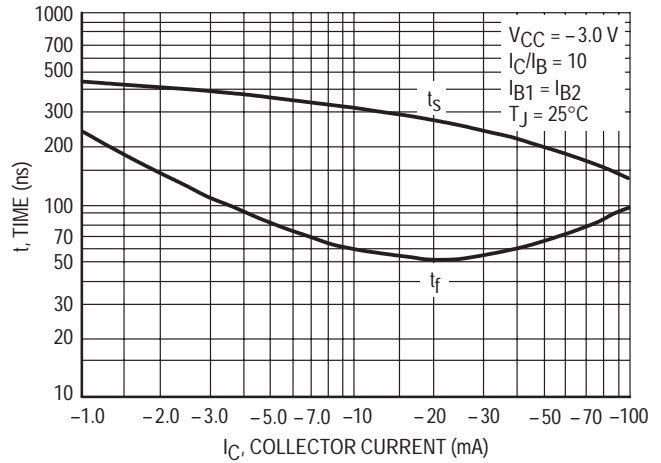


Figure 12. Turn-Off Time

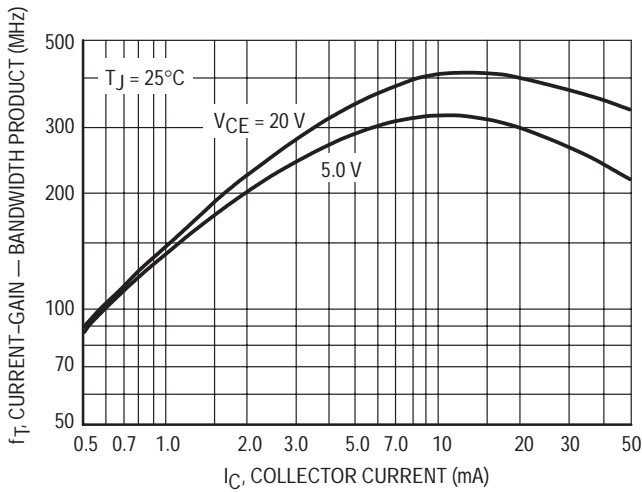


Figure 13. Current-Gain — Bandwidth Product

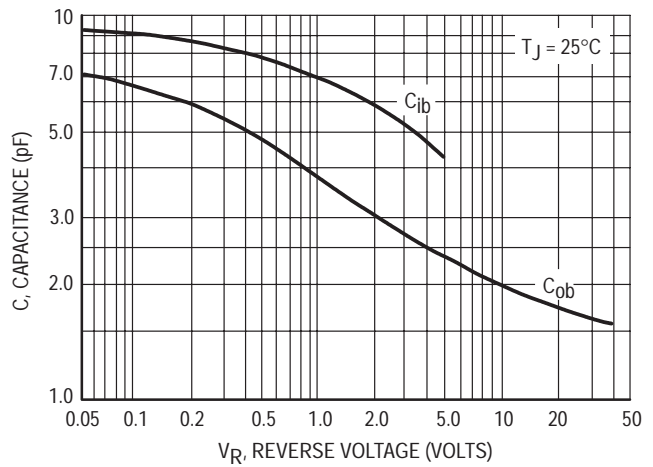


Figure 14. Capacitance

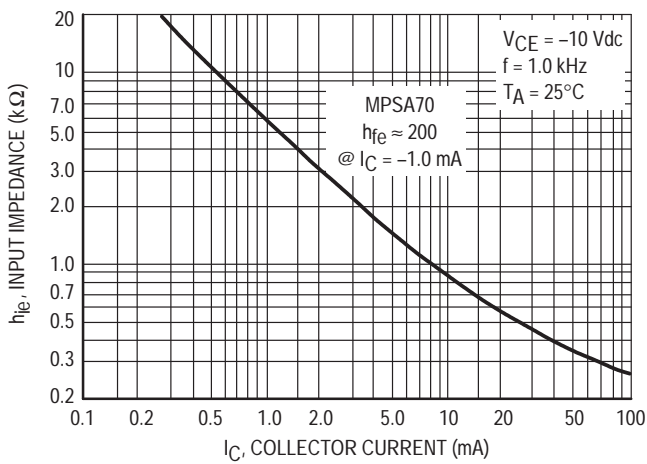


Figure 15. Input Impedance

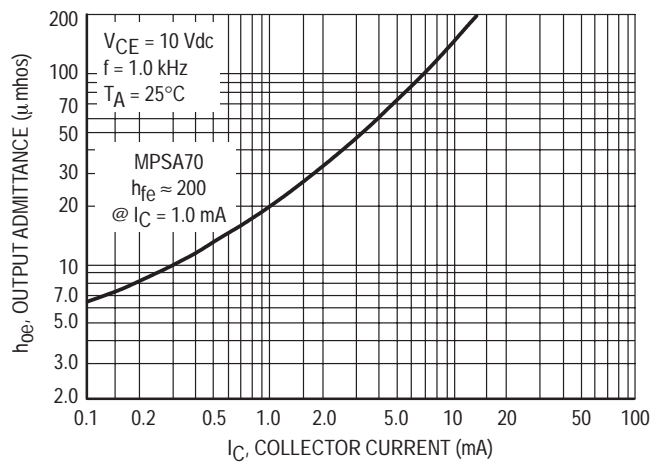


Figure 16. Output Admittance

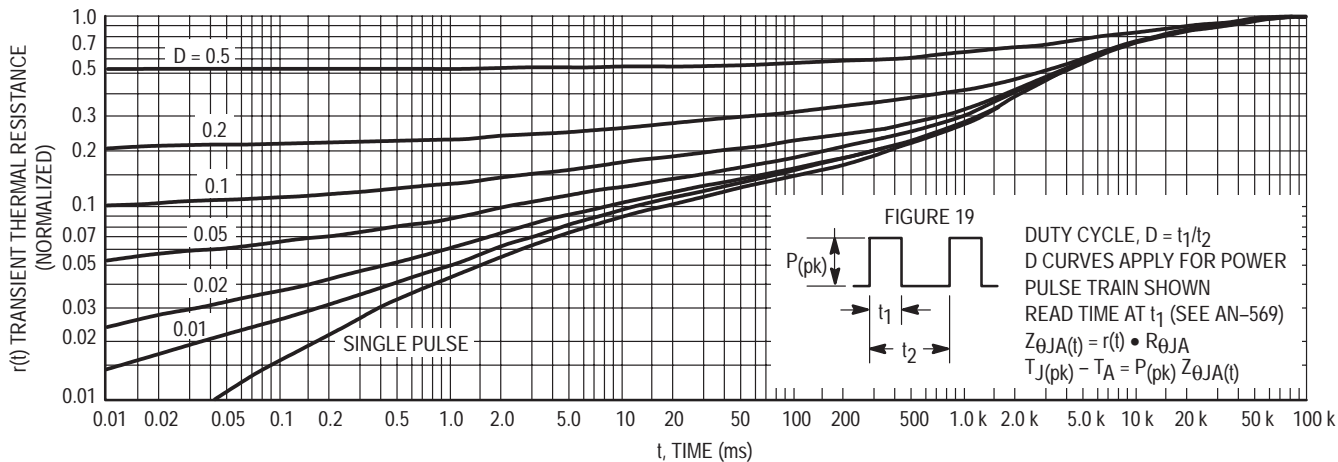


Figure 17. Thermal Response

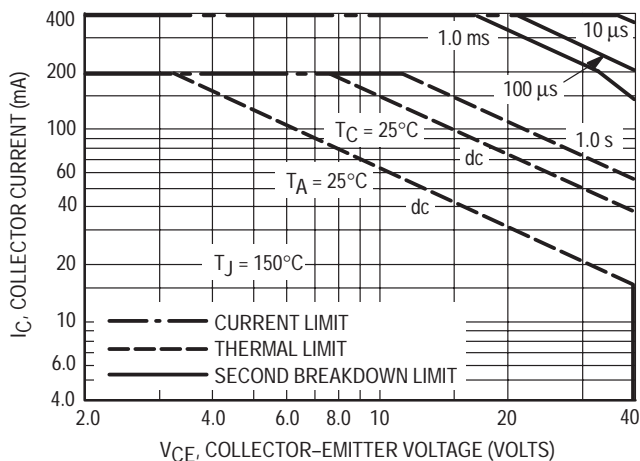


Figure 18. Active-Region Safe Operating Area

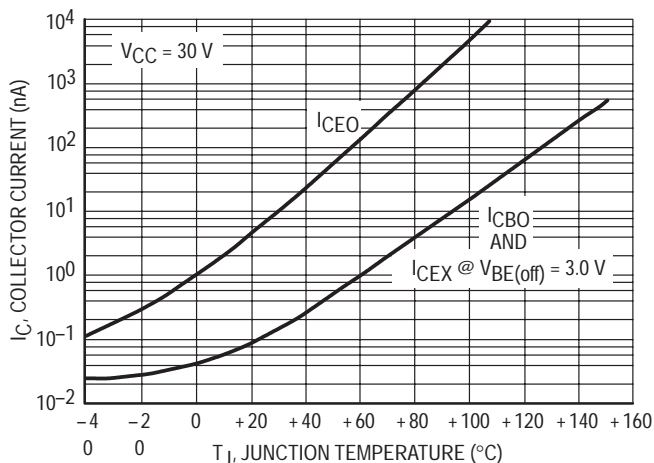


Figure 19. Typical Collector Leakage Current

The safe operating area curves indicate I_C - V_{CE} limits of the transistor that must be observed for reliable operation. Collector load lines for specific circuits must fall below the limits indicated by the applicable curve.

The data of Figure 18 is based upon $T_{J(pk)} = 150^\circ C$; T_C or T_A is variable depending upon conditions. Pulse curves are valid for duty cycles to 10% provided $T_{J(pk)} \leq 150^\circ C$. $T_{J(pk)}$ may be calculated from the data in Figure 17. At high case or ambient temperatures, thermal limitations will reduce the power than can be handled to values less than the limitations imposed by second breakdown.

DESIGN NOTE: USE OF THERMAL RESPONSE DATA

A train of periodical power pulses can be represented by the model as shown in Figure 19. Using the model and the device thermal response the normalized effective transient thermal resistance of Figure 17 was calculated for various duty cycles.

To find $Z_{\theta JA}(t)$, multiply the value obtained from Figure 17 by the steady state value $R_{\theta JA}$.

Example:

Dissipating 2.0 watts peak under the following conditions:
 $t_1 = 1.0$ ms, $t_2 = 5.0$ ms ($D = 0.2$)

Using Figure 17 at a pulse width of 1.0 ms and $D = 0.2$, the reading of $r(t)$ is 0.22.

The peak rise in junction temperature is therefore

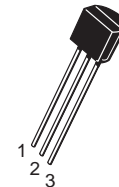
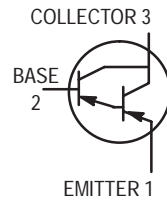
$$\Delta T = r(t) \times P(pk) \times R_{\theta JA} = 0.22 \times 2.0 \times 200 = 88^\circ C.$$

For more information, see AN-569.

Darlington Transistors

PNP Silicon

MPSA75
MPSA77



CASE 29-04, STYLE 1
TO-92 (TO-226AA)

MAXIMUM RATINGS

Rating	Symbol	MPSA75	MPSA77	Unit
Collector–Emitter Voltage	V_{CES}	-40	-60	Vdc
Emitter–Base Voltage	V_{EBO}	-10		Vdc
Collector Current — Continuous	I_C	-500		Adc
Total Device Dissipation @ $T_A = 25^\circ\text{C}$ Derate above 25°C	P_D	625	5.0	mW mW/°C
Operating and Storage Junction Temperature Range	T_J, T_{stg}	-55 to +150		°C

THERMAL CHARACTERISTICS

Characteristic	Symbol	Max	Unit
Thermal Resistance, Junction to Ambient	$R_{\theta JA}$	200	°C/W

ELECTRICAL CHARACTERISTICS ($T_A = 25^\circ\text{C}$ unless otherwise noted)

Characteristic	Symbol	Min	Typ	Max	Unit
----------------	--------	-----	-----	-----	------

OFF CHARACTERISTICS

Collector–Emitter Breakdown Voltage ($I_C = -100 \mu\text{Adc}$, $V_{BE} = 0$)	MPSA75 MPSA77	$V_{(BR)CES}$	-40 -60	— —	— —	Vdc
Collector–Base Breakdown Voltage ($I_C = 100 \mu\text{Adc}$, $I_E = 0$)	MPSA75 MPSA77	$V_{(BR)CBO}$	-40 -60	— —	— —	Vdc
Collector Cutoff Current ($V_{CB} = -30 \text{ V}$, $I_E = 0$) ($V_{CB} = -50 \text{ V}$, $I_E = 0$)	MPSA75 MPSA77	I_{CBO}	— —	— —	-100 -100	nAdc
Collector Cutoff Current ($V_{CE} = -30 \text{ V}$, $V_{BE} = 0$) ($V_{CE} = -50 \text{ V}$, $V_{BE} = 0$)	MPSA75 MPSA77	I_{CES}	— —	— —	-500 -500	nAdc
Emitter Cutoff Current ($V_{EB} = -10 \text{ Vdc}$)		I_{EBO}	—	—	-100	nAdc

ON CHARACTERISTICS

DC Current Gain ($I_C = -10 \text{ mA}$, $V_{CE} = -5.0 \text{ V}$) ($I_C = -100 \text{ mA}$, $V_{CE} = -5.0 \text{ V}$)		h_{FE}	10,000 10,000	— —	— —	—
Collector–Emitter Saturation Voltage ($I_C = -100 \text{ mA}$, $I_B = -0.1 \text{ mAdc}$)		$V_{CE(sat)}$	—	—	-1.5	Vdc
Base–Emitter On Voltage ($I_C = -100 \text{ mA}$, $V_{CE} = -5.0 \text{ Vdc}$)		V_{BE}	—	—	-2.0	Vdc

SMALL-SIGNAL CHARACTERISTICS

Current–Gain — High Frequency ($I_C = -10 \text{ mA}$, $V_{CE} = -5.0 \text{ V}$, $f = 100 \text{ MHz}$)		$ h_{fe} $	1.25	2.4	—	—
--------------------------------------------------------------------------------------------------------------	--	------------	------	-----	---	---

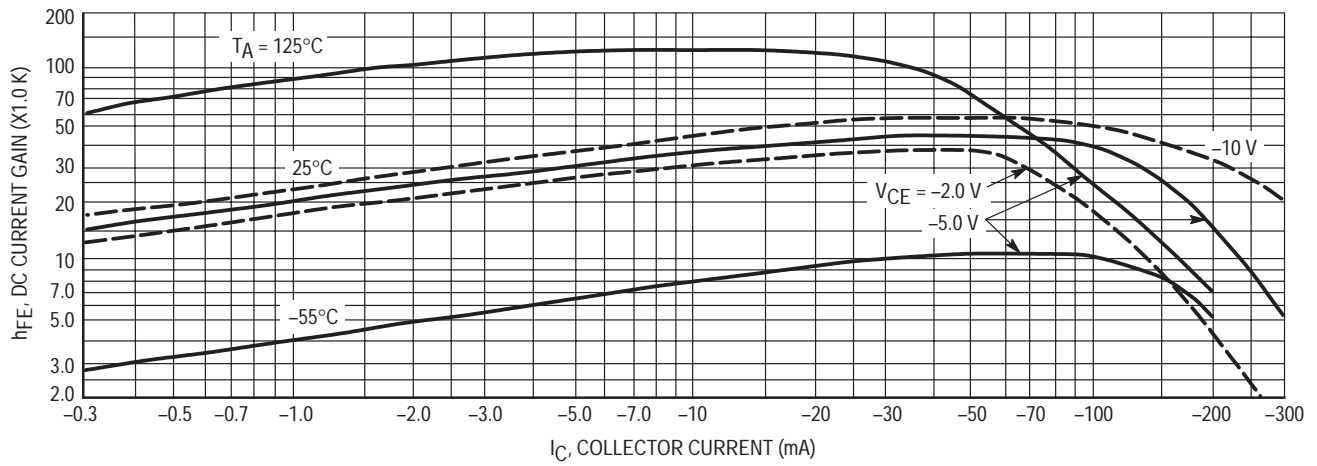


Figure 1. DC Current Gain

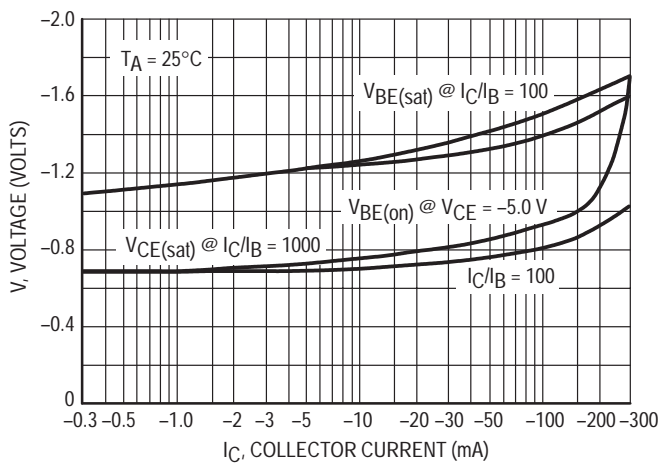


Figure 2. "On" Voltage

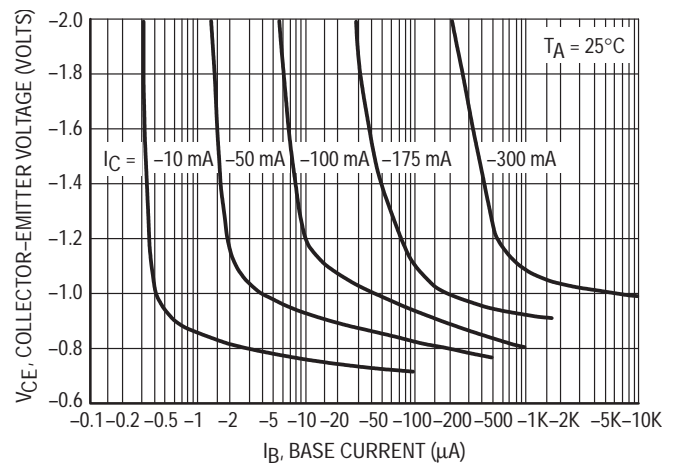


Figure 3. Collector Saturation Region

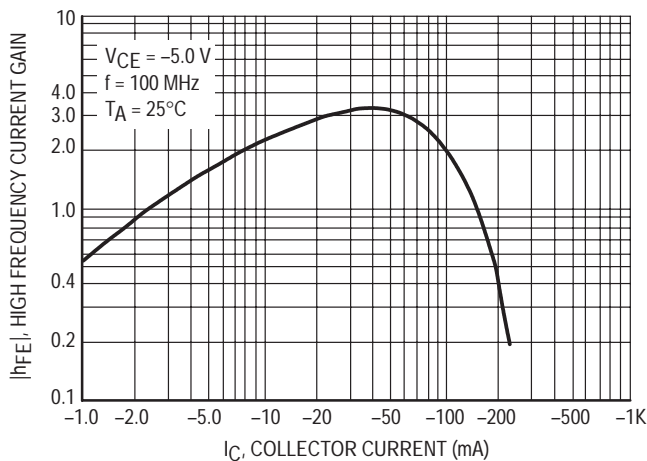


Figure 4. High Frequency Current Gain

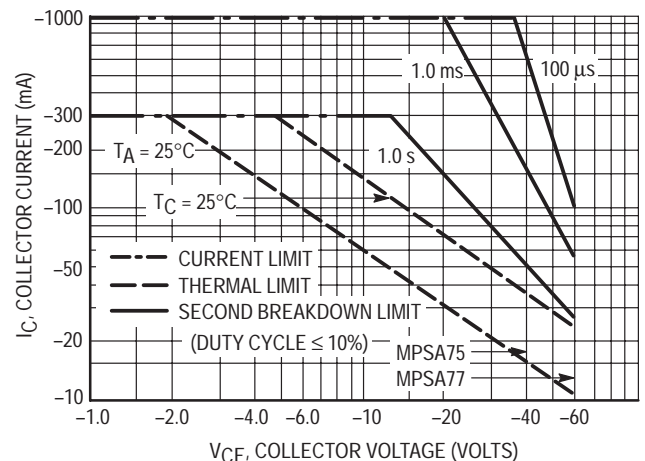
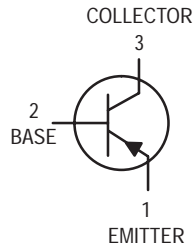


Figure 5. Active Region, Safe Operating Area

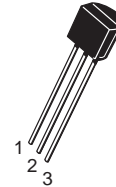
High Voltage Transistors

PNP Silicon



MPSA92*
MPSA93

*Motorola Preferred Device



CASE 29-04, STYLE 1
TO-92 (TO-226AA)

MAXIMUM RATINGS

Rating	Symbol	MPSA92	MPSA93	Unit
Collector–Emitter Voltage	V_{CEO}	-300	-200	Vdc
Collector–Base Voltage	V_{CBO}	-300	-200	Vdc
Emitter–Base Voltage	V_{EBO}	-5.0		Vdc
Collector Current — Continuous	I_C	-500		mAdc
Total Device Dissipation @ $T_A = 25^\circ\text{C}$ Derate above 25°C	P_D	625	5.0	mW mW/ $^\circ\text{C}$
Total Device Dissipation @ $T_C = 25^\circ\text{C}$ Derate above 25°C	P_D	1.5	12	Watts mW/ $^\circ\text{C}$
Operating and Storage Junction Temperature Range	T_J, T_{stg}	-55 to +150		$^\circ\text{C}$

THERMAL CHARACTERISTICS

Characteristic	Symbol	Max	Unit
Thermal Resistance, Junction to Ambient	$R_{\theta JA}$	200	$^\circ\text{C}/\text{W}$
Thermal Resistance, Junction to Case	$R_{\theta JC}$	83.3	$^\circ\text{C}/\text{W}$

ELECTRICAL CHARACTERISTICS ($T_A = 25^\circ\text{C}$ unless otherwise noted)

Characteristic	Symbol	Min	Max	Unit
----------------	--------	-----	-----	------

OFF CHARACTERISTICS

Collector–Emitter Breakdown Voltage ⁽¹⁾ ($I_C = -1.0 \text{ mAdc}, I_E = 0$)	MPSA92 MPSA93	$V_{(BR)CEO}$	-300 -200	— —	Vdc
Collector–Base Breakdown Voltage ($I_C = -100 \mu\text{Adc}, I_E = 0$)	MPSA92 MPSA93	$V_{(BR)CBO}$	-300 -200	— —	Vdc
Emitter–Base Breakdown Voltage ($I_E = -100 \mu\text{Adc}, I_C = 0$)		$V_{(BR)EBO}$	-5.0	—	Vdc
Collector Cutoff Current ($V_{CB} = -200 \text{ Vdc}, I_E = 0$) ($V_{CB} = -160 \text{ Vdc}, I_E = 0$)	MPSA92 MPSA93	I_{CBO}	— —	-0.25 -0.25	μAdc
Emitter Cutoff Current ($V_{EB} = -3.0 \text{ Vdc}, I_C = 0$)		I_{EBO}	—	-0.1	μAdc

1. Pulse Test: Pulse Width $\leq 300 \mu\text{s}$, Duty Cycle $\leq 2.0\%$.

Preferred devices are Motorola recommended choices for future use and best overall value.

ELECTRICAL CHARACTERISTICS ($T_A = 25^\circ\text{C}$ unless otherwise noted) (Continued)

Characteristic	Symbol	Min	Max	Unit
ON CHARACTERISTICS(1)				
DC Current Gain ($I_C = -1.0\text{ mAdc}$, $V_{CE} = -10\text{ Vdc}$) ($I_C = -10\text{ mAdc}$, $V_{CE} = -10\text{ Vdc}$)	Both Types Both Types	25 40	— —	—
($I_C = -30\text{ mAdc}$, $V_{CE} = -10\text{ Vdc}$)	MPSA92 MPSA93	25 25	— —	—
Collector–Emitter Saturation Voltage ($I_C = -20\text{ mAdc}$, $I_B = -2.0\text{ mAdc}$)	MPSA92 MPSA93	— —	-0.5 -0.4	Vdc
Base–Emitter Saturation Voltage ($I_C = -20\text{ mAdc}$, $I_B = -2.0\text{ mAdc}$)		—	-0.9	Vdc
SMALL–SIGNAL CHARACTERISTICS				
Current–Gain — Bandwidth Product ($I_C = -10\text{ mAdc}$, $V_{CE} = -20\text{ Vdc}$, $f = 100\text{ MHz}$)	f_T	50	—	MHz
Collector–Base Capacitance ($V_{CB} = -20\text{ Vdc}$, $I_E = 0$, $f = 1.0\text{ MHz}$)	C_{cb}	— —	6.0 8.0	pF

1. Pulse Test: Pulse Width $\leq 300\ \mu\text{s}$, Duty Cycle $\leq 2.0\%$.

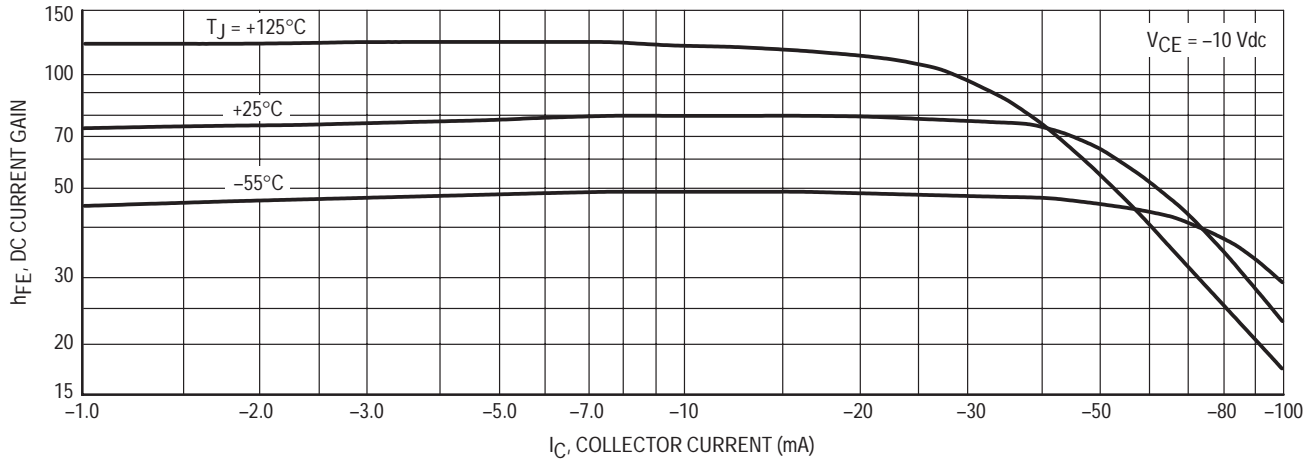


Figure 1. DC Current Gain

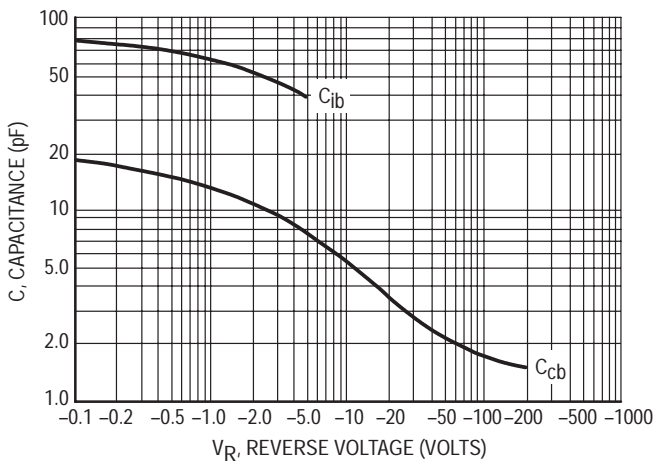


Figure 2. Capacitances

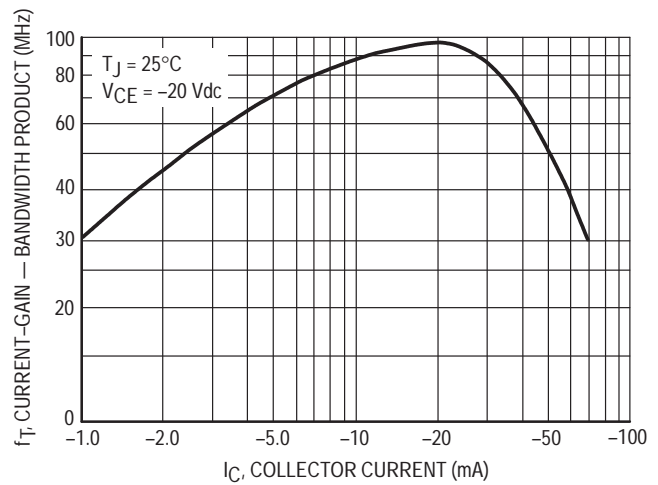


Figure 3. Current-Gain — Bandwidth Product

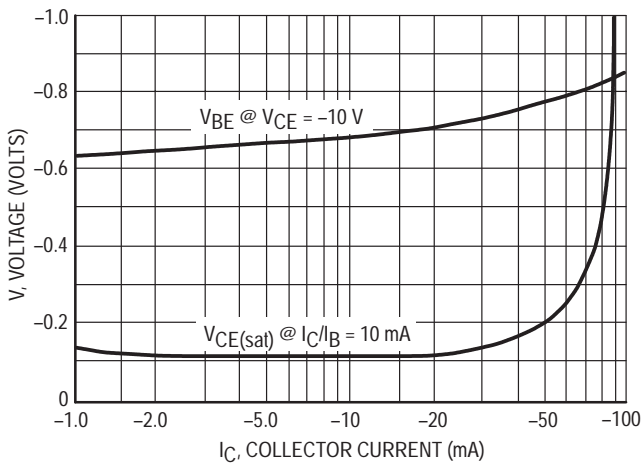


Figure 4. "On" Voltages

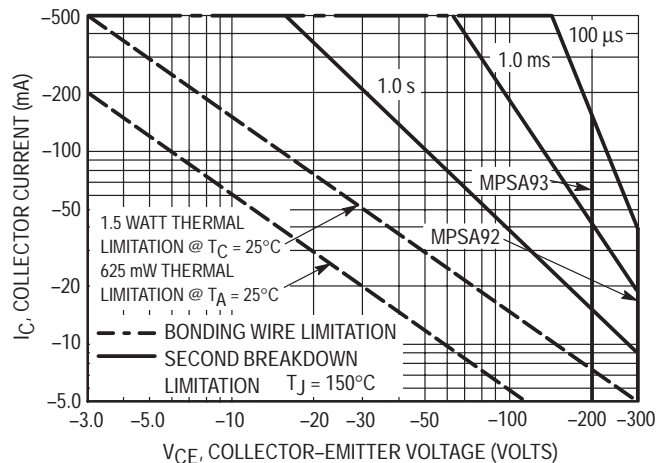
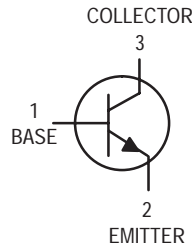


Figure 5. Active Region — Safe Operating Area

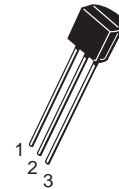
VHF/UHF Transistors

NPN Silicon



MPSH10 MPSH11

Motorola Preferred Devices



CASE 29-04, STYLE 2
TO-92 (TO-226AA)

MAXIMUM RATINGS

Rating	Symbol	Value	Unit
Collector–Emitter Voltage	V_{CEO}	25	Vdc
Collector–Base Voltage	V_{CBO}	30	Vdc
Emitter–Base Voltage	V_{EBO}	3.0	Vdc
Total Device Dissipation @ $T_A = 25^\circ\text{C}$ Derate above 25°C	P_D	350 2.8	mW mW/ $^\circ\text{C}$
Total Device Dissipation @ $T_C = 25^\circ\text{C}$ Derate above 25°C	P_D	1.0 8.0	Watts mW/ $^\circ\text{C}$
Operating and Storage Junction Temperature Range	T_J, T_{stg}	–55 to +150	$^\circ\text{C}$

THERMAL CHARACTERISTICS

Characteristic	Symbol	Max	Unit
Thermal Resistance, Junction to Ambient	$R_{\theta JA}$	357	$^\circ\text{C}/\text{W}$
Thermal Resistance, Junction to Case	$R_{\theta JC}$	125	$^\circ\text{C}/\text{W}$

ELECTRICAL CHARACTERISTICS ($T_A = 25^\circ\text{C}$ unless otherwise noted)

Characteristic	Symbol	Min	Max	Unit
----------------	--------	-----	-----	------

OFF CHARACTERISTICS

Collector–Emitter Breakdown Voltage ($I_C = 1.0 \text{ mAdc}, I_E = 0$)	$V_{(BR)CEO}$	25	—	Vdc
Collector–Base Breakdown Voltage ($I_C = 100 \mu\text{Adc}, I_E = 0$)	$V_{(BR)CBO}$	30	—	Vdc
Emitter–Base Breakdown Voltage ($I_E = 10 \mu\text{Adc}, I_C = 0$)	$V_{(BR)EBO}$	3.0	—	Vdc
Collector Cutoff Current ($V_{CB} = 25 \text{ Vdc}, I_E = 0$)	I_{CBO}	—	100	nAdc
Emitter Cutoff Current ($V_{EB} = 2.0 \text{ Vdc}, I_C = 0$)	I_{EBO}	—	100	nAdc

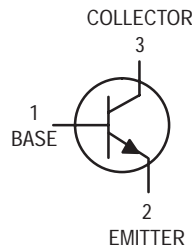
Preferred devices are Motorola recommended choices for future use and best overall value.

MPSH10 MPSH11**ELECTRICAL CHARACTERISTICS** ($T_A = 25^\circ\text{C}$ unless otherwise noted) (Continued)

Characteristic	Symbol	Min	Max	Unit
ON CHARACTERISTICS				
DC Current Gain ($I_C = 4.0 \text{ mA}$, $V_{CE} = 10 \text{ Vdc}$)	h_{FE}	60	—	—
Collector–Emitter Saturation Voltage ($I_C = 4.0 \text{ mA}$, $I_B = 0.4 \text{ mA}$)	$V_{CE(sat)}$	—	0.5	Vdc
Base–Emitter On Voltage ($I_C = 4.0 \text{ mA}$, $V_{CE} = 10 \text{ Vdc}$)	$V_{BE(on)}$	—	0.95	Vdc
SMALL–SIGNAL CHARACTERISTICS				
Current–Gain — Bandwidth Product ($I_C = 4.0 \text{ mA}$, $V_{CE} = 10 \text{ Vdc}$, $f = 100 \text{ MHz}$)	f_T	650	—	MHz
Collector–Base Capacitance ($V_{CB} = 10 \text{ Vdc}$, $I_E = 0$, $f = 1.0 \text{ MHz}$)	C_{cb}	—	0.7	pF
Common–Base Feedback Capacitance ($V_{CB} = 10 \text{ Vdc}$, $I_E = 0$, $f = 1.0 \text{ MHz}$)	C_{rb}	MPSH10 0.35 MPSH11 0.6	0.65 0.9	pF
Collector Base Time Constant ($I_C = 4.0 \text{ mA}$, $V_{CB} = 10 \text{ Vdc}$, $f = 31.8 \text{ MHz}$)	$r_b' C_C$	—	9.0	ps

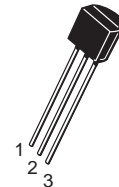
CATV Transistor

NPN Silicon



MPSH17

Motorola Preferred Device



CASE 29-04, STYLE 2
TO-92 (TO-226AA)

MAXIMUM RATINGS

Rating	Symbol	Value	Unit
Collector–Emitter Voltage	V_{CEO}	15	Vdc
Collector–Base Voltage	V_{CBO}	20	Vdc
Emitter–Base Voltage	V_{EBO}	3.0	Vdc
Total Device Dissipation @ $T_A = 25^\circ\text{C}$ Derate above 25°C	P_D	350 2.81	mW mW/ $^\circ\text{C}$
Operating and Storage Junction Temperature Range	T_J, T_{stg}	-55 to +150	$^\circ\text{C}$

THERMAL CHARACTERISTICS

Characteristic	Symbol	Max	Unit
Thermal Resistance, Junction to Ambient (Printed Circuit Board Mounting)	$R_{\theta JA}$	357	$^\circ\text{C}/\text{W}$

ELECTRICAL CHARACTERISTICS ($T_A = 25^\circ\text{C}$ unless otherwise noted)

Characteristic	Symbol	Min	Typ	Max	Unit
----------------	--------	-----	-----	-----	------

OFF CHARACTERISTICS

Collector–Emitter Breakdown Voltage ($I_C = 1.0 \text{ mAdc}, I_E = 0$)	$V_{(BR)CEO}$	15	—	—	Vdc
Collector–Base Breakdown Voltage ($I_C = 100 \mu\text{Adc}, I_E = 0$)	$V_{(BR)CBO}$	20	—	—	Vdc
Emitter–Base Breakdown Voltage ($I_E = 10 \mu\text{Adc}, I_C = 0$)	$V_{(BR)EBO}$	3.0	—	—	Vdc
Collector Cutoff Current ($V_{CB} = 15 \text{ Vdc}, I_E = 0$)	I_{CBO}	—	—	100	nAdc

Preferred devices are Motorola recommended choices for future use and best overall value.

MPSH17**ELECTRICAL CHARACTERISTICS** ($T_A = 25^\circ\text{C}$ unless otherwise noted) (Continued)

Characteristic	Symbol	Min	Typ	Max	Unit
----------------	--------	-----	-----	-----	------

ON CHARACTERISTICS

DC Current Gain ($I_C = 5.0 \text{ mA}$, $V_{CE} = 10 \text{ Vdc}$)	h_{FE}	25	—	250	—
Collector–Emitter Saturation Voltage ($I_C = 10 \text{ mA}$, $I_B = 1.0 \text{ mA}$)	$V_{CE(sat)}$	—	—	0.5	—

SMALL–SIGNAL CHARACTERISTICS

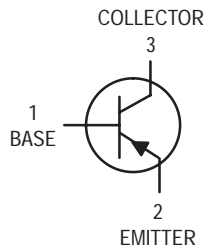
Current–Gain — Bandwidth Product ($I_C = 5.0 \text{ mA}$, $V_{CE} = 10 \text{ Vdc}$, $f = 100 \text{ MHz}$)	f_T	800	—	—	MHz
Collector–Base Capacitance ($V_{CB} = 10 \text{ Vdc}$, $f = 1.0 \text{ MHz}$)	C_{cb}	0.3	—	0.9	pF
Small–Signal Current Gain ($I_C = 5.0 \text{ mA}$, $V_{CE} = 10 \text{ Vdc}$, $f = 1.0 \text{ kHz}$)	h_{fe}	30	—	—	—
Noise Figure ($I_C = 5.0 \text{ mA}$, $V_{CC} = 12 \text{ Vdc}$, $R_S = 50 \text{ ohms}$, $f = 200 \text{ MHz}$)	NF	—	—	6.0	dB

FUNCTIONAL TEST

Amplifier Power Gain ($I_C = 5.0 \text{ mA}$, $V_{CC} = 12 \text{ Vdc}$, $R_S = 50 \text{ ohms}$, $f = 200 \text{ MHz}$)	G_{pe}	—	24	—	dB
----------------------------------------------------------------------------------------------------------------------------------	----------	---	----	---	----

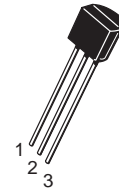
RF Amplifier Transistor

PNP Silicon



MPSH81

Motorola Preferred Device



CASE 29-04, STYLE 2
TO-92 (TO-226AA)

MAXIMUM RATINGS

Rating	Symbol	Value	Unit
Collector–Emitter Voltage	V_{CEO}	–20	Vdc
Collector–Base Voltage	V_{CBO}	–20	Vdc
Emitter–Base Voltage	V_{EBO}	–3.0	Vdc
Total Device Dissipation @ $T_A = 25^\circ\text{C}$ Derate above 25°C	P_D	350 2.81	mW mW/ $^\circ\text{C}$
Operating and Storage Junction Temperature Range	T_J, T_{stg}	–55 to +150	$^\circ\text{C}$

THERMAL CHARACTERISTICS

Characteristic	Symbol	Max	Unit
Thermal Resistance, Junction to Ambient	$R_{\theta JA}$	357	$^\circ\text{C}/\text{W}$

ELECTRICAL CHARACTERISTICS ($T_A = 25^\circ\text{C}$ unless otherwise noted)

Characteristic	Symbol	Min	Typ	Max	Unit
----------------	--------	-----	-----	-----	------

OFF CHARACTERISTICS

Collector–Emitter Breakdown Voltage ($I_C = -1.0 \text{ mA}$, $I_B = 0$)	$V_{(BR)CEO}$	–20	—	—	Vdc
Collector–Base Breakdown Voltage ($I_C = -10 \mu\text{A}$, $I_E = 0$)	$V_{(BR)CBO}$	–20	—	—	Vdc
Emitter–Base Breakdown Voltage ($I_E = -10 \mu\text{A}$, $I_C = 0$)	$V_{(BR)EBO}$	–3.0	—	—	Vdc
Collector Cutoff Current ($V_{CB} = -10 \text{ Vdc}$, $I_E = 0$)	I_{CBO}	—	—	–100	nA
Emitter Cutoff Current ($V_{EB} = -2.0 \text{ Vdc}$, $I_C = 0$)	I_{EBO}	—	—	–100	nA

Preferred devices are Motorola recommended choices for future use and best overall value.

MPSH81**ELECTRICAL CHARACTERISTICS** ($T_A = 25^\circ\text{C}$ unless otherwise noted) (Continued)

Characteristic	Symbol	Min	Typ	Max	Unit
ON CHARACTERISTICS					
DC Current Gain ($I_C = -5.0 \text{ mA dc}$, $V_{CE} = -10 \text{ V dc}$)	h_{FE}	60	—	—	—
Collector–Emitter Saturation Voltage ($I_C = -5.0 \text{ mA dc}$, $I_B = -0.5 \text{ mA dc}$)	$V_{CE(\text{sat})}$	—	—	-0.5	Vdc
Base–Emitter On Voltage ($I_C = -5.0 \text{ mA dc}$, $V_{CE} = -10 \text{ V dc}$)	$V_{BE(\text{on})}$	—	—	-0.9	Vdc
SMALL–SIGNAL CHARACTERISTICS					
Current–Gain — Bandwidth Product ($I_C = -5.0 \text{ mA dc}$, $V_{CE} = -10 \text{ V dc}$, $f = 100 \text{ MHz}$)	f_T	600	—	—	MHz
Collector–Base Capacitance ($V_{CB} = -10 \text{ V dc}$, $I_E = 0$, $f = 1.0 \text{ MHz}$)	C_{cb}	—	—	0.85	pF
Collector–Emitter Capacitance ($I_B = 0$, $V_{CB} = -10 \text{ V dc}$, $f = 1.0 \text{ MHz}$)	C_{ce}	—	—	0.65	pF

TYPICAL COMMON-BASE y-PARAMETERS

($V_{CB} = 10 \text{ Vdc}$, $T_A = 25^\circ\text{C}$, Frequency Points in MHz)

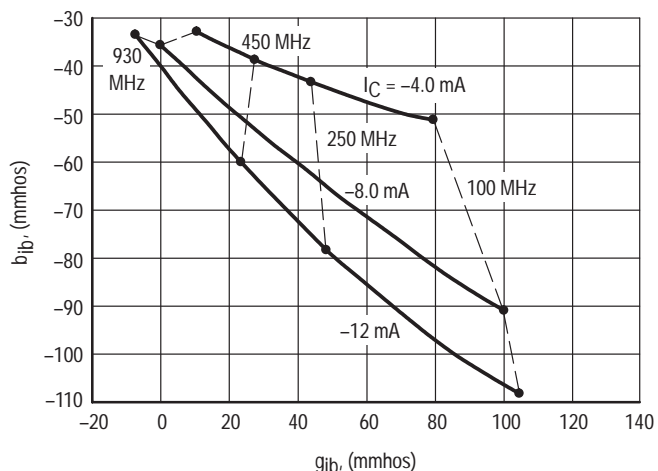


Figure 1. Input Admittance

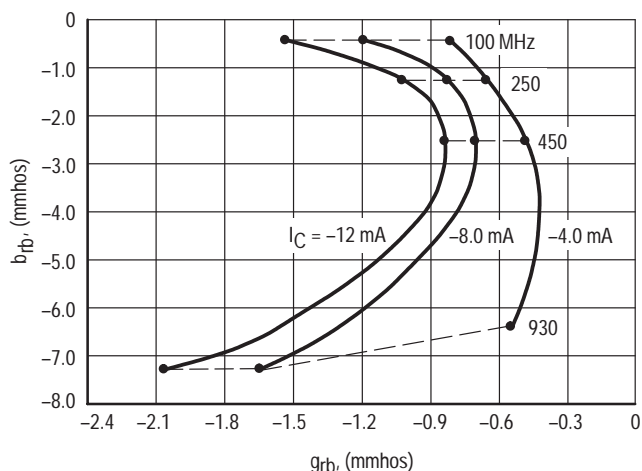


Figure 2. Reverse Transfer Admittance

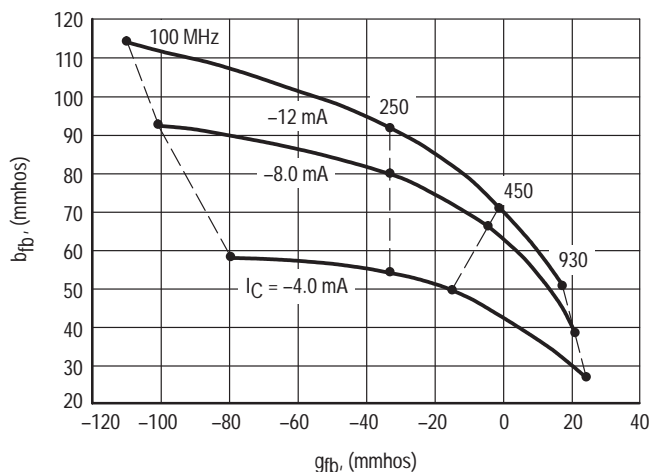


Figure 3. Forward Transfer Admittance

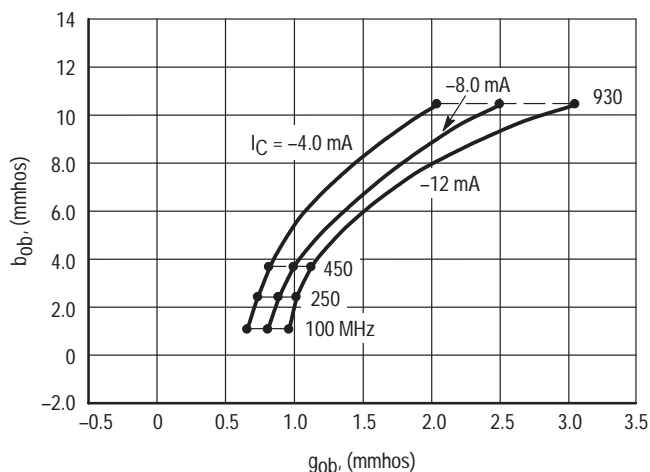


Figure 4. Output Admittance

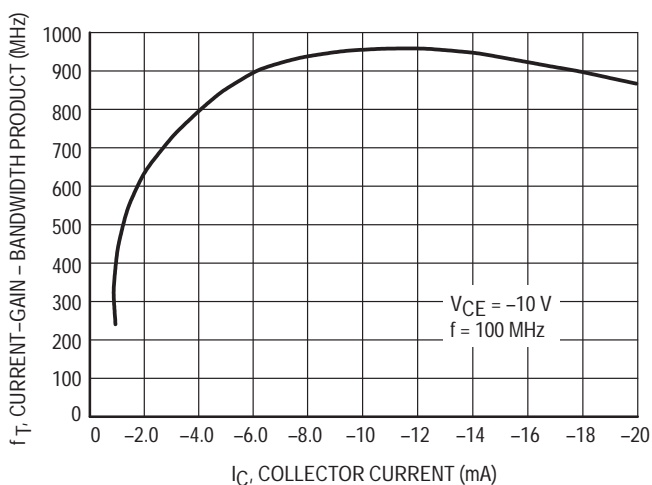
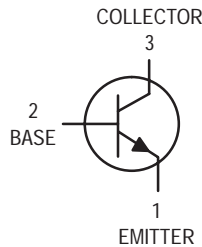


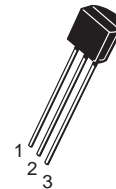
Figure 5. Current-Gain — Bandwidth Product

Amplifier Transistor

NPN Silicon



MPSL01



CASE 29-04, STYLE 1
TO-92 (TO-226AA)

MAXIMUM RATINGS

Rating	Symbol	Value	Unit
Collector–Emitter Voltage	V_{CEO}	120	Vdc
Collector–Base Voltage	V_{CBO}	140	Vdc
Emitter–Base Voltage	V_{EBO}	5.0	Vdc
Collector Current — Continuous	I_C	150	mAdc
Total Device Dissipation @ $T_A = 25^\circ\text{C}$ Derate above 25°C	P_D	625 5.0	mW mW/ $^\circ\text{C}$
Total Device Dissipation @ $T_C = 25^\circ\text{C}$ Derate above 25°C	P_D	1.5 12	Watts mW/ $^\circ\text{C}$
Operating and Storage Junction Temperature Range	T_J, T_{stg}	-55 to +150	$^\circ\text{C}$

THERMAL CHARACTERISTICS

Characteristic	Symbol	Max	Unit
Thermal Resistance, Junction to Ambient	$R_{\theta JA}$	200	$^\circ\text{C}/\text{W}$
Thermal Resistance, Junction to Case	$R_{\theta JC}$	83.3	$^\circ\text{C}/\text{W}$

ELECTRICAL CHARACTERISTICS ($T_A = 25^\circ\text{C}$ unless otherwise noted)

Characteristic	Symbol	Min	Max	Unit
----------------	--------	-----	-----	------

OFF CHARACTERISTICS

Collector–Emitter Breakdown Voltage ⁽¹⁾ ($I_C = 1.0$ mAdc, $I_B = 0$)	$V_{(BR)CEO}$	120	—	Vdc
Collector–Base Breakdown Voltage ($I_C = 100$ μAdc , $I_E = 0$)	$V_{(BR)CBO}$	140	—	Vdc
Emitter–Base Breakdown Voltage ($I_E = 10$ μAdc , $I_C = 0$)	$V_{(BR)EBO}$	5.0	—	Vdc
Collector Cutoff Current ($V_{CB} = 75$ Vdc, $I_E = 0$)	I_{CBO}	—	1.0	μAdc
Emitter Cutoff Current ($V_{EB} = 4.0$ Vdc, $I_C = 0$)	I_{EBO}	—	100	nAdc

1. Pulse Test: Pulse Width = 300 μs , Duty Cycle = 2.0%.

ELECTRICAL CHARACTERISTICS ($T_A = 25^\circ\text{C}$ unless otherwise noted) (Continued)

Characteristic	Symbol	Min	Max	Unit
ON CHARACTERISTICS				
DC Current Gain ⁽¹⁾ ($I_C = 10\text{ mAdc}$, $V_{CE} = 5.0\text{ Vdc}$)	h_{FE}	50	300	—
Collector–Emitter Saturation Voltage ($I_C = 10\text{ mAdc}$, $I_B = 1.0\text{ mAdc}$) ($I_C = 50\text{ mAdc}$, $I_B = 5.0\text{ mAdc}$)	$V_{CE(sat)}$	— —	0.20 0.30	Vdc
Base–Emitter Saturation Voltage ($I_C = 10\text{ mAdc}$, $I_B = 1.0\text{ mAdc}$) ($I_C = 50\text{ mAdc}$, $I_B = 5.0\text{ mAdc}$) ⁽¹⁾	$V_{BE(sat)}$	— —	1.2 1.4	Vdc
SMALL–SIGNAL CHARACTERISTICS				
Current–Gain — Bandwidth Product ⁽¹⁾ ($I_C = 10\text{ mAdc}$, $V_{CE} = 10\text{ Vdc}$, $f = 20\text{ MHz}$)	f_T	60	—	MHz
Collector–Base Capacitance ($V_{CB} = 10\text{ Vdc}$, $I_E = 0$, $f = 1.0\text{ MHz}$)	C_{cb}	—	8.0	pF
Small–Signal Current Gain ($I_C = 1.0\text{ mAdc}$, $V_{CE} = 10\text{ Vdc}$, $f = 1.0\text{ kHz}$)	h_{fe}	30	—	—

1. Pulse Test: Pulse Width = 300 μs , Duty Cycle = 2.0%.

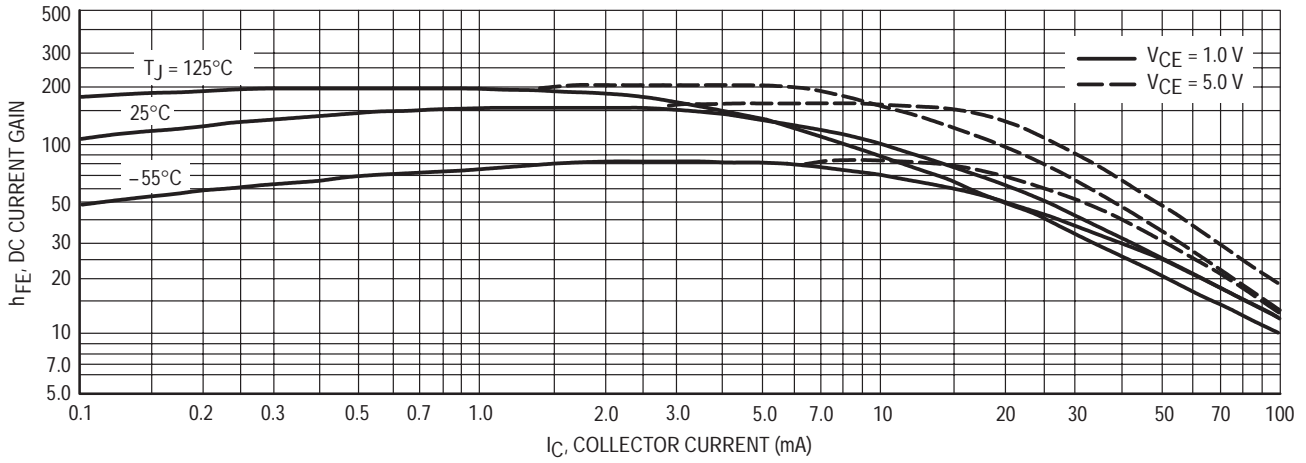


Figure 1. DC Current Gain

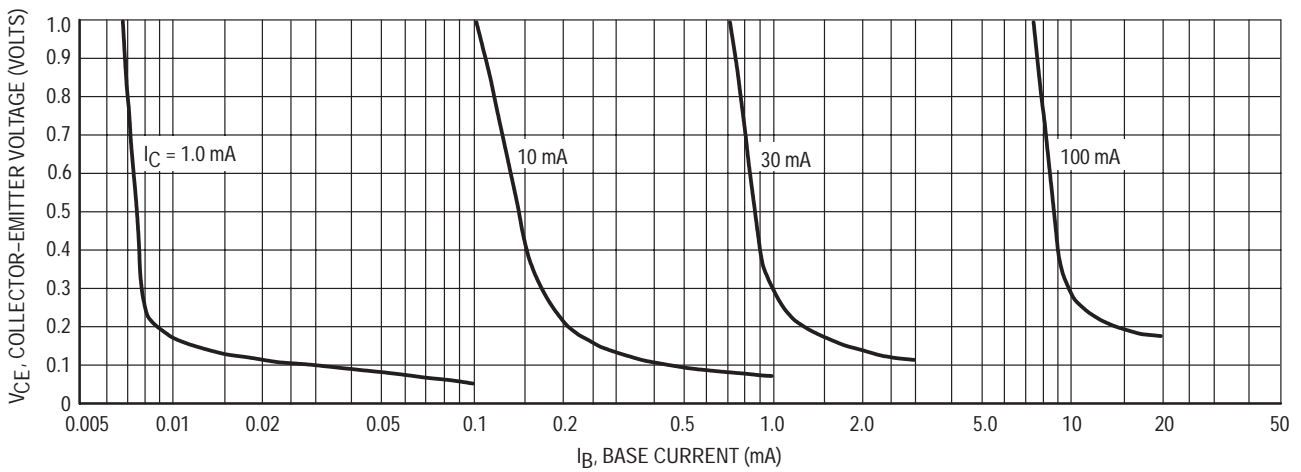


Figure 2. Collector Saturation Region

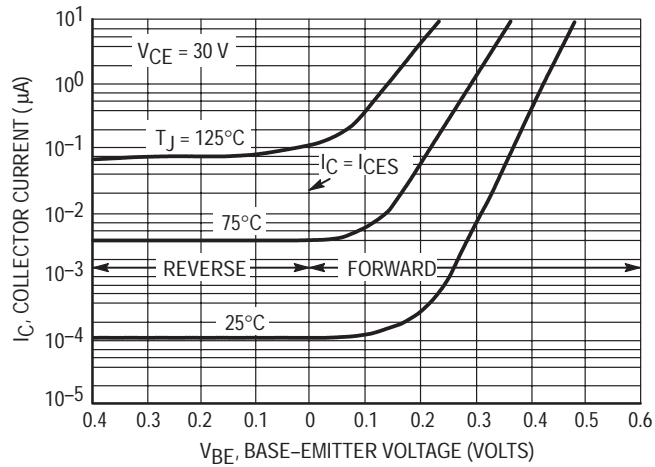


Figure 3. Collector Cut-Off Region

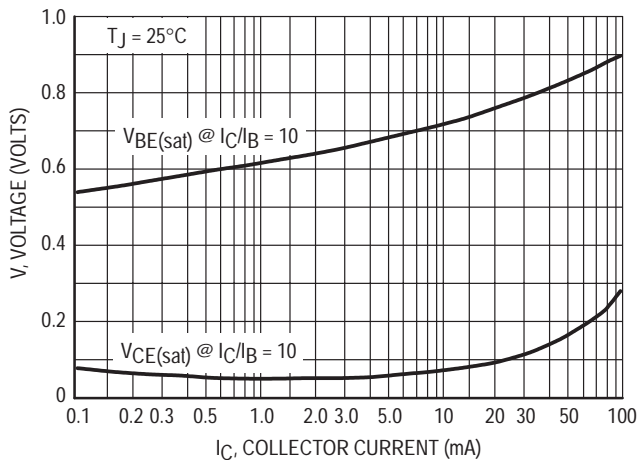


Figure 4. "On" Voltages

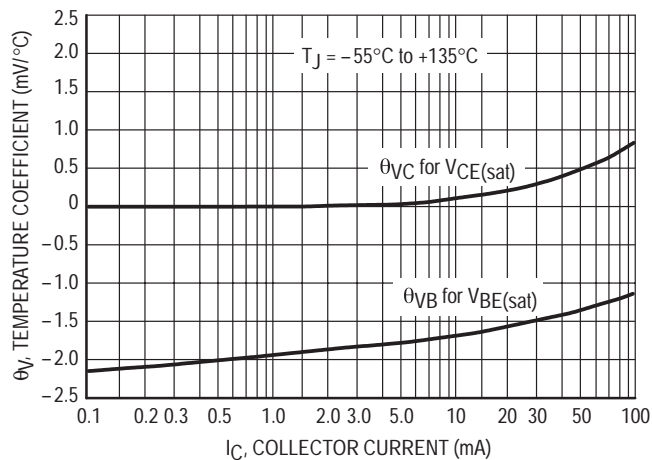
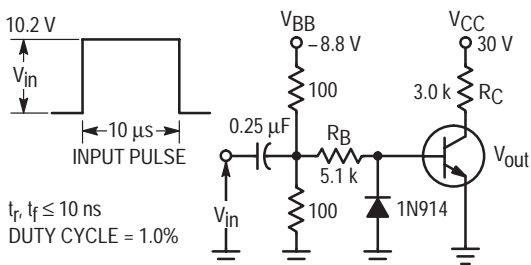


Figure 5. Temperature Coefficients



Values Shown are for $I_C @ 10 \text{ mA}$

Figure 6. Switching Time Test Circuit

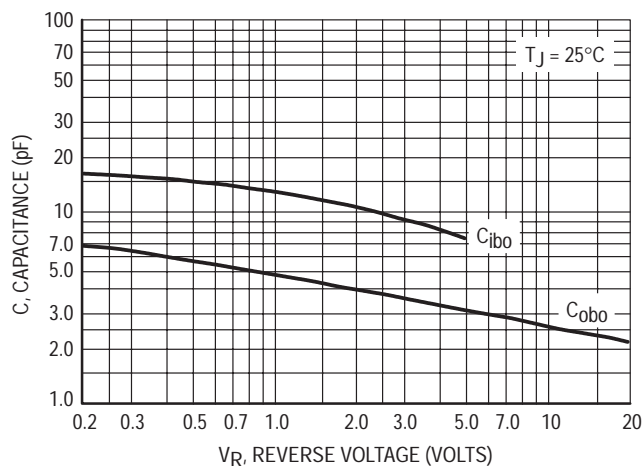


Figure 7. Capacitances

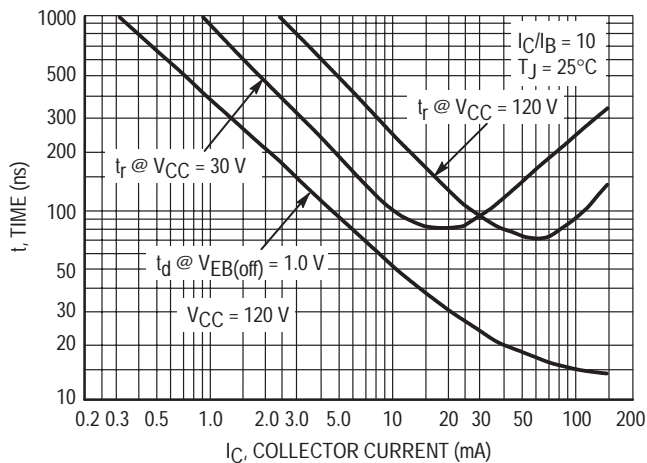


Figure 8. Turn-On Time

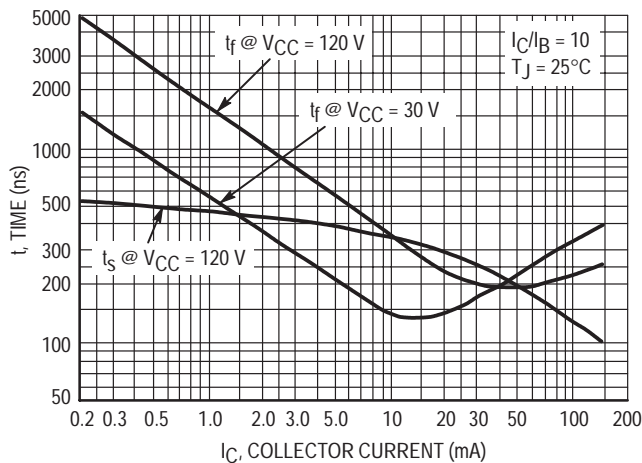
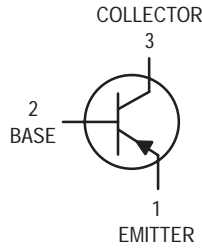


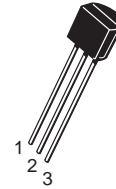
Figure 9. Turn-Off Time

Amplifier Transistor

PNP Silicon



MPSL51



CASE 29-04, STYLE 1
TO-92 (TO-226AA)

MAXIMUM RATINGS

Rating	Symbol	Value	Unit
Collector–Emitter Voltage	V_{CEO}	–100	Vdc
Collector–Base Voltage	V_{CBO}	–100	Vdc
Emitter–Base Voltage	V_{EBO}	–4.0	Vdc
Collector Current — Continuous	I_C	–600	mAdc
Total Device Dissipation @ $T_A = 25^\circ\text{C}$ Derate above 25°C	P_D	625 5.0	mW mW/ $^\circ\text{C}$
Total Device Dissipation @ $T_C = 25^\circ\text{C}$ Derate above 25°C	P_D	1.5 12	Watts mW/ $^\circ\text{C}$
Operating and Storage Junction Temperature Range	T_J, T_{stg}	–55 to +150	$^\circ\text{C}$

THERMAL CHARACTERISTICS

Characteristic	Symbol	Max	Unit
Thermal Resistance, Junction to Ambient	$R_{\theta JA}$	200	$^\circ\text{C}/\text{W}$
Thermal Resistance, Junction to Case	$R_{\theta JC}$	83.3	$^\circ\text{C}/\text{W}$

ELECTRICAL CHARACTERISTICS ($T_A = 25^\circ\text{C}$ unless otherwise noted)

Characteristic	Symbol	Min	Max	Unit
----------------	--------	-----	-----	------

OFF CHARACTERISTICS

Collector–Emitter Breakdown Voltage ⁽¹⁾ ($I_C = -1.0$ mAdc, $I_B = 0$)	$V_{(BR)CEO}$	–100	—	Vdc
Collector–Base Breakdown Voltage ($I_C = -100$ μAdc , $I_E = 0$)	$V_{(BR)CBO}$	–100	—	Vdc
Emitter–Base Breakdown Voltage ($I_E = -10$ μAdc , $I_C = 0$)	$V_{(BR)EBO}$	–4.0	—	Vdc
Collector Cutoff Current ($V_{CB} = -50$ Vdc, $I_E = 0$)	I_{CBO}	—	–1.0	μAdc
Emitter Cutoff Current ($V_{EB} = -3.0$ Vdc, $I_C = 0$)	I_{EBO}	—	–100	nAdc

1. Pulse Test: Pulse Width = 300 μs , Duty Cycle = 2.0%.

ELECTRICAL CHARACTERISTICS ($T_A = 25^\circ\text{C}$ unless otherwise noted) (Continued)

Characteristic	Symbol	Min	Max	Unit
ON CHARACTERISTICS(1)				
DC Current Gain ⁽¹⁾ ($I_C = -50\text{ mAdc}$, $V_{CE} = -5.0\text{ Vdc}$)	h_{FE}	40	250	—
Collector–Emitter Saturation Voltage ($I_C = -10\text{ mAdc}$, $I_B = -1.0\text{ mAdc}$) ($I_C = -50\text{ mAdc}$, $I_B = -5.0\text{ mAdc}$)	$V_{CE(sat)}$	— —	-0.25 -0.30	Vdc
Base–Emitter Saturation Voltage ($I_C = -10\text{ mAdc}$, $I_B = -1.0\text{ mAdc}$) ($I_C = -50\text{ mAdc}$, $I_B = -5.0\text{ mAdc}$)	$V_{BE(sat)}$	— —	-1.2 -1.2	Vdc
SMALL–SIGNAL CHARACTERISTICS				
Current–Gain — Bandwidth Product ($I_C = -10\text{ mAdc}$, $V_{CE} = -10\text{ Vdc}$, $f = 20\text{ MHz}$)	f_T	60	—	MHz
Output Capacitance ($V_{CB} = -10\text{ Vdc}$, $I_E = 0$, $f = 1.0\text{ MHz}$)	C_{obo}	—	8.0	pF
Small–Signal Current Gain ($I_C = -1.0\text{ mAdc}$, $V_{CE} = -10\text{ Vdc}$, $f = 1.0\text{ kHz}$)	h_{fe}	20	—	—

1. Pulse Test: Pulse Width = 300 μs , Duty Cycle = 2.0%.

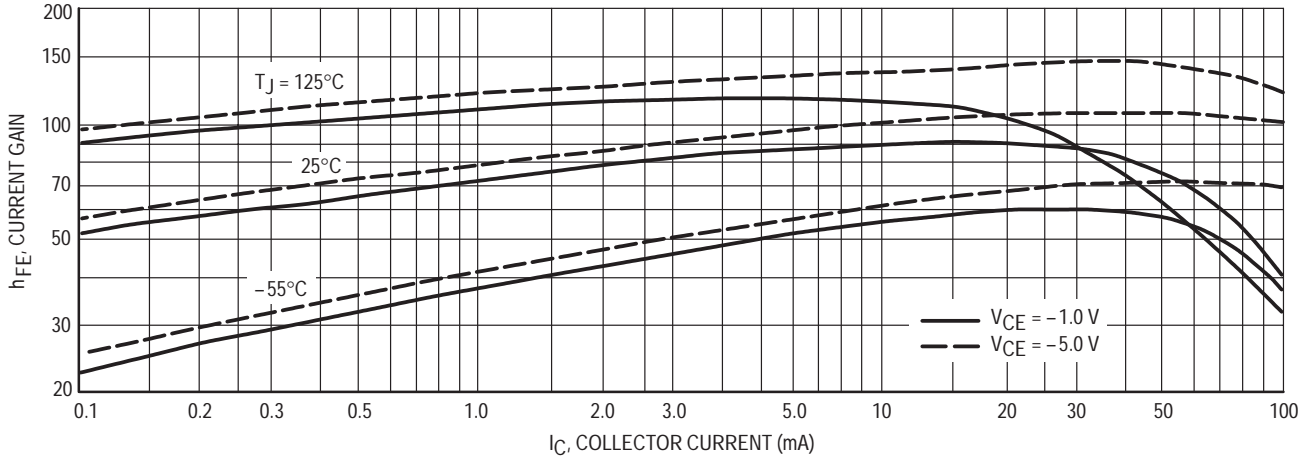


Figure 1. DC Current Gain

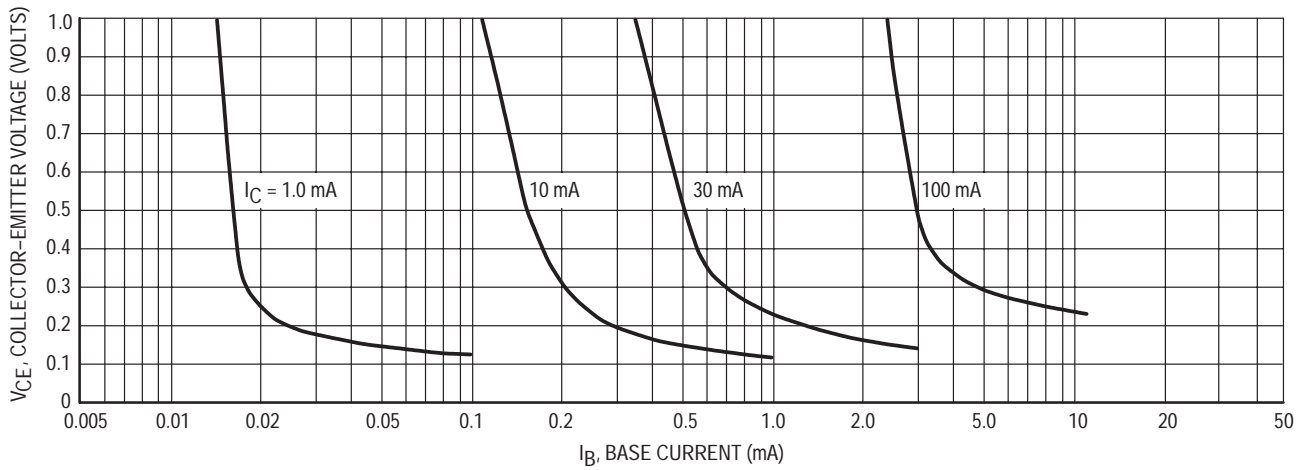


Figure 2. Collector Saturation Region

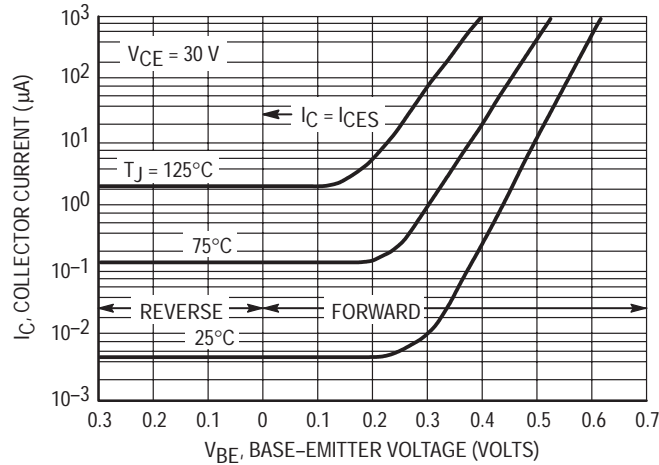


Figure 3. Collector Cut-Off Region

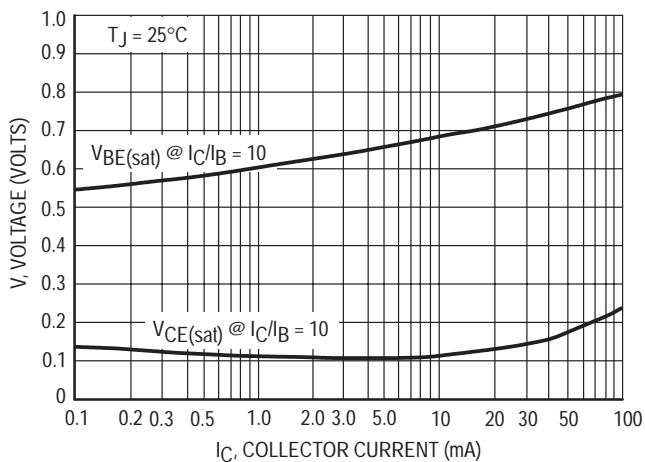


Figure 4. "On" Voltages

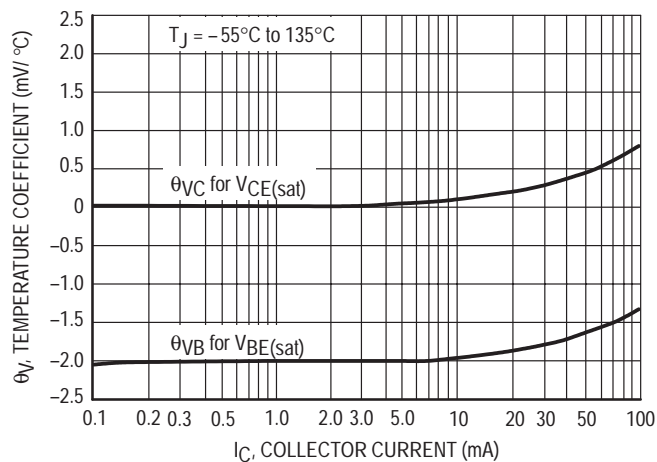


Figure 5. Temperature Coefficients

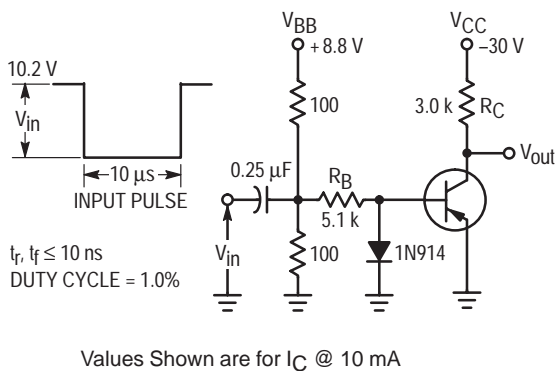


Figure 6. Switching Time Test Circuit

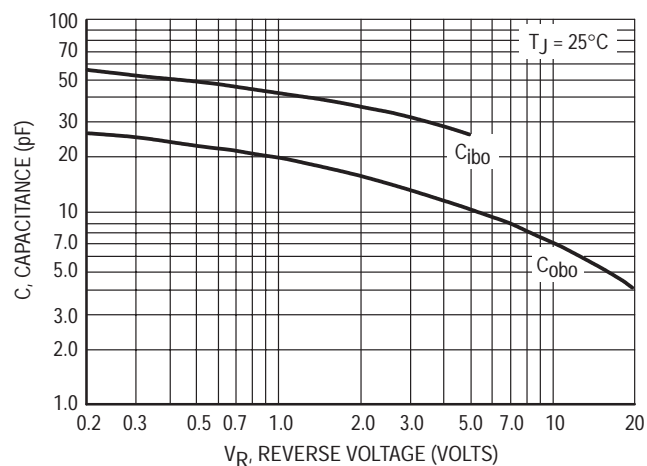


Figure 7. Capacitances

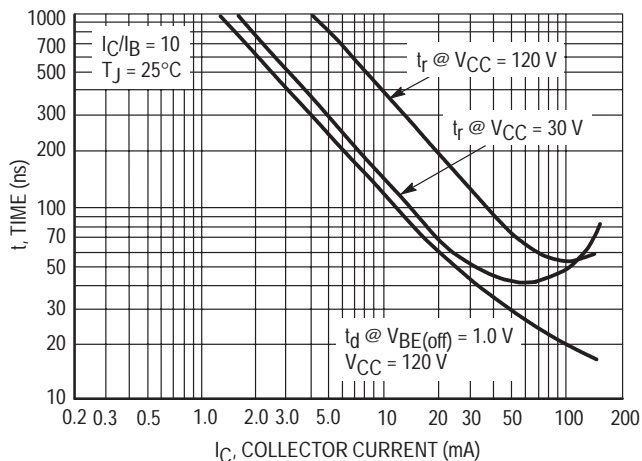


Figure 8. Turn-On Time

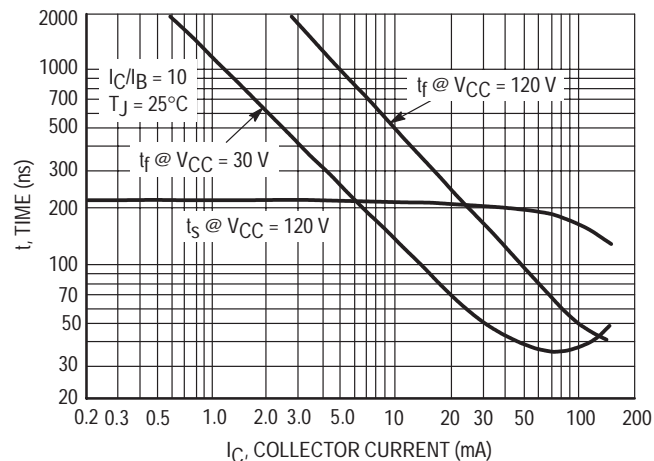
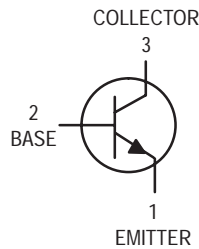


Figure 9. Turn-Off Time

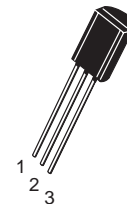
One Watt High Current Transistors

NPN Silicon



MPSW01
MPSW01A*

*Motorola Preferred Device



CASE 29-05, STYLE 1
TO-92 (TO-226AE)

MAXIMUM RATINGS

Rating	Symbol	Value	Unit
Collector–Emitter Voltage MPSW01 MPSW01A	V_{CEO}	30 40	Vdc
Collector–Base Voltage MPSW01 MPSW01A	V_{CBO}	40 50	Vdc
Emitter–Base Voltage	V_{EBO}	5.0	Vdc
Collector Current — Continuous	I_C	1000	mAdc
Total Device Dissipation @ $T_A = 25^\circ\text{C}$ Derate above 25°C	P_D	1.0 8.0	Watts mW/ $^\circ\text{C}$
Total Device Dissipation @ $T_C = 25^\circ\text{C}$ Derate above 25°C	P_D	2.5 20	Watts mW/ $^\circ\text{C}$
Operating and Storage Junction Temperature Range	T_J, T_{stg}	-55 to +150	$^\circ\text{C}$

THERMAL CHARACTERISTICS

Characteristic	Symbol	Max	Unit
Thermal Resistance, Junction to Ambient	$R_{\theta JA}$	125	$^\circ\text{C}/\text{W}$
Thermal Resistance, Junction to Case	$R_{\theta JC}$	50	$^\circ\text{C}/\text{W}$

ELECTRICAL CHARACTERISTICS ($T_A = 25^\circ\text{C}$ unless otherwise noted)

Characteristic	Symbol	Min	Max	Unit
----------------	--------	-----	-----	------

OFF CHARACTERISTICS

Collector–Emitter Breakdown Voltage ⁽¹⁾ ($I_C = 10 \text{ mAdc}, I_E = 0$)	MPSW01 MPSW01A	$V_{(BR)CEO}$	30 40	— —	Vdc
Collector–Base Breakdown Voltage ($I_C = 100 \mu\text{Adc}, I_E = 0$)	MPSW01 MPSW01A	$V_{(BR)CBO}$	40 50	— —	Vdc
Emitter–Base Breakdown Voltage ($I_E = 100 \mu\text{Adc}, I_C = 0$)		$V_{(BR)EBO}$	5.0	—	Vdc
Collector Cutoff Current ($V_{CB} = 30 \text{ Vdc}, I_E = 0$) ($V_{CB} = 40 \text{ Vdc}, I_E = 0$)	MPSW01 MPSW01A	I_{CBO}	— —	0.1 0.1	μAdc
Emitter Cutoff Current ($V_{EB} = 3.0 \text{ Vdc}, I_C = 0$)		I_{EBO}	—	0.1	μAdc

1. Pulse Test: Pulse Width $\leq 300 \mu\text{s}$, Duty Cycle $\leq 2.0\%$.

Preferred devices are Motorola recommended choices for future use and best overall value.

ELECTRICAL CHARACTERISTICS ($T_A = 25^\circ\text{C}$ unless otherwise noted) (Continued)

Characteristic	Symbol	Min	Max	Unit
ON CHARACTERISTICS(1)				
DC Current Gain ($I_C = 10\text{ mAdc}$, $V_{CE} = 1.0\text{ Vdc}$) ($I_C = 100\text{ mAdc}$, $V_{CE} = 1.0\text{ Vdc}$) ($I_C = 1000\text{ mAdc}$, $V_{CE} = 1.0\text{ Vdc}$)	h_{FE}	55 60 50	— — —	—
Collector–Emitter Saturation Voltage ($I_C = 1000\text{ mAdc}$, $I_B = 100\text{ mAdc}$)	$V_{CE(sat)}$	—	0.5	Vdc
Base–Emitter On Voltage ($I_C = 1000\text{ mAdc}$, $V_{CE} = 1.0\text{ Vdc}$)	$V_{BE(on)}$	—	1.2	Vdc

SMALL–SIGNAL CHARACTERISTICS

Current–Gain — Bandwidth Product ($I_C = 50\text{ mAdc}$, $V_{CE} = 10\text{ Vdc}$, $f = 20\text{ MHz}$)	f_T	50	—	MHz
Output Capacitance ($V_{CB} = 10\text{ Vdc}$, $I_E = 0$, $f = 1.0\text{ MHz}$)	C_{obo}	—	20	pF

1. Pulse Test: Pulse Width $\leq 300\ \mu\text{s}$, Duty Cycle $\leq 2.0\%$.

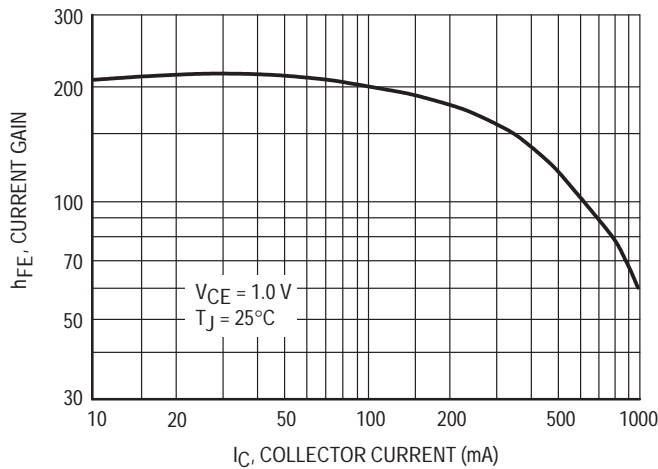


Figure 1. DC Current Gain

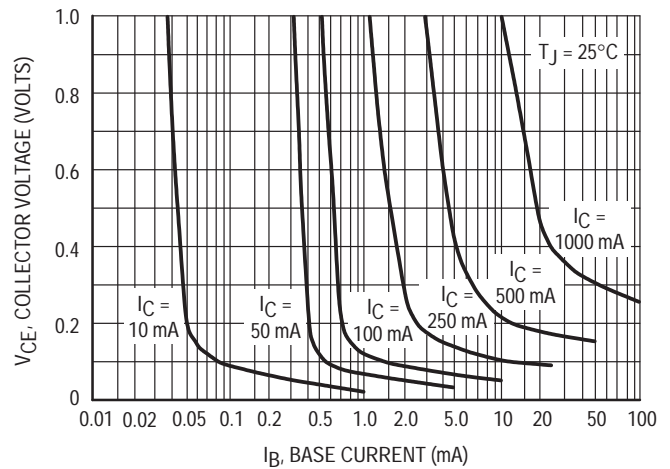


Figure 2. Collector Saturation Region

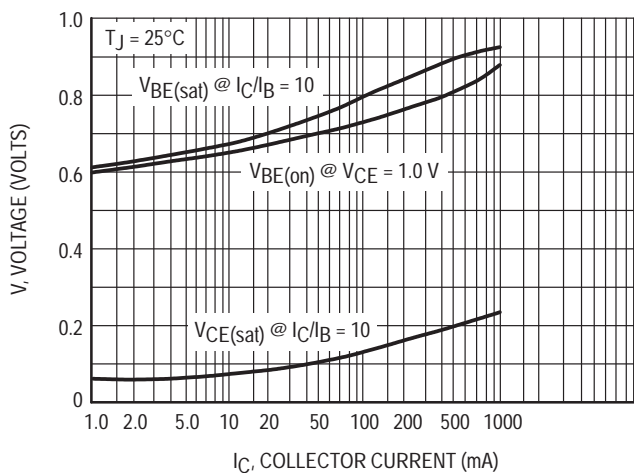


Figure 3. "ON" Voltages

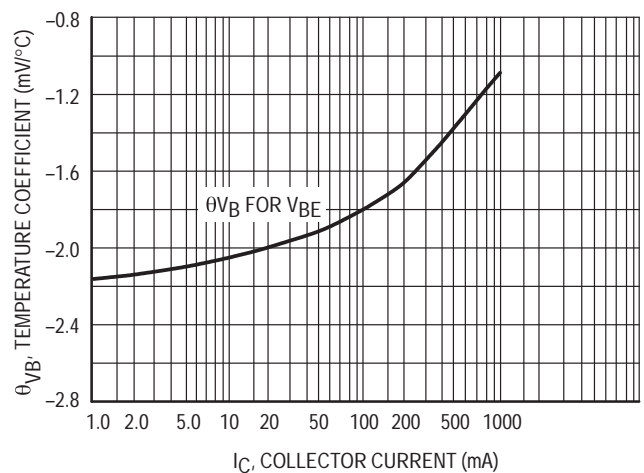


Figure 4. Temperature Coefficient

MPSW01 MPSW01A

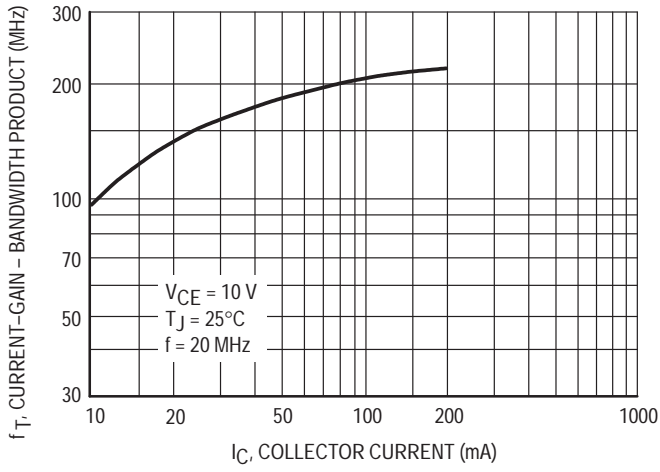


Figure 5. Current Gain — Bandwidth Product

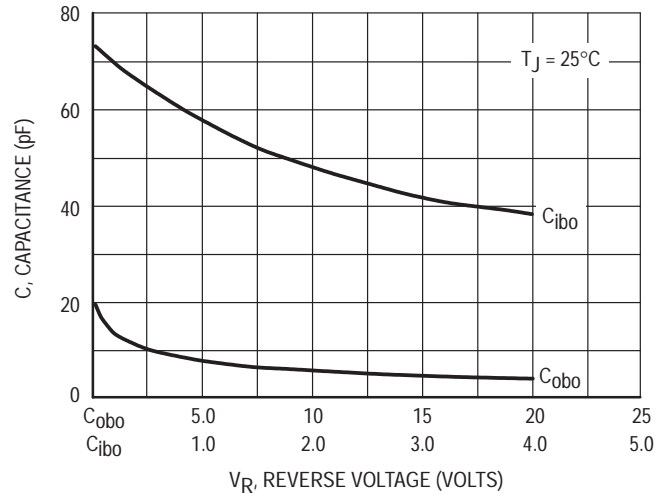


Figure 6. Capacitance

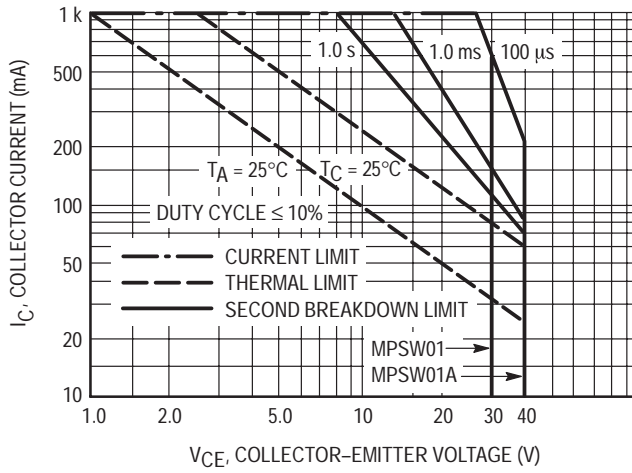


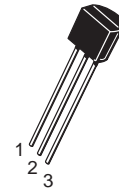
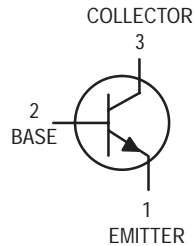
Figure 7. Active Region — Safe Operating Area

One Watt Amplifier Transistors

NPN Silicon

MPSW05
MPSW06*

*Motorola Preferred Device



CASE 29-05, STYLE 1
TO-92 (TO-226AE)

MAXIMUM RATINGS

Rating	Symbol	MPSW05	MPSW06	Unit
Collector–Emitter Voltage	V_{CEO}	60	80	Vdc
Collector–Base Voltage	V_{CBO}	60	80	Vdc
Emitter–Base Voltage	V_{EBO}	4.0		Vdc
Collector Current — Continuous	I_C	500		mAdc
Total Device Dissipation @ $T_A = 25^\circ\text{C}$ Derate above 25°C	P_D	1.0	8.0	Watt mW/ $^\circ\text{C}$
Total Device Dissipation @ $T_C = 25^\circ\text{C}$ Derate above 25°C	P_D	2.5	20	Watts mW/ $^\circ\text{C}$
Operating and Storage Junction Temperature Range	T_J, T_{stg}	–55 to +150		$^\circ\text{C}$

THERMAL CHARACTERISTICS

Characteristic	Symbol	Max	Unit
Thermal Resistance, Junction to Ambient	$R_{\theta JA}$	125	$^\circ\text{C}/\text{W}$
Thermal Resistance, Junction to Case	$R_{\theta JC}$	50	$^\circ\text{C}/\text{W}$

ELECTRICAL CHARACTERISTICS ($T_A = 25^\circ\text{C}$ unless otherwise noted)

Characteristic	Symbol	Min	Max	Unit
----------------	--------	-----	-----	------

OFF CHARACTERISTICS

Collector–Emitter Breakdown Voltage ⁽¹⁾ ($I_C = 1.0 \text{ mAdc}, I_B = 0$)	MPSW05 MPSW06	$V_{(BR)CEO}$	60 80	—	Vdc
Emitter–Base Breakdown Voltage ($I_E = 100 \mu\text{Adc}, I_C = 0$)		$V_{(BR)EBO}$	4.0	—	Vdc
Collector Cutoff Current ($V_{CE} = 40 \text{ Vdc}, I_B = 0$) ($V_{CE} = 60 \text{ Vdc}, I_B = 0$)	MPSW05 MPSW06	I_{CES}	— —	0.5 0.5	μAdc
Collector Cutoff Current ($V_{CB} = 40 \text{ Vdc}, I_E = 0$) ($V_{CB} = 60 \text{ Vdc}, I_E = 0$)	MPSW05 MPSW06	I_{CBO}	— —	0.1 0.1	μAdc
Emitter Cutoff Current ($V_{EB} = 3.0 \text{ Vdc}, I_C = 0$)		I_{EBO}	—	0.1	μAdc

1. Pulse Test: Pulse Width $\leq 300 \mu\text{s}$, Duty Cycle $\leq 2.0\%$.

Preferred devices are Motorola recommended choices for future use and best overall value.

MPSW05 MPSW06

ELECTRICAL CHARACTERISTICS (T_A = 25°C unless otherwise noted) (Continued)

Characteristic	Symbol	Min	Max	Unit
ON CHARACTERISTICS(1)				
DC Current Gain (I _C = 50 mAdc, V _{CE} = 1.0 Vdc) (I _C = 250 mAdc, V _{CE} = 1.0 Vdc)	h _{FE}	80 60	— —	—
Collector–Emitter Saturation Voltage (I _C = 250 mAdc, I _B = 10 mAdc)	V _{CE(sat)}	—	0.4	Vdc
Base–Emitter Saturation Voltage (I _C = 250 mAdc, V _{CE} = 5.0 Vdc)	V _{BE(sat)}	—	1.2	Vdc
SMALL–SIGNAL CHARACTERISTICS				
Current–Gain — Bandwidth Product (I _C = 200 mAdc, V _{CE} = 5.0 Vdc, f = 20 MHz)	f _T	50	—	MHz
Output Capacitance (V _{CB} = 10 V, f = 1.0 MHz)	C _{obo}	—	12	pF

1. Pulse Test: Pulse Width ≤ 300 μs, Duty Cycle ≤ 2.0%.

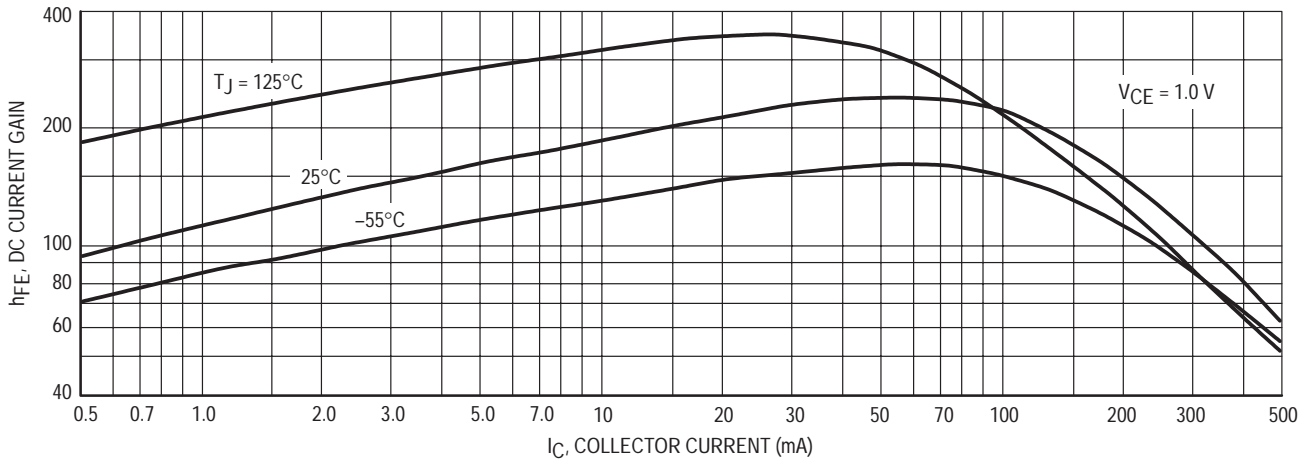


Figure 1. DC Current Gain

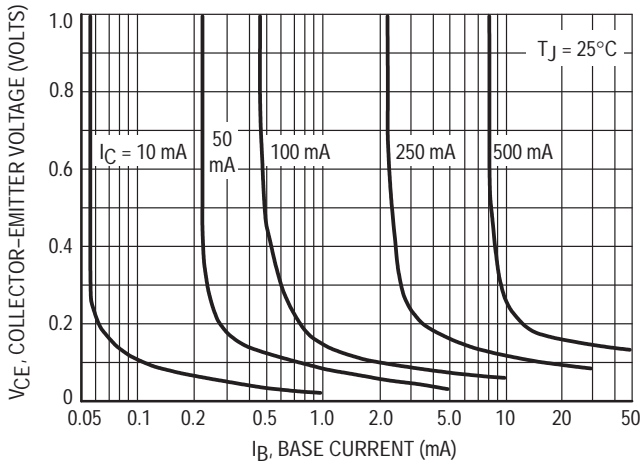


Figure 2. Collector Saturation Region

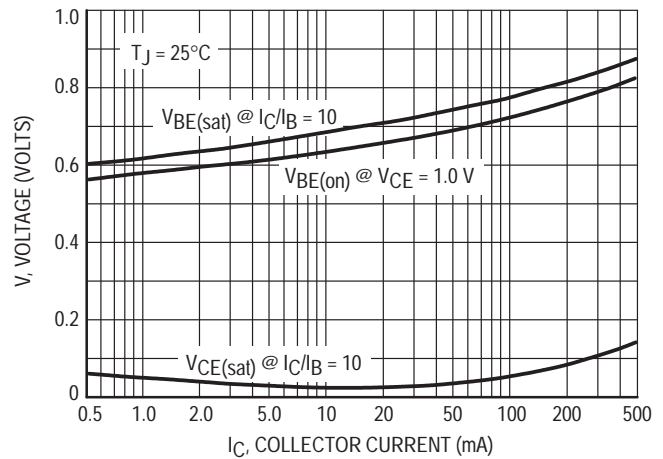


Figure 3. "On" Voltages

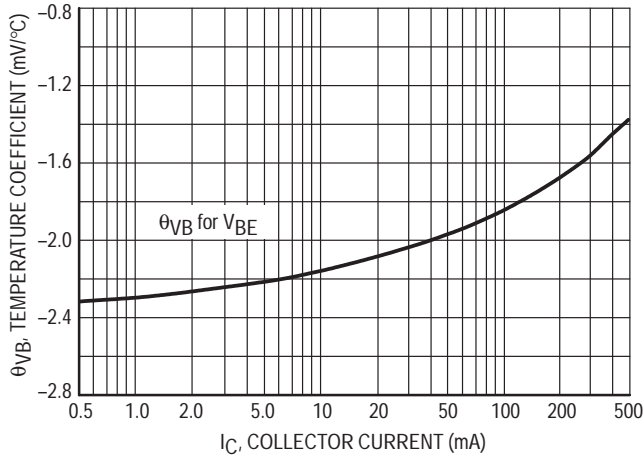


Figure 4. Base-Emitter Temperature Coefficient

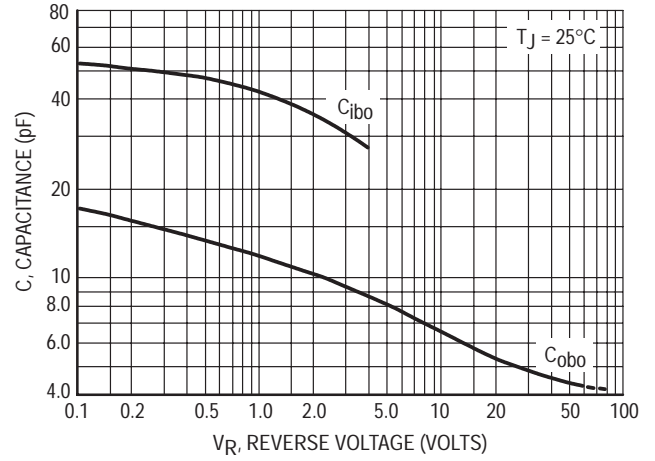


Figure 5. Capacitance

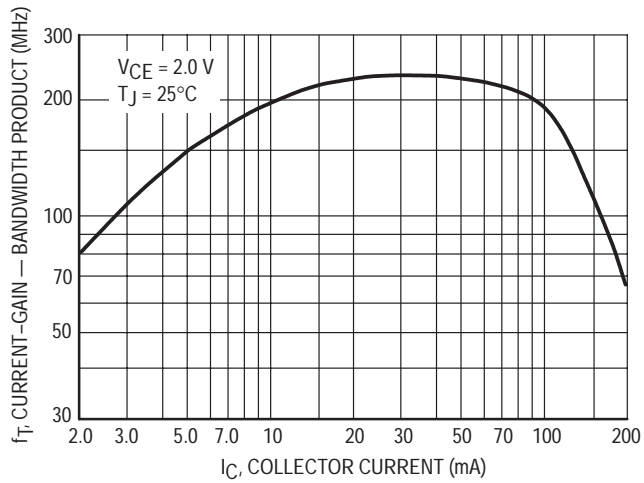


Figure 6. Current-Gain — Bandwidth Product

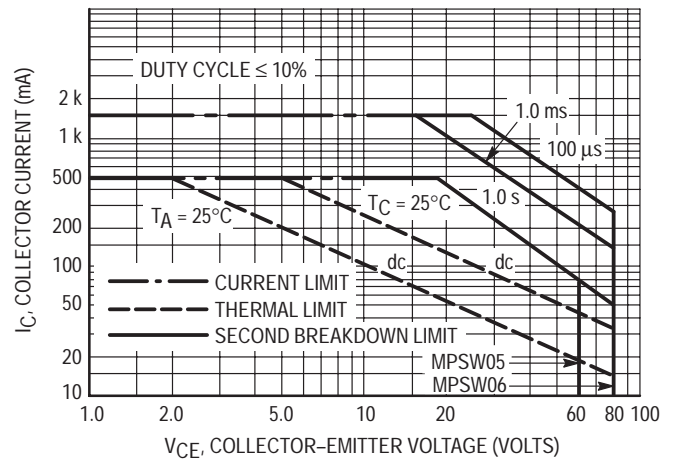
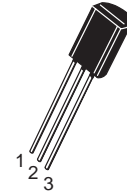
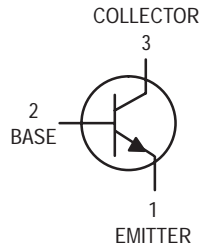


Figure 7. Active Region — Safe Operating Area

One Watt High Voltage Transistor

NPN Silicon

MPSW10



CASE 29-05, STYLE 1
TO-92 (TO-226AE)

MAXIMUM RATINGS

Rating	Symbol	Value	Unit
Collector–Emitter Voltage	V_{CEO}	300	Vdc
Collector–Base Voltage	V_{CBO}	300	Vdc
Emitter–Base Voltage	V_{EBO}	6.0	Vdc
Collector Current — Continuous	I_C	500	mAdc
Total Device Dissipation @ $T_A = 25^\circ\text{C}$ Derate above 25°C	P_D	1.0 8.0	Watt mW/ $^\circ\text{C}$
Total Device Dissipation @ $T_C = 25^\circ\text{C}$ Derate above 25°C	P_D	2.5 20	Watts mW/ $^\circ\text{C}$
Operating and Storage Junction Temperature Range	T_J, T_{stg}	-55 to +150	$^\circ\text{C}$

THERMAL CHARACTERISTICS

Characteristic	Symbol	Max	Unit
Thermal Resistance, Junction to Ambient	$R_{\theta JA}$	125	$^\circ\text{C}/\text{W}$
Thermal Resistance, Junction to Case	$R_{\theta JC}$	50	$^\circ\text{C}/\text{W}$

ELECTRICAL CHARACTERISTICS ($T_A = 25^\circ\text{C}$ unless otherwise noted)

Characteristic	Symbol	Min	Max	Unit
----------------	--------	-----	-----	------

OFF CHARACTERISTICS

Collector–Emitter Breakdown Voltage ⁽¹⁾ ($I_C = 1.0 \text{ mAdc}, I_B = 0$)	$V_{(BR)CEO}$	300	—	Vdc
Collector–Base Breakdown Voltage ($I_C = 100 \mu\text{Adc}, I_E = 0$)	$V_{(BR)CBO}$	300	—	Vdc
Emitter–Base Breakdown Voltage ($I_E = 100 \mu\text{Adc}, I_C = 0$)	$V_{(BR)EBO}$	6.0	—	Vdc
Collector Cutoff Current ($V_{CB} = 200 \text{ Vdc}, I_E = 0$)	I_{CBO}	—	0.2	μAdc
Emitter Cutoff Current ($V_{EB} = 6.0 \text{ Vdc}, I_C = 0$)	I_{EBO}	—	0.1	μAdc

1. Pulse Test: Pulse Width $\leq 300 \mu\text{s}$, Duty Cycle $\leq 2.0\%$.

ELECTRICAL CHARACTERISTICS ($T_A = 25^\circ\text{C}$ unless otherwise noted) (Continued)

Characteristic	Symbol	Min	Max	Unit
ON CHARACTERISTICS(1)				
DC Current Gain ($I_C = 1.0\text{ mA}$, $V_{CE} = 10\text{ Vdc}$) ($I_C = 10\text{ mA}$, $V_{CE} = 10\text{ Vdc}$) ($I_C = 30\text{ mA}$, $V_{CE} = 10\text{ Vdc}$)	h_{FE}	25 40 40	— — —	—
Collector–Emitter Saturation Voltage ($I_C = 30\text{ mA}$, $I_B = 3.0\text{ mA}$)	$V_{CE(sat)}$	—	0.75	Vdc
Base–Emitter On Voltage ($I_C = 30\text{ mA}$, $V_{CE} = 10\text{ Vdc}$)	$V_{BE(on)}$	—	0.85	Vdc
SMALL–SIGNAL CHARACTERISTICS				
Current–Gain — Bandwidth Product ($I_C = 10\text{ mA}$, $V_{CE} = 20\text{ Vdc}$, $f = 20\text{ MHz}$)	f_T	45	—	MHz
Collector–Base Capacitance ($V_{CB} = 20\text{ Vdc}$, $I_E = 0$, $f = 1.0\text{ MHz}$)	C_{cb}	—	3.0	pF

1. Pulse Test: Pulse Width $\leq 300\ \mu\text{s}$, Duty Cycle $\leq 2.0\%$.

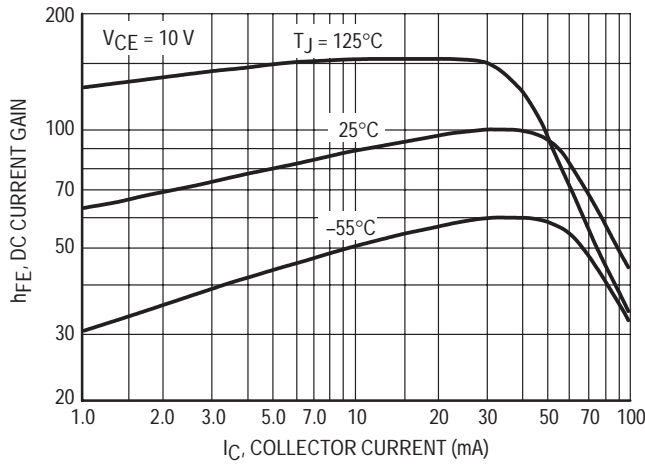


Figure 1. DC Current Gain

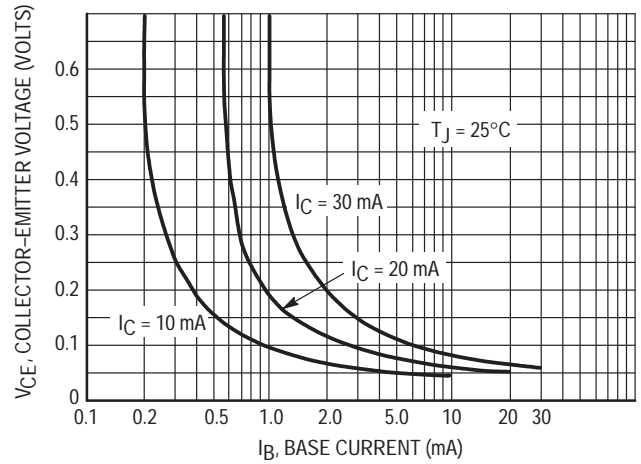


Figure 2. Collector Saturation Region

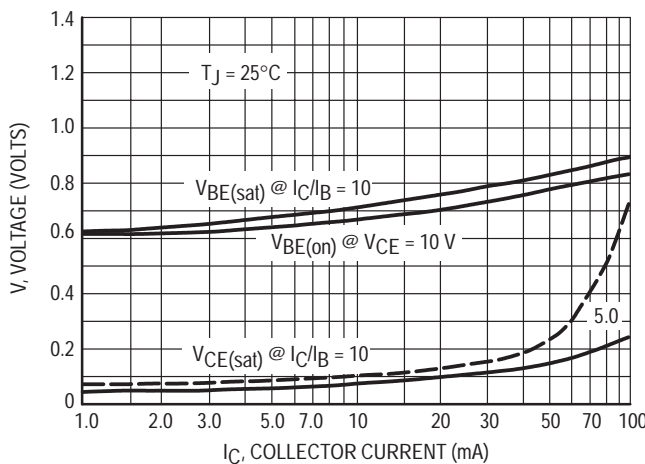


Figure 3. "On" Voltages

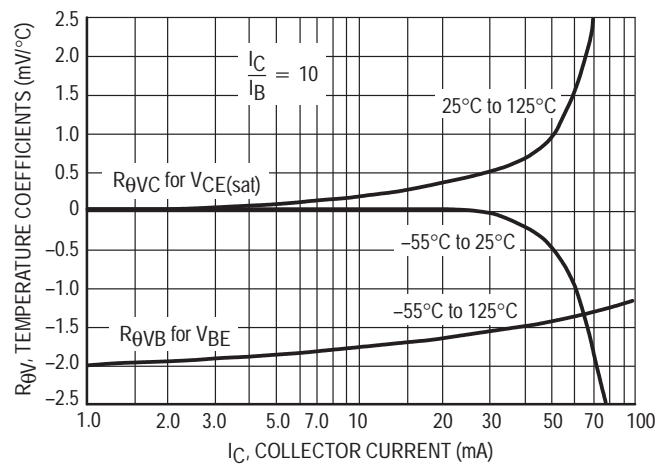


Figure 4. Temperature Coefficients

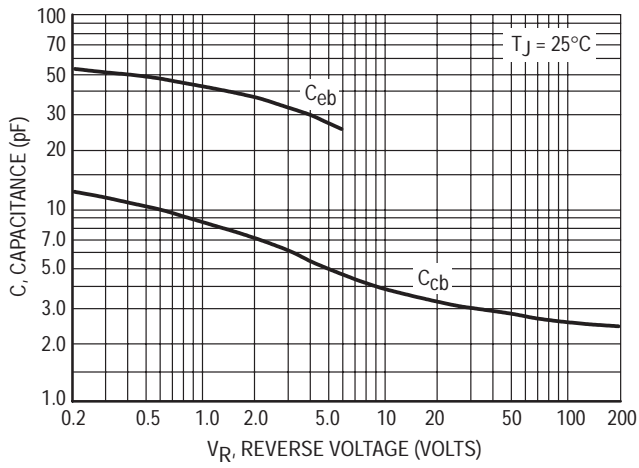


Figure 5. Capacitance

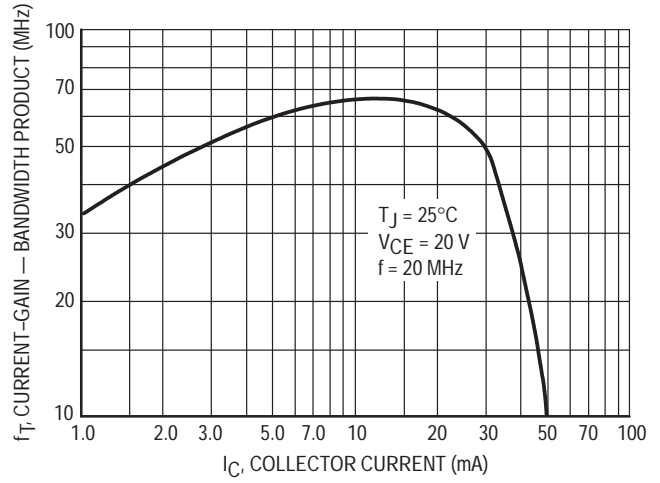


Figure 6. Current-Gain — Bandwidth Product

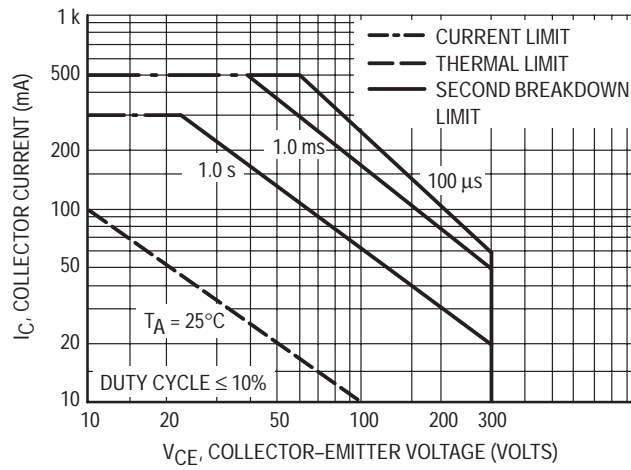
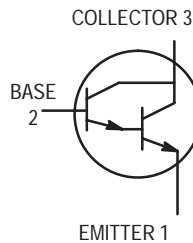


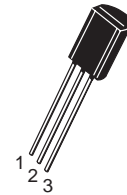
Figure 7. Active Region — Safe Operating Area

One Watt Darlington Transistors

NPN Silicon



MPSW13
MPSW14



CASE 29-05, STYLE 1
TO-92 (TO-226AE)

MAXIMUM RATINGS

Rating	Symbol	Value	Unit
Collector–Emitter Voltage	V_{CES}	30	Vdc
Collector–Base Voltage	V_{CBO}	30	Vdc
Emitter–Base Voltage	V_{EBO}	10	Vdc
Collector Current — Continuous	I_C	1.0	Adc
Total Device Dissipation @ $T_A = 25^\circ\text{C}$ Derate above 25°C	P_D	1.0 8.0	Watts mW/ $^\circ\text{C}$
Total Device Dissipation @ $T_C = 25^\circ\text{C}$ Derate above 25°C	P_D	2.5 20	Watts mW/ $^\circ\text{C}$
Operating and Storage Junction Temperature Range	T_J, T_{stg}	-55 to +150	$^\circ\text{C}$

THERMAL CHARACTERISTICS

Characteristic	Symbol	Max	Unit
Thermal Resistance, Junction to Ambient	$R_{\theta JA}$	125	$^\circ\text{C}/\text{W}$
Thermal Resistance, Junction to Case	$R_{\theta JC}$	50	$^\circ\text{C}/\text{W}$

ELECTRICAL CHARACTERISTICS ($T_A = 25^\circ\text{C}$ unless otherwise noted)

Characteristic	Symbol	Min	Max	Unit
----------------	--------	-----	-----	------

OFF CHARACTERISTICS

Collector–Emitter Breakdown Voltage ($I_C = 100 \mu\text{Adc}$, $V_{BE} = 0$)	$V_{(BR)CES}$	30	—	Vdc
Collector Cutoff Current ($V_{CB} = 30 \text{ Vdc}$, $I_E = 0$)	I_{CBO}	—	100	nAdc
Emitter Cutoff Current ($V_{EB} = 10 \text{ Vdc}$, $I_C = 0$)	I_{EBO}	—	100	nAdc

MPSW13 MPSW14

ELECTRICAL CHARACTERISTICS (T_A = 25°C unless otherwise noted) (Continued)

Characteristic	Symbol	Min	Max	Unit
ON CHARACTERISTICS(1)				
DC Current Gain (I _C = 10 mAdc, V _{CE} = 5.0 Vdc)	MPSW13	5,000	—	—
	MPSW14	10,000	—	—
(I _C = 100 mAdc, V _{CE} = 5.0 Vdc)	MPSW13	10,000	—	—
	MPSW14	20,000	—	—
Collector–Emitter Saturation Voltage (I _C = 100 mAdc, I _B = 0.1 mAdc)	V _{CE(sat)}	—	1.5	Vdc
Base–Emitter On Voltage (I _C = 100 mAdc, V _{CE} = 5.0 Vdc)	V _{BE(on)}	—	2.0	Vdc

SMALL-SIGNAL CHARACTERISTICS

Current–Gain — Bandwidth Product(2) (I _C = 10 mAdc, V _{CE} = 5.0 Vdc, f = 100 MHz)	f _T	125	—	MHz
-----------------------------------------------------------------------------------------------------------	----------------	-----	---	-----

1. Pulse Test: Pulse Width ≤ 300 μs, Duty Cycle ≤ 2.0%.
2. f_T = |h_{fe}| • f_{test}.

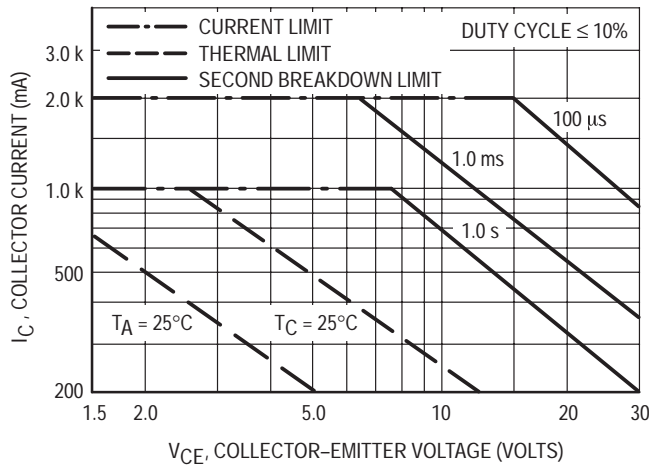


Figure 1. Active Region — Safe Operating Area

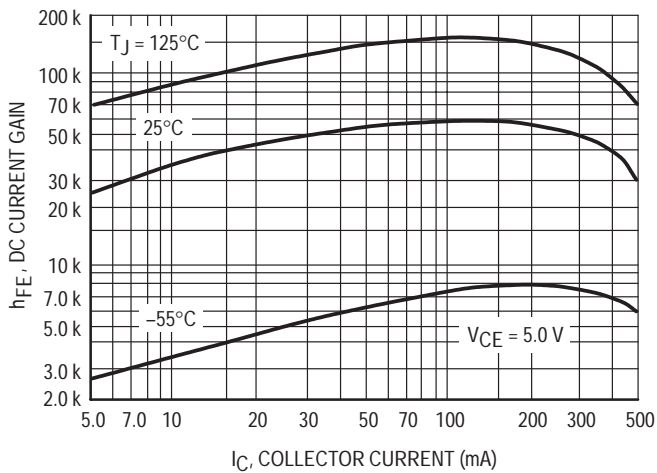


Figure 2. DC Current Gain

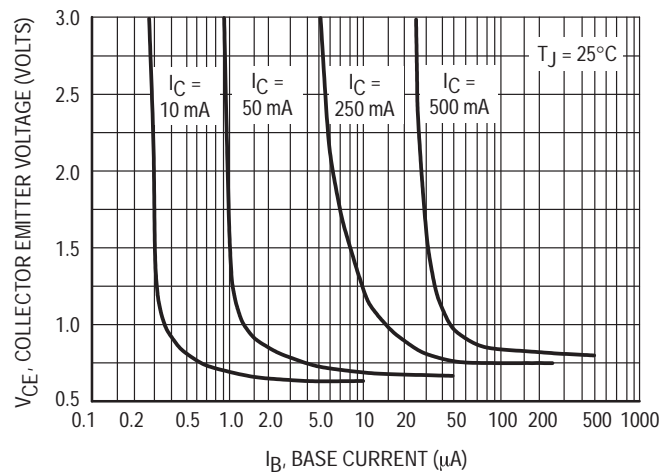


Figure 3. Collector Saturation Region

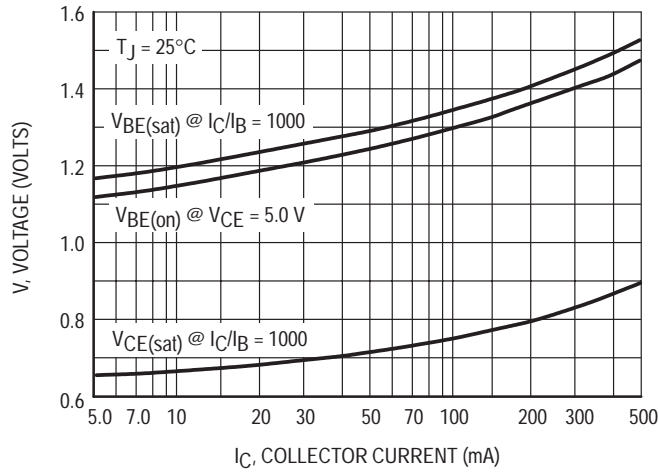


Figure 4. "ON" Voltages

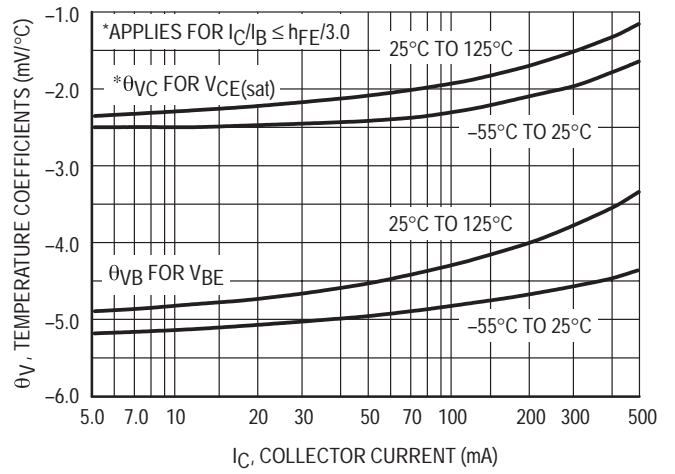


Figure 5. Temperature Coefficients

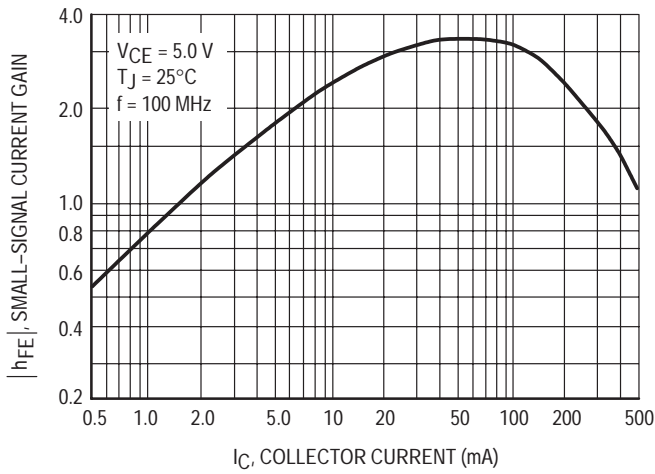


Figure 6. High Frequency Current Gain

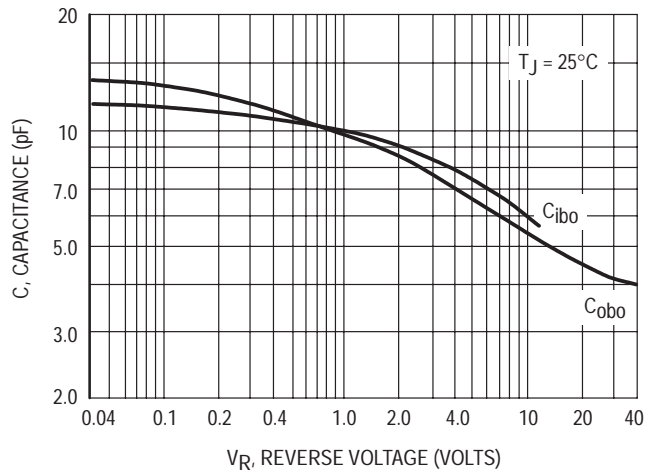


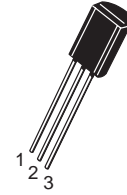
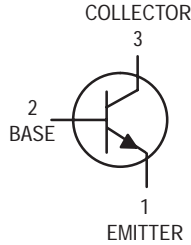
Figure 7. Capacitance

One Watt High Voltage Transistor

NPN Silicon

MPSW42

Motorola Preferred Device



CASE 29-05, STYLE 1
TO-92 (TO-226AE)

MAXIMUM RATINGS

Rating	Symbol	Value	Unit
Collector–Emitter Voltage	V_{CEO}	300	Vdc
Collector–Base Voltage	V_{CBO}	300	Vdc
Emitter–Base Voltage	V_{EBO}	6.0	Vdc
Collector Current — Continuous	I_C	500	mAdc
Total Device Dissipation @ $T_A = 25^\circ\text{C}$ Derate above 25°C	P_D	1.0 8.0	Watt mW/ $^\circ\text{C}$
Total Device Dissipation @ $T_C = 25^\circ\text{C}$ Derate above 25°C	P_D	2.5 20	Watts mW/ $^\circ\text{C}$
Operating and Storage Junction Temperature Range	T_J, T_{stg}	-55 to +150	$^\circ\text{C}$

THERMAL CHARACTERISTICS

Characteristic	Symbol	Max	Unit
Thermal Resistance, Junction to Ambient	$R_{\theta JA}$	125	$^\circ\text{C}/\text{W}$
Thermal Resistance, Junction to Case	$R_{\theta JC}$	50	$^\circ\text{C}/\text{W}$

ELECTRICAL CHARACTERISTICS ($T_A = 25^\circ\text{C}$ unless otherwise noted)

Characteristic	Symbol	Min	Max	Unit
----------------	--------	-----	-----	------

OFF CHARACTERISTICS

Collector–Emitter Breakdown Voltage ⁽¹⁾ ($I_C = 1.0 \text{ mAdc}, I_B = 0$)	$V_{(BR)CEO}$	300	—	Vdc
Collector–Base Breakdown Voltage ($I_C = 100 \mu\text{Adc}, I_E = 0$)	$V_{(BR)CBO}$	300	—	Vdc
Emitter–Base Breakdown Voltage ($I_E = 100 \mu\text{Adc}, I_C = 0$)	$V_{(BR)EBO}$	6.0	—	Vdc
Collector Cutoff Current ($V_{CB} = 200 \text{ Vdc}, I_E = 0$)	I_{CBO}	—	0.1	μAdc
Emitter Cutoff Current ($V_{EB} = 6.0 \text{ Vdc}, I_C = 0$)	I_{EBO}	—	0.1	μAdc

1. Pulse Test: Pulse Width $\leq 300 \mu\text{s}$, Duty Cycle $\leq 2.0\%$.

Preferred devices are Motorola recommended choices for future use and best overall value.

ELECTRICAL CHARACTERISTICS ($T_A = 25^\circ\text{C}$ unless otherwise noted) (Continued)

Characteristic	Symbol	Min	Max	Unit
ON CHARACTERISTICS				
DC Current Gain ($I_C = 1.0\text{ mA}$, $V_{CE} = 10\text{ Vdc}$) ($I_C = 10\text{ mA}$, $V_{CE} = 10\text{ Vdc}$) ($I_C = 30\text{ mA}$, $V_{CE} = 10\text{ Vdc}$)	h_{FE}	25 40 40	— — —	—
Collector–Emitter Saturation Voltage ($I_C = 20\text{ mA}$, $I_B = 2.0\text{ mA}$)	$V_{CE(sat)}$	—	0.5	Vdc
Base–Emitter Saturation Voltage ($I_C = 20\text{ mA}$, $I_B = 2.0\text{ mA}$)	$V_{BE(sat)}$	—	0.9	Vdc
SMALL–SIGNAL CHARACTERISTICS				
Current–Gain — Bandwidth Product ($I_C = 10\text{ mA}$, $V_{CE} = 20\text{ Vdc}$, $f = 20\text{ MHz}$)	f_T	50	—	MHz
Collector Capacitance ($V_{CB} = 20\text{ Vdc}$, $I_E = 0$, $f = 1.0\text{ MHz}$)	C_{cb}	—	3.0	pF

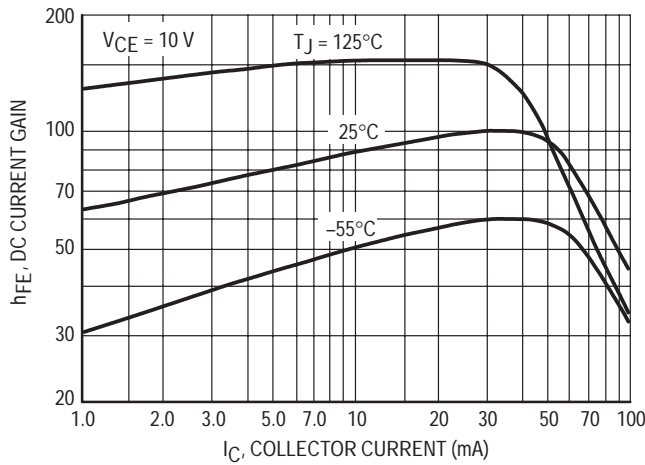


Figure 1. DC Current Gain

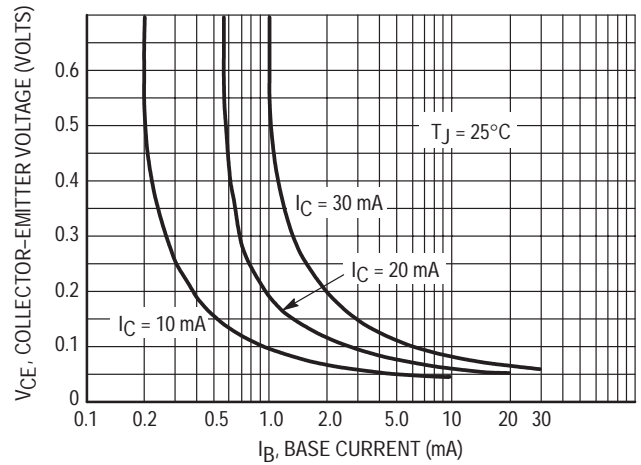


Figure 2. Collector Saturation Region

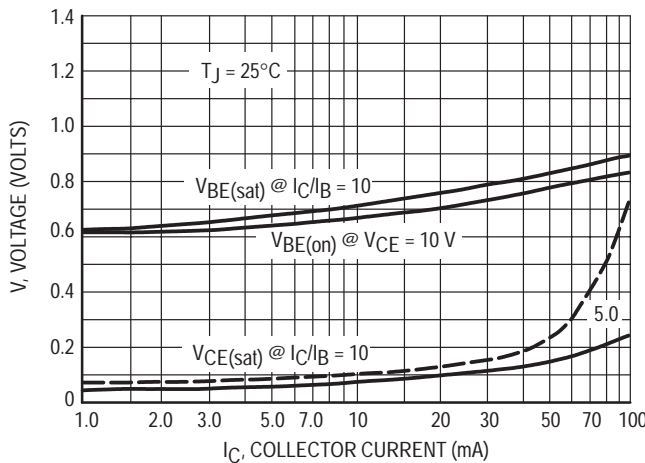


Figure 3. "On" Voltages

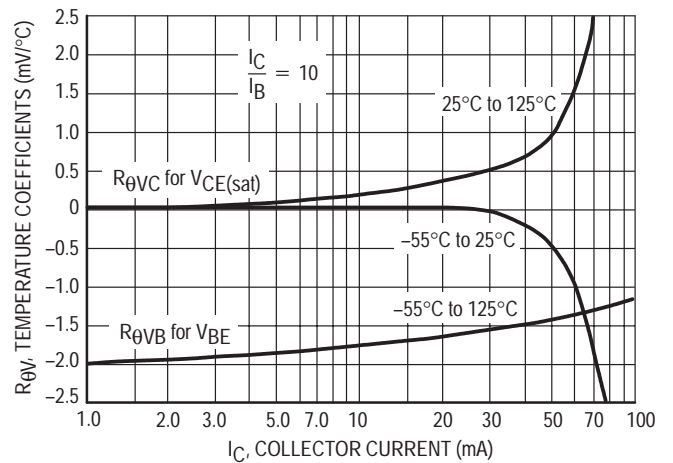


Figure 4. Temperature Coefficients

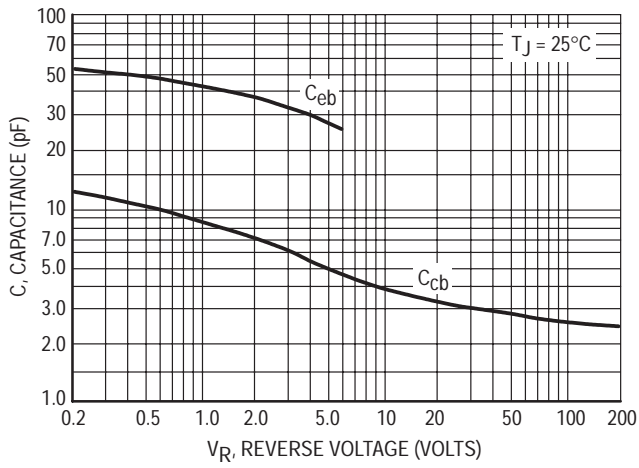


Figure 5. Capacitance

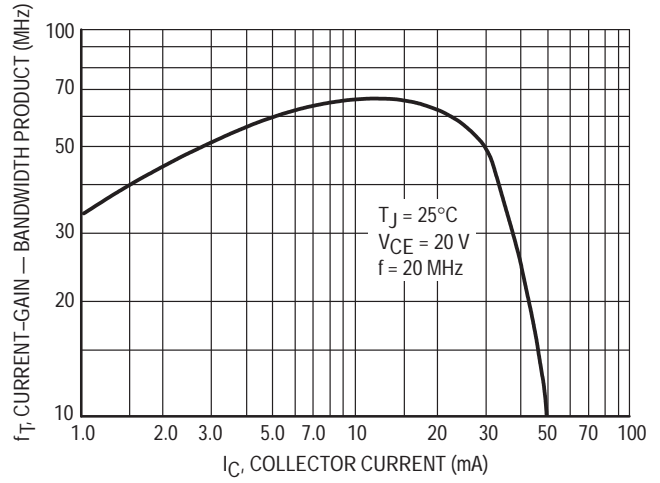


Figure 6. Current-Gain — Bandwidth Product

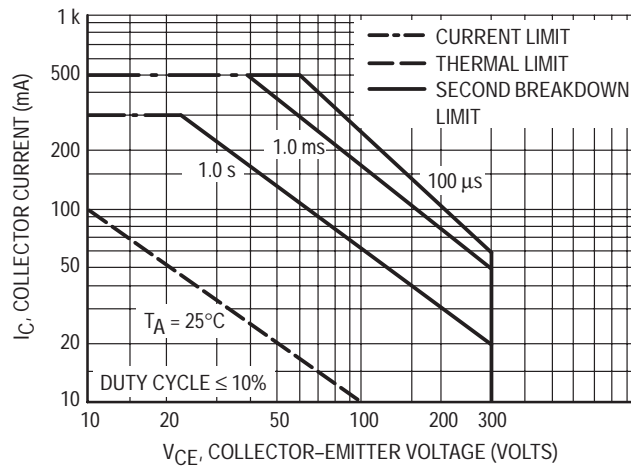
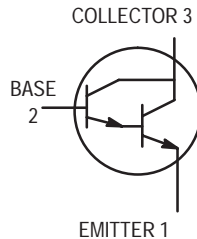


Figure 7. Active Region — Safe Operating Area

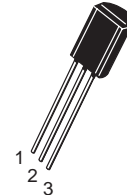
One Watt Darlington Transistors

NPN Silicon



MPSW45
MPSW45A*

*Motorola Preferred Device



CASE 29-05, STYLE 1
TO-92 (TO-226AE)

MAXIMUM RATINGS

Rating	Symbol	MPSW45	MPSW45A	Unit
Collector–Emitter Voltage	V_{CES}	40	50	Vdc
Collector–Base Voltage	V_{CBO}	50	60	Vdc
Emitter–Base Voltage	V_{EBO}	12	12	Vdc
Collector Current — Continuous	I_C	1.0	1.0	Adc
Total Device Dissipation @ $T_A = 25^\circ\text{C}$ Derate above 25°C	P_D	1.0	8.0	Watts mW/ $^\circ\text{C}$
Total Device Dissipation @ $T_C = 25^\circ\text{C}$ Derate above 25°C	P_D	2.5	20	Watts mW/ $^\circ\text{C}$
Operating and Storage Junction Temperature Range	T_J, T_{stg}	–55 to +150		$^\circ\text{C}$

THERMAL CHARACTERISTICS

Characteristic	Symbol	Max	Unit
Thermal Resistance, Junction to Ambient	$R_{\theta JA}$	125	$^\circ\text{C}/\text{W}$
Thermal Resistance, Junction to Case	$R_{\theta JC}$	50	$^\circ\text{C}/\text{W}$

ELECTRICAL CHARACTERISTICS ($T_A = 25^\circ\text{C}$ unless otherwise noted)

Characteristic	Symbol	Min	Max	Unit
----------------	--------	-----	-----	------

OFF CHARACTERISTICS

Collector–Emitter Breakdown Voltage ($I_C = 100 \mu\text{Adc}$, $V_{BE} = 0$)	MPSW45 MPSW45A	$V_{(BR)CES}$	40 50	— —	Vdc
Collector–Base Breakdown Voltage ($I_C = 100 \mu\text{Adc}$, $I_E = 0$)	MPSW45 MPSW45A	$V_{(BR)CBO}$	50 60	— —	Vdc
Emitter–Base Breakdown Voltage ($I_E = 10 \mu\text{Adc}$, $I_C = 0$)		$V_{(BR)EBO}$	12	—	Vdc
Collector Cutoff Current ($V_{CB} = 30 \text{Vdc}$, $I_E = 0$) ($V_{CB} = 40 \text{Vdc}$, $I_E = 0$)	MPSW45 MPSW45A	I_{CBO}	— —	100 100	nAdc
Emitter Cutoff Current ($V_{EB} = 10 \text{Vdc}$, $I_C = 0$)		I_{EBO}	—	100	nAdc

Preferred devices are Motorola recommended choices for future use and best overall value.

MPSW45 MPSW45A

ELECTRICAL CHARACTERISTICS (T_A = 25°C unless otherwise noted) (Continued)

Characteristic	Symbol	Min	Max	Unit
ON CHARACTERISTICS(1)				
DC Current Gain (I _C = 200 mA _{dc} , V _{CE} = 5.0 V _{dc}) (I _C = 500 mA _{dc} , V _{CE} = 5.0 V _{dc}) (I _C = 1.0 A _{dc} , V _{CE} = 5.0 V _{dc})	h _{FE}	25,000 15,000 4,000	150,000 — —	—
Collector–Emitter Saturation Voltage (I _C = 1.0 A _{dc} , I _B = 2.0 mA _{dc})	V _{CE(sat)}	—	1.5	V _{dc}
Base–Emitter Saturation Voltage (I _C = 1.0 A _{dc} , I _B = 2.0 mA _{dc})	V _{BE(sat)}	—	2.0	V _{dc}
Base–Emitter On Voltage (I _C = 1.0 A _{dc} , V _{CE} = 5.0 V _{dc})	V _{BE(on)}	—	2.0	V _{dc}

SMALL–SIGNAL CHARACTERISTICS

Current–Gain – Bandwidth Product (I _C = 200 mA _{dc} , V _{CE} = 5.0 V _{dc} , f = 100 MHz)	f _T	100	—	MHz
Collector–Base Capacitance (V _{CB} = 10 V _{dc} , I _E = 0, f = 1.0 MHz)	C _{cb}	—	6.0	pF

1. Pulse Test: Pulse Width ≤ 300 μs; Duty Cycle ≤ 2.0%.

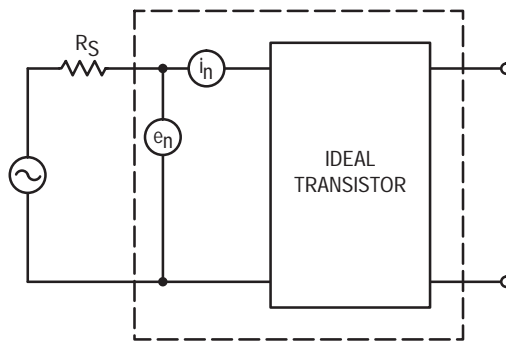


Figure 1. Transistor Noise Model

NOISE CHARACTERISTICS

($V_{CE} = 5.0 \text{ Vdc}$, $T_A = 25^\circ\text{C}$)

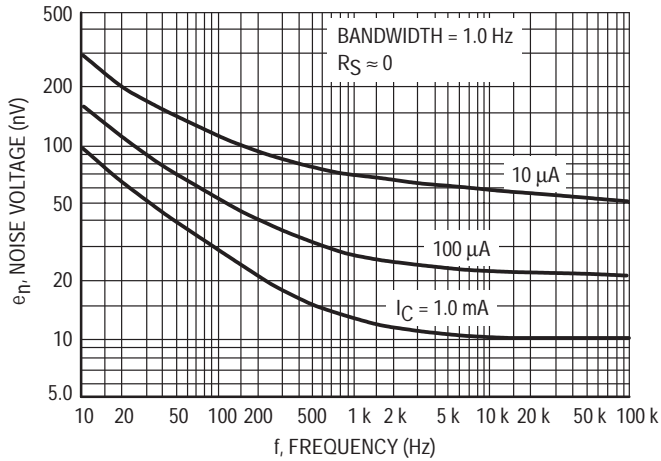


Figure 2. Noise Voltage

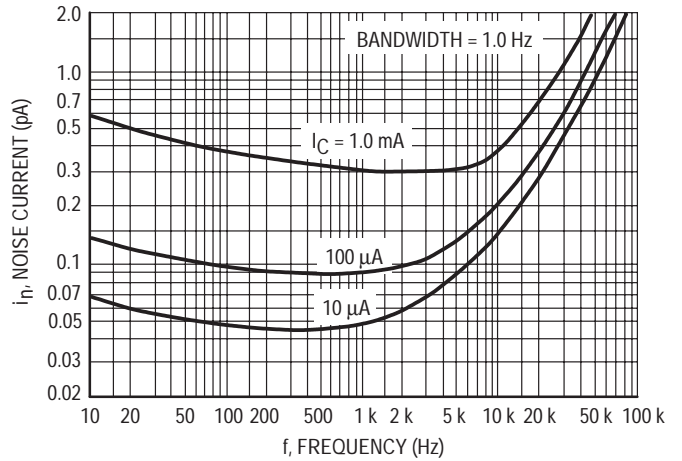


Figure 3. Noise Current

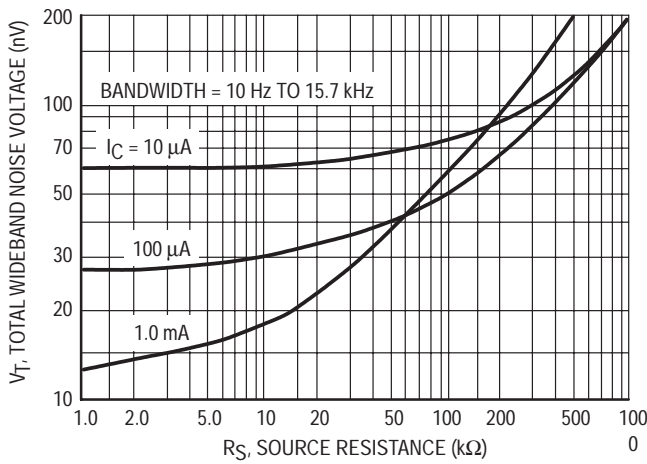


Figure 4. Total Wideband Noise Voltage

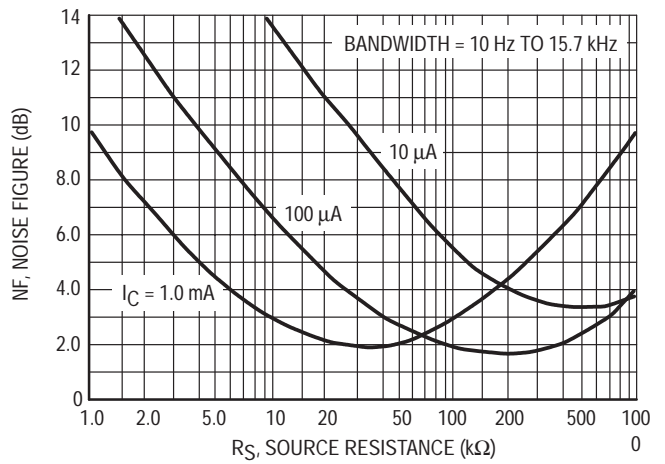


Figure 5. Wideband Noise Figure

SMALL-SIGNAL CHARACTERISTICS

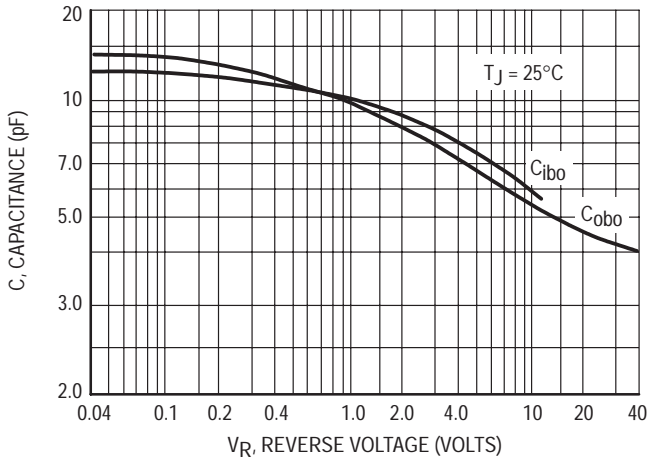


Figure 6. Capacitance

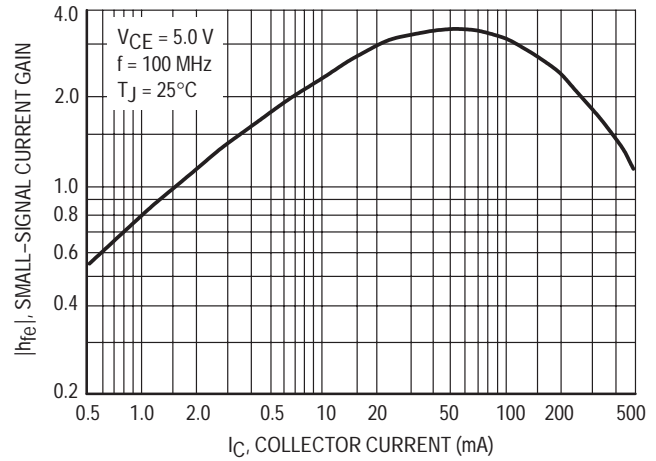


Figure 7. High Frequency Current Gain

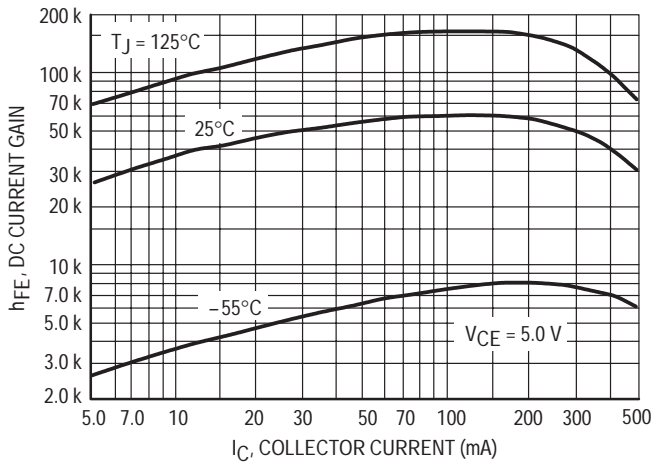


Figure 8. DC Current Gain

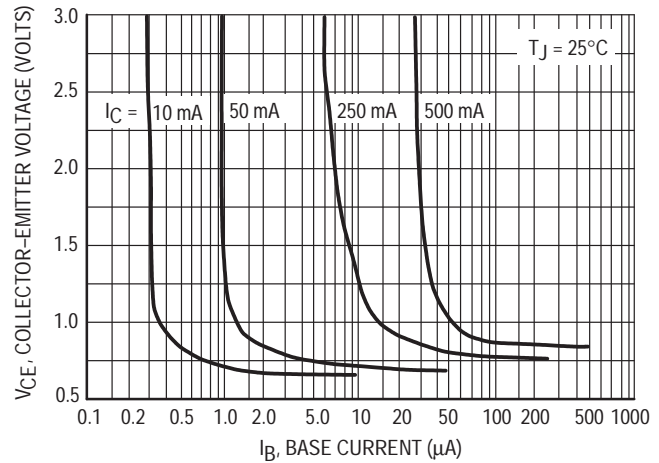


Figure 9. Collector Saturation Region

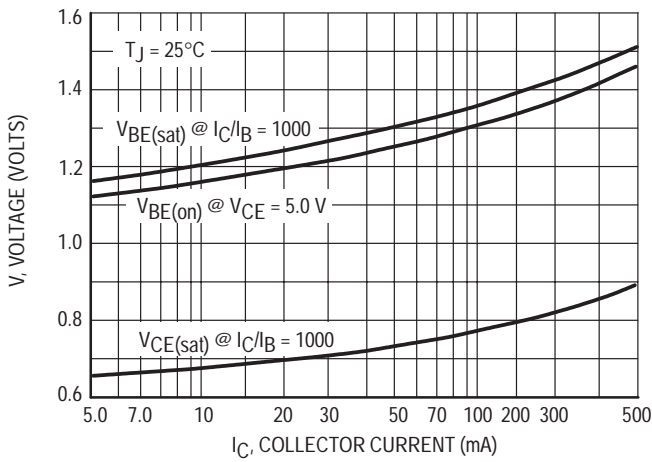


Figure 10. "On" Voltages

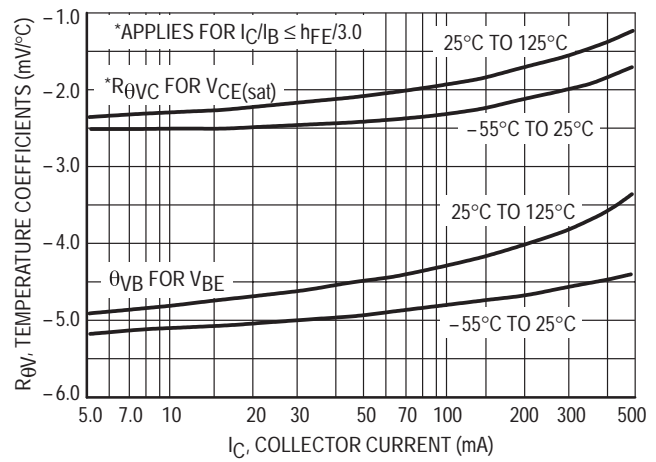


Figure 11. Temperature Coefficients

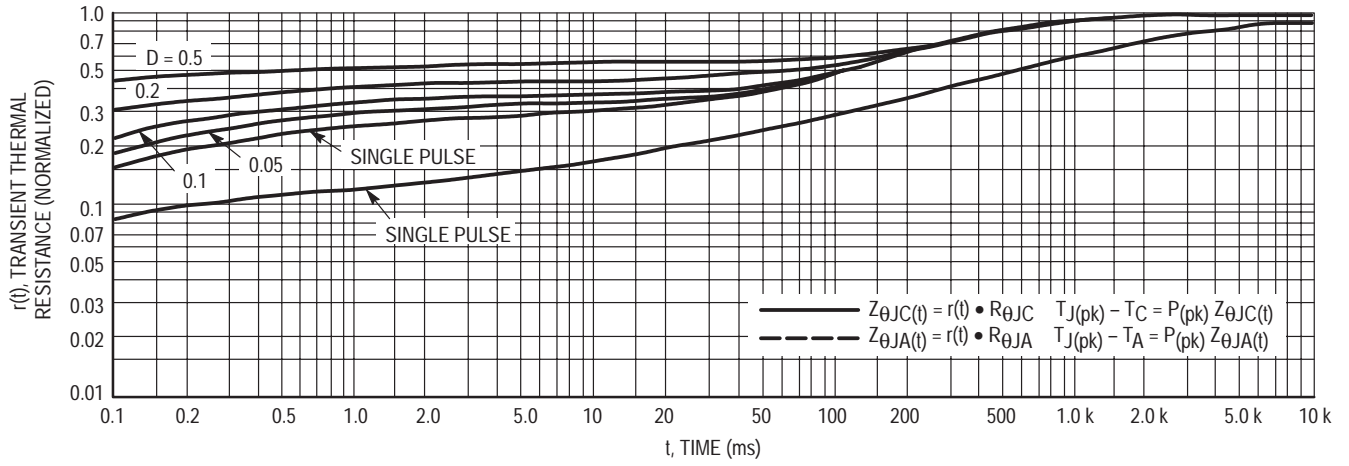


Figure 12. Thermal Response

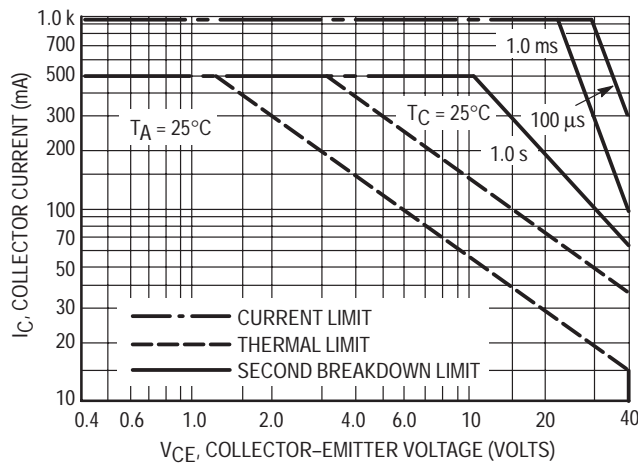
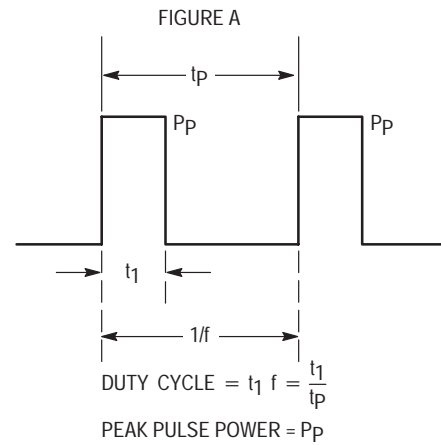


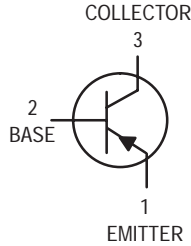
Figure 13. Active Region Safe Operating Area



Design Note: Use of Transient Thermal Resistance Data

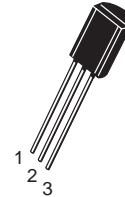
One Watt High Current Transistors

PNP Silicon



MPSW51
MPSW51A*

*Motorola Preferred Device



CASE 29-05, STYLE 1
TO-92 (TO-226AE)

MAXIMUM RATINGS

Rating	Symbol	Value	Unit
Collector-Emitter Voltage MPSW51 MPSW51A	V_{CEO}	-30 -40	Vdc
Collector-Base Voltage MPSW51 MPSW51A	V_{CBO}	-40 -50	Vdc
Emitter-Base Voltage	V_{EBO}	-5.0	Vdc
Collector Current — Continuous	I_C	-1000	mAdc
Total Device Dissipation @ $T_A = 25^\circ\text{C}$ Derate above 25°C	P_D	1.0 8.0	Watts mW/ $^\circ\text{C}$
Total Device Dissipation @ $T_C = 25^\circ\text{C}$ Derate above 25°C	P_D	2.5 20	Watts mW/ $^\circ\text{C}$
Operating and Storage Junction Temperature Range	T_J, T_{stg}	-55 to +150	$^\circ\text{C}$

THERMAL CHARACTERISTICS

Characteristic	Symbol	Max	Unit
Thermal Resistance, Junction to Ambient	$R_{\theta JA}$	125	$^\circ\text{C}/\text{W}$
Thermal Resistance, Junction to Case	$R_{\theta JC}$	50	$^\circ\text{C}/\text{W}$

ELECTRICAL CHARACTERISTICS ($T_A = 25^\circ\text{C}$ unless otherwise noted)

Characteristic	Symbol	Min	Max	Unit
----------------	--------	-----	-----	------

OFF CHARACTERISTICS

Collector-Emitter Breakdown Voltage ⁽¹⁾ ($I_C = -1.0 \text{ mAdc}, I_E = 0$)	MPSW51 MPSW51A	$V_{(BR)CEO}$	-30 -40	— —	Vdc
Collector-Base Breakdown Voltage ($I_C = -100 \mu\text{Adc}, I_E = 0$)	MPSW51 MPSW51A	$V_{(BR)CBO}$	-40 -50	— —	Vdc
Emitter-Base Breakdown Voltage ($I_E = -100 \mu\text{Adc}, I_C = 0$)		$V_{(BR)EBO}$	-5.0	—	Vdc
Collector Cutoff Current ($V_{CB} = -30 \text{ Vdc}, I_E = 0$) ($V_{CB} = -40 \text{ Vdc}, I_E = 0$)	MPSW51 MPSW51A	I_{CBO}	— —	-0.1 -0.1	μAdc
Emitter Cutoff Current ($V_{EB} = -3.0 \text{ Vdc}, I_C = 0$)		I_{EBO}	—	-0.1	μAdc

1. Pulse Test: Pulse Width $\leq 300 \mu\text{s}$, Duty Cycle $\leq 2.0\%$.

Preferred devices are Motorola recommended choices for future use and best overall value.

ELECTRICAL CHARACTERISTICS ($T_A = 25^\circ\text{C}$ unless otherwise noted) (Continued)

Characteristic	Symbol	Min	Max	Unit
ON CHARACTERISTICS				
DC Current Gain ($I_C = -10\text{ mAdc}$, $V_{CE} = -1.0\text{ Vdc}$) ($I_C = -100\text{ mAdc}$, $V_{CE} = -1.0\text{ Vdc}$) ($I_C = -1000\text{ mAdc}$, $V_{CE} = -1.0\text{ Vdc}$)	h_{FE}	55 60 50	— — —	—
Collector–Emitter Saturation Voltage ($I_C = -1000\text{ mAdc}$, $I_B = -100\text{ mAdc}$)	$V_{CE(sat)}$	—	-0.7	Vdc
Base–Emitter On Voltage ($I_C = -1000\text{ mAdc}$, $V_{CE} = -1.0\text{ Vdc}$)	$V_{BE(on)}$	—	-1.2	Vdc
SMALL-SIGNAL CHARACTERISTICS				
Current–Gain – Bandwidth Product ($I_C = -50\text{ mAdc}$, $V_{CE} = -10\text{ Vdc}$, $f = 20\text{ MHz}$)	f_T	50	—	MHz
Output Capacitance ($V_{CB} = -10\text{ Vdc}$, $I_E = 0$, $f = 1.0\text{ MHz}$)	C_{obo}	—	30	pF

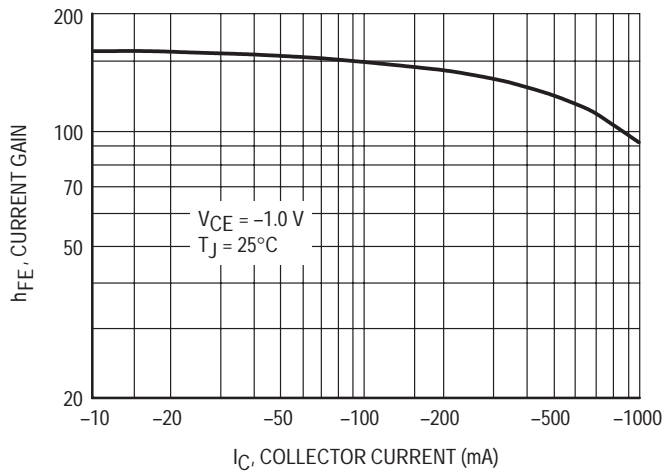


Figure 1. DC Current Gain

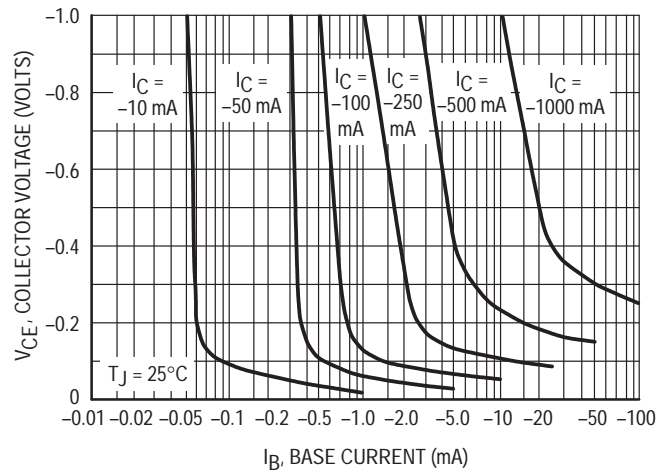


Figure 2. Collector Saturation Region

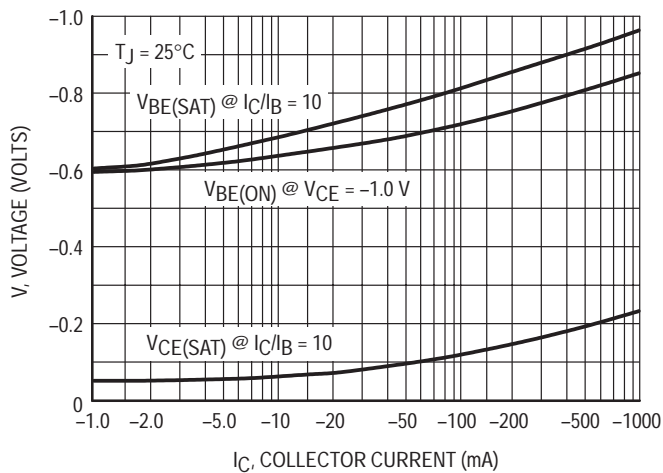


Figure 3. "ON" Voltages

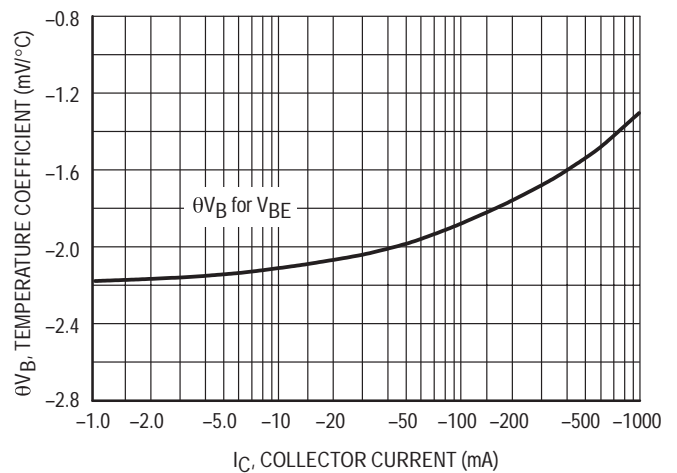


Figure 4. Temperature Coefficient

MPSW51 MPSW51A

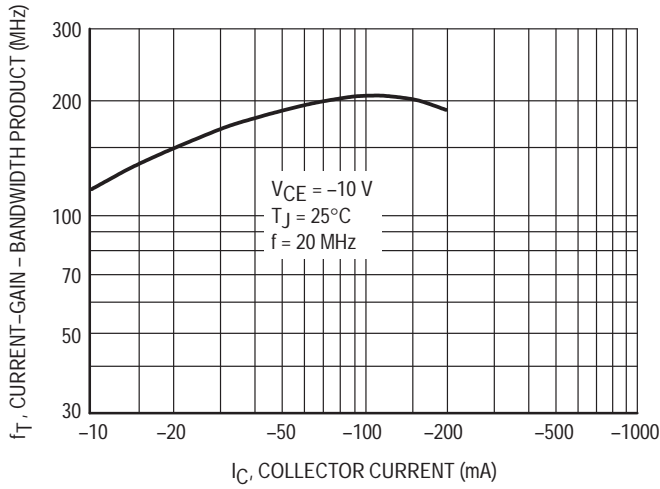


Figure 5. Current Gain — Bandwidth Product

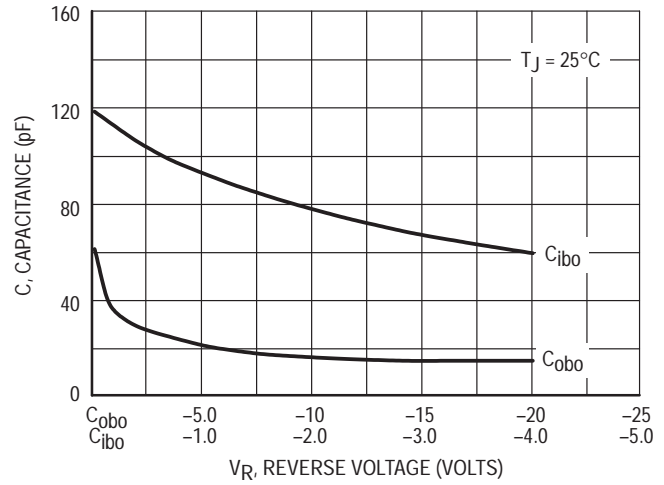


Figure 6. Capacitance

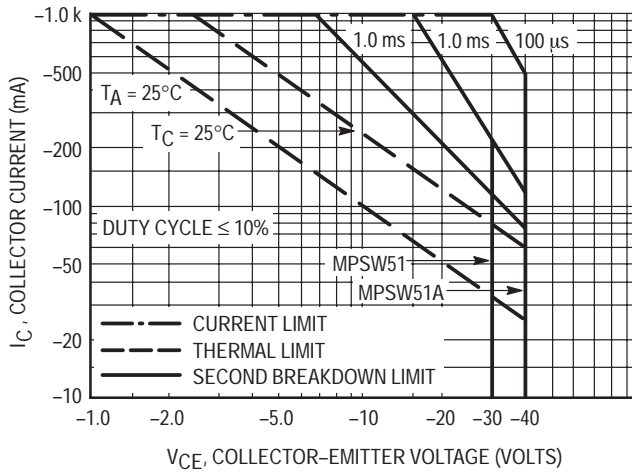
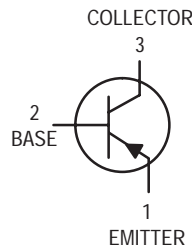


Figure 7. Active Region — Safe Operating Area

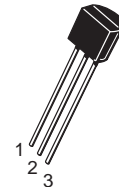
One Watt Amplifier Transistors

PNP Silicon



MPSW55
MPSW56*

*Motorola Preferred Device



CASE 29-05, STYLE 1
TO-92 (TO-226AE)

MAXIMUM RATINGS

Rating	Symbol	MPSW55	MPSW56	Unit
Collector–Emitter Voltage	V_{CEO}	-60	-80	Vdc
Collector–Base Voltage	V_{CBO}	-60	-80	Vdc
Emitter–Base Voltage	V_{EBO}	-4.0		Vdc
Collector Current — Continuous	I_C	-500		mAdc
Total Device Dissipation @ $T_A = 25^\circ\text{C}$ Derate above 25°C	P_D	1.0	8.0	Watt mW/ $^\circ\text{C}$
Total Device Dissipation @ $T_C = 25^\circ\text{C}$ Derate above 25°C	P_D	2.5	20	Watts mW/ $^\circ\text{C}$
Operating and Storage Junction Temperature Range	T_J, T_{stg}	-55 to +150		$^\circ\text{C}$

THERMAL CHARACTERISTICS

Characteristic	Symbol	Max	Unit
Thermal Resistance, Junction to Ambient	$R_{\theta JA}$	125	$^\circ\text{C}/\text{W}$
Thermal Resistance, Junction to Case	$R_{\theta JC}$	50	$^\circ\text{C}/\text{W}$

ELECTRICAL CHARACTERISTICS ($T_A = 25^\circ\text{C}$ unless otherwise noted)

Characteristic	Symbol	Min	Max	Unit
----------------	--------	-----	-----	------

OFF CHARACTERISTICS

Collector–Emitter Breakdown Voltage ⁽¹⁾ ($I_C = -1.0$ mAdc, $I_B = 0$)	MPSW55 MPSW56	$V_{(BR)CEO}$	-60 -80	— —	Vdc
Emitter–Base Breakdown Voltage ($I_E = -100$ μAdc , $I_C = 0$)		$V_{(BR)EBO}$	-4.0	—	Vdc
Collector Cutoff Current ($V_{CE} = -40$ Vdc, $I_B = 0$) ($V_{CE} = -60$ Vdc, $I_B = 0$)	MPSW55 MPSW56	I_{CES}	— —	-0.5 -0.5	μAdc
Collector Cutoff Current ($V_{CB} = -40$ Vdc, $I_E = 0$) ($V_{CB} = -60$ Vdc, $I_E = 0$)	MPSW55 MPSW56	I_{CBO}	— —	-0.1 -0.1	μAdc
Emitter Cutoff Current ($V_{EB} = -3.0$ Vdc, $I_C = 0$)		I_{EBO}	—	-0.1	μAdc

1. Pulse Test: Pulse Width ≤ 300 μs , Duty Cycle $\leq 2.0\%$.

Preferred devices are Motorola recommended choices for future use and best overall value.

MPSW55 MPSW56

ELECTRICAL CHARACTERISTICS (T_A = 25°C unless otherwise noted) (Continued)

Characteristic	Symbol	Min	Max	Unit
ON CHARACTERISTICS(1)				
DC Current Gain (I _C = -50 mA, V _{CE} = -1.0 Vdc) (I _C = -250 mA, V _{CE} = -1.0 Vdc)	h _{FE}	100 50	— —	—
Collector–Emitter Saturation Voltage (I _C = -250 mA, I _B = -10 mA)	V _{CE(sat)}	—	-0.5	Vdc
Base–Emitter On Voltage (I _C = -250 mA, V _{CE} = -5.0 Vdc)	V _{BE(on)}	—	-1.2	Vdc

SMALL–SIGNAL CHARACTERISTICS

Current–Gain — Bandwidth Product (I _C = -250 mA, V _{CE} = -5.0 Vdc, f = 20 MHz)	f _T	50	—	MHz
Output Capacitance (V _{CB} = -10 Vdc, f = 1.0 MHz)	C _{obo}	—	15	pF

1. Pulse Test: Pulse Width ≤ 300 μs, Duty Cycle ≤ 2.0%.

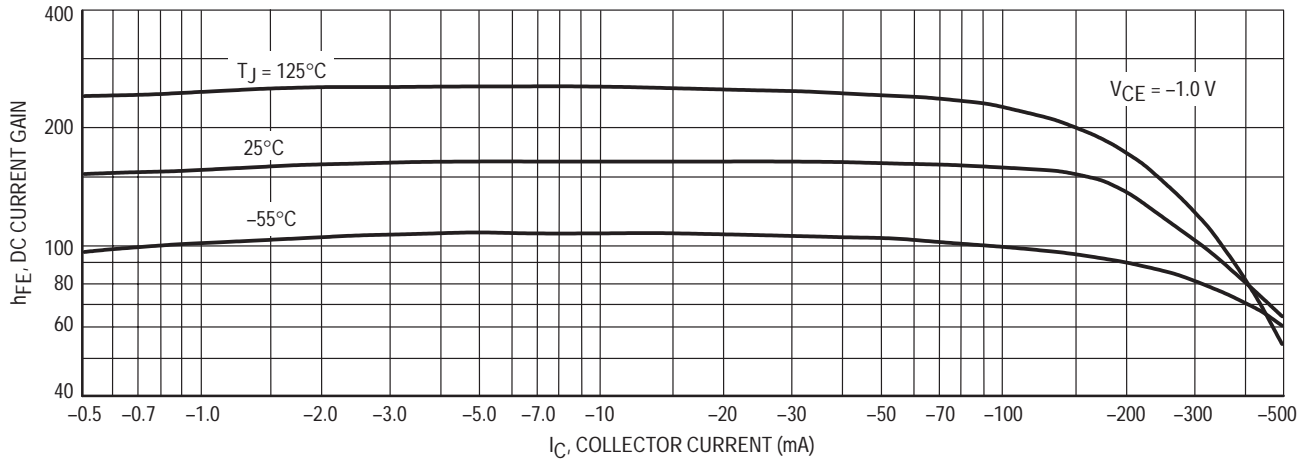


Figure 1. DC Current Gain

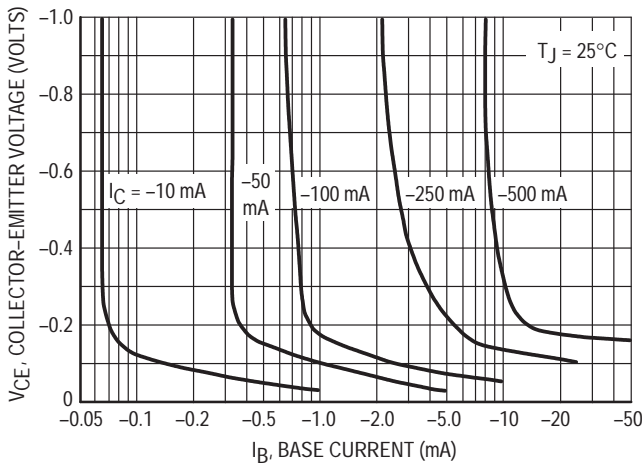


Figure 2. Collector Saturation Region

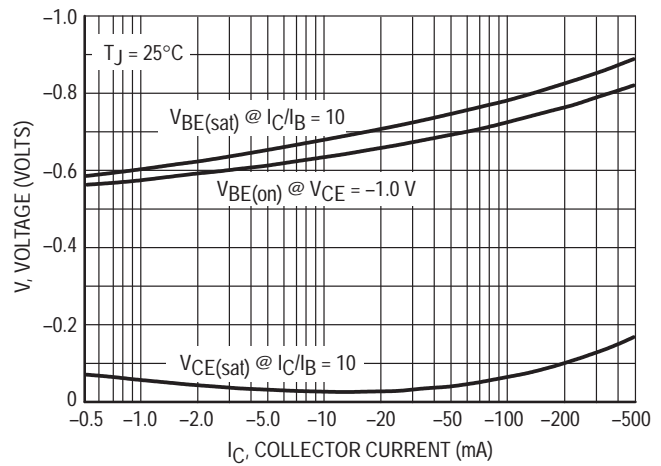


Figure 3. "On" Voltages

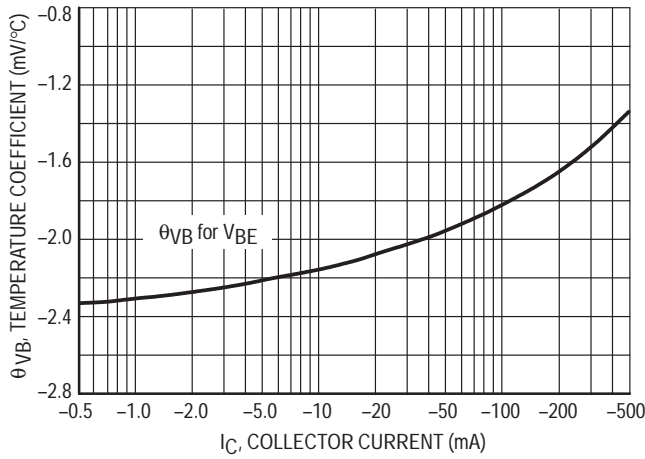


Figure 4. Base-Emitter Temperature Coefficient

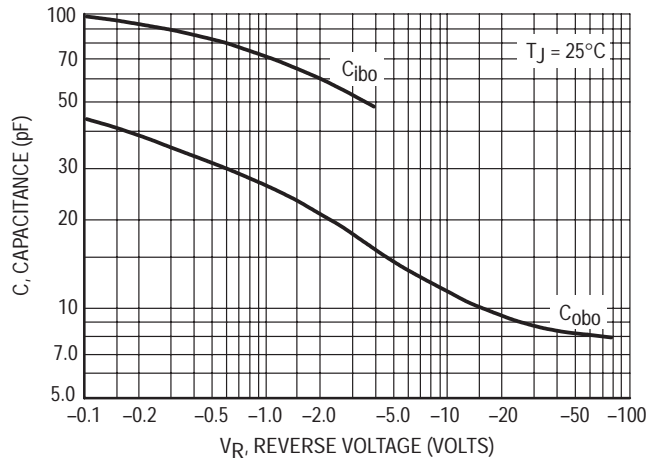


Figure 5. Capacitance

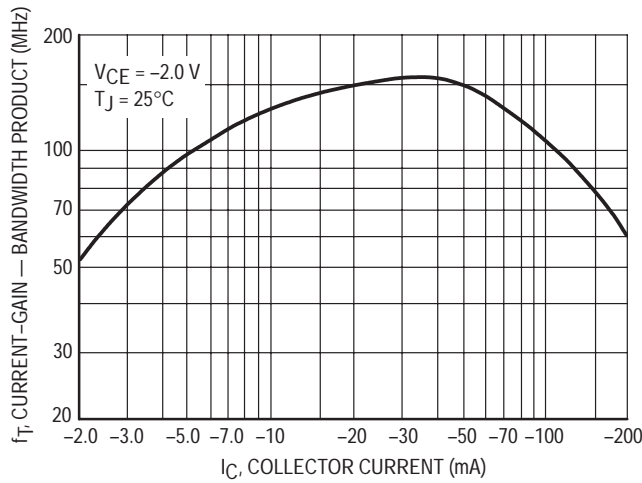


Figure 6. Current-Gain — Bandwidth Product

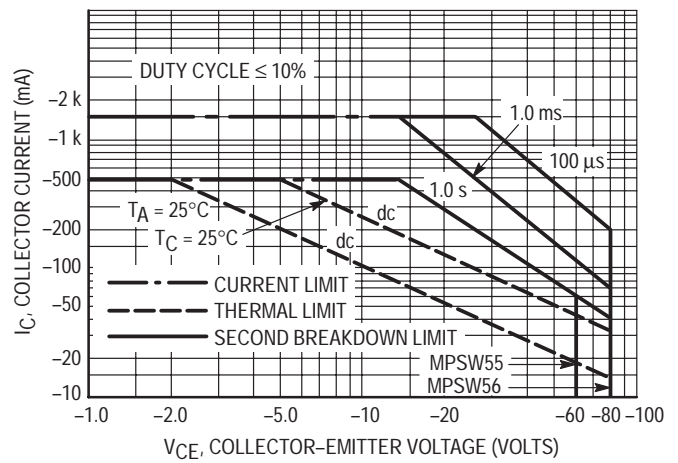
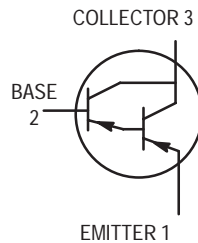


Figure 7. Active Region — Safe Operating Area

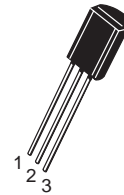
One Watt Darlington Transistors

PNP Silicon



MPSW63
MPSW64*

*Motorola Preferred Device



CASE 29-05, STYLE 1
TO-92 (TO-226AE)

MAXIMUM RATINGS

Rating	Symbol	MPSW63 MPSW64	Unit
Collector–Emitter Voltage	V_{CES}	–30	Vdc
Collector–Base Voltage	V_{CBO}	–30	Vdc
Emitter–Base Voltage	V_{EBO}	–10	Vdc
Collector Current — Continuous	I_C	–500	mAdc
Total Device Dissipation @ $T_A = 25^\circ\text{C}$ Derate above 25°C	P_D	1.0 8.0	Watt mW/ $^\circ\text{C}$
Total Device Dissipation @ $T_C = 25^\circ\text{C}$ Derate above 25°C	P_D	2.5 20	Watts mW/ $^\circ\text{C}$
Operating and Storage Junction Temperature Range	T_J, T_{stg}	–55 to +150	$^\circ\text{C}$

THERMAL CHARACTERISTICS

Characteristic	Symbol	Max	Unit
Thermal Resistance, Junction to Ambient	$R_{\theta JA}$	125	$^\circ\text{C}/\text{W}$
Thermal Resistance, Junction to Case	$R_{\theta JC}$	50	$^\circ\text{C}/\text{W}$

ELECTRICAL CHARACTERISTICS ($T_A = 25^\circ\text{C}$ unless otherwise noted)

Characteristic	Symbol	Min	Max	Unit
----------------	--------	-----	-----	------

OFF CHARACTERISTICS

Collector–Emitter Breakdown Voltage ($I_C = -100 \mu\text{Adc}$, $V_{BE} = 0$)	$V_{(BR)CES}$	–30	—	Vdc
Collector Cutoff Current ($V_{CB} = -30 \text{ Vdc}$, $I_E = 0$)	I_{CBO}	—	–100	nAdc
Emitter Cutoff Current ($V_{EB} = -10 \text{ Vdc}$, $I_C = 0$)	I_{EBO}	—	–100	nAdc

Preferred devices are Motorola recommended choices for future use and best overall value.

ELECTRICAL CHARACTERISTICS ($T_A = 25^\circ\text{C}$ unless otherwise noted) (Continued)

Characteristic	Symbol	Min	Max	Unit
ON CHARACTERISTICS(1)				
DC Current Gain ($I_C = -10\text{ mAdc}$, $V_{CE} = -5.0\text{ Vdc}$)	MPSW63	5,000	—	—
	MPSW64	10,000	—	—
($I_C = -100\text{ mAdc}$, $V_{CE} = -5.0\text{ Vdc}$)	MPSW63	10,000	—	—
	MPSW64	20,000	—	—
Collector–Emitter Saturation Voltage ($I_C = -100\text{ mAdc}$, $I_B = -0.1\text{ mAdc}$)	$V_{CE(sat)}$	—	-1.5	Vdc
Base–Emitter On Voltage ($I_C = -100\text{ mAdc}$, $V_{CE} = -5.0\text{ Vdc}$)	$V_{BE(on)}$	—	-2.0	Vdc
SMALL-SIGNAL CHARACTERISTICS				
Current–Gain — Bandwidth Product(2) ($I_C = -10\text{ mAdc}$, $V_{CE} = -5.0\text{ Vdc}$, $f = 100\text{ MHz}$)	f_T	125	—	MHz

1. Pulse Test: Pulse Width $\leq 300\ \mu\text{s}$, Duty Cycle $\leq 2.0\%$.
2. $f_T = |h_{fe}| \cdot f_{test}$.

TYPICAL ELECTRICAL CHARACTERISTICS

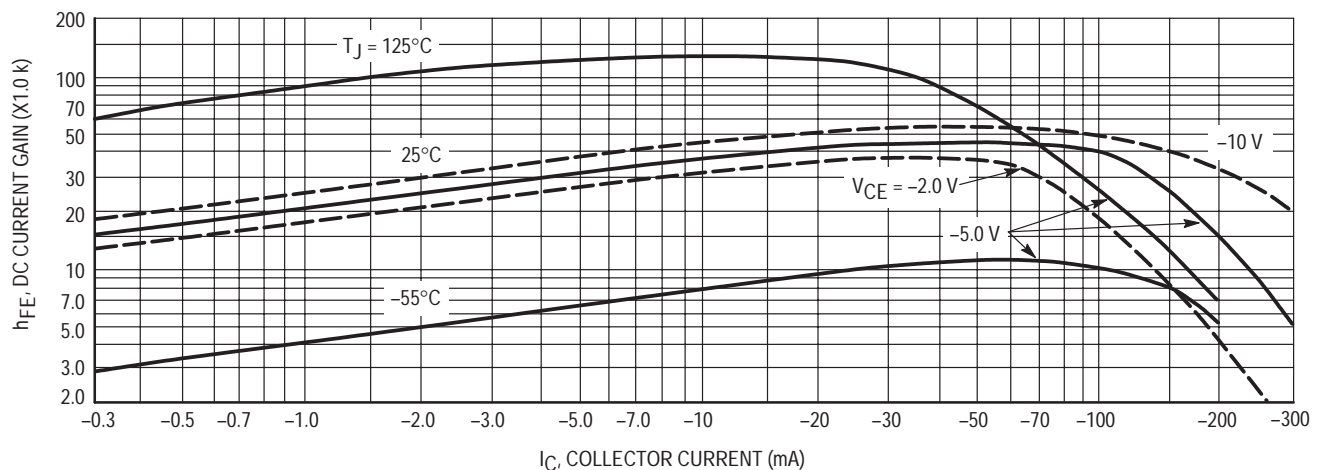


Figure 1. DC Current Gain

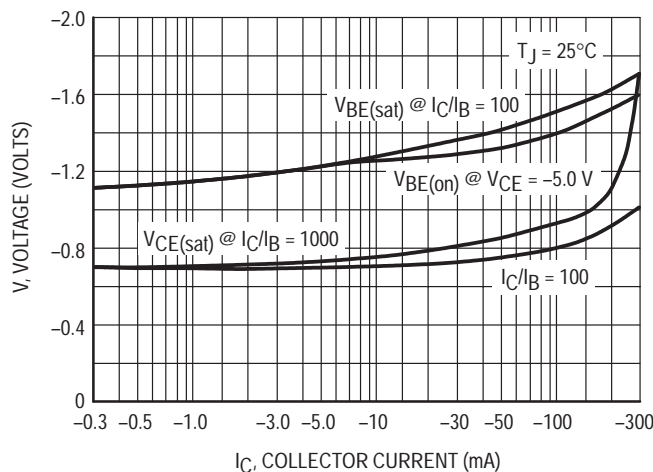


Figure 2. "ON" Voltage

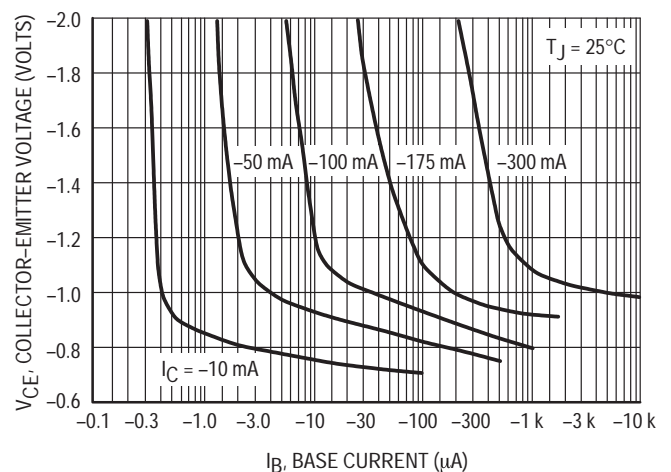


Figure 3. Collector Saturation Region

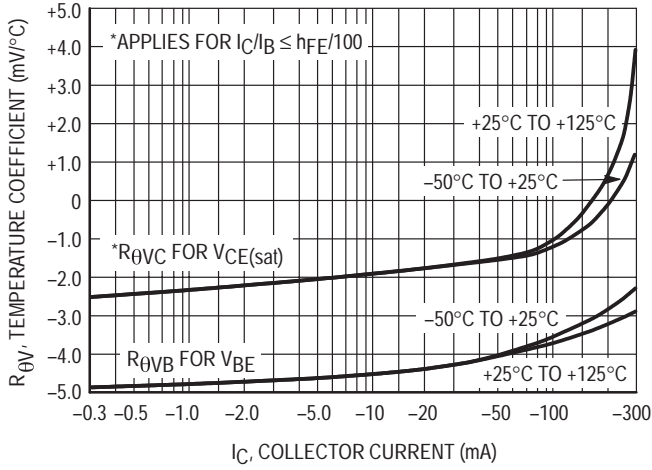


Figure 4. Temperature Coefficients

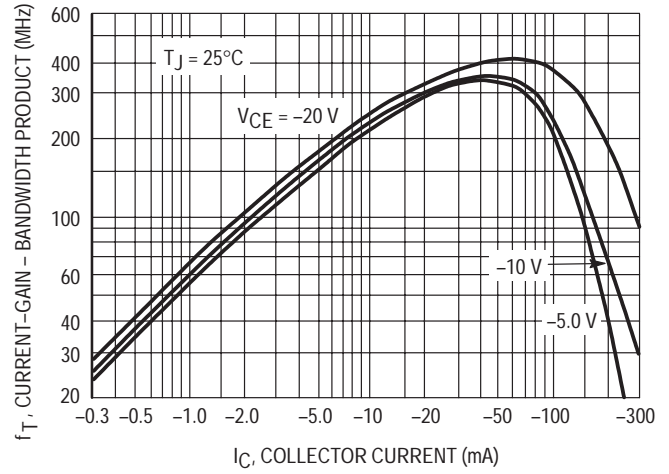


Figure 5. Current-Gain — Bandwidth Product

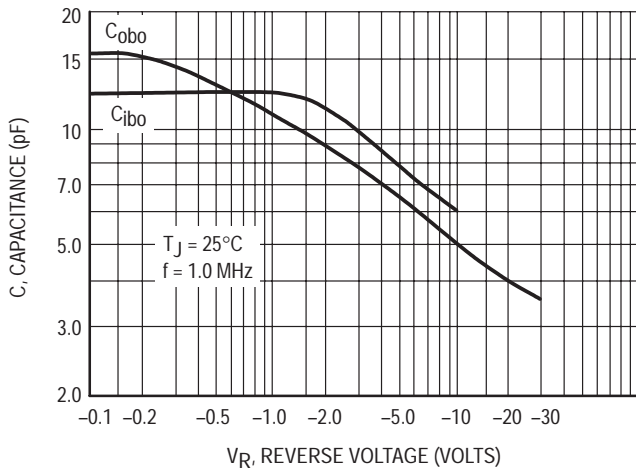


Figure 6. Capacitance

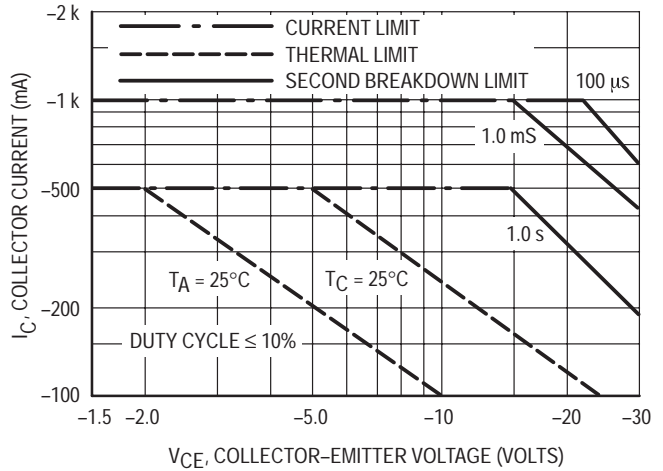
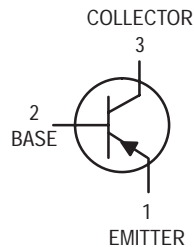


Figure 7. Active Region, Safe Operating Area

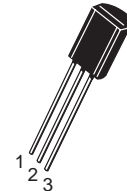
One Watt High Voltage Transistor

PNP Silicon



MPSW92

Motorola Preferred Device



CASE 29-05, STYLE 1
TO-92 (TO-226AE)

MAXIMUM RATINGS

Rating	Symbol	Value	Unit
Collector–Emitter Voltage	V_{CEO}	–300	Vdc
Collector–Base Voltage	V_{CBO}	–300	Vdc
Emitter–Base Voltage	V_{EBO}	–5.0	Vdc
Collector Current — Continuous	I_C	–500	mAdc
Total Device Dissipation @ $T_A = 25^\circ\text{C}$ Derate above 25°C	P_D	1.0 8.0	Watt mW/ $^\circ\text{C}$
Total Device Dissipation @ $T_C = 25^\circ\text{C}$ Derate above 25°C	P_D	2.5 20	Watts mW/ $^\circ\text{C}$
Operating and Storage Junction Temperature Range	T_J, T_{stg}	–55 to +150	$^\circ\text{C}$

THERMAL CHARACTERISTICS

Characteristic	Symbol	Max	Unit
Thermal Resistance, Junction to Ambient	$R_{\theta JA}$	125	$^\circ\text{C}/\text{W}$
Thermal Resistance, Junction to Case	$R_{\theta JC}$	50	$^\circ\text{C}/\text{W}$

ELECTRICAL CHARACTERISTICS ($T_A = 25^\circ\text{C}$ unless otherwise noted)

Characteristic	Symbol	Min	Max	Unit
----------------	--------	-----	-----	------

OFF CHARACTERISTICS

Collector–Emitter Breakdown Voltage ⁽¹⁾ ($I_C = -1.0$ mAdc, $I_B = 0$)	$V_{(BR)CEO}$	–300	—	Vdc
Collector–Base Breakdown Voltage ($I_C = -100$ μAdc , $I_E = 0$)	$V_{(BR)CBO}$	–300	—	Vdc
Emitter–Base Breakdown Voltage ($I_E = -100$ μAdc , $I_C = 0$)	$V_{(BR)EBO}$	–5.0	—	Vdc
Collector Cutoff Current ($V_{CB} = -200$ Vdc, $I_E = 0$)	I_{CBO}	—	–0.25	μAdc
Emitter Cutoff Current ($V_{EB} = -3.0$ Vdc, $I_C = 0$)	I_{EBO}	—	–0.1	μAdc

1. Pulse Test: Pulse Width ≤ 300 μs , Duty Cycle $\leq 2.0\%$.

Preferred devices are Motorola recommended choices for future use and best overall value.

ELECTRICAL CHARACTERISTICS ($T_A = 25^\circ\text{C}$ unless otherwise noted) (Continued)

Characteristic	Symbol	Min	Max	Unit
ON CHARACTERISTICS(1)				
DC Current Gain ($I_C = -1.0\text{ mA}$, $V_{CE} = -10\text{ Vdc}$) ($I_C = -10\text{ mA}$, $V_{CE} = -10\text{ Vdc}$) ($I_C = -30\text{ mA}$, $V_{CE} = -10\text{ Vdc}$)	h_{FE}	25 40 25	— — —	—
Collector–Emitter Saturation Voltage ($I_C = -20\text{ mA}$, $I_B = -2.0\text{ mA}$)	$V_{CE(sat)}$	—	-0.5	Vdc
Base–Emitter Saturation Voltage ($I_C = -20\text{ mA}$, $I_B = -2.0\text{ mA}$)	$V_{BE(sat)}$	—	-0.9	Vdc
SMALL–SIGNAL CHARACTERISTICS				
Current–Gain — Bandwidth Product ($I_C = -10\text{ mA}$, $V_{CE} = -20\text{ Vdc}$, $f = 20\text{ MHz}$)	f_T	50	—	MHz
Collector–Base Capacitance ($V_{CB} = -20\text{ Vdc}$, $I_E = 0$, $f = 1.0\text{ MHz}$)	C_{cb}	—	6.0	pF

1. Pulse Test: Pulse Width $\leq 300\ \mu\text{s}$, Duty Cycle $\leq 2.0\%$.

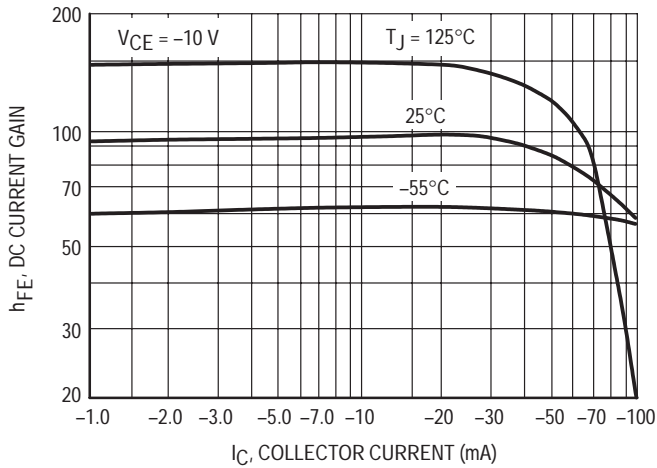


Figure 1. DC Current Gain

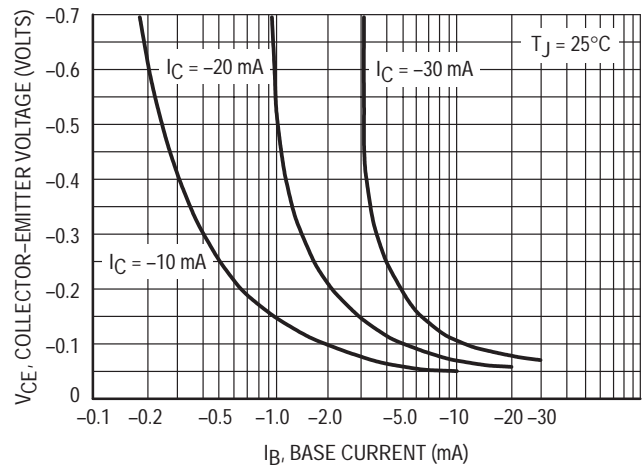


Figure 2. Collector Saturation Region

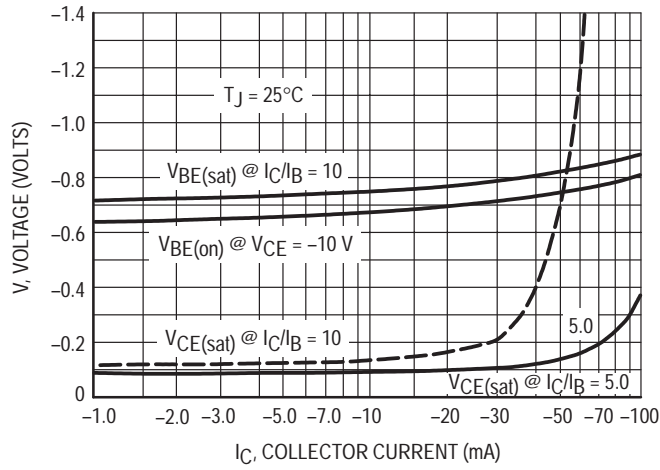


Figure 3. "ON" Voltages

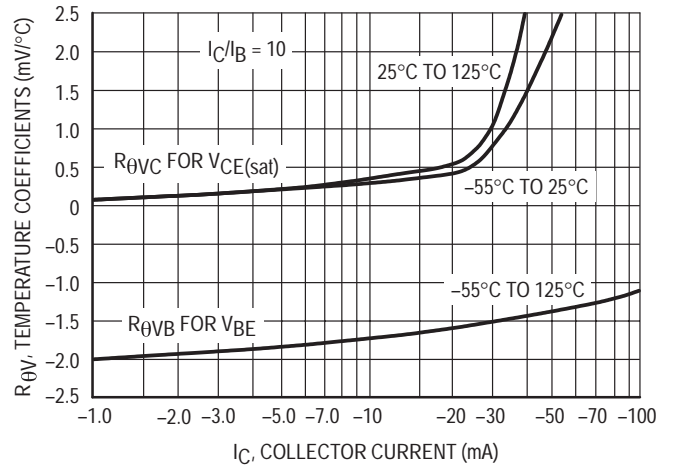


Figure 4. Temperature Coefficients

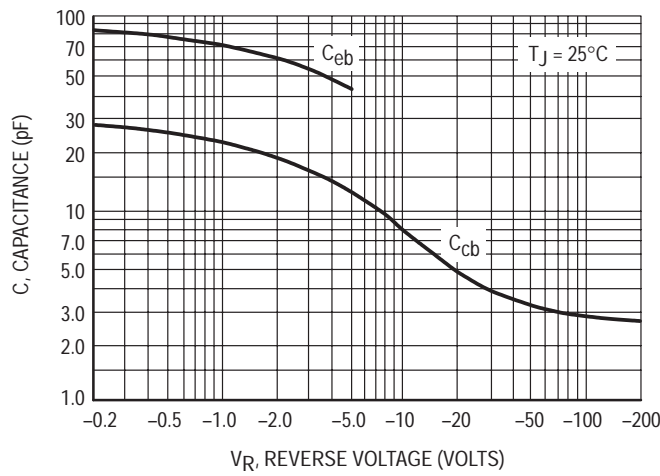


Figure 5. Capacitance

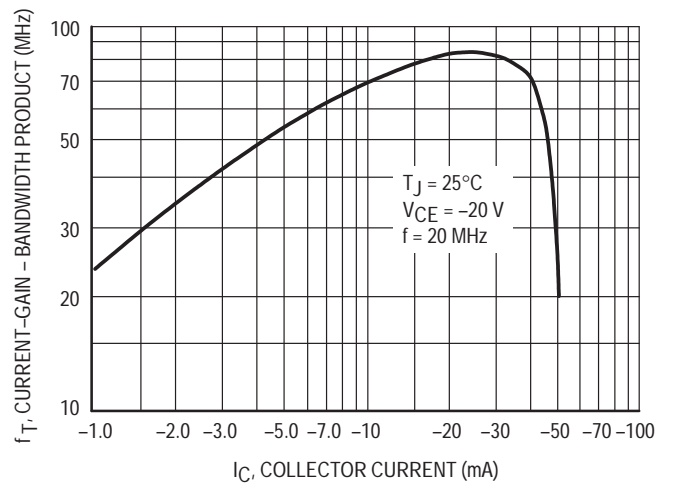


Figure 6. Current-Gain — Bandwidth Product

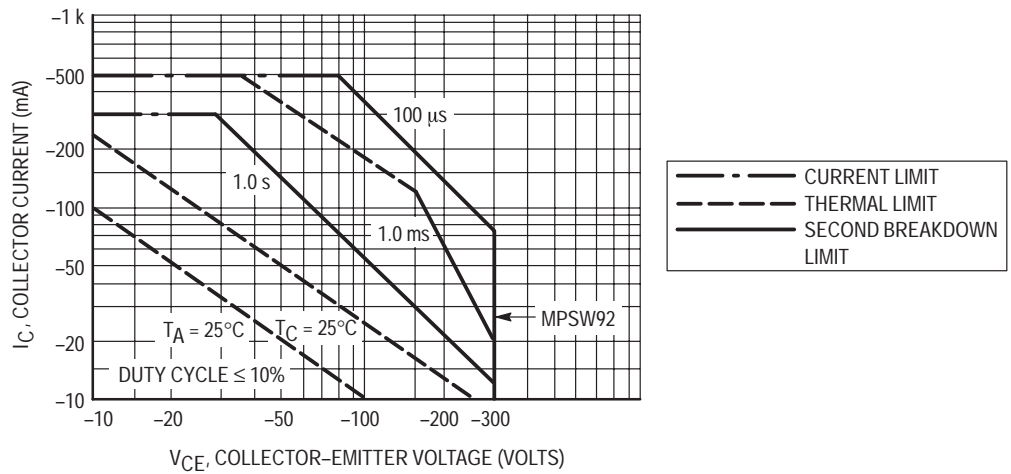
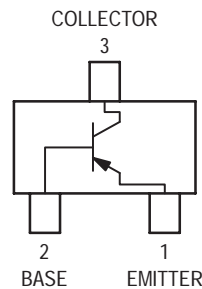


Figure 7. Active Region Safe Operating Area

PNP RF Amplifier Transistor Surface Mount

MSA1022-CT1

Motorola Preferred Device



CASE 318D-03, STYLE 1
SC-59

MAXIMUM RATINGS ($T_A = 25^\circ\text{C}$)

Rating	Symbol	Value	Unit
Collector-Base Voltage	V_{CB0}	-30	Vdc
Collector-Emitter Voltage	V_{CEO}	-20	Vdc
Emitter-Base Voltage	V_{EBO}	-5.0	Vdc
Collector Current — Continuous	I_C	-30	mAdc

THERMAL CHARACTERISTICS

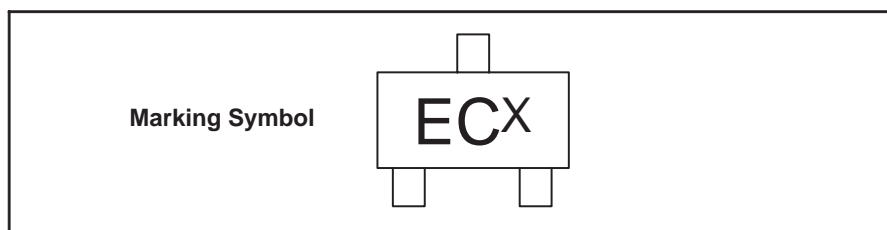
Characteristic	Symbol	Max	Unit
Power Dissipation	P_D	200	mW
Junction Temperature	T_J	150	$^\circ\text{C}$
Storage Temperature	T_{stg}	-55 ~ +150	$^\circ\text{C}$

ELECTRICAL CHARACTERISTICS ($T_A = 25^\circ\text{C}$)

Characteristic	Symbol	Min	Max	Unit
Collector Cutoff Current ($V_{CB} = -10$ Vdc, $I_E = 0$)	I_{CBO}	—	-0.1	μAdc
Collector-Emitter Breakdown Voltage ($V_{CE} = -20$ Vdc, $I_B = 0$)	I_{CEO}	—	-100	μAdc
Emitter-Base Breakdown Voltage ($V_{EB} = -5.0$ Vdc, $I_C = 0$)	I_{EBO}	—	-10	μAdc
DC Current Gain ⁽¹⁾ ($V_{CE} = -10$ Vdc, $I_C = -1.0$ mAdc)	h_{FE}	110	220	—
Current-Gain — Bandwidth Product ($V_{CB} = -10$ Vdc, $I_E = 1.0$ mAdc)	f_T	150	—	MHz

1. Pulse Test: Pulse Width ≤ 300 μs , D.C. $\leq 2\%$.

DEVICE MARKING



The "X" represents a smaller alpha digit Date Code. The Date Code indicates the actual month in which the part was manufactured.

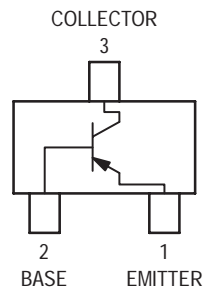
Preferred devices are Motorola recommended choices for future use and best overall value.

(Replaces MSA1022-BT1/D)

PNP General Purpose Amplifier Transistor Surface Mount

MSB709-RT1

Motorola Preferred Device



CASE 318D-03, STYLE 1
SC-59

MAXIMUM RATINGS (T_A = 25°C)

Rating	Symbol	Value	Unit
Collector-Base Voltage	V _{(BR)CBO}	-60	Vdc
Collector-Emitter Voltage	V _{(BR)CEO}	-45	Vdc
Emitter-Base Voltage	V _{(BR)EBO}	-7.0	Vdc
Collector Current — Continuous	I _C	-100	mAdc
Collector Current — Peak	I _{C(P)}	-200	mAdc

THERMAL CHARACTERISTICS

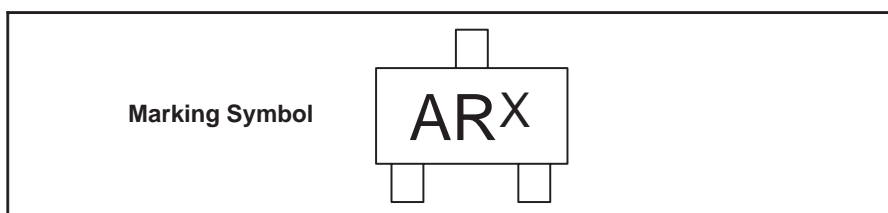
Characteristic	Symbol	Max	Unit
Power Dissipation	P _D	200	mW
Junction Temperature	T _J	150	°C
Storage Temperature	T _{stg}	-55 ~ +150	°C

ELECTRICAL CHARACTERISTICS (T_A = 25°C)

Characteristic	Symbol	Min	Max	Unit
Collector-Emitter Breakdown Voltage (I _C = -2.0 mAdc, I _B = 0)	V _{(BR)CEO}	-45	—	Vdc
Collector-Base Breakdown Voltage (I _C = -10 μAdc, I _E = 0)	V _{(BR)CBO}	-60	—	Vdc
Emitter-Base Breakdown Voltage (I _E = -10 μAdc, I _C = 0)	V _{(BR)EBO}	-7.0	—	Vdc
Collector-Base Cutoff Current (V _{CB} = -45 Vdc, I _E = 0)	I _{CBO}	—	-0.1	μAdc
Collector-Emitter Cutoff Current (V _{CE} = -10 Vdc, I _B = 0)	I _{CEO}	—	-100	nAdc
DC Current Gain ⁽¹⁾ (V _{CE} = -10 Vdc, I _C = -2.0 mAdc)	h _{FE1}	210	340	—
Collector-Emitter Saturation Voltage (I _C = -100 mAdc, I _B = -10 mAdc)	V _{CE(sat)}	—	-0.5	Vdc

1. Pulse Test: Pulse Width ≤ 300 μs, D.C. ≤ 2%.

DEVICE MARKING



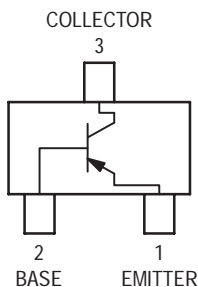
The "X" represents a smaller alpha digit Date Code. The Date Code indicates the actual month in which the part was manufactured.

Preferred devices are Motorola recommended choices for future use and best overall value.

PNP General Purpose Amplifier Transistor Surface Mount

MSB710-RT1

Motorola Preferred Device



CASE 318D-04, STYLE 1
SC-59

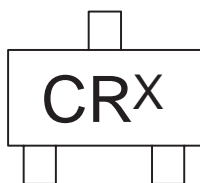
MAXIMUM RATINGS ($T_A = 25^\circ\text{C}$)

Rating	Symbol	Value	Unit
Collector-Base Voltage	$V_{(BR)CBO}$	-60	Vdc
Collector-Emitter Voltage	$V_{(BR)CEO}$	-50	Vdc
Emitter-Base Voltage	$V_{(BR)EBO}$	-7.0	Vdc
Collector Current — Continuous	I_C	-500	mAdc
Collector Current — Peak	$I_{C(P)}$	-1.0	Adc

THERMAL CHARACTERISTICS

Characteristic	Symbol	Max	Unit
Power Dissipation	P_D	200	mW
Junction Temperature	T_J	150	$^\circ\text{C}$
Storage Temperature	T_{stg}	-55 ~ +150	$^\circ\text{C}$

DEVICE MARKING



The "X" represents a smaller alpha digit Date Code. The Date Code indicates the actual month in which the part was manufactured.

Preferred devices are Motorola recommended choices for future use and best overall value.

replaces MSB710-QT1/D

ELECTRICAL CHARACTERISTICS ($T_A = 25^\circ\text{C}$)

Characteristic	Symbol	Min	Max	Unit
Collector–Emitter Breakdown Voltage ($I_C = -10\text{ mA}$, $I_B = 0$)	$V_{(BR)CEO}$	-50	—	Vdc
Collector–Base Breakdown Voltage ($I_C = -10\text{ }\mu\text{A}$, $I_E = 0$)	$V_{(BR)CBO}$	-60	—	Vdc
Emitter–Base Breakdown Voltage ($I_E = -10\text{ }\mu\text{A}$, $I_C = 0$)	$V_{(BR)EBO}$	-7.0	—	Vdc
Collector–Base Cutoff Current ($V_{CB} = -20\text{ Vdc}$, $I_E = 0$)	I_{CBO}	—	-0.1	μA
DC Current Gain ⁽¹⁾ ($V_{CE} = -10\text{ Vdc}$, $I_C = -150\text{ mA}$) ($V_{CE} = -10\text{ Vdc}$, $I_C = 500\text{ mA}$)	h_{FE1} h_{FE2}	120 40	240 —	—
Collector–Emitter Saturation Voltage ($I_C = -300\text{ mA}$, $I_B = -30\text{ mA}$)	$V_{CE(sat)}$	—	-0.6	Vdc
Collector–Base Saturation Voltage ($I_C = -300\text{ mA}$, $I_B = -30\text{ mA}$)	$V_{BE(sat)}$	—	-1.5	Vdc
Output Capacitance ($V_{CB} = -10\text{ Vdc}$, $I_E = 0$, $f = 1.0\text{ MHz}$)	C_{ob}	—	15	pF

1. Pulse Test: Pulse Width $\leq 300\text{ }\mu\text{s}$, D.C. $\leq 2\%$.

PNP Silicon General Purpose Amplifier Transistor

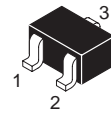
This PNP Silicon Epitaxial Planar Transistor is designed for general purpose amplifier applications. This device is housed in the SC-70/SOT-323 package which is designed for low power surface mount applications.

- High h_{FE} , 210–460
- Low $V_{CE(sat)}$, < 0.5 V
- Available in 8 mm, 7–inch/3000 Unit Tape and Reel

MSB1218A-RT1

Motorola Preferred Devices

PNP GENERAL PURPOSE AMPLIFIER TRANSISTORS SURFACE MOUNT



CASE 419-02, STYLE 3
SC-70/SOT-323

MAXIMUM RATINGS ($T_A = 25^\circ\text{C}$)

Rating	Symbol	Value	Unit
Collector–Base Voltage	$V_{(BR)CBO}$	45	Vdc
Collector–Emitter Voltage	$V_{(BR)CEO}$	45	Vdc
Emitter–Base Voltage	$V_{(BR)EBO}$	7.0	Vdc
Collector Current — Continuous	I_C	100	mAdc
Collector Current — Peak	$I_{C(P)}$	200	mAdc

DEVICE MARKING

MSB1218A-RT1 = BR

THERMAL CHARACTERISTICS

Rating	Symbol	Max	Unit
Power Dissipation ⁽¹⁾	P_D	150	mW
Junction Temperature	T_J	150	$^\circ\text{C}$
Storage Temperature Range	T_{stg}	-55 ~ +150	$^\circ\text{C}$

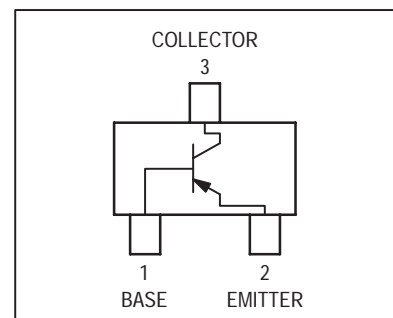
ELECTRICAL CHARACTERISTICS

Characteristic	Symbol	Min	Max	Unit
Collector–Emitter Breakdown Voltage ($I_C = 2.0 \text{ mAdc}$, $I_B = 0$)	$V_{(BR)CEO}$	45	—	Vdc
Collector–Base Breakdown Voltage ($I_C = 10 \mu\text{Adc}$, $I_E = 0$)	$V_{(BR)CBO}$	45	—	Vdc
Emitter–Base Breakdown Voltage ($I_E = 10 \mu\text{Adc}$, $I_C = 0$)	$V_{(BR)EBO}$	7.0	—	Vdc
Collector–Base Cutoff Current ($V_{CB} = 20 \text{ Vdc}$, $I_E = 0$)	I_{CBO}	—	0.1	μA
Collector–Emitter Cutoff Current ($V_{CE} = 10 \text{ Vdc}$, $I_B = 0$)	I_{CEO}	—	100	μA
DC Current Gain ⁽²⁾ ($V_{CE} = 10 \text{ Vdc}$, $I_C = 2.0 \text{ mAdc}$)	h_{FE1}	210	340	—
Collector–Emitter Saturation Voltage ⁽²⁾ ($I_C = 100 \text{ mAdc}$, $I_B = 10 \text{ mAdc}$)	$V_{CE(sat)}$	—	0.5	Vdc

1. Device mounted on a FR-4 glass epoxy printed circuit board using the minimum recommended footprint.

2. Pulse Test: Pulse Width $\leq 300 \mu\text{s}$, D.C. $\leq 2\%$.

Preferred devices are Motorola recommended choices for future use and best overall value.



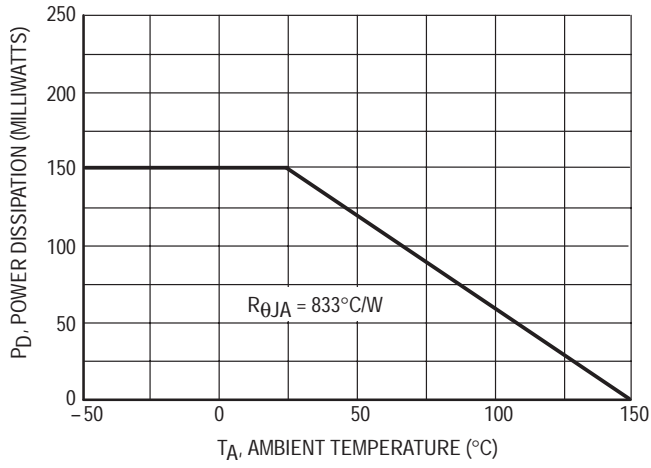


Figure 1. Derating Curve

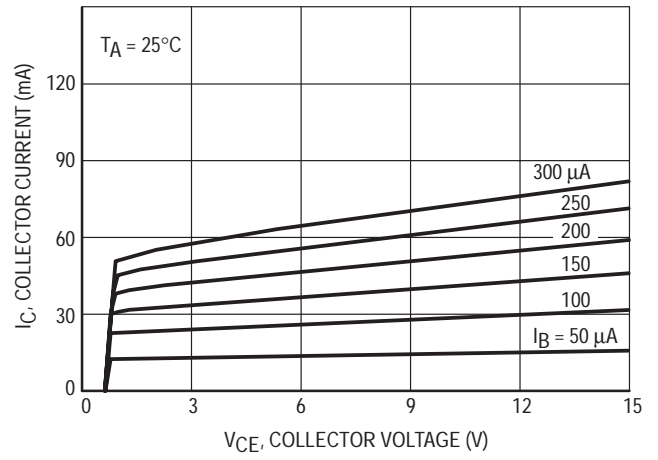


Figure 2. I_C – V_{CE}

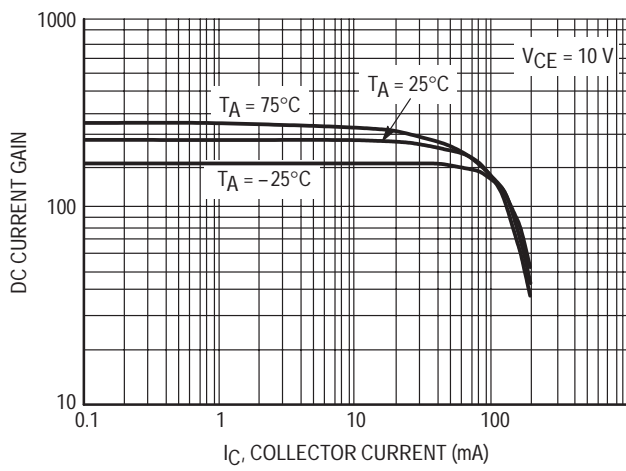


Figure 3. DC Current Gain

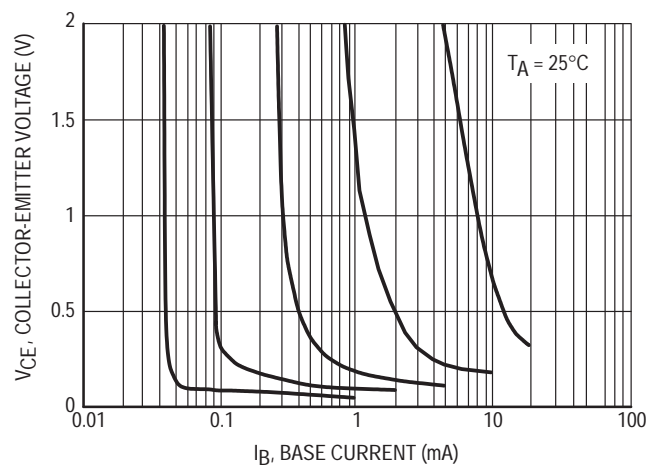


Figure 4. Collector Saturation Region

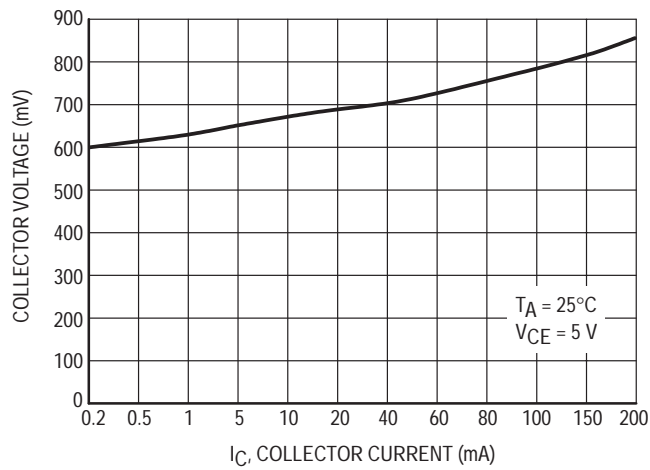


Figure 5. On Voltage

MSB1218A-RT1

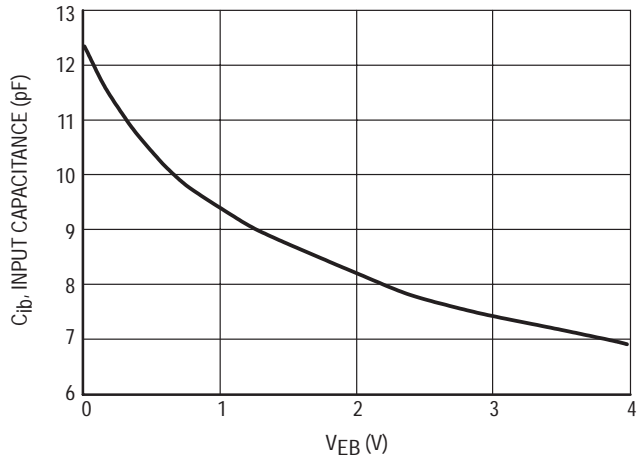


Figure 6. Capacitance

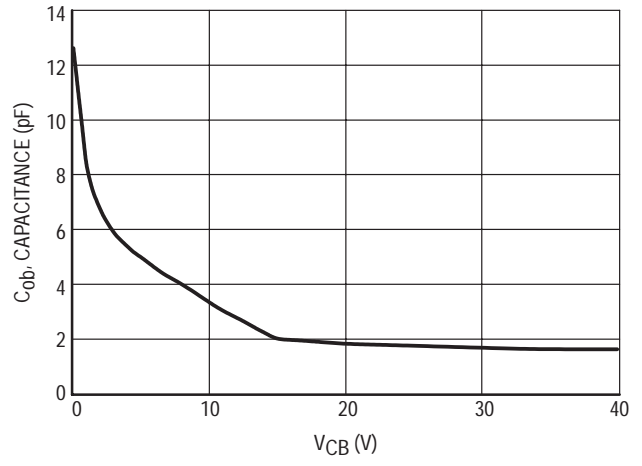


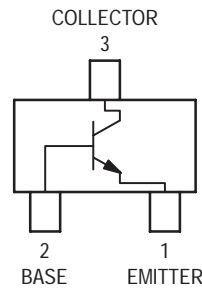
Figure 7. Capacitance

NPN RF Amplifier Transistors

Surface Mount

MSC2295-BT1
MSC2295-CT1

Motorola Preferred Devices



CASE 318D-03, STYLE 1
SC-59

MAXIMUM RATINGS (T_A = 25°C)

Rating	Symbol	Value	Unit
Collector-Base Voltage	V _{(BR)CBO}	30	Vdc
Collector-Emitter Voltage	V _{(BR)CEO}	20	Vdc
Emitter-Base Voltage	V _{(BR)EBO}	5.0	Vdc
Collector Current — Continuous	I _C	30	mAdc

THERMAL CHARACTERISTICS

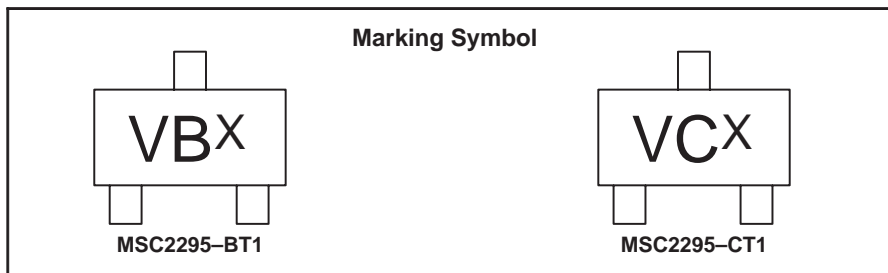
Characteristic	Symbol	Max	Unit
Power Dissipation	P _D	200	mW
Junction Temperature	T _J	150	°C
Storage Temperature	T _{stg}	-55 ~ +150	°C

ELECTRICAL CHARACTERISTICS (T_A = 25°C)

Characteristic	Symbol	Min	Max	Unit
Collector-Base Cutoff Current (V _{CB} = 10 Vdc, I _E = 0)	I _{CBO}	—	0.1	μAdc
DC Current Gain ⁽¹⁾ (V _{CB} = 10 Vdc, I _C = -1.0 mAdc)	h _{FE}	70 110	140 220	—
Collector-Gain — Bandwidth Product (V _{CB} = 10 Vdc, I _E = -1.0 mAdc)	f _T	150	—	MHz
Reverse Transistor Capacitance (V _{CE} = 10 Vdc, I _C = 1.0 mAdc, f = 10.7 MHz)	C _{re}	—	1.5	pF

1. Pulse Test: Pulse Width ≤ 300 μs, D.C. ≤ 2%.

DEVICE MARKING



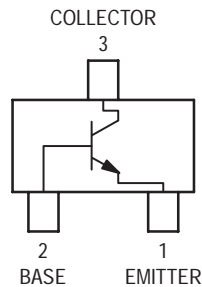
The "X" represents a smaller alpha digit Date Code. The Date Code indicates the actual month in which the part was manufactured.

Preferred devices are Motorola recommended choices for future use and best overall value.

NPN RF Amplifier Transistor Surface Mount

MSC3130T1

Motorola Preferred Device



CASE 318D-03, STYLE 1
SC-59

MAXIMUM RATINGS ($T_A = 25^\circ\text{C}$)

Rating	Symbol	Value	Unit
Collector-Base Voltage	V_{CB0}	15	Vdc
Collector-Emitter Voltage	V_{CEO}	10	Vdc
Emitter-Base Voltage	V_{EBO}	3.0	Vdc
Collector Current — Continuous	I_C	50	mAdc

THERMAL CHARACTERISTICS

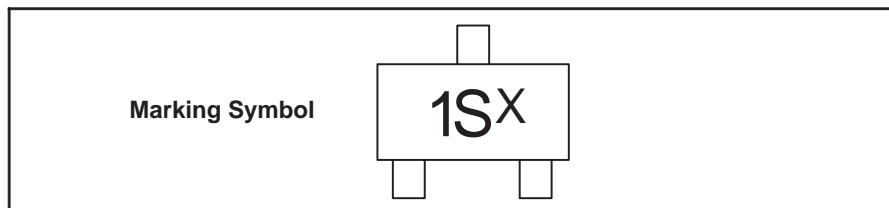
Characteristic	Symbol	Max	Unit
Power Dissipation	P_D	200	mW
Junction Temperature	T_J	150	$^\circ\text{C}$
Storage Temperature	T_{stg}	-55 ~ +150	$^\circ\text{C}$

ELECTRICAL CHARACTERISTICS ($T_A = 25^\circ\text{C}$)

Characteristic	Symbol	Min	Max	Unit
Collector Cutoff Current ($V_{CB} = 10 \text{ Vdc}$, $I_E = 0$)	I_{CBO}	—	1.0	μAdc
Collector-Emitter Breakdown Voltage ($I_C = 2.0 \text{ mAdc}$, $I_B = 0$)	V_{CEO}	10	—	Vdc
Emitter-Base Breakdown Voltage ($I_E = 10 \mu\text{Adc}$, $I_C = 0$)	V_{EBO}	3.0	—	Vdc
DC Current Gain ⁽¹⁾ ($V_{CE} = 4.0 \text{ Vdc}$, $I_C = 5.0 \text{ mAdc}$)	h_{FE}	75	400	—
Collector-Emitter Saturation Voltage ($I_C = 20 \text{ mAdc}$, $I_B = 4.0 \text{ mAdc}$)	$V_{CE(sat)}$	—	0.5	Vdc
Current-Gain — Bandwidth Product ($V_{CB} = 4.0 \text{ Vdc}$, $I_E = -5.0 \text{ mAdc}$)	f_T	1.4	2.5	GHz

1. Pulse Test: Pulse Width $\leq 300 \mu\text{s}$, D.C. $\leq 2\%$.

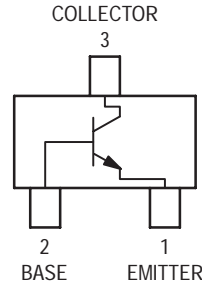
DEVICE MARKING



The "X" represents a smaller alpha digit Date Code. The Date Code indicates the actual month in which the part was manufactured.

Preferred devices are Motorola recommended choices for future use and best overall value.

NPN General Purpose Amplifier Transistors Surface Mount



MSD601-RT1*
MSD601-ST1

*Motorola Preferred Device



CASE 318D-03, STYLE 1
SC-59

MAXIMUM RATINGS (T_A = 25°C)

Rating	Symbol	Value	Unit
Collector–Base Voltage	V _{(BR)CBO}	60	Vdc
Collector–Emitter Voltage	V _{(BR)CEO}	50	Vdc
Emitter–Base Voltage	V _{(BR)EBO}	7.0	Vdc
Collector Current — Continuous	I _C	100	mAdc
Collector Current — Peak	I _{C(P)}	200	mAdc

THERMAL CHARACTERISTICS

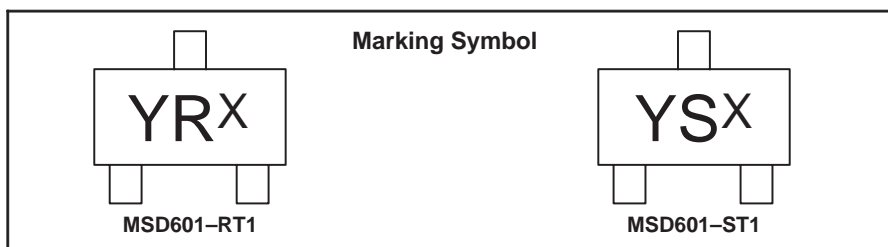
Characteristic	Symbol	Max	Unit
Power Dissipation	P _D	200	mW
Junction Temperature	T _J	150	°C
Storage Temperature	T _{stg}	-55 ~ +150	°C

ELECTRICAL CHARACTERISTICS (T_A = 25°C)

Characteristic	Symbol	Min	Max	Unit
Collector–Emitter Breakdown Voltage (I _C = 2.0 mAdc, I _B = 0)	V _{(BR)CEO}	50	—	Vdc
Collector–Base Breakdown Voltage (I _C = 10 μAdc, I _E = 0)	V _{(BR)CBO}	60	—	Vdc
Emitter–Base Breakdown Voltage (I _E = 10 μAdc, I _C = 0)	V _{(BR)EBO}	7.0	—	Vdc
Collector–Base Cutoff Current (V _{CB} = 45 Vdc, I _E = 0)	I _{CB0}	—	0.1	μAdc
Collector–Emitter Cutoff Current (V _{CE} = 10 Vdc, I _B = 0)	I _{CEO}	—	100	nAdc
DC Current Gain ⁽¹⁾ (V _{CE} = 10 Vdc, I _C = 2.0 mAdc)	MSD601-RT1 h _{FE1}	210	340	—
(V _{CE} = 2.0 Vdc, I _C = 100 mAdc)	MSD601-ST1 h _{FE2}	290	460	—
		90	—	—
Collector–Emitter Saturation Voltage (I _C = 100 mAdc, I _B = 10 mAdc)	V _{CE(sat)}	—	0.5	Vdc

1. Pulse Test: Pulse Width ≤ 300 μs, D.C. ≤ 2%.

DEVICE MARKING



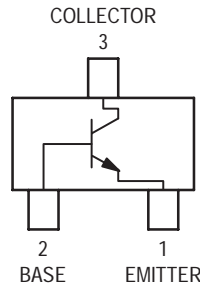
The "X" represents a smaller alpha digit Date Code. The Date Code indicates the actual month in which the part was manufactured.

Preferred devices are Motorola recommended choices for future use and best overall value.

NPN General Purpose Amplifier Transistor Surface Mount

MSD602-RT1

Motorola Preferred Device



CASE 318D-03, STYLE 1
SC-59

MAXIMUM RATINGS ($T_A = 25^\circ\text{C}$)

Rating	Symbol	Value	Unit
Collector–Base Voltage	$V_{(BR)CBO}$	60	Vdc
Collector–Emitter Voltage	$V_{(BR)CEO}$	50	Vdc
Emitter–Base Voltage	$V_{(BR)EBO}$	7.0	Vdc
Collector Current — Continuous	I_C	500	mAdc
Collector Current — Peak	$I_{C(P)}$	1.0	Adc

THERMAL CHARACTERISTICS

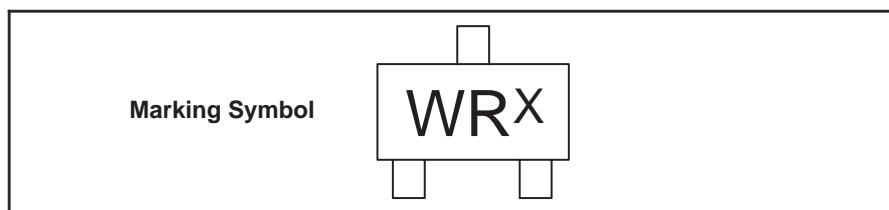
Characteristic	Symbol	Max	Unit
Power Dissipation	P_D	200	mW
Junction Temperature	T_J	150	$^\circ\text{C}$
Storage Temperature	T_{stg}	-55 ~ +150	$^\circ\text{C}$

ELECTRICAL CHARACTERISTICS ($T_A = 25^\circ\text{C}$)

Characteristic	Symbol	Min	Max	Unit
Collector–Emitter Breakdown Voltage ($I_C = 10\text{ mAdc}$, $I_B = 0$)	$V_{(BR)CEO}$	50	—	Vdc
Collector–Base Breakdown Voltage ($I_C = 10\ \mu\text{Adc}$, $I_E = 0$)	$V_{(BR)CBO}$	60	—	Vdc
Emitter–Base Breakdown Voltage ($I_E = 10\ \mu\text{Adc}$, $I_C = 0$)	$V_{(BR)EBO}$	7.0	—	Vdc
Collector–Base Cutoff Current ($V_{CB} = 20\text{ Vdc}$, $I_E = 0$)	I_{CBO}	—	0.1	μAdc
DC Current Gain ⁽¹⁾ ($V_{CE} = 10\text{ Vdc}$, $I_C = 150\text{ mAdc}$) ($V_{CE} = 10\text{ Vdc}$, $I_C = 500\text{ mAdc}$)	h_{FE1} h_{FE2}	120 40	240 —	—
Collector–Emitter Saturation Voltage ($I_C = 300\text{ mAdc}$, $I_B = 30\text{ mAdc}$)	$V_{CE(sat)}$	—	0.6	Vdc
Output Capacitance ($V_{CB} = 10\text{ Vdc}$, $I_E = 0$, $f = 1.0\text{ MHz}$)	C_{ob}	—	15	pF

1. Pulse Test: Pulse Width $\leq 300\ \mu\text{s}$, D.C. $\leq 2\%$.

DEVICE MARKING



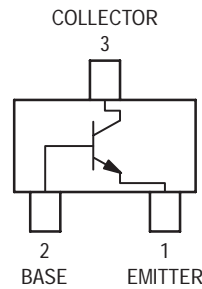
The "X" represents a smaller alpha digit Date Code. The Date Code indicates the actual month in which the part was manufactured.

Preferred devices are Motorola recommended choices for future use and best overall value.

NPN Low Voltage Output Amplifier Surface Mount

MSD1328-RT1

Motorola Preferred Device



CASE 318D-03, STYLE 1
SC-59

MAXIMUM RATINGS (T_A = 25°C)

Rating	Symbol	Value	Unit
Collector-Base Voltage	V _{(BR)CBO}	25	Vdc
Collector-Emitter Voltage	V _{(BR)CEO}	20	Vdc
Emitter-Base Voltage	V _{(BR)EBO}	12	Vdc
Collector Current — Continuous	I _C	500	mAdc
Collector Current — Peak	I _{C(P)}	1000	mAdc

THERMAL CHARACTERISTICS

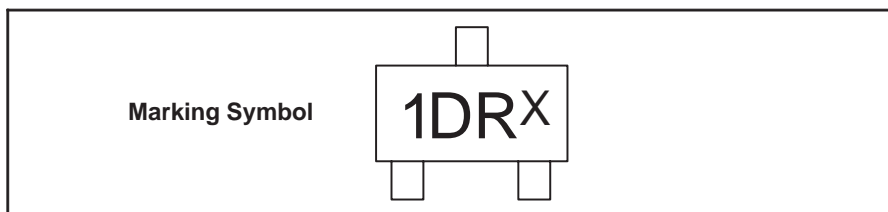
Characteristic	Symbol	Max	Unit
Power Dissipation	P _D	200	mW
Junction Temperature	T _J	150	°C
Storage Temperature	T _{stg}	-55 ~ +150	°C

ELECTRICAL CHARACTERISTICS (T_A = 25°C)

Characteristic	Symbol	Min	Max	Unit
Collector-Emitter Breakdown Voltage (I _C = 1.0 mAdc, I _B = 0)	V _{(BR)CEO}	20	—	Vdc
Collector-Base Breakdown Voltage (I _C = 10 μAdc, I _E = 0)	V _{(BR)CBO}	25	—	Vdc
Emitter-Base Breakdown Voltage (I _E = 10 μAdc, I _C = 0)	V _{(BR)EBO}	12	—	Vdc
Collector-Base Cutoff Current (V _{CB} = 25 Vdc, I _E = 0)	I _{CBO}	—	0.1	μAdc
DC Current Gain ⁽¹⁾ (V _{CE} = 2.0 Vdc, I _C = 500 mAdc)	h _{FE}	200	350	—
Collector-Emitter Saturation Voltage (I _C = 500 mAdc, I _B = 20 mAdc)	V _{CE(sat)}	—	0.4	Vdc
Base-Emitter Saturation Voltage (I _C = 500 mAdc, I _B = 50 mAdc)	V _{BE(sat)}	—	1.2	Vdc

1. Pulse Test: Pulse Width ≤ 300 μs, D.C. ≤ 2%.

DEVICE MARKING



The "X" represents a smaller alpha digit Date Code. The Date Code indicates the actual month in which the part was manufactured.

Preferred devices are Motorola recommended choices for future use and best overall value.

NPN Silicon General Purpose Amplifier Transistor

This NPN Silicon Epitaxial Planar Transistor is designed for general purpose amplifier applications. This device is housed in the SC-70/SOT-323 package which is designed for low power surface mount applications.

- High h_{FE} , 210–460
- Low $V_{CE(sat)}$, < 0.5 V
- Available in 8 mm, 7-inch/3000 Unit Tape and Reel

MAXIMUM RATINGS ($T_A = 25^\circ\text{C}$)

Rating	Symbol	Value	Unit
Collector-Base Voltage	$V_{(BR)CBO}$	60	Vdc
Collector-Emitter Voltage	$V_{(BR)CEO}$	50	Vdc
Emitter-Base Voltage	$V_{(BR)EBO}$	7.0	Vdc
Collector Current — Continuous	I_C	100	mAdc
Collector Current — Peak	$I_{C(P)}$	200	mAdc

DEVICE MARKING

MSD1819A-RT1 = ZR

THERMAL CHARACTERISTICS

Rating	Symbol	Max	Unit
Power Dissipation ⁽¹⁾	P_D	150	mW
Junction Temperature	T_J	150	$^\circ\text{C}$
Storage Temperature Range	T_{stg}	-55 ~ +150	$^\circ\text{C}$

ELECTRICAL CHARACTERISTICS

Characteristic	Symbol	Min	Max	Unit
Collector-Emitter Breakdown Voltage ($I_C = 2.0 \text{ mAdc}$, $I_B = 0$)	$V_{(BR)CEO}$	50	—	Vdc
Collector-Base Breakdown Voltage ($I_C = 10 \mu\text{Adc}$, $I_E = 0$)	$V_{(BR)CBO}$	60	—	Vdc
Emitter-Base Breakdown Voltage ($I_E = 10 \mu\text{Adc}$, $I_C = 0$)	$V_{(BR)EBO}$	7.0	—	Vdc
Collector-Base Cutoff Current ($V_{CB} = 20 \text{ Vdc}$, $I_E = 0$)	I_{CBO}	—	0.1	μA
Collector-Emitter Cutoff Current ($V_{CE} = 10 \text{ Vdc}$, $I_B = 0$)	I_{CEO}	—	100	μA
DC Current Gain ⁽²⁾ ($V_{CE} = 10 \text{ Vdc}$, $I_C = 2.0 \text{ mAdc}$) ($V_{CE} = 2.0 \text{ Vdc}$, $I_C = 100 \text{ mAdc}$)	h_{FE1} h_{FE2}	210 90	340 —	—
Collector-Emitter Saturation Voltage ⁽²⁾ ($I_C = 100 \text{ mAdc}$, $I_B = 10 \text{ mAdc}$)	$V_{CE(sat)}$	—	0.5	Vdc

1. Device mounted on a FR-4 glass epoxy printed circuit board using the minimum recommended footprint.

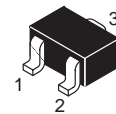
2. Pulse Test: Pulse Width $\leq 300 \mu\text{s}$, D.C. $\leq 2\%$.

Preferred devices are Motorola recommended choices for future use and best overall value.

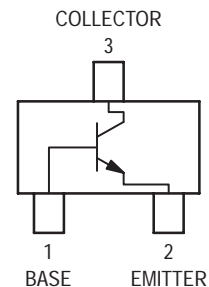
MSD1819A-RT1

Motorola Preferred Devices

**NPN GENERAL
PURPOSE AMPLIFIER
TRANSISTORS
SURFACE MOUNT**



**CASE 419-02, STYLE 3
SC-70/SOT-323**



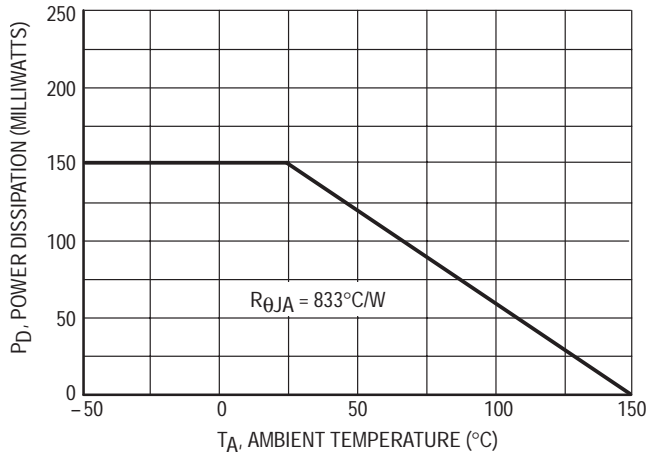


Figure 1. Derating Curve

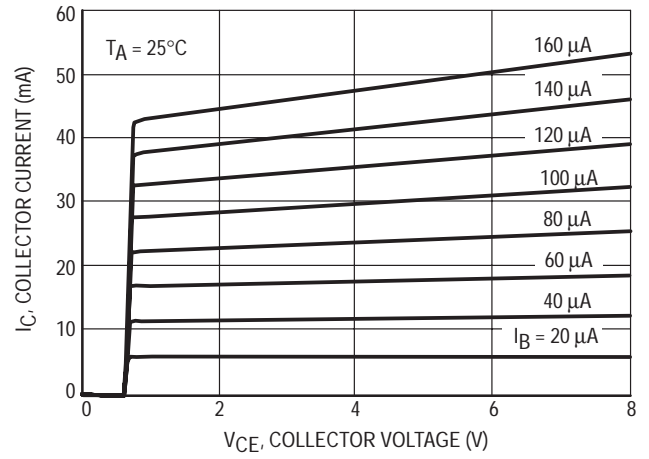


Figure 2. IC - VCE

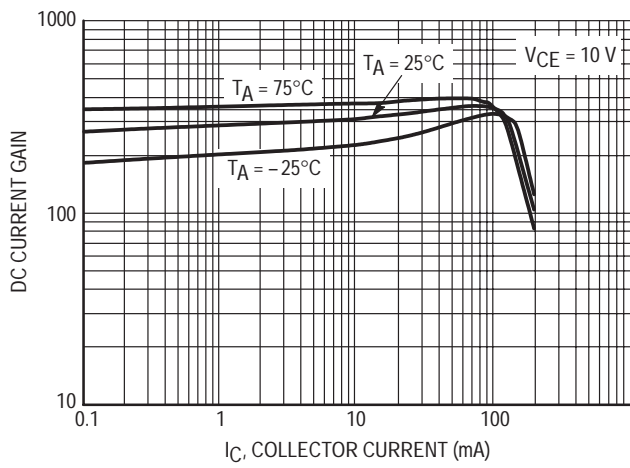


Figure 3. DC Current Gain

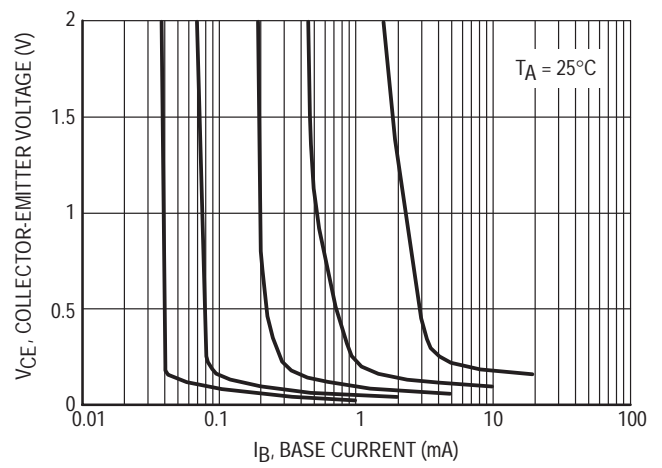


Figure 4. Collector Saturation Region

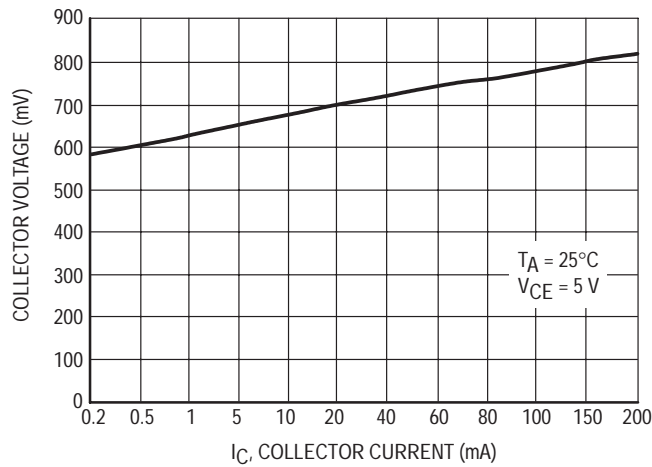


Figure 5. On Voltage

MSD1819A-RT1

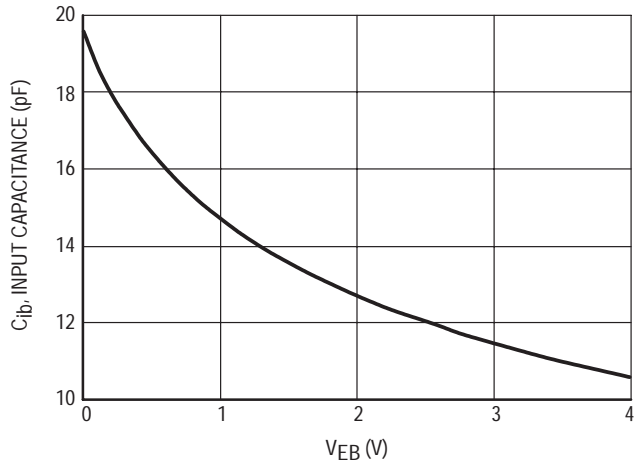


Figure 6. Capacitance

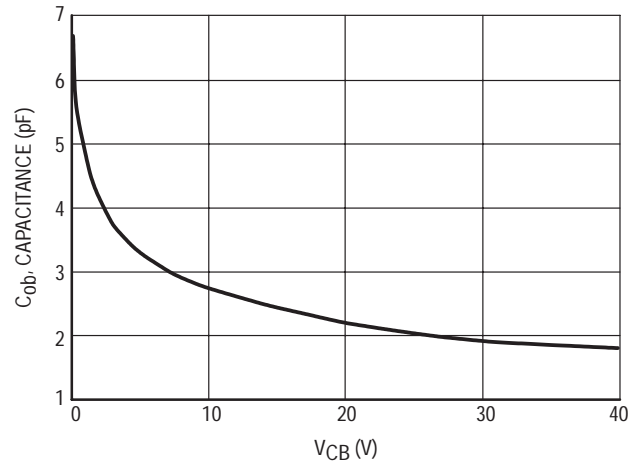


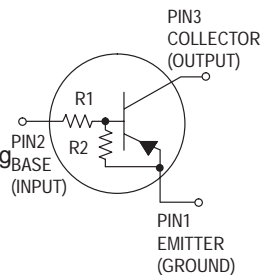
Figure 7. Capacitance

Bias Resistor Transistor

PNP Silicon Surface Mount Transistor with Monolithic Bias Resistor Network

This new series of digital transistors is designed to replace a single device and its external resistor bias network. The BRT (Bias Resistor Transistor) contains a single transistor with a monolithic bias network consisting of two resistors; a series base resistor and a base-emitter resistor. The BRT eliminates these individual components by integrating them into a single device. The use of a BRT can reduce both system cost and board space. The device is housed in the SC-59 package which is designed for low power surface mount applications.

- Simplifies Circuit Design
- Reduces Board Space
- Reduces Component Count
- The SC-59 package can be soldered using wave or reflow. The modified gull-winged leads absorb thermal stress during soldering eliminating the possibility of damage to the die.
- Available in 8 mm embossed tape and reel. Use the Device Number to order the 7 inch/3000 unit reel.



MUN2111T1 SERIES

Motorola Preferred Devices

PNP SILICON BIAS RESISTOR TRANSISTOR



CASE 318D-03, STYLE 1
(SC-59)

MAXIMUM RATINGS (T_A = 25°C unless otherwise noted)

Rating	Symbol	Value	Unit
Collector-Base Voltage	V _{CBO}	50	Vdc
Collector-Emitter Voltage	V _{CEO}	50	Vdc
Collector Current	I _C	100	mAdc
Total Power Dissipation @ T _A = 25°C(1) Derate above 25°C	P _D	200 1.6	mW mW/°C

THERMAL CHARACTERISTICS

Thermal Resistance — Junction-to-Ambient (surface mounted)	R _{θJA}	625	°C/W
Operating and Storage Temperature Range	T _J , T _{stg}	-65 to +150	°C
Maximum Temperature for Soldering Purposes, Time in Solder Bath	T _L	260 10	°C Sec

DEVICE MARKING AND RESISTOR VALUES

Device	Marking	R1 (K)	R2 (K)
MUN2111T1	6A	10	10
MUN2112T1	6B	22	22
MUN2113T1	6C	47	47
MUN2114T1	6D	10	47
MUN2115T1(2)	6E	10	∞
MUN2116T1(2)	6F	4.7	∞
MUN2130T1(2)	6G	1.0	1.0
MUN2131T1(2)	6H	2.2	2.2
MUN2132T1(2)	6J	4.7	4.7
MUN2133T1(2)	6K	4.7	47
MUN2134T1(2)	6L	22	47

1. Device mounted on a FR-4 glass epoxy printed circuit board using the minimum recommended footprint.
2. New devices. Updated curves to follow in subsequent data sheets.

Preferred devices are Motorola recommended choices for future use and best overall value.

MUN211T1 SERIES

ELECTRICAL CHARACTERISTICS ($T_A = 25^\circ\text{C}$ unless otherwise noted)

Characteristic	Symbol	Min	Typ	Max	Unit
OFF CHARACTERISTICS					
Collector–Base Cutoff Current ($V_{CB} = 50\text{ V}$, $I_E = 0$)	I_{CBO}	—	—	100	nAdc
Collector–Emitter Cutoff Current ($V_{CE} = 50\text{ V}$, $I_B = 0$)	I_{CEO}	—	—	500	nAdc
Emitter–Base Cutoff Current ($V_{EB} = 6.0\text{ V}$, $I_C = 0$)	I_{EBO}	—	—	0.5	mAdc
MUN2111T1		—	—	0.2	
MUN2112T1		—	—	0.1	
MUN2113T1		—	—	0.2	
MUN2114T1		—	—	0.9	
MUN2115T1		—	—	1.9	
MUN2116T1		—	—	4.3	
MUN2130T1		—	—	2.3	
MUN2131T1		—	—	1.5	
MUN2132T1		—	—	0.18	
MUN2133T1		—	—	0.13	
MUN2134T1		—	—		
Collector–Base Breakdown Voltage ($I_C = 10\ \mu\text{A}$, $I_E = 0$)	$V_{(BR)CBO}$	50	—	—	Vdc
Collector–Emitter Breakdown Voltage ⁽³⁾ ($I_C = 2.0\text{ mA}$, $I_B = 0$)	$V_{(BR)CEO}$	50	—	—	Vdc
ON CHARACTERISTICS⁽³⁾					
DC Current Gain ($V_{CE} = 10\text{ V}$, $I_C = 5.0\text{ mA}$)	h_{FE}	35	60	—	
MUN2111T1		60	100	—	
MUN2112T1		80	140	—	
MUN2113T1		80	140	—	
MUN2114T1		160	250	—	
MUN2115T1		160	250	—	
MUN2116T1		3.0	5.0	—	
MUN2130T1		8.0	15	—	
MUN2131T1		15	27	—	
MUN2132T1		80	140	—	
MUN2133T1		80	130	—	
MUN2134T1					
Collector–Emitter Saturation Voltage ($I_C = 10\text{ mA}$, $I_B = 0.3\text{ mA}$)	$V_{CE(sat)}$	—	—	0.25	Vdc
MUN2111T1		—	—	0.25	
MUN2112T1		—	—	0.25	
MUN2113T1		—	—	0.25	
MUN2114T1		—	—	0.25	
MUN2115T1		—	—	0.25	
MUN2130T1		—	—	0.25	
($I_C = 10\text{ mA}$, $I_B = 5.0\text{ mA}$)		—	—	0.25	
MUN2131T1		—	—	0.25	
($I_C = 10\text{ mA}$, $I_B = 1.0\text{ mA}$)		—	—	0.25	
MUN2116T1		—	—	0.25	
MUN2132T1		—	—	0.25	
MUN2134T1		—	—	0.25	
Output Voltage (on) ($V_{CC} = 5.0\text{ V}$, $V_B = 2.5\text{ V}$, $R_L = 1.0\text{ k}\Omega$)	V_{OL}	—	—	0.2	Vdc
MUN2111T1		—	—	0.2	
MUN2112T1		—	—	0.2	
MUN2114T1		—	—	0.2	
MUN2115T1		—	—	0.2	
MUN2116T1		—	—	0.2	
MUN2130T1		—	—	0.2	
MUN2131T1		—	—	0.2	
MUN2132T1		—	—	0.2	
MUN2133T1		—	—	0.2	
MUN2134T1		—	—	0.2	
($V_{CC} = 5.0\text{ V}$, $V_B = 3.5\text{ V}$, $R_L = 1.0\text{ k}\Omega$)		—	—	0.2	
MUN2113T1		—	—	0.2	

3. Pulse Test: Pulse Width < 300 μs , Duty Cycle < 2.0%

ELECTRICAL CHARACTERISTICS (Continued) ($T_A = 25^\circ\text{C}$ unless otherwise noted)

Characteristic	Symbol	Min	Typ	Max	Unit
Output Voltage (off) ($V_{CC} = 5.0\text{ V}$, $V_B = 0.5\text{ V}$, $R_L = 1.0\text{ k}\Omega$) ($V_{CC} = 5.0\text{ V}$, $V_B = 0.050\text{ V}$, $R_L = 1.0\text{ k}\Omega$) MUN2130T1 ($V_{CC} = 5.0\text{ V}$, $V_B = 0.25\text{ V}$, $R_L = 1.0\text{ k}\Omega$) MUN2115T1 MUN2116T1 MUN2131T1 MUN2132T1	V_{OH}	4.9	—	—	Vdc
Input Resistor MUN2111T1 MUN2112T1 MUN2113T1 MUN2114T1 MUN2115T1 MUN2116T1 MUN2130T1 MUN2131T1 MUN2132T1 MUN2133T1 MUN2134T1	R1	7.0 15.4 32.9 7.0 7.0 3.3 0.7 1.5 3.3 3.3 15.4	10 22 47 10 10 4.7 1.0 2.2 4.7 4.7 22	13 28.6 61.1 13 13 6.1 1.3 2.9 6.1 6.1 28.6	k Ω
Resistor Ratio MUN2111T1/MUN2112T1/MUN2113T1 MUN2114T1 MUN2115T1/MUN2116T1 MUN2130T1/MUN2131T1/MUN2132T1 MUN2133T1 MUN2134T1	R_1/R_2	0.8 0.17 — 0.8 0.055 0.38	1.0 0.21 — 1.0 0.1 0.47	1.2 0.25 — 1.2 0.185 0.56	

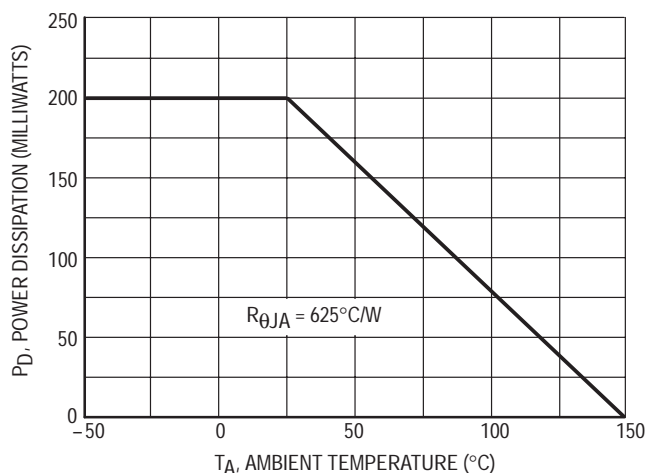


Figure 1. Derating Curve

TYPICAL ELECTRICAL CHARACTERISTICS — MUN2111T1

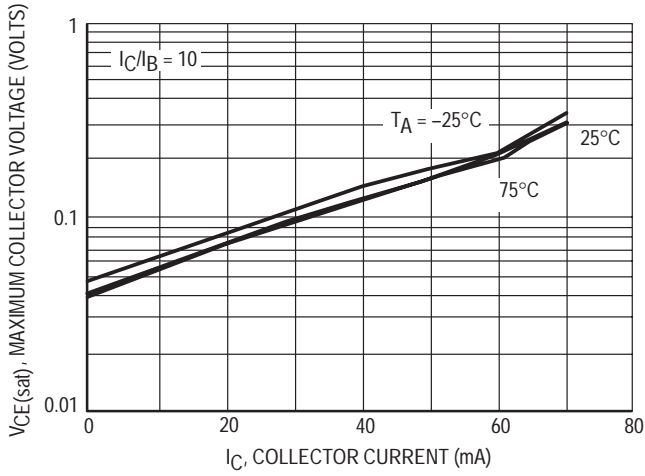


Figure 2. $V_{CE(sat)}$ versus I_C

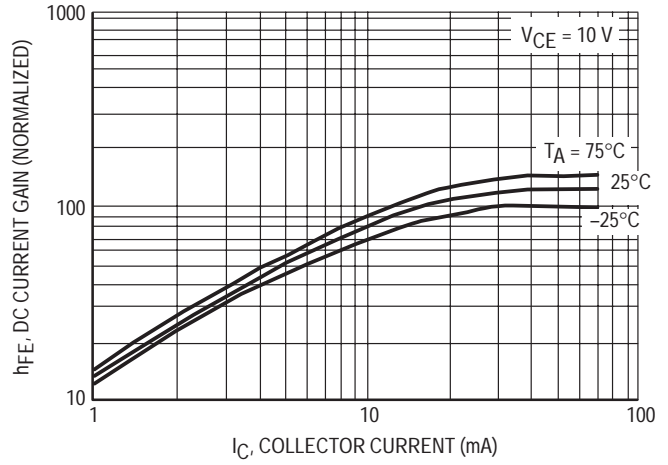


Figure 3. DC Current Gain

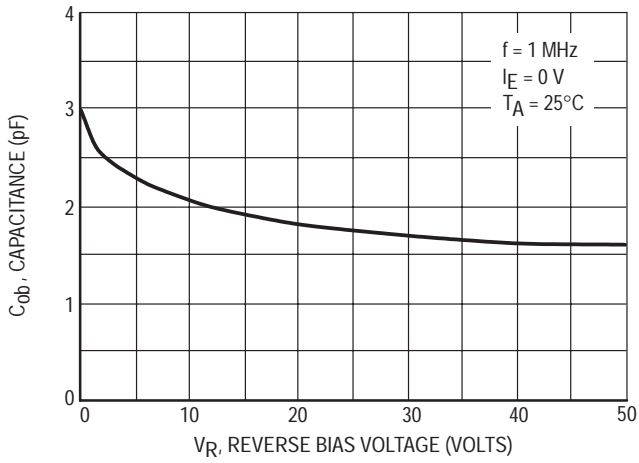


Figure 4. Output Capacitance

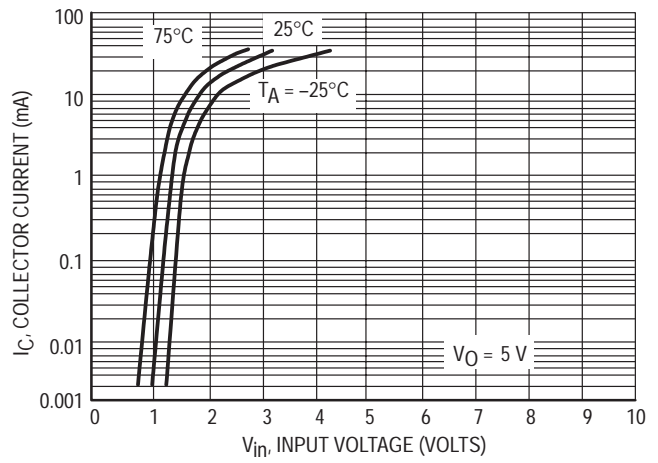


Figure 5. Output Current versus Input Voltage

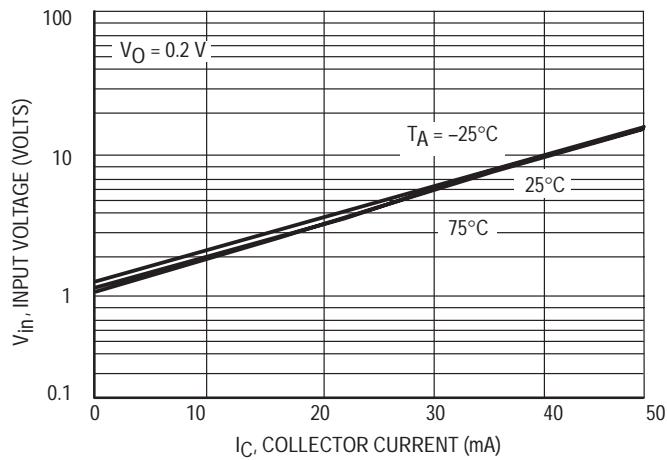


Figure 6. Input Voltage versus Output Current

TYPICAL ELECTRICAL CHARACTERISTICS — MUN2112T1

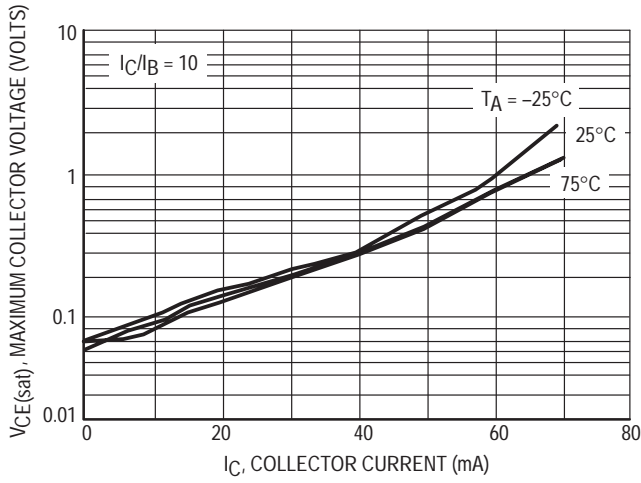


Figure 7. $V_{CE(sat)}$ versus I_C

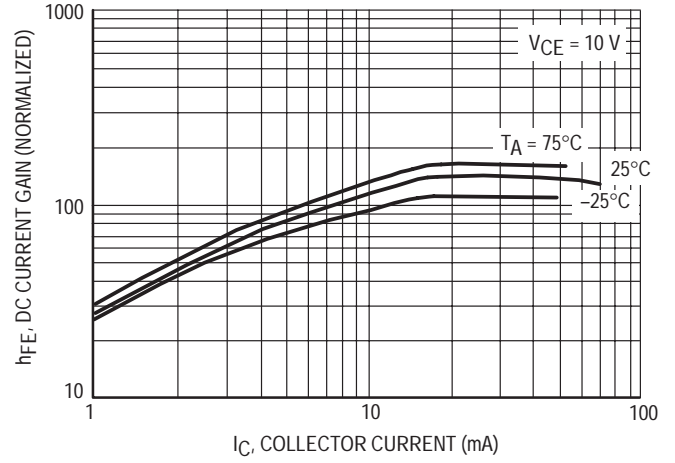


Figure 8. DC Current Gain

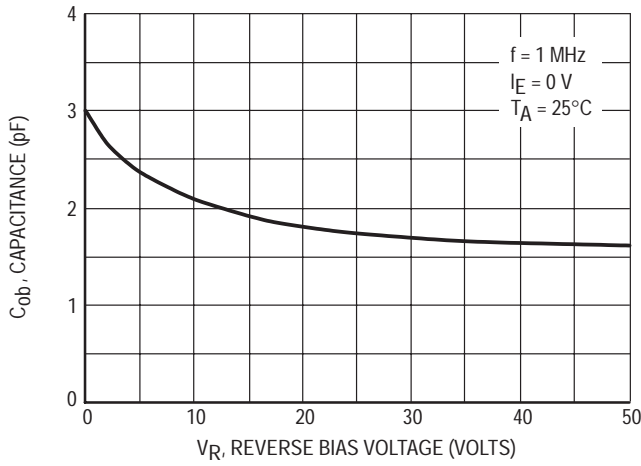


Figure 9. Output Capacitance

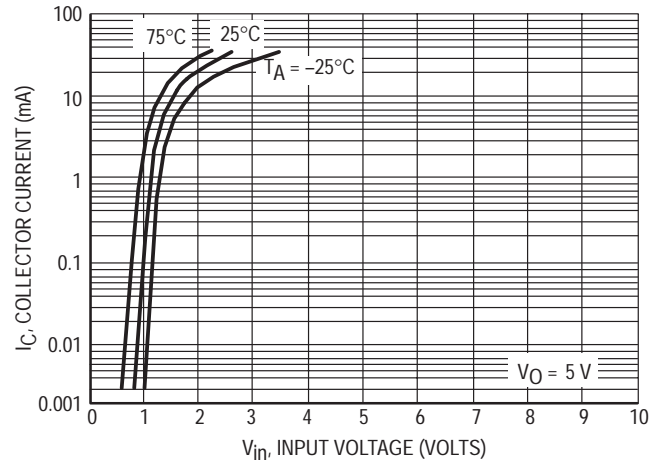


Figure 10. Output Current versus Input Voltage

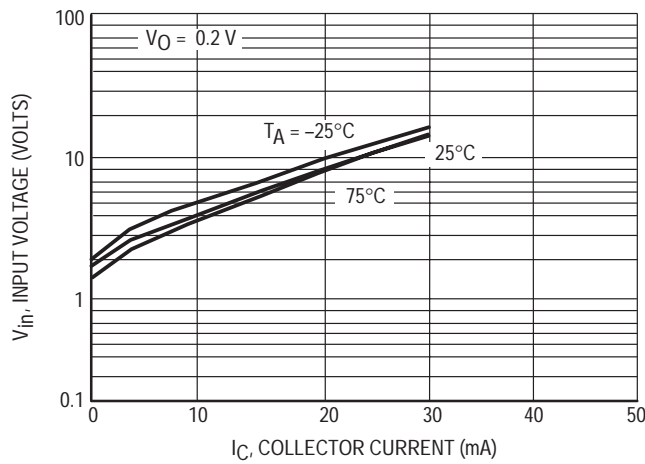


Figure 11. Input Voltage versus Output Current

TYPICAL ELECTRICAL CHARACTERISTICS — MUN2113T1

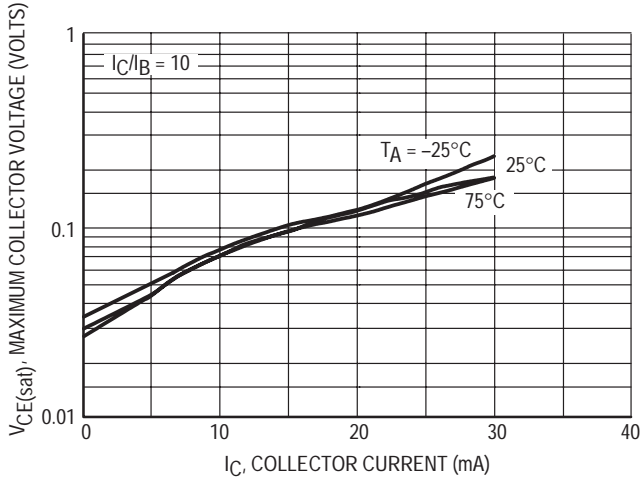


Figure 12. $V_{CE(sat)}$ versus I_C

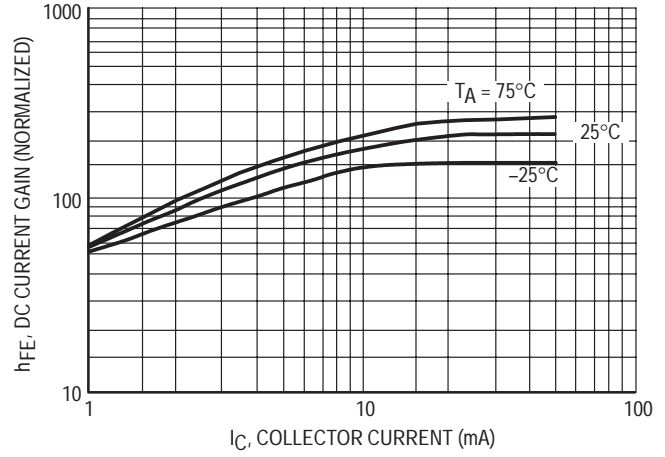


Figure 13. DC Current Gain

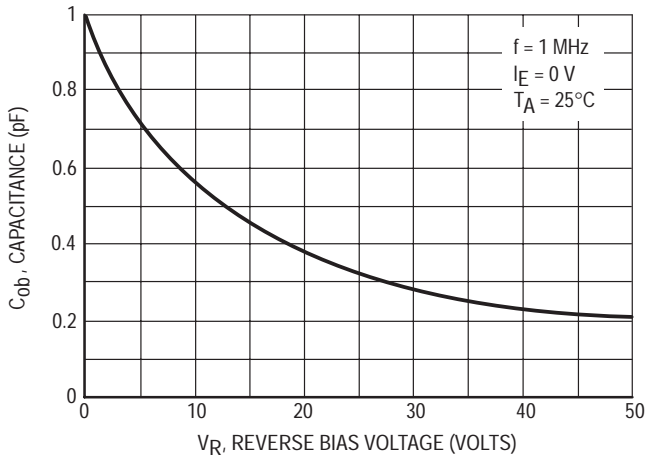


Figure 14. Output Capacitance

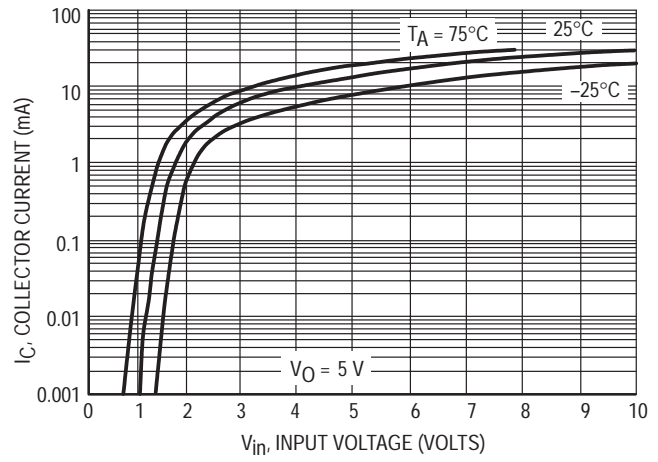


Figure 15. Output Current versus Input Voltage

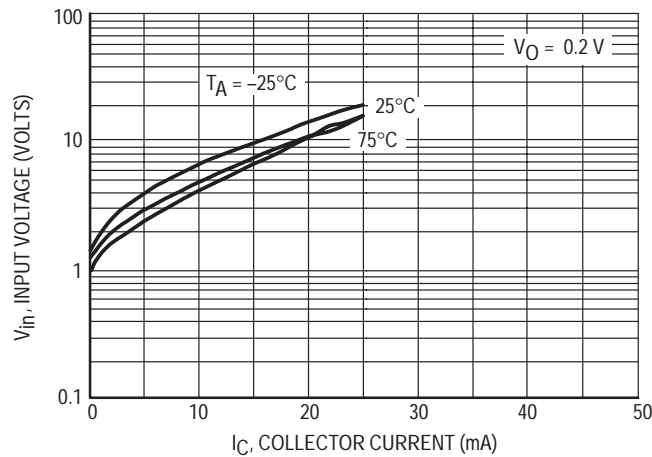


Figure 16. Input Voltage versus Output Current

TYPICAL ELECTRICAL CHARACTERISTICS — MUN2114T1

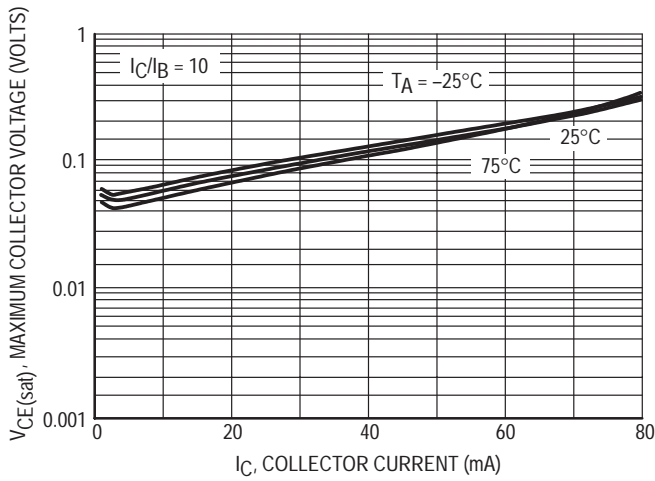


Figure 17. $V_{CE(sat)}$ versus I_C

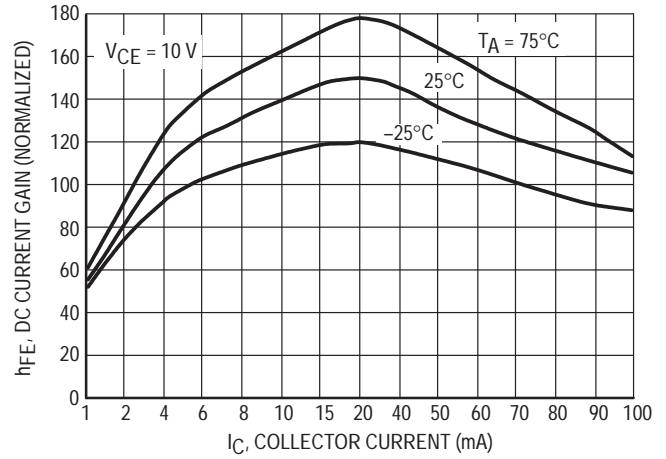


Figure 18. DC Current Gain

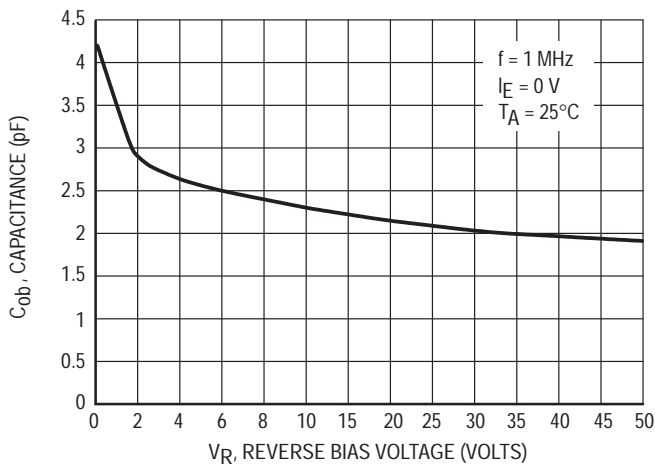


Figure 19. Output Capacitance

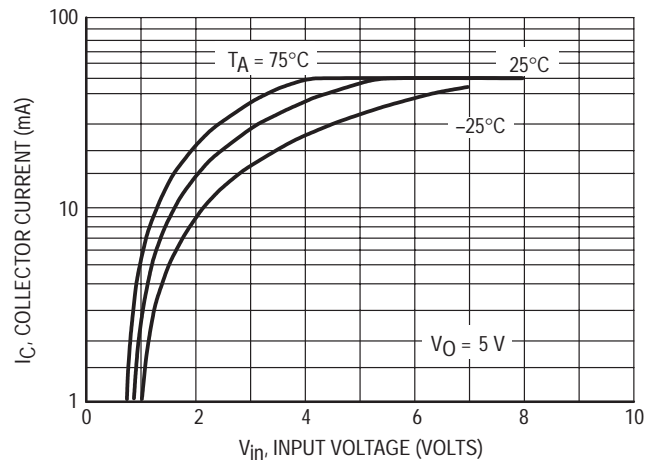


Figure 20. Output Current versus Input Voltage

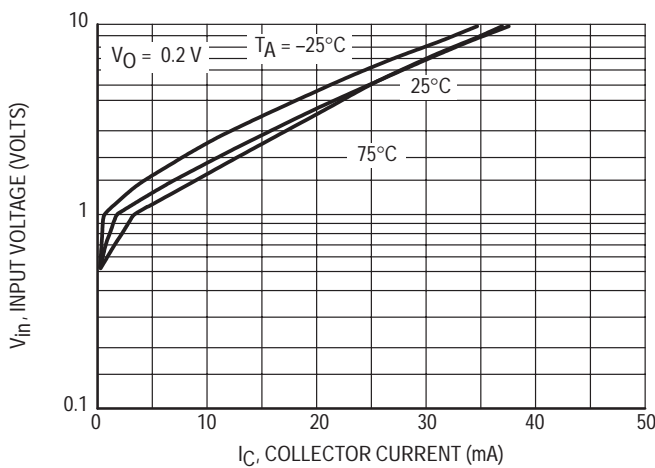


Figure 21. Input Voltage versus Output Current

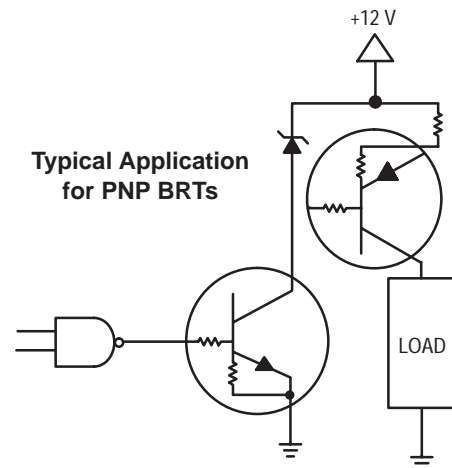


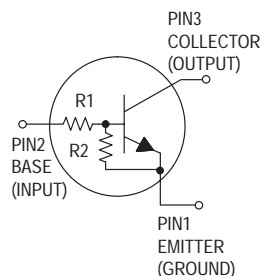
Figure 22. Inexpensive, Unregulated Current Source

Bias Resistor Transistor

NPN Silicon Surface Mount Transistor with Monolithic Bias Resistor Network

This new series of digital transistors is designed to replace a single device and its external resistor bias network. The BRT (Bias Resistor Transistor) contains a single transistor with a monolithic bias network consisting of two resistors; a series base resistor and a base-emitter resistor. The BRT eliminates these individual components by integrating them into a single device. The use of a BRT can reduce both system cost and board space. The device is housed in the SC-59 package which is designed for low power surface mount applications.

- Simplifies Circuit Design
- Reduces Board Space
- Reduces Component Count
- The SC-59 package can be soldered using wave or reflow. The modified gull-winged leads absorb thermal stress during soldering eliminating the possibility of damage to the die.
- Available in 8 mm embossed tape and reel
Use the Device Number to order the 7 inch/3000 unit reel.



MUN2211T1 SERIES

Motorola Preferred Devices

NPN SILICON BIAS RESISTOR TRANSISTOR



CASE 318D-03, STYLE 1
(SC-59)

MAXIMUM RATINGS ($T_A = 25^\circ\text{C}$ unless otherwise noted)

Rating	Symbol	Value	Unit
Collector-Base Voltage	V_{CBO}	50	Vdc
Collector-Emitter Voltage	V_{CEO}	50	Vdc
Collector Current	I_C	100	mAdc
Total Power Dissipation @ $T_A = 25^\circ\text{C}$ (1) Derate above 25°C	P_D	200 1.6	mW mW/ $^\circ\text{C}$

THERMAL CHARACTERISTICS

Thermal Resistance — Junction-to-Ambient (surface mounted)	$R_{\theta JA}$	625	$^\circ\text{C}/\text{W}$
Operating and Storage Temperature Range	T_J, T_{stg}	-65 to +150	$^\circ\text{C}$
Maximum Temperature for Soldering Purposes, Time in Solder Bath	T_L	260 10	$^\circ\text{C}$ Sec

DEVICE MARKING AND RESISTOR VALUES

Device	Marking	R1 (K)	R2 (K)
MUN2211T1	8A	10	10
MUN2212T1	8B	22	22
MUN2213T1	8C	47	47
MUN2214T1	8D	10	47
MUN2215T1(2)	8E	10	∞
MUN2216T1(2)	8F	4.7	∞
MUN2230T1(2)	8G	1.0	1.0
MUN2231T1(2)	8H	2.2	2.2
MUN2232T1(2)	8J	4.7	4.7
MUN2233T1(2)	8K	4.7	47
MUN2234T1(2)	8L	22	47

1. Device mounted on a FR-4 glass epoxy printed circuit board using the minimum recommended footprint.
2. New devices. Updated curves to follow in subsequent data sheets.

Preferred devices are Motorola recommended choices for future use and best overall value.

ELECTRICAL CHARACTERISTICS ($T_A = 25^\circ\text{C}$ unless otherwise noted)

Characteristic	Symbol	Min	Typ	Max	Unit
OFF CHARACTERISTICS					
Collector–Base Cutoff Current ($V_{CB} = 50\text{ V}$, $I_E = 0$)	I_{CBO}	—	—	100	nAdc
Collector–Emitter Cutoff Current ($V_{CE} = 50\text{ V}$, $I_B = 0$)	I_{CEO}	—	—	500	nAdc
Emitter–Base Cutoff Current ($V_{EB} = 6.0\text{ V}$, $I_C = 0$)	I_{EBO}	—	—	0.5	mAdc
MUN2211T1		—	—	0.2	
MUN2212T1		—	—	0.1	
MUN2213T1		—	—	0.2	
MUN2214T1		—	—	0.9	
MUN2215T1		—	—	1.9	
MUN2216T1		—	—	4.3	
MUN2230T1		—	—	2.3	
MUN2231T1		—	—	1.5	
MUN2232T1		—	—	0.18	
MUN2233T1		—	—	0.13	
MUN2234T1		—	—		
Collector–Base Breakdown Voltage ($I_C = 10\text{ }\mu\text{A}$, $I_E = 0$)	$V_{(BR)CBO}$	50	—	—	Vdc
Collector–Emitter Breakdown Voltage ⁽³⁾ ($I_C = 2.0\text{ mA}$, $I_B = 0$)	$V_{(BR)CEO}$	50	—	—	Vdc

ON CHARACTERISTICS⁽³⁾

DC Current Gain ($V_{CE} = 10\text{ V}$, $I_C = 5.0\text{ mA}$)		h_{FE}	35	60	—	
MUN2211T1			60	100	—	
MUN2212T1			80	140	—	
MUN2213T1			80	140	—	
MUN2214T1			160	350	—	
MUN2215T1			160	350	—	
MUN2216T1			3.0	5.0	—	
MUN2230T1			8.0	15	—	
MUN2231T1			15	30	—	
MUN2232T1			80	200	—	
MUN2233T1			80	150	—	
MUN2234T1						
Collector–Emitter Saturation Voltage ($I_C = 10\text{ mA}$, $I_B = 0.3\text{ mA}$) ($I_C = 10\text{ mA}$, $I_B = 5\text{ mA}$) MUN2230T1/MUN2231T1 ($I_C = 10\text{ mA}$, $I_B = 1\text{ mA}$) MUN2215T1/MUN2216T1/ MUN2232T1/MUN2233T1/MUN2234T1		$V_{CE(sat)}$	—	—	0.25	Vdc
Output Voltage (on) ($V_{CC} = 5.0\text{ V}$, $V_B = 2.5\text{ V}$, $R_L = 1.0\text{ k}\Omega$)		V_{OL}	—	—	0.2	Vdc
MUN2211T1			—	—	0.2	Vdc
MUN2212T1			—	—	0.2	Vdc
MUN2214T1			—	—	0.2	Vdc
MUN2215T1			—	—	0.2	Vdc
MUN2216T1			—	—	0.2	Vdc
MUN2230T1			—	—	0.2	Vdc
MUN2231T1			—	—	0.2	Vdc
MUN2232T1			—	—	0.2	Vdc
MUN2233T1			—	—	0.2	Vdc
MUN2234T1			—	—	0.2	Vdc
($V_{CC} = 5.0\text{ V}$, $V_B = 3.5\text{ V}$, $R_L = 1.0\text{ k}\Omega$)			—	—	0.2	Vdc
MUN2213T1			—	—	0.2	Vdc

3. Pulse Test: Pulse Width < 300 μs , Duty Cycle < 2.0%

MUN2211T1 SERIES

ELECTRICAL CHARACTERISTICS (Continued) ($T_A = 25^\circ\text{C}$ unless otherwise noted)

Characteristic	Symbol	Min	Typ	Max	Unit
Output Voltage (off) ($V_{CC} = 5.0\text{ V}$, $V_B = 0.5\text{ V}$, $R_L = 1.0\text{ k}\Omega$) ($V_{CC} = 5.0\text{ V}$, $V_B = 0.050\text{ V}$, $R_L = 1.0\text{ k}\Omega$) ($V_{CC} = 5.0\text{ V}$, $V_B = 0.25\text{ V}$, $R_L = 1.0\text{ k}\Omega$)	V_{OH}	4.9	—	—	Vdc
Input Resistor	R1				k Ω
MUN2211T1		7.0	10	13	
MUN2212T1		15.4	22	28.6	
MUN2213T1		32.9	47	61.1	
MUN2214T1		7.0	10	13	
MUN2215T1		7.0	10	13	
MUN2216T1		3.3	4.7	6.1	
MUN2230T1		0.7	1.0	1.3	
MUN2231T1		1.5	2.2	2.9	
MUN2232T1		3.3	4.7	6.1	
MUN2233T1		3.3	4.7	6.1	
MUN2234T1		15.4	22	28.6	
Resistor Ratio	R1/R2				
MUN2211T1/MUN2212T1/MUN2213T1		0.8	1.0	1.2	
MUN2214T1		0.17	0.21	0.25	
MUN2215T1/MUN2216T1		—	—	—	
MUN2230T1/MUN2231T1/MUN2232T1		0.8	1.0	1.2	
MUN2233T1		0.055	0.1	0.185	
MUN2234T1		0.38	0.47	0.56	

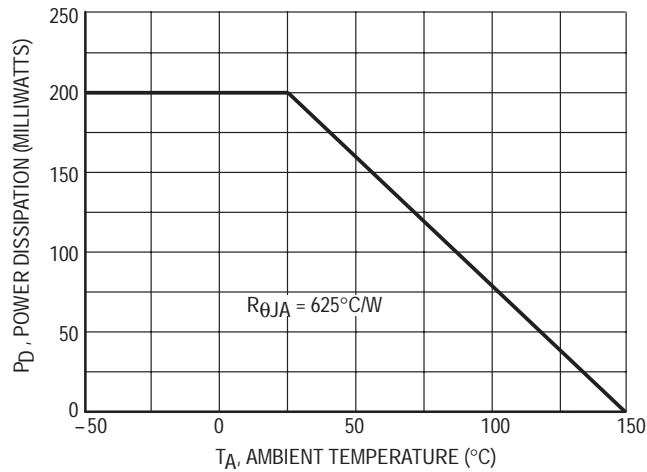


Figure 1. Derating Curve

TYPICAL ELECTRICAL CHARACTERISTICS — MUN2211T1

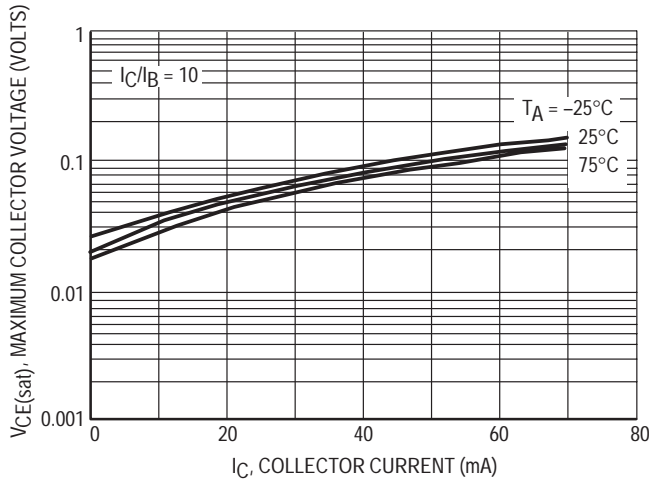


Figure 2. $V_{CE(sat)}$ versus I_C

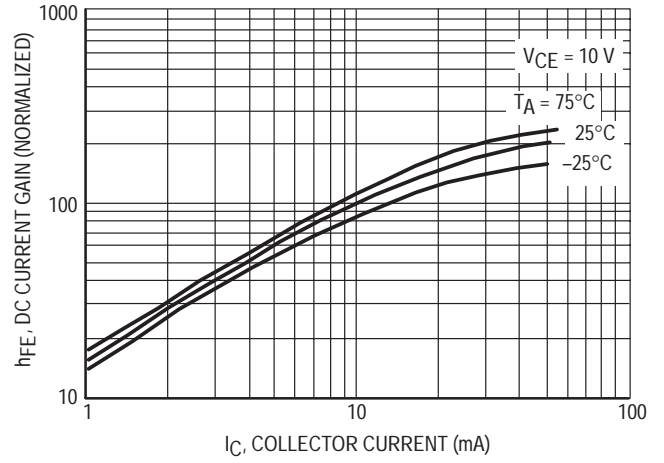


Figure 3. DC Current Gain

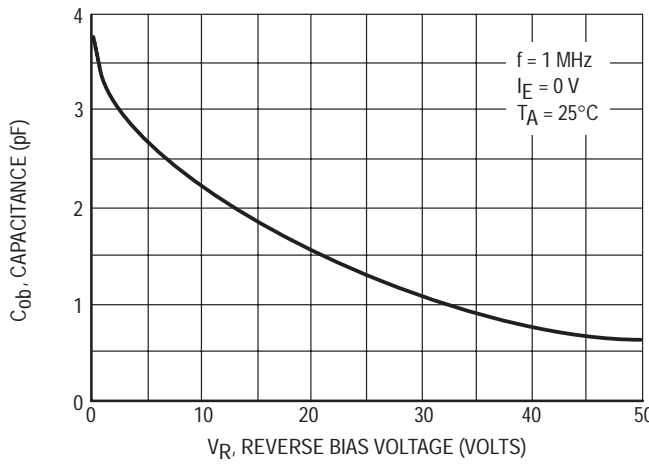


Figure 4. Output Capacitance

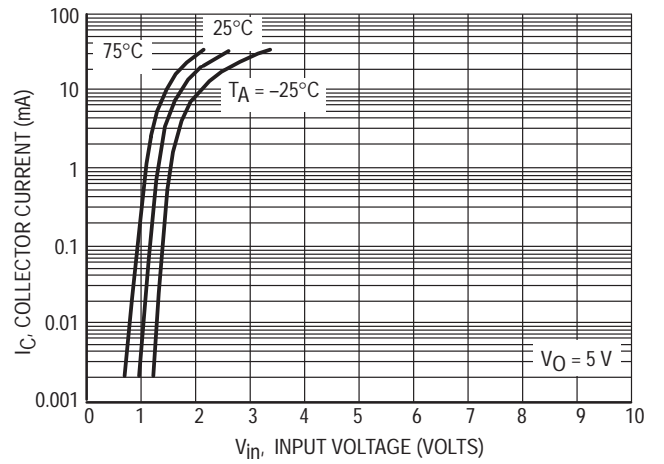


Figure 5. Output Current versus Input Voltage

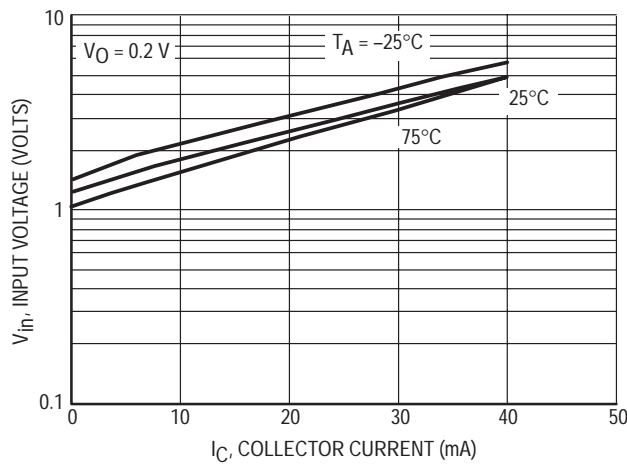


Figure 6. Input Voltage versus Output Current

TYPICAL ELECTRICAL CHARACTERISTICS — MUN2212T1

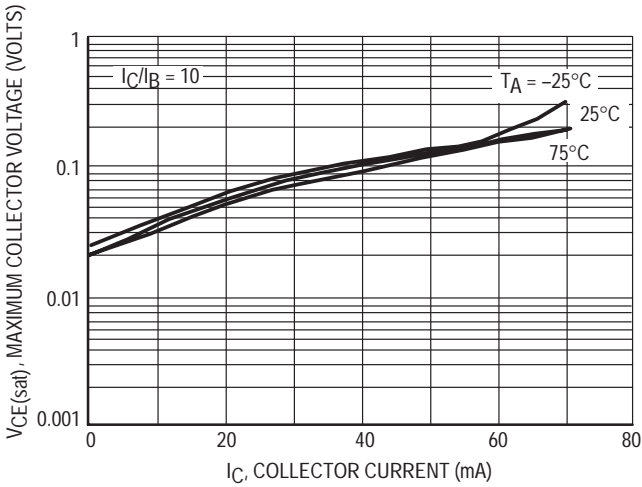


Figure 7. $V_{CE(sat)}$ versus I_C

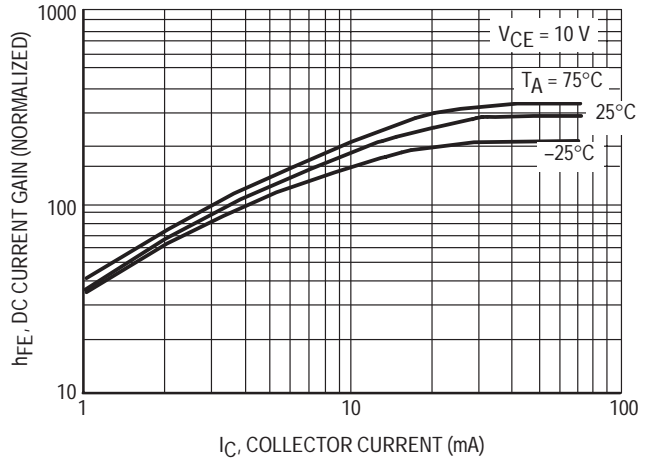


Figure 8. DC Current Gain

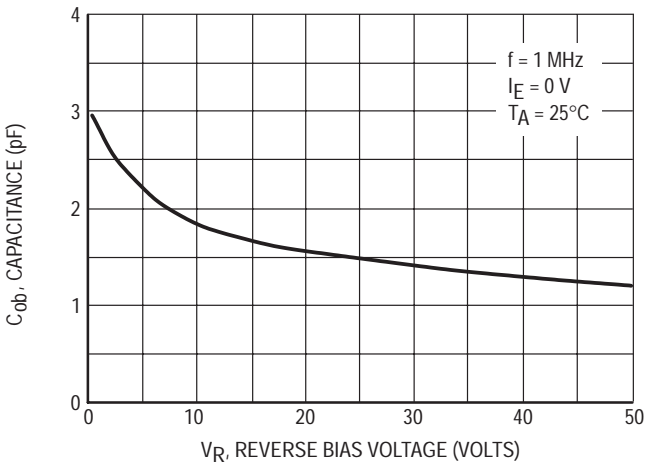


Figure 9. Output Capacitance

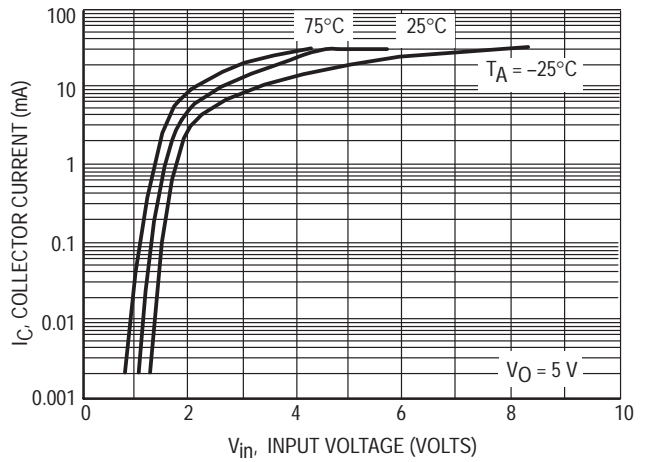


Figure 10. Output Current versus Input Voltage

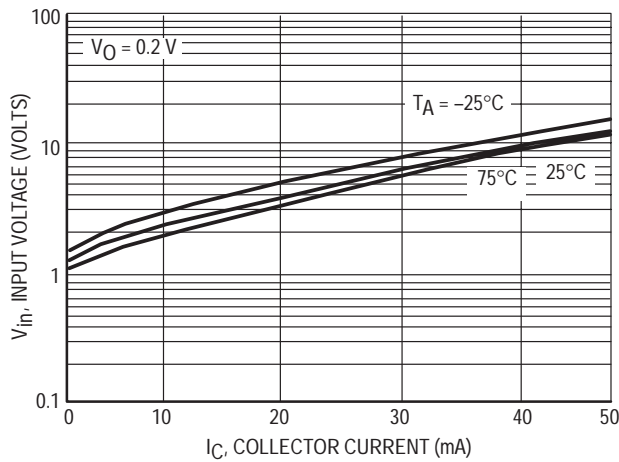


Figure 11. Input Voltage versus Output Current

TYPICAL ELECTRICAL CHARACTERISTICS — MUN2213T1

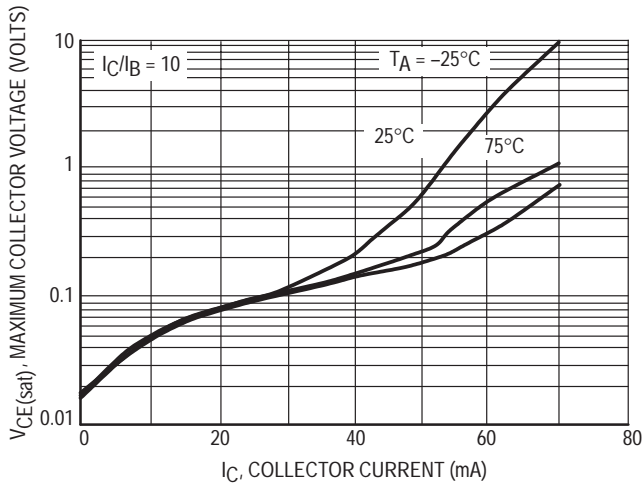


Figure 12. $V_{CE(sat)}$ versus I_C

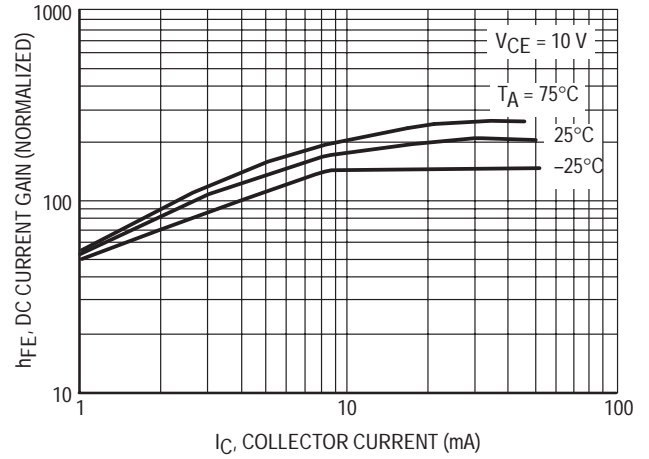


Figure 13. DC Current Gain

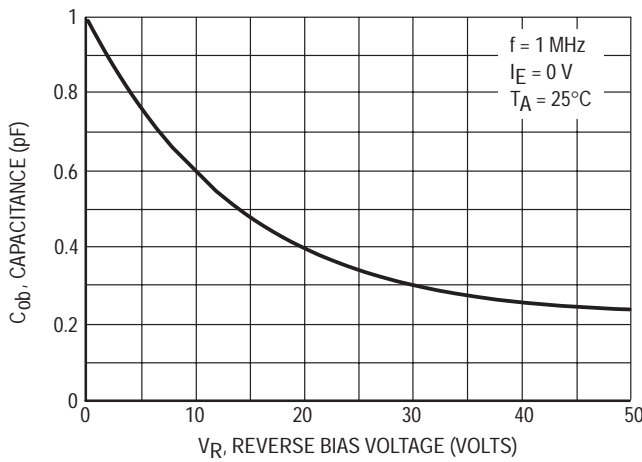


Figure 14. Output Capacitance

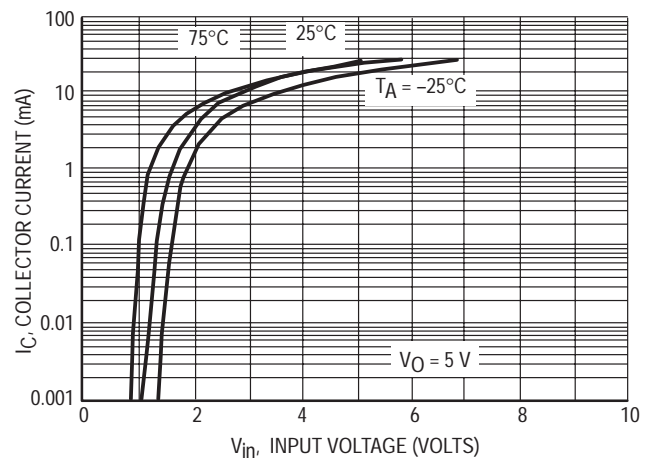


Figure 15. Output Current versus Input Voltage

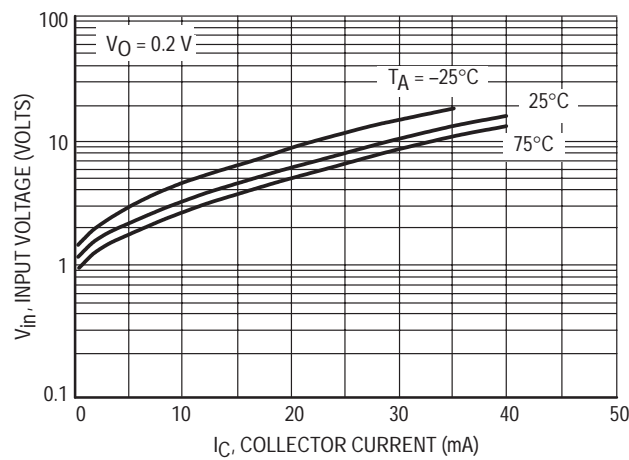


Figure 16. Input Voltage versus Output Current

TYPICAL ELECTRICAL CHARACTERISTICS — MUN2214T1

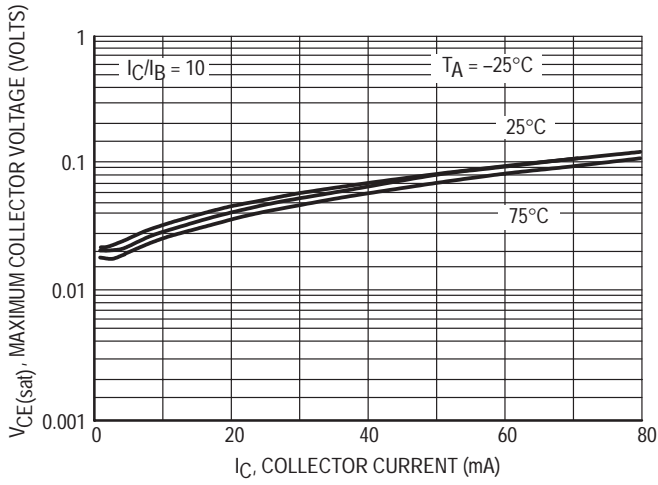


Figure 17. $V_{CE(sat)}$ versus I_C

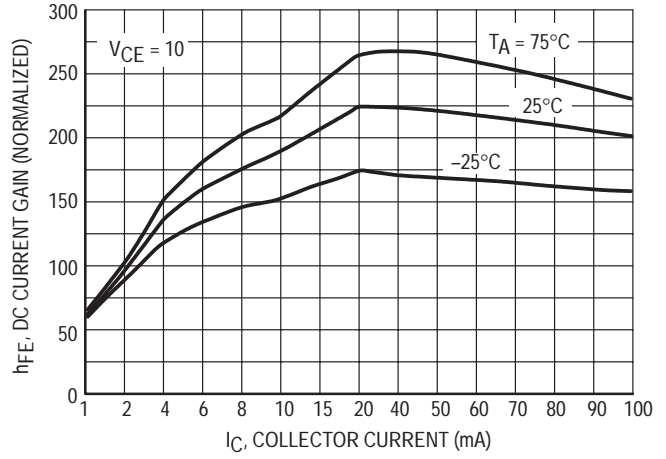


Figure 18. DC Current Gain

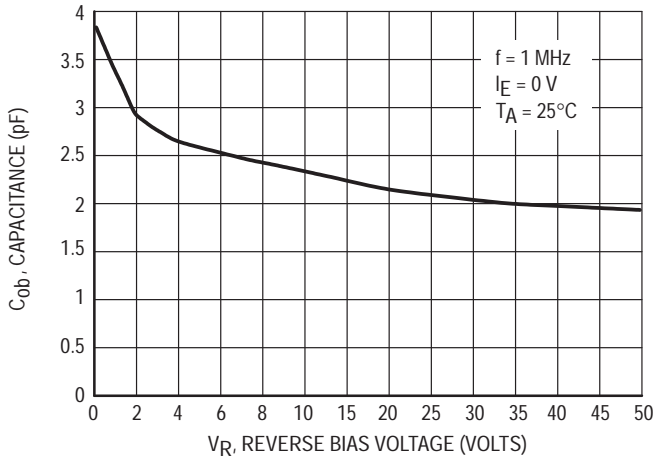


Figure 19. Output Capacitance

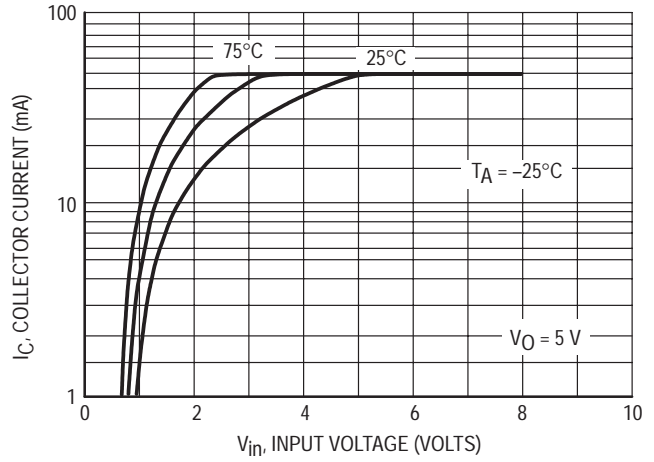


Figure 20. Output Current versus Input Voltage

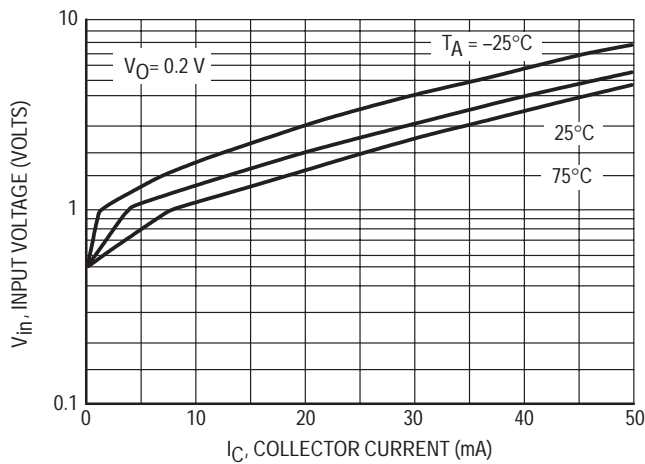


Figure 21. Input Voltage versus Output Current

TYPICAL APPLICATIONS FOR NPN BRTs

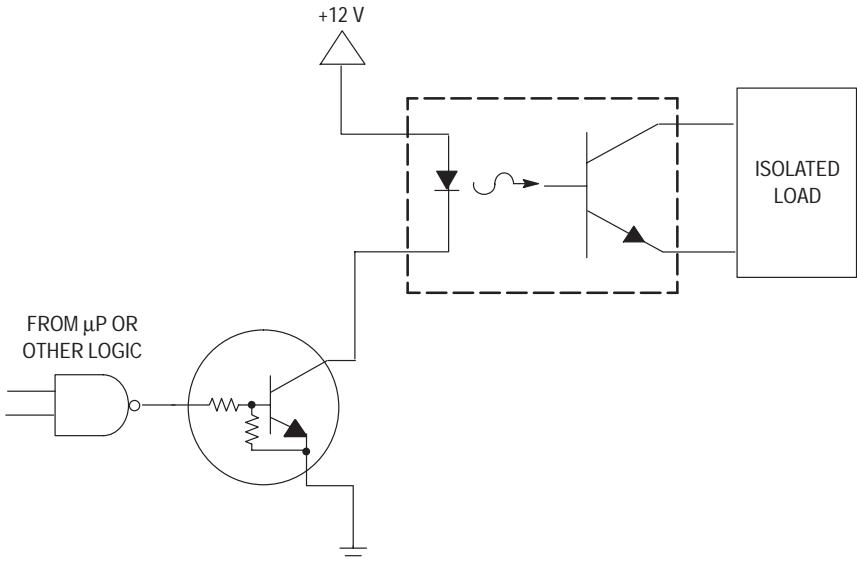


Figure 22. Level Shifter: Connects 12 or 24 Volt Circuits to Logic

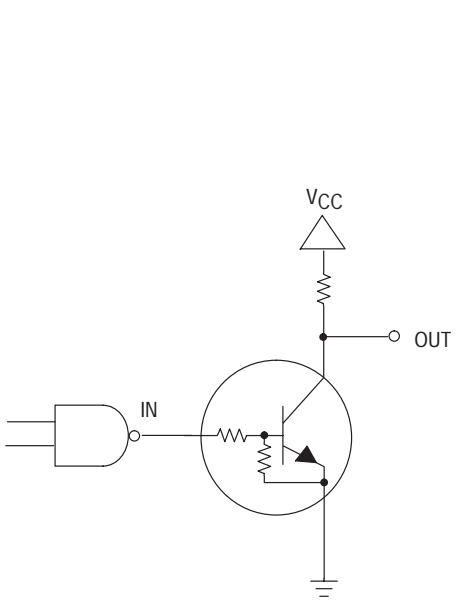


Figure 23. Open Collector Inverter: Inverts the Input Signal

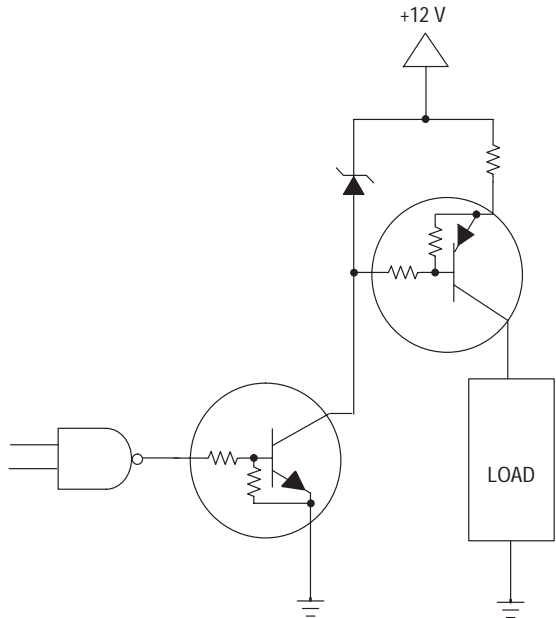


Figure 24. Inexpensive, Unregulated Current Source

Dual Bias Resistor Transistors

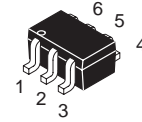
PNP Silicon Surface Mount Transistors with Monolithic Bias Resistor Network

The BRT (Bias Resistor Transistor) contains a single transistor with a monolithic bias network consisting of two resistors; a series base resistor and a base-emitter resistor. These digital transistors are designed to replace a single device and its external resistor bias network. The BRT eliminates these individual components by integrating them into a single device. In the MUN5111DW1T1 series, two BRT devices are housed in the SOT-363 package which is ideal for low-power surface mount applications where board space is at a premium.

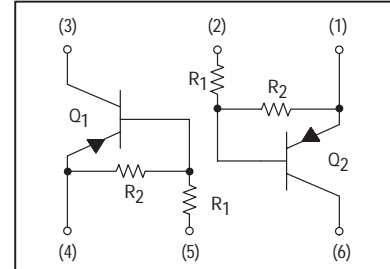
- Simplifies Circuit Design
- Reduces Board Space
- Reduces Component Count
- Available in 8 mm, 7 inch/3000 Unit Tape and Reel.

MUN5111DW1T1 SERIES

Motorola Preferred Devices



CASE 419B-01, STYLE 1
SOT-363



MAXIMUM RATINGS ($T_A = 25^\circ\text{C}$ unless otherwise noted, common for Q₁ and Q₂)

Rating	Symbol	Value	Unit
Collector-Base Voltage	V_{CBO}	-50	Vdc
Collector-Emitter Voltage	V_{CEO}	-50	Vdc
Collector Current	I_C	-100	mAdc

THERMAL CHARACTERISTICS

Thermal Resistance — Junction-to-Ambient (surface mounted)	$R_{\theta JA}$	833	$^\circ\text{C/W}$
Operating and Storage Temperature Range	T_J, T_{stg}	-65 to +150	$^\circ\text{C}$
Total Package Dissipation @ $T_A = 25^\circ\text{C}$ (1)	P_D	150	mW

DEVICE MARKING AND RESISTOR VALUES: MUN5111DW1T1 SERIES

Device	Marking	R1 (K)	R2 (K)
MUN5111DW1T1	0A	10	10
MUN5112DW1T1	0B	22	22
MUN5113DW1T1	0C	47	47
MUN5114DW1T1	0D	10	47
MUN5115DW1T1(2)	0E	10	∞
MUN5116DW1T1(2)	0F	4.7	∞
MUN5130DW1T1(2)	0G	1.0	1.0
MUN5131DW1T1(2)	0H	2.2	2.2
MUN5132DW1T1(2)	0J	4.7	4.7
MUN5133DW1T1(2)	0K	4.7	47
MUN5134DW1T1(2)	0L	22	47
MUN5135DW1T1(2)	0M	2.2	47

1. Device mounted on a FR-4 glass epoxy printed circuit board using the minimum recommended footprint.
2. New resistor combinations. Updated curves to follow in subsequent data sheets.

Preferred devices are Motorola recommended choices for future use and best overall value.

ELECTRICAL CHARACTERISTICS ($T_A = 25^\circ\text{C}$ unless otherwise noted, common for Q₁ and Q₂)

Characteristic	Symbol	Min	Typ	Max	Unit
OFF CHARACTERISTICS					
Collector–Base Cutoff Current ($V_{CB} = -50\text{ V}$, $I_E = 0$)	I_{CBO}	—	—	-100	nAdc
Collector–Emitter Cutoff Current ($V_{CE} = -50\text{ V}$, $I_B = 0$)	I_{CEO}	—	—	-500	nAdc
Emitter–Base Cutoff Current ($V_{EB} = -6.0\text{ V}$, $I_C = 0$)	I_{EBO}	—	—	-0.5	mAdc
MUN5111DW1T1		—	—	-0.2	
MUN5112DW1T1		—	—	-0.1	
MUN5113DW1T1		—	—	-0.2	
MUN5114DW1T1		—	—	-0.9	
MUN5115DW1T1		—	—	-1.9	
MUN5116DW1T1		—	—	-4.3	
MUN5130DW1T1		—	—	-2.3	
MUN5131DW1T1		—	—	-1.5	
MUN5132DW1T1		—	—	-0.18	
MUN5133DW1T1		—	—	-0.13	
MUN5134DW1T1		—	—	-0.2	
MUN5135DW1T1		—	—		
Collector–Base Breakdown Voltage ($I_C = -10\text{ }\mu\text{A}$, $I_E = 0$)	$V_{(BR)CBO}$	-50	—	—	Vdc
Collector–Emitter Breakdown Voltage ⁽³⁾ ($I_C = -2.0\text{ mA}$, $I_B = 0$)	$V_{(BR)CEO}$	-50	—	—	Vdc
ON CHARACTERISTICS⁽³⁾					
DC Current Gain ($V_{CE} = -10\text{ V}$, $I_C = -5.0\text{ mA}$)	h_{FE}	35	60	—	
MUN5111DW1T1		60	100	—	
MUN5112DW1T1		80	140	—	
MUN5113DW1T1		80	140	—	
MUN5114DW1T1		160	250	—	
MUN5115DW1T1		160	250	—	
MUN5116DW1T1		3.0	5.0	—	
MUN5130DW1T1		8.0	15	—	
MUN5131DW1T1		15	27	—	
MUN5132DW1T1		80	140	—	
MUN5133DW1T1		80	130	—	
MUN5134DW1T1		80	140	—	
MUN5135DW1T1					
Collector–Emitter Saturation Voltage ($I_C = -10\text{ mA}$, $I_E = -0.3\text{ mA}$) ($I_C = -10\text{ mA}$, $I_B = -5\text{ mA}$) MUN5130DW1T1/MUN5131DW1T1 ($I_C = -10\text{ mA}$, $I_B = -1\text{ mA}$) MUN5115DW1T1/MUN5116DW1T1/ MUN5132DW1T1/MUN5133DW1T1/MUN5134DW1T1	$V_{CE(sat)}$	—	—	-0.25	Vdc
Output Voltage (on) ($V_{CC} = -5.0\text{ V}$, $V_B = -2.5\text{ V}$, $R_L = 1.0\text{ k}\Omega$)	V_{OL}	—	—	-0.2	Vdc
MUN5111DW1T1		—	—	-0.2	
MUN5112DW1T1		—	—	-0.2	
MUN5114DW1T1		—	—	-0.2	
MUN5115DW1T1		—	—	-0.2	
MUN5116DW1T1		—	—	-0.2	
MUN5130DW1T1		—	—	-0.2	
MUN5131DW1T1		—	—	-0.2	
MUN5132DW1T1		—	—	-0.2	
MUN5133DW1T1		—	—	-0.2	
MUN5134DW1T1		—	—	-0.2	
MUN5135DW1T1		—	—	-0.2	
($V_{CC} = -5.0\text{ V}$, $V_B = -3.5\text{ V}$, $R_L = 1.0\text{ k}\Omega$) MUN5113DW1T1		—	—	-0.2	

3. Pulse Test: Pulse Width < 300 μs , Duty Cycle < 2.0%

MUN5111DW1T1 SERIES

ELECTRICAL CHARACTERISTICS ($T_A = 25^\circ\text{C}$ unless otherwise noted, common for Q₁ and Q₂) (Continued)

Characteristic	Symbol	Min	Typ	Max	Unit
Output Voltage (off) ($V_{CC} = -5.0\text{ V}$, $V_B = -0.5\text{ V}$, $R_L = 1.0\text{ k}\Omega$) ($V_{CC} = -5.0\text{ V}$, $V_B = -0.050\text{ V}$, $R_L = 1.0\text{ k}\Omega$) MUN5130DW1T1 ($V_{CC} = -5.0\text{ V}$, $V_B = -0.25\text{ V}$, $R_L = 1.0\text{ k}\Omega$) MUN5115DW1T1 MUN5116DW1T1 MUN5131DW1T1 MUN5132DW1T1	V_{OH}	-4.9	—	—	Vdc
Input Resistor MUN5111DW1T1 MUN5112DW1T1 MUN5113DW1T1 MUN5114DW1T1 MUN5115DW1T1 MUN5116DW1T1 MUN5130DW1T1 MUN5131DW1T1 MUN5132DW1T1 MUN5133DW1T1 MUN5134DW1T1 MUN5135DW1T1	R1	7.0 15.4 32.9 7.0 7.0 3.3 0.7 1.5 3.3 3.3 15.4 1.54	10 22 47 10 10 4.7 1.0 2.2 4.7 4.7 22 2.2	13 28.6 61.1 13 13 6.1 1.3 2.9 6.1 6.1 28.6 2.86	k Ω
Resistor Ratio MUN5111DW1T1/MUN5112DW1T1/MUN5113DW1T1 MUN5114DW1T1 MUN5115DW1T1/MUN5116DW1T1 MUN5130DW1T1/MUN5131DW1T1/MUN5132DW1T1 MUN5133DW1T1 MUN5134DW1T1 MUN5135DW1T1	R_1/R_2	0.8 0.17 — 0.8 0.055 0.38 0.038	1.0 0.21 — 1.0 0.1 0.47 0.047	1.2 0.25 — 1.2 0.185 0.56 0.056	

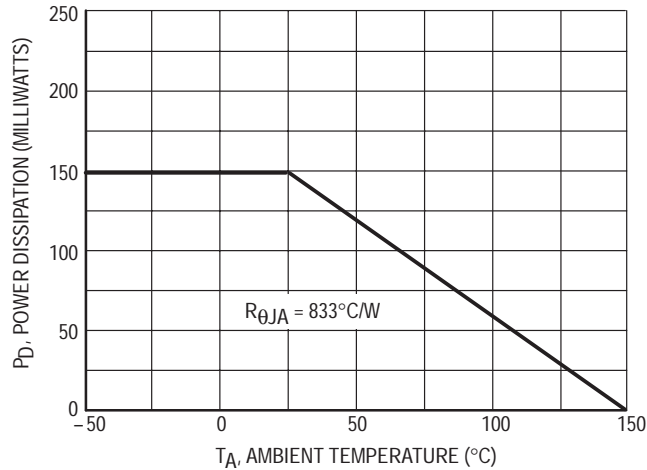


Figure 1. Derating Curve

TYPICAL ELECTRICAL CHARACTERISTICS — MUN5111DW1T1

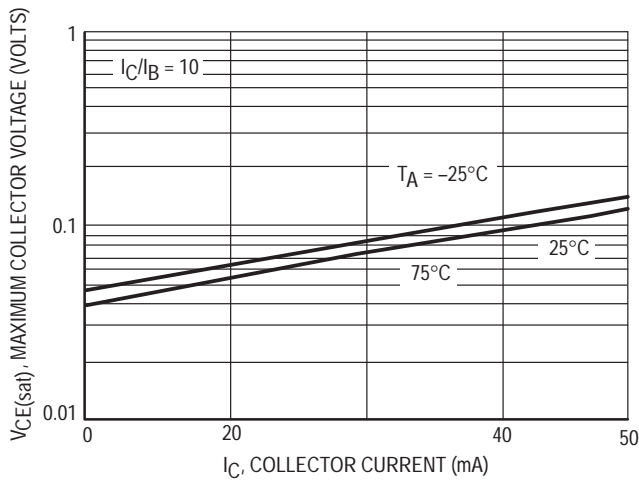


Figure 2. $V_{CE(sat)}$ versus I_C

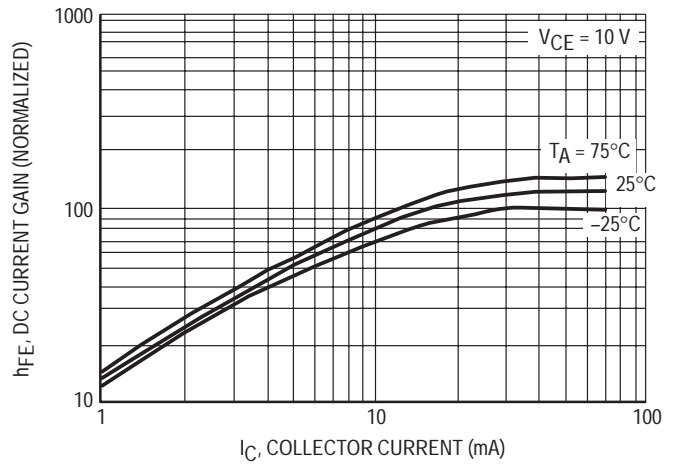


Figure 3. DC Current Gain

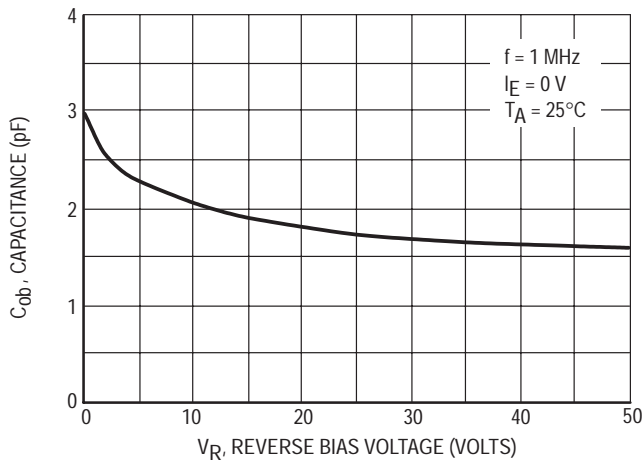


Figure 4. Output Capacitance

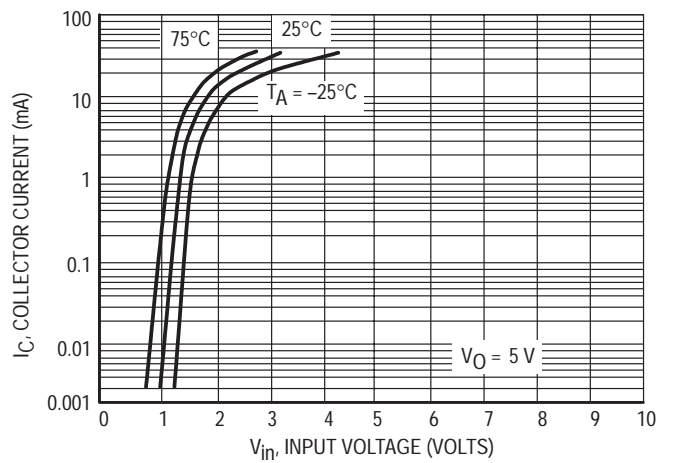


Figure 5. Output Current versus Input Voltage

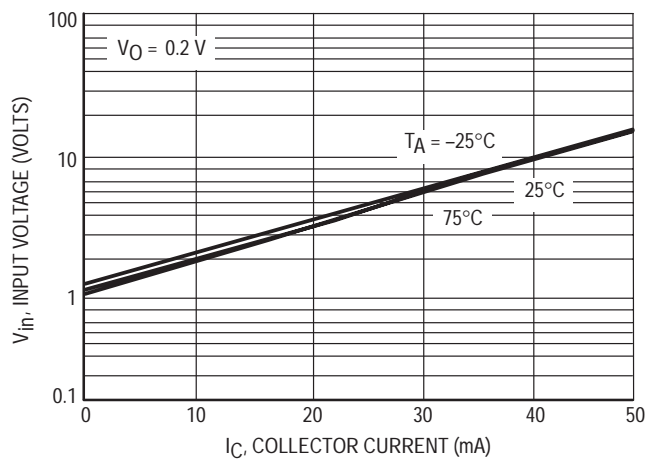


Figure 6. Input Voltage versus Output Current

TYPICAL ELECTRICAL CHARACTERISTICS — MUN5112DW1T1

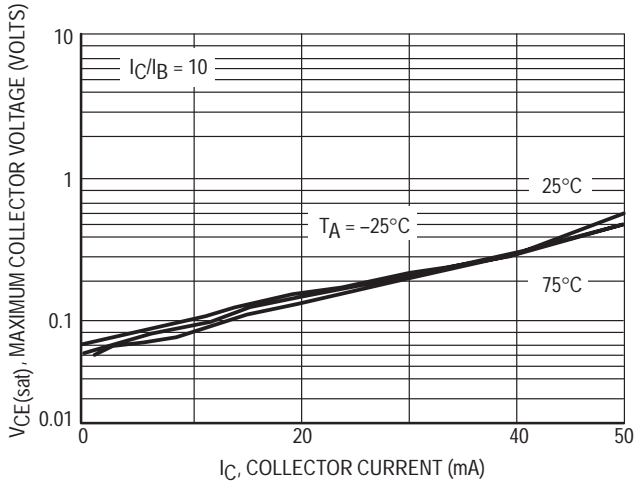


Figure 7. $V_{CE(sat)}$ versus I_C

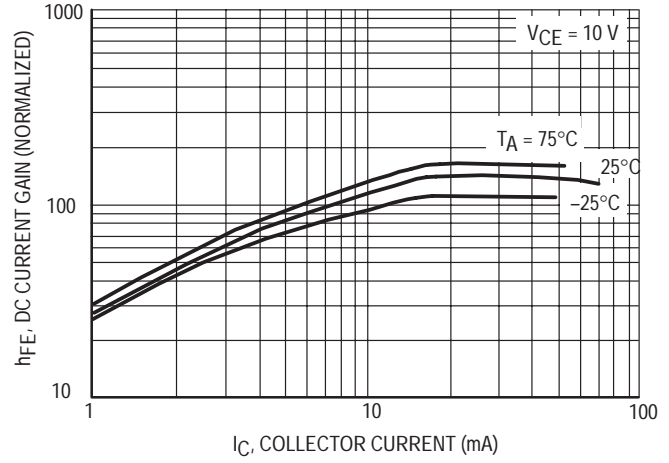


Figure 8. DC Current Gain

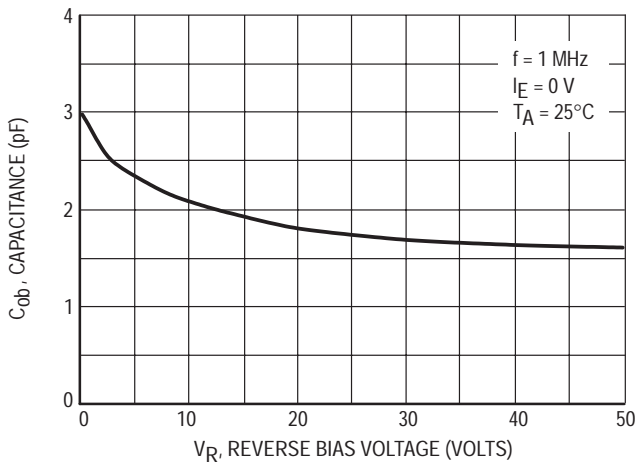


Figure 9. Output Capacitance

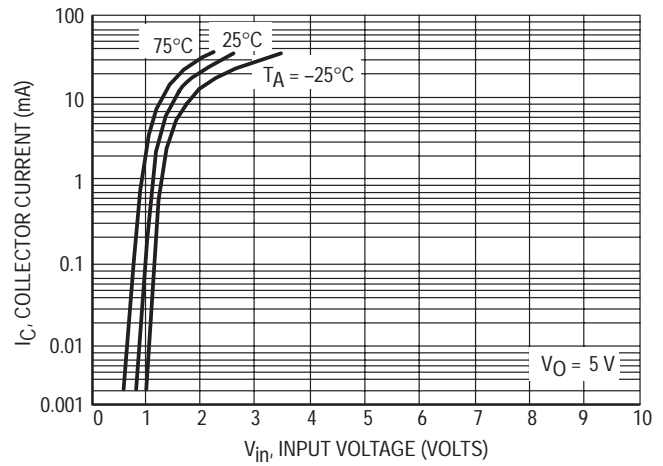


Figure 10. Output Current versus Input Voltage

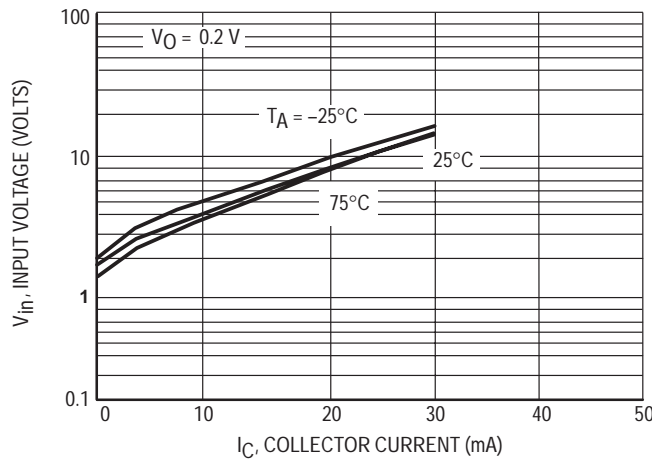


Figure 11. Input Voltage versus Output Current

TYPICAL ELECTRICAL CHARACTERISTICS — MUN5113DW1T1

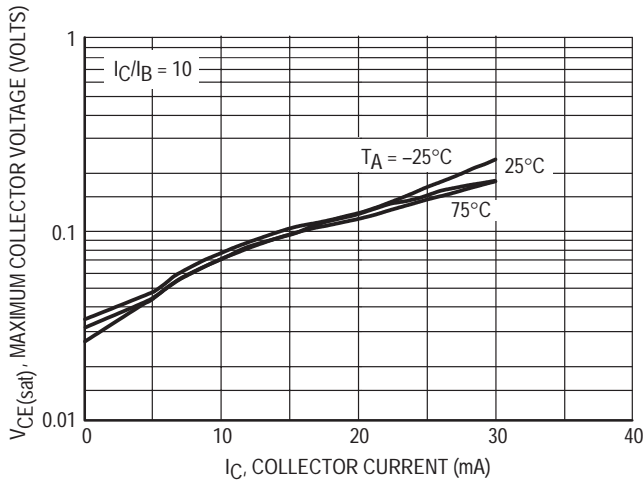


Figure 12. $V_{CE(sat)}$ versus I_C

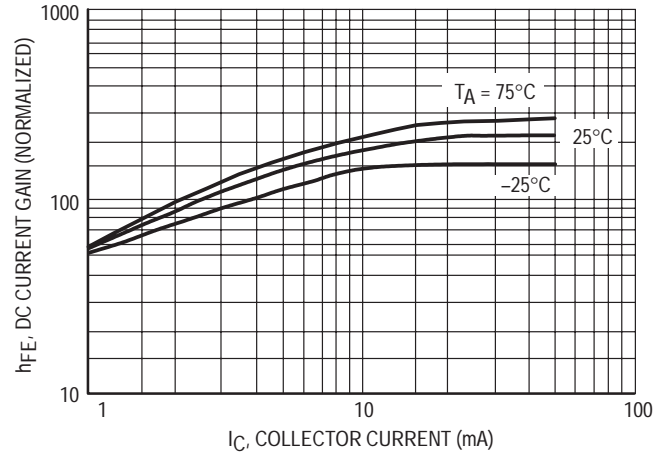


Figure 13. DC Current Gain

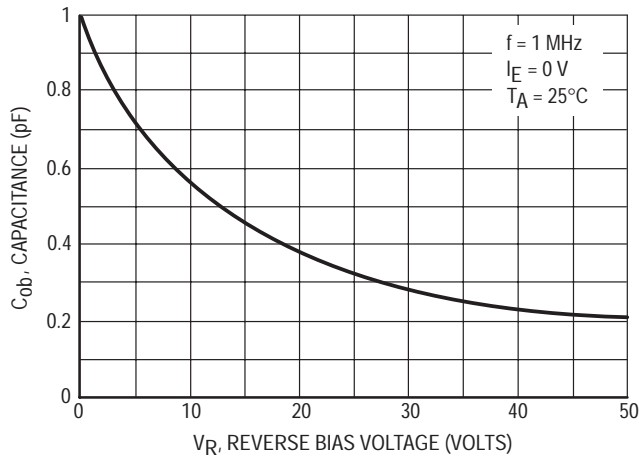


Figure 14. Output Capacitance

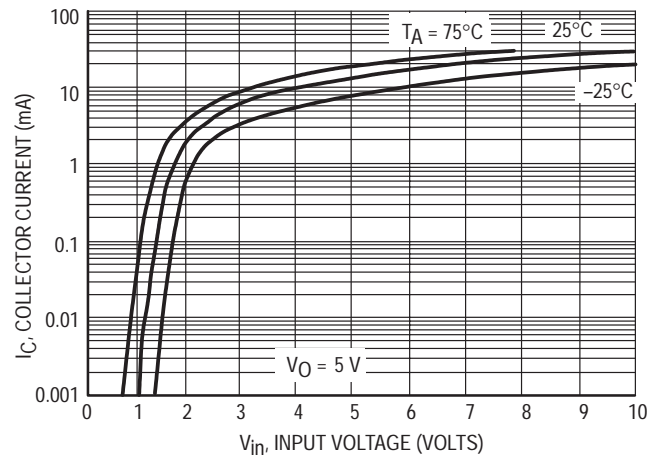


Figure 15. Output Current versus Input Voltage

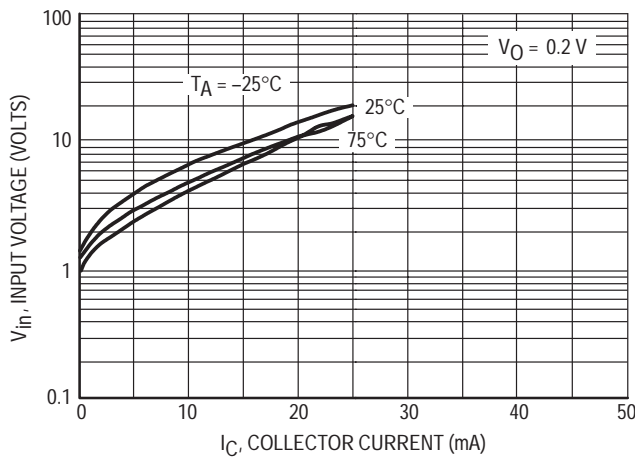


Figure 16. Input Voltage versus Output Current

TYPICAL ELECTRICAL CHARACTERISTICS — MUN5114DW1T1

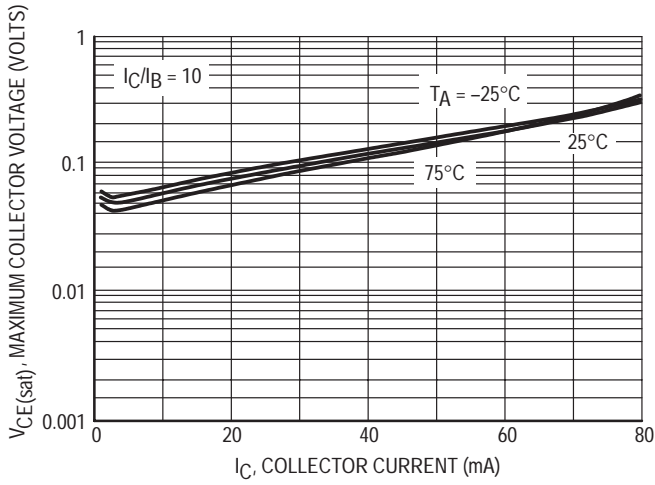


Figure 17. $V_{CE(sat)}$ versus I_C

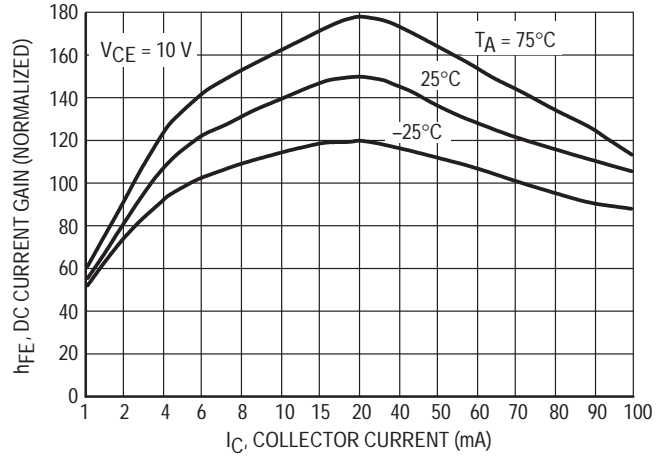


Figure 18. DC Current Gain

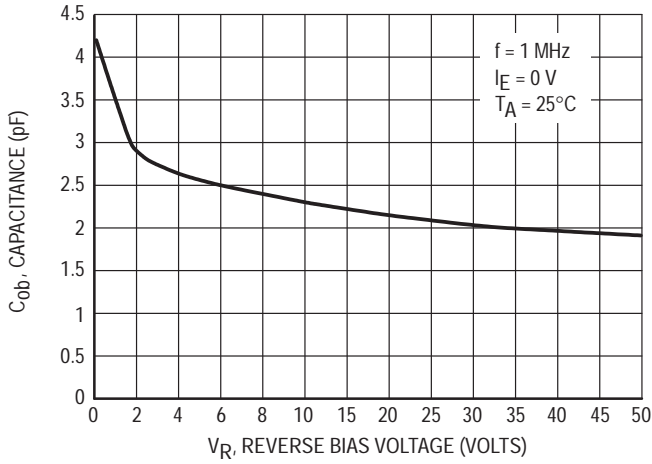


Figure 19. Output Capacitance

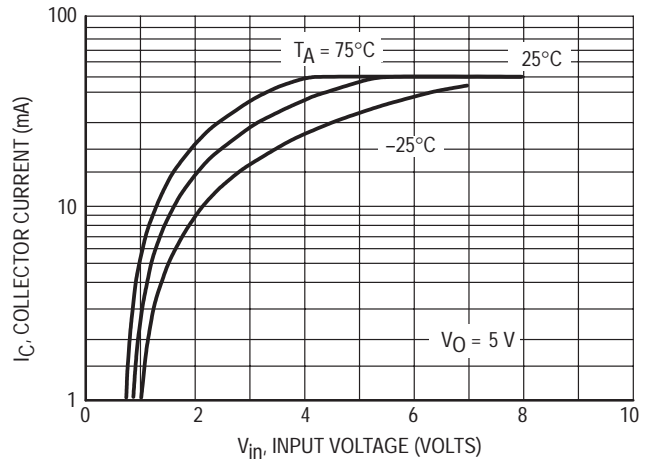


Figure 20. Output Current versus Input Voltage

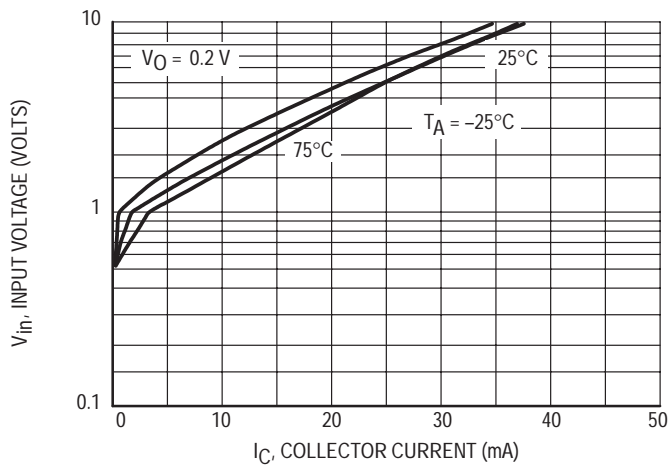


Figure 21. Input Voltage versus Output Current

TYPICAL ELECTRICAL CHARACTERISTICS — MUN5115DW1T1

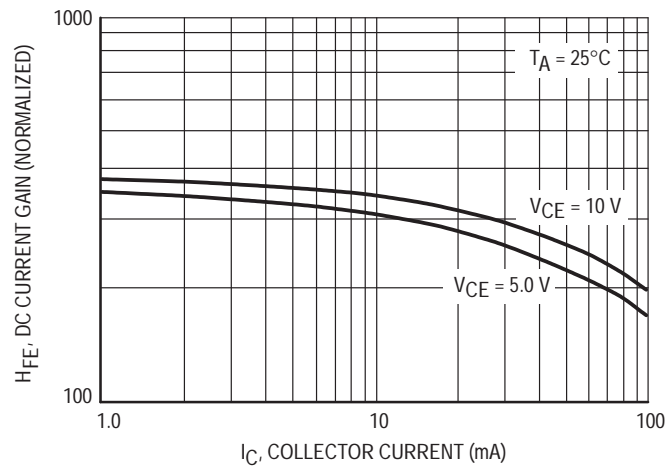


Figure 22. DC Current Gain

TYPICAL ELECTRICAL CHARACTERISTICS — MUN5116DW1T1

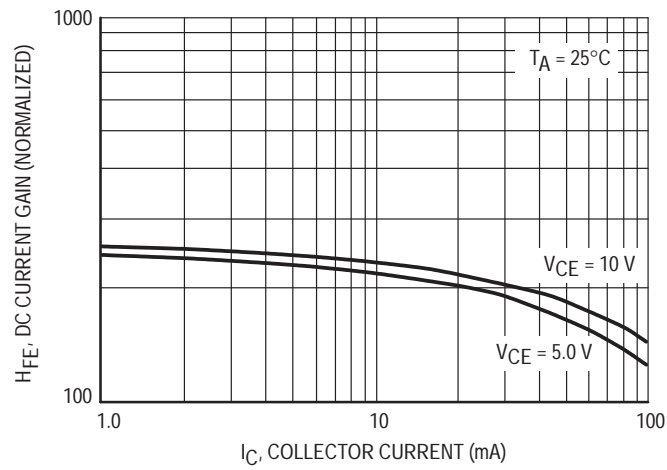


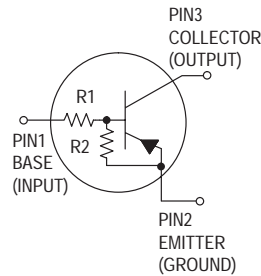
Figure 23. DC Current Gain

Bias Resistor Transistor

PNP Silicon Surface Mount Transistor with Monolithic Bias Resistor Network

This new series of digital transistors is designed to replace a single device and its external resistor bias network. The BRT (Bias Resistor Transistor) contains a single transistor with a monolithic bias network consisting of two resistors; a series base resistor and a base-emitter resistor. The BRT eliminates these individual components by integrating them into a single device. The use of a BRT can reduce both system cost and board space. The device is housed in the SC-70/SOT-323 package which is designed for low power surface mount applications.

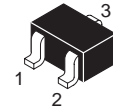
- Simplifies Circuit Design
- Reduces Board Space
- Reduces Component Count
- The SC-70/SOT-323 package can be soldered using wave or reflow. The modified gull-winged leads absorb thermal stress during soldering eliminating the possibility of damage to the die.
- Available in 8 mm embossed tape and reel
Use the Device Number to order the 7 inch/3000 unit reel.
Replace "T1" with "T3" in the Device Number to order the 13 inch/10,000 unit reel.



MUN5111T1 SERIES

Motorola Preferred Devices

PNP SILICON BIAS RESISTOR TRANSISTOR



CASE 419-02, STYLE 3
SC-70/SOT-323

MAXIMUM RATINGS ($T_A = 25^\circ\text{C}$ unless otherwise noted)

Rating	Symbol	Value	Unit
Collector-Base Voltage	V_{CBO}	50	Vdc
Collector-Emitter Voltage	V_{CEO}	50	Vdc
Collector Current	I_C	100	mAdc
Total Power Dissipation @ $T_A = 25^\circ\text{C}$ (1) Derate above 25°C	P_D	150 1.2	mW mW/°C

THERMAL CHARACTERISTICS

Thermal Resistance — Junction-to-Ambient (surface mounted)	$R_{\theta JA}$	833	°C/W
Operating and Storage Temperature Range	T_J, T_{stg}	-65 to +150	°C
Maximum Temperature for Soldering Purposes, Time in Solder Bath	T_L	260 10	°C Sec

DEVICE MARKING AND RESISTOR VALUES

Device	Marking	R1 (K)	R2 (K)
MUN5111T1	6A	10	10
MUN5112T1	6B	22	22
MUN5113T1	6C	47	47
MUN5114T1	6D	10	47
MUN5115T1(2)	6E	10	∞
MUN5116T1(2)	6F	4.7	∞
MUN5130T1(2)	6G	1.0	1.0
MUN5131T1(2)	6H	2.2	2.2
MUN5132T1(2)	6J	4.7	4.7
MUN5133T1(2)	6K	4.7	47
MUN5134T1(2)	6L	22	47

1. Device mounted on a FR-4 glass epoxy printed circuit board using the minimum recommended footprint.
2. New devices. Updated curves to follow in subsequent data sheets.

Preferred devices are Motorola recommended choices for future use and best overall value.

ELECTRICAL CHARACTERISTICS ($T_A = 25^\circ\text{C}$ unless otherwise noted)

Characteristic	Symbol	Min	Typ	Max	Unit
OFF CHARACTERISTICS					
Collector–Base Cutoff Current ($V_{CB} = 50\text{ V}$, $I_E = 0$)	I_{CBO}	—	—	100	nAdc
Collector–Emitter Cutoff Current ($V_{CE} = 50\text{ V}$, $I_B = 0$)	I_{CEO}	—	—	500	nAdc
Emitter–Base Cutoff Current ($V_{EB} = 6.0\text{ V}$, $I_C = 0$)	I_{EBO}	—	—	0.5	mAdc
MUN5111T1		—	—	0.2	
MUN5112T1		—	—	0.1	
MUN5113T1		—	—	0.2	
MUN5114T1		—	—	0.9	
MUN5115T1		—	—	1.9	
MUN5116T1		—	—	4.3	
MUN5130T1		—	—	2.3	
MUN5131T1		—	—	1.5	
MUN5132T1		—	—	0.18	
MUN5133T1		—	—	0.13	
MUN5134T1		—	—		
Collector–Base Breakdown Voltage ($I_C = 10\text{ }\mu\text{A}$, $I_E = 0$)	$V_{(BR)CBO}$	50	—	—	Vdc
Collector–Emitter Breakdown Voltage ⁽³⁾ ($I_C = 2.0\text{ mA}$, $I_B = 0$)	$V_{(BR)CEO}$	50	—	—	Vdc

ON CHARACTERISTICS⁽³⁾

DC Current Gain ($V_{CE} = 10\text{ V}$, $I_C = 5.0\text{ mA}$)	h_{FE}	35	60	—	
MUN5111T1		60	100	—	
MUN5112T1		80	140	—	
MUN5113T1		80	140	—	
MUN5114T1		160	250	—	
MUN5115T1		160	250	—	
MUN5116T1		3.0	5.0	—	
MUN5130T1		8.0	15	—	
MUN5131T1		15	27	—	
MUN5132T1		80	140	—	
MUN5133T1		80	130	—	
MUN5134T1					
Collector–Emitter Saturation Voltage ($I_C = 10\text{ mA}$, $I_E = 0.3\text{ mA}$) ($I_C = 10\text{ mA}$, $I_B = 5\text{ mA}$) MUN5130T1/MUN5131T1 ($I_C = 10\text{ mA}$, $I_B = 1\text{ mA}$) MUN5115T1/MUN5116T1/ MUN5132T1/MUN5133T1/MUN5134T1	$V_{CE(sat)}$	—	—	0.25	Vdc
Output Voltage (on) ($V_{CC} = 5.0\text{ V}$, $V_B = 2.5\text{ V}$, $R_L = 1.0\text{ k}\Omega$)	V_{OL}	—	—	0.2	Vdc
MUN5111T1		—	—	0.2	
MUN5112T1		—	—	0.2	
MUN5114T1		—	—	0.2	
MUN5115T1		—	—	0.2	
MUN5116T1		—	—	0.2	
MUN5130T1		—	—	0.2	
MUN5131T1		—	—	0.2	
MUN5132T1		—	—	0.2	
MUN5133T1		—	—	0.2	
MUN5134T1		—	—	0.2	
($V_{CC} = 5.0\text{ V}$, $V_B = 3.5\text{ V}$, $R_L = 1.0\text{ k}\Omega$)		—	—	0.2	
MUN5113T1		—	—	0.2	

3. Pulse Test: Pulse Width < 300 μs , Duty Cycle < 2.0%

MUN5111T1 SERIES

ELECTRICAL CHARACTERISTICS ($T_A = 25^\circ\text{C}$ unless otherwise noted) (Continued)

Characteristic	Symbol	Min	Typ	Max	Unit
Output Voltage (off) ($V_{CC} = 5.0\text{ V}$, $V_B = 0.5\text{ V}$, $R_L = 1.0\text{ k}\Omega$) ($V_{CC} = 5.0\text{ V}$, $V_B = 0.050\text{ V}$, $R_L = 1.0\text{ k}\Omega$) ($V_{CC} = 5.0\text{ V}$, $V_B = 0.25\text{ V}$, $R_L = 1.0\text{ k}\Omega$)	V_{OH}	4.9	—	—	Vdc
Input Resistor	R1	7.0	10	13	k Ω
MUN5111T1		15.4	22	28.6	
MUN5112T1		32.9	47	61.1	
MUN5113T1		7.0	10	13	
MUN5114T1		7.0	10	13	
MUN5115T1		3.3	4.7	6.1	
MUN5116T1		0.7	1.0	1.3	
MUN5130T1		1.5	2.2	2.9	
MUN5131T1		3.3	4.7	6.1	
MUN5132T1		3.3	4.7	6.1	
MUN5133T1		15.4	22	28.6	
MUN5134T1					
Resistor Ratio	R_1/R_2	0.8	1.0	1.2	
MUN5111T1/MUN5112T1/MUN5113T1		0.17	0.21	0.25	
MUN5114T1		—	—	—	
MUN5115T1/MUN5116T1		0.8	1.0	1.2	
MUN5130T1/MUN5131T1/MUN5132T1		0.055	0.1	0.185	
MUN5133T1		0.38	0.47	0.56	
MUN5134T1					

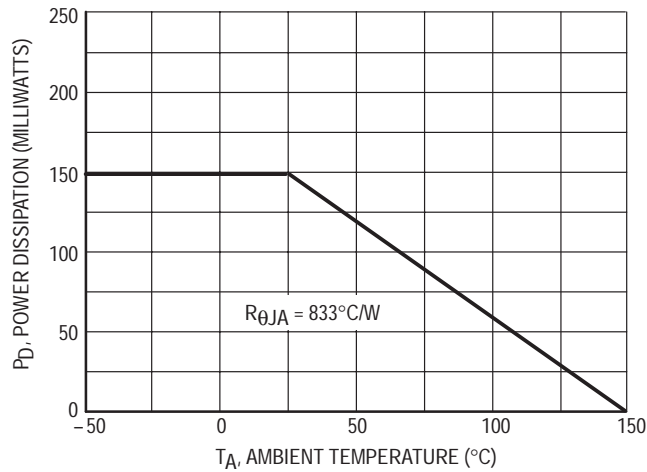


Figure 1. Derating Curve

TYPICAL ELECTRICAL CHARACTERISTICS — MUN5111T1

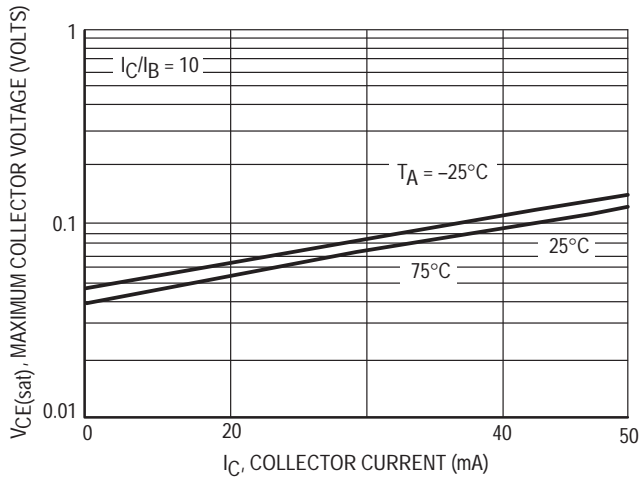


Figure 2. $V_{CE(sat)}$ versus I_C

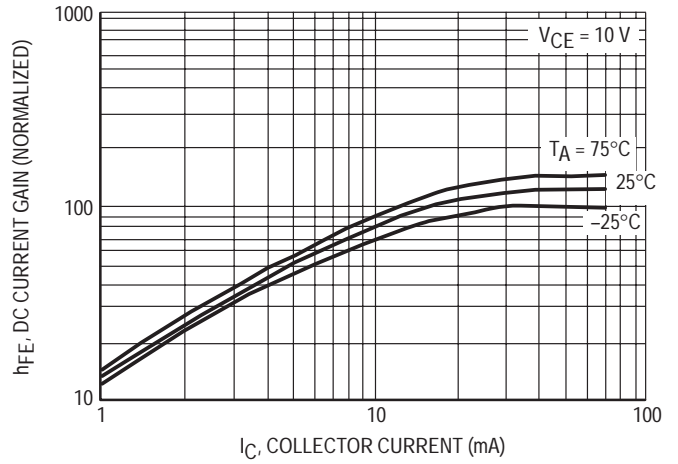


Figure 3. DC Current Gain

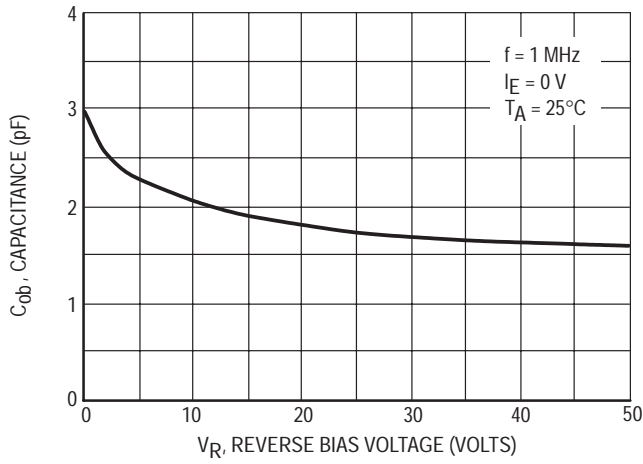


Figure 4. Output Capacitance

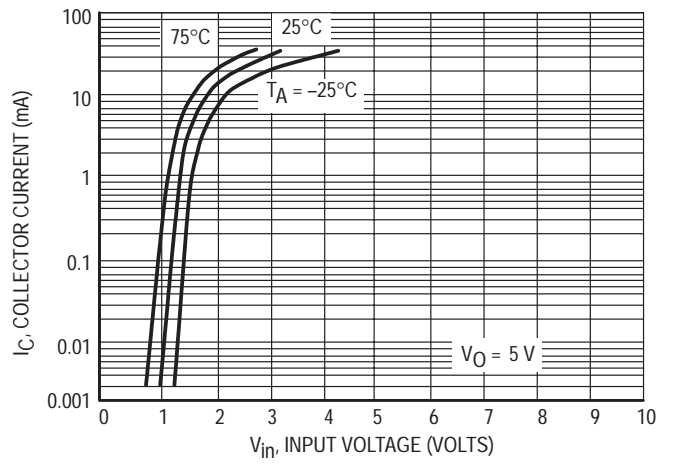


Figure 5. Output Current versus Input Voltage

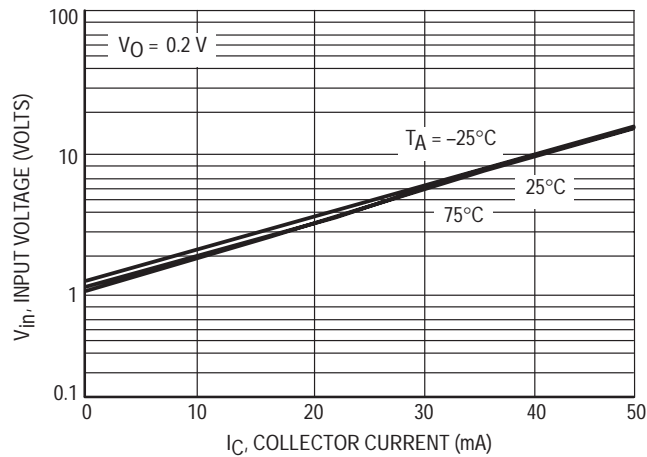


Figure 6. Input Voltage versus Output Current

TYPICAL ELECTRICAL CHARACTERISTICS — MUN511T1

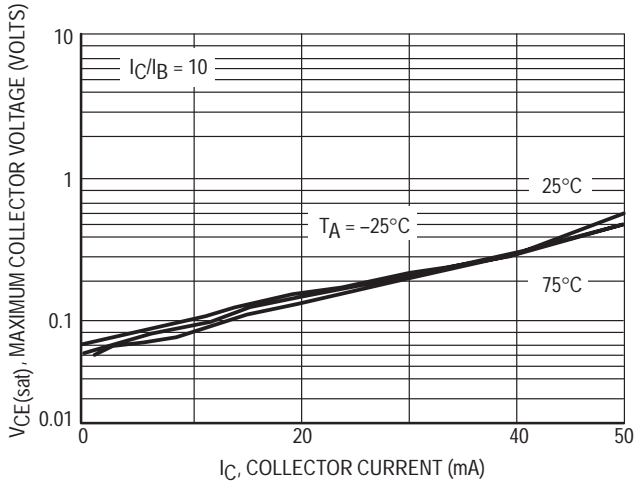


Figure 7. $V_{CE(sat)}$ versus I_C

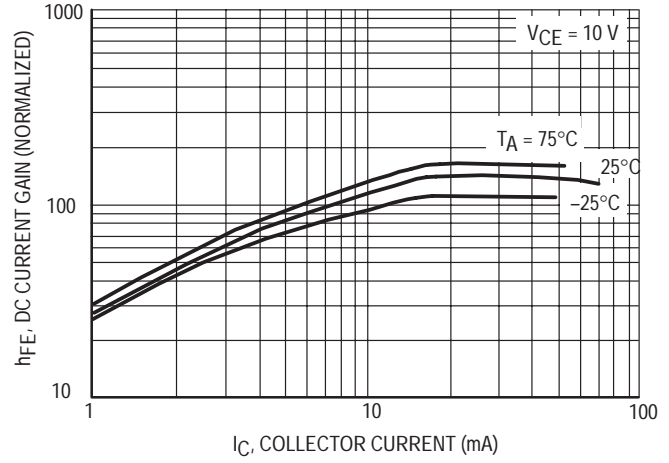


Figure 8. DC Current Gain

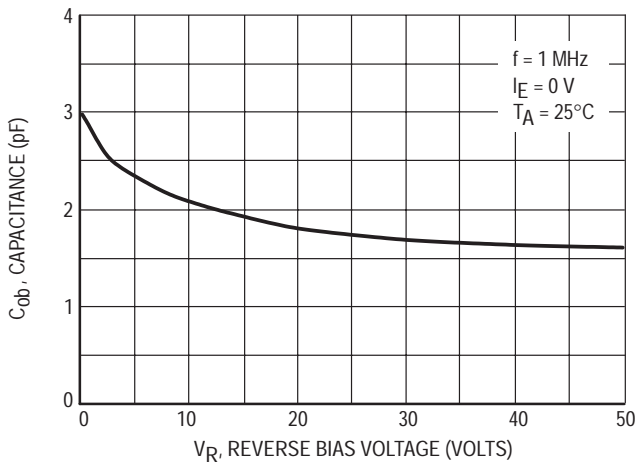


Figure 9. Output Capacitance

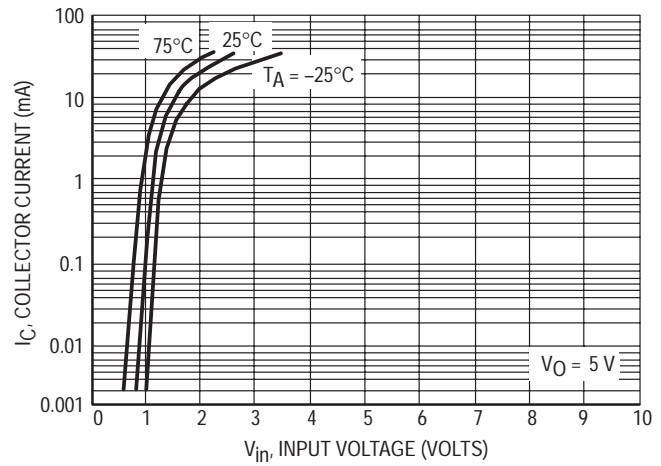


Figure 10. Output Current versus Input Voltage

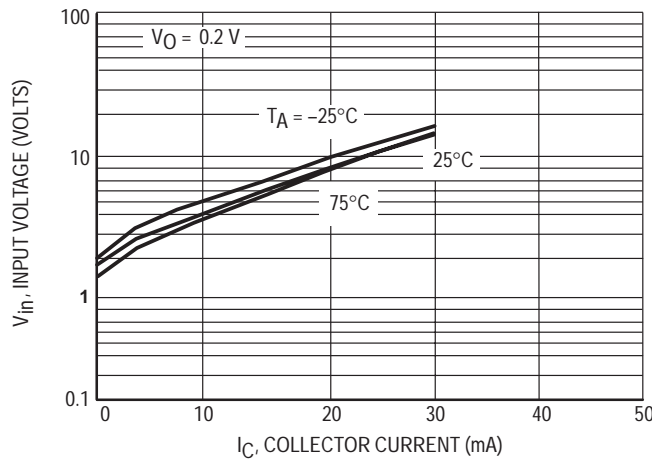


Figure 11. Input Voltage versus Output Current

TYPICAL ELECTRICAL CHARACTERISTICS — MUN5113T1

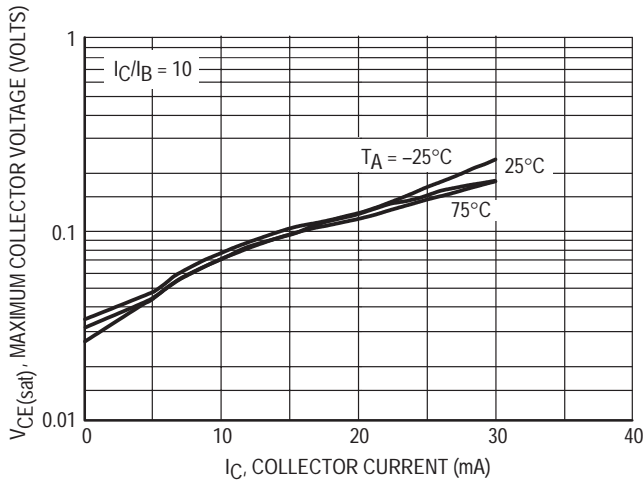


Figure 12. $V_{CE(sat)}$ versus I_C

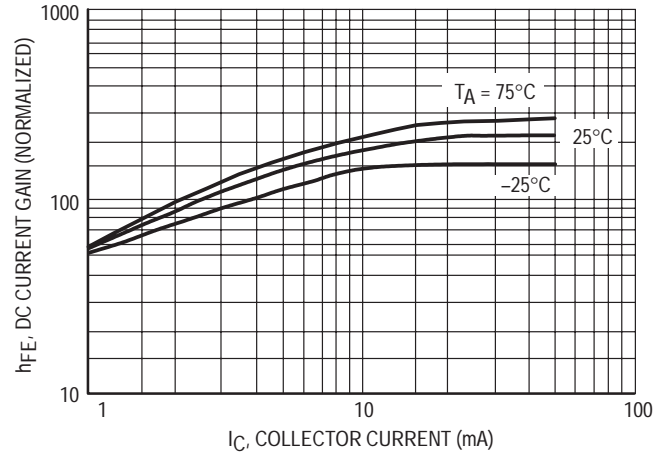


Figure 13. DC Current Gain

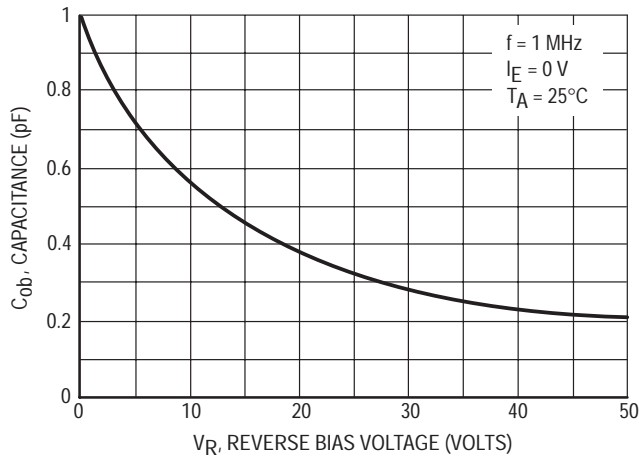


Figure 14. Output Capacitance

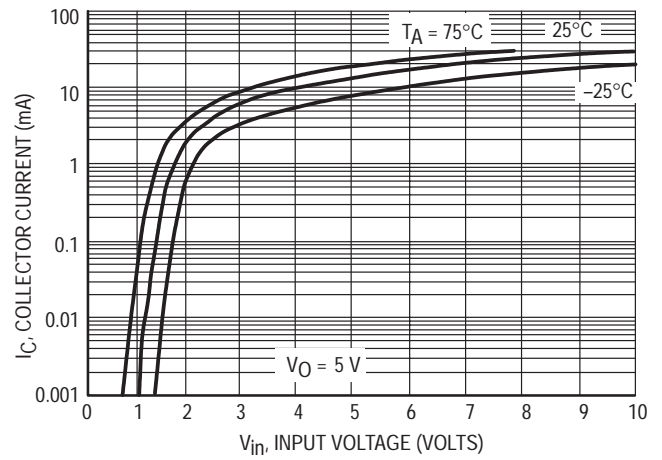


Figure 15. Output Current versus Input Voltage

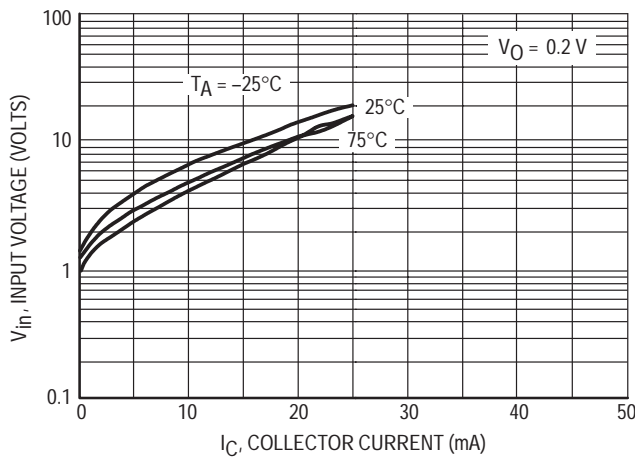


Figure 16. Input Voltage versus Output Current

TYPICAL ELECTRICAL CHARACTERISTICS — MUN5114T1

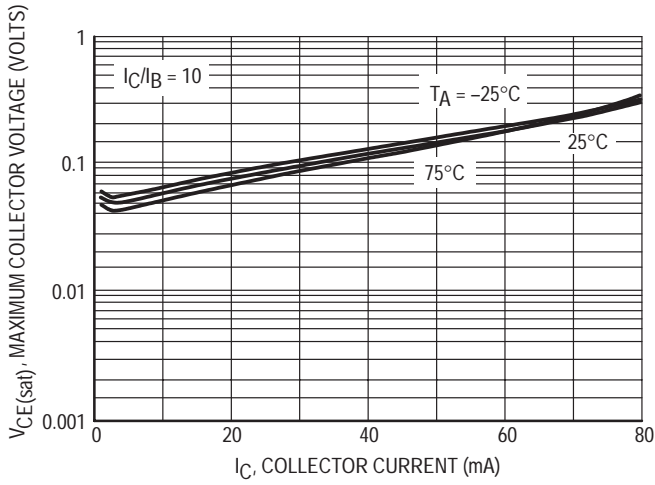


Figure 17. $V_{CE(sat)}$ versus I_C

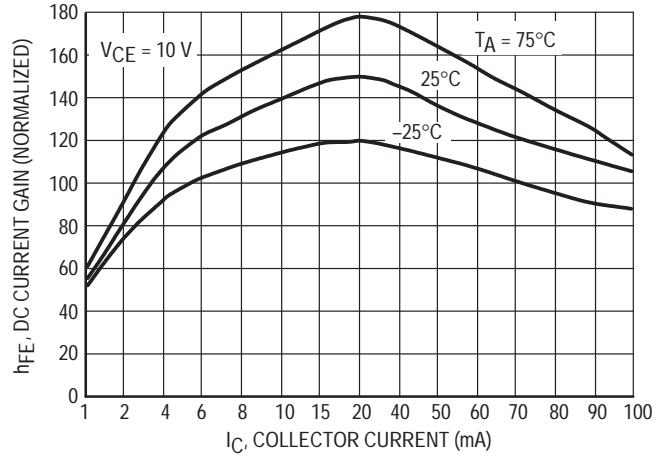


Figure 18. DC Current Gain

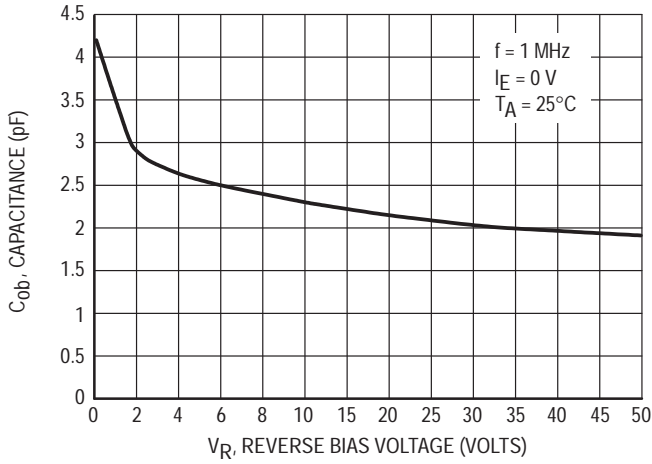


Figure 19. Output Capacitance

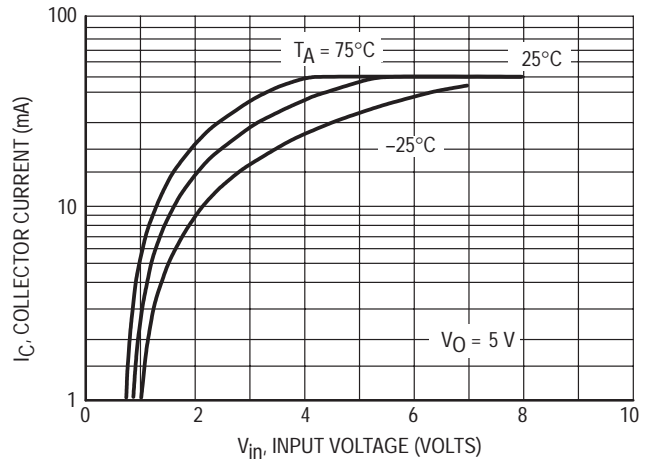


Figure 20. Output Current versus Input Voltage

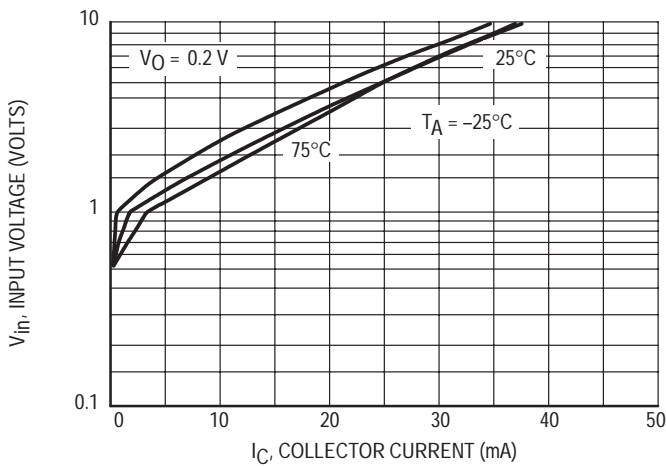


Figure 21. Input Voltage versus Output Current

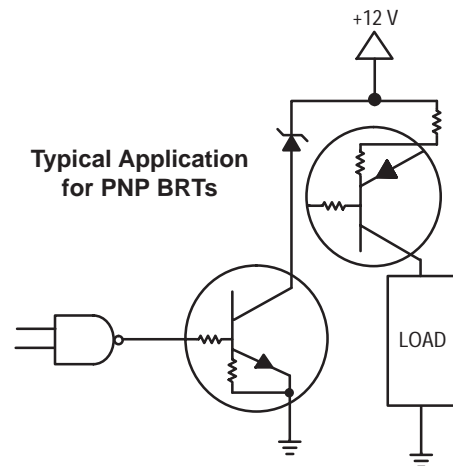


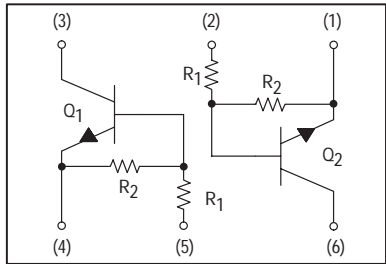
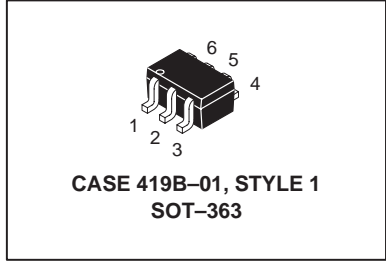
Figure 22. Inexpensive, Unregulated Current Source

Dual Bias Resistor Transistors

NPN Silicon Surface Mount Transistors with Monolithic Bias Resistor Network

The BRT (Bias Resistor Transistor) contains a single transistor with a monolithic bias network consisting of two resistors; a series base resistor and a base-emitter resistor. These digital transistors are designed to replace a single device and its external resistor bias network. The BRT eliminates these individual components by integrating them into a single device. In the MUN5211DW1T1 series, two BRT devices are housed in the SOT-363 package which is ideal for low power surface mount applications where board space is at a premium.

- Simplifies Circuit Design
- Reduces Board Space
- Reduces Component Count
- Available in 8 mm, 7 inch/3000 Unit Tape and Reel.



MAXIMUM RATINGS ($T_A = 25^\circ\text{C}$ unless otherwise noted, common for Q_1 and Q_2)

Rating	Symbol	Value	Unit
Collector-Base Voltage	V_{CBO}	50	Vdc
Collector-Emitter Voltage	V_{CEO}	50	Vdc
Collector Current	I_C	100	mAdc

THERMAL CHARACTERISTICS

Thermal Resistance — Junction-to-Ambient (surface mounted)	$R_{\theta JA}$	833	$^\circ\text{C/W}$
Operating and Storage Temperature Range	T_J, T_{stg}	-65 to +150	$^\circ\text{C}$
Total Package Dissipation @ $T_A = 25^\circ\text{C}$ (1)	P_D	150	mW

DEVICE MARKING AND RESISTOR VALUES: MUN5211DW1T1 SERIES

Device	Marking	R1 (K)	R2 (K)
MUN5211DW1T1	7A	10	10
MUN5212DW1T1	7B	22	22
MUN5213DW1T1	7C	47	47
MUN5214DW1T1	7D	10	47
MUN5215DW1T1(2)	7E	10	∞
MUN5216DW1T1(2)	7F	4.7	∞
MUN5230DW1T1(2)	7G	1.0	1.0
MUN5231DW1T1(2)	7H	2.2	2.2
MUN5232DW1T1(2)	7J	4.7	4.7
MUN5233DW1T1(2)	7K	4.7	47
MUN5234DW1T1(2)	7L	22	47
MUN5235DW1T1(2)	7M	2.2	47

1. Device mounted on a FR-4 glass epoxy printed circuit board using the minimum recommended footprint.
2. New resistor combinations. Updated curves to follow in subsequent data sheets.

Preferred devices are Motorola recommended choices for future use and best overall value.

MUN5211DW1T1 SERIES

ELECTRICAL CHARACTERISTICS ($T_A = 25^\circ\text{C}$ unless otherwise noted, common for Q₁ and Q₂)

Characteristic	Symbol	Min	Typ	Max	Unit
OFF CHARACTERISTICS					
Collector-Base Cutoff Current ($V_{CB} = 50\text{ V}$, $I_E = 0$)	I_{CBO}	—	—	100	nAdc
Collector-Emitter Cutoff Current ($V_{CE} = 50\text{ V}$, $I_B = 0$)	I_{CEO}	—	—	500	nAdc
Emitter-Base Cutoff Current ($V_{EB} = 6.0\text{ V}$, $I_C = 0$)	MUN5211DW1T1	—	—	0.5	mAdc
	MUN5212DW1T1	—	—	0.2	
	MUN5213DW1T1	—	—	0.1	
	MUN5214DW1T1	—	—	0.2	
	MUN5215DW1T1	—	—	0.9	
	MUN5216DW1T1	—	—	1.9	
	MUN5230DW1T1	—	—	4.3	
	MUN5231DW1T1	—	—	2.3	
	MUN5232DW1T1	—	—	1.5	
	MUN5233DW1T1	—	—	0.18	
	MUN5234DW1T1	—	—	0.13	
MUN5235DW1T1	—	—	0.2		
Collector-Base Breakdown Voltage ($I_C = 10\ \mu\text{A}$, $I_E = 0$)	$V_{(BR)CBO}$	50	—	—	Vdc
Collector-Emitter Breakdown Voltage ⁽³⁾ ($I_C = 2.0\text{ mA}$, $I_B = 0$)	$V_{(BR)CEO}$	50	—	—	Vdc

ON CHARACTERISTICS⁽³⁾

DC Current Gain ($V_{CE} = 10\text{ V}$, $I_C = 5.0\text{ mA}$)	MUN5211DW1T1	h_{FE}	35	60	—		
	MUN5212DW1T1		60	100	—		
	MUN5213DW1T1		80	140	—		
	MUN5214DW1T1		80	140	—		
	MUN5215DW1T1		160	350	—		
	MUN5216DW1T1		160	350	—		
	MUN5230DW1T1		3.0	5.0	—		
	MUN5231DW1T1		8.0	15	—		
	MUN5232DW1T1		15	30	—		
	MUN5233DW1T1		80	200	—		
	MUN5234DW1T1		80	150	—		
	MUN5235DW1T1		80	140	—		
Collector-Emitter Saturation Voltage ($I_C = 10\text{ mA}$, $I_B = 0.3\text{ mA}$) ($I_C = 10\text{ mA}$, $I_B = 5\text{ mA}$) MUN5230DW1T1/MUN5231DW1T1 ($I_C = 10\text{ mA}$, $I_B = 1\text{ mA}$) MUN5215DW1T1/MUN5216DW1T1 MUN5232DW1T1/MUN5233DW1T1/MUN5234DW1T1	$V_{CE(sat)}$	—	—	0.25	Vdc		
Output Voltage (on) ($V_{CC} = 5.0\text{ V}$, $V_B = 2.5\text{ V}$, $R_L = 1.0\text{ k}\Omega$)	MUN5211DW1T1	V_{OL}	—	—	0.2	Vdc	
	MUN5212DW1T1		—	—	0.2		
	MUN5214DW1T1		—	—	0.2		
	MUN5215DW1T1		—	—	0.2		
	MUN5216DW1T1		—	—	0.2		
	MUN5230DW1T1		—	—	0.2		
	MUN5231DW1T1		—	—	0.2		
	MUN5232DW1T1		—	—	0.2		
	MUN5233DW1T1		—	—	0.2		
	MUN5234DW1T1		—	—	0.2		
	MUN5235DW1T1		—	—	0.2		
	($V_{CC} = 5.0\text{ V}$, $V_B = 3.5\text{ V}$, $R_L = 1.0\text{ k}\Omega$)		MUN5213DW1T1	—	—		0.2

3. Pulse Test: Pulse Width < 300 μs , Duty Cycle < 2.0%

ELECTRICAL CHARACTERISTICS ($T_A = 25^\circ\text{C}$ unless otherwise noted, common for Q₁ and Q₂) (Continued)

Characteristic	Symbol	Min	Typ	Max	Unit
Output Voltage (off) ($V_{CC} = 5.0\text{ V}$, $V_B = 0.5\text{ V}$, $R_L = 1.0\text{ k}\Omega$) ($V_{CC} = 5.0\text{ V}$, $V_B = 0.050\text{ V}$, $R_L = 1.0\text{ k}\Omega$) ($V_{CC} = 5.0\text{ V}$, $V_B = 0.25\text{ V}$, $R_L = 1.0\text{ k}\Omega$) MUN5230DW1T1 MUN5215DW1T1 MUN5216DW1T1 MUN5233DW1T1	V_{OH}	4.9	—	—	Vdc
Input Resistor MUN5211DW1T1 MUN5212DW1T1 MUN5213DW1T1 MUN5214DW1T1 MUN5215DW1T1 MUN5216DW1T1 MUN5230DW1T1 MUN5231DW1T1 MUN5232DW1T1 MUN5233DW1T1 MUN5234DW1T1 MUN5235DW1T1	R1	7.0 15.4 32.9 7.0 7.0 3.3 0.7 1.5 3.3 3.3 15.4 1.54	10 22 47 10 10 4.7 1.0 2.2 4.7 4.7 22 2.2	13 28.6 61.1 13 13 6.1 1.3 2.9 6.1 6.1 28.6 2.86	k Ω
Resistor Ratio MUN5211DW1T1/MUN5212DW1T1/MUN5213DW1T1 MUN5214DW1T1 MUN5215DW1T1/MUN5216DW1T1 MUN5230DW1T1/MUN5231DW1T1/MUN5232DW1T1 MUN5233DW1T1 MUN5234DW1T1 MUN5235DW1T1	R1/R2	0.8 0.17 — 0.8 0.055 0.38 0.038	1.0 0.21 — 1.0 0.1 0.47 0.047	1.2 0.25 — 1.2 0.185 0.56 0.056	

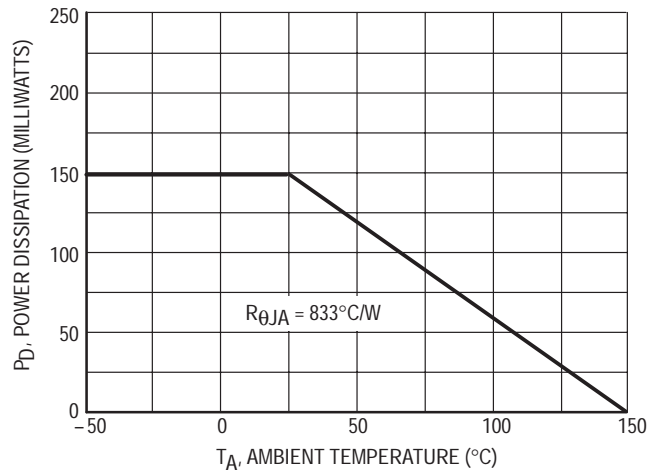


Figure 1. Derating Curve

TYPICAL ELECTRICAL CHARACTERISTICS — MUN5211DW1T1

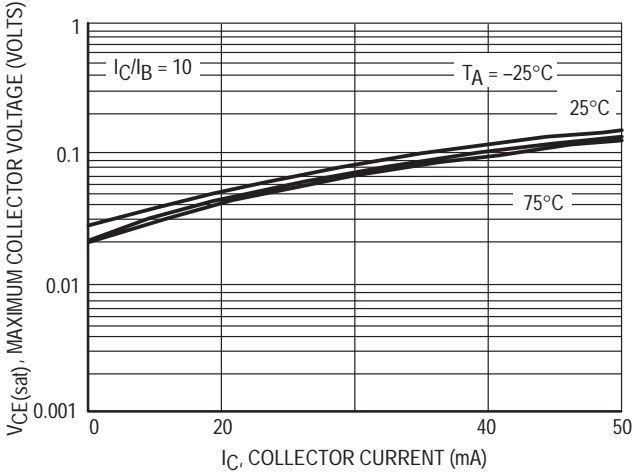


Figure 2. $V_{CE(sat)}$ versus I_C

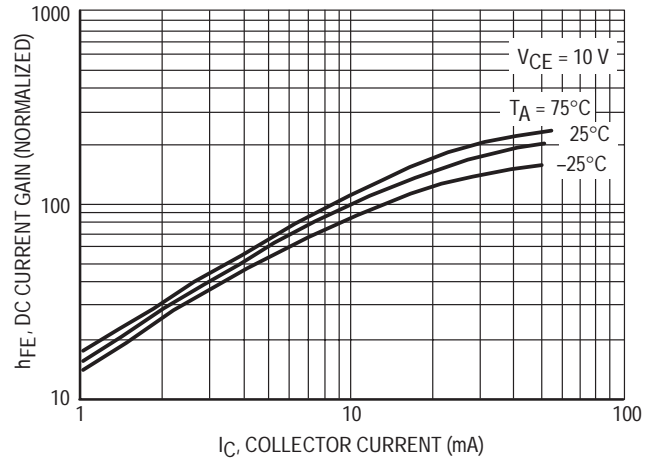


Figure 3. DC Current Gain

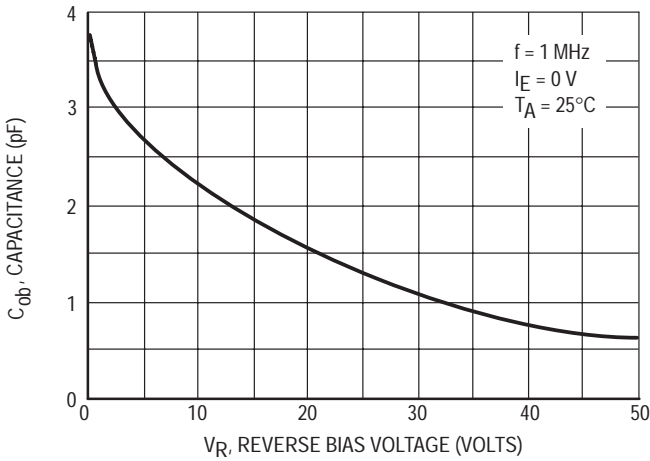


Figure 4. Output Capacitance

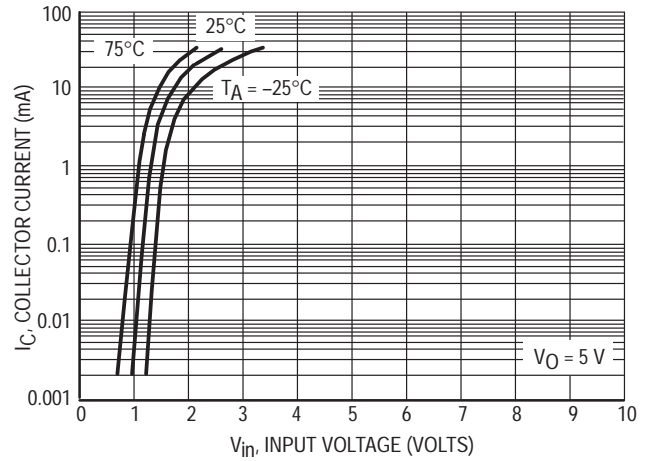


Figure 5. Output Current versus Input Voltage

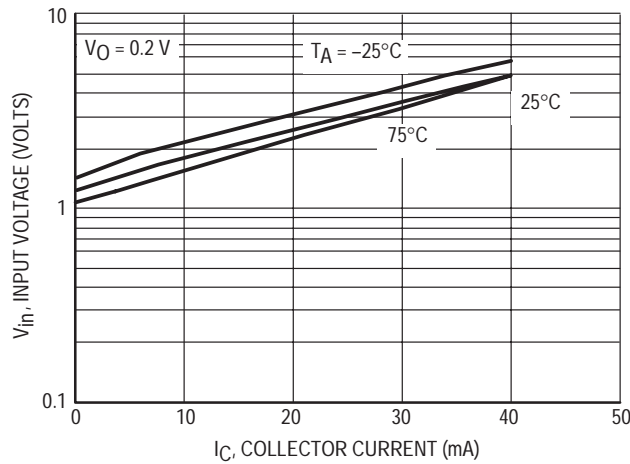


Figure 6. Input Voltage versus Output Current

TYPICAL ELECTRICAL CHARACTERISTICS — MUN5212DW1T1

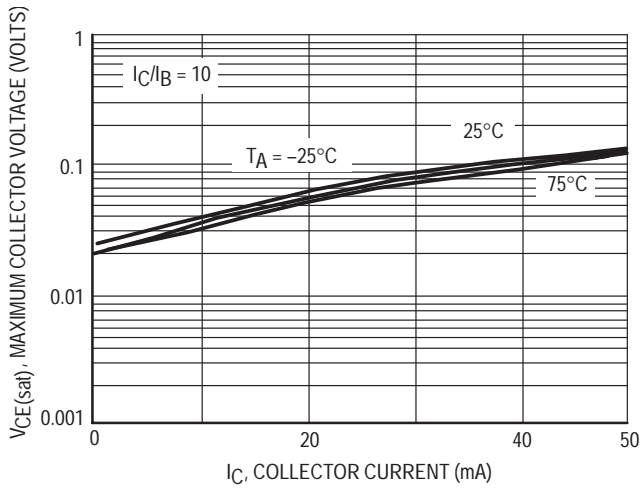


Figure 7. $V_{CE(sat)}$ versus I_C

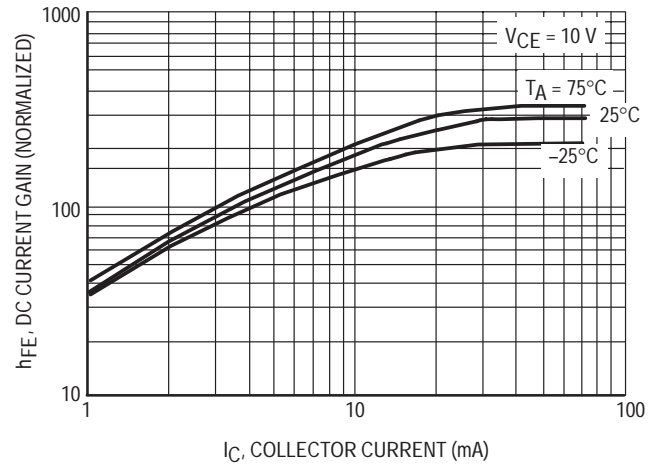


Figure 8. DC Current Gain

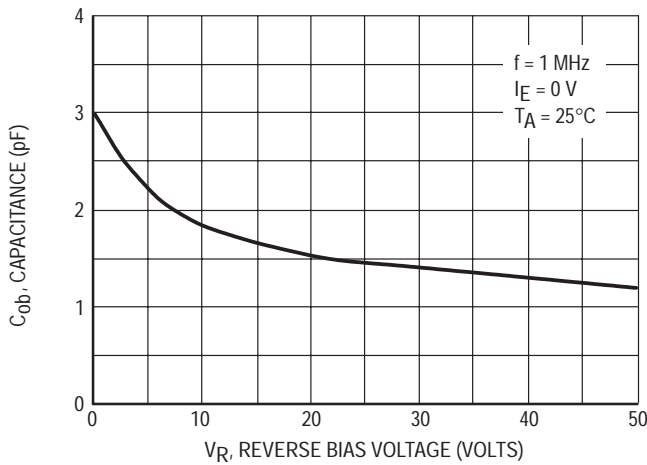


Figure 9. Output Capacitance

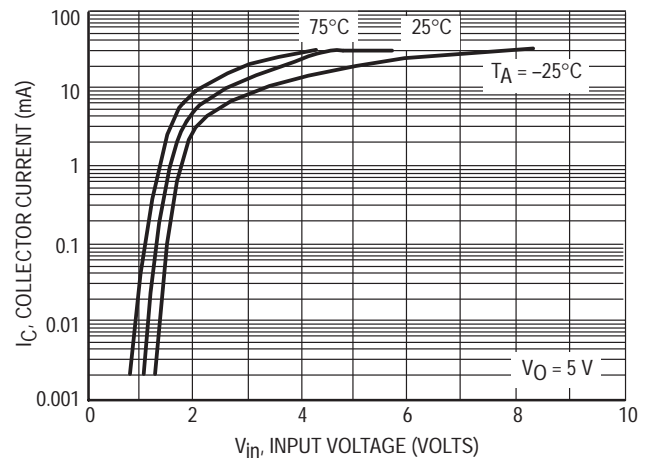


Figure 10. Output Current versus Input Voltage

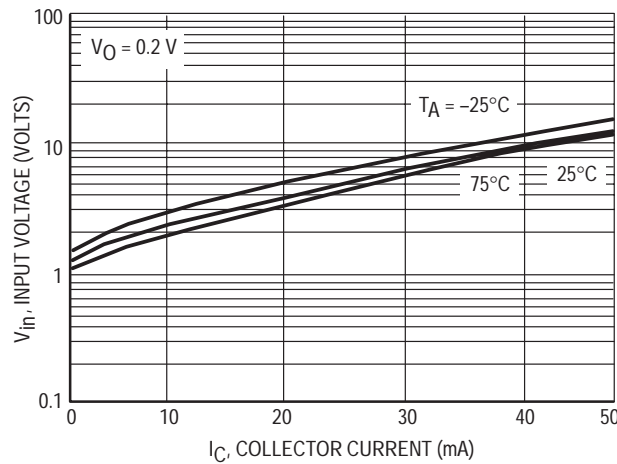


Figure 11. Input Voltage versus Output Current

TYPICAL ELECTRICAL CHARACTERISTICS — MUN5213DW1T1

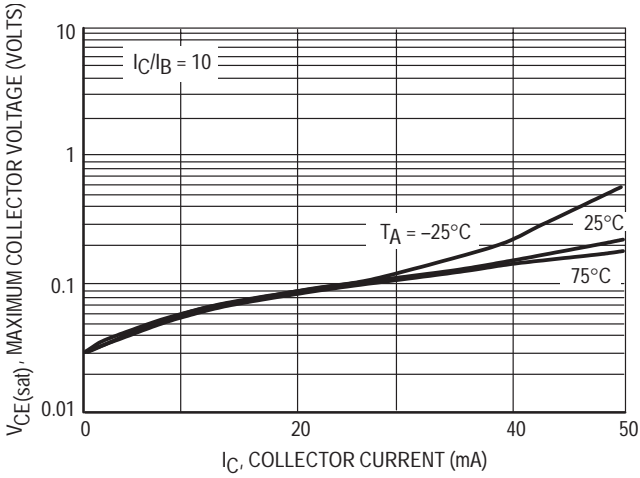


Figure 12. $V_{CE(sat)}$ versus I_C

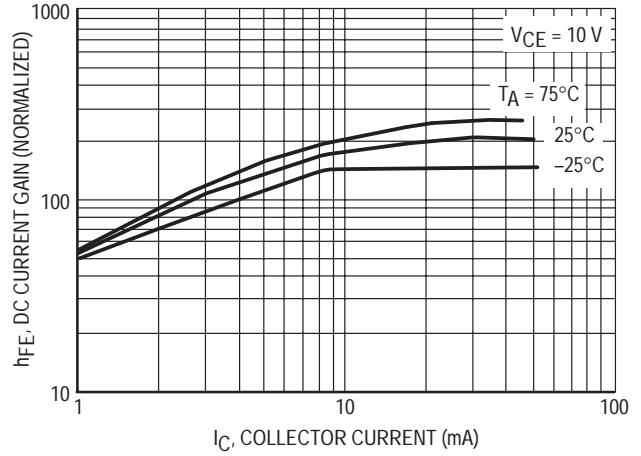


Figure 13. DC Current Gain

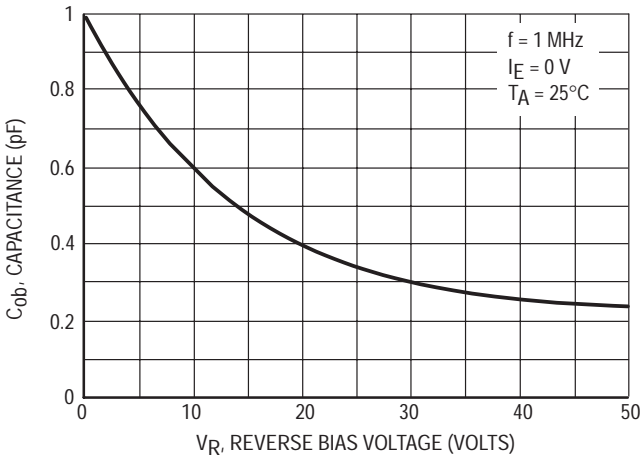


Figure 14. Output Capacitance

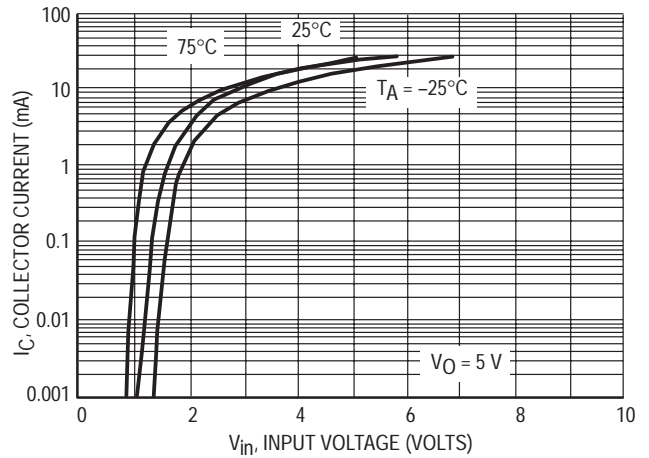


Figure 15. Output Current versus Input Voltage

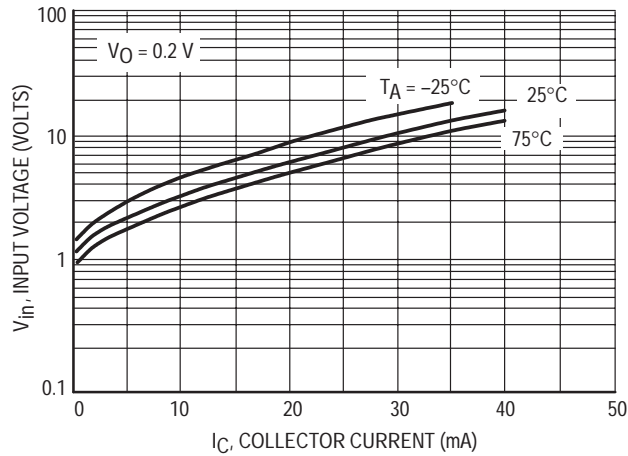


Figure 16. Input Voltage versus Output Current

TYPICAL ELECTRICAL CHARACTERISTICS — MUN5214DW1T1

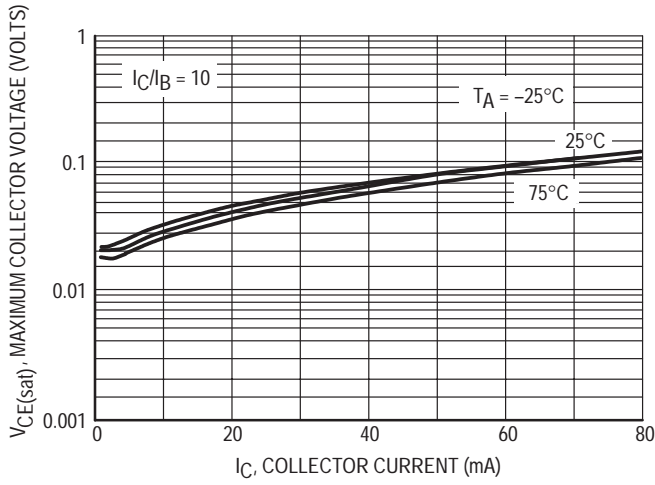


Figure 17. $V_{CE(sat)}$ versus I_C

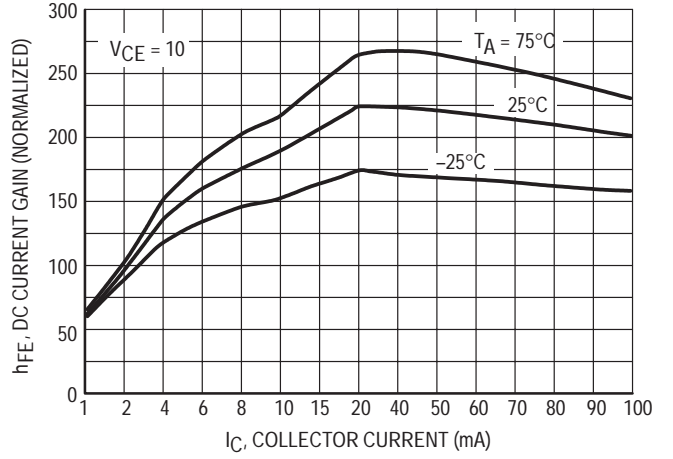


Figure 18. DC Current Gain

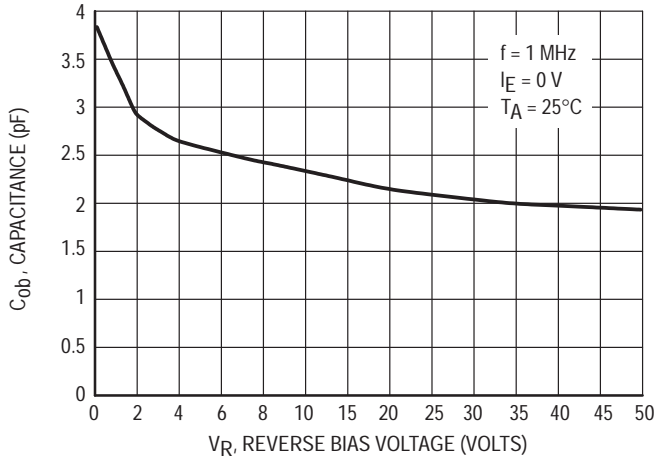


Figure 19. Output Capacitance

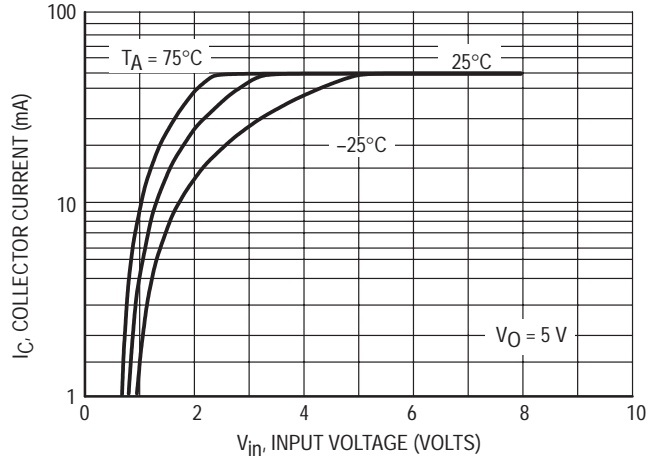


Figure 20. Output Current versus Input Voltage

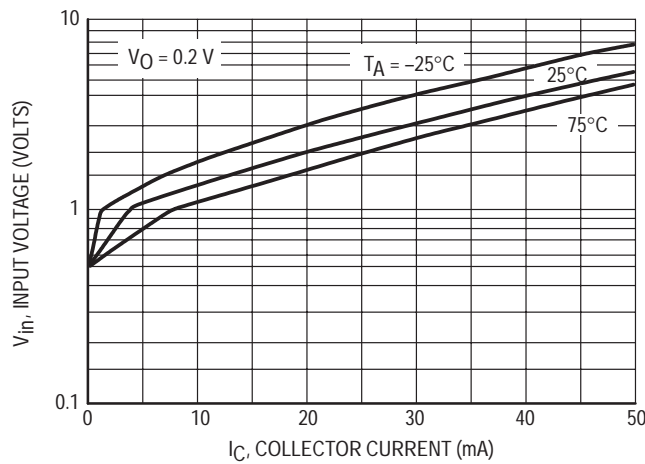


Figure 21. Input Voltage versus Output Current

TYPICAL ELECTRICAL CHARACTERISTICS — MUN5215DW1T1

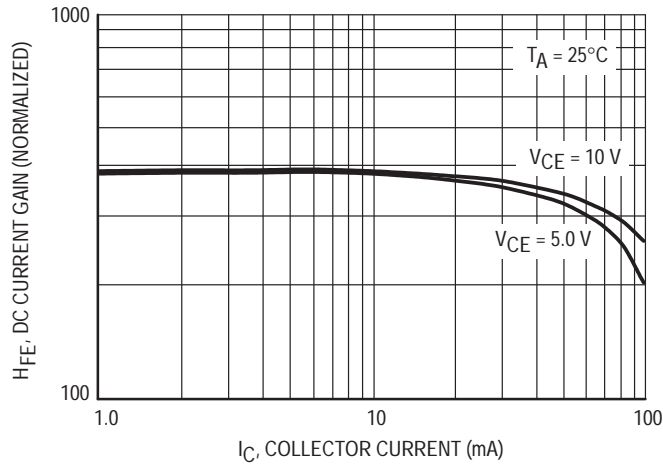


Figure 22. DC Current Gain

TYPICAL ELECTRICAL CHARACTERISTICS — MUN5216DW1T1

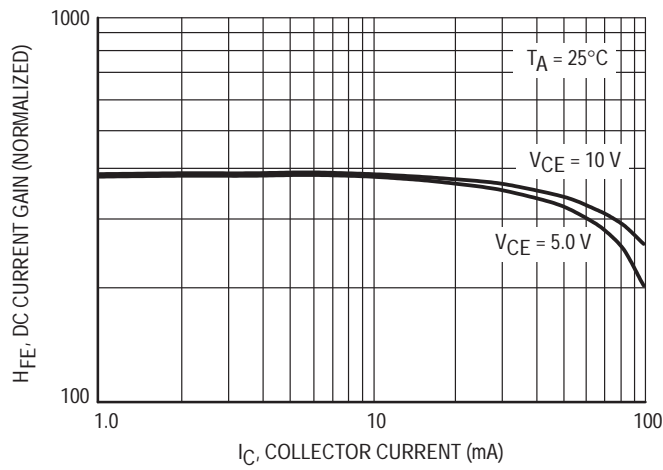


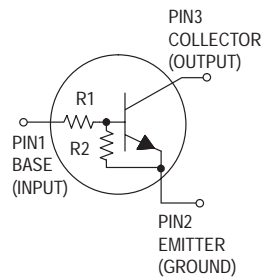
Figure 23. DC Current Gain

Bias Resistor Transistor

NPN Silicon Surface Mount Transistor with Monolithic Bias Resistor Network

This new series of digital transistors is designed to replace a single device and its external resistor bias network. The BRT (Bias Resistor Transistor) contains a single transistor with a monolithic bias network consisting of two resistors; a series base resistor and a base-emitter resistor. The BRT eliminates these individual components by integrating them into a single device. The use of a BRT can reduce both system cost and board space. The device is housed in the SC-70/SOT-323 package which is designed for low power surface mount applications.

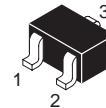
- Simplifies Circuit Design
- Reduces Board Space
- Reduces Component Count
- The SC-70/SOT-323 package can be soldered using wave or reflow. The modified gull-winged leads absorb thermal stress during soldering eliminating the possibility of damage to the die.
- Available in 8 mm embossed tape and reel
Use the Device Number to order the 7 inch/3000 unit reel.
Replace "T1" with "T3" in the Device Number to order the 13 inch/10,000 unit reel.



MUN5211T1 SERIES

Motorola Preferred Devices

NPN SILICON BIAS RESISTOR TRANSISTORS



CASE 419-02, STYLE 3
SC-70/SOT-323

MAXIMUM RATINGS ($T_A = 25^\circ\text{C}$ unless otherwise noted)

Rating	Symbol	Value	Unit
Collector-Base Voltage	V_{CBO}	50	Vdc
Collector-Emitter Voltage	V_{CEO}	50	Vdc
Collector Current	I_C	100	mAdc
Total Power Dissipation @ $T_A = 25^\circ\text{C}$ (1) Derate above 25°C	P_D	150 1.2	mW mW/°C

THERMAL CHARACTERISTICS

Thermal Resistance — Junction-to-Ambient (surface mounted)	$R_{\theta JA}$	833	°C/W
Operating and Storage Temperature Range	T_J, T_{stg}	-65 to +150	°C
Maximum Temperature for Soldering Purposes, Time in Solder Bath	T_L	260 10	°C Sec

DEVICE MARKING AND RESISTOR VALUES

Device	Marking	R1 (K)	R2 (K)
MUN5211T1	8A	10	10
MUN5212T1	8B	22	22
MUN5213T1	8C	47	47
MUN5214T1	8D	10	47
MUN5215T1(2)	8E	10	∞
MUN5216T1(2)	8F	4.7	∞
MUN5230T1(2)	8G	1.0	1.0
MUN5231T1(2)	8H	2.2	2.2
MUN5232T1(2)	8J	4.7	4.7
MUN5233T1(2)	8K	4.7	47
MUN5234T1(2)	8L	22	47

1. Device mounted on a FR-4 glass epoxy printed circuit board using the minimum recommended footprint.
2. New devices. Updated curves to follow in subsequent data sheets.

Preferred devices are Motorola recommended choices for future use and best overall value.

MUN5211T1 SERIES

ELECTRICAL CHARACTERISTICS (T_A = 25°C unless otherwise noted)

Characteristic	Symbol	Min	Typ	Max	Unit
OFF CHARACTERISTICS					
Collector-Base Cutoff Current (V _{CB} = 50 V, I _E = 0)	I _{CBO}	—	—	100	nAdc
Collector-Emitter Cutoff Current (V _{CE} = 50 V, I _B = 0)	I _{CEO}	—	—	500	nAdc
Emitter-Base Cutoff Current (V _{EB} = 6.0 V, I _C = 0)	I _{EBO}	—	—	0.5	mAdc
MUN5211T1		—	—	0.2	
MUN5212T1		—	—	0.1	
MUN5213T1		—	—	0.2	
MUN5214T1		—	—	0.9	
MUN5215T1		—	—	1.9	
MUN5216T1		—	—	4.3	
MUN5230T1		—	—	2.3	
MUN5231T1		—	—	1.5	
MUN5232T1		—	—	0.18	
MUN5233T1		—	—	0.13	
MUN5234T1		—	—		
Collector-Base Breakdown Voltage (I _C = 10 μA, I _E = 0)	V _{(BR)CBO}	50	—	—	Vdc
Collector-Emitter Breakdown Voltage ⁽³⁾ (I _C = 2.0 mA, I _B = 0)	V _{(BR)CEO}	50	—	—	Vdc

ON CHARACTERISTICS⁽³⁾

DC Current Gain (V _{CE} = 10 V, I _C = 5.0 mA)	h _{FE}	35	60	—	
MUN5211T1		60	100	—	
MUN5212T1		80	140	—	
MUN5213T1		80	140	—	
MUN5214T1		160	350	—	
MUN5215T1		160	350	—	
MUN5216T1		3.0	5.0	—	
MUN5230T1		8.0	15	—	
MUN5231T1		15	30	—	
MUN5232T1		80	200	—	
MUN5233T1		80	150	—	
MUN5234T1					
Collector-Emitter Saturation Voltage (I _C = 10 mA, I _B = 0.3 mA) (I _C = 10 mA, I _B = 5 mA) MUN5230T1/MUN5231T1 (I _C = 10 mA, I _B = 1 mA) MUN5215T1/MUN5216T1 MUN5232T1/MUN5233T1/MUN5234T1	V _{CE(sat)}	—	—	0.25	Vdc
Output Voltage (on) (V _{CC} = 5.0 V, V _B = 2.5 V, R _L = 1.0 kΩ)	V _{OL}	—	—	0.2	Vdc
MUN5211T1		—	—	0.2	
MUN5212T1		—	—	0.2	
MUN5214T1		—	—	0.2	
MUN5215T1		—	—	0.2	
MUN5216T1		—	—	0.2	
MUN5230T1		—	—	0.2	
MUN5231T1		—	—	0.2	
MUN5232T1		—	—	0.2	
MUN5233T1		—	—	0.2	
MUN5234T1		—	—	0.2	
(V _{CC} = 5.0 V, V _B = 3.5 V, R _L = 1.0 kΩ)		—	—	0.2	
MUN5213T1		—	—	0.2	

3. Pulse Test: Pulse Width < 300 μs, Duty Cycle < 2.0%

ELECTRICAL CHARACTERISTICS ($T_A = 25^\circ\text{C}$ unless otherwise noted) (Continued)

Characteristic	Symbol	Min	Typ	Max	Unit
Output Voltage (off) ($V_{CC} = 5.0\text{ V}$, $V_B = 0.5\text{ V}$, $R_L = 1.0\text{ k}\Omega$) ($V_{CC} = 5.0\text{ V}$, $V_B = 0.050\text{ V}$, $R_L = 1.0\text{ k}\Omega$) ($V_{CC} = 5.0\text{ V}$, $V_B = 0.25\text{ V}$, $R_L = 1.0\text{ k}\Omega$)	V_{OH}	4.9	—	—	Vdc
Input Resistor	R1	7.0	10	13	k Ω
MUN5211T1		15.4	22	28.6	
MUN5212T1		32.9	47	61.1	
MUN5213T1		7.0	10	13	
MUN5214T1		7.0	10	13	
MUN5215T1		3.3	4.7	6.1	
MUN5216T1		0.7	1.0	1.3	
MUN5230T1		1.5	2.2	2.9	
MUN5231T1		3.3	4.7	6.1	
MUN5232T1		3.3	4.7	6.1	
MUN5233T1		15.4	22	28.6	
MUN5234T1					
Resistor Ratio	R1/R2	0.8	1.0	1.2	
MUN5211T1/MUN5212T1/MUN5213T1		0.17	0.21	0.25	
MUN5214T1		—	—	—	
MUN5215T1/MUN5216T1		0.8	1.0	1.2	
MUN5230T1/MUN5231T1/MUN5232T1		0.055	0.1	0.185	
MUN5233T1		0.38	0.47	0.56	
MUN5234T1					

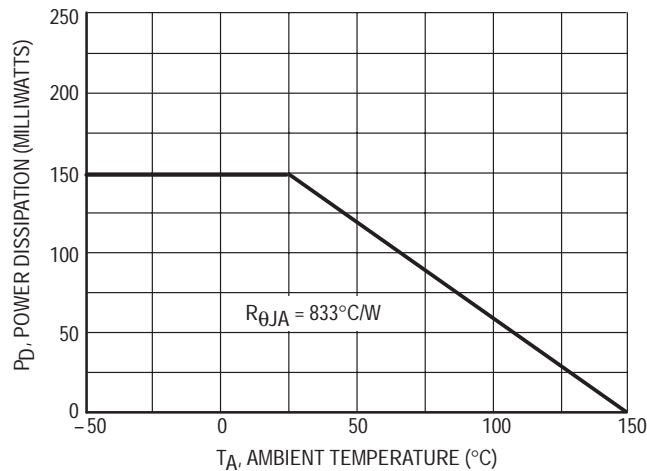


Figure 1. Derating Curve

TYPICAL ELECTRICAL CHARACTERISTICS — MUN5211T1

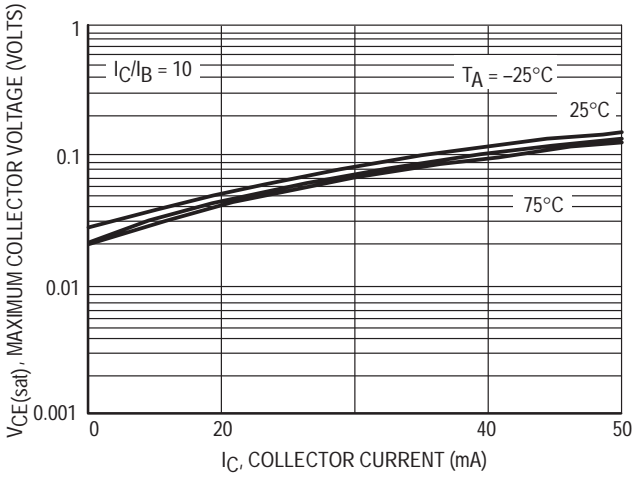


Figure 2. $V_{CE(sat)}$ versus I_C

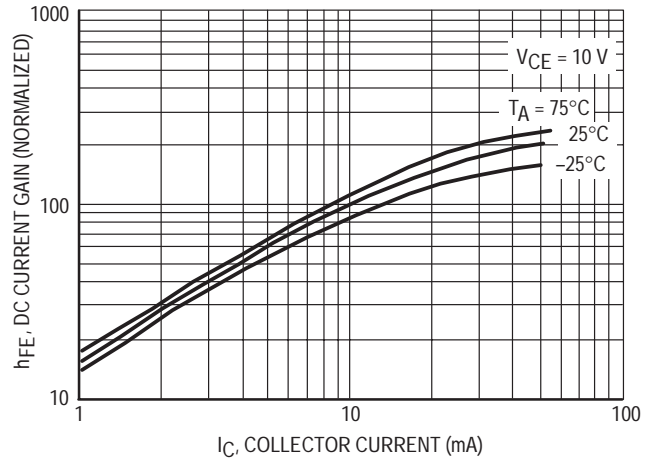


Figure 3. DC Current Gain

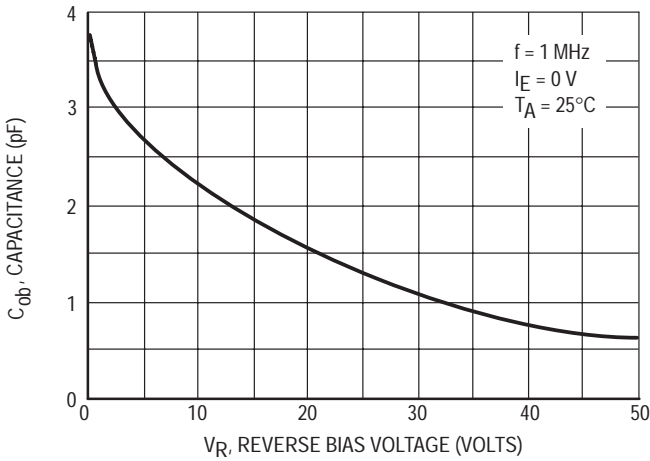


Figure 4. Output Capacitance

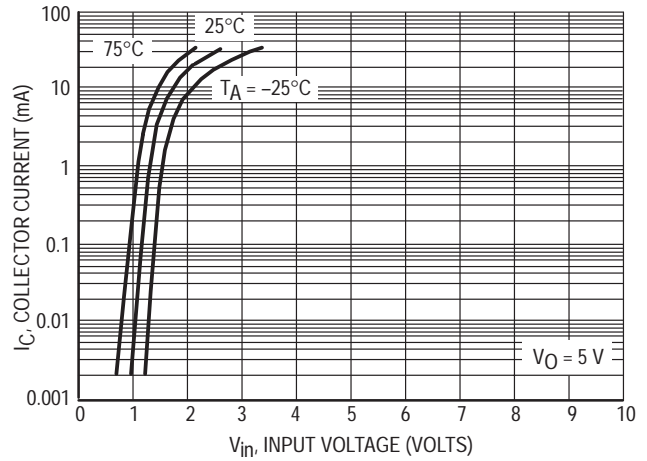


Figure 5. Output Current versus Input Voltage

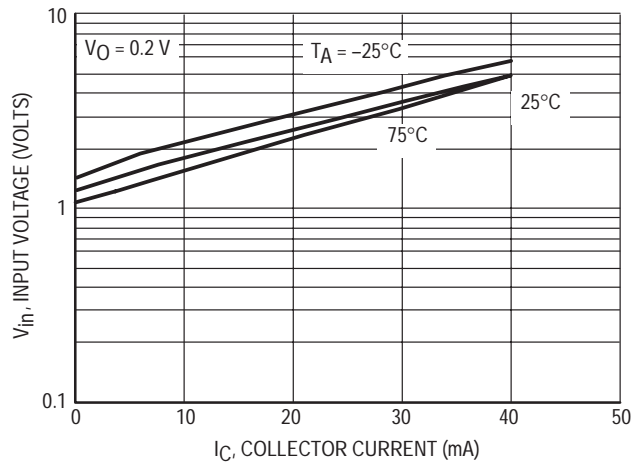


Figure 6. Input Voltage versus Output Current

TYPICAL ELECTRICAL CHARACTERISTICS — MUN5212T1

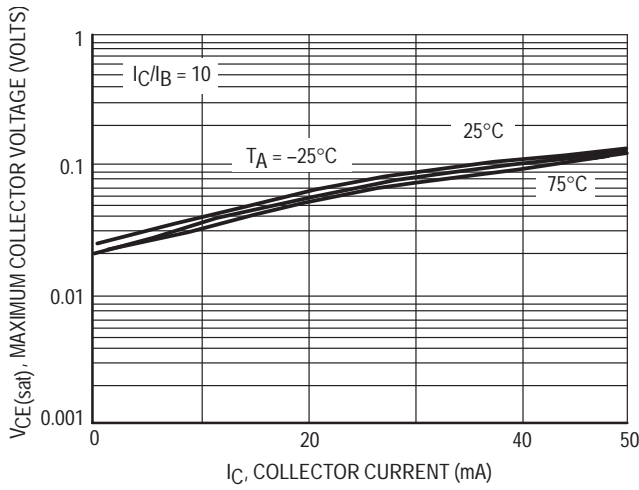


Figure 7. $V_{CE(sat)}$ versus I_C

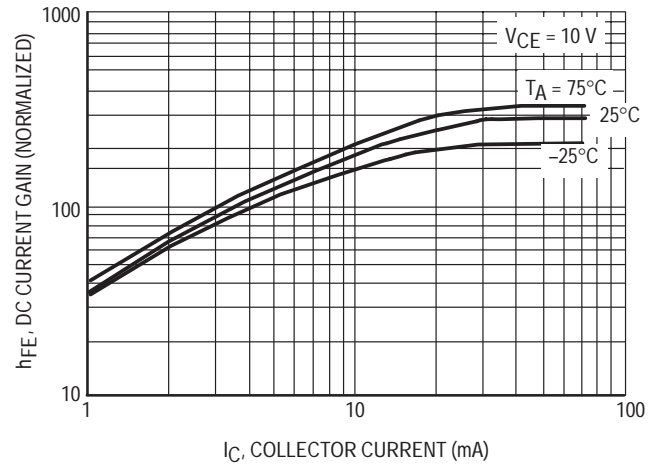


Figure 8. DC Current Gain

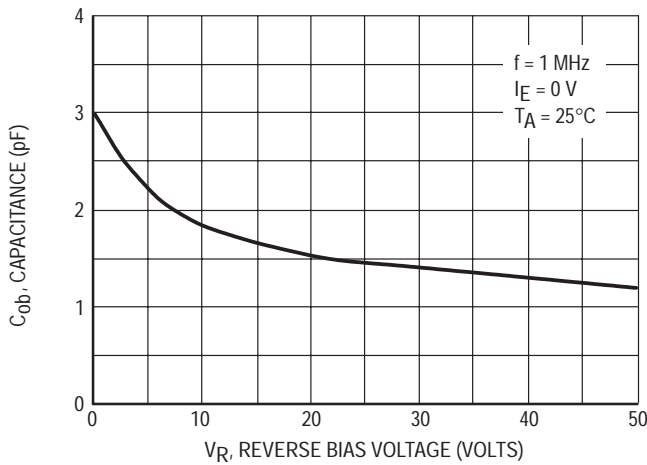


Figure 9. Output Capacitance

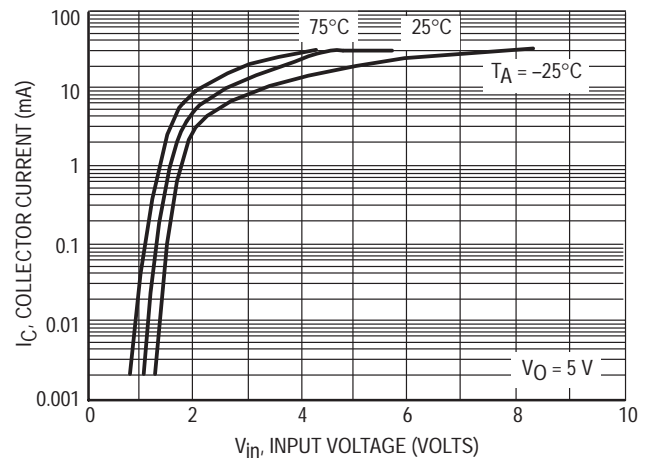


Figure 10. Output Current versus Input Voltage

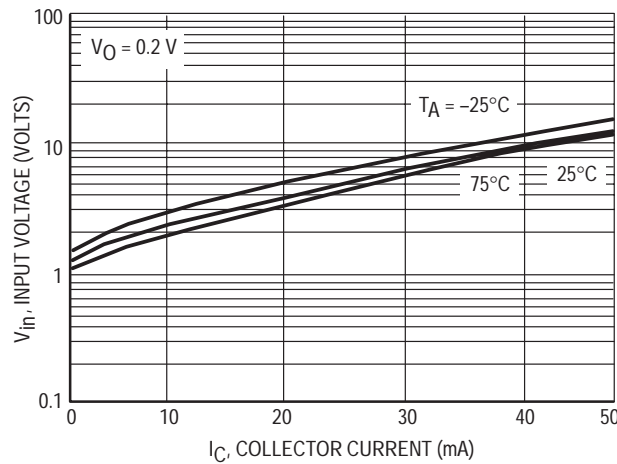


Figure 11. Input Voltage versus Output Current

TYPICAL ELECTRICAL CHARACTERISTICS — MUN5213T1

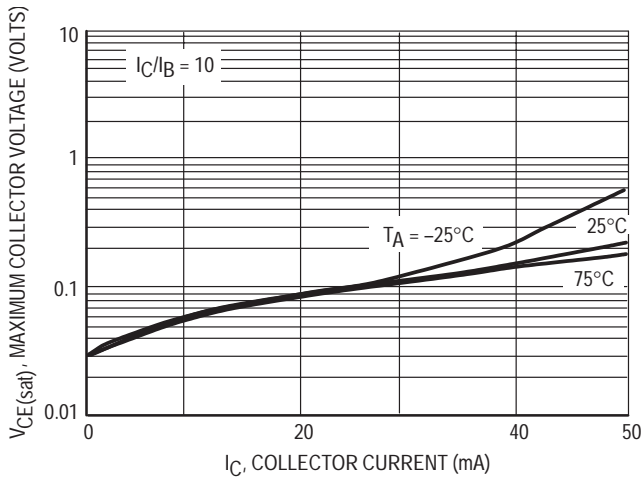


Figure 12. $V_{CE(sat)}$ versus I_C

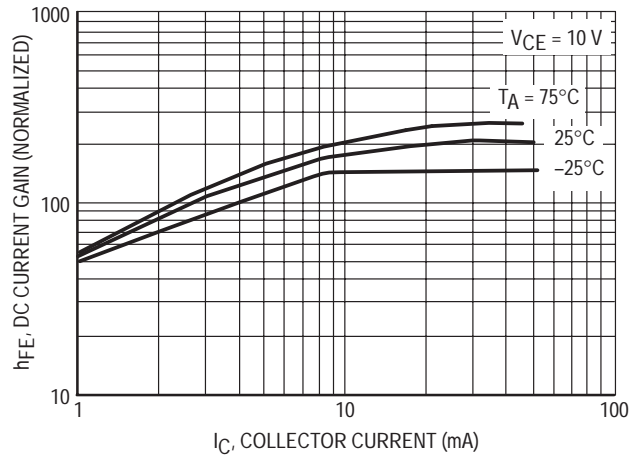


Figure 13. DC Current Gain

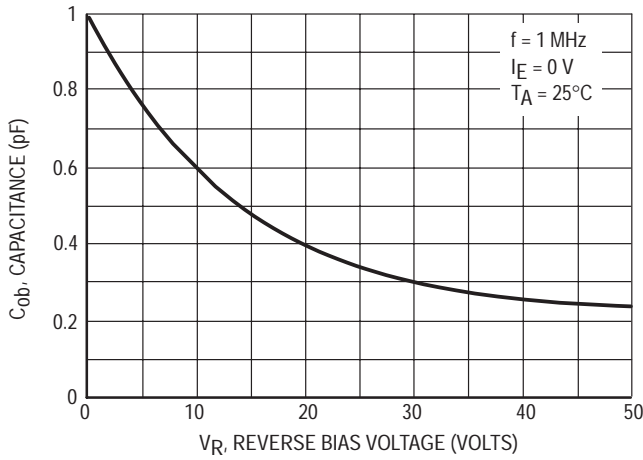


Figure 14. Output Capacitance

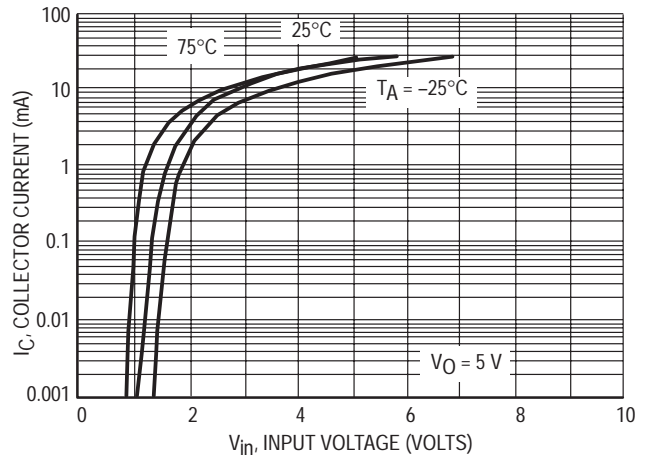


Figure 15. Output Current versus Input Voltage

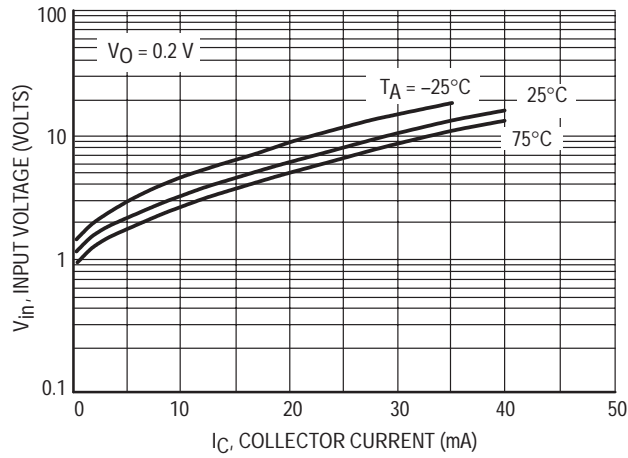


Figure 16. Input Voltage versus Output Current

TYPICAL ELECTRICAL CHARACTERISTICS — MUN5214T1

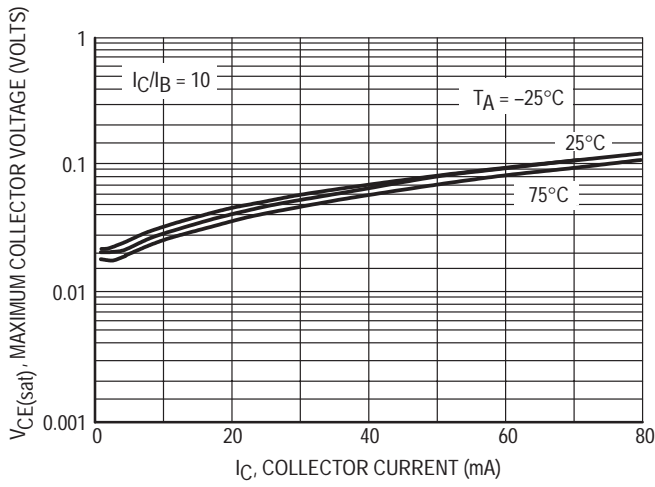


Figure 17. $V_{CE(sat)}$ versus I_C

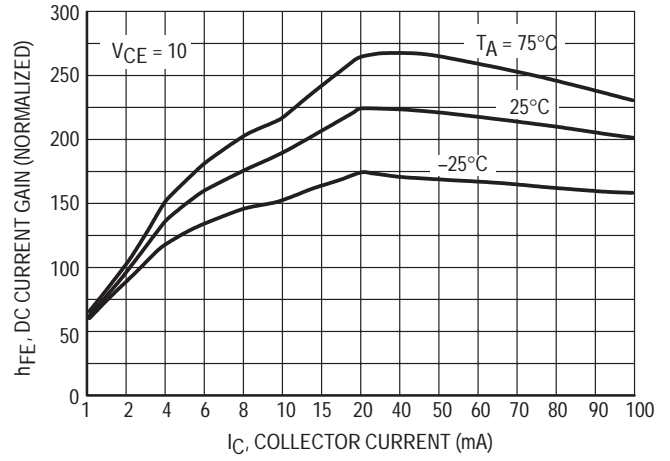


Figure 18. DC Current Gain

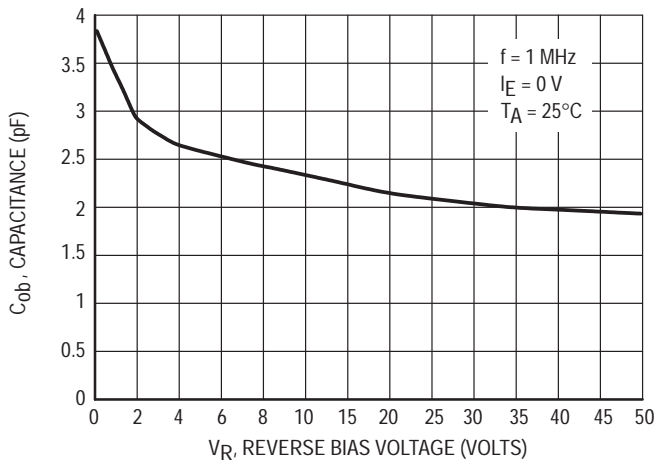


Figure 19. Output Capacitance

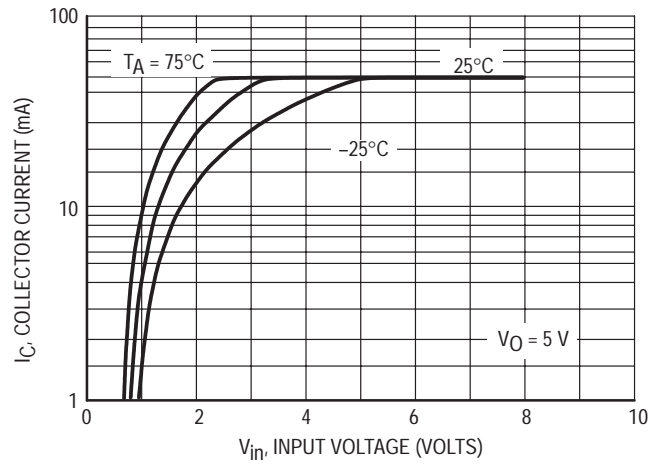


Figure 20. Output Current versus Input Voltage

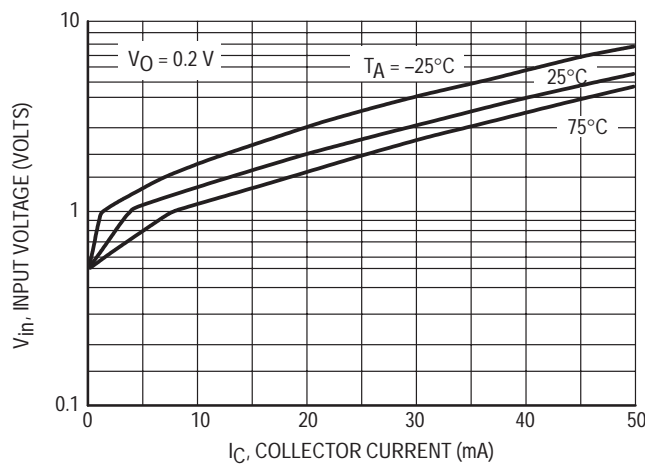


Figure 21. Input Voltage versus Output Current

TYPICAL APPLICATIONS FOR NPN BRTs

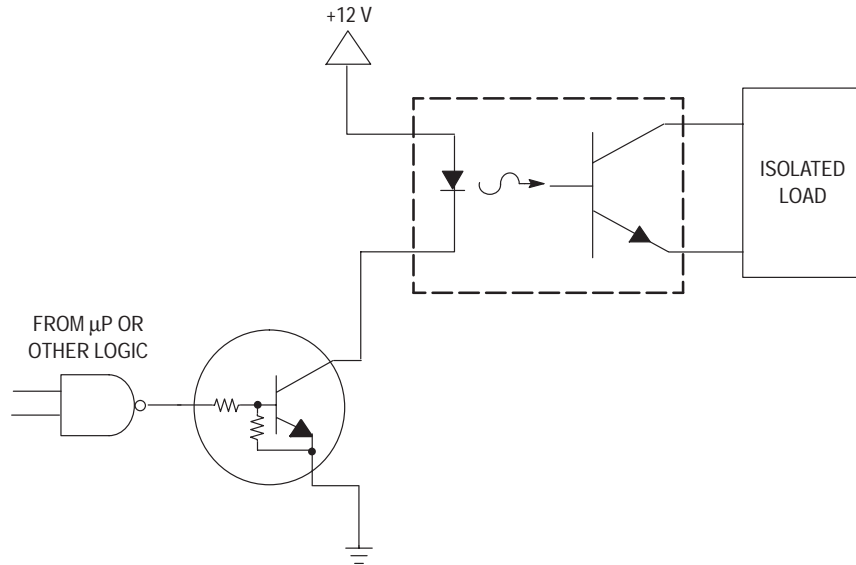


Figure 22. Level Shifter: Connects 12 or 24 Volt Circuits to Logic

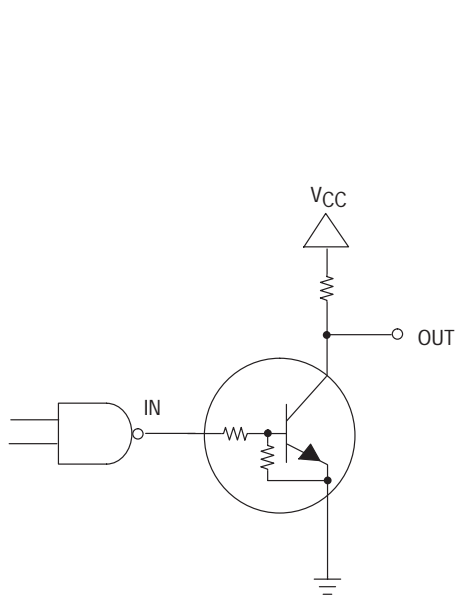


Figure 23. Open Collector Inverter: Inverts the Input Signal

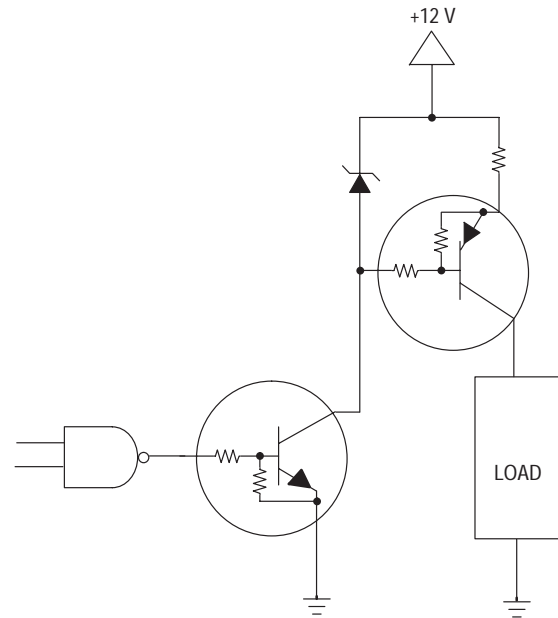


Figure 24. Inexpensive, Unregulated Current Source

Dual Bias Resistor Transistors

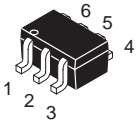
NPN and PNP Silicon Surface Mount Transistors with Monolithic Bias Resistor Network

The BRT (Bias Resistor Transistor) contains a single transistor with a monolithic bias network consisting of two resistors; a series base resistor and a base-emitter resistor. These digital transistors are designed to replace a single device and its external resistor bias network. The BRT eliminates these individual components by integrating them into a single device. In the MUN5311DW1T1 series, two complementary BRT devices are housed in the SOT-363 package which is ideal for low power surface mount applications where board space is at a premium.

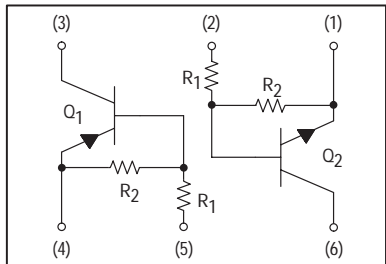
- Simplifies Circuit Design
- Reduces Board Space
- Reduces Component Count
- Available in 8 mm, 7 inch/3000 Unit Tape and Reel.

**MUN5311DW1T1
SERIES**

Motorola Preferred Devices



**CASE 419B-01, STYLE 1
SOT-363**



MAXIMUM RATINGS ($T_A = 25^\circ\text{C}$ unless otherwise noted, common for Q_1 and Q_2 , – minus sign for Q_2 (PNP) omitted)

Rating	Symbol	Value	Unit
Collector-Base Voltage	V_{CB0}	50	Vdc
Collector-Emitter Voltage	V_{CEO}	50	Vdc
Collector Current	I_C	100	mAdc

THERMAL CHARACTERISTICS

Thermal Resistance — Junction-to-Ambient (surface mounted)	$R_{\theta JA}$	833	$^\circ\text{C/W}$
Operating and Storage Temperature Range	T_J, T_{stg}	-65 to +150	$^\circ\text{C}$
Total Package Dissipation @ $T_A = 25^\circ\text{C}$ (1)	P_D	150	mW

DEVICE MARKING AND RESISTOR VALUES: MUN5311DW1T1 SERIES

Device	Marking	R1 (K)	R2 (K)
MUN5311DW1T1	11	10	10
MUN5312DW1T1	12	22	22
MUN5313DW1T1	13	47	47
MUN5314DW1T1	14	10	47
MUN5315DW1T1(2)	15	10	∞
MUN5316DW1T1(2)	16	4.7	∞
MUN5330DW1T1(2)	30	1.0	1.0
MUN5331DW1T1(2)	31	2.2	2.2
MUN5332DW1T1(2)	32	4.7	4.7
MUN5333DW1T1(2)	33	4.7	47
MUN5334DW1T1(2)	34	22	47
MUN5335DW1T1(2)	35	2.2	47

1. Device mounted on a FR-4 glass epoxy printed circuit board using the minimum recommended footprint.
2. New resistor combinations. Updated curves to follow in subsequent data sheets.

Preferred devices are Motorola recommended choices for future use and best overall value.

MUN5311DW1T1 SERIES

ELECTRICAL CHARACTERISTICS ($T_A = 25^\circ\text{C}$ unless otherwise noted, common for Q₁ and Q₂, – minus sign for Q₂ (PNP) omitted)

Characteristic	Symbol	Min	Typ	Max	Unit
OFF CHARACTERISTICS					
Collector-Base Cutoff Current ($V_{CB} = 50\text{ V}$, $I_E = 0$)	I_{CBO}	—	—	100	nAdc
Collector-Emitter Cutoff Current ($V_{CE} = 50\text{ V}$, $I_B = 0$)	I_{CEO}	—	—	500	nAdc
Emitter-Base Cutoff Current ($V_{EB} = 6.0\text{ V}$, $I_C = 0$)	I_{EBO}	—	—	0.5	mAdc
MUN5311DW1T1		—	—	0.2	
MUN5312DW1T1		—	—	0.1	
MUN5313DW1T1		—	—	0.2	
MUN5314DW1T1		—	—	0.9	
MUN5315DW1T1		—	—	1.9	
MUN5316DW1T1		—	—	4.3	
MUN5330DW1T1		—	—	2.3	
MUN5331DW1T1		—	—	1.5	
MUN5332DW1T1		—	—	0.18	
MUN5333DW1T1		—	—	0.13	
MUN5334DW1T1		—	—	0.2	
MUN5335DW1T1		—	—		
Collector-Base Breakdown Voltage ($I_C = 10\ \mu\text{A}$, $I_E = 0$)	$V_{(BR)CBO}$	50	—	—	Vdc
Collector-Emitter Breakdown Voltage ⁽³⁾ ($I_C = 2.0\text{ mA}$, $I_B = 0$)	$V_{(BR)CEO}$	50	—	—	Vdc

ON CHARACTERISTICS⁽³⁾

DC Current Gain ($V_{CE} = 10\text{ V}$, $I_C = 5.0\text{ mA}$)	h_{FE}	35	60	—	
MUN5311DW1T1		60	100	—	
MUN5312DW1T1		80	140	—	
MUN5313DW1T1		80	140	—	
MUN5314DW1T1		160	350	—	
MUN5315DW1T1		160	350	—	
MUN5316DW1T1		3.0	5.0	—	
MUN5330DW1T1		8.0	15	—	
MUN5331DW1T1		15	30	—	
MUN5332DW1T1		80	200	—	
MUN5333DW1T1		80	150	—	
MUN5334DW1T1		80	140	—	
MUN5335DW1T1					
Collector-Emitter Saturation Voltage ($I_C = 10\text{ mA}$, $I_B = 0.3\text{ mA}$) ($I_C = 10\text{ mA}$, $I_B = 5\text{ mA}$) MUN5330DW1T1/MUN5331DW1T1 ($I_C = 10\text{ mA}$, $I_B = 1\text{ mA}$) MUN5315DW1T1/MUN5316DW1T1 MUN5332DW1T1/MUN5333DW1T1/MUN5334DW1T1	$V_{CE(sat)}$	—	—	0.25	Vdc
Output Voltage (on) ($V_{CC} = 5.0\text{ V}$, $V_B = 2.5\text{ V}$, $R_L = 1.0\text{ k}\Omega$)	V_{OL}	—	—	0.2	Vdc
MUN5311DW1T1		—	—	0.2	
MUN5312DW1T1		—	—	0.2	
MUN5314DW1T1		—	—	0.2	
MUN5315DW1T1		—	—	0.2	
MUN5316DW1T1		—	—	0.2	
MUN5330DW1T1		—	—	0.2	
MUN5331DW1T1		—	—	0.2	
MUN5332DW1T1		—	—	0.2	
MUN5333DW1T1		—	—	0.2	
MUN5334DW1T1		—	—	0.2	
MUN5335DW1T1		—	—	0.2	
($V_{CC} = 5.0\text{ V}$, $V_B = 3.5\text{ V}$, $R_L = 1.0\text{ k}\Omega$)		—	—	0.2	
MUN5313DW1T1		—	—	0.2	

3. Pulse Test: Pulse Width < 300 μs , Duty Cycle < 2.0%

ELECTRICAL CHARACTERISTICS ($T_A = 25^\circ\text{C}$ unless otherwise noted, common for Q₁ and Q₂, – minus sign for Q₂ (PNP) omitted)
(Continued)

Characteristic	Symbol	Min	Typ	Max	Unit
Output Voltage (off) ($V_{CC} = 5.0\text{ V}$, $V_B = 0.5\text{ V}$, $R_L = 1.0\text{ k}\Omega$) ($V_{CC} = 5.0\text{ V}$, $V_B = 0.050\text{ V}$, $R_L = 1.0\text{ k}\Omega$) MUN5330DW1T1 ($V_{CC} = 5.0\text{ V}$, $V_B = 0.25\text{ V}$, $R_L = 1.0\text{ k}\Omega$) MUN5315DW1T1 MUN5316DW1T1 MUN5333DW1T1	V_{OH}	4.9	—	—	Vdc
Input Resistor MUN5311DW1T1 MUN5312DW1T1 MUN5313DW1T1 MUN5314DW1T1 MUN5315DW1T1 MUN5316DW1T1 MUN5330DW1T1 MUN5331DW1T1 MUN5332DW1T1 MUN5333DW1T1 MUN5334DW1T1 MUN5335DW1T1	R1	7.0 15.4 32.9 7.0 7.0 3.3 0.7 1.5 3.3 3.3 15.4 1.54	10 22 47 10 10 4.7 1.0 2.2 4.7 4.7 22 2.2	13 28.6 61.1 13 13 6.1 1.3 2.9 6.1 6.1 28.6 2.86	k Ω
Resistor Ratio MUN5311DW1T1/MUN5312DW1T1/MUN5313DW1T1 MUN5314DW1T1 MUN5315DW1T1/MUN5316DW1T1 MUN5330DW1T1/MUN5331DW1T1/MUN5332DW1T1 MUN5333DW1T1 MUN5334DW1T1 MUN5335DW1T1	R1/R2	0.8 0.17 — 0.8 0.055 0.38 0.038	1.0 0.21 — 1.0 0.1 0.47 0.047	1.2 0.25 — 1.2 0.185 0.56 0.056	

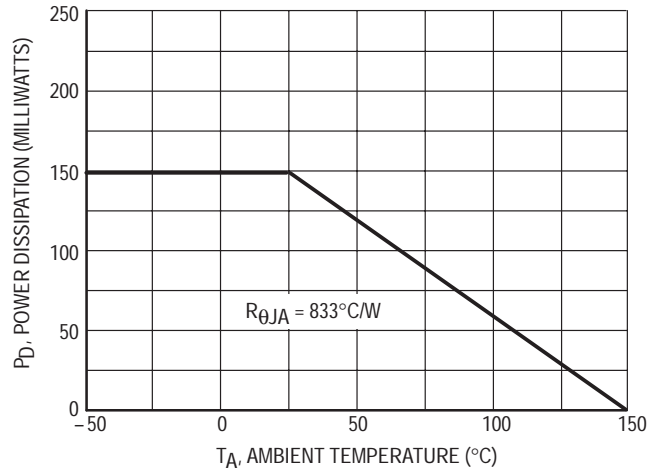


Figure 1. Derating Curve

TYPICAL ELECTRICAL CHARACTERISTICS — MUN5311DW1T1 NPN TRANSISTOR

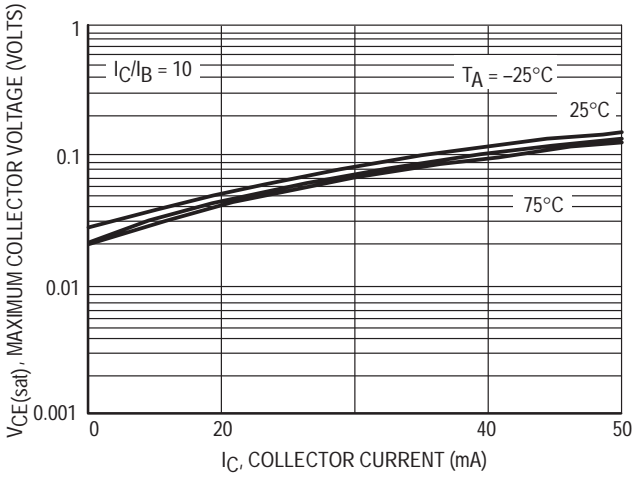


Figure 2. $V_{CE(sat)}$ versus I_C

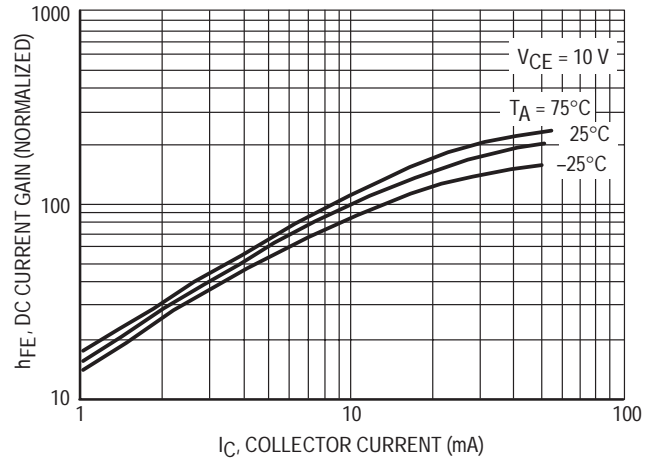


Figure 3. DC Current Gain

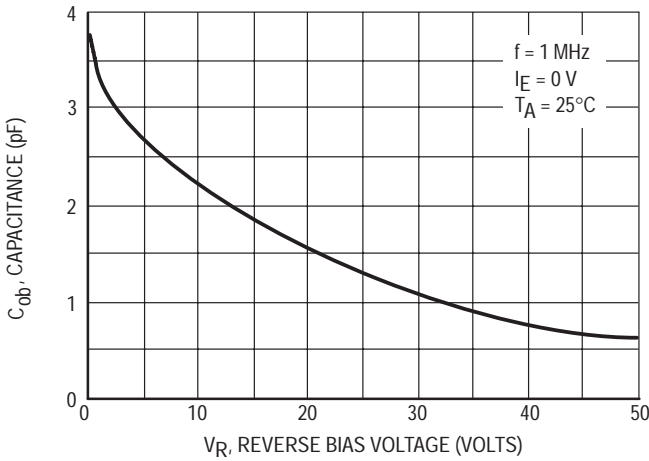


Figure 4. Output Capacitance

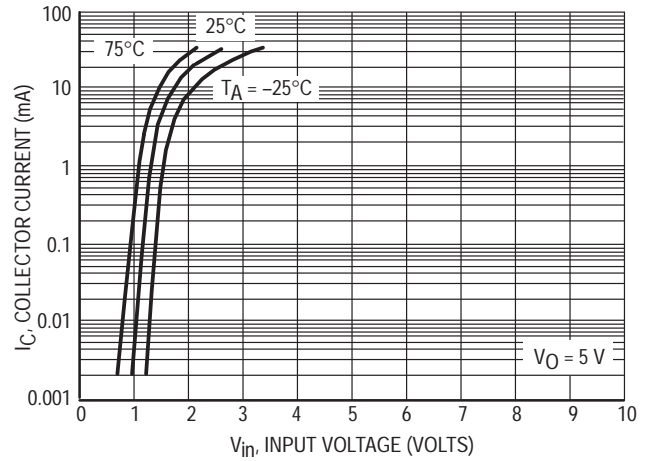


Figure 5. Output Current versus Input Voltage

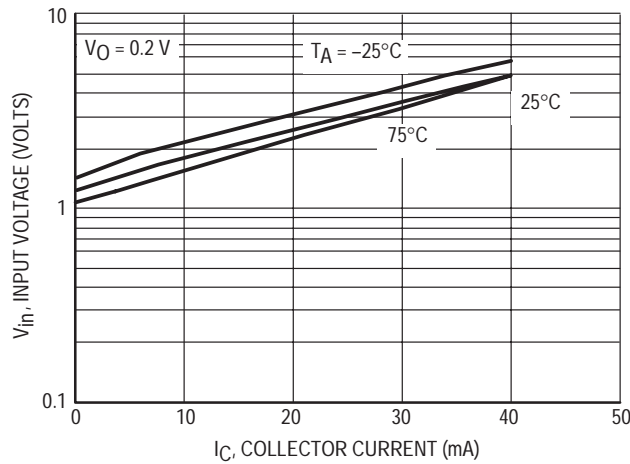


Figure 6. Input Voltage versus Output Current

TYPICAL ELECTRICAL CHARACTERISTICS — MUN5311DW1T1 PNP TRANSISTOR

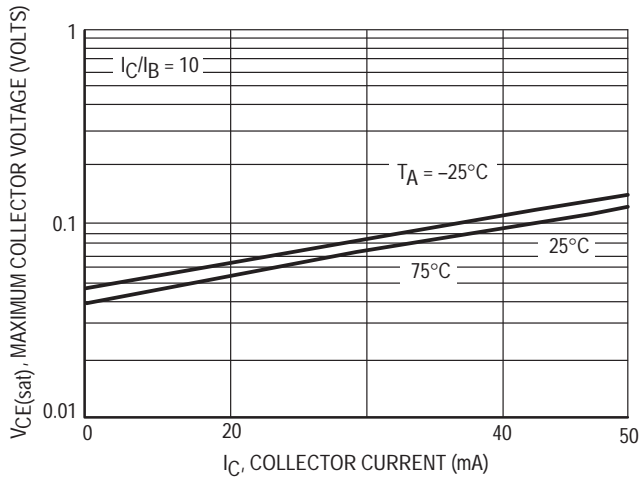


Figure 7. $V_{CE(sat)}$ versus I_C

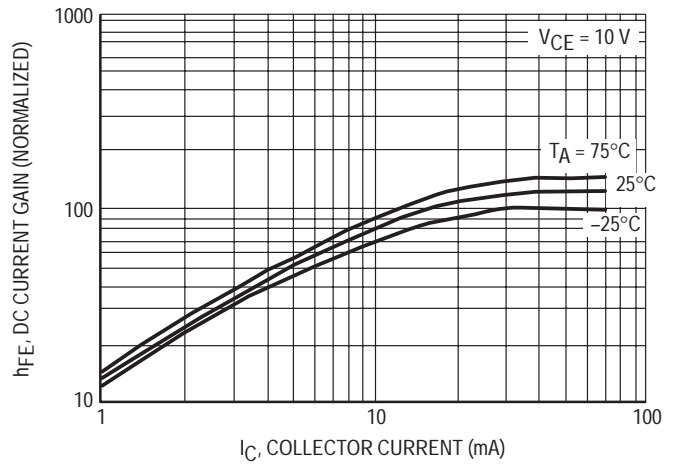


Figure 8. DC Current Gain

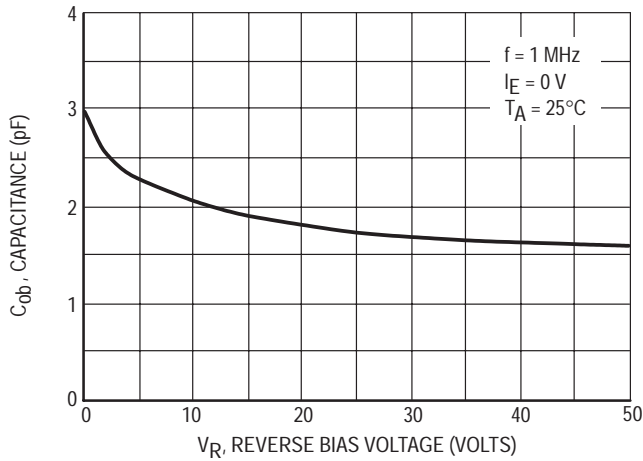


Figure 9. Output Capacitance

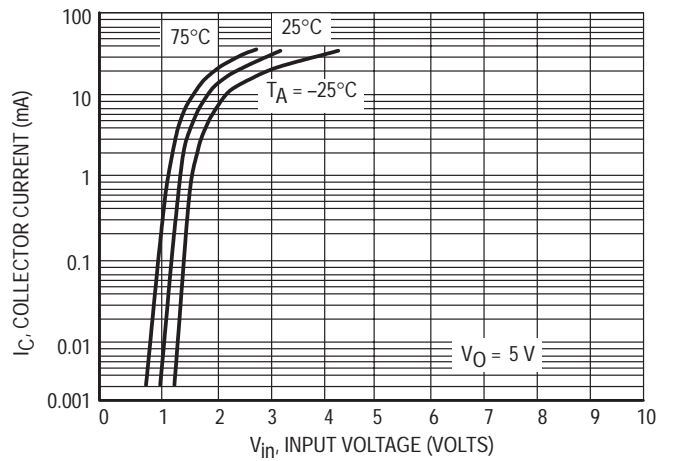


Figure 10. Output Current versus Input Voltage

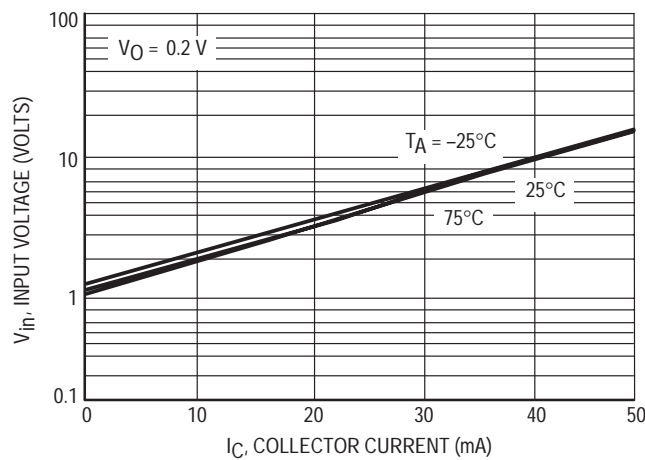


Figure 11. Input Voltage versus Output Current

TYPICAL ELECTRICAL CHARACTERISTICS — MUN5312DW1T1 NPN TRANSISTOR

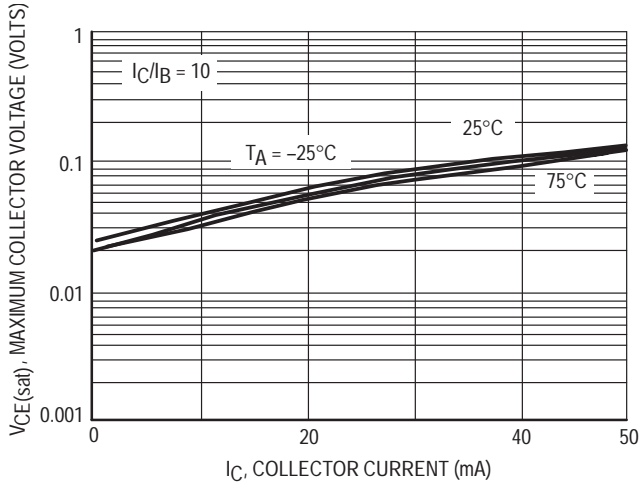


Figure 12. $V_{CE(sat)}$ versus I_C

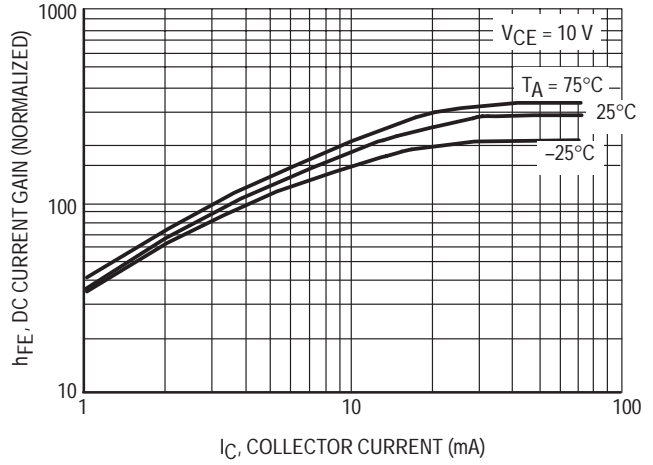


Figure 13. DC Current Gain

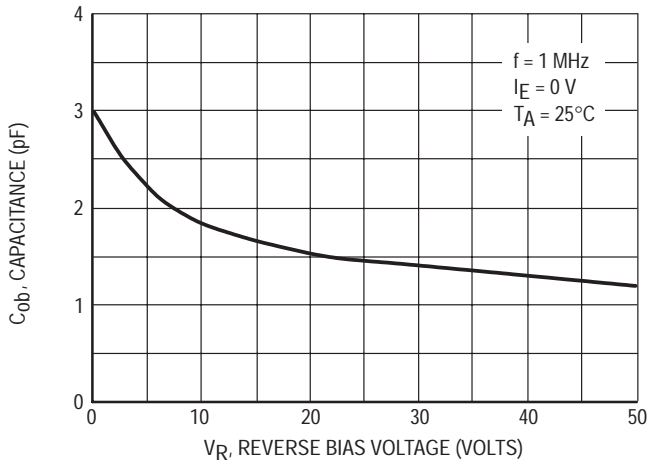


Figure 14. Output Capacitance

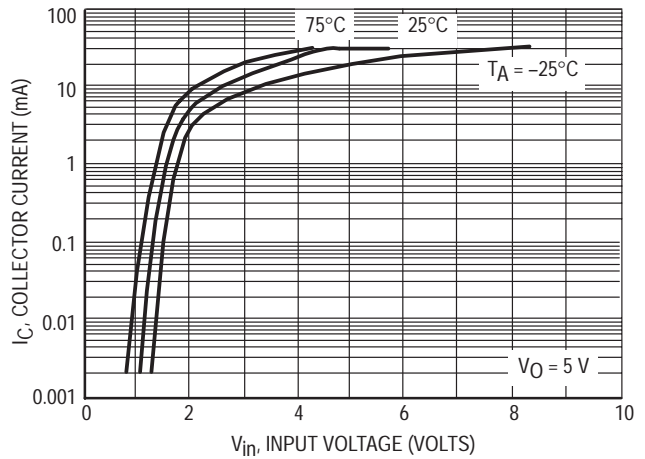


Figure 15. Output Current versus Input Voltage

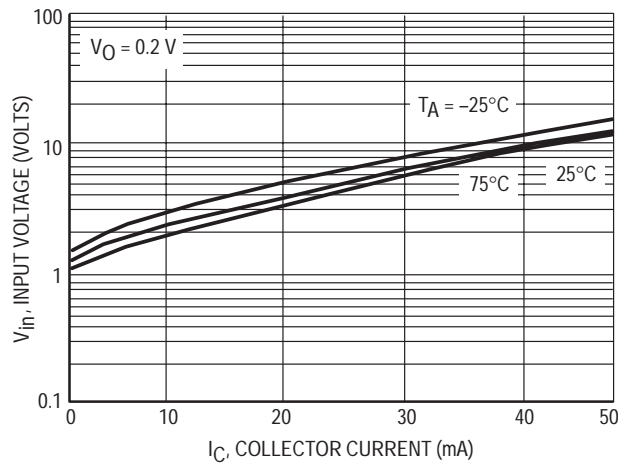


Figure 16. Input Voltage versus Output Current

TYPICAL ELECTRICAL CHARACTERISTICS — MUN5312DW1T1 PNP TRANSISTOR

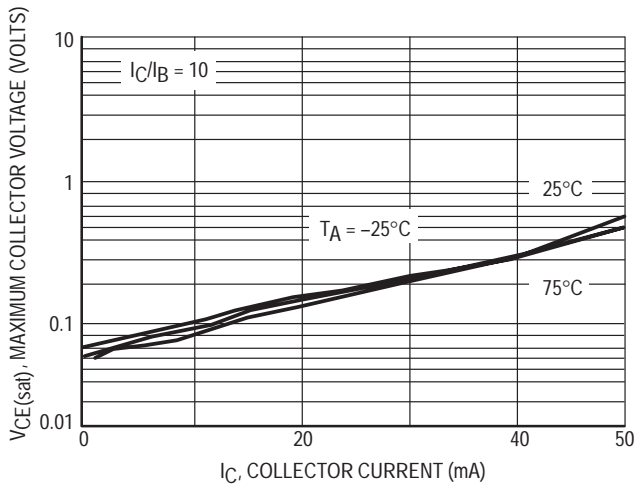


Figure 17. $V_{CE(sat)}$ versus I_C

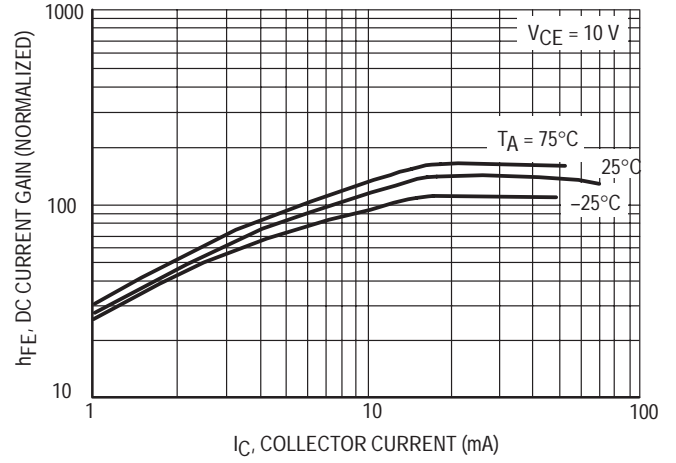


Figure 18. DC Current Gain

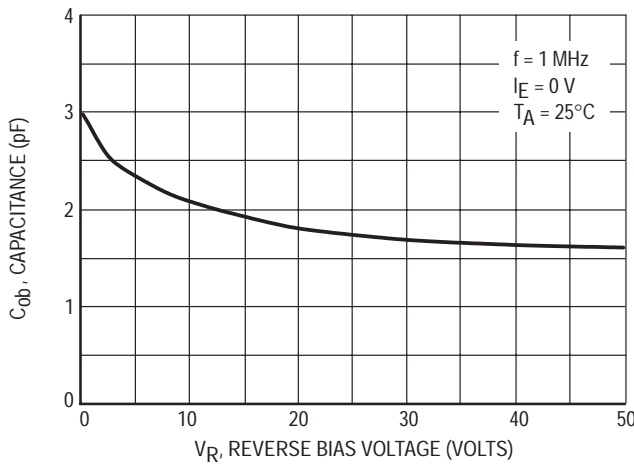


Figure 19. Output Capacitance

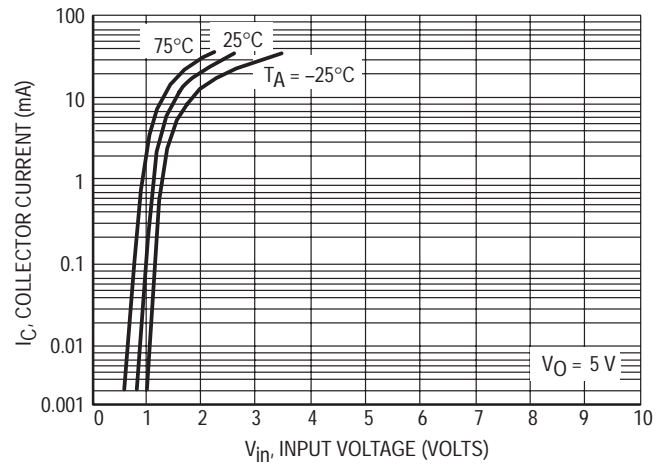


Figure 20. Output Current versus Input Voltage

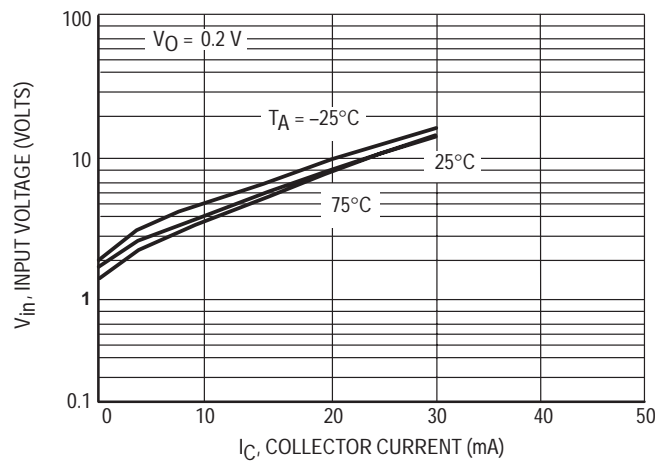


Figure 21. Input Voltage versus Output Current

TYPICAL ELECTRICAL CHARACTERISTICS — MUN5313DW1T1 NPN TRANSISTOR

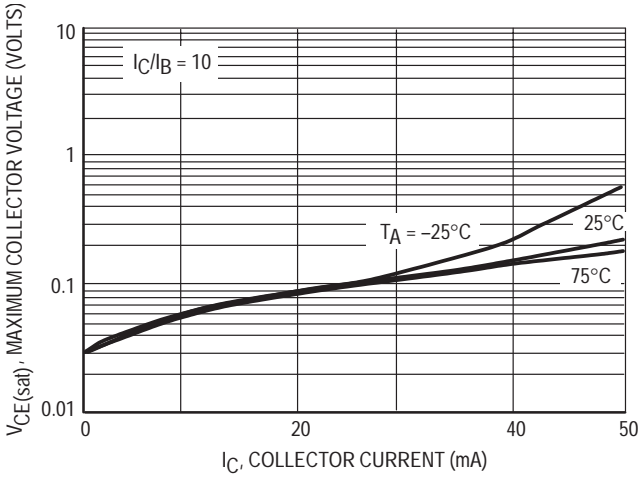


Figure 22. $V_{CE(sat)}$ versus I_C

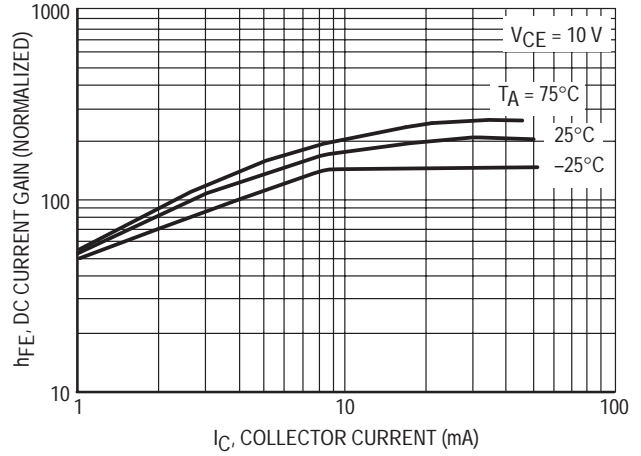


Figure 23. DC Current Gain

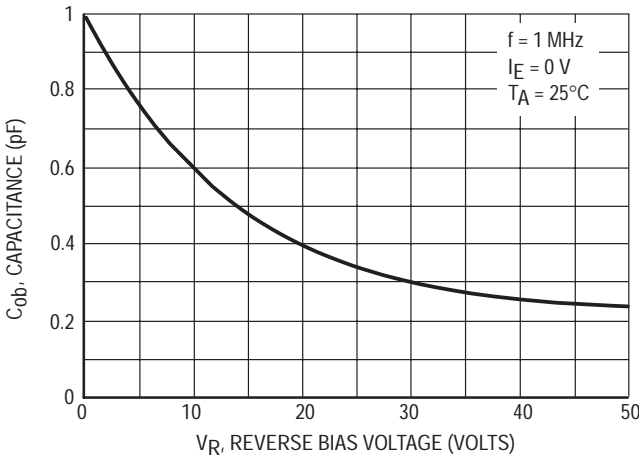


Figure 24. Output Capacitance

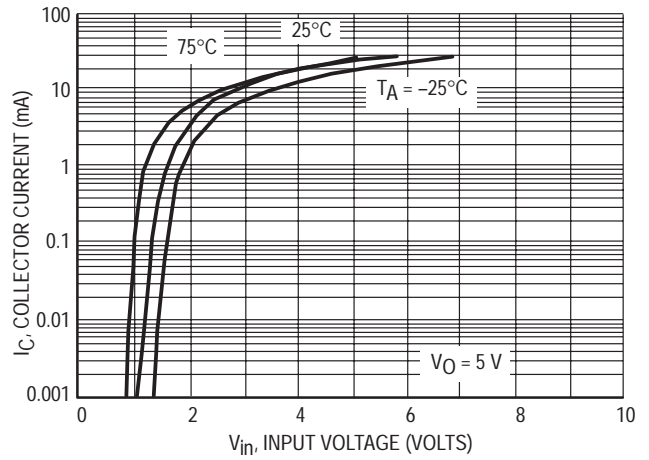


Figure 25. Output Current versus Input Voltage

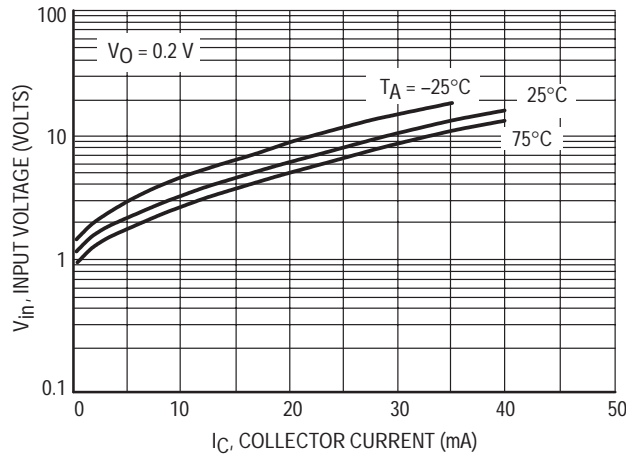


Figure 26. Input Voltage versus Output Current

TYPICAL ELECTRICAL CHARACTERISTICS — MUN5313DW1T1 PNP TRANSISTOR

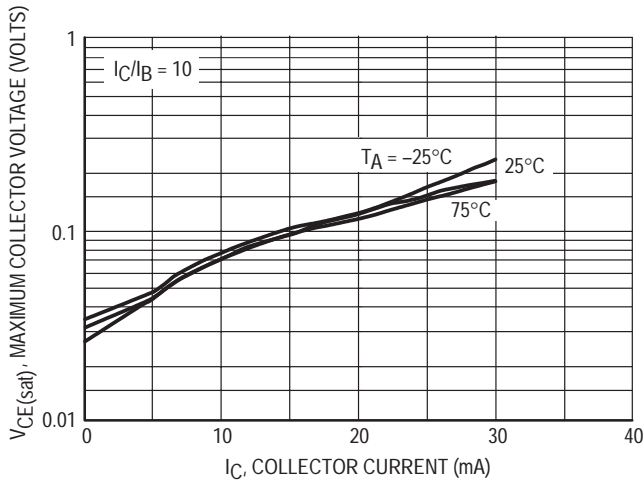


Figure 27. $V_{CE(sat)}$ versus I_C

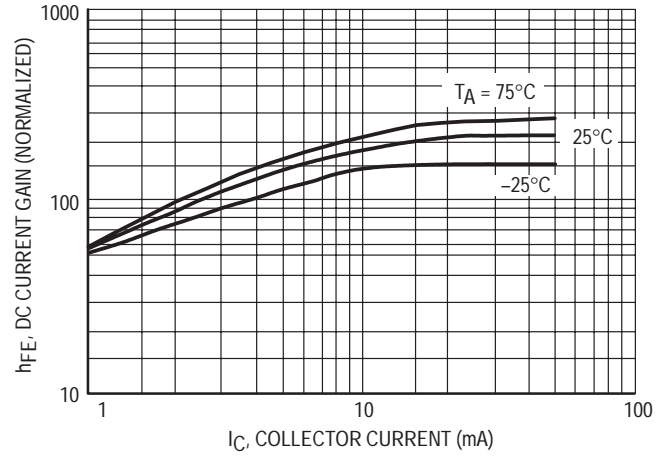


Figure 28. DC Current Gain

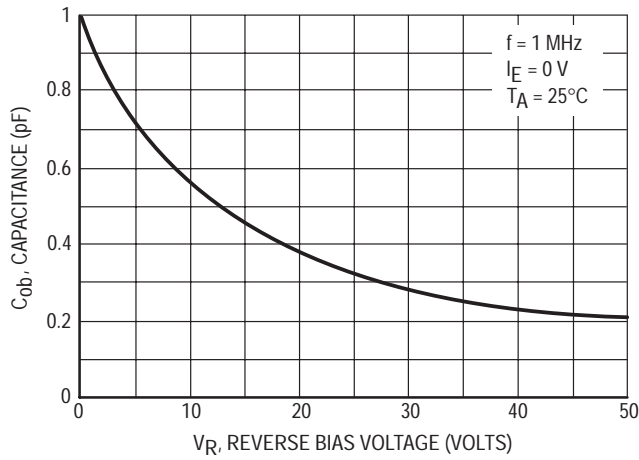


Figure 29. Output Capacitance

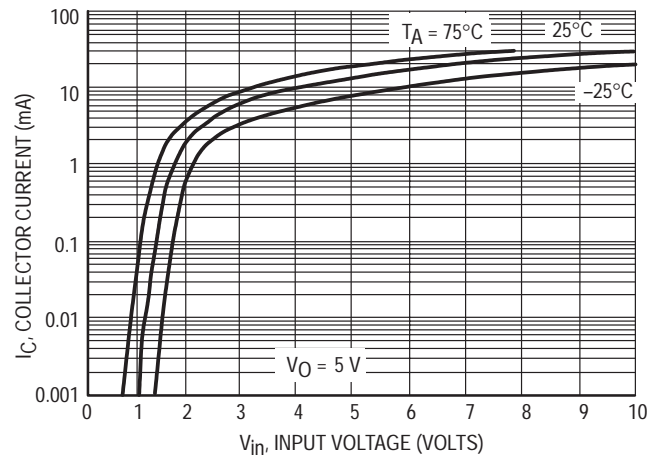


Figure 30. Output Current versus Input Voltage

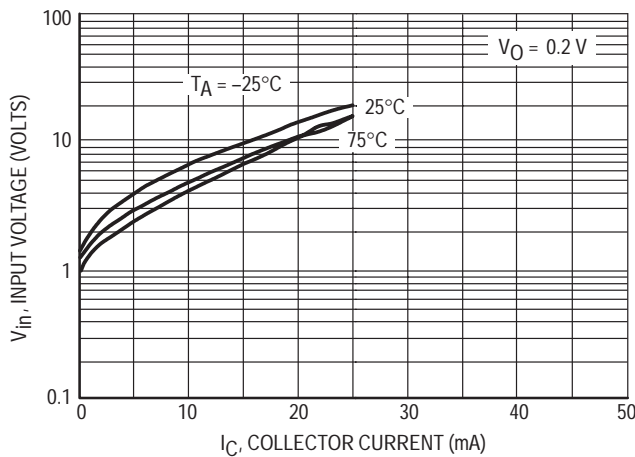


Figure 31. Input Voltage versus Output Current

TYPICAL ELECTRICAL CHARACTERISTICS — MUN5314DW1T1 NPN TRANSISTOR

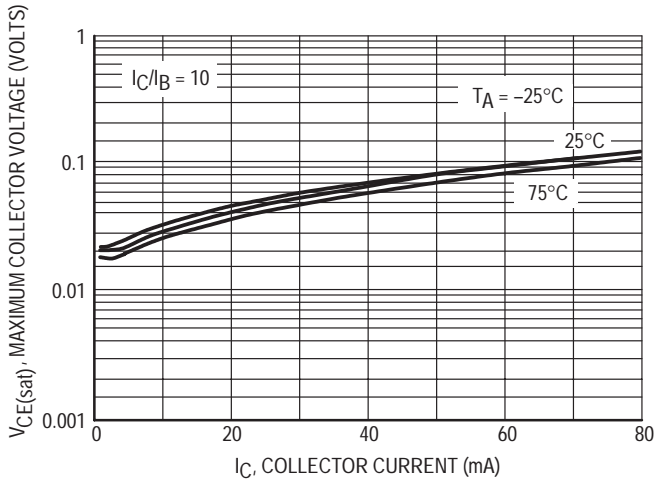


Figure 32. $V_{CE(sat)}$ versus I_C

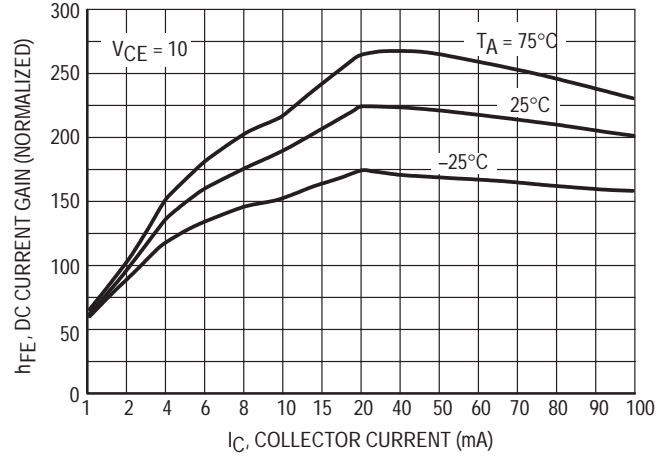


Figure 33. DC Current Gain

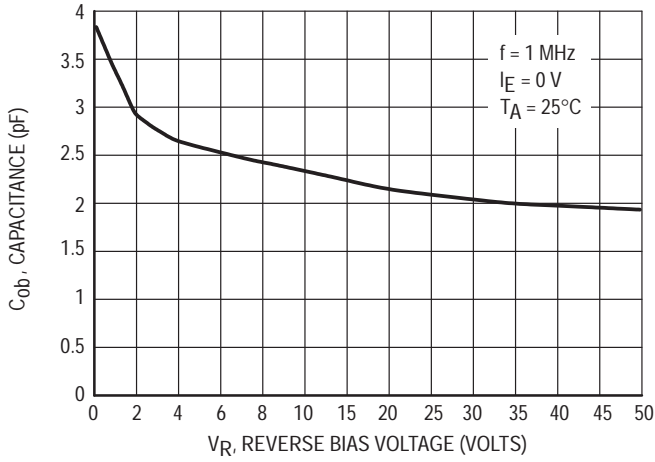


Figure 34. Output Capacitance

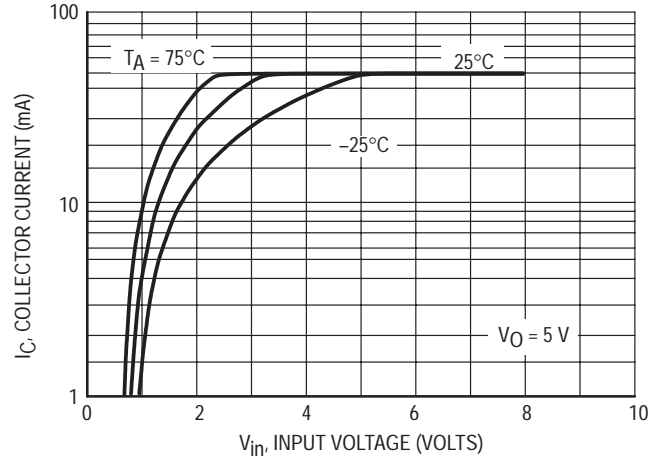


Figure 35. Output Current versus Input Voltage

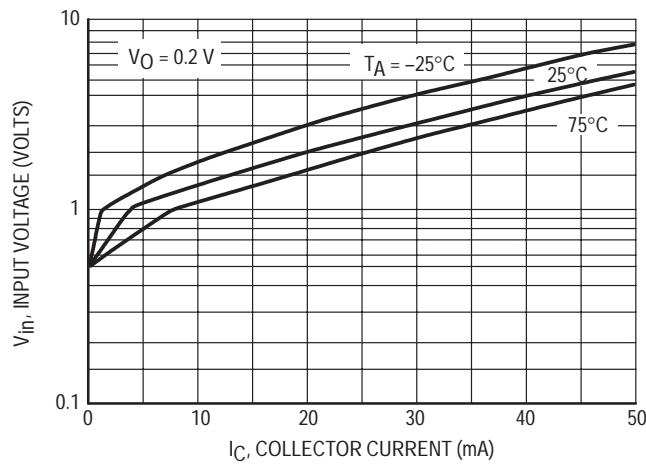


Figure 36. Input Voltage versus Output Current

TYPICAL ELECTRICAL CHARACTERISTICS — MUN5314DW1T1 PNP TRANSISTOR

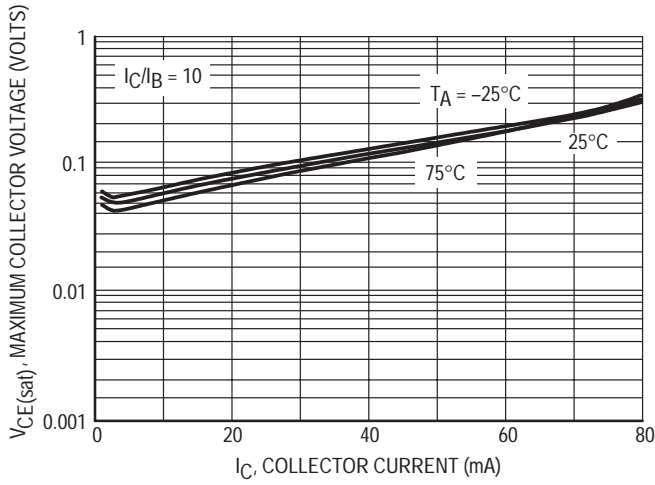


Figure 37. $V_{CE(sat)}$ versus I_C

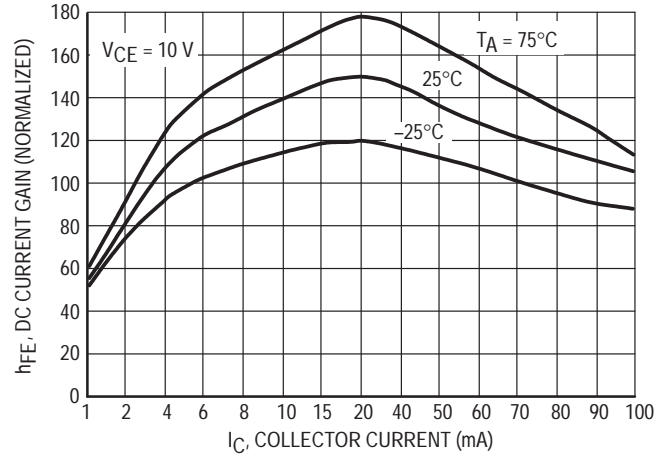


Figure 38. DC Current Gain

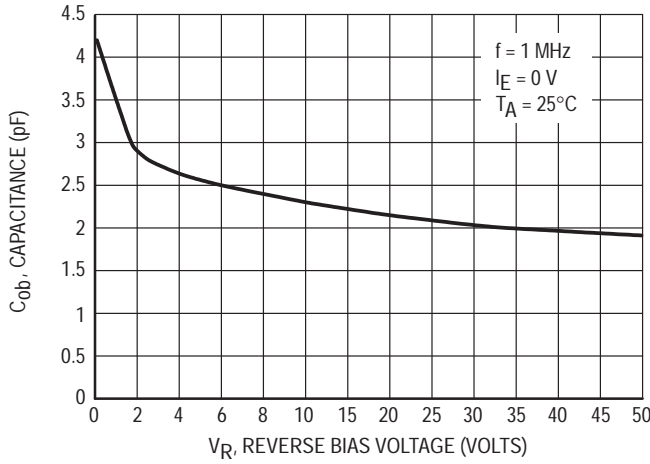


Figure 39. Output Capacitance

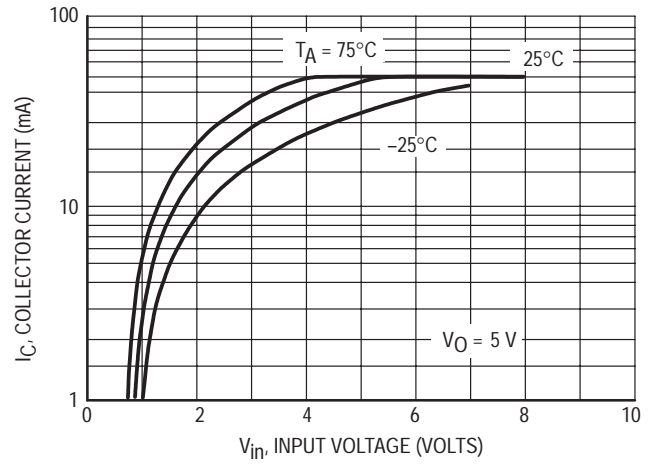


Figure 40. Output Current versus Input Voltage

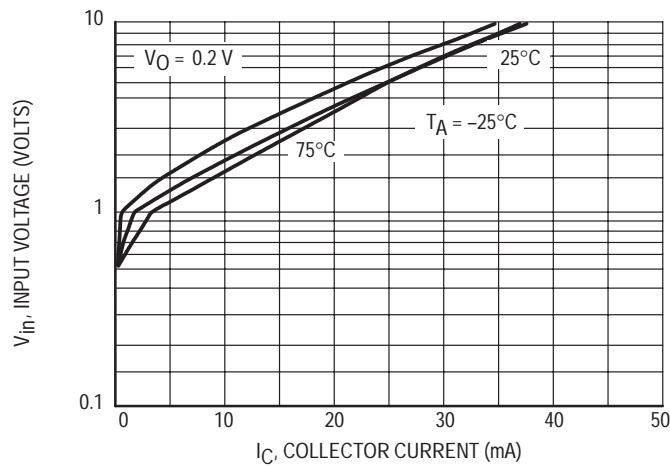


Figure 41. Input Voltage versus Output Current

TYPICAL ELECTRICAL CHARACTERISTICS — MUN5315DW1T1

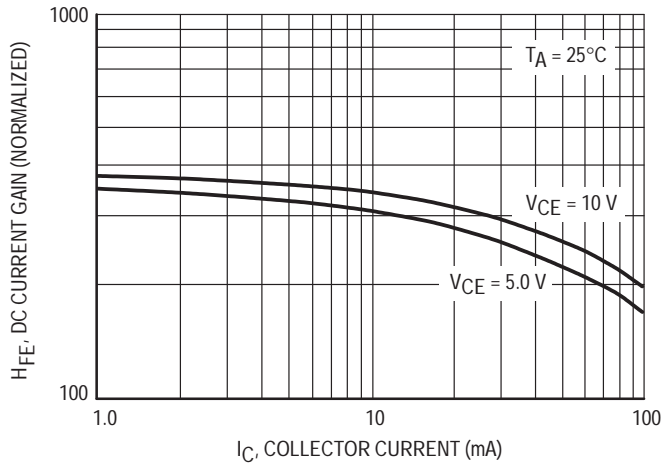


Figure 42. DC Current Gain — PNP

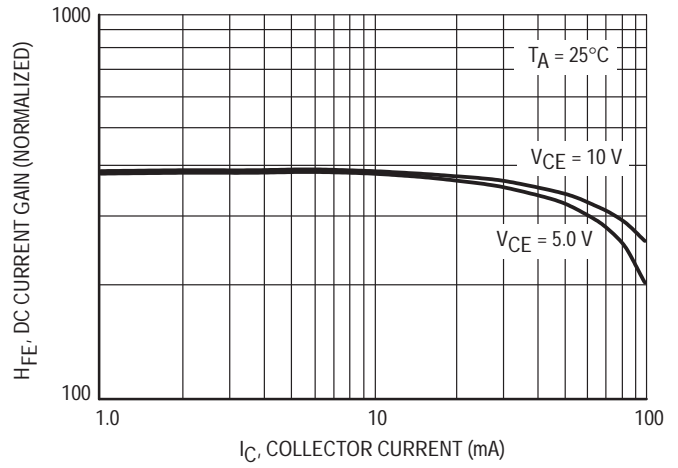


Figure 43. DC Current Gain — NPN

TYPICAL ELECTRICAL CHARACTERISTICS — MUN5316DW1T1

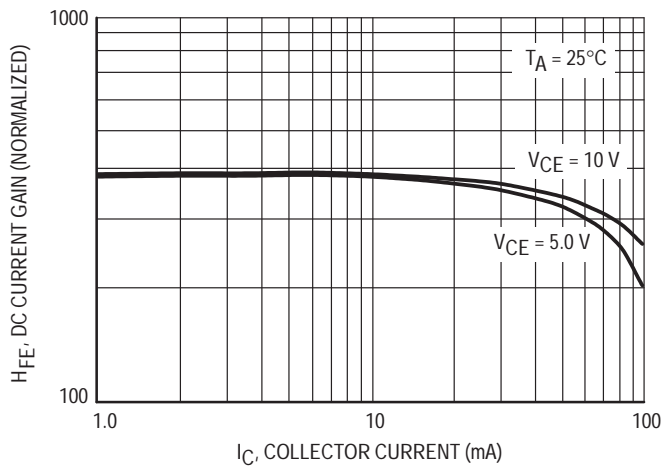


Figure 44. DC Current Gain — PNP

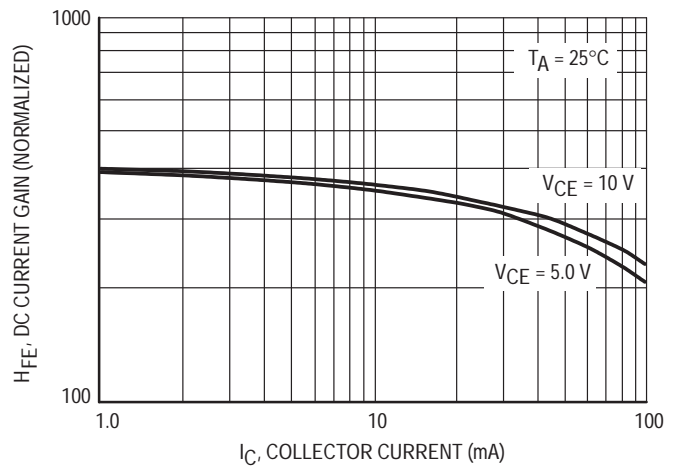
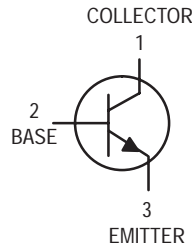


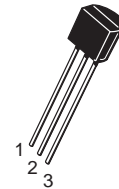
Figure 45. DC Current Gain — NPN

Amplifier Transistors

NPN Silicon



P2N2222A



CASE 29-04, STYLE 17
TO-92 (TO-226AA)

MAXIMUM RATINGS

Rating	Symbol	Value	Unit
Collector–Emitter Voltage	V_{CE0}	40	Vdc
Collector–Base Voltage	V_{CBO}	75	Vdc
Emitter–Base Voltage	V_{EBO}	6.0	Vdc
Collector Current — Continuous	I_C	600	mAdc
Total Device Dissipation @ $T_A = 25^\circ\text{C}$ Derate above 25°C	P_D	625 5.0	mW mW/ $^\circ\text{C}$
Total Device Dissipation @ $T_C = 25^\circ\text{C}$ Derate above 25°C	P_D	1.5 12	Watts mW/ $^\circ\text{C}$
Operating and Storage Junction Temperature Range	T_J, T_{stg}	-55 to +150	$^\circ\text{C}$

THERMAL CHARACTERISTICS

Characteristic	Symbol	Max	Unit
Thermal Resistance, Junction to Ambient	$R_{\theta JA}$	200	$^\circ\text{C}/\text{W}$
Thermal Resistance, Junction to Case	$R_{\theta JC}$	83.3	$^\circ\text{C}/\text{W}$

ELECTRICAL CHARACTERISTICS ($T_A = 25^\circ\text{C}$ unless otherwise noted)

Characteristic	Symbol	Min	Max	Unit
----------------	--------	-----	-----	------

OFF CHARACTERISTICS

Collector–Emitter Breakdown Voltage ($I_C = 10 \text{ mAdc}, I_B = 0$)	$V_{(BR)CEO}$	40	—	Vdc
Collector–Base Breakdown Voltage ($I_C = 10 \text{ }\mu\text{Adc}, I_E = 0$)	$V_{(BR)CBO}$	75	—	Vdc
Emitter–Base Breakdown Voltage ($I_E = 10 \text{ }\mu\text{Adc}, I_C = 0$)	$V_{(BR)EBO}$	6.0	—	Vdc
Collector Cutoff Current ($V_{CE} = 60 \text{ Vdc}, V_{EB(off)} = 3.0 \text{ Vdc}$)	I_{CEX}	—	10	nAdc
Collector Cutoff Current ($V_{CB} = 60 \text{ Vdc}, I_E = 0$) ($V_{CB} = 60 \text{ Vdc}, I_E = 0, T_A = 150^\circ\text{C}$)	I_{CBO}	— —	0.01 10	μAdc
Emitter Cutoff Current ($V_{EB} = 3.0 \text{ Vdc}, I_C = 0$)	I_{EBO}	—	10	nAdc
Collector Cutoff Current ($V_{CE} = 10 \text{ V}$)	I_{CEO}	—	10	nAdc
Base Cutoff Current ($V_{CE} = 60 \text{ Vdc}, V_{EB(off)} = 3.0 \text{ Vdc}$)	I_{BEX}	—	20	nAdc

P2N2222A

ELECTRICAL CHARACTERISTICS ($T_A = 25^\circ\text{C}$ unless otherwise noted) (Continued)

Characteristic	Symbol	Min	Max	Unit
ON CHARACTERISTICS				
DC Current Gain ($I_C = 0.1\text{ mAdc}$, $V_{CE} = 10\text{ Vdc}$) ($I_C = 1.0\text{ mAdc}$, $V_{CE} = 10\text{ Vdc}$) ($I_C = 10\text{ mAdc}$, $V_{CE} = 10\text{ Vdc}$) ($I_C = 10\text{ mAdc}$, $V_{CE} = 10\text{ Vdc}$, $T_A = -55^\circ\text{C}$) ($I_C = 150\text{ mAdc}$, $V_{CE} = 10\text{ Vdc}$) ⁽¹⁾ ($I_C = 150\text{ mAdc}$, $V_{CE} = 1.0\text{ Vdc}$) ⁽¹⁾ ($I_C = 500\text{ mAdc}$, $V_{CE} = 10\text{ Vdc}$) ⁽¹⁾	h_{FE}	35 50 75 35 100 50 40	— — — — 300 — —	—
Collector–Emitter Saturation Voltage ⁽¹⁾ ($I_C = 150\text{ mAdc}$, $I_B = 15\text{ mAdc}$) ($I_C = 500\text{ mAdc}$, $I_B = 50\text{ mAdc}$)	$V_{CE(sat)}$	— —	0.3 1.0	Vdc
Base–Emitter Saturation Voltage ⁽¹⁾ ($I_C = 150\text{ mAdc}$, $I_B = 15\text{ mAdc}$) ($I_C = 500\text{ mAdc}$, $I_B = 50\text{ mAdc}$)	$V_{BE(sat)}$	0.6 —	1.2 2.0	Vdc

SMALL–SIGNAL CHARACTERISTICS

Current–Gain — Bandwidth Product ⁽²⁾ ($I_C = 20\text{ mAdc}$, $V_{CE} = 20\text{ Vdc}$, $f = 100\text{ MHz}$)	f_T	300	—	MHz
Output Capacitance ($V_{CB} = 10\text{ Vdc}$, $I_E = 0$, $f = 1.0\text{ MHz}$)	C_{obo}	—	8.0	pF
Input Capacitance ($V_{EB} = 0.5\text{ Vdc}$, $I_C = 0$, $f = 1.0\text{ MHz}$)	C_{ibo}	—	25	pF
Input Impedance ($I_C = 1.0\text{ mAdc}$, $V_{CE} = 10\text{ Vdc}$, $f = 1.0\text{ kHz}$) ($I_C = 10\text{ mAdc}$, $V_{CE} = 10\text{ Vdc}$, $f = 1.0\text{ kHz}$)	h_{ie}	2.0 0.25	8.0 1.25	k Ω
Voltage Feedback Ratio ($I_C = 1.0\text{ mAdc}$, $V_{CE} = 10\text{ Vdc}$, $f = 1.0\text{ kHz}$) ($I_C = 10\text{ mAdc}$, $V_{CE} = 10\text{ Vdc}$, $f = 1.0\text{ kHz}$)	h_{re}	— —	8.0 4.0	$\times 10^{-4}$
Small–Signal Current Gain ($I_C = 1.0\text{ mAdc}$, $V_{CE} = 10\text{ Vdc}$, $f = 1.0\text{ kHz}$) ($I_C = 10\text{ mAdc}$, $V_{CE} = 10\text{ Vdc}$, $f = 1.0\text{ kHz}$)	h_{fe}	50 75	300 375	—
Output Admittance ($I_C = 1.0\text{ mAdc}$, $V_{CE} = 10\text{ Vdc}$, $f = 1.0\text{ kHz}$) ($I_C = 10\text{ mAdc}$, $V_{CE} = 10\text{ Vdc}$, $f = 1.0\text{ kHz}$)	h_{oe}	5.0 25	35 200	μmhos
Collector Base Time Constant ($I_E = 20\text{ mAdc}$, $V_{CB} = 20\text{ Vdc}$, $f = 31.8\text{ MHz}$)	$r_b'C_c$	—	150	ps
Noise Figure ($I_C = 100\text{ }\mu\text{A}$, $V_{CE} = 10\text{ Vdc}$, $R_S = 1.0\text{ k}\Omega$, $f = 1.0\text{ kHz}$)	N_F	—	4.0	dB

SWITCHING CHARACTERISTICS

Delay Time	$(V_{CC} = 30\text{ Vdc}$, $V_{BE(off)} = -2.0\text{ Vdc}$, $I_C = 150\text{ mAdc}$, $I_{B1} = 15\text{ mAdc}$) (Figure 1)	t_d	—	10	ns
Rise Time		t_r	—	25	ns
Storage Time	$(V_{CC} = 30\text{ Vdc}$, $I_C = 150\text{ mAdc}$, $I_{B1} = I_{B2} = 15\text{ mAdc}$) (Figure 2)	t_s	—	225	ns
Fall Time		t_f	—	60	ns

1. Pulse Test: Pulse Width $\leq 300\text{ }\mu\text{s}$, Duty Cycle $\leq 2.0\%$.
2. f_T is defined as the frequency at which $|h_{fe}|$ extrapolates to unity.

SWITCHING TIME EQUIVALENT TEST CIRCUITS

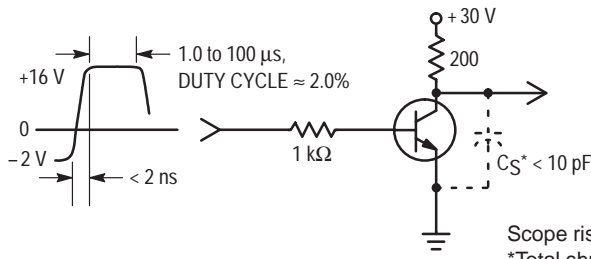


Figure 1. Turn-On Time

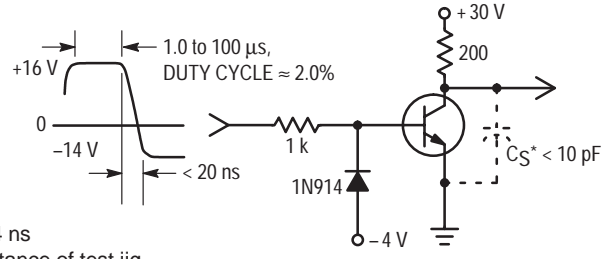


Figure 2. Turn-Off Time

Scope rise time <math>< 4 \text{ ns}</math>
 *Total shunt capacitance of test jig, connectors, and oscilloscope.

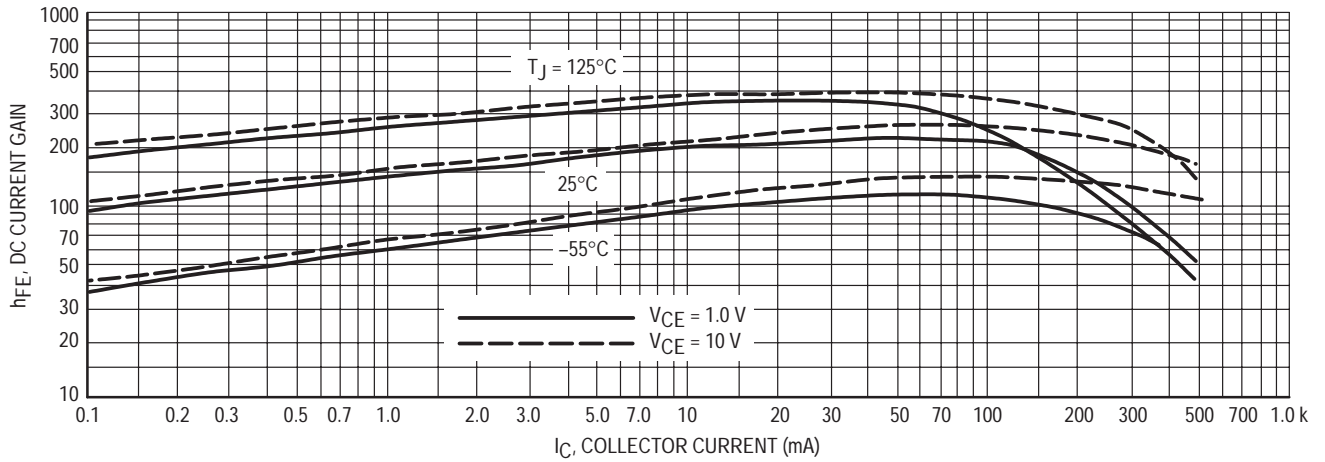


Figure 3. DC Current Gain

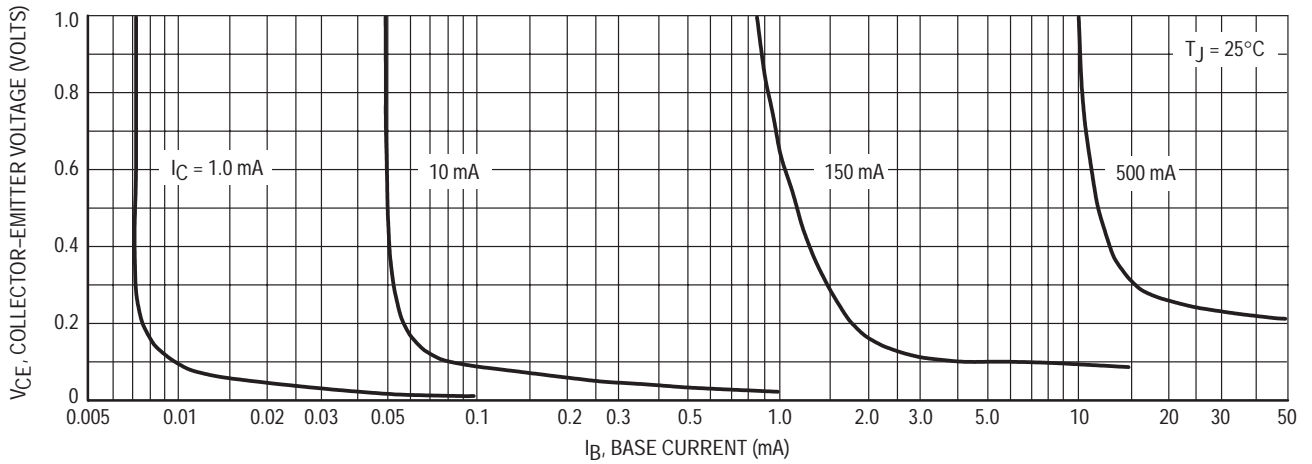


Figure 4. Collector Saturation Region

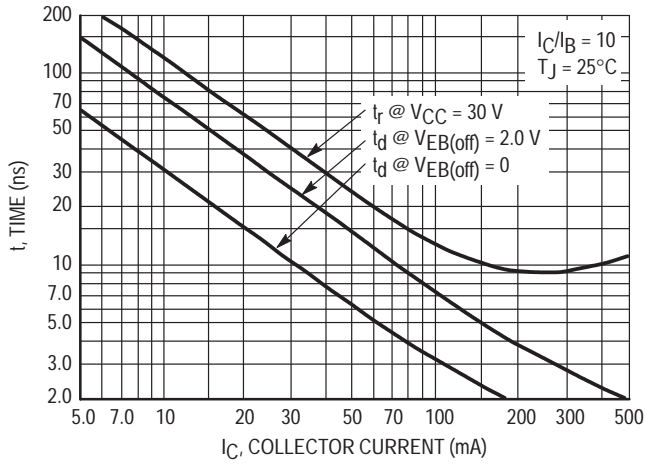


Figure 5. Turn-On Time

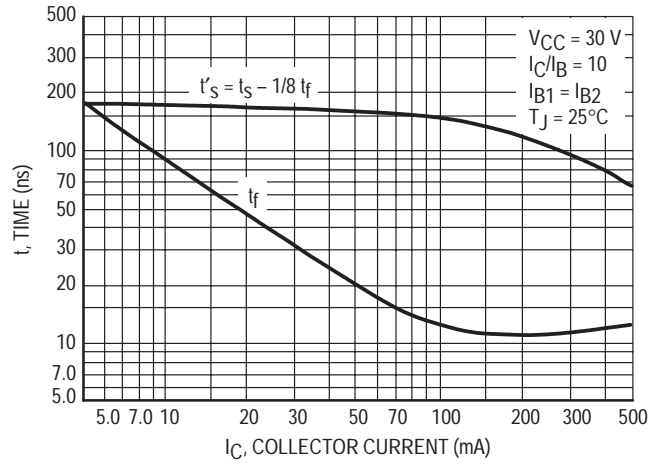


Figure 6. Turn-Off Time

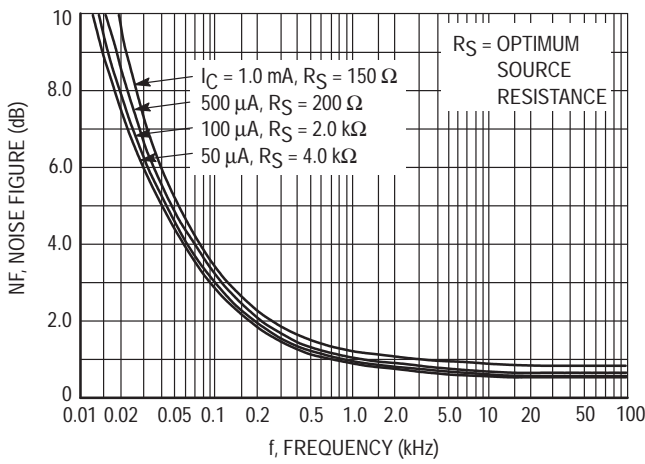


Figure 7. Frequency Effects

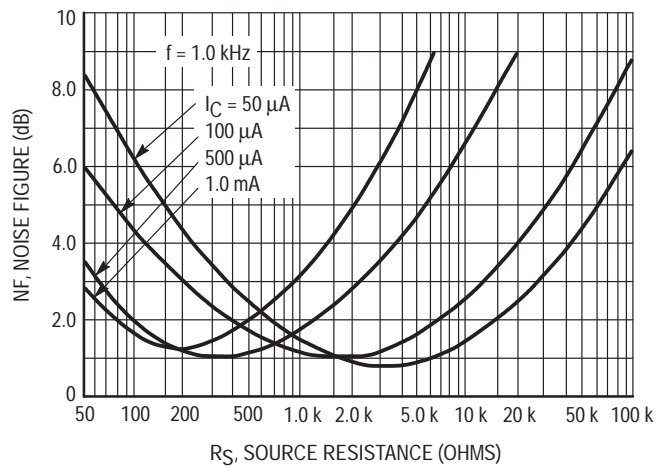


Figure 8. Source Resistance Effects

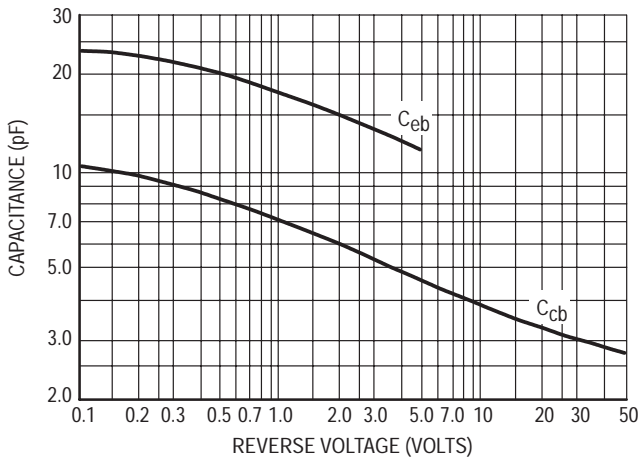


Figure 9. Capacitances

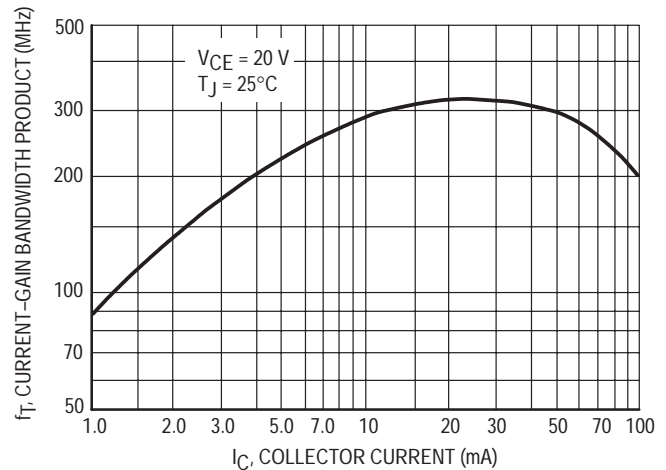


Figure 10. Current-Gain Bandwidth Product

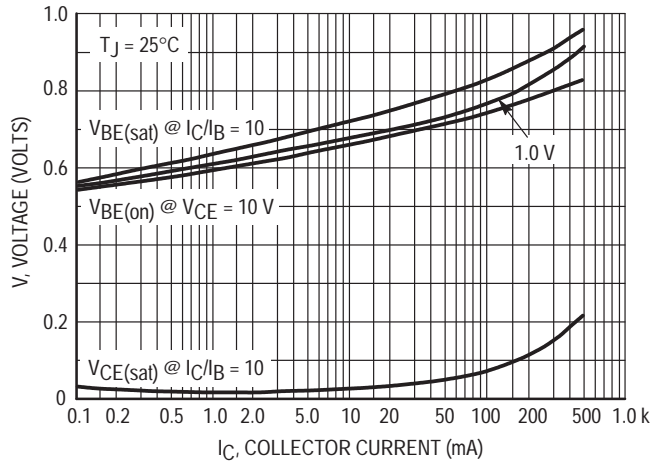


Figure 11. "On" Voltages

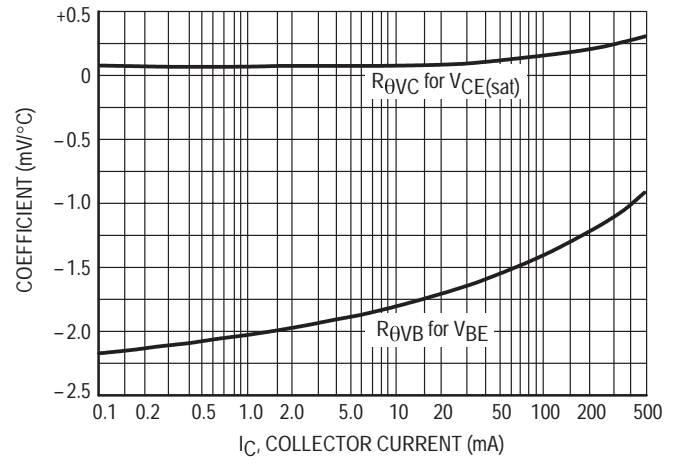
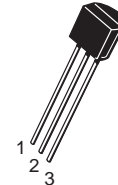
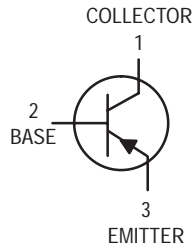


Figure 12. Temperature Coefficients

Amplifier Transistor

PNP Silicon

P2N2907A



CASE 29-04, STYLE 17
TO-92 (TO-226AA)

MAXIMUM RATINGS

Rating	Symbol	Value	Unit
Collector–Emitter Voltage	V_{CEO}	–60	Vdc
Collector–Base Voltage	V_{CBO}	–60	Vdc
Emitter–Base Voltage	V_{EBO}	–5.0	Vdc
Collector Current — Continuous	I_C	–600	mAdc
Total Device Dissipation @ $T_A = 25^\circ\text{C}$ Derate above 25°C	P_D	625 5.0	mW mW/ $^\circ\text{C}$
Total Device Dissipation @ $T_C = 25^\circ\text{C}$ Derate above 25°C	P_D	1.5 12	Watts mW/ $^\circ\text{C}$
Operating and Storage Junction Temperature Range	T_J, T_{stg}	–55 to +150	$^\circ\text{C}$

THERMAL CHARACTERISTICS

Characteristic	Symbol	Max	Unit
Thermal Resistance, Junction to Ambient	$R_{\theta JA}$	200	$^\circ\text{C}/\text{W}$
Thermal Resistance, Junction to Case	$R_{\theta JC}$	83.3	$^\circ\text{C}/\text{W}$

ELECTRICAL CHARACTERISTICS ($T_A = 25^\circ\text{C}$ unless otherwise noted)

Characteristic	Symbol	Min	Max	Unit
----------------	--------	-----	-----	------

OFF CHARACTERISTICS

Collector–Emitter Breakdown Voltage ⁽¹⁾ ($I_C = -10$ mAdc, $I_E = 0$)	$V_{(BR)CEO}$	–60	—	Vdc
Collector–Base Breakdown Voltage ($I_C = -10$ μ Adc, $I_E = 0$)	$V_{(BR)CBO}$	–60	—	Vdc
Emitter–Base Breakdown Voltage ($I_E = -10$ μ Adc, $I_C = 0$)	$V_{(BR)EBO}$	–5.0	—	Vdc
Collector Cutoff Current ($V_{CE} = -30$ Vdc, $V_{EB(off)} = -0.5$ Vdc)	I_{CEX}	—	–50	nAdc
Collector Cutoff Current ($V_{CB} = -50$ Vdc, $I_E = 0$) ($V_{CB} = -50$ Vdc, $I_E = 0$, $T_A = 150^\circ\text{C}$)	I_{CBO}	— —	–0.01 –10	μ Adc
Emitter Cutoff Current ($V_{EB} = -3.0$ Vdc)	I_{EBO}	—	–10	nAdc
Collector Cutoff Current ($V_{CE} = -10$ V)	I_{CEO}	—	–10	nAdc
Base Cutoff Current ($V_{CE} = -30$ Vdc, $V_{EB(off)} = -0.5$ Vdc)	I_{BEX}	—	–50	nAdc

1. Pulse Test: Pulse Width ≤ 300 μ s, Duty Cycle $\leq 2.0\%$.

ELECTRICAL CHARACTERISTICS ($T_A = 25^\circ\text{C}$ unless otherwise noted) (Continued)

Characteristic	Symbol	Min	Max	Unit
ON CHARACTERISTICS				
DC Current Gain ($I_C = -0.1 \text{ mAdc}$, $V_{CE} = -10 \text{ Vdc}$) ($I_C = -1.0 \text{ mAdc}$, $V_{CE} = -10 \text{ Vdc}$) ($I_C = -10 \text{ mAdc}$, $V_{CE} = -10 \text{ Vdc}$) ($I_C = -150 \text{ mAdc}$, $V_{CE} = -10 \text{ Vdc}$) ⁽¹⁾ ($I_C = -500 \text{ mAdc}$, $V_{CE} = -10 \text{ Vdc}$) ⁽¹⁾	h_{FE}	75 100 100 100 50	— — — 300 —	—
Collector–Emitter Saturation Voltage ⁽¹⁾ ($I_C = -150 \text{ mAdc}$, $I_B = -15 \text{ mAdc}$) ($I_C = -500 \text{ mAdc}$, $I_B = -50 \text{ mAdc}$)	$V_{CE(sat)}$	— —	—0.4 —1.6	Vdc
Base–Emitter Saturation Voltage ⁽¹⁾ ($I_C = -150 \text{ mAdc}$, $I_B = -15 \text{ mAdc}$) ($I_C = -500 \text{ mAdc}$, $I_B = -50 \text{ mAdc}$)	$V_{BE(sat)}$	— —	—1.3 —2.6	Vdc

SMALL–SIGNAL CHARACTERISTICS

Current–Gain — Bandwidth Product ^{(1), (2)} ($I_C = -50 \text{ mAdc}$, $V_{CE} = -20 \text{ Vdc}$, $f = 100 \text{ MHz}$)	f_T	200	—	MHz
Output Capacitance ($V_{CB} = -10 \text{ Vdc}$, $I_E = 0$, $f = 1.0 \text{ MHz}$)	C_{obo}	—	8.0	pF
Input Capacitance ($V_{EB} = -2.0 \text{ Vdc}$, $I_C = 0$, $f = 1.0 \text{ MHz}$)	C_{ibo}	—	30	pF

SWITCHING CHARACTERISTICS

Turn–On Time	$(V_{CC} = -30 \text{ Vdc}$, $I_C = -150 \text{ mAdc}$, $I_{B1} = -15 \text{ mAdc}$) (Figures 1 and 5)	t_{on}	—	50	ns
Delay Time		t_d	—	10	ns
Rise Time		t_r	—	40	ns
Turn–Off Time	$(V_{CC} = -6.0 \text{ Vdc}$, $I_C = -150 \text{ mAdc}$, $I_{B1} = I_{B2} = -15 \text{ mAdc}$) (Figure 2)	t_{off}	—	110	ns
Storage Time		t_s	—	80	ns
Fall Time		t_f	—	30	ns

1. Pulse Test: Pulse Width $\leq 300 \mu\text{s}$, Duty Cycle $\leq 2.0\%$.
2. f_T is defined as the frequency at which $|h_{fe}|$ extrapolates to unity.

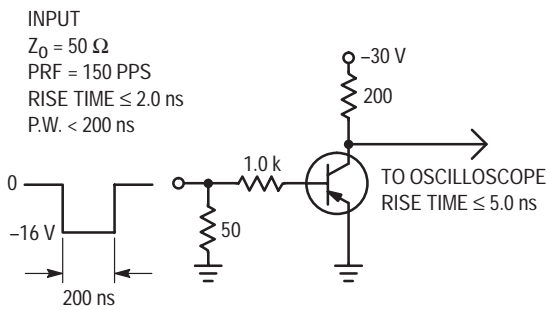


Figure 1. Delay and Rise Time Test Circuit

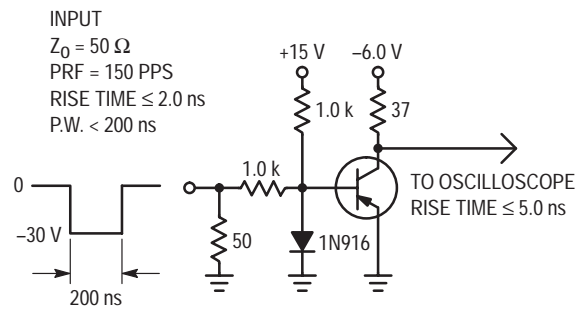


Figure 2. Storage and Fall Time Test Circuit

TYPICAL CHARACTERISTICS

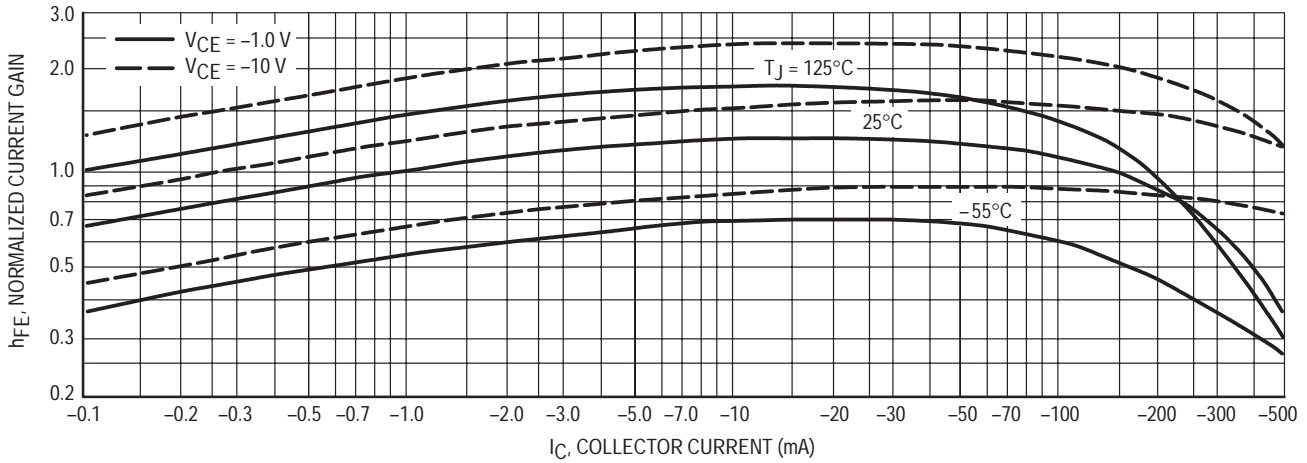


Figure 3. DC Current Gain

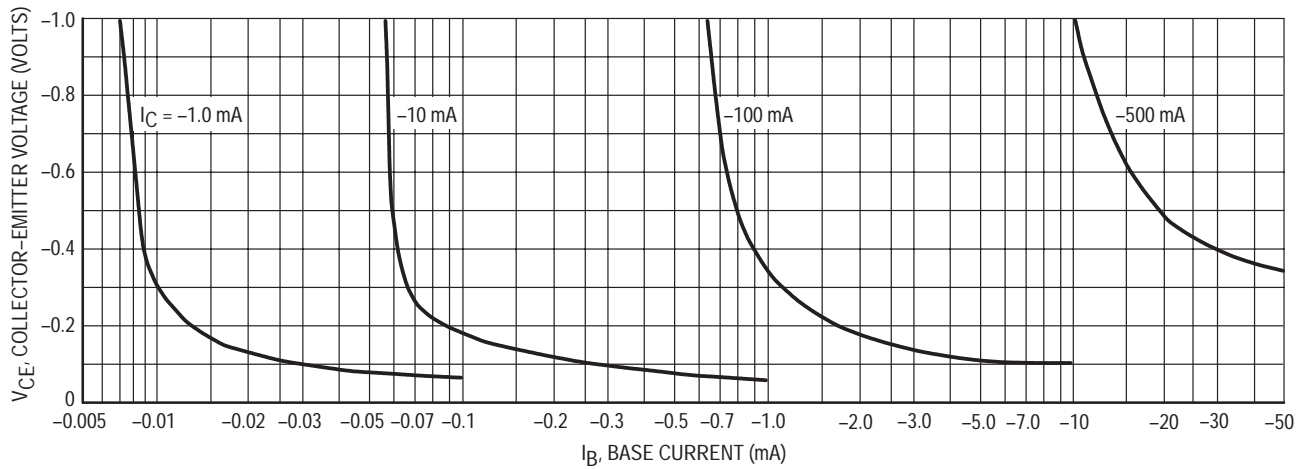


Figure 4. Collector Saturation Region

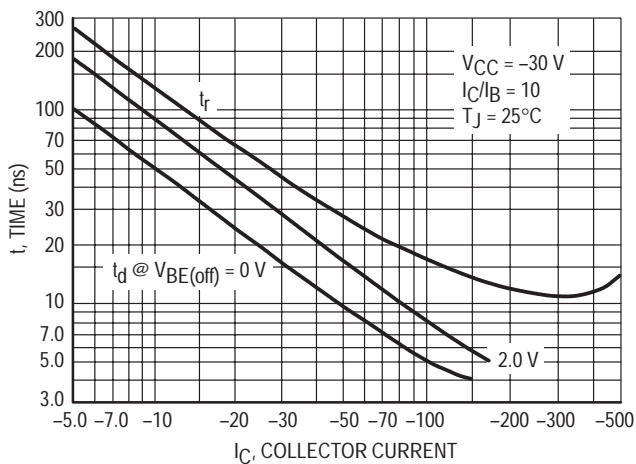


Figure 5. Turn-On Time

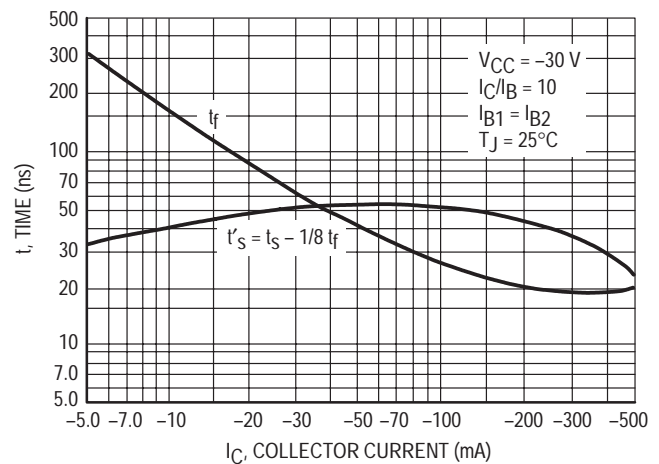


Figure 6. Turn-Off Time

TYPICAL SMALL-SIGNAL CHARACTERISTICS

NOISE FIGURE
 $V_{CE} = 10 \text{ Vdc}$, $T_A = 25^\circ\text{C}$

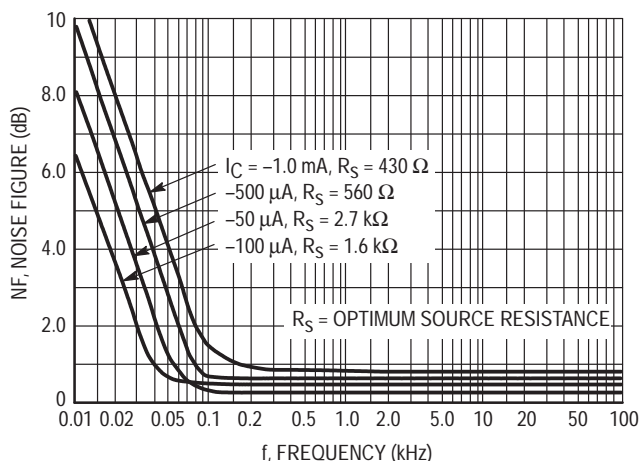


Figure 7. Frequency Effects

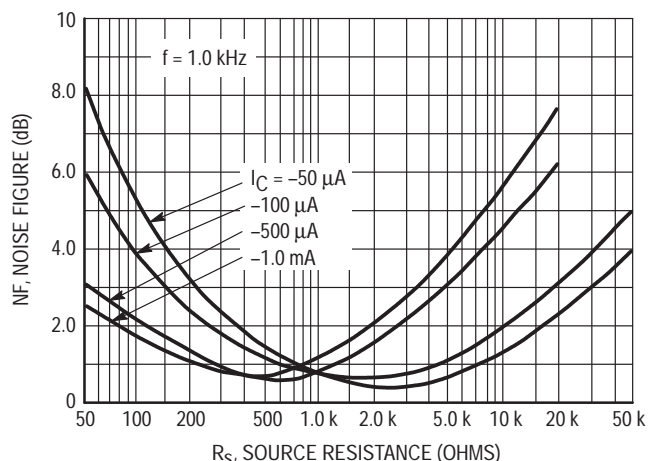


Figure 8. Source Resistance Effects

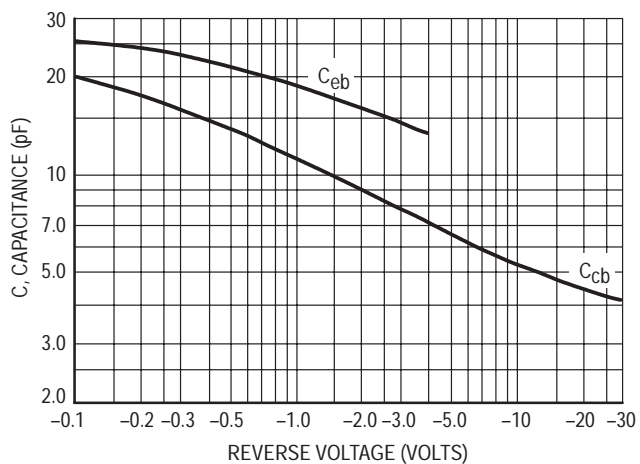


Figure 9. Capacitances

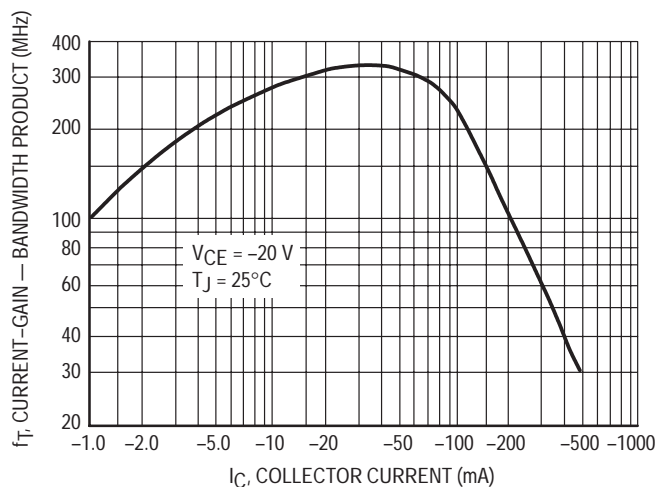


Figure 10. Current-Gain — Bandwidth Product

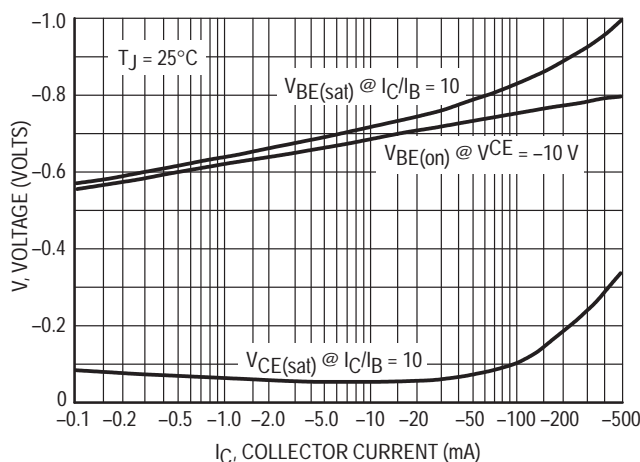


Figure 11. "On" Voltage

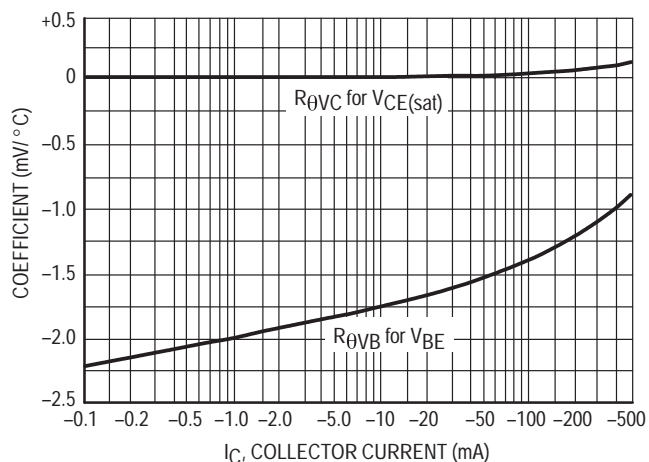
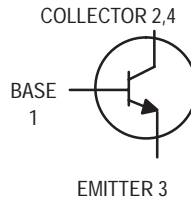


Figure 12. Temperature Coefficients

NPN Silicon Planar Epitaxial Transistor

This NPN Silicon Epitaxial transistor is designed for use in industrial and consumer applications. The device is housed in the SOT-223 package which is designed for medium power surface mount applications.

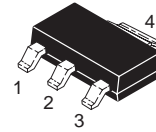
- High Current: 2.0 Amp
- The SOT-223 package can be soldered using wave or reflow.
- SOT-223 package ensures level mounting, resulting in improved thermal conduction, and allows visual inspection of soldered joints. The formed leads absorb thermal stress during soldering, eliminating the possibility of damage to the die.
- Available in 12 mm Tape and Reel
 - Use PZT651T1 to order the 7 inch/1000 unit reel
 - Use PZT651T3 to order the 13 inch/4000 unit reel
- PNP Complement is PZT751T1



PZT651T1

Motorola Preferred Device

**SOT-223 PACKAGE
HIGH CURRENT
NPN SILICON
TRANSISTOR
SURFACE MOUNT**



**CASE 318E-04, STYLE 1
TO-261AA**

MAXIMUM RATINGS ($T_C = 25^\circ\text{C}$ unless otherwise noted)

Rating	Symbol	Value	Unit
Collector-Emitter Voltage	V_{CEO}	60	Vdc
Collector-Base Voltage	V_{CBO}	80	Vdc
Emitter-Base Voltage	V_{EBO}	5.0	Vdc
Collector Current	I_C	2.0	Adc
Total Power Dissipation @ $T_A = 25^\circ\text{C}^{(1)}$ Derate above 25°C	P_D	0.8 6.4	Watts mW/ $^\circ\text{C}$
Storage Temperature Range	T_{stg}	-65 to 150	$^\circ\text{C}$
Junction Temperature	T_J	150	$^\circ\text{C}$

DEVICE MARKING

651

THERMAL CHARACTERISTICS

Characteristic	Symbol	Max	Unit
Thermal Resistance from Junction-to-Ambient in Free Air	$R_{\theta JA}$	156	$^\circ\text{C}/\text{W}$
Maximum Temperature for Soldering Purposes Time in Solder Bath	T_L	260 10	$^\circ\text{C}$ Sec

1. Device mounted on a FR-4 glass epoxy printed circuit board using minimum recommended footprint.

Preferred devices are Motorola recommended choices for future use and best overall value.

ELECTRICAL CHARACTERISTICS ($T_A = 25^\circ\text{C}$ unless otherwise noted)

Characteristics	Symbol	Min	Max	Unit
OFF CHARACTERISTICS				
Collector–Emitter Breakdown Voltage ($I_C = 10\text{ mAdc}$, $I_B = 0$)	$V_{(BR)CEO}$	60	—	Vdc
Collector–Emitter Breakdown Voltage ($I_C = 100\ \mu\text{Adc}$, $I_E = 0$)	$V_{(BR)CBO}$	80	—	Vdc
Emitter–Base Breakdown Voltage ($I_E = 10\ \mu\text{Adc}$, $I_C = 0$)	$V_{(BR)EBO}$	5.0	—	Vdc
Base–Emitter Cutoff Current ($V_{EB} = 4.0\text{ Vdc}$)	I_{EBO}	—	0.1	μAdc
Collector–Base Cutoff Current ($V_{CB} = 80\text{ Vdc}$, $I_E = 0$)	I_{CBO}	—	100	nAdc

ON CHARACTERISTICS (2)

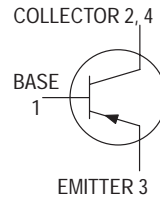
DC Current Gain ($I_C = 50\text{ mAdc}$, $V_{CE} = 2.0\text{ Vdc}$) ($I_C = 500\text{ mAdc}$, $V_{CE} = 2.0\text{ Vdc}$) ($I_C = 1.0\text{ Adc}$, $V_{CE} = 2.0\text{ Vdc}$) ($I_C = 2.0\text{ Adc}$, $V_{CE} = 2.0\text{ Vdc}$)	h_{FE}	75 75 75 40	— — — —	—
Collector–Emitter Saturation Voltages ($I_C = 2.0\text{ Adc}$, $I_B = 200\text{ mAdc}$) ($I_C = 1.0\text{ Adc}$, $I_B = 100\text{ mAdc}$)	$V_{CE(sat)}$	— —	0.5 0.3	Vdc
Base–Emitter Voltages ($I_C = 1.0\text{ Adc}$, $V_{CE} = 2.0\text{ Vdc}$)	$V_{BE(on)}$	—	1.0	Vdc
Base–Emitter Saturation Voltage ($I_C = 1.0\text{ Adc}$, $I_B = 100\text{ mAdc}$)	$V_{BE(sat)}$	—	1.2	Vdc
Current–Gain — Bandwidth ($I_C = 50\text{ mAdc}$, $V_{CE} = 5.0\text{ Vdc}$, $f = 100\text{ MHz}$)	f_T	75	—	MHz

2. Pulse Test: Pulse Width $\leq 300\ \mu\text{s}$, Duty Cycle = 2.0%

PNP Silicon Planar Epitaxial Transistor

This PNP Silicon Epitaxial transistor is designed for use in industrial and consumer applications. The device is housed in the SOT-223 package which is designed for medium power surface mount applications.

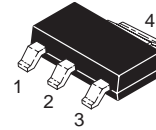
- High Current: 2.0 Amp
- The SOT-223 Package can be soldered using wave or reflow.
- SOT-223 package ensures level mounting, resulting in improved thermal conduction, and allows visual inspection of soldered joints. The formed leads absorb thermal stress during soldering, eliminating the possibility of damage to the die
- Available in 12 mm Tape and Reel
Use PZT751T1 to order the 7 inch/1000 unit reel.
Use PZT751T3 to order the 13 inch/4000 unit reel.
- NPN Complement is PZT651T1



PZT751T1

Motorola Preferred Device

**SOT-223 PACKAGE
HIGH CURRENT
PNP SILICON
TRANSISTOR
SURFACE MOUNT**



**CASE 318E-04, STYLE 1
TO-261AA**

MAXIMUM RATINGS (T_C = 25°C unless otherwise noted)

Rating	Symbol	Value	Unit
Collector-Emitter Voltage	V _{CEO}	60	Vdc
Collector-Base Voltage	V _{CBO}	80	Vdc
Emitter-Base Voltage	V _{EBO}	5.0	Vdc
Collector Current	I _C	2.0	Adc
Total Power Dissipation @ T _A = 25°C ⁽¹⁾ Derate above 25°C	P _D	0.8 6.4	Watts mW/°C
Storage Temperature Range	T _{stg}	-65 to 150	°C
Junction Temperature	T _J	150	°C

DEVICE MARKING

ZT751

THERMAL CHARACTERISTICS

Thermal Resistance from Junction-to-Ambient in Free Air	R _{θJA}	156	°C/W
Maximum Temperature for Soldering Purposes Time in Solder Bath	T _L	260 10	°C Sec

1. Device mounted on a FR-4 glass epoxy printed circuit board using minimum recommended footprint.

Preferred devices are Motorola recommended choices for future use and best overall value.

ELECTRICAL CHARACTERISTICS ($T_A = 25^\circ\text{C}$ unless otherwise noted)

Characteristics	Symbol	Min	Max	Unit
OFF CHARACTERISTICS				
Collector–Emitter Breakdown Voltage ($I_C = 10\text{ mAdc}$, $I_B = 0$)	$V_{(BR)CEO}$	60	—	Vdc
Collector–Emitter Breakdown Voltage ($I_C = 100\text{ }\mu\text{Adc}$, $I_E = 0$)	$V_{(BR)CBO}$	80	—	Vdc
Emitter–Base Breakdown Voltage ($I_E = 10\text{ }\mu\text{Adc}$, $I_C = 0$)	$V_{(BR)EBO}$	5.0	—	Vdc
Base–Emitter Cutoff Current ($V_{EB} = 4.0\text{ Vdc}$)	I_{EBO}	—	0.1	μAdc
Collector–Base Cutoff Current ($V_{CB} = 80\text{ Vdc}$, $I_E = 0$)	I_{CBO}	—	100	nAdc

ON CHARACTERISTICS (2)

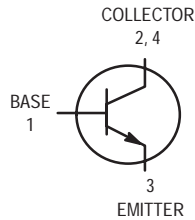
DC Current Gain ($I_C = 50\text{ mAdc}$, $V_{CE} = 2.0\text{ Vdc}$) ($I_C = 500\text{ mAdc}$, $V_{CE} = 2.0\text{ Vdc}$) ($I_C = 1.0\text{ Adc}$, $V_{CE} = 2.0\text{ Vdc}$) ($I_C = 2.0\text{ Adc}$, $V_{CE} = 2.0\text{ Vdc}$)	h_{FE}	75 75 75 40	— — — —	—
Collector–Emitter Saturation Voltages ($I_C = 2.0\text{ Adc}$, $I_B = 200\text{ mAdc}$) ($I_C = 1.0\text{ Adc}$, $I_B = 100\text{ mAdc}$)	$V_{CE(sat)}$	— —	0.5 0.3	Vdc
Base–Emitter Voltages ($I_C = 1.0\text{ Adc}$, $V_{CE} = 2.0\text{ Vdc}$)	$V_{BE(on)}$	—	1.0	Vdc
Base–Emitter Saturation Voltage ($I_C = 1.0\text{ Adc}$, $I_B = 100\text{ mAdc}$)	$V_{BE(sat)}$	—	1.2	Vdc
Current–Gain–Bandwidth ($I_C = 50\text{ mAdc}$, $V_{CE} = 5.0\text{ Vdc}$, $f = 100\text{ MHz}$)	f_T	75	—	MHz

2. Pulse Test: Pulse Width $\leq 300\text{ }\mu\text{s}$, Duty Cycle = 2.0%.

NPN Silicon Planar Epitaxial Transistor

This NPN Silicon Epitaxial transistor is designed for use in linear and switching applications. The device is housed in the SOT-223 package which is designed for medium power surface mount applications.

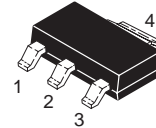
- PNP Complement is PZT2907AT1
- The SOT-223 package can be soldered using wave or reflow.
- SOT-223 package ensures level mounting, resulting in improved thermal conduction, and allows visual inspection of soldered joints. The formed leads absorb thermal stress during soldering, eliminating the possibility of damage to the die.
- Available in 12 mm tape and reel
Use PZT2222AT1 to order the 7 inch/1000 unit reel.
Use PZT2222AT3 to order the 13 inch/4000 unit reel.



PZT2222AT1

Motorola Preferred Device

**SOT-223 PACKAGE
NPN SILICON
TRANSISTOR
SURFACE MOUNT**



**CASE 318E-04, STYLE 1
TO-261AA**

MAXIMUM RATINGS

Rating	Symbol	Value	Unit
Collector-Emitter Voltage	V_{CEO}	40	Vdc
Collector-Base Voltage	V_{CBO}	75	Vdc
Emitter-Base Voltage (Open Collector)	V_{EBO}	6.0	Vdc
Collector Current	I_C	600	mAdc
Total Power Dissipation up to $T_A = 25^\circ\text{C}^{(1)}$	P_D	1.5	Watts
Storage Temperature Range	T_{stg}	- 65 to +150	$^\circ\text{C}$
Junction Temperature	T_J	150	$^\circ\text{C}$

THERMAL CHARACTERISTICS

Thermal Resistance from Junction to Ambient	$R_{\theta JA}$	83.3	$^\circ\text{C/W}$
Lead Temperature for Soldering, 0.0625" from case Time in Solder Bath	T_L	260 10	$^\circ\text{C}$ Sec

DEVICE MARKING

P1F

ELECTRICAL CHARACTERISTICS ($T_A = 25^\circ\text{C}$ unless otherwise noted)

Characteristic	Symbol	Min	Max	Unit
----------------	--------	-----	-----	------

OFF CHARACTERISTICS

Collector-Emitter Breakdown Voltage ($I_C = 10 \text{ mAdc}$, $I_B = 0$)	$V_{(BR)CEO}$	40	—	Vdc
Collector-Base Breakdown Voltage ($I_C = 10 \mu\text{Adc}$, $I_E = 0$)	$V_{(BR)CBO}$	75	—	Vdc
Emitter-Base Breakdown Voltage ($I_E = 10 \mu\text{Adc}$, $I_C = 0$)	$V_{(BR)EBO}$	6.0	—	Vdc
Base-Emitter Cutoff Current ($V_{CE} = 60 \text{ Vdc}$, $V_{BE} = -3.0 \text{ Vdc}$)	I_{BEX}	—	20	nAdc
Collector-Emitter Cutoff Current ($V_{CE} = 60 \text{ Vdc}$, $V_{BE} = -3.0 \text{ Vdc}$)	I_{CEX}	—	10	nAdc
Emitter-Base Cutoff Current ($V_{EB} = 3.0 \text{ Vdc}$, $I_C = 0$)	I_{EBO}	—	100	nAdc

1. Device mounted on an epoxy printed circuit board 1.575 inches x 1.575 inches x 0.059 inches; mounting pad for the collector lead min. 0.93 inches².

Preferred devices are Motorola recommended choices for future use and best overall value.

REV 2

ELECTRICAL CHARACTERISTICS — continued ($T_A = 25^\circ\text{C}$ unless otherwise noted)

Characteristic	Symbol	Min	Max	Unit
OFF CHARACTERISTICS (continued)				
Collector-Base Cutoff Current ($V_{CB} = 60\text{ Vdc}$, $I_E = 0$) ($V_{CB} = 60\text{ Vdc}$, $I_E = 0$, $T_A = 125^\circ\text{C}$)	I_{CBO}	—	10	nAdc μAdc
ON CHARACTERISTICS				
DC Current Gain ($I_C = 0.1\text{ mAdc}$, $V_{CE} = 10\text{ Vdc}$) ($I_C = 1.0\text{ mAdc}$, $V_{CE} = 10\text{ Vdc}$) ($I_C = 10\text{ mAdc}$, $V_{CE} = 10\text{ Vdc}$) ($I_C = 10\text{ mAdc}$, $V_{CE} = 10\text{ Vdc}$, $T_A = -55^\circ\text{C}$) ($I_C = 150\text{ mAdc}$, $V_{CE} = 10\text{ Vdc}$) ($I_C = 150\text{ mAdc}$, $V_{CE} = 1.0\text{ Vdc}$) ($I_C = 500\text{ mAdc}$, $V_{CE} = 10\text{ Vdc}$)	h_{FE}	35 50 70 35 100 50 40	— — — — 300 — —	—
Collector-Emitter Saturation Voltages ($I_C = 150\text{ mAdc}$, $I_B = 15\text{ mAdc}$) ($I_C = 500\text{ mAdc}$, $I_B = 50\text{ mAdc}$)	$V_{CE(sat)}$	— —	0.3 1.0	Vdc
Base-Emitter Saturation Voltages ($I_C = 150\text{ mAdc}$, $I_B = 15\text{ mAdc}$) ($I_C = 500\text{ mAdc}$, $I_B = 50\text{ mAdc}$)	$V_{BE(sat)}$	0.6 —	1.2 2.0	Vdc
Input Impedance ($V_{CE} = 10\text{ Vdc}$, $I_C = 1.0\text{ mAdc}$, $f = 1.0\text{ kHz}$) ($V_{CE} = 10\text{ Vdc}$, $I_C = 10\text{ mAdc}$, $f = 1.0\text{ kHz}$)	h_{ie}	2.0 0.25	8.0 1.25	k Ω
Voltage Feedback Ratio ($V_{CE} = 10\text{ Vdc}$, $I_C = 1.0\text{ mAdc}$, $f = 1.0\text{ kHz}$) ($V_{CE} = 10\text{ Vdc}$, $I_C = 10\text{ mAdc}$, $f = 1.0\text{ kHz}$)	h_{re}	— —	8.0×10^{-4} 4.0×10^{-4}	—
Small-Signal Current Gain ($V_{CE} = 10\text{ Vdc}$, $I_C = 1.0\text{ mAdc}$, $f = 1.0\text{ kHz}$) ($V_{CE} = 10\text{ Vdc}$, $I_C = 10\text{ mAdc}$, $f = 1.0\text{ kHz}$)	$ h_{fe} $	50 75	300 375	—
Output Admittance ($V_{CE} = 10\text{ Vdc}$, $I_C = 1.0\text{ mAdc}$, $f = 1.0\text{ kHz}$) ($V_{CE} = 10\text{ Vdc}$, $I_C = 10\text{ mAdc}$, $f = 1.0\text{ kHz}$)	h_{oe}	5.0 25	35 200	μmhos
Noise Figure ($V_{CE} = 10\text{ Vdc}$, $I_C = 100\text{ }\mu\text{Adc}$, $f = 1.0\text{ kHz}$)	F	—	4.0	dB

DYNAMIC CHARACTERISTICS

Current-Gain — Bandwidth Product ($I_C = 20\text{ mAdc}$, $V_{CE} = 20\text{ Vdc}$, $f = 100\text{ MHz}$)	f_T	300	—	MHz
Output Capacitance ($V_{CB} = 10\text{ Vdc}$, $I_E = 0$, $f = 1.0\text{ MHz}$)	C_c	—	8.0	pF
Input Capacitance ($V_{EB} = 0.5\text{ Vdc}$, $I_C = 0$, $f = 1.0\text{ MHz}$)	C_e	—	25	pF

SWITCHING TIMES ($T_A = 25^\circ\text{C}$)

Delay Time	($V_{CC} = 30\text{ Vdc}$, $I_C = 150\text{ mAdc}$, $I_B(\text{on}) = 15\text{ mAdc}$, $V_{EB(\text{off})} = 0.5\text{ Vdc}$) Figure 1	t_d	—	10	ns
Rise Time		t_r	—	25	
Storage Time	($V_{CC} = 30\text{ Vdc}$, $I_C = 150\text{ mAdc}$, $I_B(\text{on}) = I_B(\text{off}) = 15\text{ mAdc}$) Figure 2	t_s	—	225	ns
Fall Time		t_f	—	60	

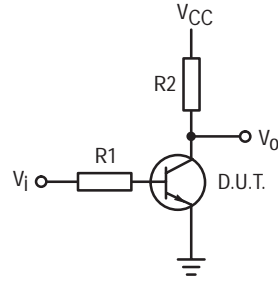
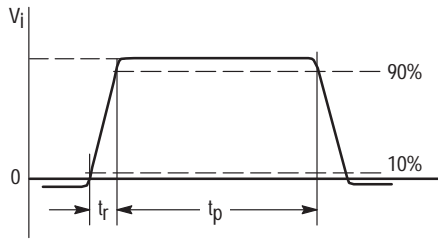


Figure 1. Input Waveform and Test Circuit for Determining Delay Time and Rise Time

$V_i = -0.5 \text{ V to } +9.9 \text{ V}$, $V_{CC} = +30 \text{ V}$, $R_1 = 619 \Omega$, $R_2 = 200 \Omega$.

PULSE GENERATOR:

PULSE DURATION	$t_p \leq 200 \text{ ns}$
RISE TIME	$t_r \leq 2 \text{ ns}$
DUTY FACTOR	$\delta = 0.02$

OSCILLOSCOPE:

INPUT IMPEDANCE	$Z_i > 100 \text{ k}\Omega$
INPUT CAPACITANCE	$C_i < 12 \text{ pF}$
RISE TIME	$t_r < 5 \text{ ns}$

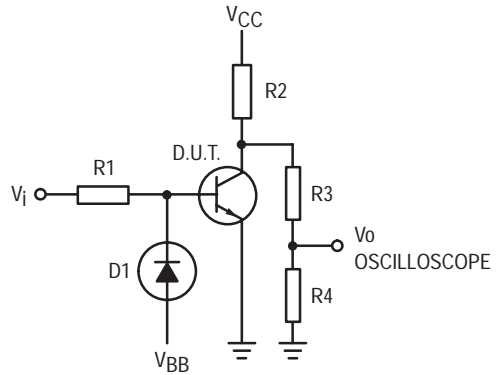
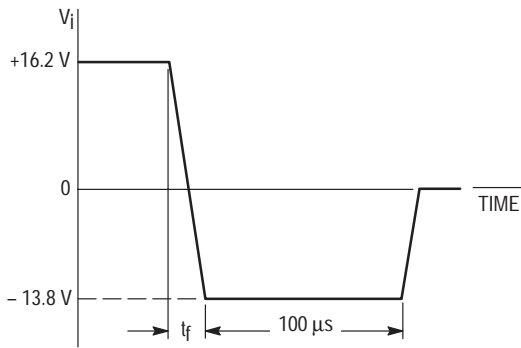
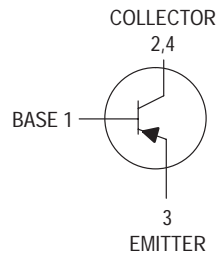


Figure 2. Input Waveform and Test Circuit for Determining Storage Time and Fall Time

PNP Silicon Epitaxial Transistor

This PNP Silicon Epitaxial transistor is designed for use in linear and switching applications. The device is housed in the SOT-223 package which is designed for medium power surface mount applications.

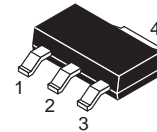
- NPN Complement is PZT2222AT1
- The SOT-223 package can be soldered using wave or reflow
- SOT-223 package ensures level mounting, resulting in improved thermal conduction, and allows visual inspection of soldered joints. The formed leads absorb thermal stress during soldering eliminating the possibility of damage to the die.
- Available in 12 mm tape and reel
Use PZT2907AT1 to order the 7 inch/1000 unit reel.
Use PZT2907AT3 to order the 13 inch/4000 unit reel.



PZT2907AT1

Motorola Preferred Device

**SOT-223 PACKAGE
PNP SILICON
TRANSISTOR
SURFACE MOUNT**



**CASE 318E-04, STYLE 1
TO-261AA**

MAXIMUM RATINGS (T_C = 25°C unless otherwise noted)

Rating	Symbol	Value	Unit
Collector-Emitter Voltage	V _{CEO}	-60	Vdc
Collector-Base Voltage	V _{CB0}	-60	Vdc
Emitter-Base Voltage	V _{EBO}	-5.0	Vdc
Collector Current	I _C	-600	mAdc
Total Power Dissipation @ T _A = 25°C(1) Derate above 25°C	P _D	1.5 12	Watts mW/°C
Operating and Storage Temperature Range	T _J , T _{stg}	-65 to 150	°C

THERMAL CHARACTERISTICS

Thermal Resistance — Junction-to-Ambient (surface mounted)	R _{θJA}	83.3	°C/W
Lead Temperature for Soldering, 0.0625" from case Time in Solder Bath	T _L	260 10	°C Sec

DEVICE MARKING

P2F

ELECTRICAL CHARACTERISTICS (T_A = 25°C unless otherwise noted)

Characteristic	Symbol	Min	Typ	Max	Unit
----------------	--------	-----	-----	-----	------

OFF CHARACTERISTICS

Collector-Base Breakdown Voltage (I _C = -10 μAdc, I _E = 0)	V _{(BR)CBO}	-60	—	—	Vdc
Collector-Emitter Breakdown Voltage (I _C = 10 mAdc, I _B = 0)	V _{(BR)CEO}	-60	—	—	Vdc
Emitter-Base Breakdown Voltage (I _E = -10 μAdc, I _C = 0)	V _{(BR)EBO}	-5.0	—	—	Vdc
Collector-Base Cutoff Current (V _{CB} = -50 Vdc, I _E = 0)	I _{CB0}	—	—	-10	nAdc
Collector-Emitter Cutoff Current (V _{CE} = -30 Vdc, V _{BE} = 0.5 Vdc)	I _{CEX}	—	—	-50	nAdc
Base-Emitter Cutoff Current (V _{CE} = -30 Vdc, V _{BE} = -0.5 Vdc)	I _{BEX}	—	—	-50	nAdc

1. Device mounted on a glass epoxy printed circuit board 1.575 in. x 1.575 in. x 0.059 in.; mounting pad for the collector lead min. 0.93 sq. in.

Preferred devices are Motorola recommended choices for future use and best overall value.

REV 4

PZT2907AT1

ELECTRICAL CHARACTERISTICS ($T_A = 25^\circ\text{C}$ unless otherwise noted) (Continued)

Characteristic	Symbol	Min	Typ	Max	Unit
ON CHARACTERISTICS(2)					
DC Current Gain ($I_C = -0.1 \text{ mA dc}$, $V_{CE} = -10 \text{ V dc}$) ($I_C = -1.0 \text{ mA dc}$, $V_{CE} = -10 \text{ V dc}$) ($I_C = -10 \text{ mA dc}$, $V_{CE} = -10 \text{ V dc}$) ($I_C = -150 \text{ mA dc}$, $V_{CE} = -10 \text{ V dc}$) ($I_C = -500 \text{ mA dc}$, $V_{CE} = -10 \text{ V dc}$)	h_{FE}	75 100 100 100 50	— — — — —	— — — 300 —	—
Collector-Emitter Saturation Voltages ($I_C = -150 \text{ mA dc}$, $I_B = -15 \text{ mA dc}$) ($I_C = -500 \text{ mA dc}$, $I_B = -50 \text{ mA dc}$)	$V_{CE(sat)}$	— —	— —	-0.4 -1.6	Vdc
Base-Emitter Saturation Voltages ($I_C = -150 \text{ mA dc}$, $I_B = -15 \text{ mA dc}$) ($I_C = -500 \text{ mA dc}$, $I_B = -50 \text{ mA dc}$)	$V_{BE(sat)}$	— —	— —	-1.3 -2.6	Vdc

DYNAMIC CHARACTERISTICS

Current-Gain — Bandwidth Product ($I_C = -50 \text{ mA dc}$, $V_{CE} = -20 \text{ V dc}$, $f = 100 \text{ MHz}$)	f_T	200	—	—	MHz
Output Capacitance ($V_{CB} = -10 \text{ V dc}$, $I_E = 0$, $f = 1.0 \text{ MHz}$)	C_C	—	—	8.0	pF
Input Capacitance ($V_{EB} = -2.0 \text{ V dc}$, $I_C = 0$, $f = 1.0 \text{ MHz}$)	C_e	—	—	30	pF

SWITCHING TIMES

Turn-On Time	$(V_{CC} = -30 \text{ V dc}$, $I_C = -150 \text{ mA dc}$, $I_{B1} = -15 \text{ mA dc}$)	t_{on}	—	—	45	ns
Delay Time		t_d	—	—	10	
Rise Time		t_r	—	—	40	
Turn-Off Time	$(V_{CC} = -6.0 \text{ V dc}$, $I_C = -150 \text{ mA dc}$, $I_{B1} = I_{B2} = -15 \text{ mA dc}$)	t_{off}	—	—	100	ns
Storage Time		t_s	—	—	80	
Fall Time		t_f	—	—	30	

2. Pulse Test: Pulse Width $\leq 300 \mu\text{s}$, Duty Cycle = 2.0%.

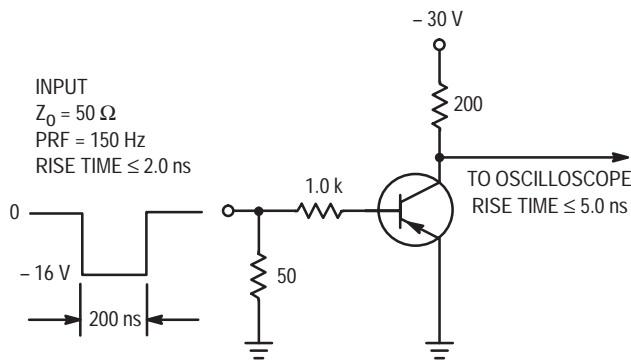


Figure 1. Delay and Rise Time Test Circuit

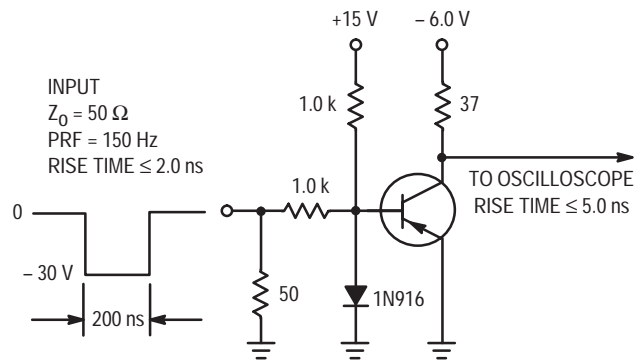


Figure 2. Storage and Fall Time Test Circuit

TYPICAL ELECTRICAL CHARACTERISTICS

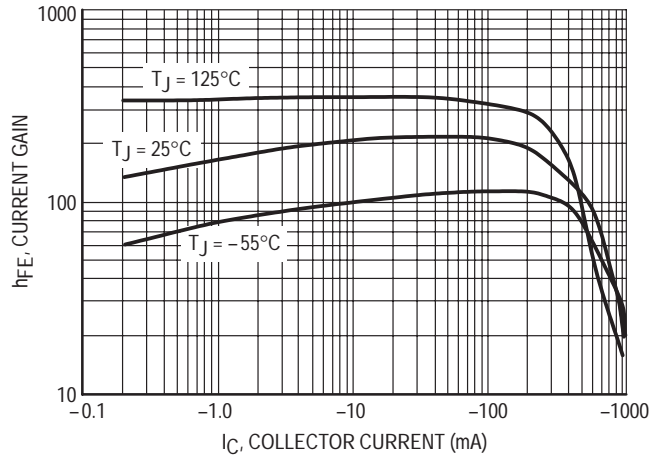


Figure 3. DC Current Gain

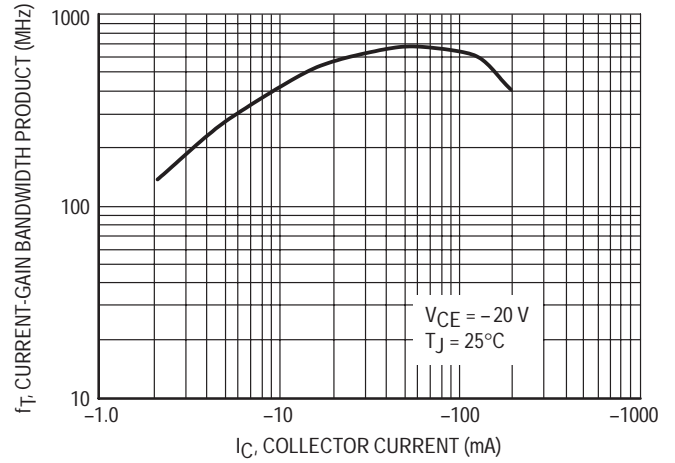


Figure 4. Current Gain Bandwidth Product

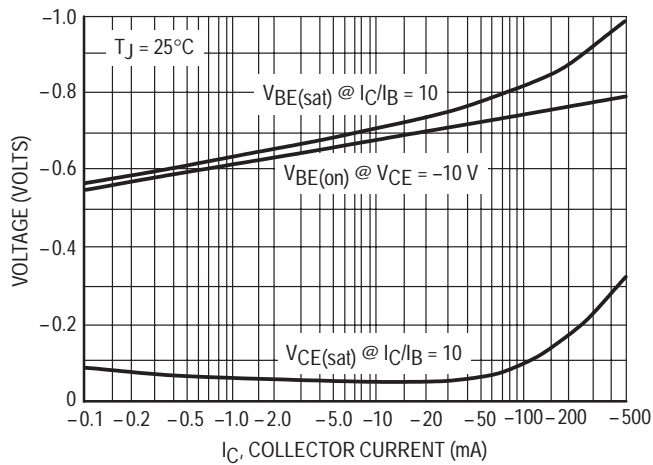


Figure 5. "ON" Voltage

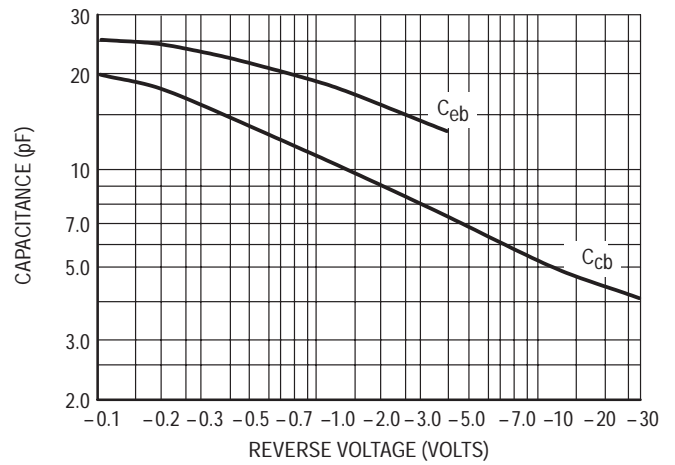
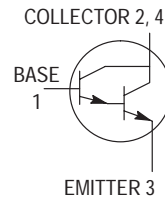


Figure 6. Capacitances

NPN Small-Signal Darlington Transistor

This NPN small signal darlington transistor is designed for use in switching applications, such as print hammer, relay, solenoid and lamp drivers. The device is housed in the SOT-223 package, which is designed for medium power surface mount applications.

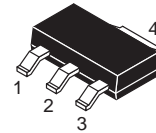
- High f_T : 125 MHz Minimum
- The SOT-223 Package can be soldered using wave or reflow.
- SOT-223 package ensures level mounting, resulting in improved thermal conduction, and allows visual inspection of soldered joints. The formed leads absorb thermal stress during soldering, eliminating the possibility of damage to the die.
- Available in 12 mm Tape and Reel
Use PZTA14T1 to order the 7 inch/1000 unit reel
Use PZTA14T3 to order the 13 inch/4000 unit reel
- The PNP Complement is PZTA64T1



PZTA14T1

Motorola Preferred Device

**SOT-223 PACKAGE
MEDIUM POWER
NPN SILICON
DARLINGTON
TRANSISTOR
SURFACE MOUNT**



**CASE 318E-04, STYLE 1
TO-261AA**

MAXIMUM RATINGS ($T_C = 25^\circ\text{C}$ unless otherwise noted)

Rating	Symbol	Value	Unit
Collector-Emitter Voltage	V_{CES}	30	Vdc
Collector-Emitter Voltage	V_{CEO}	30	Vdc
Emitter-Base Voltage	V_{EBO}	10	Vdc
Collector Current	I_C	300	mAdc
Total Power Dissipation @ $T_A = 25^\circ\text{C}$ (1)	P_D	1.5	Watts
Operating and Storage Temperature Range	T_J, T_{stg}	-65 to 150	$^\circ\text{C}$

DEVICE MARKING

P1N

THERMAL CHARACTERISTICS

Thermal Resistance Junction-to-Ambient (surface mounted)	$R_{\theta JA}$	83.3	$^\circ\text{C/W}$
Maximum Temperature for Soldering Purposes Time in Solder Bath	T_L	260 10	$^\circ\text{C}$ Sec

1. Device mounted on a FR-4 glass epoxy printed circuit board 1.575 in. x 1.575 in. x 0.0625 in.; mounting pad for the collector lead = 0.93 sq. in.

Preferred devices are Motorola recommended choices for future use and best overall value.

ELECTRICAL CHARACTERISTICS ($T_A = 25^\circ\text{C}$ unless otherwise noted)

Characteristics	Symbol	Min	Typ	Max	Unit
OFF CHARACTERISTICS					
Collector-Base Breakdown Voltage ($I_C = 100\ \mu\text{A}$, $I_E = 0$)	$V_{(BR)CBO}$	30	—	—	Vdc
Collector-Emitter Breakdown Voltage ($I_C = 100\ \mu\text{A}$, $I_B = 0$)	$V_{(BR)CES}$	30	—	—	Vdc
Emitter-Base Breakdown Voltage ($I_E = 10\ \mu\text{A}$, $I_C = 0$)	$V_{(BR)EBO}$	10	—	—	Vdc
Collector-Base Cutoff Current ($V_{CB} = 30\ \text{Vdc}$, $I_E = 0$)	I_{CBO}	—	—	0.1	μA
Emitter-Base Cutoff Current ($V_{EB} = 10\ \text{Vdc}$, $I_C = 0$)	I_{EBO}	—	—	0.1	μA
ON CHARACTERISTICS (2)					
DC Current Gain ($I_C = 10\ \text{mA}$, $V_{CE} = 5.0\ \text{Vdc}$) ($I_C = 100\ \text{mA}$, $V_{CE} = 5.0\ \text{Vdc}$)	h_{FE}	10,000 20,000	— —	— —	—
Collector-Emitter Saturation Voltage ($I_C = 100\ \text{mA}$, $I_B = 0.1\ \text{mA}$)	$V_{CE(sat)}$	—	—	1.5	Vdc
Base-Emitter On Voltage ($I_C = 100\ \text{mA}$, $V_{CE} = 5.0\ \text{Vdc}$)	$V_{BE(on)}$	—	—	2.0	Vdc
DYNAMIC CHARACTERISTICS					
Current-Gain — Bandwidth Product ($I_C = 10\ \text{mA}$, $V_{CE} = 5.0\ \text{Vdc}$)	f_T	125	—	—	MHz

2. Pulse Test: Pulse Width $\leq 300\ \mu\text{s}$, Duty Cycle $\leq 2.0\%$.

TYPICAL ELECTRICAL CHARACTERISTICS

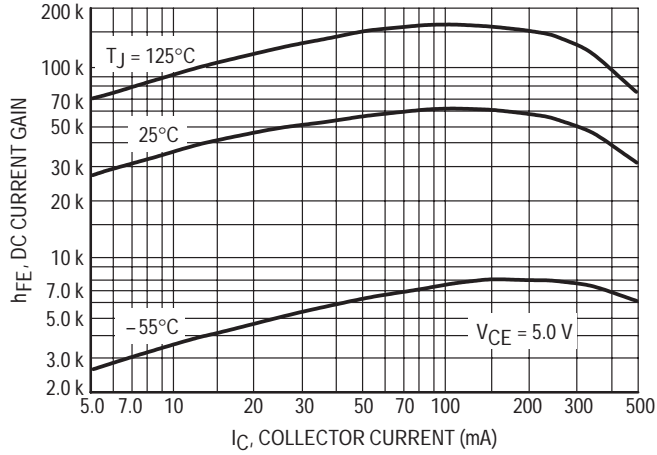


Figure 1. DC Current Gain

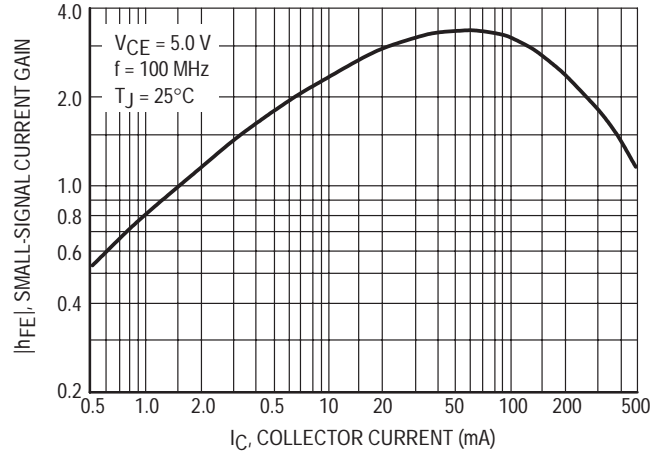


Figure 2. High Frequency Current Gain

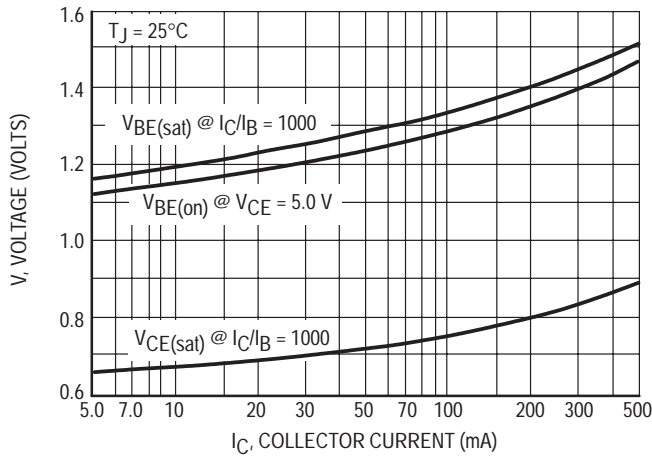


Figure 3. "On" Voltages

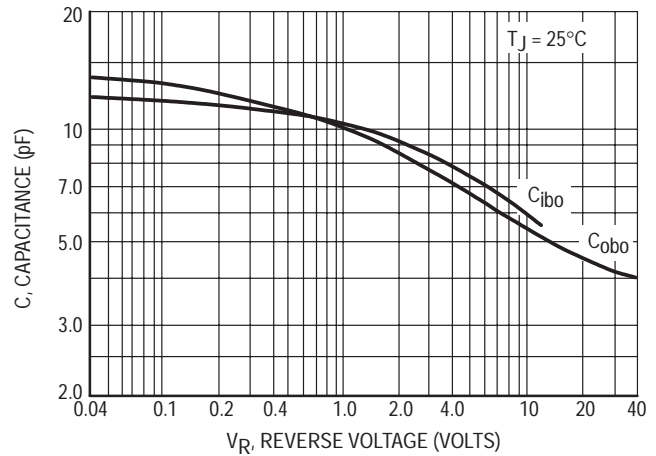


Figure 4. Capacitance

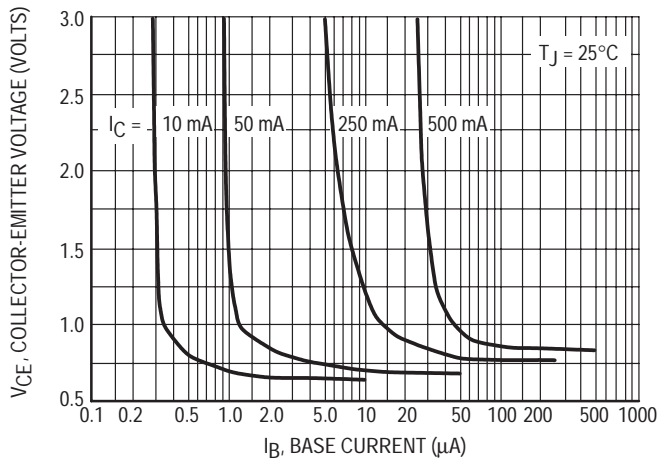


Figure 5. Collector Saturation Region

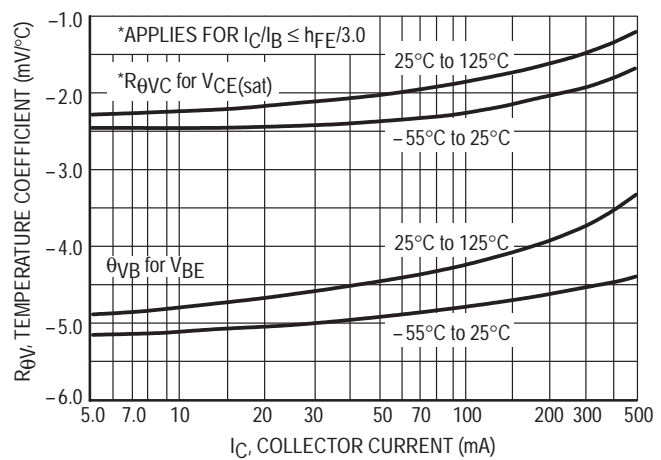
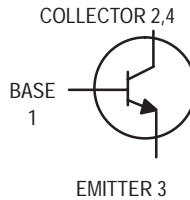


Figure 6. Temperature Coefficients

High Voltage Transistor

Surface Mount

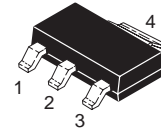
NPN Silicon



PZTA42T1

Motorola Preferred Device

SOT-223 PACKAGE
NPN SILICON
HIGH VOLTAGE
TRANSISTOR
SURFACE MOUNT



CASE 318E-04, STYLE 1
TO-261AA

MAXIMUM RATINGS

Rating	Symbol	Value	Unit
Collector-Emitter Voltage (Open Base)	V_{CEO}	300	Vdc
Collector-Base Voltage (Open Emitter)	V_{CBO}	300	Vdc
Emitter-Base Voltage (Open Collector)	V_{EBO}	6.0	Vdc
Collector Current (DC)	I_C	500	mAdc
Total Power Dissipation @ $T_A = 25^\circ\text{C}^{(1)}$	P_D	1.5	Watts
Storage Temperature Range	T_{stg}	-65 to +150	$^\circ\text{C}$
Junction Temperature	T_J	150	$^\circ\text{C}$

DEVICE MARKING

P1D

THERMAL CHARACTERISTICS

Characteristic	Symbol	Max	Unit
Thermal Resistance, Junction-to-Ambient ⁽¹⁾	$R_{\theta JA}$	83.3	$^\circ\text{C}/\text{W}$

ELECTRICAL CHARACTERISTICS ($T_A = 25^\circ\text{C}$ unless otherwise noted)

Characteristics	Symbol	Min	Max	Unit
-----------------	--------	-----	-----	------

OFF CHARACTERISTICS

Collector-Emitter Breakdown Voltage ⁽²⁾ ($I_C = 1.0 \text{ mAdc}$, $I_E = 0$)	$V_{(BR)CEO}$	300	—	Vdc
Collector-Base Breakdown Voltage ($I_C = 100 \mu\text{Adc}$, $I_E = 0$)	$V_{(BR)CBO}$	300	—	Vdc
Emitter-Base Breakdown Voltage ($I_E = 100 \mu\text{Adc}$, $I_C = 0$)	$V_{(BR)EBO}$	6.0	—	Vdc
Collector-Base Cutoff Current ($V_{CB} = 200 \text{ Vdc}$, $I_E = 0$)	I_{CBO}	—	0.1	μAdc
Emitter-Base Cutoff Current ($V_{BE} = 6.0 \text{ Vdc}$, $I_C = 0$)	I_{EBO}	—	0.1	μAdc

1. Device mounted on a glass epoxy printed circuit board 1.575 in. x 1.575 in. x 0.059 in.; mounting pad for the collector lead min 0.93 in².

2. Pulse Test Conditions, $t_p = 300 \mu\text{s}$, $\delta = 0.02$.

Preferred devices are Motorola recommended choices for future use and best overall value.

PZTA42T1**ELECTRICAL CHARACTERISTICS** ($T_A = 25^\circ\text{C}$ unless otherwise noted) (Continued)**ON CHARACTERISTICS**

DC Current Gain ($I_C = 1.0 \text{ mA}$, $V_{CE} = 10 \text{ Vdc}$) ($I_C = 10 \text{ mA}$, $V_{CE} = 10 \text{ Vdc}$) ($I_C = 30 \text{ mA}$, $V_{CE} = 10 \text{ Vdc}$)	h_{FE}	25 40 40	— — —	—
---------------------------------------------------------------------------------------------------------------------------------------------------------------------------------------------	----------	----------------	-------------	---

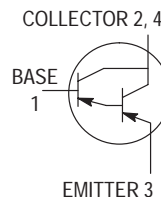
DYNAMIC CHARACTERISTICS

Current-Gain — Bandwidth Product ($I_C = 10 \text{ mA}$, $V_{CE} = 20 \text{ Vdc}$, $f = 100 \text{ MHz}$)	f_T	50	—	MHz
Feedback Capacitance ($V_{CB} = 20 \text{ Vdc}$, $I_E = 0$, $f = 1.0 \text{ MHz}$)	C_{re}	—	3.0	pF
Collector-Emitter Saturation Voltage ($I_C = 20 \text{ mA}$, $I_B = 2.0 \text{ mA}$)	$V_{CE(sat)}$	—	0.5	Vdc
Base-Emitter Saturation Voltage ($I_C = 20 \text{ mA}$, $I_B = 2.0 \text{ mA}$)	$V_{BE(sat)}$	—	0.9	Vdc

PNP Small-Signal Darlington Transistor

This PNP small-signal darlington transistor is designed for use in preamplifiers input applications or wherever it is necessary to have a high input impedance. The device is housed in the SOT-223 package which is designed for medium power surface mount applications.

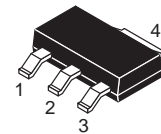
- High f_T : 125 MHz Minimum
- The SOT-223 Package can be soldered using wave or reflow.
- SOT-223 package ensures level mounting, resulting in improved thermal conduction, and allows visual inspection of soldered joints. The formed leads absorb thermal stress during soldering eliminating the possibility of damage to the die.
- Available in 12 mm Tape and Reel
Use PZTA64T1 to order the 7 inch/1000 unit reel.
Use PZTA64T3 to order the 13 inch/4000 unit reel.
- NPN Complement is PZTA14T1



PZTA64T1

Motorola Preferred Device

**SOT-223 PACKAGE
PNP SILICON
DARLINGTON
TRANSISTOR
SURFACE MOUNT**



**CASE 318E-04, STYLE 1
TO-261AA**

MAXIMUM RATINGS (T_C = 25°C unless otherwise noted)

Rating	Symbol	Value	Unit
Collector-Emitter Voltage	V _{CES}	30	Vdc
Collector-Base Voltage	V _{CB0}	30	Vdc
Emitter-Base Voltage	V _{EBO}	10	Vdc
Total Power Dissipation @ T _A = 25°C(1)	P _D	1.5	Watts
Collector Current	I _C	500	mAdc
Operating and Storage Temperature Range	T _J , T _{stg}	-65 to +150	°C

DEVICE MARKING

P2V

THERMAL CHARACTERISTICS

Thermal Resistance from Junction to Ambient (surface mounted)	R _{θJA}	83.3	°C/W
Maximum Temperature for Soldering Purposes Time in Solder Bath	T _L	260 10	°C Sec

1. Device mounted on a FR-4 glass epoxy printed circuit board 1.575 in. x 1.575 in. x 0.0625 in.; mounting pad for the collector lead = 0.93 sq. in.

Preferred devices are Motorola recommended choices for future use and best overall value.

PZTA64T1**ELECTRICAL CHARACTERISTICS** ($T_A = 25^\circ\text{C}$ unless otherwise noted)

Characteristic	Symbol	Min	Max	Unit
----------------	--------	-----	-----	------

OFF CHARACTERISTICS

Collector-Emitter Breakdown Voltage ($I_C = 100\ \mu\text{Adc}$, $V_{BE} = 0$)	$V_{(BR)CES}$	30	—	Vdc
Collector-Base Breakdown Voltage ($I_C = 100\ \mu\text{A}$, $I_E = 0$)	$V_{(BR)CBO}$	30	—	Vdc
Emitter-Base Breakdown Voltage ($I_E = 100\ \mu\text{A}$, $I_C = 0$)	$V_{(BR)EBO}$	10	—	Vdc
Emitter-Base Cutoff Current ($V_{BE} = 10\ \text{Vdc}$, $I_C = 0$)	I_{EBO}	—	0.1	μAdc
Collector-Base Cutoff Current ($V_{CB} = 30\ \text{Vdc}$, $I_E = 0$)	I_{CBO}	—	0.1	μAdc

ON CHARACTERISTICS(2)

DC Current Gain ($I_C = 10\ \text{mAdc}$, $V_{CE} = 5.0\ \text{Vdc}$) ($I_C = 100\ \text{mAdc}$, $V_{CE} = 5.0\ \text{Vdc}$)	h_{FE}	10,000 20,000	— —	—
Collector-Emitter Saturation Voltage ($I_C = 100\ \text{mAdc}$, $I_B = 0.1\ \text{mAdc}$)	$V_{CE(sat)}$	—	1.5	Vdc
Base-Emitter On-Voltage ($V_{CE} = 5.0\ \text{Vdc}$, $I_C = 100\ \text{mAdc}$)	$V_{BE(on)}$	—	2.0	Vdc

DYNAMIC CHARACTERISTICS

Current-Gain — Bandwidth Product ($I_C = 10\ \text{mAdc}$, $V_{CE} = 5.0\ \text{Vdc}$, $f = 100\ \text{MHz}$)	f_T	125	—	MHz
----------------------------------------------------------------------------------------------------------------------	-------	-----	---	-----

2. Pulse Test: Pulse Width $\leq 300\ \mu\text{s}$, Duty Cycle $\leq 2.0\%$.

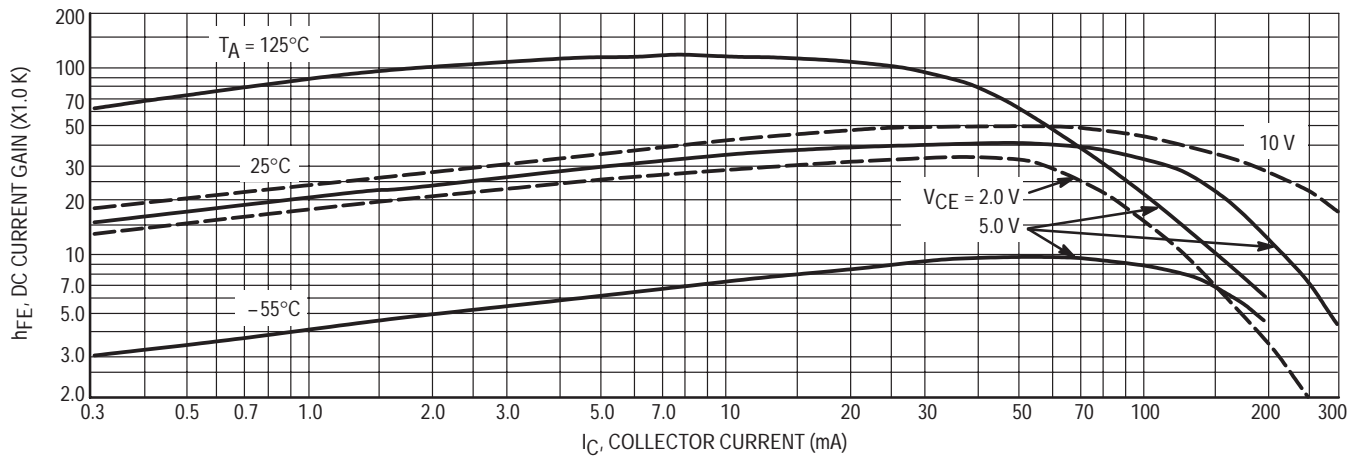


Figure 1. DC Current Gain

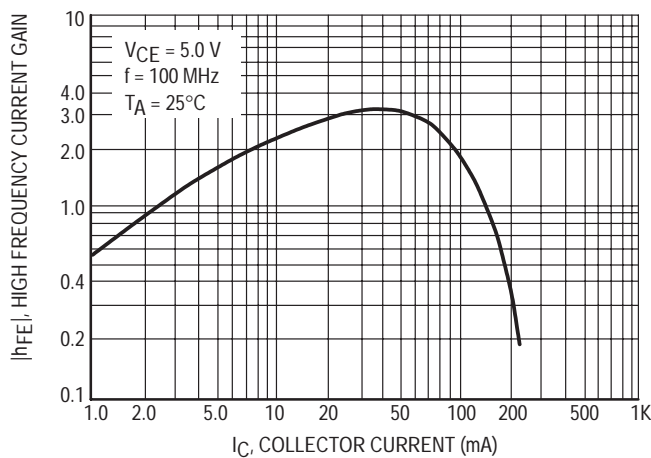


Figure 2. High Frequency Current Gain

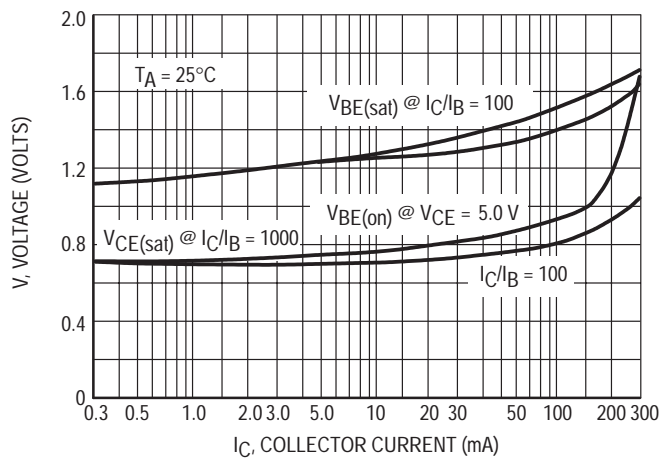


Figure 3. "On" Voltage

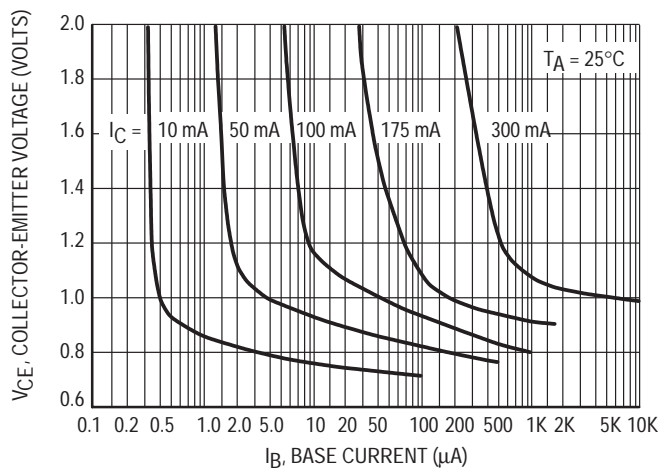
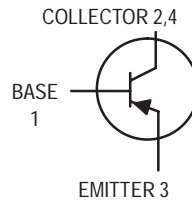


Figure 4. Collector Saturation Region

High Voltage Transistor

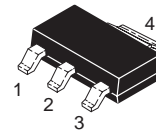
PNP Silicon



PZTA92T1

Motorola Preferred Device

SOT-223 PACKAGE
PNP SILICON
HIGH VOLTAGE TRANSISTOR
SURFACE MOUNT



CASE 318E-04, STYLE 1
TO-261AA

MAXIMUM RATINGS

Rating	Symbol	Value	Unit
Collector-Emitter Voltage	V_{CEO}	-300	Vdc
Collector-Base Voltage	V_{CBO}	-300	Vdc
Emitter-Base Voltage	V_{EBO}	-5.0	Vdc
Collector Current	I_C	-500	mAdc
Total Power Dissipation up to $T_A = 25^\circ\text{C}^{(1)}$	P_D	1.5	Watts
Storage Temperature Range	T_{stg}	-65 to +150	$^\circ\text{C}$
Junction Temperature	T_J	150	$^\circ\text{C}$

DEVICE MARKING

P2D

THERMAL CHARACTERISTICS

Characteristic	Symbol	Max	Unit
Thermal Resistance from Junction to Ambient ⁽¹⁾	$R_{\theta JA}$	83.3	$^\circ\text{C/W}$

ELECTRICAL CHARACTERISTICS ($T_A = 25^\circ\text{C}$ unless otherwise noted)

Characteristic	Symbol	Min	Max	Unit
----------------	--------	-----	-----	------

OFF CHARACTERISTICS

Collector-Emitter Breakdown Voltage ($I_C = -1.0$ mAdc, $I_B = 0$)	$V_{(BR)CEO}$	-300	—	Vdc
Collector-Base Breakdown Voltage ($I_C = -100$ μ Adc, $I_E = 0$)	$V_{(BR)CBO}$	-300	—	Vdc
Emitter-Base Breakdown Voltage ($I_E = -100$ μ Adc, $I_C = 0$)	$V_{(BR)EBO}$	-5.0	—	Vdc
Collector-Base Cutoff Current ($V_{CB} = -200$ Vdc, $I_E = 0$)	I_{CBO}	—	-0.25	μ Adc
Emitter-Base Cutoff Current ($V_{BE} = -3.0$ Vdc, $I_C = 0$)	I_{EBO}	—	-0.1	μ Adc

ON CHARACTERISTICS

DC Current Gain ⁽²⁾ ($I_C = -1.0$ mAdc, $V_{CE} = -10$ Vdc) ($I_C = -10$ mAdc, $V_{CE} = -10$ Vdc) ($I_C = -30$ mAdc, $V_{CE} = -10$ Vdc)	h_{FE}	25 40 25	— — —	—
Saturation Voltages ($I_C = -20$ mAdc, $I_B = -2.0$ mAdc) ($I_C = -20$ mAdc, $I_B = -2.0$ mAdc)	$V_{CE(sat)}$ $V_{BE(sat)}$	— —	-0.5 -0.9	Vdc

DYNAMIC CHARACTERISTICS

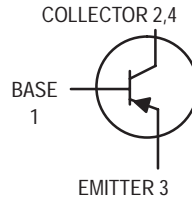
Collector-Base Capacitance @ $f = 1.0$ MHz ($V_{CB} = -20$ Vdc, $I_E = 0$)	C_{cb}	—	6.0	pF
Current-Gain — Bandwidth Product ($I_C = -10$ mAdc, $V_{CE} = -20$ Vdc, $f = 100$ MHz)	f_T	50	—	MHz

1. Device mounted on a glass epoxy printed circuit board 1.575 in. x 1.575 in. x 0.059 in.; mounting pad for the collector lead min. 0.93 in².
2. Pulse Test: Pulse Width ≤ 300 μ s; Duty Cycle = 2.0%.

Preferred devices are Motorola recommended choices for future use and best overall value.

High Voltage Transistor

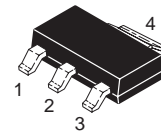
PNP Silicon



PZTA96T1

Motorola Preferred Device

SOT-223 PACKAGE
PNP SILICON
HIGH VOLTAGE TRANSISTOR
SURFACE MOUNT



CASE 318E-04, STYLE 1
TO-261AA

MAXIMUM RATINGS

Rating	Symbol	Value	Unit
Collector–Emitter Voltage	V_{CEO}	–450	Vdc
Collector–Base Voltage	V_{CBO}	–450	Vdc
Emitter–Base Voltage	V_{EBO}	–5.0	Vdc
Collector Current	I_C	–500	mAdc
Total Power Dissipation up to $T_A = 25^\circ\text{C}$ (1)	P_D	1.5	Watts
Storage Temperature Range	T_{stg}	–65 to +150	$^\circ\text{C}$
Junction Temperature	T_J	150	$^\circ\text{C}$

DEVICE MARKING

ZTA96

THERMAL CHARACTERISTICS

Characteristic	Symbol	Max	Unit
Thermal Resistance from Junction to Ambient(1)	$R_{\theta JA}$	83.3	$^\circ\text{C}$

ELECTRICAL CHARACTERISTICS ($T_A = 25^\circ\text{C}$ unless otherwise noted)

Characteristic	Symbol	Min	Max	Unit
----------------	--------	-----	-----	------

OFF CHARACTERISTICS

Collector–Emitter Breakdown Voltage ($I_C = -1.0$ mAdc, $I_B = 0$)	$V_{(BR)CEO}$	–450	—	Vdc
Collector–Emitter Breakdown Voltage ($I_C = -100$ μ Adc, $I_E = 0$)	$V_{(BR)CBO}$	–450	—	Vdc
Emitter–Base Breakdown Voltage ($I_E = -10$ μ Adc, $I_C = 0$)	$V_{(BR)EBO}$	–5.0	—	Vdc
Collector–Base Cutoff Current ($V_{CB} = -400$ Vdc, $I_E = 0$)	I_{CBO}	—	–0.1	μ Adc
Emitter–Base Cutoff Current ($V_{BE} = -4.0$ Vdc, $I_C = 0$)	I_{EBO}	—	–0.1	μ Adc

ON CHARACTERISTICS

DC Current Gain(2) ($I_C = -10$ mAdc, $V_{CE} = -10$ Vdc)	h_{FE}	50	150	—
Saturation Voltages ($I_C = -20$ mAdc, $I_B = -2.0$ mAdc) ($I_C = -20$ mAdc, $I_B = -2.0$ mAdc)	$V_{CE(sat)}$ $V_{BE(sat)}$	—	–0.6 –1.0	Vdc

1. Device mounted on a glass epoxy printed circuit board 1.575 in. x 1.575 in. x 0.059 in.; mounting pad for the collector lead min. 0.93 in².

2. Pulse Test: Pulse Width ≤ 300 μ s; Duty Cycle = 2.0%.

Preferred devices are Motorola recommended choices for future use and best overall value.

Advance Information

Integrated Relay/Solenoid Driver

- Optimized to Switch 3 V to 5 V Relays from a 5 V Rail
- Compatible with "TX" and "TQ" Series Telecom Relays Rated up to 300 mW at 3 V to 5 V
- Features Low Input Drive Current
- Internal Zener Clamp Routes Induced Current to Ground Rather Than Back to Supply
- Guaranteed Off State with No Input Connection
- Supports Large Systems with Minimal Off-State Leakage
- ESD Resistant in Accordance with the 2000 V Human Body Model
- Provides a Robust Driver Interface Between Relay Coil and Sensitive Logic Circuits

Applications include:

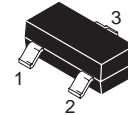
- Telecom Line Cards and Telephony
- Industrial Controls
- Security Systems
- Appliances and White Goods
- Automated Test Equipment
- Automotive Controls

This device is intended to replace an array of three to six discrete components with an integrated SMT part. It is available in a SOT-23 package. It can be used to switch other 3 to 5 Vdc Inductive Loads such as solenoids and small DC motors.

MDC3105LT1

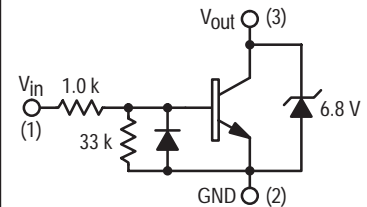
Motorola Preferred Device

RELAY/SOLENOID DRIVER
SILICON MONOLITHIC
CIRCUIT BLOCK



CASE 318-08, STYLE 6
SOT-23 (TO-236AB)

INTERNAL CIRCUIT DIAGRAM



MAXIMUM RATINGS

Rating	Symbol	Value	Unit
Power Supply Voltage	V_{CC}	6.0	Vdc
Recommended Operating Supply Voltage	V_{CC}	2.0-5.5	Vdc
Input Voltage	$V_{in(fwd)}$	6.0	Vdc
Reverse Input Voltage	$V_{in(rev)}$	-0.5	Vdc
Output Sink Current — Continuous	I_O	300	mA
Junction Temperature	T_J	150	°C
Operating Ambient Temperature Range	T_A	-40 to +85	°C
Storage Temperature Range	T_{stg}	-65 to +150	°C

THERMAL CHARACTERISTICS

Characteristic	Symbol	Max	Unit
Total Device Dissipation ⁽¹⁾ Derate above 25°C	P_D	225	mW
Thermal Resistance Junction to Ambient	$R_{\theta JA}$	556	°C/W

1. FR-5 PCB of 1" x 0.75" x 0.062", $T_A = 25^\circ\text{C}$

Preferred devices are Motorola recommended choices for future use and best overall value.

This document contains information on a new product. Specifications and information herein are subject to change without notice.

ELECTRICAL CHARACTERISTICS ($T_A = 25^\circ\text{C}$ unless otherwise noted)

Characteristic	Symbol	Min	Typ	Max	Unit
OFF CHARACTERISTICS					
Output Zener Breakdown Voltage (@ $I_T = 10\text{ mA Pulse}$)	$V_{(BRout)}$ $V_{(-BRout)}$	6.4 —	6.8 -0.7	7.2 —	V
Output Leakage Current @ 0 Input Voltage ($V_{out} = 5.5\text{ Vdc}$, $V_{in} = \text{O.C.}$, $T_A = 25^\circ\text{C}$) ($V_{out} = 5.5\text{ Vdc}$, $V_{in} = \text{O.C.}$, $T_A = 85^\circ\text{C}$)	I_{OO}	— —	— —	5.0 30	μA
ON CHARACTERISTICS					
Input Bias Current @ $V_{in} = 4.0\text{ Vdc}$ ($I_O = 250\text{ mA}$, $V_{out} = 0.4\text{ Vdc}$, $T_A = -40^\circ\text{C}$) (correlated to a measurement @ 25°C)	I_{in}	—	2.5	—	mAdc
Output Saturation Voltage ($I_O = 250\text{ mA}$, $V_{in} = 4.0\text{ Vdc}$, $T_A = -40^\circ\text{C}$) (correlated to a measurement @ 25°C)		—	0.2	0.4	Vdc
Output Sink Current — Continuous ($T_A = -40^\circ\text{C}$, $V_{CE} = 0.4\text{ Vdc}$, $V_{in} = 4.0\text{ Vdc}$) (correlated to a measurement @ 25°C)	$I_{C(on)}$	250	—	—	mA

TYPICAL APPLICATION-DEPENDENT SWITCHING PERFORMANCE**SWITCHING CHARACTERISTICS**

Characteristic	Symbol	VCC	Min	Typ	Max	Units
Propagation Delay Times:						
High to Low Propagation Delay; Figures 1, 2 (5.0 V 74HC04)	t_{PHL}	5.5	—	55	—	ns
Low to High Propagation Delay; Figures 1, 2 (5.0 V 74HC04)	t_{PLH}	5.5	—	430	—	
High to Low Propagation Delay; Figures 1, 3 (3.0 V 74HC04)	t_{PHL}	5.5	—	85	—	
Low to High Propagation Delay; Figures 1, 3 (3.0 V 74HC04)	t_{PLH}	5.5	—	315	—	
High to Low Propagation Delay; Figures 1, 4 (5.0 V 74LS04)	t_{PHL}	5.5	—	55	—	
Low to High Propagation Delay; Figures 1, 4 (5.0 V 74LS04)	t_{PLH}	5.5	—	2385	—	
Transition Times:						
Fall Time; Figures 1, 2 (5.0 V 74HC04)	t_f	5.5	—	45	—	ns
Rise Time; Figures 1, 2 (5.0 V 74HC04)	t_r	5.5	—	160	—	
Fall Time; Figures 1, 3 (3.0 V 74HC04)	t_f	5.5	—	70	—	
Rise Time; Figures 1, 3 (3.0 V 74HC04)	t_r	5.5	—	195	—	
Fall Time; Figures 1, 4 (5.0 V 74LS04)	t_f	5.5	—	45	—	
Rise Time; Figures 1, 4 (5.0 V 74LS04)	t_r	5.5	—	2400	—	
Input Slew Rate ⁽¹⁾	$\Delta V/\Delta t_{in}$	5.5	TBD	—	—	V/ms

1. Minimum input slew rate must be followed to avoid overdissipating the device.

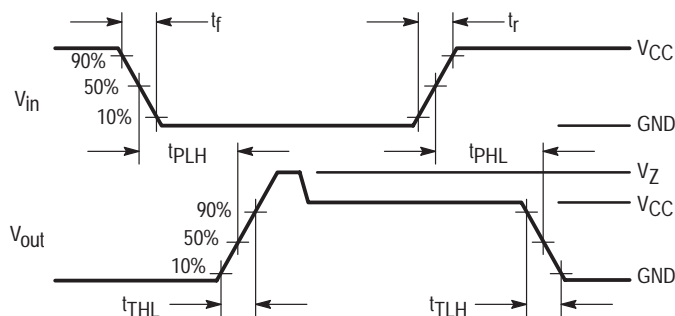


Figure 1. Switching Waveforms

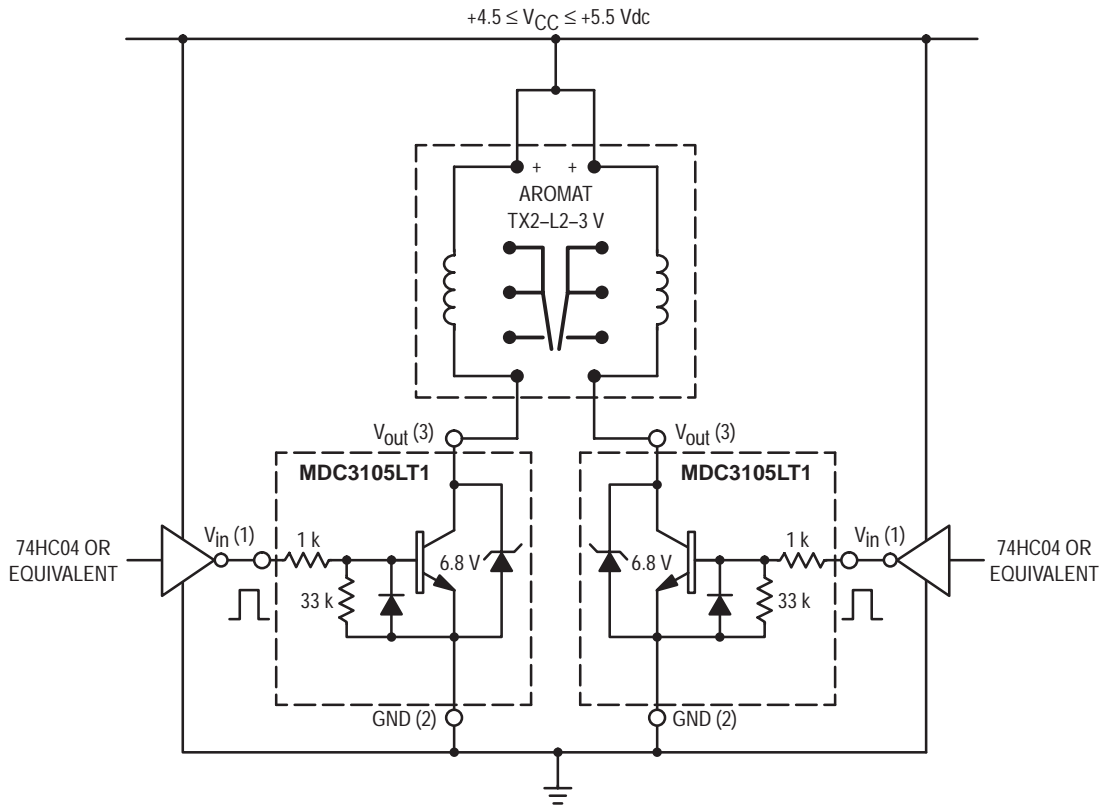


Figure 2. A 3.0-V, 200-mW Dual Coil Latching Relay Application with 5.0 V-HCMOS Interface

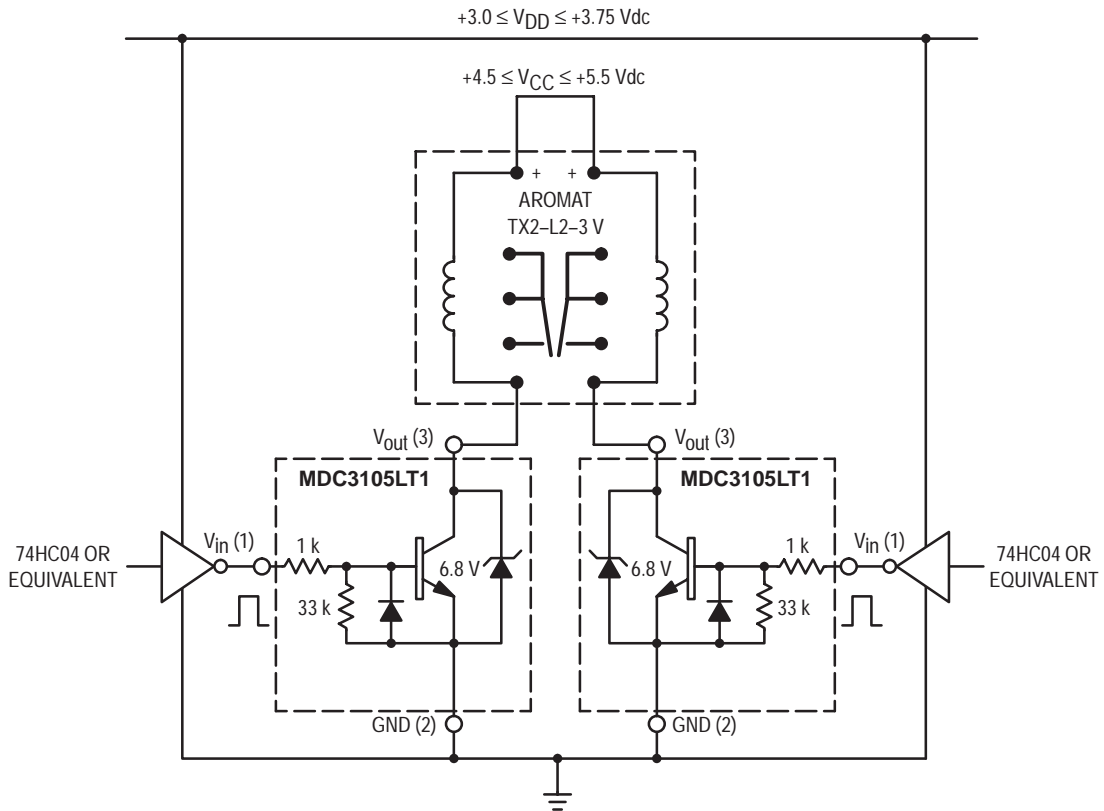


Figure 3. A 3.0-V, 200-mW Dual Coil Latching Relay Application with 3.0 V-HCMOS Interface

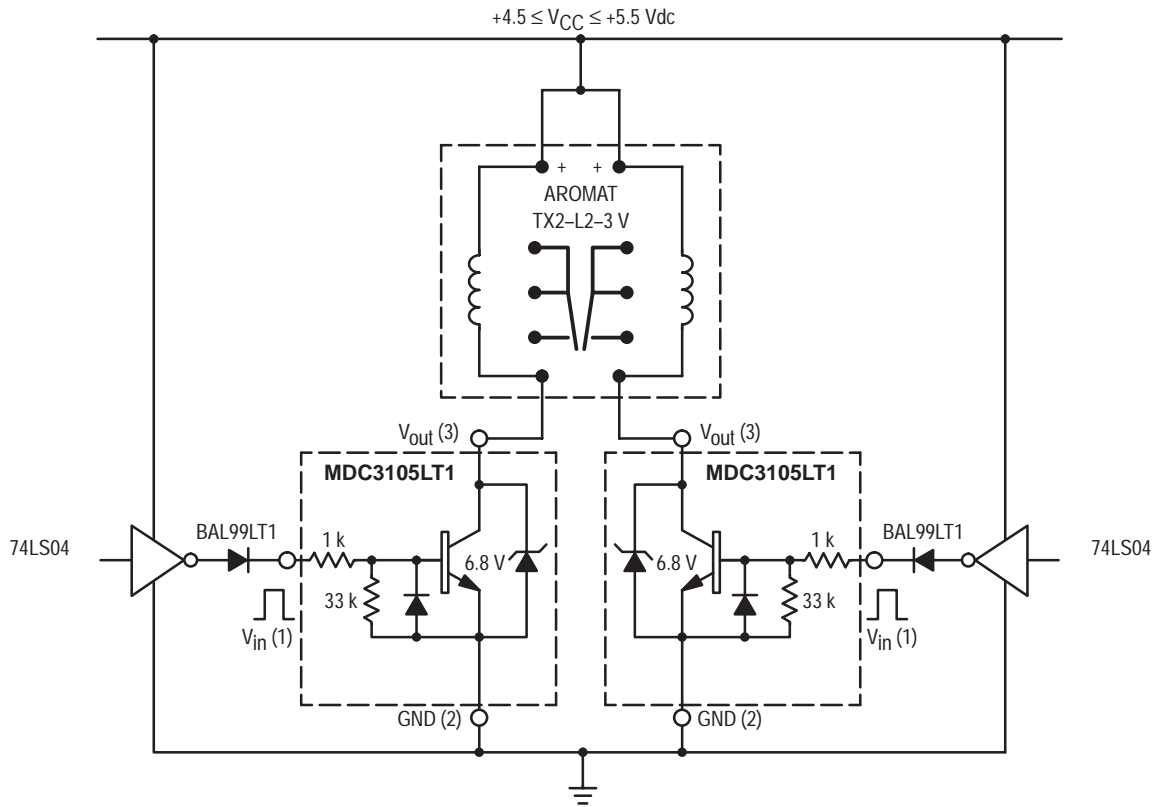


Figure 4. A 3.0-V, 200-mW Dual Coil Latching Relay Application with TTL Interface

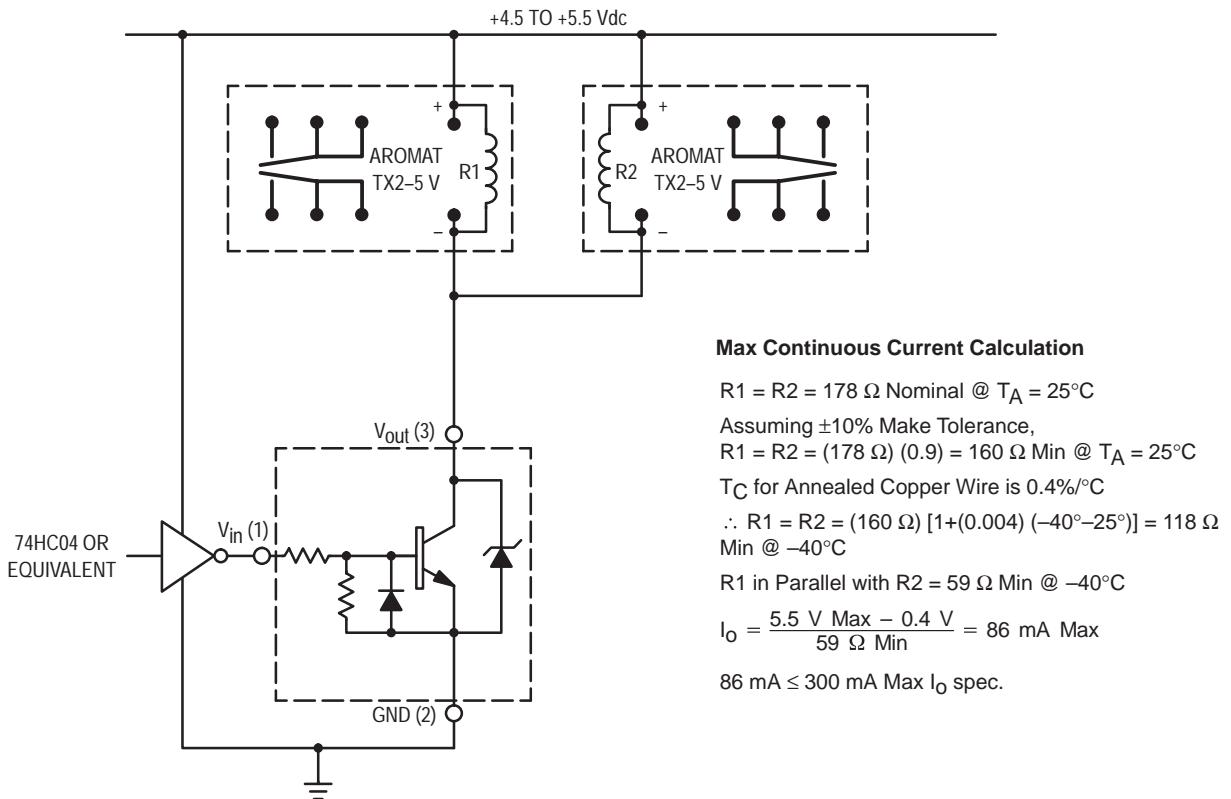


Figure 5. Typical 5.0 V, 140 mW Coil Dual Relay Application

TYPICAL OPERATING WAVEFORMS

(Circuit of Figure 5)

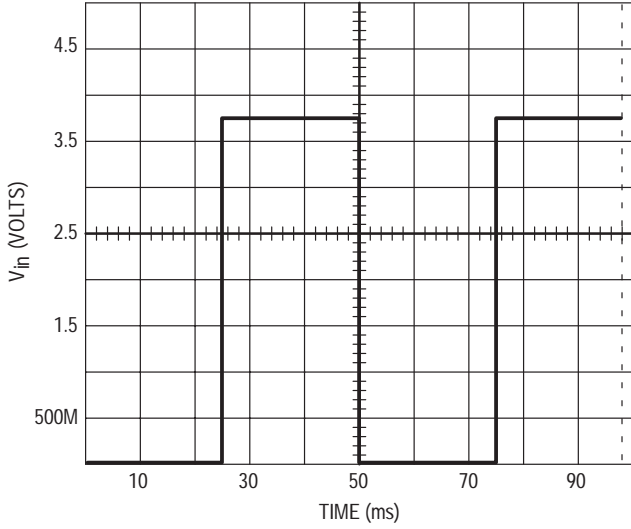


Figure 6. 20 Hz Square Wave Input

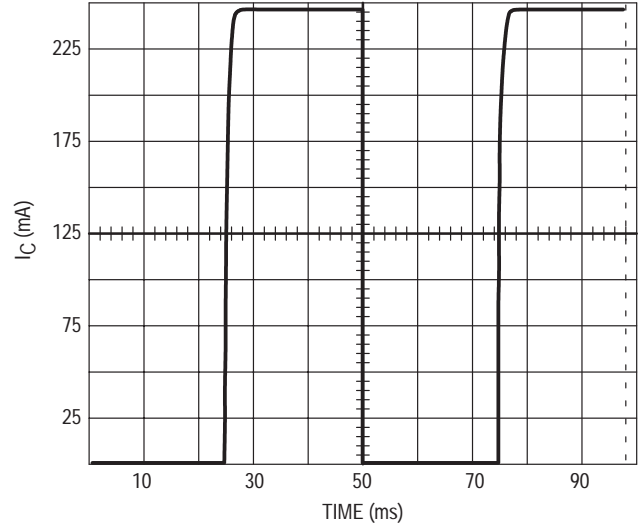


Figure 7. 20 Hz Square Wave Response

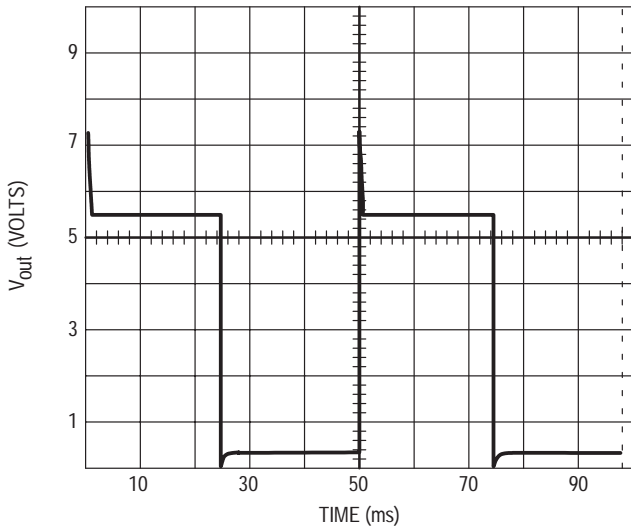


Figure 8. 20 Hz Square Wave Response

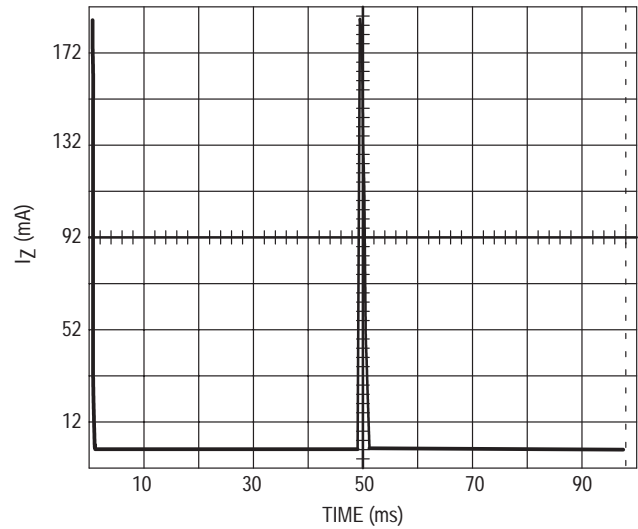


Figure 9. 20 Hz Square Wave Response

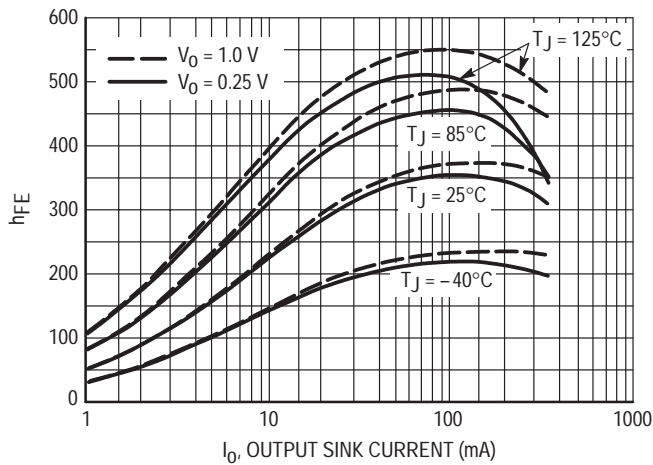


Figure 10. Pulsed Current Gain

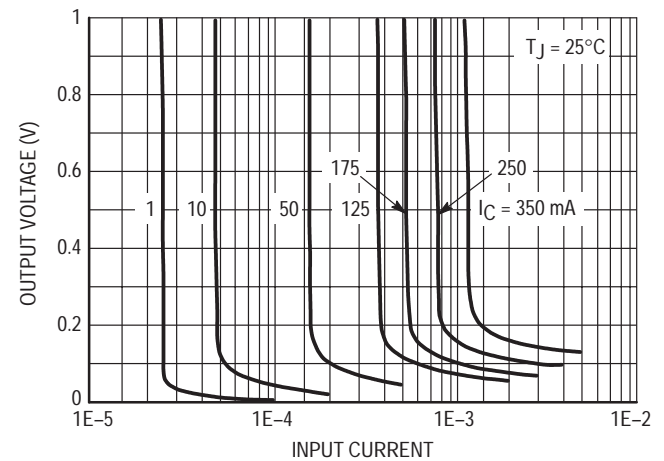


Figure 11. Collector Saturation Region

Low Voltage Bias Stabilizer with Enable

- Maintains Stable Bias Current in N-Type Discrete Bipolar Junction and Field Effect Transistors
- Provides Stable Bias Using a Single Component Without Use of Emitter Ballast and Bypass Components
- Operates Over a Wide Range of Supply Voltages Down to 1.8 Vdc
- Reduces Bias Current Variation Due to Temperature and Unit-to-Unit Parametric Changes
- Consumes < 0.5 mW at $V_{CC} = 2.75$ V
- Active High Enable is CMOS Compatible

This device provides a reference voltage and acts as a DC feedback element around an external discrete, NPN BJT or N-Channel FET. It allows the external transistor to have its emitter/source directly grounded and still operate with a stable collector/drain DC current. It is primarily intended to stabilize the bias of discrete RF stages operating from a low voltage regulated supply, but can also be used to stabilize the bias current of any linear stage in order to eliminate emitter/source bypassing and achieve tighter bias regulation over temperature and unit variations. The "ENABLE" polarity nulls internal current, Enable current, and RF transistor current in "STANDBY." This device is intended to replace a circuit of three to six discrete components.

The combination of low supply voltage, low quiescent current drain, and small package make the MDC5001T1 ideal for portable communications applications such as:

- Cellular Telephones
- Pagers
- PCN/PCS Portables
- GPS Receivers
- PCMCIA RF Modems
- Cordless Phones
- Broadband and Multiband Transceivers and Other Portable Wireless Products

MAXIMUM RATINGS

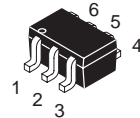
Rating	Symbol	Value	Unit
Power Supply Voltage	V_{CC}	15	Vdc
Ambient Operating Temperature Range	T_A	-40 to +85	°C
Storage Temperature Range	T_{stg}	-65 to +150	°C
Junction Temperature	T_J	150	°C
Collector Emitter Voltage (Q2)	V_{CEO}	-15	V
Enable Voltage (Pin 5)	V_{ENBL}	V_{CC}	V

THERMAL CHARACTERISTICS

Characteristic	Symbol	Max	Unit
Total Device Power Dissipation (FR-5 PCB of 1" x 0.75" x 0.062", $T_A = 25^\circ\text{C}$) Derate above 25°C	P_D	150 1.2	mW mW/°C
Thermal Resistance, Junction to Ambient	$R_{\theta JA}$	833	°C/W

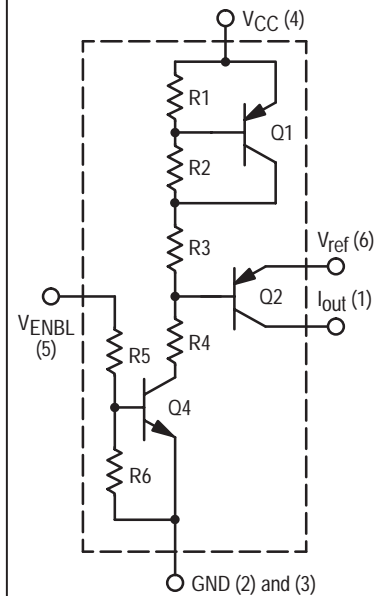
MDC5001T1

SILICON
SMALLBLOCK™
INTEGRATED CIRCUIT



CASE 419B-01, Style 19
SOT-363

INTERNAL CIRCUIT DIAGRAM



MDC5001T1

ELECTRICAL CHARACTERISTICS (T_A = 25°C unless otherwise noted)

Characteristic	Symbol	Min	Typ	Max	Unit
Recommended Operating Supply Voltage	V _{CC}	1.8	2.75	10	Volts
Power Supply Current (V _{CC} = 2.75 V) V _{ref} , I _{out} are unterminated See Figure 8	I _{CC}	—	130	200	μA
Q2 Collector Emitter Breakdown Voltage (I _{C2} = 10 μA, I _{B2} = 0)	V _{(BR)CEO2}	15			Volts
Reference Voltage (V _{ENBL} = V _{CC} = 2.75 V, V _{out} = 0.7 V) (I _{out} = 30 μA) (I _{out} = 150 μA) See Figure 1	V _{ref}	2.050 2.110	2.075 2.135	2.100 2.160	Volts
Reference Voltage (V _{ENBL} = V _{CC} = 2.75 V, V _{out} = 0.7 V, −40°C ≤ T _A ≤ +85°C) V _{CC} Pulse Width = 10 mS, Duty Cycle = 1% (I _{out} = 10 μA) (I _{out} = 30 μA) (I _{out} = 100 μA) See Figures 2 and 11	ΔV _{ref}		±5.0 ±15 ±25	±10 ±30 ±50	mV

The following SPICE models are provided as a convenience to the user and every effort has been made to insure their accuracy. However, no responsibility for their accuracy is assumed by Motorola.

.MODEL Q4 NPN		.MODEL Q1, Q2 PNP	
BF = 136	NE = 1.6	BF = 87	NK = 0.5
BR = 0.2	NF = 1.005	BR = 0.6	NR = 1.0
CJC = 318.6 f	RB = 140	CJC = 800E−15	RB = 720
CJE = 569.2 f	RBM = 70	CJE = 46E−15	RBM = 470
CJS = 1.9 p	RC = 180	EG = 1.215	RC = 180
EG = 1.215	RE = 1.6	FC = 0.5	RE = 26
FC = 0.5	TF = 553.6 p	IKF = 3.8E−04	TF = 15E−9
IKF = 24.41 m	TR = 10 n	IKR = 2.0	TR = 50E−09
IKR = 0.25	VAF = 267.6	IRB = 0.9E−3	VAF = 54.93
IRB = 0.0004	VAR = 12	IS = 1.027E−15	VAR = 20
IS = 256E−18	VJC = 0.4172	ISC = 10E−18	VAR = 20
ISC = 1 f	VJE = 0.7245	ISE = 1.8E−15	VJC = 0.4172
ISE = 500E−18	VJS = 0.39	ITF = 2E−3	VJE = 0.4172
ITF = 0.9018	VTF = 10	MJC = 0.2161	VTF = 10
MJC = 0.2161	XTB = 1.5	MJE = 0.2161	XTB = 1.5
MJE = 0.3373	XTF = 2.077	NC = 0.8	XTF = 2.0
MJS = 0.13	XTI = 3	NE = 1.38	XTI = 3
NC = 1.09		NF = 1.015	

RESISTOR VALUES
R1 = 12 K
R2 = 6 K
R3 = 3.4 K
R4 = 12 K
R5 = 20 K
R6 = 40 K

These models can be retrieved electronically by accessing the Motorola Web page at <http://design-net.sps.mot.com/models> and searching the section on SMALLBLOCK™ models

TYPICAL OPEN LOOP CHARACTERISTICS

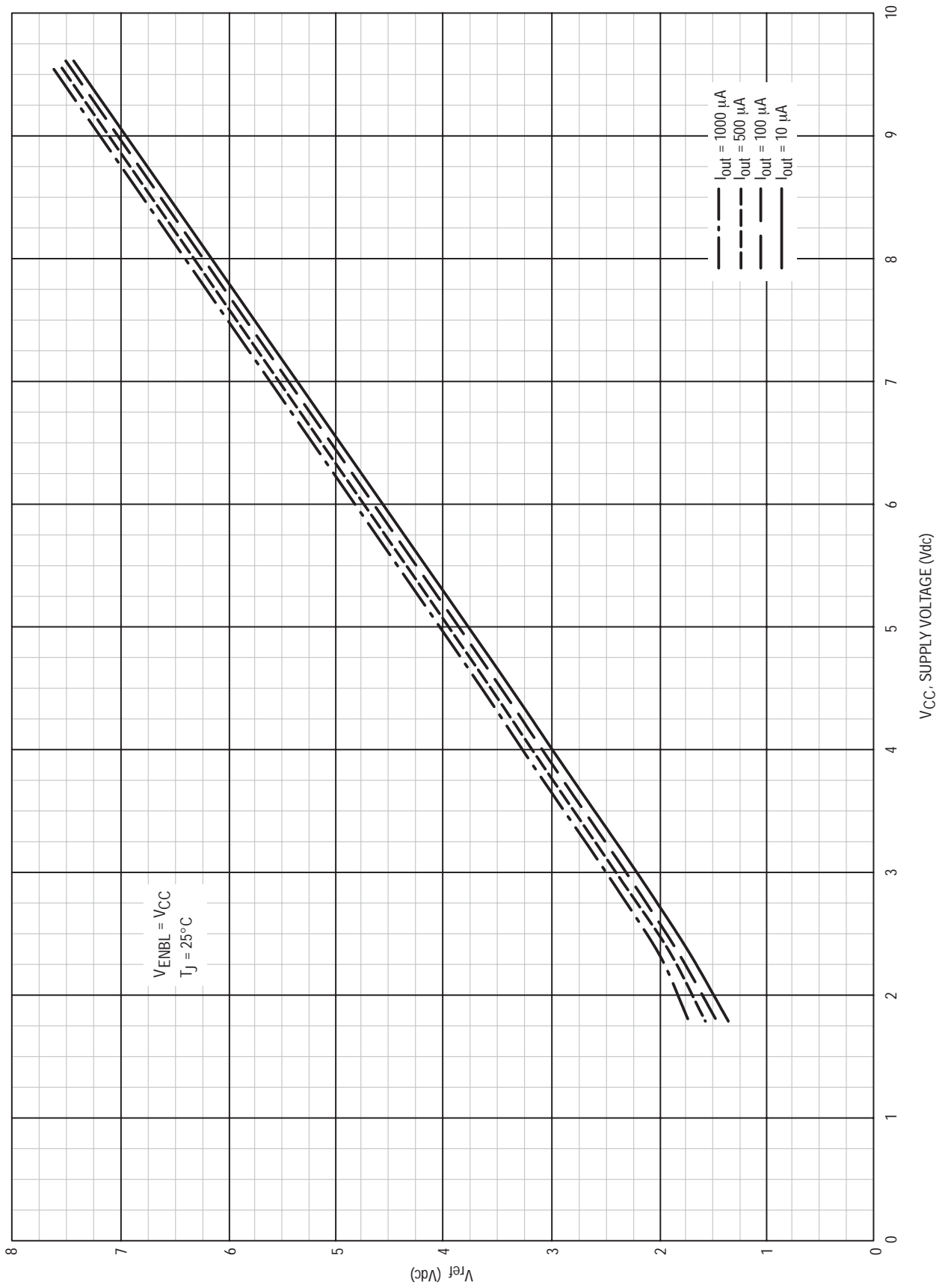


Figure 1. V_{ref} versus V_{CC} @ I_{out}

TYPICAL OPEN LOOP CHARACTERISTICS
(Refer to Circuits of Figures 10 through 15)

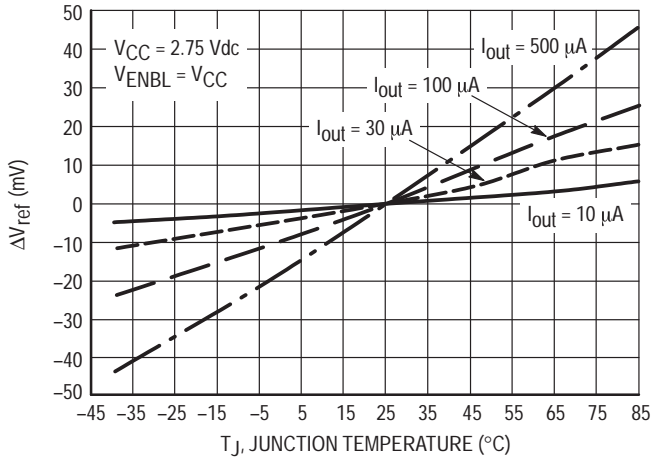


Figure 2. ΔV_{ref} versus T_J @ I_{out}

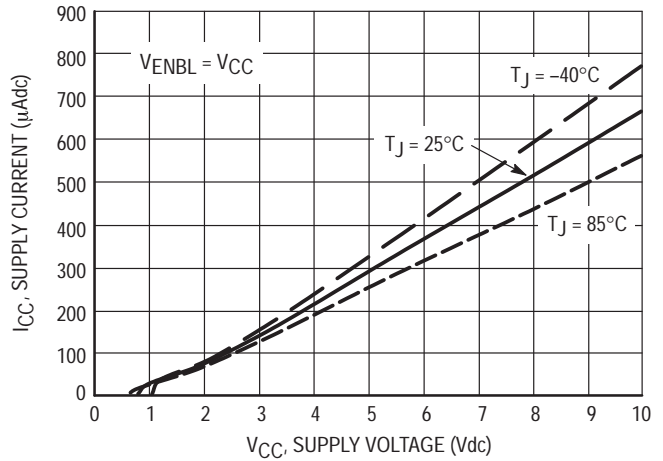


Figure 3. I_{CC} versus V_{CC} @ T_J

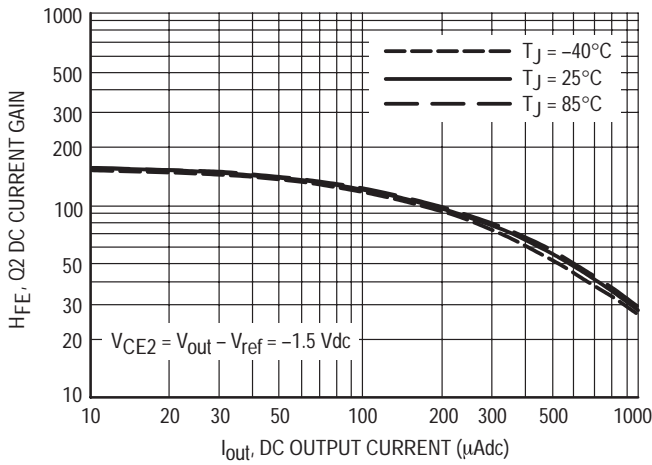


Figure 4. Q2 Current Gain versus Output Current @ T_J

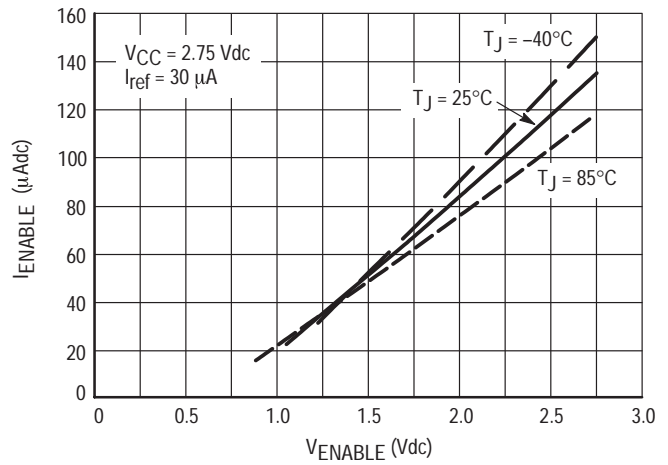


Figure 5. I_{enable} versus V_{enable}

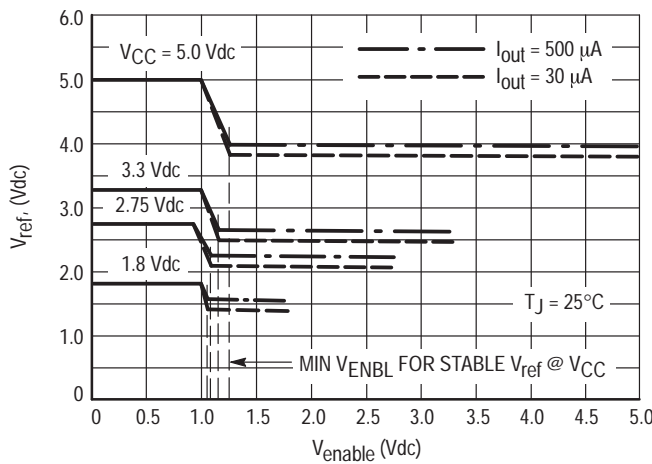


Figure 6. V_{ref} versus V_{enable} @ V_{CC} and I_{out}

TYPICAL CLOSED LOOP PERFORMANCE
(Refer to Circuits of Figures 16 & 17)

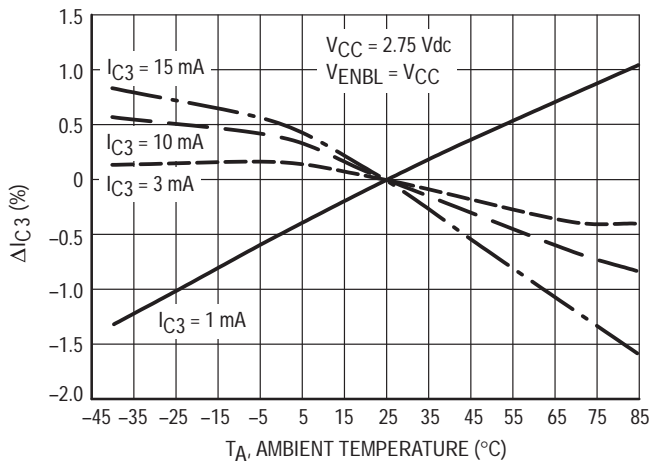


Figure 7. ΔI_{C3} versus T_A @ I_{C3}

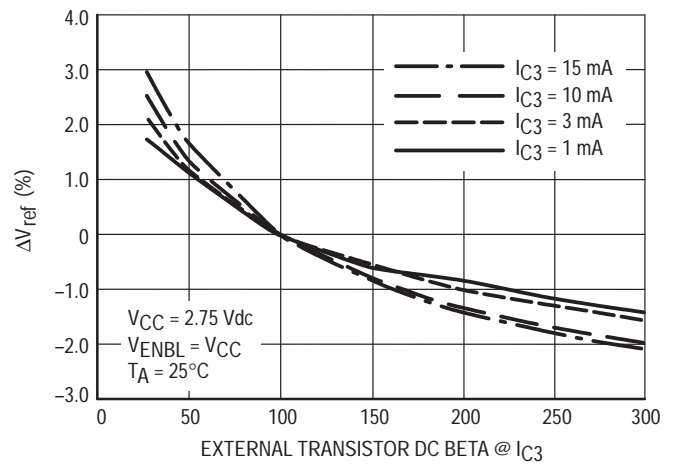


Figure 8. ΔV_{ref} versus External Transistor DC Beta @ I_{C3}

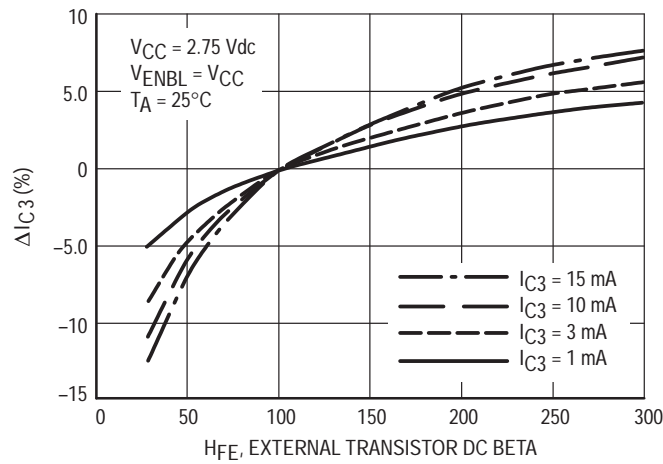


Figure 9. ΔI_{C3} versus External Transistor DC Beta @ I_{C3}

OPEN LOOP TEST CIRCUITS

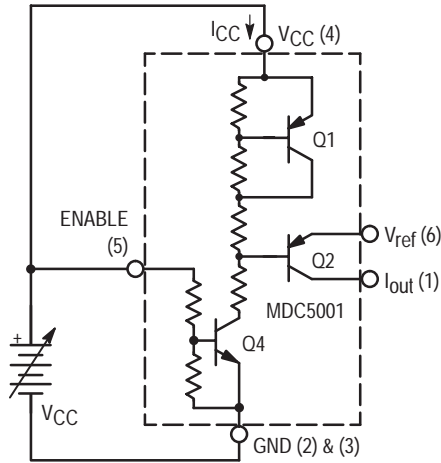
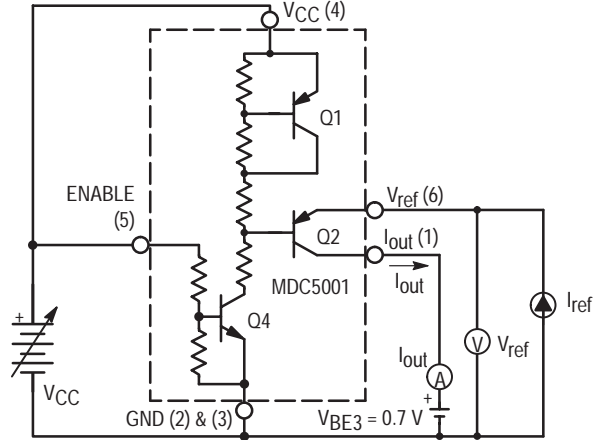
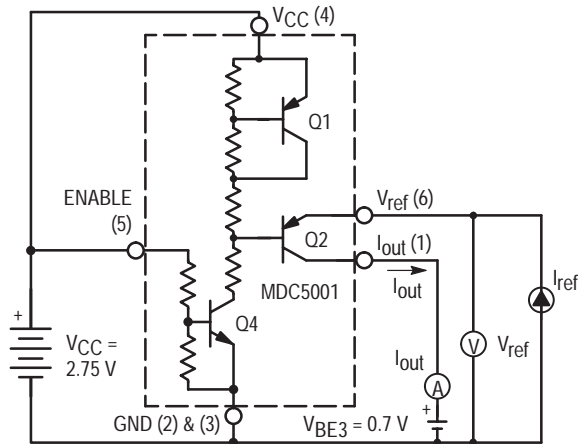


Figure 10. I_{CC} versus V_{CC} Test Circuit



See NOTE 1

Figure 11. V_{ref} versus V_{CC} Test Circuit



See NOTE 1

Figure 12. V_{ref} versus T_J Test Circuit

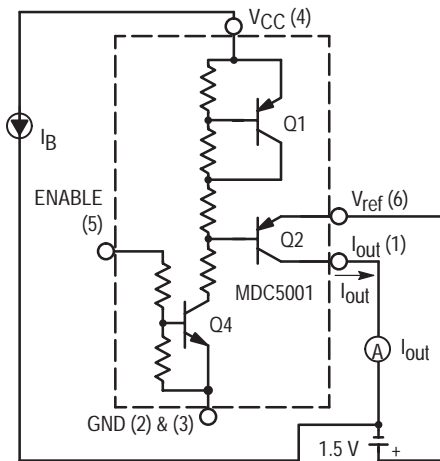


Figure 13. H_{FE} versus I_{out} Test Circuit

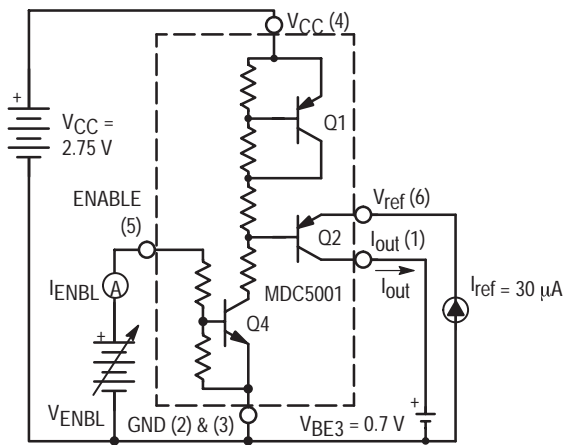
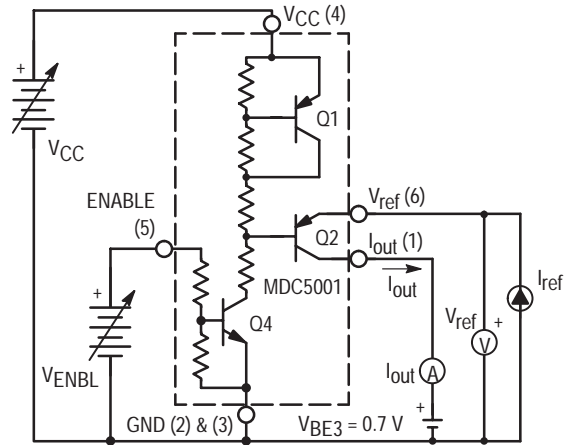


Figure 14. I_{ENBL} versus V_{ENBL} Test Circuit



See NOTE 1

Figure 15. V_{ref} versus V_{ENBL} Test Circuit

NOTE 1: V_{BE3} is used to simulate actual operating conditions that reduce V_{CE2} & H_{FE2} , and increase I_{B2} & V_{ref} .

CLOSED LOOP TEST CIRCUITS

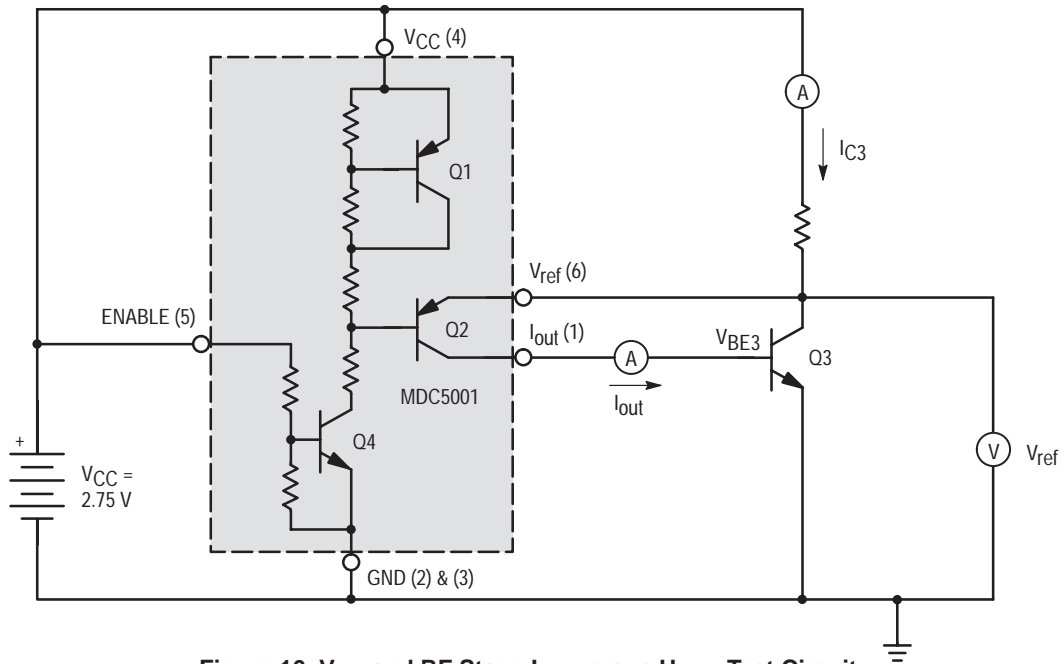
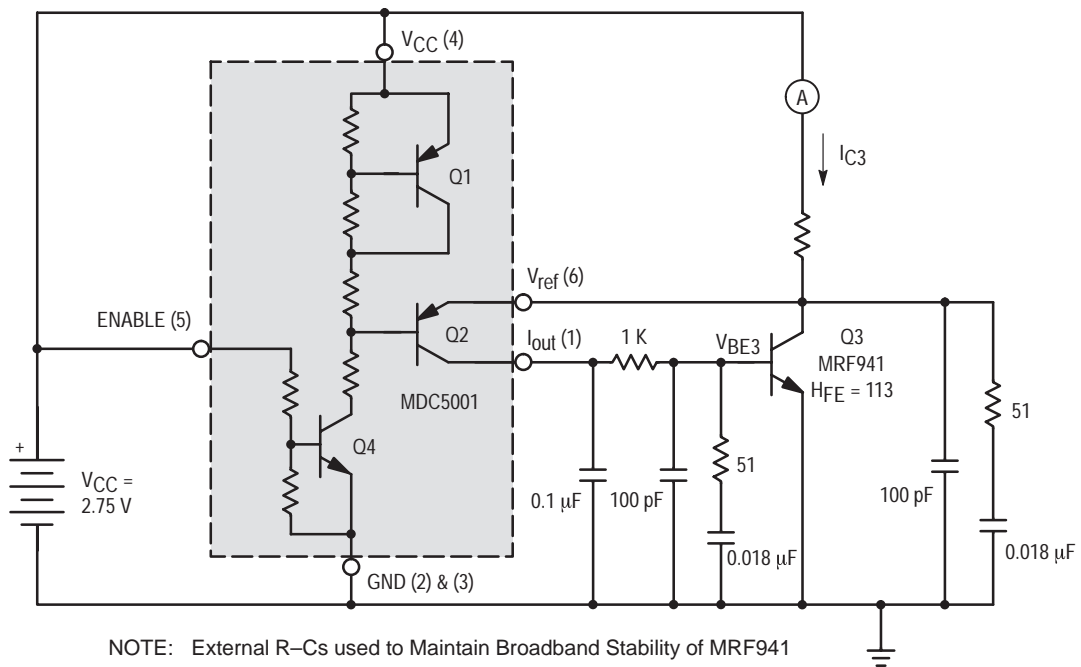


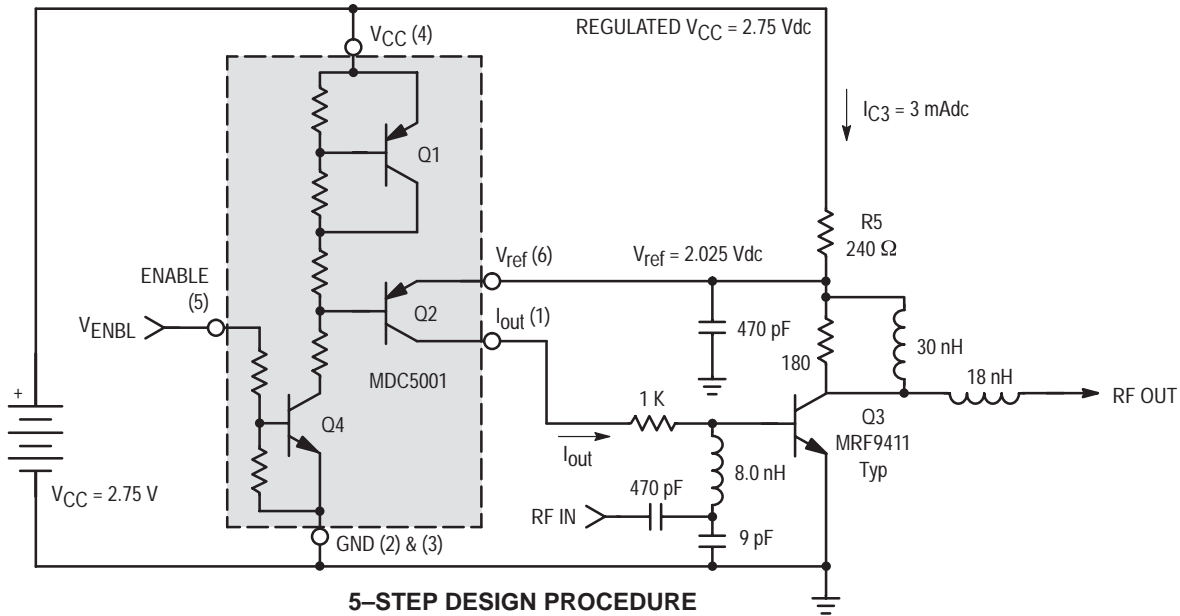
Figure 16. V_{ref} and RF Stage I_{C3} versus H_{FE3} Test Circuit



NOTE: External R-Cs used to Maintain Broadband Stability of MRF941

Figure 17. RF Stage I_{C3} versus T_A Test Circuit

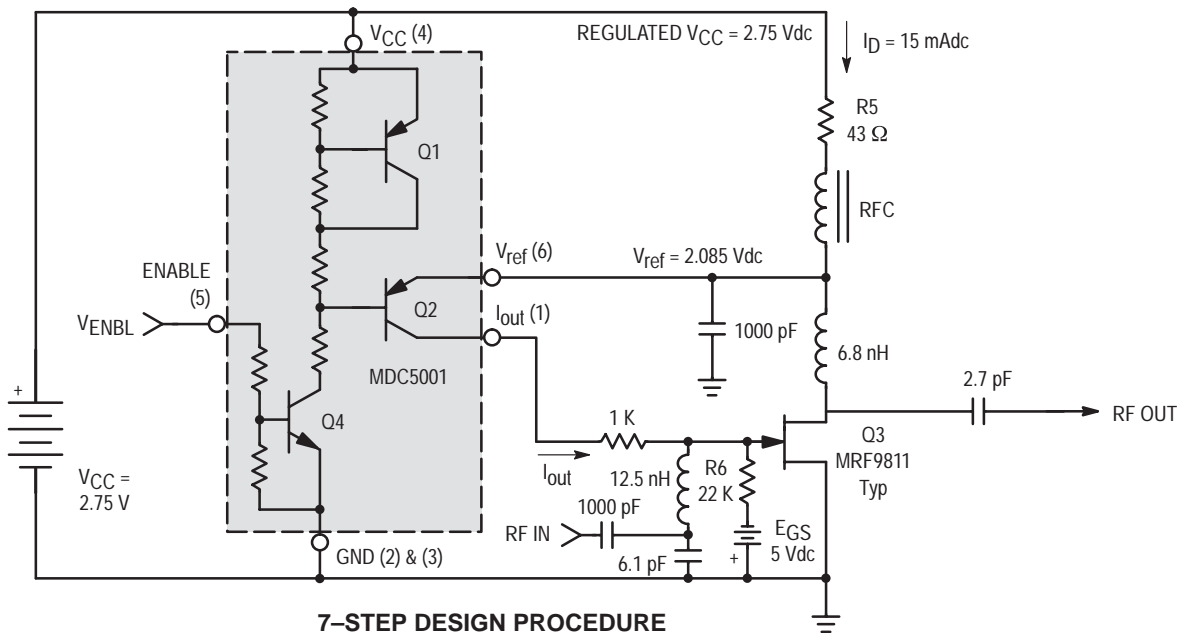
APPLICATION CIRCUITS



5-STEP DESIGN PROCEDURE

- Step 1: Choose V_{CC} (1.8 V Min to 10 V Max)
- Step 2: Insure that Min V_{ENBL} is \geq minimum indicated in Figures 5 and 6.
- Step 3: Choose bias current, I_{C3} , and calculate needed I_{out} from typ HFE3
- Step 4: From Figure 1, read V_{ref} for V_{CC} and I_{out} calculated.
- Step 5: Calculate Nominal $R5 = (V_{CC} - V_{ref}) \div (I_{C3} + I_{out})$. Tweak as desired.

Figure 18. Class A Biasing of a Typical 900 MHz BJT Amplifier Application



7-STEP DESIGN PROCEDURE

- Step 1: Choose V_{CC} (1.8 V Min to 10 V Max)
- Step 2: Insure that Min V_{ENBL} is \geq minimum indicated in Figures 5 and 6.
- Step 3: Choose bias current, I_D , and determine needed gate-source voltage, V_{GS} .
- Step 4: Choose I_{out} keeping in mind that too large an I_{out} can impair MDC5000 $\Delta V_{ref}/\Delta T_J$ performance (Figure 2) but too large an $R6$ can cause I_{DGO} & I_{GSO} to bias on the FET.
- Step 5: Calculate $R6 = (V_{GS} + E_{GS}) \div I_{out}$
- Step 6: From Figure 1, read V_{ref} for V_{CC} & I_{out} chosen
- Step 7: Calculate Nominal $R5 = (V_{CC} - V_{ref}) \div (I_D + I_{out})$. Tweak as desired.

Figure 19. Class A Biasing of a Typical 890 MHz Depletion Mode GaAs FET Amplifier

Section 3

GreenLine™ Portfolio

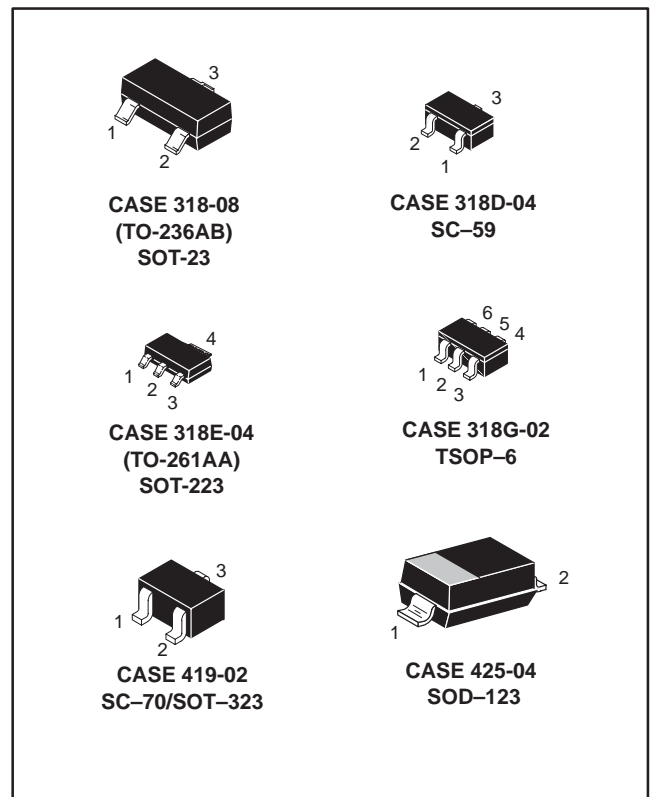
In Brief . . .

New in this revision is Motorola's GreenLine™ portfolio of devices. These devices feature energy-conserving traits superior to those of our existing line of standard parts for the same usage. GreenLine devices can actually help reduce the power demands of your products. In an increasingly power-hungry world, Motorola's GreenLine™ portfolio makes powerful sense. So much sense that we plan to continue adding devices to the portfolio. Chances are, there are Motorola GreenLine™ devices applicable to one or more of your products – ones that can help save energy, dollars – and the environment.

Currently, our portfolio consists of three families:

- **Low-Leakage Switching Diodes:** Reverse leakage specifications guaranteed to 500 pA. They help extend battery life and are ideal for small battery powered systems in which standby power is essential. Applications include ESD protection, reverse voltage protection, and steering logic.
- **Bipolar Output Driver Transistors:** Ultra-low collector saturation voltage. They deliver more energy to the intended load with less power wasted through dissipation loss. Especially effective in lower voltage battery powered applications and prolong battery life in portable and hand-held communications and personal digital equipment. Applications include low voltage display light drivers and general output drivers.
- **Small Signal HDTMOS™:** Lowest ever drain-source resistance versus package size. Lower $r_{DS(on)}$ means less wasted energy through dissipation loss. Especially effective for low-current applications where energy conservation is crucial. These small MOSFETs are ideal for space-sensitive power management circuitry. Applications include low current switchmode power supplies, uninterruptable power supplies (UPS), power management systems, and bias switching.

This chapter exclusively highlights the GreenLine devices, which are also listed in their respective Transistor, Diode and MOSFET chapters.





BSS84LT1

Motorola Preferred Device

Low $r_{DS(on)}$ Small-Signal MOSFETs TMOS Single P-Channel Field Effect Transistors

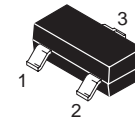
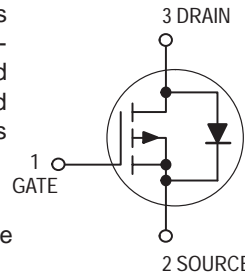
Part of the Greenline™ Portfolio of devices with energy-conserving traits.

These miniature surface mount MOSFETs utilize Motorola's High Cell Density, HDTMOS process. Reduced power loss conserves energy, making this device ideal for use in small power management circuitry. Typical applications are dc-dc converters, load switching, power management in portable and battery-powered products such as computers, printers, cellular and cordless telephones.

- Energy Efficient
- Miniature SOT-23 Surface Mount Package Saves Board Space



P-CHANNEL
ENHANCEMENT-MODE
TMOS MOSFET



CASE 318-08, Style 21
SOT-23 (TO-236AB)

MAXIMUM RATINGS ($T_J = 25^\circ\text{C}$ unless otherwise noted)

Rating	Symbol	Value	Unit
Drain-to-Source Voltage	V_{DSS}	50	Vdc
Gate-to-Source Voltage — Continuous	V_{GS}	± 20	Vdc
Drain Current — Continuous @ $T_A = 25^\circ\text{C}$ — Pulsed Drain Current ($t_p \leq 10 \mu\text{s}$)	I_D I_{DM}	130 520	mA
Total Power Dissipation @ $T_A = 25^\circ\text{C}$	P_D	225	mW
Operating and Storage Temperature Range	T_J, T_{stg}	-55 to 150	$^\circ\text{C}$
Thermal Resistance — Junction-to-Ambient	$R_{\theta JA}$	556	$^\circ\text{C}/\text{W}$
Maximum Lead Temperature for Soldering Purposes, for 10 seconds	T_L	260	$^\circ\text{C}$

DEVICE MARKING

BSS84LT1 = PD

ORDERING INFORMATION

Device	Reel Size	Tape Width	Quantity
BSS84LT1	7"	8mm embossed tape	3000
BSS84LT3	13"	8mm embossed tape	10,000

Preferred devices are Motorola recommended choices for future use and best overall value.

ELECTRICAL CHARACTERISTICS ($T_A = 25^\circ\text{C}$ unless otherwise noted)

Characteristic	Symbol	Min	Typ	Max	Unit
OFF CHARACTERISTICS					
Drain-to-Source Breakdown Voltage ($V_{GS} = 0\text{ Vdc}$, $I_D = 250\ \mu\text{Adc}$)	$V_{(BR)DSS}$	50	—	—	Vdc
Zero Gate Voltage Drain Current ($V_{DS} = 25\text{ Vdc}$, $V_{GS} = 0\text{ Vdc}$) ($V_{DS} = 50\text{ Vdc}$, $V_{GS} = 0\text{ Vdc}$) ($V_{DS} = 50\text{ Vdc}$, $V_{GS} = 0\text{ Vdc}$, $T_J = 125^\circ\text{C}$)	I_{DSS}	—	—	0.1 15 60	μAdc
Gate-Body Leakage Current ($V_{GS} = \pm 20\text{ Vdc}$, $V_{DS} = 0\text{ Vdc}$)	I_{GSS}	—	—	± 60	μAdc

ON CHARACTERISTICS(1)

Gate-Source Threshold Voltage ($V_{DS} = V_{GS}$, $I_D = 1.0\text{ mA}$)	$V_{GS(th)}$	0.8	—	2.0	Vdc
Static Drain-to-Source On-Resistance ($V_{GS} = 5.0\text{ Vdc}$, $I_D = 100\text{ mA}$)	$r_{DS(on)}$	—	5.0	10	Ohms
Transfer Admittance ($V_{DS} = 25\text{ Vdc}$, $I_D = 100\text{ mA}$, $f = 1.0\text{ kHz}$)	$ y_{fs} $	50	—	—	mS

DYNAMIC CHARACTERISTICS

Input Capacitance	($V_{DS} = 5.0\text{ Vdc}$)	C_{iss}	—	30	—	pF
Output Capacitance	($V_{DS} = 5.0\text{ Vdc}$)	C_{oss}	—	10	—	
Transfer Capacitance	($V_{DG} = 5.0\text{ Vdc}$)	C_{rss}	—	5.0	—	

SWITCHING CHARACTERISTICS(2)

Turn-On Delay Time	$(V_{DD} = -15\text{ Vdc}$, $I_D = -2.5\text{ Adc}$, $R_L = 50\ \Omega)$	$t_{d(on)}$	—	2.5	—	ns
Rise Time		t_r	—	1.0	—	
Turn-Off Delay Time		$t_{d(off)}$	—	16	—	
Fall Time		t_f	—	8.0	—	
Gate Charge		Q_T	—	6000	—	pC

SOURCE-DRAIN DIODE CHARACTERISTICS

Continuous Current	I_S	—	—	0.130	A
Pulsed Current	I_{SM}	—	—	0.520	
Forward Voltage(2)	V_{SD}	—	2.5	—	V

(1) Pulse Test: Pulse Width $\leq 300\ \mu\text{s}$, Duty Cycle $\leq 2\%$.

(2) Switching characteristics are independent of operating junction temperature.

TYPICAL ELECTRICAL CHARACTERISTICS

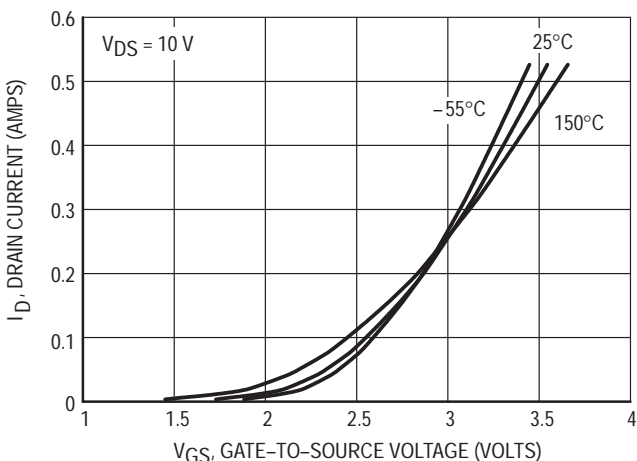


Figure 1. Transfer Characteristics

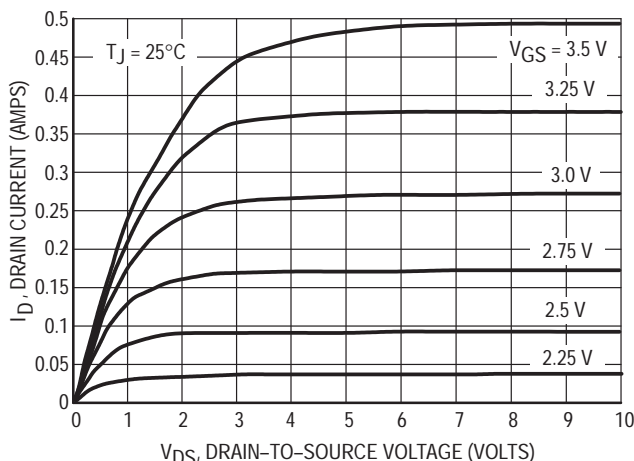


Figure 2. On-Region Characteristics

BSS84LT1

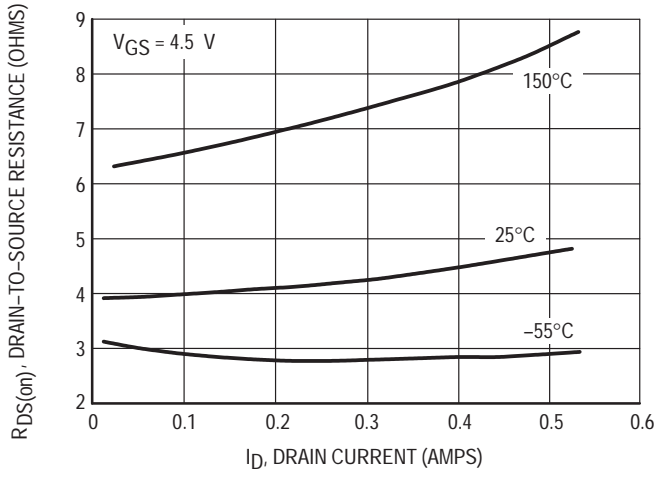


Figure 3. On-Resistance versus Drain Current

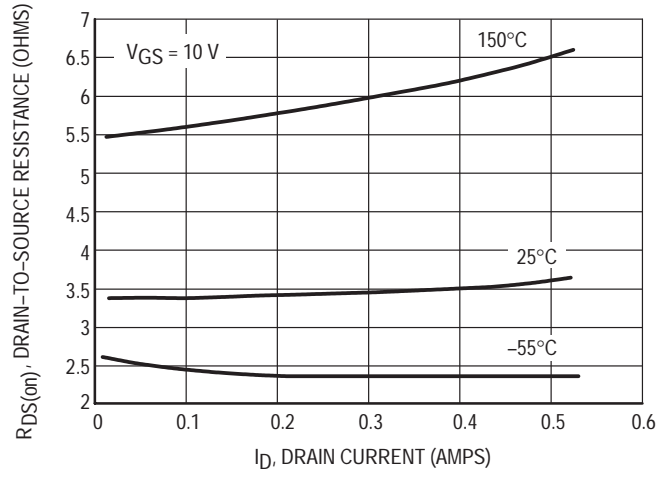


Figure 4. On-Resistance versus Drain Current

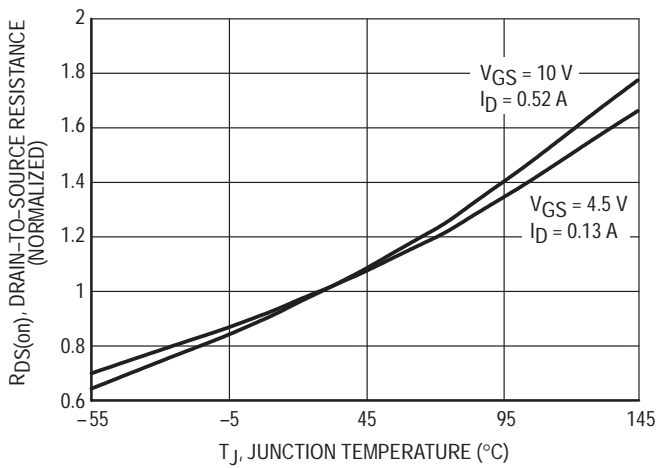


Figure 5. On-Resistance Variation with Temperature

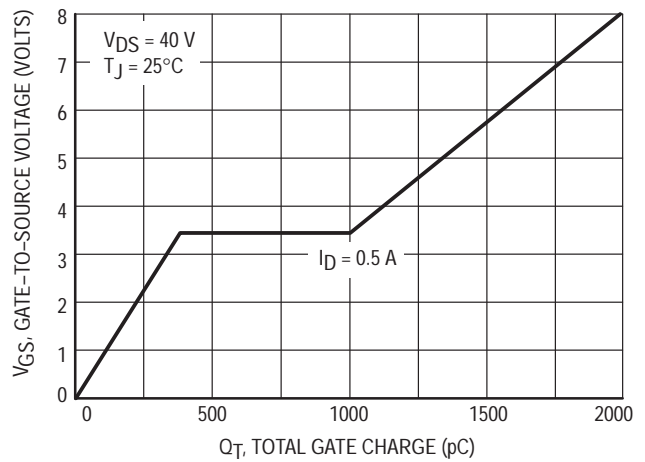


Figure 6. Gate Charge

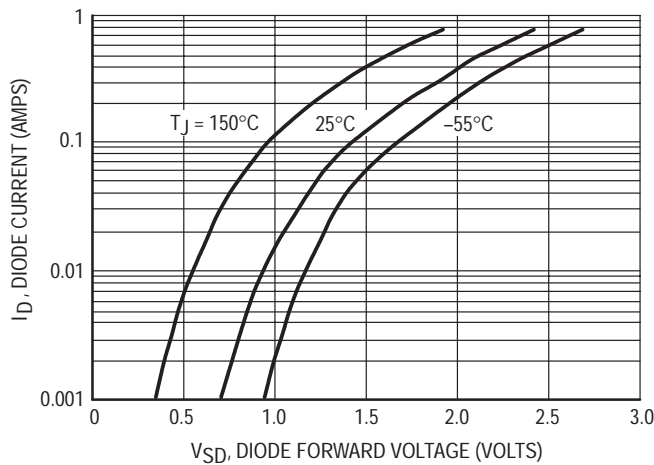


Figure 7. Body Diode Forward Voltage



BSS138LT1

Motorola Preferred Device

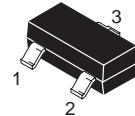
**N-Channel Enhancement Mode
Logic Level SOT-23 MOSFET**

Typical applications are dc–dc converters, power management in portable and battery–powered products such as computers, printers, PCMCIA cards, cellular and cordless telephones.

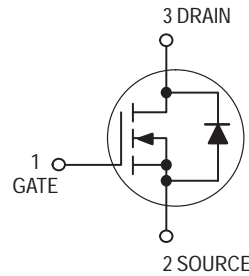
- Low Threshold Voltage ($V_{GS(th)}$: 0.5V...1.5V) makes it ideal for low voltage applications
- Miniature SOT–23 Surface Mount Package saves board space



**N-CHANNEL
LOGIC LEVEL
TMOS FET
TRANSISTOR**



**CASE 318–08, Style 21
SOT–23 (TO–236A)**



MAXIMUM RATINGS ($T_A = 25^\circ\text{C}$ unless otherwise noted)

Rating	Symbol	Value	Unit
Drain–to–Source Voltage	V_{DSS}	50	Vdc
Gate–to–Source Voltage — Continuous	V_{GS}	± 20	Vdc
Drain Current — Continuous @ $T_A = 25^\circ\text{C}$ — Pulsed Drain Current ($t_p \leq 10 \mu\text{s}$)	I_D I_{DM}	200 800	mA
Total Power Dissipation @ $T_A = 25^\circ\text{C}$	P_D	225	mW
Operating and Storage Temperature Range	T_J, T_{stg}	– 55 to 150	$^\circ\text{C}$
Thermal Resistance — Junction–to–Ambient	$R_{\theta JA}$	556	$^\circ\text{C}/\text{W}$
Maximum Lead Temperature for Soldering Purposes, for 10 seconds	T_L	260	$^\circ\text{C}$

DEVICE MARKING

BSS138LT1 = J1

ORDERING INFORMATION

Device	Reel Size	Tape Width	Quantity
BSS138LT1	7"	8mm embossed tape	3000
BSS138LT3	13"	8mm embossed tape	10,000

Preferred devices are Motorola recommended choices for future use and best overall value.

BSS138LT1**ELECTRICAL CHARACTERISTICS** ($T_A = 25^\circ\text{C}$ unless otherwise noted)

Characteristic	Symbol	Min	Typ	Max	Unit
----------------	--------	-----	-----	-----	------

OFF CHARACTERISTICS

Drain-to-Source Breakdown Voltage ($V_{GS} = 0\text{ Vdc}$, $I_D = 250\ \mu\text{Adc}$)	$V_{(BR)DSS}$	50	—	—	Vdc
Zero Gate Voltage Drain Current ($V_{DS} = 25\text{ Vdc}$, $V_{GS} = 0\text{ Vdc}$) ($V_{DS} = 50\text{ Vdc}$, $V_{GS} = 0\text{ Vdc}$)	I_{DSS}	— —	— —	0.1 0.5	μAdc
Gate-Source Leakage Current ($V_{GS} = \pm 20\text{ Vdc}$, $V_{DS} = 0\text{ Vdc}$)	I_{GSS}	—	—	± 0.1	μAdc

ON CHARACTERISTICS(1)

Gate-Source Threshold Voltage ($V_{DS} = V_{GS}$, $I_D = 1.0\text{ mAdc}$)	$V_{GS(th)}$	0.5	—	1.5	Vdc
Static Drain-to-Source On-Resistance ($V_{GS} = 2.75\text{ Vdc}$, $I_D < 200\text{ mAdc}$, $T_A = -40^\circ\text{C}$ to $+85^\circ\text{C}$) ($V_{GS} = 5.0\text{ Vdc}$, $I_D = 200\text{ mAdc}$)	$r_{DS(on)}$	— —	5.6 —	10 3.5	Ohms
Forward Transconductance ($V_{DS} = 25\text{ Vdc}$, $I_D = 200\text{ mAdc}$, $f = 1.0\text{ kHz}$)	g_{fs}	100	—	—	mmhos

DYNAMIC CHARACTERISTICS

Input Capacitance	($V_{DS} = 25\text{ Vdc}$, $V_{GS} = 0$, $f = 1\text{ MHz}$)	C_{iss}	—	40	50	pF
Output Capacitance	($V_{DS} = 25\text{ Vdc}$, $V_{GS} = 0$, $f = 1\text{ MHz}$)	C_{oss}	—	12	25	
Transfer Capacitance	($V_{DG} = 25\text{ Vdc}$, $V_{GS} = 0$, $f = 1\text{ MHz}$)	C_{rss}	—	3.5	5.0	

SWITCHING CHARACTERISTICS(2)

Turn-On Delay Time	(V _{DD} = 30 Vdc, I _D = 0.2 Adc,)	$t_{d(on)}$	—	—	20	ns
Turn-Off Delay Time		$t_{d(off)}$	—	—	20	

(1) Pulse Test: Pulse Width $\leq 300\ \mu\text{s}$, Duty Cycle $\leq 2\%$.

(2) Switching characteristics are independent of operating junction temperature.

TYPICAL ELECTRICAL CHARACTERISTICS

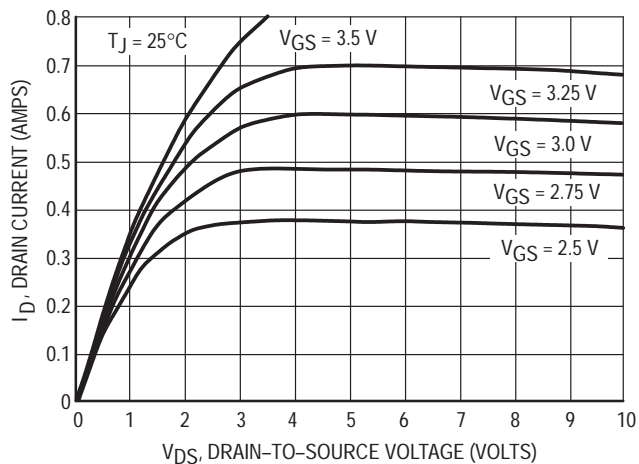


Figure 1. On-Region Characteristics

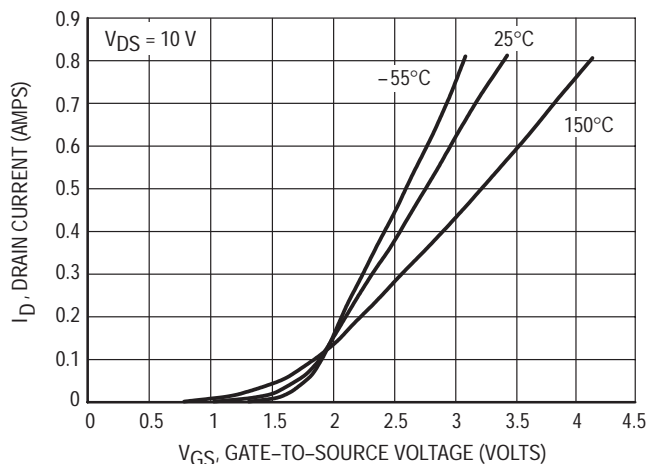


Figure 2. Transfer Characteristics

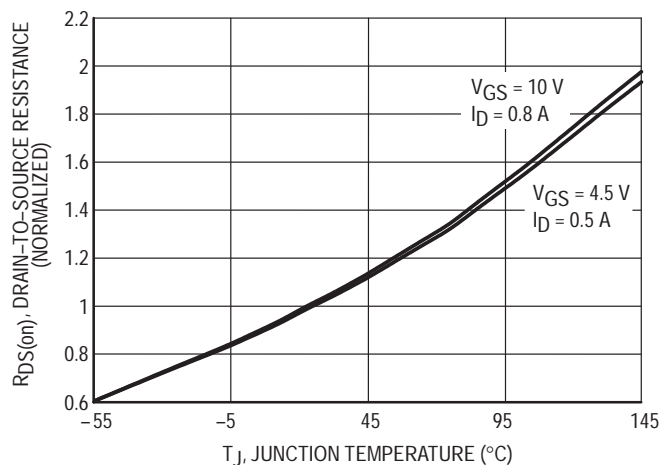


Figure 3. On-Resistance Variation with Temperature

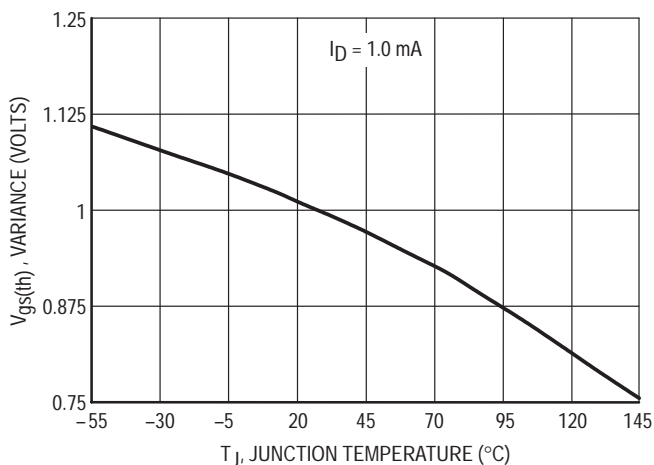


Figure 4. Threshold Voltage Variation with Temperature

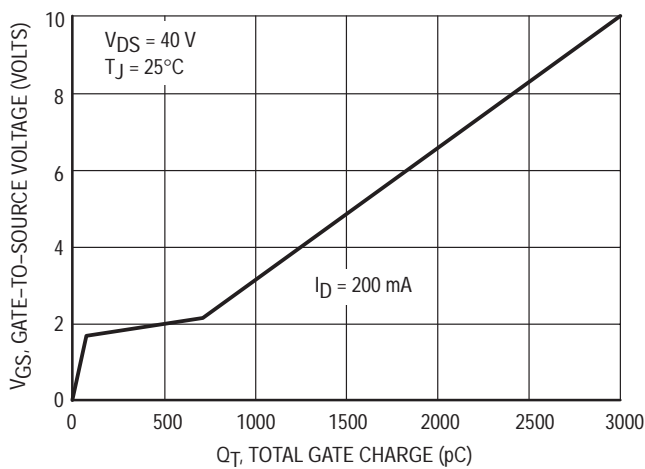


Figure 5. Gate Charge

BSS138LT1

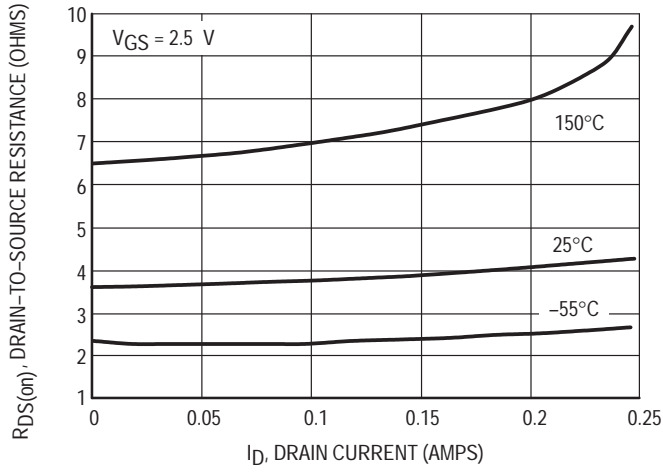


Figure 6. On-Resistance versus Drain Current

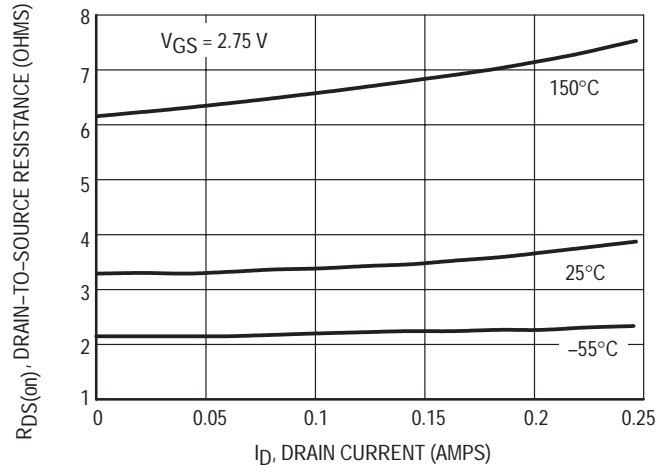


Figure 7. On-Resistance versus Drain Current

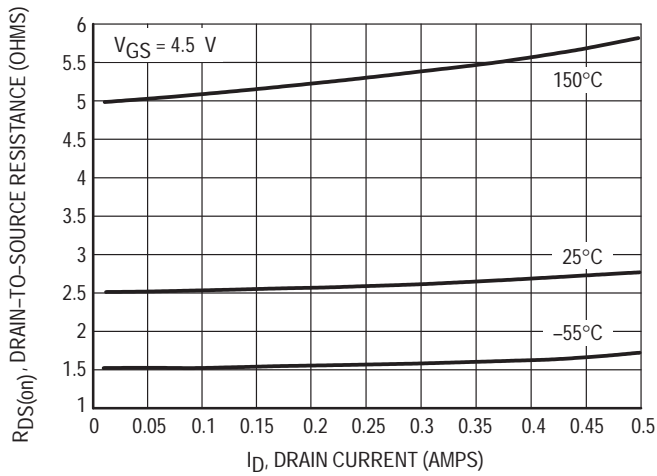


Figure 8. On-Resistance versus Drain Current

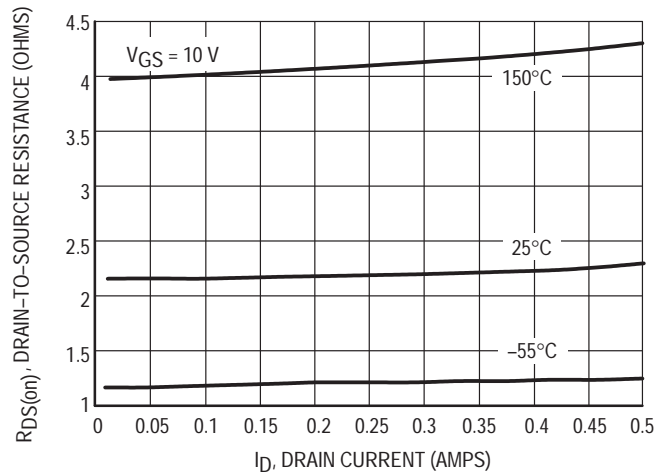


Figure 9. On-Resistance versus Drain Current

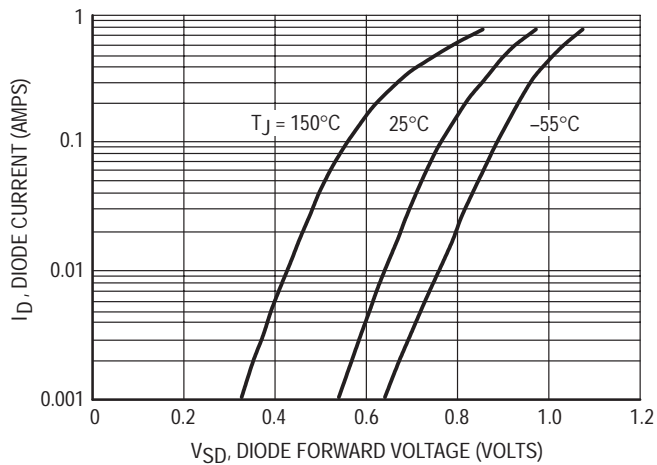


Figure 10. Body Diode Forward Voltage

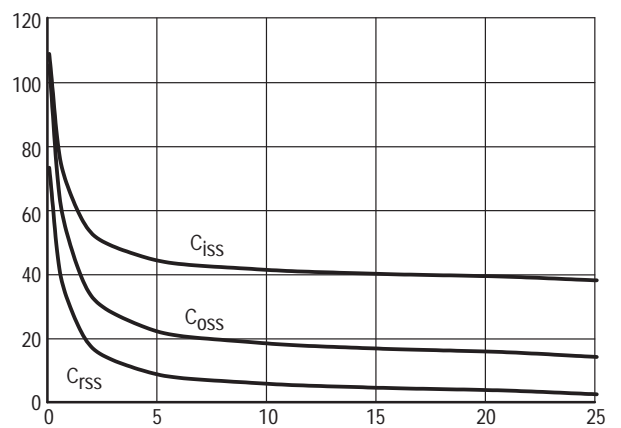


Figure 11. Capacitance

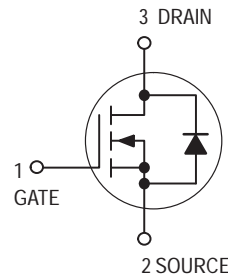


Low $r_{DS(on)}$ Small-Signal MOSFETs TMOS Single N-Channel Field Effect Transistors

Part of the GreenLine™ Portfolio of devices with energy-conserving traits.

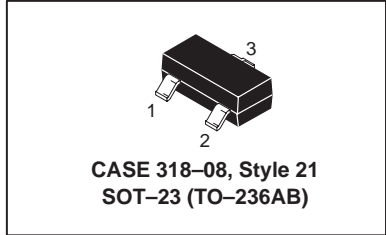
These miniature surface mount MOSFETs utilize Motorola's High Cell Density, HDTMOS process. Low $r_{DS(on)}$ assures minimal power loss and conserves energy, making this device ideal for use in space sensitive power management circuitry. Typical applications are dc-dc converters and power management in portable and battery-powered products such as computers, printers, PCMCIA cards, cellular and cordless telephones.

- Low $r_{DS(on)}$ Provides Higher Efficiency and Extends Battery Life
- Miniature SOT-23 Surface Mount Package Saves Board Space



MGSF1N02LT1
Motorola Preferred Device

**N-CHANNEL
ENHANCEMENT-MODE
TMOS MOSFET**



MAXIMUM RATINGS ($T_J = 25^\circ\text{C}$ unless otherwise noted)

Rating	Symbol	Value	Unit
Drain-to-Source Voltage	V_{DS}	20	Vdc
Gate-to-Source Voltage — Continuous	V_{GS}	± 20	Vdc
Drain Current — Continuous @ $T_A = 25^\circ\text{C}$ — Pulsed Drain Current ($t_p \leq 10 \mu\text{s}$)	I_D I_{DM}	750 2000	mA
Total Power Dissipation @ $T_A = 25^\circ\text{C}$	P_D	400	mW
Operating and Storage Temperature Range	T_J, T_{stg}	- 55 to 150	$^\circ\text{C}$
Thermal Resistance — Junction-to-Ambient	$R_{\theta JA}$	300	$^\circ\text{C/W}$
Maximum Lead Temperature for Soldering Purposes, 1/8" from case for 10 seconds	T_L	260	$^\circ\text{C}$

Device Marking: NZ

ORDERING INFORMATION

Device	Reel Size	Tape Width	Quantity
MGSF1N02LT1	7"	8mm embossed tape	3000
MGSF1N02LT3	13"	8mm embossed tape	10,000

Preferred devices are Motorola recommended choices for future use and best overall value.

MGSF1N02LT1

ELECTRICAL CHARACTERISTICS (T_A = 25°C unless otherwise noted)

Characteristic	Symbol	Min	Typ	Max	Unit
----------------	--------	-----	-----	-----	------

OFF CHARACTERISTICS

Drain-to-Source Breakdown Voltage (V _{GS} = 0 Vdc, I _D = 10 μAdc)	V _{(BR)DSS}	20	—	—	Vdc
Zero Gate Voltage Drain Current (V _{DS} = 20 Vdc, V _{GS} = 0 Vdc) (V _{DS} = 20 Vdc, V _{GS} = 0 Vdc, T _J = 125°C)	I _{DSS}	—	—	1.0 10	μAdc
Gate-Body Leakage Current (V _{GS} = ± 20 Vdc, V _{DS} = 0 Vdc)	I _{GSS}	—	—	±100	nAdc

ON CHARACTERISTICS(1)

Gate Threshold Voltage (V _{DS} = V _{GS} , I _D = 250 μAdc)	V _{GS(th)}	1.0	1.7	2.4	Vdc
Static Drain-to-Source On-Resistance (V _{GS} = 10 Vdc, I _D = 1.2 Adc) (V _{GS} = 4.5 Vdc, I _D = 1.0 Adc)	r _{DS(on)}	—	0.075 0.115	0.090 0.130	Ohms

DYNAMIC CHARACTERISTICS

Input Capacitance	(V _{DS} = 5.0 Vdc)	C _{iss}	—	125	—	pF
Output Capacitance	(V _{DS} = 5.0 Vdc)	C _{oss}	—	120	—	
Transfer Capacitance	(V _{DG} = 5.0 Vdc)	C _{rss}	—	45	—	

SWITCHING CHARACTERISTICS(2)

Turn-On Delay Time	(V _{DD} = 15 Vdc, I _D = 1.0 Adc, R _L = 50 Ω)	t _{d(on)}	—	2.5	—	ns
Rise Time		t _r	—	1.0	—	
Turn-Off Delay Time		t _{d(off)}	—	16	—	
Fall Time		t _f	—	8.0	—	
Gate Charge (See Figure 6)		Q _T	—	6000	—	pC

SOURCE-DRAIN DIODE CHARACTERISTICS

Continuous Current	I _S	—	—	0.6	A
Pulsed Current	I _{SM}	—	—	0.75	
Forward Voltage(2)	V _{SD}	—	0.8	—	V

(1) Pulse Test: Pulse Width ≤ 300 μs, Duty Cycle ≤ 2%.

(2) Switching characteristics are independent of operating junction temperature.

TYPICAL ELECTRICAL CHARACTERISTICS

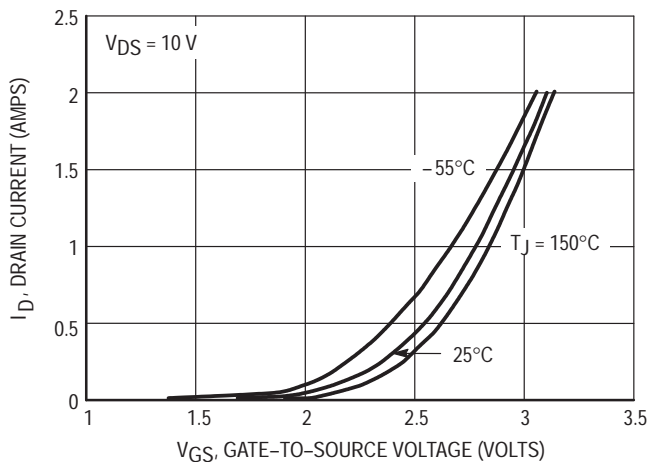


Figure 1. Transfer Characteristics

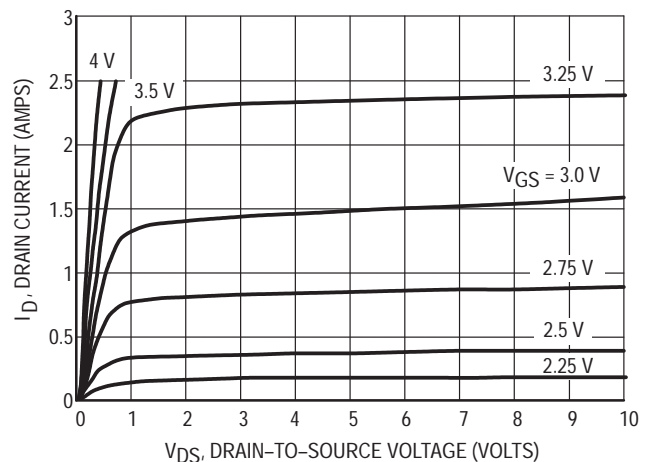


Figure 2. On-Region Characteristics

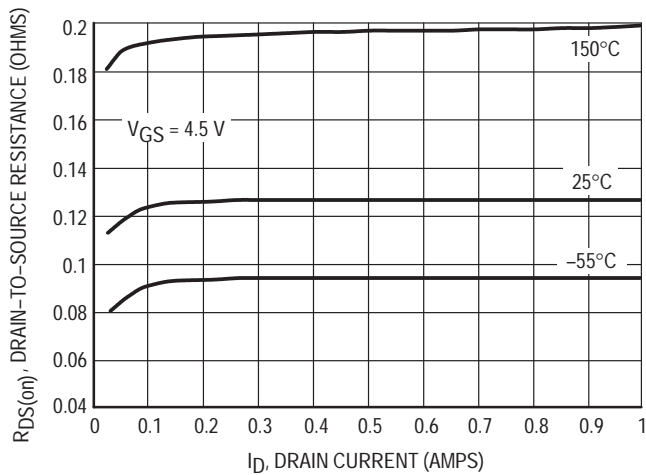


Figure 3. On-Resistance versus Drain Current

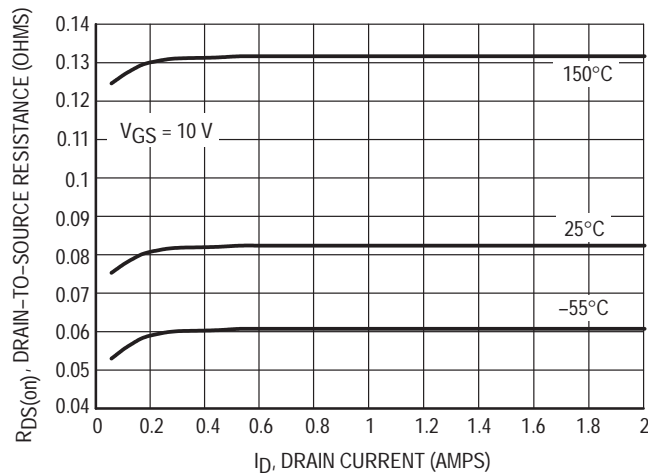


Figure 4. On-Resistance versus Drain Current

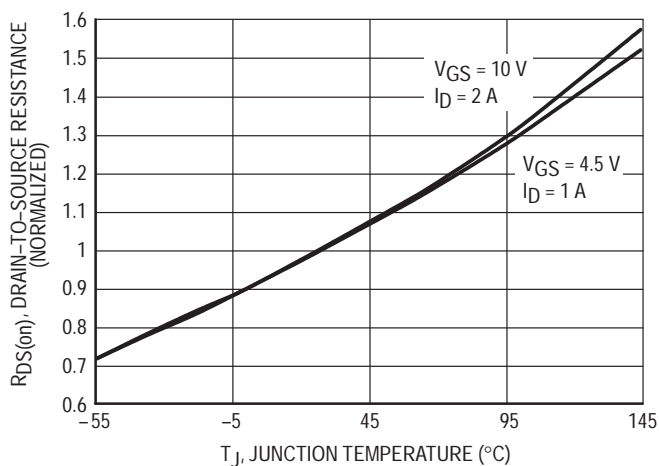


Figure 5. On-Resistance Variation with Temperature

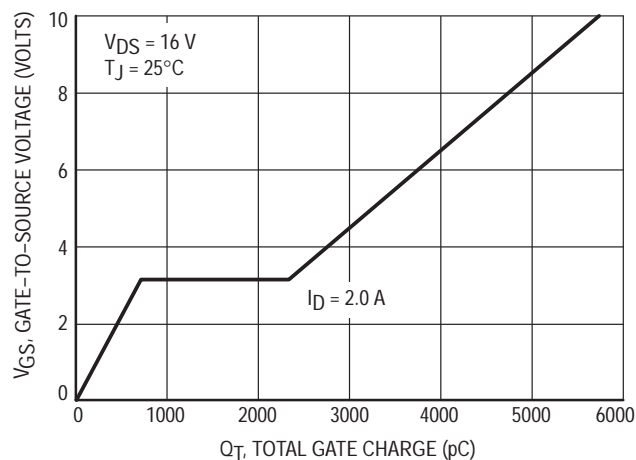


Figure 6. Gate Charge

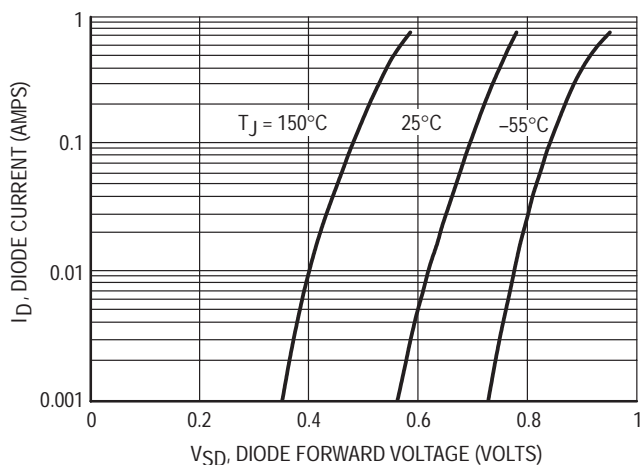


Figure 7. Body Diode Forward Voltage

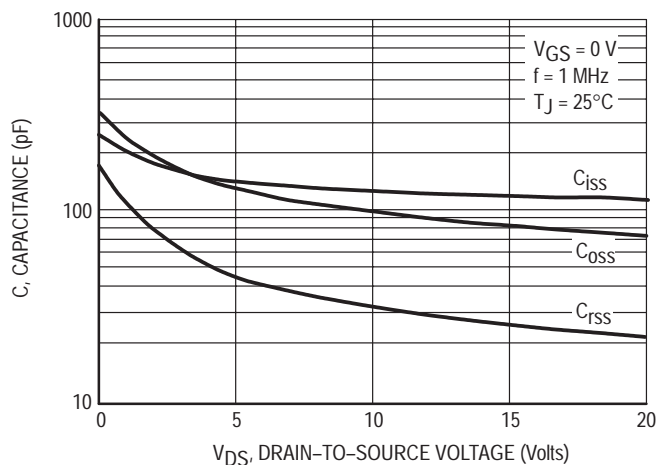


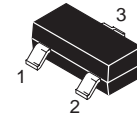
Figure 8. Capacitance



MGSF1N03LT1

Motorola Preferred Device

**N-CHANNEL
ENHANCEMENT-MODE
TMOS MOSFET**



**CASE 318-08, Style 21
SOT-23 (TO-236AB)**

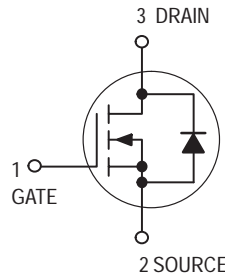
Low $r_{DS(on)}$ Small-Signal MOSFETs

TMOS Single N-Channel Field Effect Transistors

Part of the GreenLine™ Portfolio of devices with energy-conserving traits.

These miniature surface mount MOSFETs utilize Motorola's High Cell Density, HDTMOS process. Low $r_{DS(on)}$ assures minimal power loss and conserves energy, making this device ideal for use in space sensitive power management circuitry. Typical applications are dc-dc converters and power management in portable and battery-powered products such as computers, printers, PCMCIA cards, cellular and cordless telephones.

- Low $r_{DS(on)}$ Provides Higher Efficiency and Extends Battery Life
- Miniature SOT-23 Surface Mount Package Saves Board Space



MAXIMUM RATINGS ($T_J = 25^\circ\text{C}$ unless otherwise noted)

Rating	Symbol	Value	Unit
Drain-to-Source Voltage	V_{DSS}	30	Vdc
Gate-to-Source Voltage — Continuous	V_{GS}	± 20	Vdc
Drain Current — Continuous @ $T_A = 25^\circ\text{C}$ — Pulsed Drain Current ($t_p \leq 10 \mu\text{s}$)	I_D I_{DM}	750 2000	mA
Total Power Dissipation @ $T_A = 25^\circ\text{C}$	P_D	400	mW
Operating and Storage Temperature Range	T_J, T_{stg}	-55 to 150	$^\circ\text{C}$
Thermal Resistance — Junction-to-Ambient	$R_{\theta JA}$	300	$^\circ\text{C/W}$
Maximum Lead Temperature for Soldering Purposes, 1/8" from case for 10 seconds	T_L	260	$^\circ\text{C}$

Device Marking: N3

ORDERING INFORMATION

Device	Reel Size	Tape Width	Quantity
MGSF1N03LT1	7"	8mm embossed tape	3000
MGSF1N03LT3	13"	8mm embossed tape	10,000

Preferred devices are Motorola recommended choices for future use and best overall value.

ELECTRICAL CHARACTERISTICS ($T_A = 25^\circ\text{C}$ unless otherwise noted)

Characteristic	Symbol	Min	Typ	Max	Unit
OFF CHARACTERISTICS					
Drain-to-Source Breakdown Voltage ($V_{GS} = 0\text{ Vdc}$, $I_D = 10\ \mu\text{Adc}$)	$V_{(BR)DSS}$	30	—	—	Vdc
Zero Gate Voltage Drain Current ($V_{DS} = 30\text{ Vdc}$, $V_{GS} = 0\text{ Vdc}$) ($V_{DS} = 30\text{ Vdc}$, $V_{GS} = 0\text{ Vdc}$, $T_J = 125^\circ\text{C}$)	I_{DSS}	—	—	1.0 10	μAdc
Gate-Body Leakage Current ($V_{GS} = \pm 20\text{ Vdc}$, $V_{DS} = 0\text{ Vdc}$)	I_{GSS}	—	—	± 100	nAdc

ON CHARACTERISTICS(1)

Gate Threshold Voltage ($V_{DS} = V_{GS}$, $I_D = 250\ \mu\text{Adc}$)	$V_{GS(th)}$	1.0	1.7	2.4	Vdc
Static Drain-to-Source On-Resistance ($V_{GS} = 10\text{ Vdc}$, $I_D = 1.2\text{ Adc}$) ($V_{GS} = 4.5\text{ Vdc}$, $I_D = 1.0\text{ Adc}$)	$r_{DS(on)}$	—	0.08 0.125	0.10 0.145	Ohms

DYNAMIC CHARACTERISTICS

Input Capacitance	($V_{DS} = 5.0\text{ Vdc}$)	C_{iss}	—	140	—	pF
Output Capacitance	($V_{DS} = 5.0\text{ Vdc}$)	C_{oss}	—	100	—	
Transfer Capacitance	($V_{DG} = 5.0\text{ Vdc}$)	C_{rss}	—	40	—	

SWITCHING CHARACTERISTICS(2)

Turn-On Delay Time	$(V_{DD} = 15\text{ Vdc}$, $I_D = 1.0\text{ Adc}$, $R_L = 50\ \Omega$)	$t_{d(on)}$	—	2.5	—	ns
Rise Time		t_r	—	1.0	—	
Turn-Off Delay Time		$t_{d(off)}$	—	16	—	
Fall Time		t_f	—	8.0	—	
Gate Charge (See Figure 6)		Q_T	—	6000	—	pC

SOURCE-DRAIN DIODE CHARACTERISTICS

Continuous Current	I_S	—	—	0.6	A
Pulsed Current	I_{SM}	—	—	0.75	
Forward Voltage(2)	V_{SD}	—	0.8	—	V

(1) Pulse Test: Pulse Width $\leq 300\ \mu\text{s}$, Duty Cycle $\leq 2\%$.

(2) Switching characteristics are independent of operating junction temperature.

TYPICAL ELECTRICAL CHARACTERISTICS

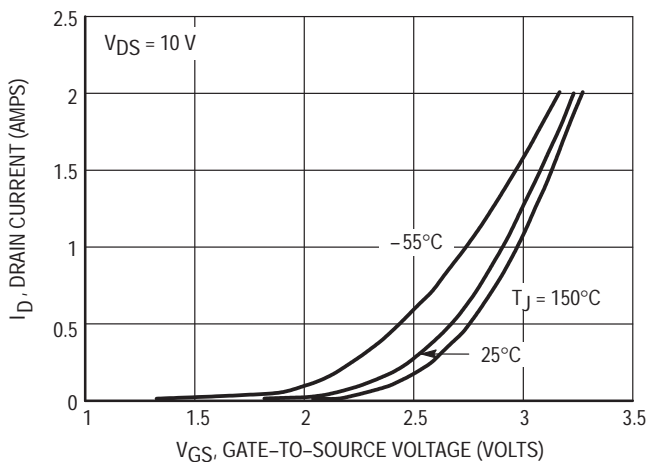


Figure 1. Transfer Characteristics

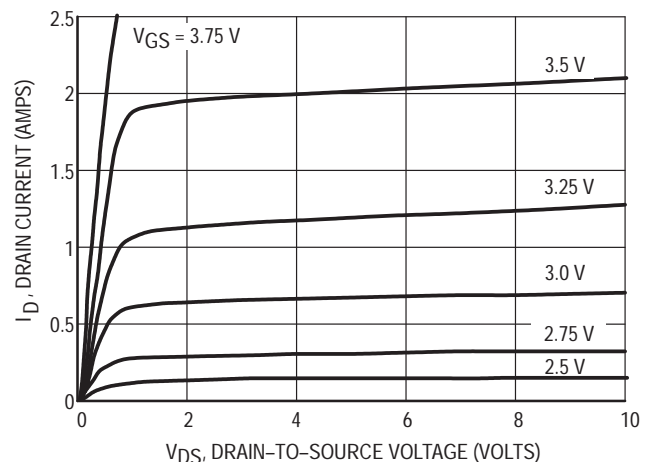


Figure 2. On-Region Characteristics

MGSF1N03LT1

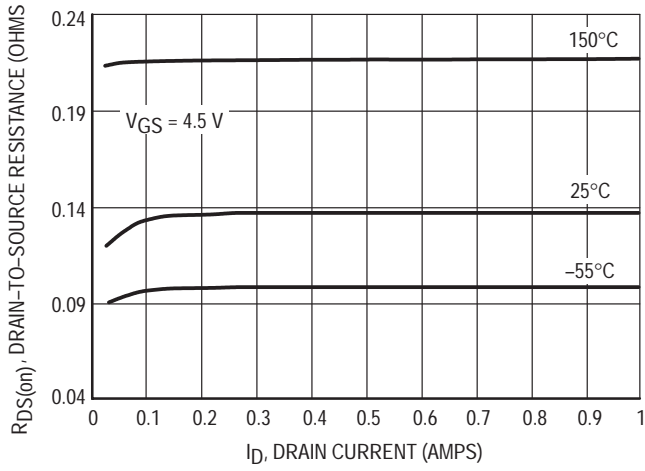


Figure 3. On-Resistance versus Drain Current

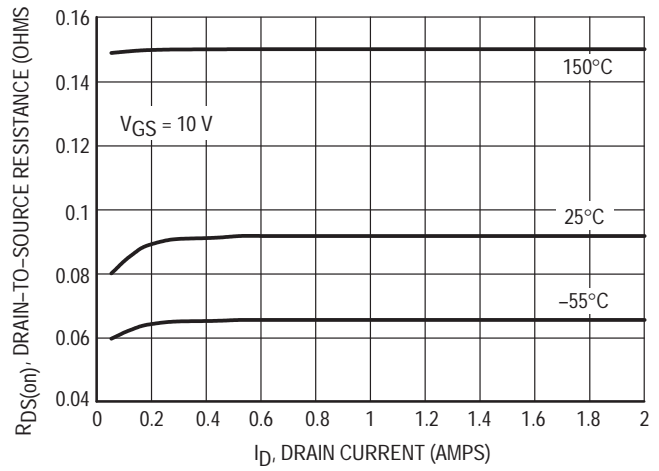


Figure 4. On-Resistance versus Drain Current

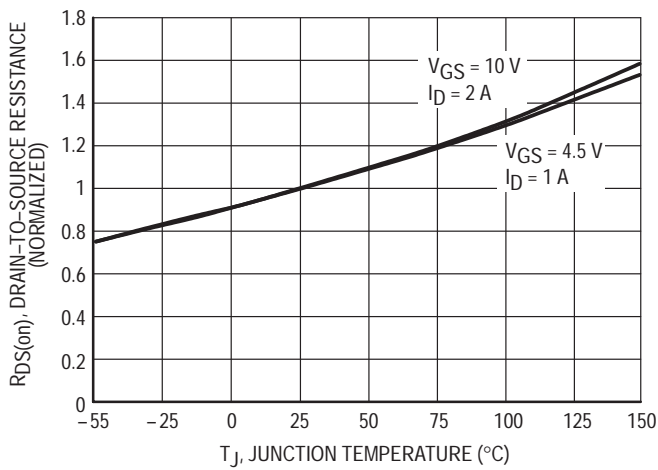


Figure 5. On-Resistance Variation with Temperature

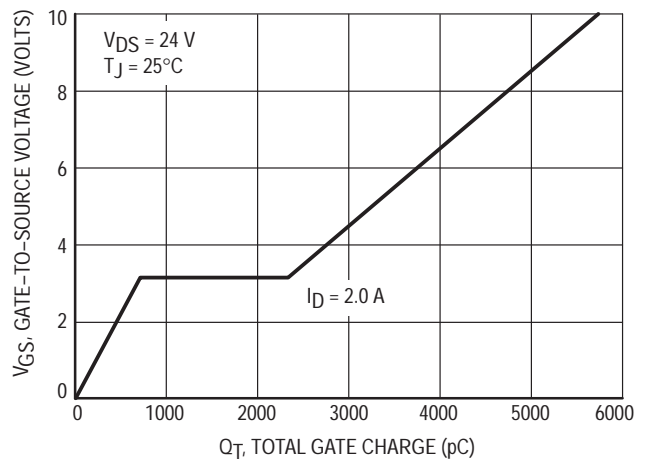


Figure 6. Gate Charge

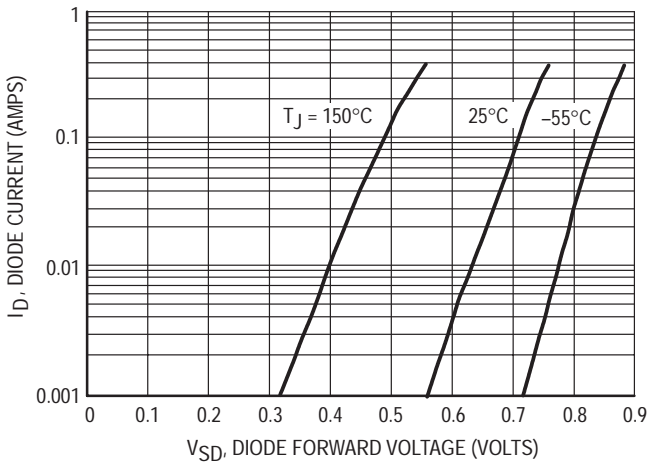


Figure 7. Body Diode Forward Voltage

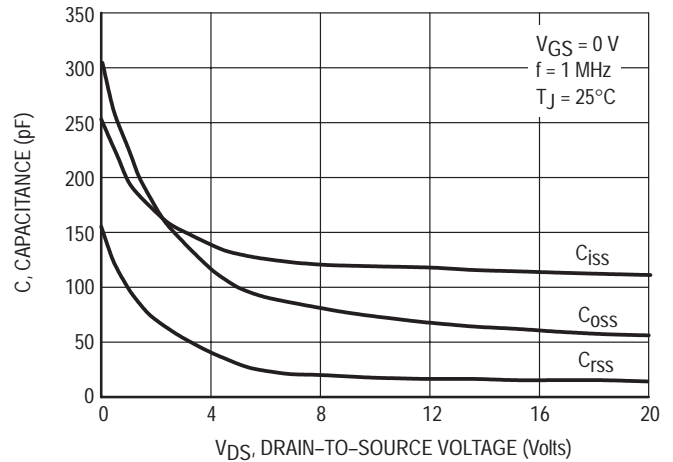


Figure 8. Capacitance



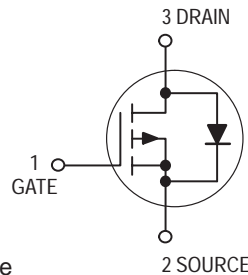
Preliminary Information

**Low $r_{DS(on)}$ Small-Signal MOSFETs
TMOS Single P-Channel
Field Effect Transistors**

Part of the GreenLine™ Portfolio of devices with energy-conserving traits.

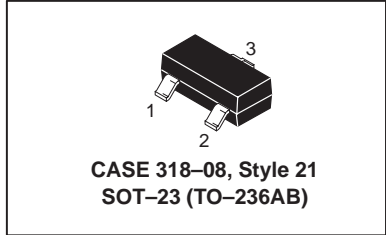
These miniature surface mount MOSFETs utilize Motorola's High Cell Density, HDTMOS process. Low $r_{DS(on)}$ assures minimal power loss and conserves energy, making this device ideal for use in space sensitive power management circuitry. Typical applications are dc-dc converters and power management in portable and battery-powered products such as computers, printers, PCMCIA cards, cellular and cordless telephones.

- Low $r_{DS(on)}$ Provides Higher Efficiency and Extends Battery Life
- Miniature SOT-23 Surface Mount Package Saves Board Space



MGSF1P02ELT1
Motorola Preferred Device

**P-CHANNEL
ENHANCEMENT-MODE
TMOS MOSFET**



MAXIMUM RATINGS ($T_J = 25^\circ\text{C}$ unless otherwise noted)

Rating	Symbol	Value	Unit
Drain-to-Source Voltage	V_{DSS}	20	Vdc
Gate-to-Source Voltage — Continuous	V_{GS}	± 8.0	Vdc
Drain Current — Continuous @ $T_A = 25^\circ\text{C}$ — Pulsed Drain Current ($t_p \leq 10 \mu\text{s}$)	I_D I_{DM}	750 2000	mA
Total Power Dissipation @ $T_A = 25^\circ\text{C}$	P_D	400	mW
Operating and Storage Temperature Range	T_J, T_{stg}	-55 to 150	$^\circ\text{C}$
Thermal Resistance — Junction-to-Ambient	$R_{\theta JA}$	300	$^\circ\text{C/W}$
Maximum Lead Temperature for Soldering Purposes, 1/8" from case for 10 seconds	T_L	260	$^\circ\text{C}$

Device Marking: PC

ORDERING INFORMATION

Device	Reel Size	Tape Width	Quantity
MGSF1P02ELT1	7"	8mm embossed tape	3000
MGSF1P02ELT3	13"	8mm embossed tape	10,000

Preferred devices are Motorola recommended choices for future use and best overall value.

MGSF1P02ELT1

ELECTRICAL CHARACTERISTICS ($T_A = 25^\circ\text{C}$ unless otherwise noted)

Characteristic	Symbol	Min	Typ	Max	Unit
----------------	--------	-----	-----	-----	------

OFF CHARACTERISTICS

Drain-to-Source Breakdown Voltage ($V_{GS} = 0\text{ Vdc}$, $I_D = 250\ \mu\text{Adc}$)	$V_{(BR)DSS}$	20	—	—	Vdc
Zero Gate Voltage Drain Current ($V_{DS} = 16\text{ Vdc}$, $V_{GS} = 0\text{ Vdc}$) ($V_{DS} = 16\text{ Vdc}$, $V_{GS} = 0\text{ Vdc}$, $T_J = 125^\circ\text{C}$)	I_{DSS}	—	—	1.0 10	μAdc
Gate-Body Leakage Current ($V_{GS} = \pm 8.0\text{ Vdc}$, $V_{DS} = 0\text{ Vdc}$)	I_{GSS}	—	—	± 100	nAdc

ON CHARACTERISTICS(1)

Gate Threshold Voltage ($V_{DS} = V_{GS}$, $I_D = 250\ \mu\text{Adc}$)	$V_{GS(th)}$	0.7	0.85	1.2	Vdc
Static Drain-to-Source On-Resistance ($V_{GS} = 4.5\text{ Vdc}$, $I_D = 0.75\text{ Adc}$) ($V_{GS} = 2.5\text{ Vdc}$, $I_D = 0.5\text{ Adc}$)	$r_{DS(on)}$	—	0.20 0.32	0.26 0.50	Ohms

DYNAMIC CHARACTERISTICS

Input Capacitance	($V_{DS} = 5.0\text{ Vdc}$)	C_{iss}	—	130	—	pF
Output Capacitance	($V_{DS} = 5.0\text{ Vdc}$)	C_{oss}	—	120	—	
Transfer Capacitance	($V_{DG} = 5.0\text{ Vdc}$)	C_{rss}	—	60	—	

SWITCHING CHARACTERISTICS(2)

Turn-On Delay Time	$(V_{DD} = 15\text{ Vdc}$, $I_D = 1.0\text{ Adc}$, $R_L = 50\ \Omega)$	$t_{d(on)}$	—	2.5	—	ns
Rise Time		t_r	—	1.0	—	
Turn-Off Delay Time		$t_{d(off)}$	—	16	—	
Fall Time		t_f	—	8.0	—	
Gate Charge (See Figure 6)		Q_T	—	6000	—	pC

SOURCE-DRAIN DIODE CHARACTERISTICS

Continuous Current	I_S	—	—	0.6	A
Pulsed Current	I_{SM}	—	—	0.75	
Forward Voltage(2)	V_{SD}	—	1.5	—	V

(1) Pulse Test: Pulse Width $\leq 300\ \mu\text{s}$, Duty Cycle $\leq 2\%$.

(2) Switching characteristics are independent of operating junction temperature.



MGSF1P02LT1

Motorola Preferred Device

**Low $r_{DS(on)}$ Small-Signal MOSFETs
TMOS Single P-Channel
Field Effect Transistors**

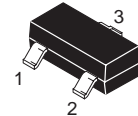
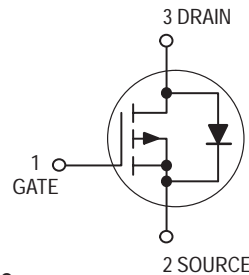
Part of the GreenLine™ Portfolio of devices with energy-conserving traits.

These miniature surface mount MOSFETs utilize Motorola's High Cell Density, HDTMOS process. Low $r_{DS(on)}$ assures minimal power loss and conserves energy, making this device ideal for use in space sensitive power management circuitry. Typical applications are dc-dc converters and power management in portable and battery-powered products such as computers, printers, PCMCIA cards, cellular and cordless telephones.

- Low $r_{DS(on)}$ Provides Higher Efficiency and Extends Battery Life
- Miniature SOT-23 Surface Mount Package Saves Board Space



**P-CHANNEL
ENHANCEMENT-MODE
TMOS MOSFET**



**CASE 318-08, Style 21
SOT-23 (TO-236AB)**

MAXIMUM RATINGS ($T_J = 25^\circ\text{C}$ unless otherwise noted)

Rating	Symbol	Value	Unit
Drain-to-Source Voltage	V_{DSS}	20	Vdc
Gate-to-Source Voltage — Continuous	V_{GS}	± 20	Vdc
Drain Current — Continuous @ $T_A = 25^\circ\text{C}$ — Pulsed Drain Current ($t_p \leq 10 \mu\text{s}$)	I_D I_{DM}	750 2000	mA
Total Power Dissipation @ $T_A = 25^\circ\text{C}$	P_D	400	mW
Operating and Storage Temperature Range	T_J, T_{stg}	-55 to 150	$^\circ\text{C}$
Thermal Resistance — Junction-to-Ambient	$R_{\theta JA}$	300	$^\circ\text{C/W}$
Maximum Lead Temperature for Soldering Purposes, 1/8" from case for 10 seconds	T_L	260	$^\circ\text{C}$

Device Marking: PC

ORDERING INFORMATION

Device	Reel Size	Tape Width	Quantity
MGSF1P02LT1	7"	8mm embossed tape	3000
MGSF1P02LT3	13"	8mm embossed tape	10,000

Preferred devices are Motorola recommended choices for future use and best overall value.

MGSF1P02LT1

ELECTRICAL CHARACTERISTICS (T_A = 25°C unless otherwise noted)

Characteristic	Symbol	Min	Typ	Max	Unit
----------------	--------	-----	-----	-----	------

OFF CHARACTERISTICS

Drain-to-Source Breakdown Voltage (V _{GS} = 0 Vdc, I _D = 10 μAdc)	V _{(BR)DSS}	20	—	—	Vdc
Zero Gate Voltage Drain Current (V _{DS} = 20 Vdc, V _{GS} = 0 Vdc) (V _{DS} = 20 Vdc, V _{GS} = 0 Vdc, T _J = 125°C)	I _{DSS}	—	—	1.0 10	μAdc
Gate-Body Leakage Current (V _{GS} = ± 20 Vdc, V _{DS} = 0 Vdc)	I _{GSS}	—	—	±100	nAdc

ON CHARACTERISTICS(1)

Gate Threshold Voltage (V _{DS} = V _{GS} , I _D = 250 μAdc)	V _{GS(th)}	1.0	1.7	2.4	Vdc
Static Drain-to-Source On-Resistance (V _{GS} = 10 Vdc, I _D = 1.5 Adc) (V _{GS} = 4.5 Vdc, I _D = 0.75 Adc)	r _{DS(on)}	—	0.235 0.375	0.350 0.500	Ohms

DYNAMIC CHARACTERISTICS

Input Capacitance	(V _{DS} = 5.0 Vdc)	C _{iss}	—	130	—	pF
Output Capacitance	(V _{DS} = 5.0 Vdc)	C _{oss}	—	120	—	
Transfer Capacitance	(V _{DG} = 5.0 Vdc)	C _{rss}	—	60	—	

SWITCHING CHARACTERISTICS(2)

Turn-On Delay Time	(V _{DD} = 15 Vdc, I _D = 1.0 Adc, R _L = 50 Ω)	t _{d(on)}	—	2.5	—	ns
Rise Time		t _r	—	1.0	—	
Turn-Off Delay Time		t _{d(off)}	—	16	—	
Fall Time		t _f	—	8.0	—	
Gate Charge (See Figure 6)		Q _T	—	6000	—	pC

SOURCE-DRAIN DIODE CHARACTERISTICS

Continuous Current	I _S	—	—	0.6	A
Pulsed Current	I _{SM}	—	—	0.75	
Forward Voltage(2)	V _{SD}	—	1.5	—	V

(1) Pulse Test: Pulse Width ≤ 300 μs, Duty Cycle ≤ 2%.

(2) Switching characteristics are independent of operating junction temperature.

TYPICAL ELECTRICAL CHARACTERISTICS

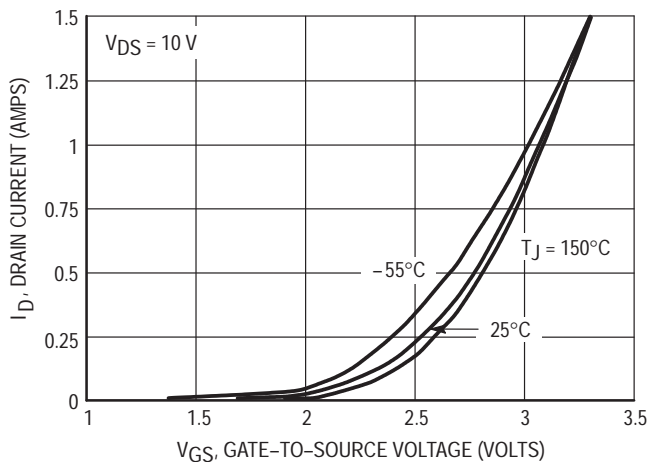


Figure 1. Transfer Characteristics

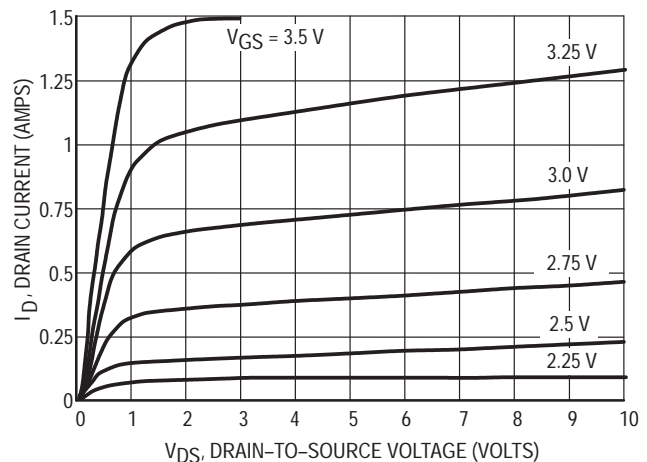


Figure 2. On-Region Characteristics

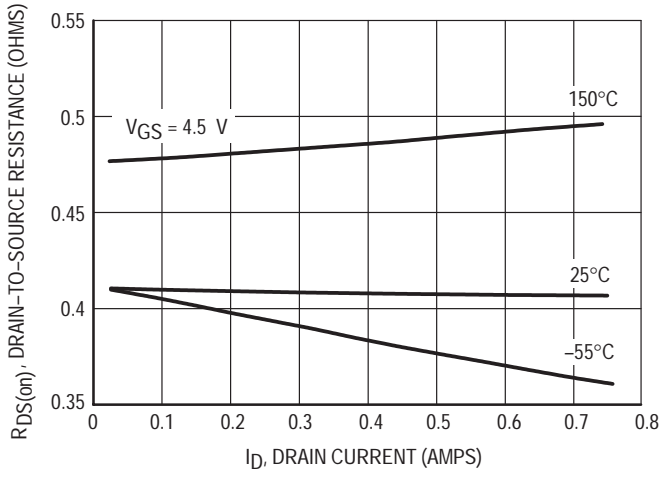


Figure 3. On-Resistance versus Drain Current

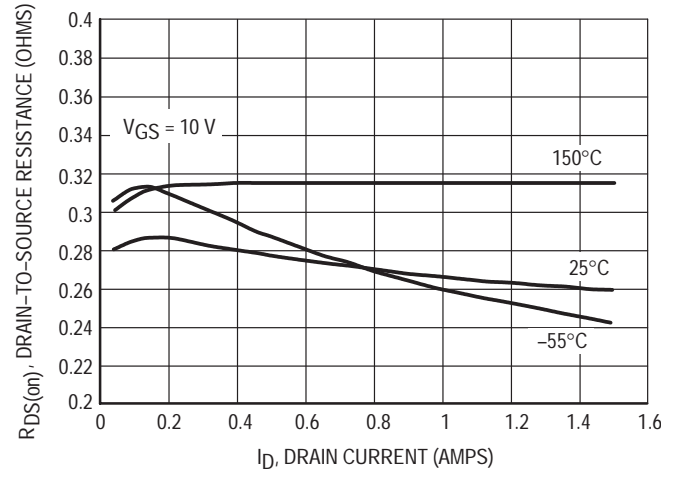


Figure 4. On-Resistance versus Drain Current

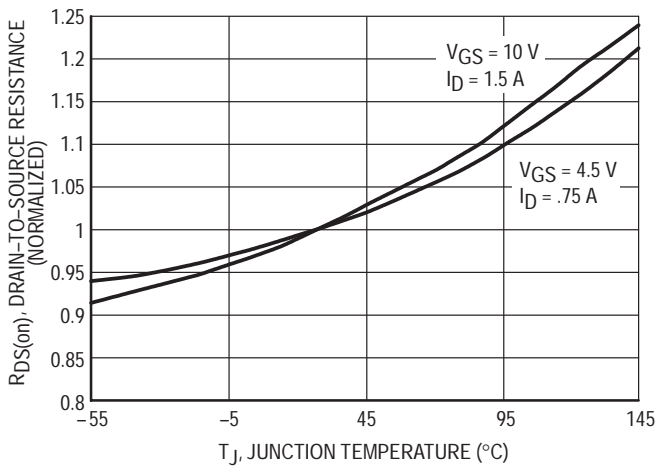


Figure 5. On-Resistance Variation with Temperature

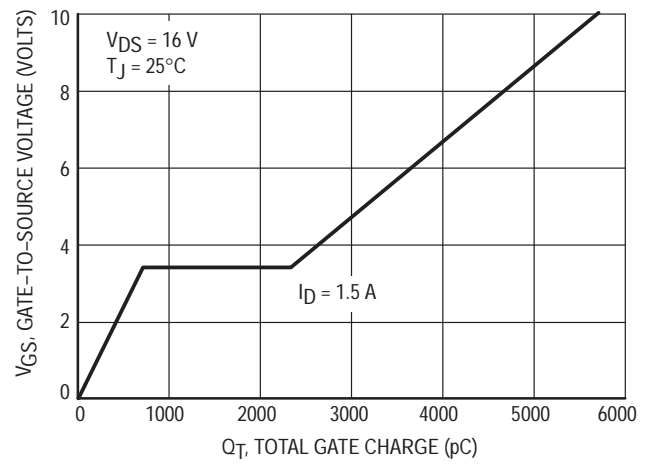


Figure 6. Gate Charge

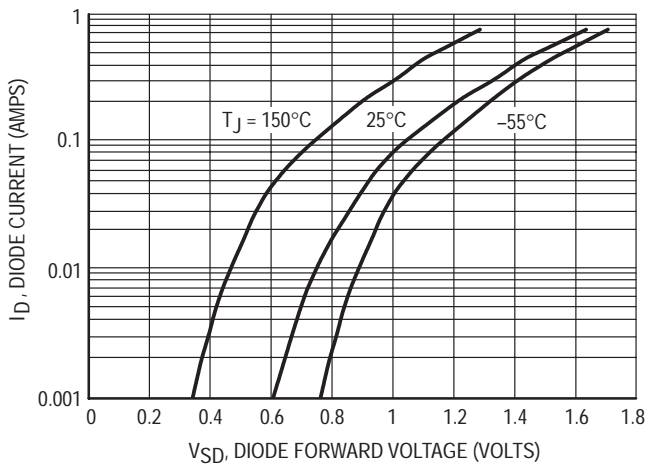


Figure 7. Body Diode Forward Voltage

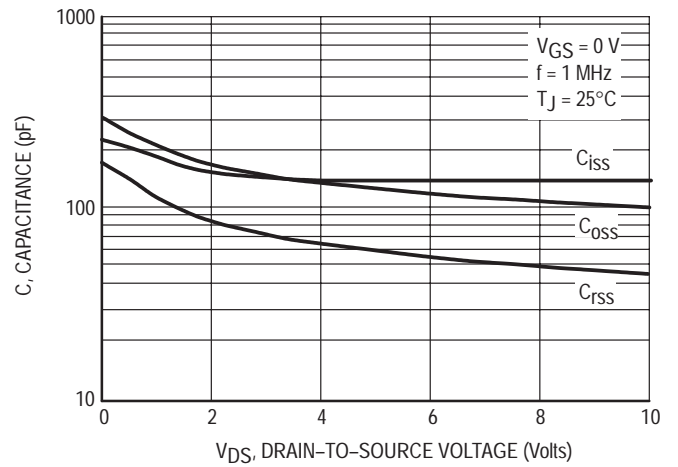


Figure 8. Capacitance



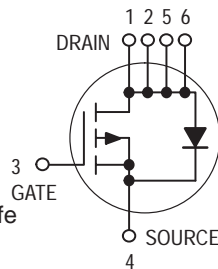
Preliminary Information

Low $r_{DS(on)}$ Small-Signal MOSFETs TMOS Single P-Channel Field Effect Transistors

Part of the GreenLine™ Portfolio of devices with energy-conserving traits.

These miniature surface mount MOSFETs utilize Motorola's High Cell Density, HDTMOS process. Low $r_{DS(on)}$ assures minimal power loss and conserves energy, making this device ideal for use in small power management circuitry. Typical applications are dc-dc converters, power management in portable and battery-powered products such as computers, printers, PCMCIA cards, cellular and cordless telephones.

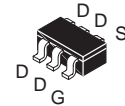
- Low $r_{DS(on)}$ Provides Higher Efficiency and Extends Battery Life
- Miniature TSOP 6 Surface Mount Package Saves Board Space
- Visit our Web Site at <http://www.mot-sps.com/ospd>



MGSF3441VT1

Motorola Preferred Device

P-CHANNEL
ENHANCEMENT-MODE
TMOS MOSFET
 $r_{DS(on)} = 78 \text{ m}\Omega$ (TYP)



CASE 318G-02, Style 1
TSOP 6 PLASTIC

2.5V RATED

MAXIMUM RATINGS ($T_J = 25^\circ\text{C}$ unless otherwise noted)

Rating	Symbol	Value	Unit
Drain-to-Source Voltage	V_{DSS}	20	Vdc
Gate-to-Source Voltage — Continuous	V_{GS}	± 8.0	Vdc
Drain Current — Continuous @ $T_A = 25^\circ\text{C}$ — Pulsed Drain Current ($t_p \leq 10 \mu\text{s}$)	I_D I_{DM}	3.3 20	A
Total Power Dissipation @ $T_A = 25^\circ\text{C}$ Mounted on FR4 $t \leq 5 \text{ sec}$	P_D	2.0	W
Operating and Storage Temperature Range	T_J, T_{stg}	-55 to 150	$^\circ\text{C}$
Thermal Resistance — Junction-to-Ambient	$R_{\theta JA}$	128	$^\circ\text{C/W}$
Maximum Lead Temperature for Soldering Purposes, for 10 seconds	T_L	260	$^\circ\text{C}$

ORDERING INFORMATION

Device	Reel Size	Tape Width	Quantity
MGSF3441VT1	7"	8 mm embossed tape	3000
MGSF3441VT3	13"	8 mm embossed tape	10,000

This document contains information on a product under development. Motorola reserves the right to change or discontinue this product without notice.

Preferred devices are Motorola recommended choices for future use and best overall value.

ELECTRICAL CHARACTERISTICS ($T_A = 25^\circ\text{C}$ unless otherwise noted)

Characteristic	Symbol	Min	Typ	Max	Unit
----------------	--------	-----	-----	-----	------

OFF CHARACTERISTICS

Drain-to-Source Breakdown Voltage ($V_{GS} = 0\text{ Vdc}$, $I_D = 10\ \mu\text{A}$)	$V_{(BR)DSS}$	20	—	—	Vdc
Zero Gate Voltage Drain Current ($V_{DS} = 20\text{ Vdc}$, $V_{GS} = 0\text{ Vdc}$) ($V_{DS} = 20\text{ Vdc}$, $V_{GS} = 0\text{ Vdc}$, $T_J = 70^\circ\text{C}$)	I_{DSS}	—	—	1.0 4.0	μAdc
Gate-Body Leakage Current ($V_{GS} = \pm 8.0\text{ Vdc}$, $V_{DS} = 0$)	I_{GSS}	—	—	± 100	nAdc

ON CHARACTERISTICS(1)

Gate Threshold Voltage ($V_{DS} = V_{GS}$, $I_D = 250\ \mu\text{Adc}$)	$V_{GS(th)}$	0.45	—	—	Vdc
Static Drain-to-Source On-Resistance ($V_{GS} = 4.5\text{ Vdc}$, $I_D = 3.3\text{ A}$) ($V_{GS} = 2.5\text{ Vdc}$, $I_D = 2.9\text{ A}$)	$r_{DS(on)}$	—	0.078 0.110	0.090 0.135	Ohms

DYNAMIC CHARACTERISTICS

Input Capacitance	($V_{DS} = 5.0\text{ V}$)	C_{iss}	—	90	—	pF
Output Capacitance	($V_{DS} = 5.0\text{ V}$)	C_{oss}	—	50	—	
Transfer Capacitance	($V_{DG} = 5.0\text{ V}$)	C_{rss}	—	10	—	

SWITCHING CHARACTERISTICS(2)

Turn-On Delay Time	(V _{DD} = 15 Vdc, I _D = 1.0 A, V _{GEN} = 10 V, R _L = 10 Ω)	$t_{d(on)}$	—	27	50	ns
Rise Time		t_r	—	17	30	
Turn-Off Delay Time		$t_{d(off)}$	—	52	80	
Fall Time		t_f	—	45	70	
Gate Charge		Q_T	—	3000	—	pC

SOURCE-DRAIN DIODE CHARACTERISTICS

Continuous Current	I_S	—	—	1.0	A
Pulsed Current	I_{SM}	—	—	20	A
Forward Voltage ⁽²⁾	V_{SD}	—	0.80	1.2	V

(1) Pulse Test: Pulse Width $\leq 300\ \mu\text{s}$, Duty Cycle $\leq 2\%$.

(2) Switching characteristics are independent of operating junction temperature.

TYPICAL ELECTRICAL CHARACTERISTICS

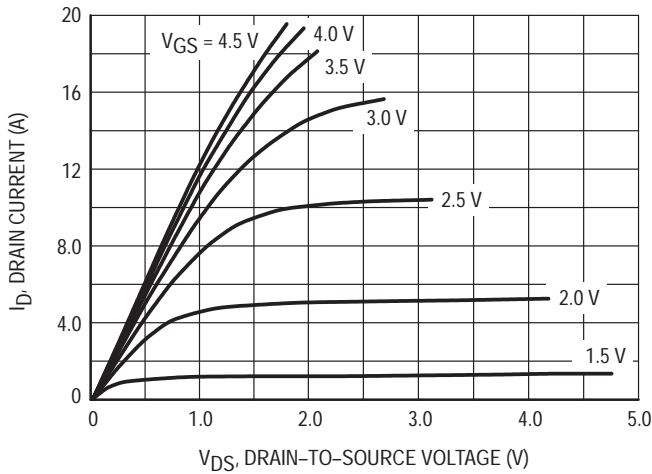


Figure 1. Output Characteristics

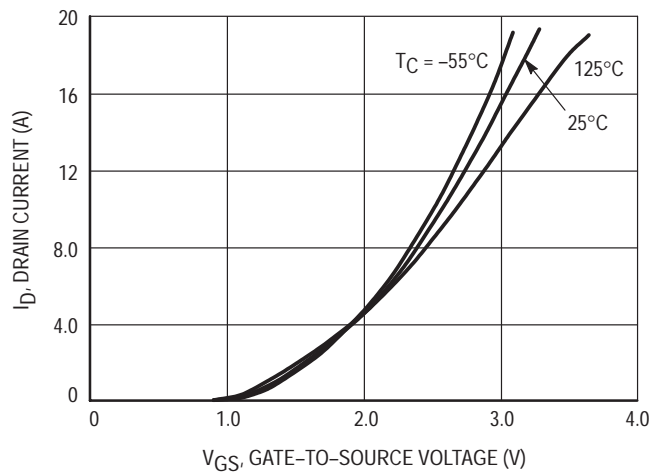


Figure 2. Transfer Characteristics

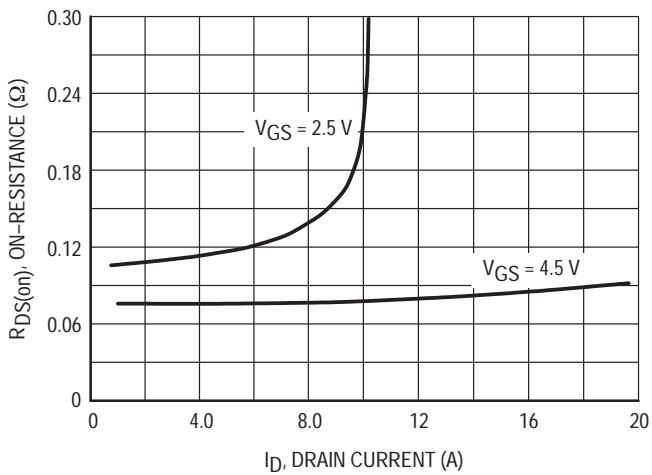


Figure 3. On-Resistance versus Drain Current

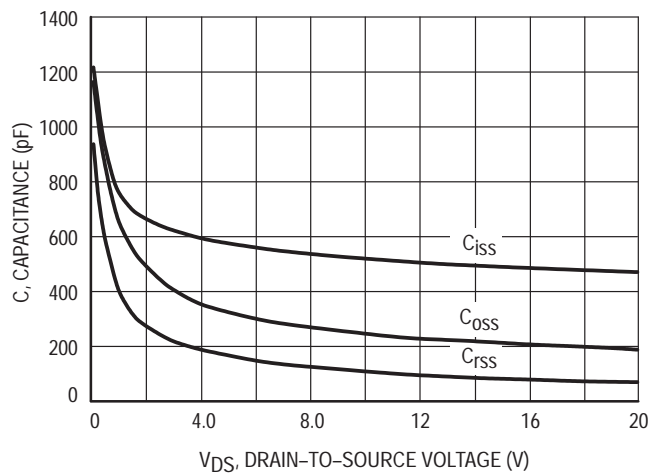


Figure 4. Capacitance

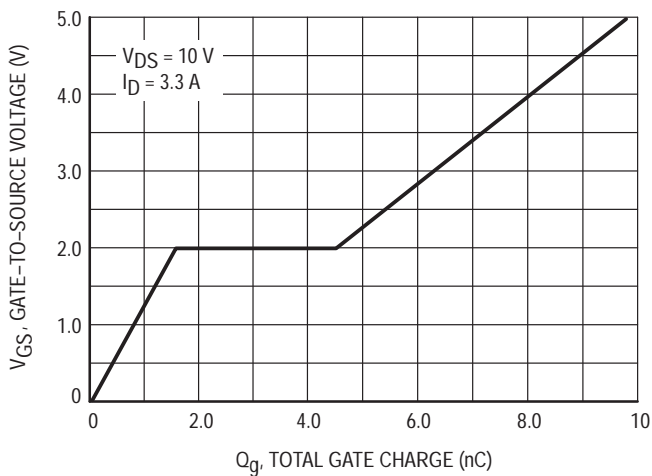


Figure 5. Gate Charge

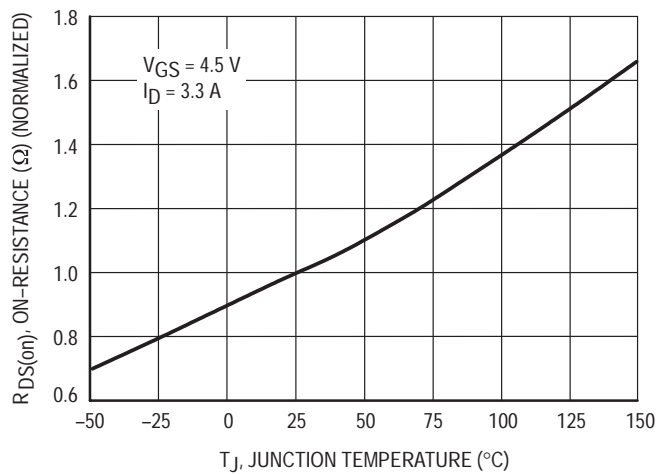


Figure 6. On-Resistance versus Junction Temperature

TYPICAL ELECTRICAL CHARACTERISTICS

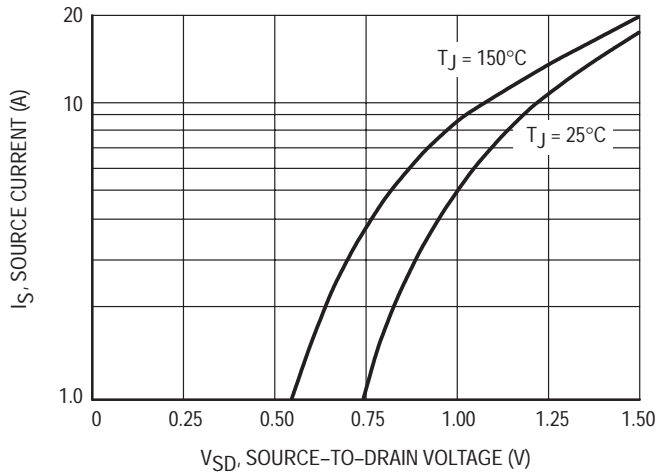


Figure 7. Source-Drain Diode Forward Voltage

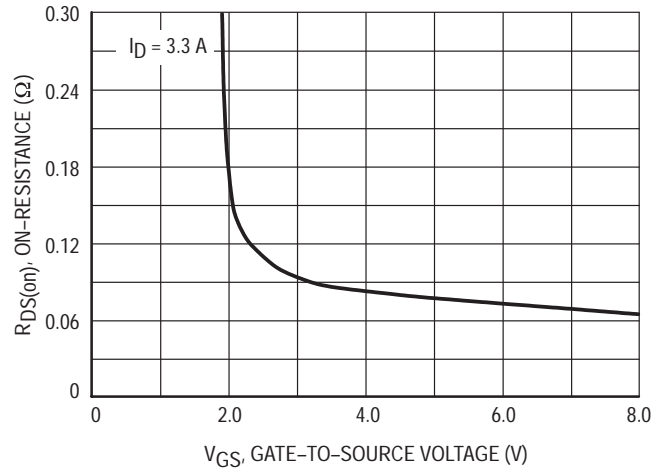


Figure 8. On-Resistance versus Gate-to-Source Voltage

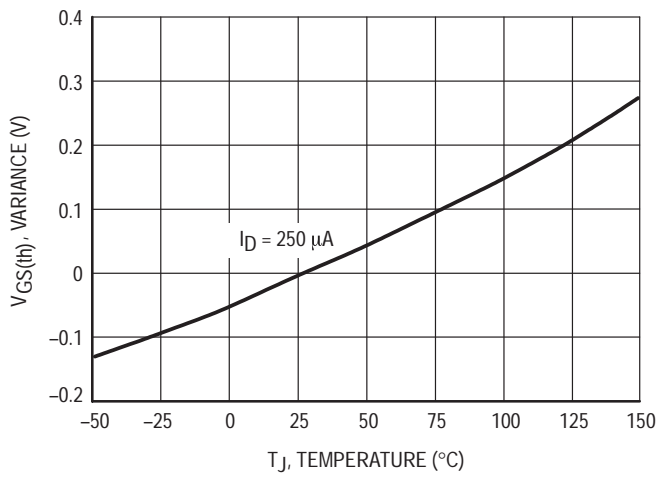


Figure 9. Threshold Voltage

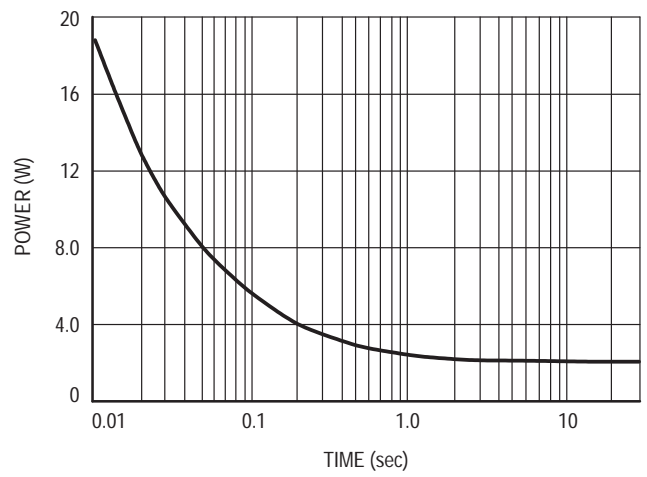


Figure 10. Single Pulse Power

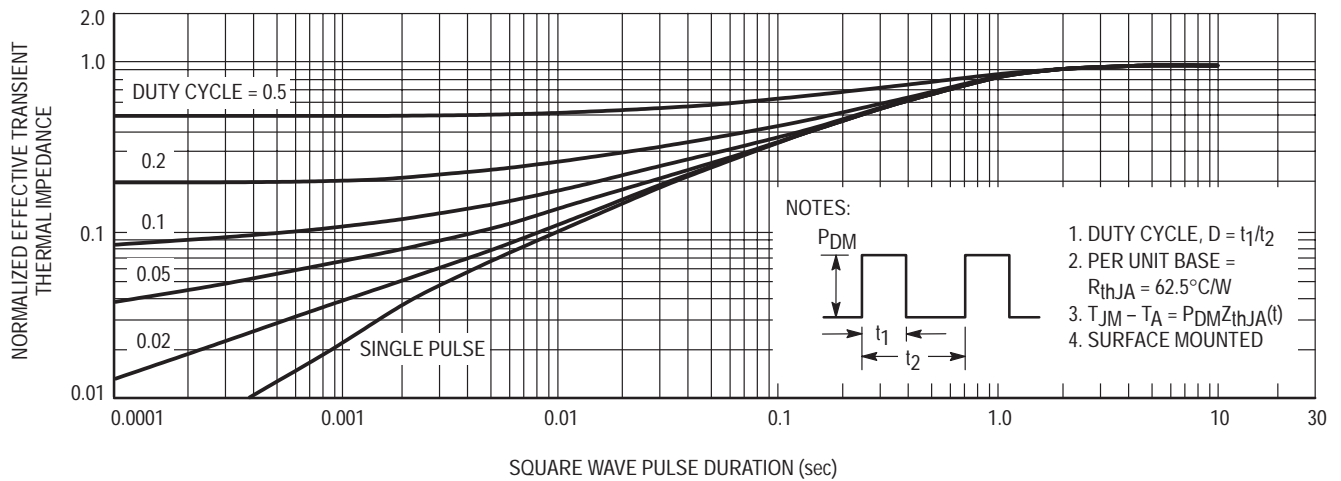


Figure 11. Normalized Thermal Transient Impedance, Junction-to-Ambient



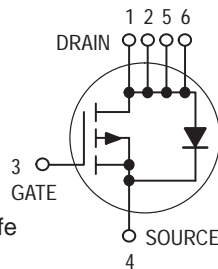
Preliminary Information

Low $r_{DS(on)}$ Small-Signal MOSFETs TMOS Single P-Channel Field Effect Transistors

Part of the GreenLine™ Portfolio of devices with energy-conserving traits.

These miniature surface mount MOSFETs utilize Motorola's High Cell Density, HDTMOS process. Low $r_{DS(on)}$ assures minimal power loss and conserves energy, making this device ideal for use in small power management circuitry. Typical applications are dc-dc converters, power management in portable and battery-powered products such as computers, printers, PCMCIA cards, cellular and cordless telephones.

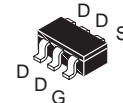
- Low $r_{DS(on)}$ Provides Higher Efficiency and Extends Battery Life
- Miniature TSOP 6 Surface Mount Package Saves Board Space
- Visit our Web Site at <http://www.mot-sps.com/ospd>



MGSF3441XT1

Motorola Preferred Device

P-CHANNEL
ENHANCEMENT-MODE
TMOS MOSFET
 $r_{DS(on)} = 78 \text{ m}\Omega$ (TYP)



CASE 318G-02, Style 1
TSOP 6 PLASTIC

2.5V RATED

MAXIMUM RATINGS ($T_J = 25^\circ\text{C}$ unless otherwise noted)

Rating	Symbol	Value	Unit
Drain-to-Source Voltage	V_{DSS}	20	Vdc
Gate-to-Source Voltage — Continuous	V_{GS}	± 8.0	Vdc
Drain Current — Continuous @ $T_A = 25^\circ\text{C}$ — Pulsed Drain Current ($t_p \leq 10 \mu\text{s}$)	I_D I_{DM}	1.5 20	A
Total Power Dissipation @ $T_A = 25^\circ\text{C}$	P_D	950	mW
Operating and Storage Temperature Range	T_J, T_{stg}	-55 to 150	$^\circ\text{C}$
Thermal Resistance — Junction-to-Ambient	$R_{\theta JA}$	132	$^\circ\text{C}/\text{W}$
Maximum Lead Temperature for Soldering Purposes, for 10 seconds	T_L	260	$^\circ\text{C}$

ORDERING INFORMATION

Device	Reel Size	Tape Width	Quantity
MGSF3441XT1	7"	8 mm embossed tape	3000
MGSF3441XT3	13"	8 mm embossed tape	10,000

This document contains information on a product under development. Motorola reserves the right to change or discontinue this product without notice.

Preferred devices are Motorola recommended choices for future use and best overall value.

ELECTRICAL CHARACTERISTICS ($T_A = 25^\circ\text{C}$ unless otherwise noted)

Characteristic	Symbol	Min	Typ	Max	Unit
----------------	--------	-----	-----	-----	------

OFF CHARACTERISTICS

Drain-to-Source Breakdown Voltage ($V_{GS} = 0 \text{ Vdc}$, $I_D = 10 \mu\text{A}$)	$V_{(BR)DSS}$	20	—	—	Vdc
Zero Gate Voltage Drain Current ($V_{DS} = 20 \text{ Vdc}$, $V_{GS} = 0 \text{ Vdc}$) ($V_{DS} = 20 \text{ Vdc}$, $V_{GS} = 0 \text{ Vdc}$, $T_J = 70^\circ\text{C}$)	I_{DSS}	—	—	1.0 4.0	μAdc
Gate-Body Leakage Current ($V_{GS} = \pm 8.0 \text{ Vdc}$, $V_{DS} = 0$)	I_{GSS}	—	—	± 100	nAdc

ON CHARACTERISTICS(1)

Gate Threshold Voltage ($V_{DS} = V_{GS}$, $I_D = 250 \mu\text{Adc}$)	$V_{GS(th)}$	0.45	—	—	Vdc
Static Drain-to-Source On-Resistance ($V_{GS} = 4.5 \text{ Vdc}$, $I_D = 1.5 \text{ A}$) ($V_{GS} = 2.5 \text{ Vdc}$, $I_D = 1.2 \text{ A}$)	$r_{DS(on)}$	—	0.078 0.110	0.100 0.135	Ohms

DYNAMIC CHARACTERISTICS

Input Capacitance	($V_{DS} = 5.0 \text{ V}$)	C_{iss}	—	90	—	pF
Output Capacitance	($V_{DS} = 5.0 \text{ V}$)	C_{oss}	—	50	—	
Transfer Capacitance	($V_{DG} = 5.0 \text{ V}$)	C_{rss}	—	10	—	

SWITCHING CHARACTERISTICS(2)

Turn-On Delay Time	(V _{DD} = 15 Vdc, I _D = 1.0 A, V _{GEN} = 10 V, R _L = 10 Ω)	$t_{d(on)}$	—	27	50	ns
Rise Time		t_r	—	17	30	
Turn-Off Delay Time		$t_{d(off)}$	—	52	80	
Fall Time		t_f	—	45	70	
Gate Charge		Q_T	—	3000	—	pC

SOURCE-DRAIN DIODE CHARACTERISTICS

Continuous Current	I_S	—	—	1.0	A
Pulsed Current	I_{SM}	—	—	20	A
Forward Voltage ⁽²⁾	V_{SD}	—	0.80	1.2	V

(1) Pulse Test: Pulse Width $\leq 300 \mu\text{s}$, Duty Cycle $\leq 2\%$.

(2) Switching characteristics are independent of operating junction temperature.



Preliminary Information

MGSF3442VT1

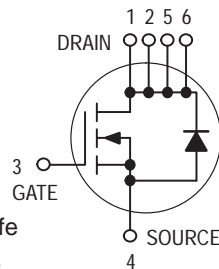
Motorola Preferred Device

**Low $r_{DS(on)}$ Small-Signal MOSFETs
TMOS Single N-Channel
Field Effect Transistors**

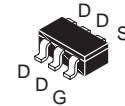
Part of the GreenLine™ Portfolio of devices with energy-conserving traits.

These miniature surface mount MOSFETs utilize Motorola's High Cell Density, HDTMOS process. Low $r_{DS(on)}$ assures minimal power loss and conserves energy, making this device ideal for use in small power management circuitry. Typical applications are dc-dc converters, power management in portable and battery-powered products such as computers, printers, PCMCIA cards, cellular and cordless telephones.

- Low $r_{DS(on)}$ Provides Higher Efficiency and Extends Battery Life
- Miniature TSOP 6 Surface Mount Package Saves Board Space
- Visit our Web Site at <http://www.mot-sps.com/ospd>



N-CHANNEL
ENHANCEMENT-MODE
TMOS MOSFET
 $r_{DS(on)} = 58 \text{ m}\Omega$ (TYP)



CASE 318G-02, Style 1
TSOP 6 PLASTIC

2.5V RATED

MAXIMUM RATINGS ($T_J = 25^\circ\text{C}$ unless otherwise noted)

Rating	Symbol	Value	Unit
Drain-to-Source Voltage	V_{DSS}	20	Vdc
Gate-to-Source Voltage — Continuous	V_{GS}	± 8.0	Vdc
Drain Current — Continuous @ $T_A = 25^\circ\text{C}$ — Pulsed Drain Current ($t_p \leq 10 \mu\text{s}$)	I_D I_{DM}	4.0 20	A
Total Power Dissipation @ $T_A = 25^\circ\text{C}$ Mounted on FR4 $t \leq 5 \text{ sec}$	P_D	2.0	W
Operating and Storage Temperature Range	T_J, T_{stg}	-55 to 150	$^\circ\text{C}$
Thermal Resistance — Junction-to-Ambient	$R_{\theta JA}$	62.5	$^\circ\text{C/W}$
Maximum Lead Temperature for Soldering Purposes, for 10 seconds	T_L	260	$^\circ\text{C}$

ORDERING INFORMATION

Device	Reel Size	Tape Width	Quantity
MGSF3442VT1	7"	8 mm embossed tape	3000
MGSF3442VT3	13"	8 mm embossed tape	10,000

This document contains information on a product under development. Motorola reserves the right to change or discontinue this product without notice.

Preferred devices are Motorola recommended choices for future use and best overall value.

ELECTRICAL CHARACTERISTICS ($T_A = 25^\circ\text{C}$ unless otherwise noted)

Characteristic	Symbol	Min	Typ	Max	Unit
----------------	--------	-----	-----	-----	------

OFF CHARACTERISTICS

Drain-to-Source Breakdown Voltage ($V_{GS} = 0\text{ Vdc}$, $I_D = 10\ \mu\text{A}$)	$V_{(BR)DSS}$	20	—	—	Vdc
Zero Gate Voltage Drain Current ($V_{DS} = 20\text{ Vdc}$, $V_{GS} = 0\text{ Vdc}$) ($V_{DS} = 20\text{ Vdc}$, $V_{GS} = 0\text{ Vdc}$, $T_J = 70^\circ\text{C}$)	I_{DSS}	—	—	1.0 5.0	μAdc
Gate-Body Leakage Current ($V_{GS} = \pm 8.0\text{ Vdc}$, $V_{DS} = 0$)	I_{GSS}	—	—	± 100	nAdc

ON CHARACTERISTICS(1)

Gate Threshold Voltage ($V_{DS} = V_{GS}$, $I_D = 250\ \mu\text{Adc}$)	$V_{GS(th)}$	0.6	—	—	Vdc
Static Drain-to-Source On-Resistance ($V_{GS} = 4.5\text{ Vdc}$, $I_D = 4.0\text{ A}$) ($V_{GS} = 2.5\text{ Vdc}$, $I_D = 3.4\text{ A}$)	$r_{DS(on)}$	—	0.058 0.072	0.070 0.095	Ohms

DYNAMIC CHARACTERISTICS

Input Capacitance	($V_{DS} = 5.0\text{ V}$)	C_{iss}	—	90	—	pF
Output Capacitance	($V_{DS} = 5.0\text{ V}$)	C_{oss}	—	50	—	
Transfer Capacitance	($V_{DG} = 5.0\text{ V}$)	C_{rss}	—	10	—	

SWITCHING CHARACTERISTICS(2)

Turn-On Delay Time	(V _{DD} = 10 Vdc, I _D = 1.0 A, V _{GEN} = 10 V, R _L = 10 Ω)	$t_{d(on)}$	—	8.0	20	ns
Rise Time		t_r	—	24	40	
Turn-Off Delay Time		$t_{d(off)}$	—	36	60	
Fall Time		t_f	—	10	20	
Gate Charge		Q_T	—	—	—	nC

SOURCE-DRAIN DIODE CHARACTERISTICS

Continuous Current	I_S	—	—	1.0	A
Pulsed Current	I_{SM}	—	—	5.0	A
Forward Voltage ⁽²⁾	V_{SD}	—	—	1.2	V

(1) Pulse Test: Pulse Width $\leq 300\ \mu\text{s}$, Duty Cycle $\leq 2\%$.

(2) Switching characteristics are independent of operating junction temperature.

TYPICAL ELECTRICAL CHARACTERISTICS

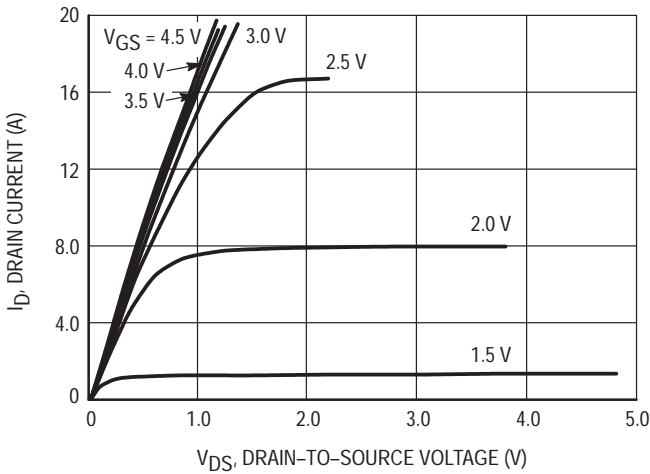


Figure 1. Output Characteristics

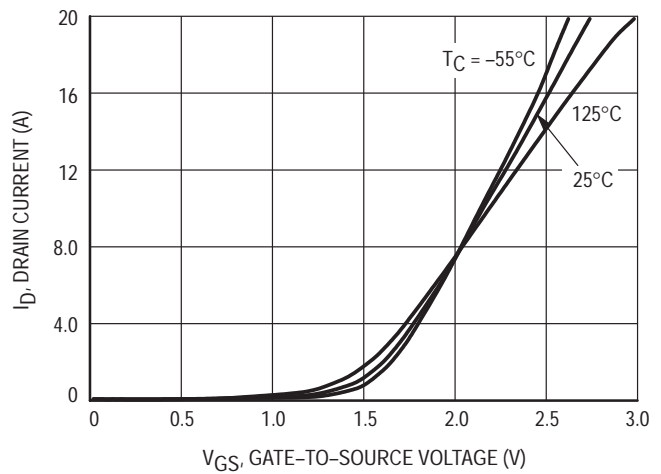


Figure 2. Transfer Characteristics

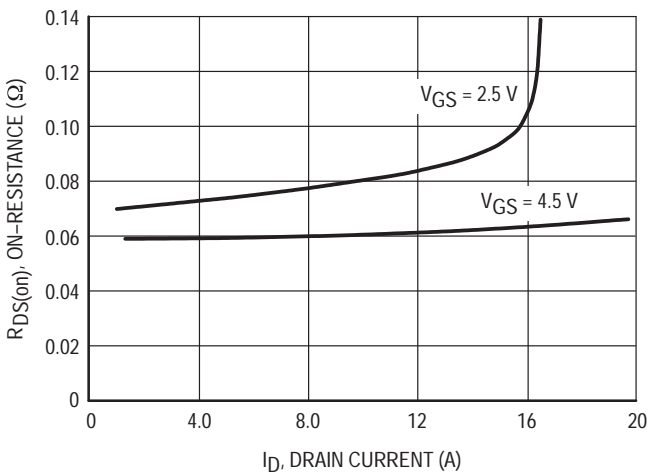


Figure 3. On-Resistance versus Drain Current

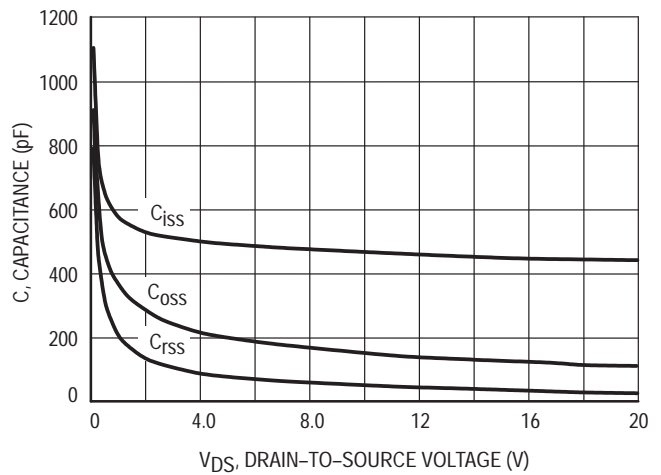


Figure 4. Capacitance

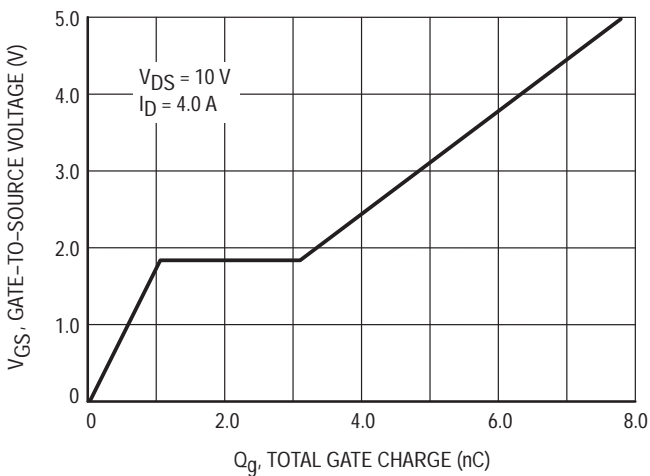


Figure 5. Gate Charge

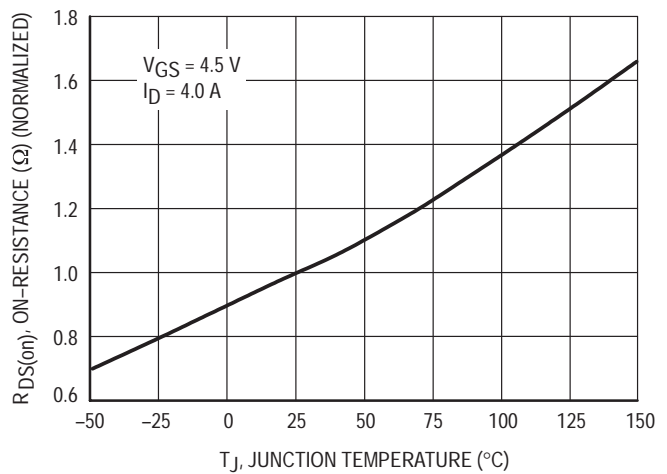


Figure 6. On-Resistance versus Junction Temperature

TYPICAL ELECTRICAL CHARACTERISTICS

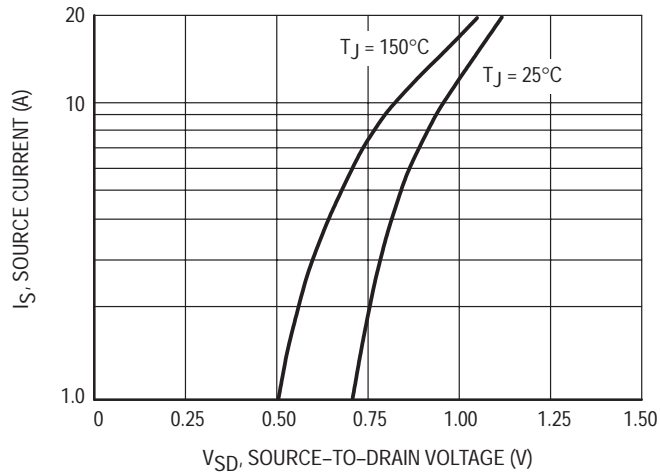


Figure 7. Source-Drain Diode Forward Voltage

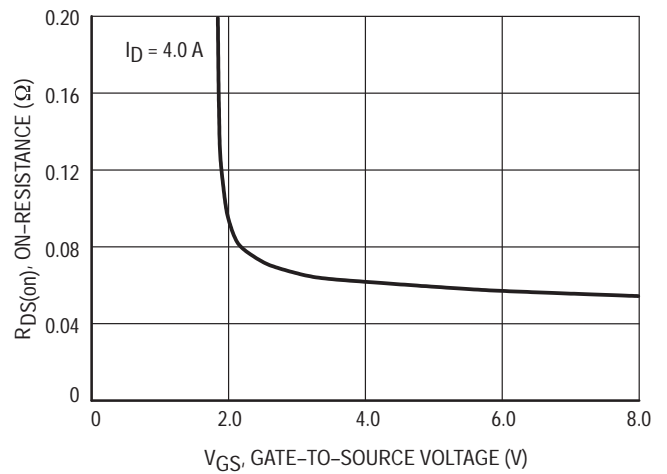


Figure 8. On-Resistance versus Gate-to-Source Voltage

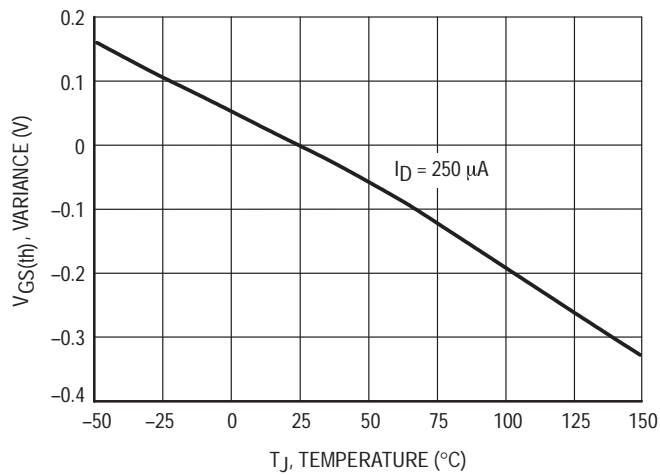


Figure 9. Threshold Voltage

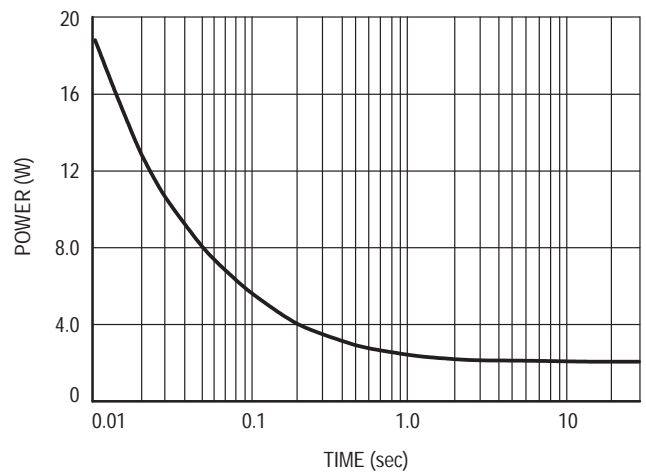


Figure 10. Single Pulse Power

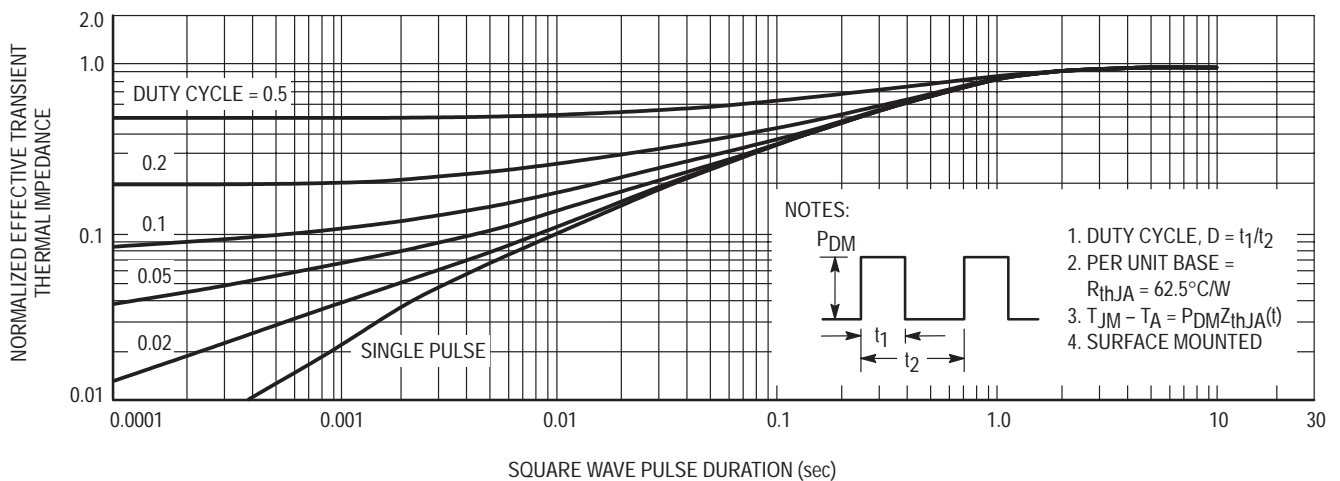


Figure 11. Normalized Thermal Transient Impedance, Junction-to-Ambient



Preliminary Information

MGSF3442XT1

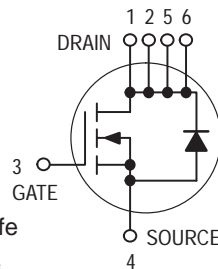
Motorola Preferred Device

**Low $r_{DS(on)}$ Small-Signal MOSFETs
TMOS Single N-Channel
Field Effect Transistors**

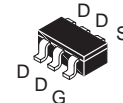
Part of the GreenLine™ Portfolio of devices with energy-conserving traits.

These miniature surface mount MOSFETs utilize Motorola's High Cell Density, HDTMOS process. Low $r_{DS(on)}$ assures minimal power loss and conserves energy, making this device ideal for use in small power management circuitry. Typical applications are dc-dc converters, power management in portable and battery-powered products such as computers, printers, PCMCIA cards, cellular and cordless telephones.

- Low $r_{DS(on)}$ Provides Higher Efficiency and Extends Battery Life
- Miniature TSOP 6 Surface Mount Package Saves Board Space
- Visit our Web Site at <http://www.mot-sps.com/ospd>



N-CHANNEL
ENHANCEMENT-MODE
TMOS MOSFET
 $r_{DS(on)} = 58 \text{ m}\Omega$ (TYP)



CASE 318G-02, Style 1
TSOP 6 PLASTIC

2.5V RATED

MAXIMUM RATINGS ($T_J = 25^\circ\text{C}$ unless otherwise noted)

Rating	Symbol	Value	Unit
Drain-to-Source Voltage	V_{DSS}	20	Vdc
Gate-to-Source Voltage — Continuous	V_{GS}	± 8.0	Vdc
Drain Current — Continuous @ $T_A = 25^\circ\text{C}$ — Pulsed Drain Current ($t_p \leq 10 \mu\text{s}$)	I_D I_{DM}	1.7 20	A
Total Power Dissipation @ $T_A = 25^\circ\text{C}$	P_D	400	mW
Operating and Storage Temperature Range	T_J, T_{stg}	-55 to 150	$^\circ\text{C}$
Thermal Resistance — Junction-to-Ambient	$R_{\theta JA}$	300	$^\circ\text{C}/\text{W}$
Maximum Lead Temperature for Soldering Purposes, for 10 seconds	T_L	260	$^\circ\text{C}$

ORDERING INFORMATION

Device	Reel Size	Tape Width	Quantity
MGSF3442XT1	7"	8 mm embossed tape	3000
MGSF3442XT3	13"	8 mm embossed tape	10,000

This document contains information on a product under development. Motorola reserves the right to change or discontinue this product without notice.

Preferred devices are Motorola recommended choices for future use and best overall value.

ELECTRICAL CHARACTERISTICS ($T_A = 25^\circ\text{C}$ unless otherwise noted)

Characteristic	Symbol	Min	Typ	Max	Unit
----------------	--------	-----	-----	-----	------

OFF CHARACTERISTICS

Drain-to-Source Breakdown Voltage ($V_{GS} = 0\text{ Vdc}$, $I_D = 10\ \mu\text{A}$)	$V_{(BR)DSS}$	20	—	—	Vdc
Zero Gate Voltage Drain Current ($V_{DS} = 20\text{ Vdc}$, $V_{GS} = 0\text{ Vdc}$) ($V_{DS} = 20\text{ Vdc}$, $V_{GS} = 0\text{ Vdc}$, $T_J = 70^\circ\text{C}$)	I_{DSS}	—	—	1.0 5.0	μAdc
Gate-Body Leakage Current ($V_{GS} = \pm 8.0\text{ Vdc}$, $V_{DS} = 0$)	I_{GSS}	—	—	± 100	nAdc

ON CHARACTERISTICS(1)

Gate Threshold Voltage ($V_{DS} = V_{GS}$, $I_D = 250\ \mu\text{Adc}$)	$V_{GS(th)}$	0.6	—	—	Vdc
Static Drain-to-Source On-Resistance ($V_{GS} = 4.5\text{ Vdc}$, $I_D = 1.7\text{ A}$) ($V_{GS} = 2.5\text{ Vdc}$, $I_D = 1.3\text{ A}$)	$r_{DS(on)}$	—	0.058 0.072	0.070 0.095	Ohms

DYNAMIC CHARACTERISTICS

Input Capacitance	($V_{DS} = 5.0\text{ V}$)	C_{iss}	—	90	—	pF
Output Capacitance	($V_{DS} = 5.0\text{ V}$)	C_{oss}	—	50	—	
Transfer Capacitance	($V_{DG} = 5.0\text{ V}$)	C_{rss}	—	10	—	

SWITCHING CHARACTERISTICS(2)

Turn-On Delay Time	(V _{DD} = 10 Vdc, I _D = 1.0 A, V _{GEN} = 10 V, R _L = 10 Ω)	$t_{d(on)}$	—	8.0	20	ns
Rise Time		t_r	—	24	40	
Turn-Off Delay Time		$t_{d(off)}$	—	36	60	
Fall Time		t_f	—	10	20	
Gate Charge		Q_T	—	—	—	nC

SOURCE-DRAIN DIODE CHARACTERISTICS

Continuous Current	I_S	—	—	1.0	A
Pulsed Current	I_{SM}	—	—	5.0	A
Forward Voltage(2)	V_{SD}	—	—	1.2	V

(1) Pulse Test: Pulse Width $\leq 300\ \mu\text{s}$, Duty Cycle $\leq 2\%$.

(2) Switching characteristics are independent of operating junction temperature.



Preliminary Information

MGSF3454VT1

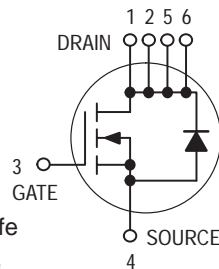
Motorola Preferred Device

**Low $r_{DS(on)}$ Small-Signal MOSFETs
TMOS Single N-Channel
Field Effect Transistors**

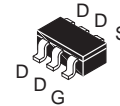
Part of the GreenLine™ Portfolio of devices with energy-conserving traits.

These miniature surface mount MOSFETs utilize Motorola's High Cell Density, HDTMOS process. Low $r_{DS(on)}$ assures minimal power loss and conserves energy, making this device ideal for use in small power management circuitry. Typical applications are dc-dc converters, power management in portable and battery-powered products such as computers, printers, PCMCIA cards, cellular and cordless telephones.

- Low $r_{DS(on)}$ Provides Higher Efficiency and Extends Battery Life
- Miniature TSOP 6 Surface Mount Package Saves Board Space
- Visit our Web Site at <http://www.mot-sps.com/ospd>



N-CHANNEL
ENHANCEMENT-MODE
TMOS MOSFET
 $r_{DS(on)} = 50 \text{ m}\Omega$ (TYP)



CASE 318G-02, Style 1
TSOP 6 PLASTIC

MAXIMUM RATINGS ($T_J = 25^\circ\text{C}$ unless otherwise noted)

Rating	Symbol	Value	Unit
Drain-to-Source Voltage	V_{DSS}	30	Vdc
Gate-to-Source Voltage — Continuous	V_{GS}	± 20	Vdc
Drain Current — Continuous @ $T_A = 25^\circ\text{C}$ — Pulsed Drain Current ($t_p \leq 10 \mu\text{s}$)	I_D I_{DM}	4.2 20	A
Total Power Dissipation @ $T_A = 25^\circ\text{C}$ Mounted on FR4 $t \leq 5 \text{ sec}$	P_D	2.0	W
Operating and Storage Temperature Range	T_J, T_{stg}	-55 to 150	$^\circ\text{C}$
Thermal Resistance — Junction-to-Ambient	$R_{\theta JA}$	62.5	$^\circ\text{C}/\text{W}$
Maximum Lead Temperature for Soldering Purposes, for 10 seconds	T_L	260	$^\circ\text{C}$

ORDERING INFORMATION

Device	Reel Size	Tape Width	Quantity
MGSF3454VT1	7"	8 mm embossed tape	3000
MGSF3454VT3	13"	8 mm embossed tape	10,000

This document contains information on a product under development. Motorola reserves the right to change or discontinue this product without notice.

Preferred devices are Motorola recommended choices for future use and best overall value.

ELECTRICAL CHARACTERISTICS ($T_A = 25^\circ\text{C}$ unless otherwise noted)

Characteristic	Symbol	Min	Typ	Max	Unit
----------------	--------	-----	-----	-----	------

OFF CHARACTERISTICS

Drain-to-Source Breakdown Voltage ($V_{GS} = 0\text{ Vdc}$, $I_D = 10\ \mu\text{A}$)	$V_{(BR)DSS}$	30	—	—	Vdc
Zero Gate Voltage Drain Current ($V_{DS} = 30\text{ Vdc}$, $V_{GS} = 0\text{ Vdc}$) ($V_{DS} = 30\text{ Vdc}$, $V_{GS} = 0\text{ Vdc}$, $T_J = 70^\circ\text{C}$)	I_{DSS}	—	—	1.0 25	μAdc
Gate-Body Leakage Current ($V_{GS} = \pm 20\text{ Vdc}$, $V_{DS} = 0$)	I_{GSS}	—	—	± 100	nAdc

ON CHARACTERISTICS(1)

Gate Threshold Voltage ($V_{DS} = V_{GS}$, $I_D = 250\ \mu\text{Adc}$)	$V_{GS(th)}$	1.0	—	—	Vdc
Static Drain-to-Source On-Resistance ($V_{GS} = 10\text{ Vdc}$, $I_D = 4.2\text{ A}$) ($V_{GS} = 4.5\text{ Vdc}$, $I_D = 3.4\text{ A}$)	$r_{DS(on)}$	—	0.05 0.07	0.065 0.095	Ohms

DYNAMIC CHARACTERISTICS

Input Capacitance	($V_{DS} = 5.0\text{ V}$)	C_{iss}	—	90	—	pF
Output Capacitance	($V_{DS} = 5.0\text{ V}$)	C_{oss}	—	50	—	
Transfer Capacitance	($V_{DG} = 5.0\text{ V}$)	C_{rss}	—	10	—	

SWITCHING CHARACTERISTICS(2)

Turn-On Delay Time	(V _{DD} = 10 Vdc, I _D = 1.0 A, V _{GEN} = 10 V, R _L = 10 Ω)	$t_{d(on)}$	—	10	20	ns
Rise Time		t_r	—	15	30	
Turn-Off Delay Time		$t_{d(off)}$	—	20	35	
Fall Time		t_f	—	10	20	
Gate Charge		Q_T	—	—	15	nC

SOURCE-DRAIN DIODE CHARACTERISTICS

Continuous Current	I_S	—	—	1.0	A
Pulsed Current	I_{SM}	—	—	5.0	A
Forward Voltage ⁽²⁾	V_{SD}	—	—	1.2	V

(1) Pulse Test: Pulse Width $\leq 300\ \mu\text{s}$, Duty Cycle $\leq 2\%$.

(2) Switching characteristics are independent of operating junction temperature.

TYPICAL ELECTRICAL CHARACTERISTICS

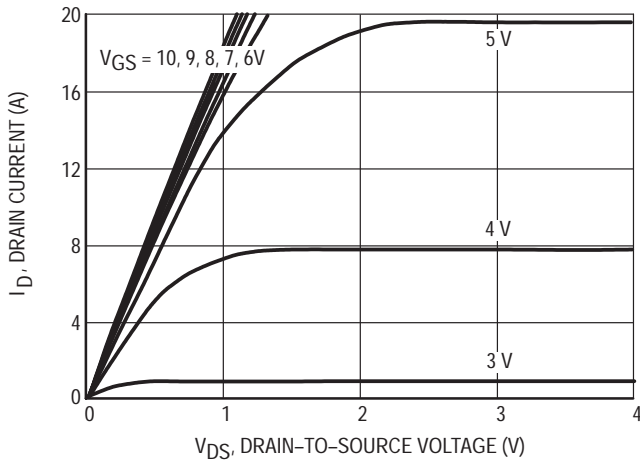


Figure 1. Output Characteristics

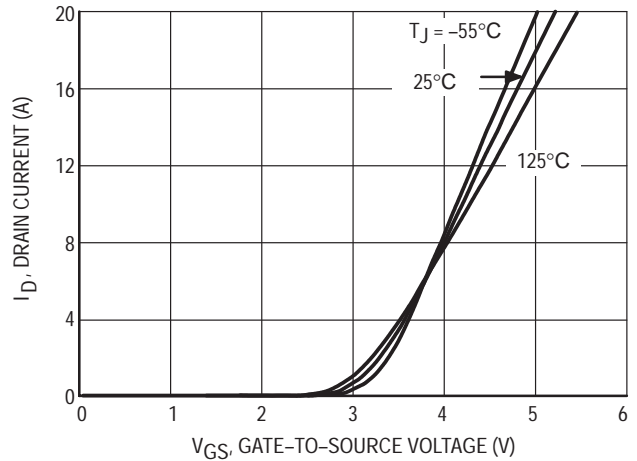


Figure 2. Transfer Characteristics

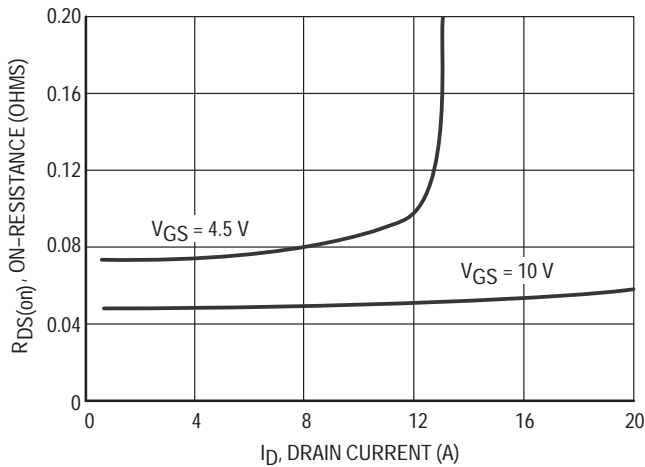


Figure 3. On-Resistance vs. Drain Current

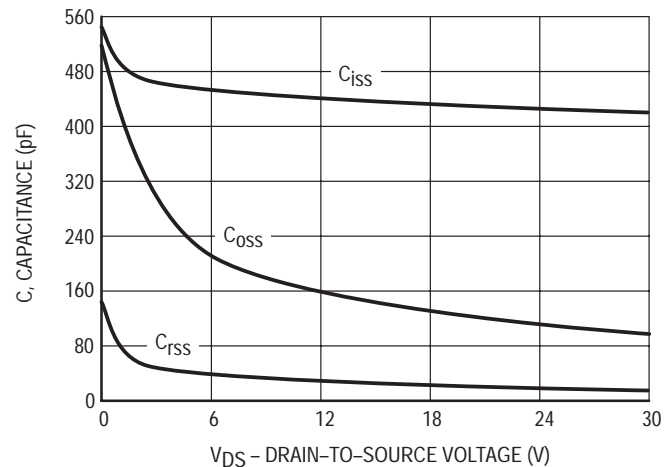


Figure 4. Capacitance

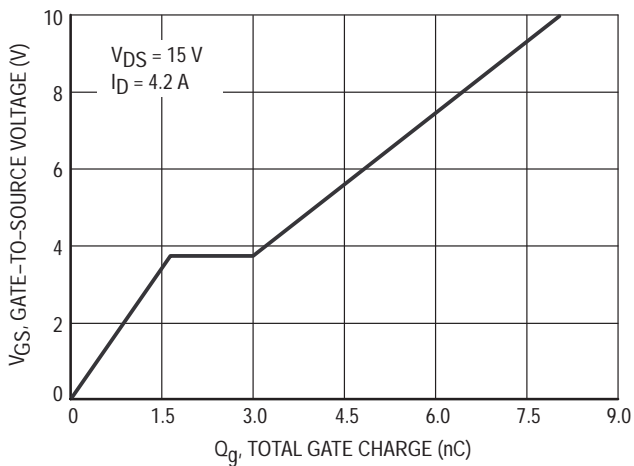


Figure 5. Gate Charge

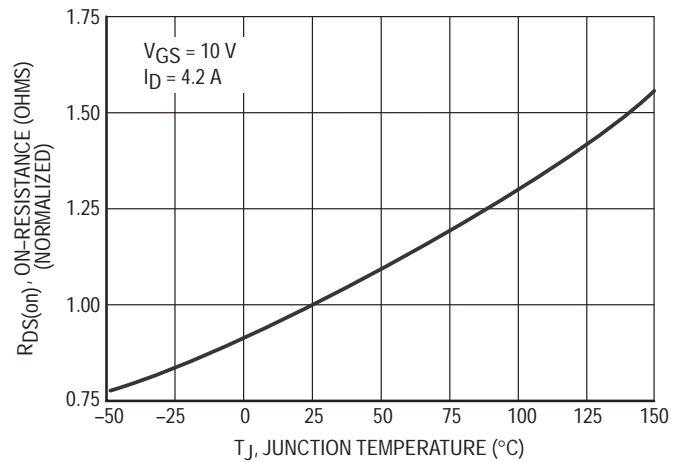


Figure 6. On-Resistance vs. Junction Temperature

TYPICAL ELECTRICAL CHARACTERISTICS

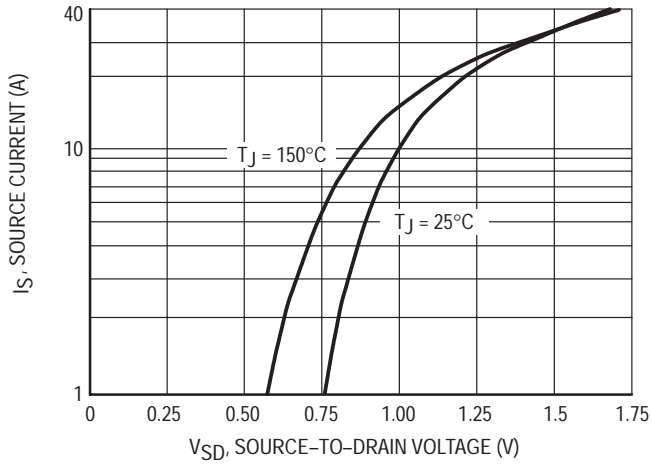


Figure 7. Source-Drain Diode Forward Voltage

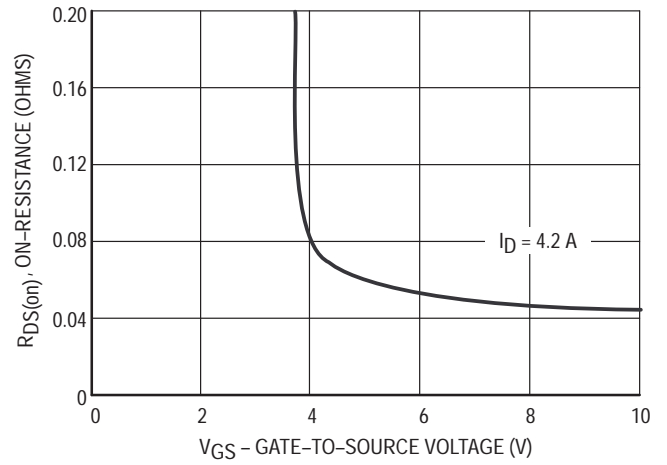


Figure 8. On-Resistance vs. Gate-to-Source Voltage

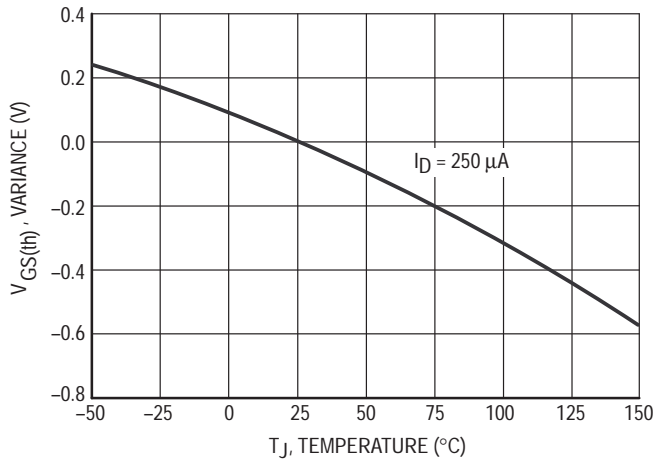


Figure 9. Threshold Voltage

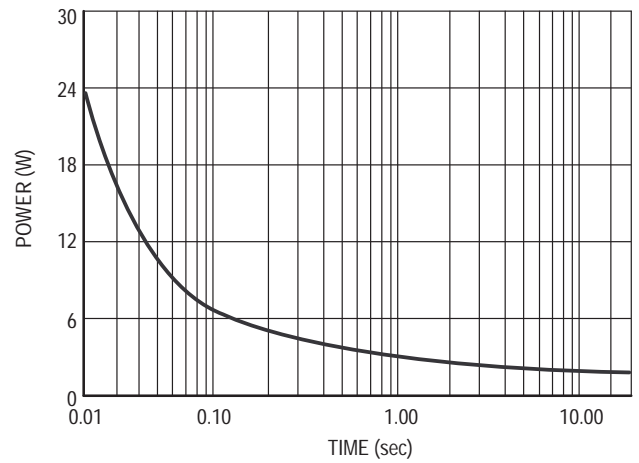


Figure 10. Single Pulse Power

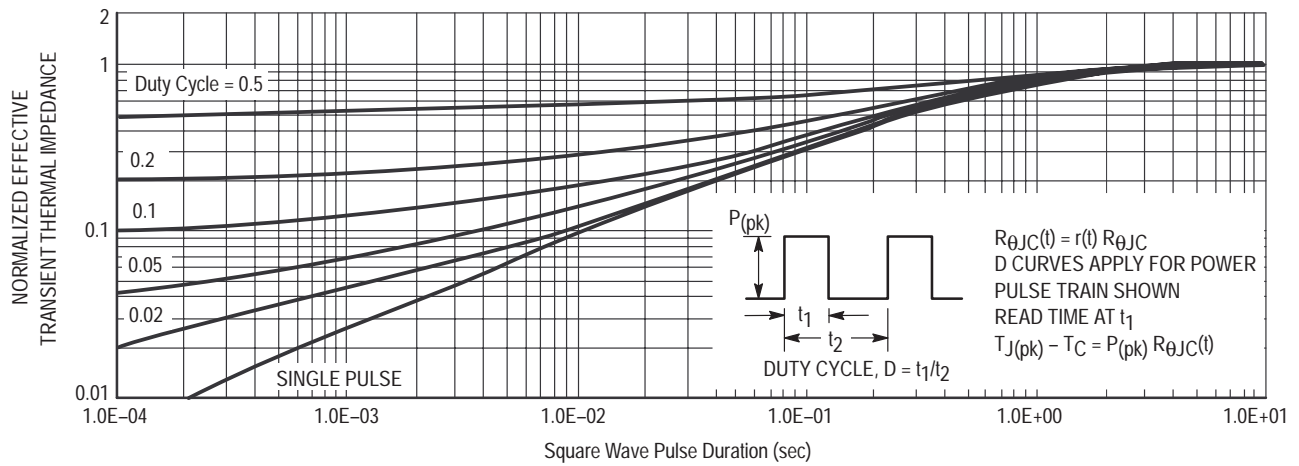


Figure 11. Normalized Thermal Transient Impedance, Junction-to-Ambient



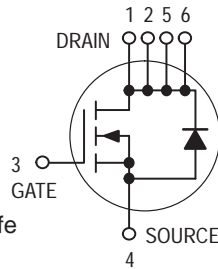
Preliminary Information

Low $r_{DS(on)}$ Small-Signal MOSFETs TMOS Single N-Channel Field Effect Transistors

Part of the GreenLine™ Portfolio of devices with energy-conserving traits.

These miniature surface mount MOSFETs utilize Motorola's High Cell Density, HDTMOS process. Low $r_{DS(on)}$ assures minimal power loss and conserves energy, making this device ideal for use in small power management circuitry. Typical applications are dc-dc converters, power management in portable and battery-powered products such as computers, printers, PCMCIA cards, cellular and cordless telephones.

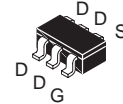
- Low $r_{DS(on)}$ Provides Higher Efficiency and Extends Battery Life
- Miniature TSOP 6 Surface Mount Package Saves Board Space
- Visit our Web Site at <http://www.mot-sps.com/ospd>



MGSF3454XT1

Motorola Preferred Device

N-CHANNEL
ENHANCEMENT-MODE
TMOS MOSFET
 $r_{DS(on)} = 50 \text{ m}\Omega$ (TYP)



CASE 318G-02, Style 1
TSOP 6 PLASTIC

MAXIMUM RATINGS ($T_J = 25^\circ\text{C}$ unless otherwise noted)

Rating	Symbol	Value	Unit
Drain-to-Source Voltage	V_{DSS}	30	Vdc
Gate-to-Source Voltage — Continuous	V_{GS}	± 20	Vdc
Drain Current — Continuous @ $T_A = 25^\circ\text{C}$ — Pulsed Drain Current ($t_p \leq 10 \mu\text{s}$)	I_D I_{DM}	1.75 20	A
Total Power Dissipation @ $T_A = 25^\circ\text{C}$	P_D	950	mW
Operating and Storage Temperature Range	T_J, T_{stg}	-55 to 150	$^\circ\text{C}$
Thermal Resistance — Junction-to-Ambient	$R_{\theta JA}$	250	$^\circ\text{C}/\text{W}$
Maximum Lead Temperature for Soldering Purposes, for 10 seconds	T_L	260	$^\circ\text{C}$

Device Marking = 3G

ORDERING INFORMATION

Device	Reel Size	Tape Width	Quantity
MGSF3454XT1	7"	8 mm embossed tape	3000
MGSF3454XT3	13"	8 mm embossed tape	10,000

This document contains information on a product under development. Motorola reserves the right to change or discontinue this product without notice.

Preferred devices are Motorola recommended choices for future use and best overall value.

ELECTRICAL CHARACTERISTICS ($T_A = 25^\circ\text{C}$ unless otherwise noted)

Characteristic	Symbol	Min	Typ	Max	Unit
OFF CHARACTERISTICS					
Drain-to-Source Breakdown Voltage ($V_{GS} = 0\text{ Vdc}$, $I_D = 10\ \mu\text{A}$)	$V_{(BR)DSS}$	30	—	—	Vdc
Zero Gate Voltage Drain Current ($V_{DS} = 30\text{ Vdc}$, $V_{GS} = 0\text{ Vdc}$) ($V_{DS} = 30\text{ Vdc}$, $V_{GS} = 0\text{ Vdc}$, $T_J = 70^\circ\text{C}$)	I_{DSS}	—	—	1.0 25	μAdc
Gate-Body Leakage Current ($V_{GS} = \pm 20\text{ Vdc}$, $V_{DS} = 0$)	I_{GSS}	—	—	± 100	nAdc

ON CHARACTERISTICS(1)

Gate Threshold Voltage ($V_{DS} = V_{GS}$, $I_D = 250\ \mu\text{Adc}$)	$V_{GS(th)}$	1.0	—	—	Vdc
Static Drain-to-Source On-Resistance ($V_{GS} = 10\text{ Vdc}$, $I_D = 1.75\text{ A}$) ($V_{GS} = 4.5\text{ Vdc}$, $I_D = 1.5\text{ A}$)	$r_{DS(on)}$	—	0.05 0.07	0.065 0.095	Ohms

DYNAMIC CHARACTERISTICS

Input Capacitance	($V_{DS} = 5.0\text{ V}$)	C_{iss}	—	345	—	pF
Output Capacitance	($V_{DS} = 5.0\text{ V}$)	C_{oss}	—	215	—	
Transfer Capacitance	($V_{DG} = 5.0\text{ V}$)	C_{rss}	—	140	—	

SWITCHING CHARACTERISTICS(2)

Turn-On Delay Time	($V_{DD} = 10\text{ Vdc}$, $I_D = 1.0\text{ A}$, $V_{GEN} = 10\text{ V}$, $R_L = 10\ \Omega$)	$t_{d(on)}$	—	10	—	ns
Rise Time		t_r	—	15	—	
Turn-Off Delay Time		$t_{d(off)}$	—	20	—	
Fall Time		t_f	—	10	—	
Gate Charge		Q_T	—	—	15	nC

SOURCE-DRAIN DIODE CHARACTERISTICS

Continuous Current	I_S	—	—	1.0	A
Pulsed Current	I_{SM}	—	—	5.0	A
Forward Voltage(2)	V_{SD}	—	—	1.2	V

(1) Pulse Test: Pulse Width $\leq 300\ \mu\text{s}$, Duty Cycle $\leq 2\%$.

(2) Switching characteristics are independent of operating junction temperature.

TYPICAL ELECTRICAL CHARACTERISTICS

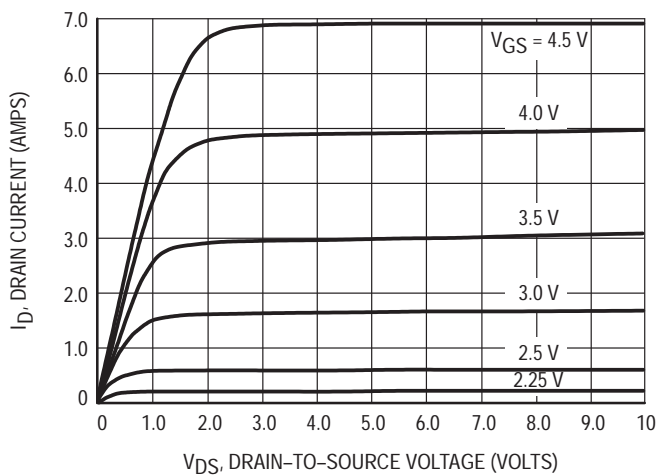


Figure 1. Output Characteristics

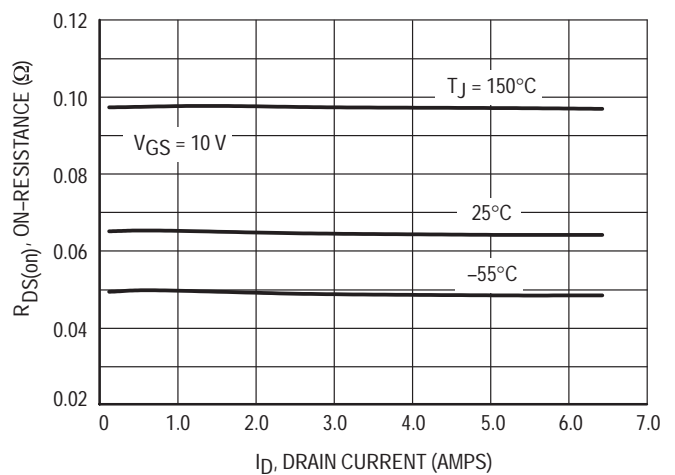


Figure 2. On-Resistance versus Drain Current

TYPICAL ELECTRICAL CHARACTERISTICS

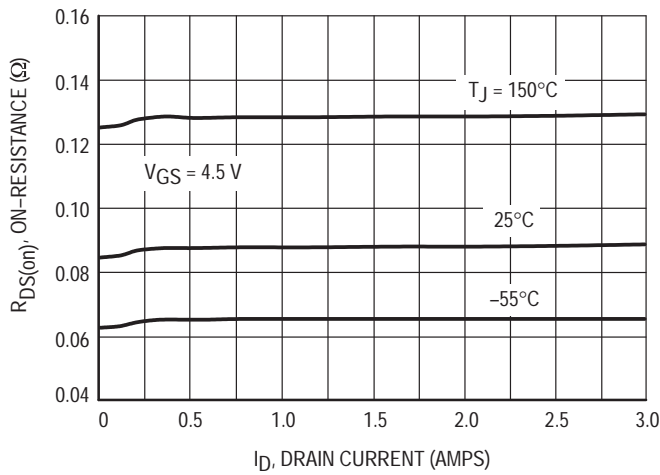


Figure 3. On-Resistance versus Drain Current

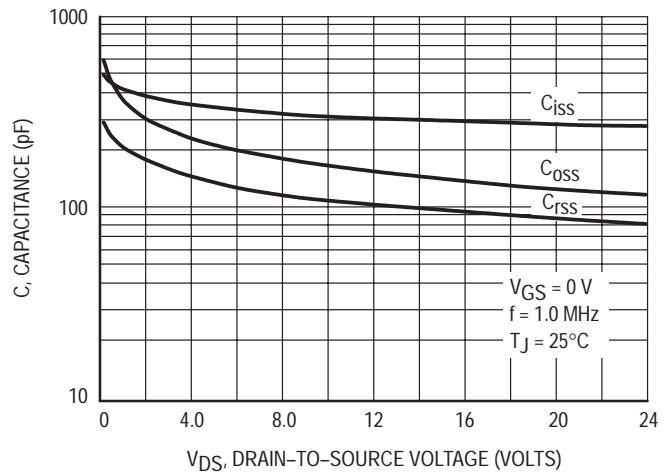


Figure 4. Capacitance

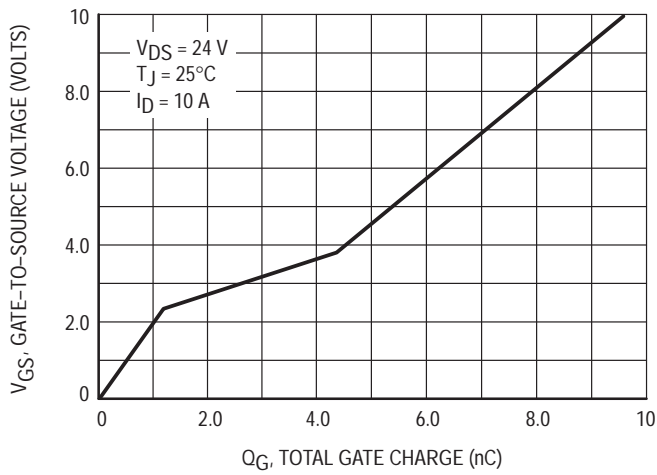


Figure 5. Gate Charge

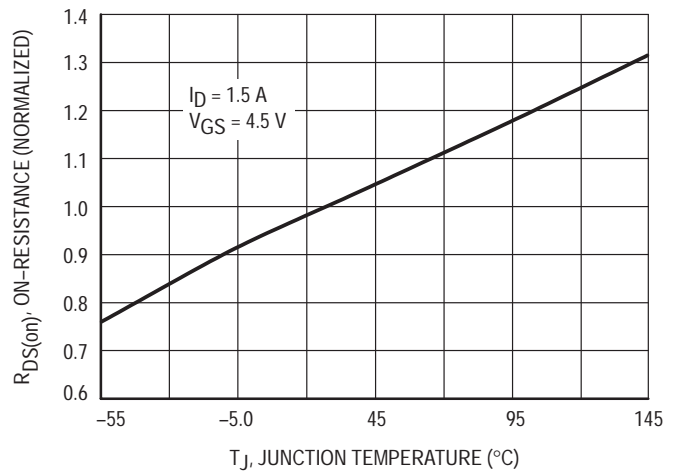


Figure 6. On-Resistance versus Junction Temperature

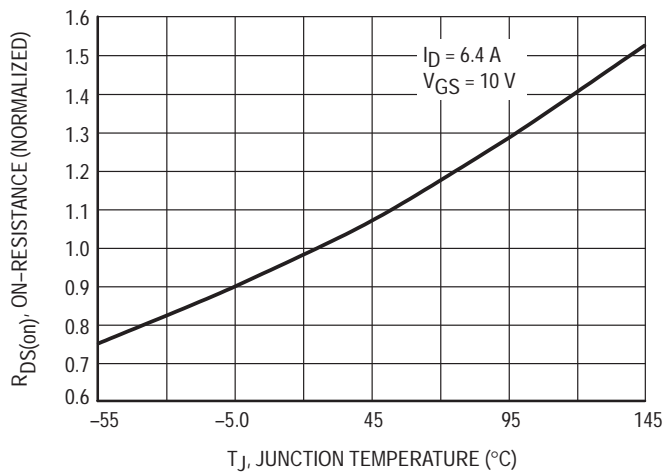


Figure 7. On-Resistance versus Junction Temperature

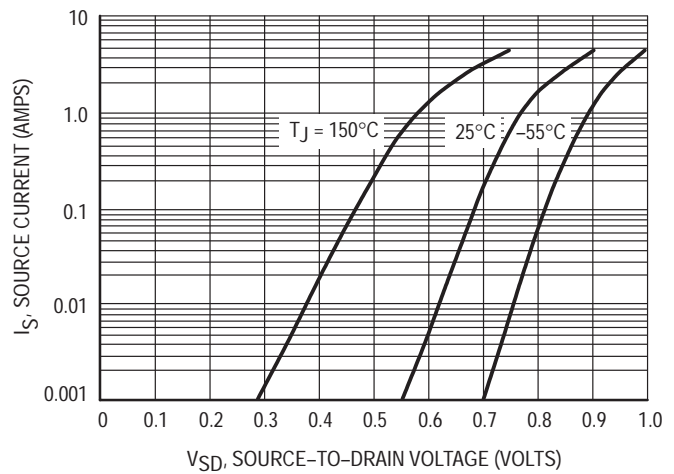


Figure 8. Source-Drain Diode Forward Voltage

TYPICAL ELECTRICAL CHARACTERISTICS

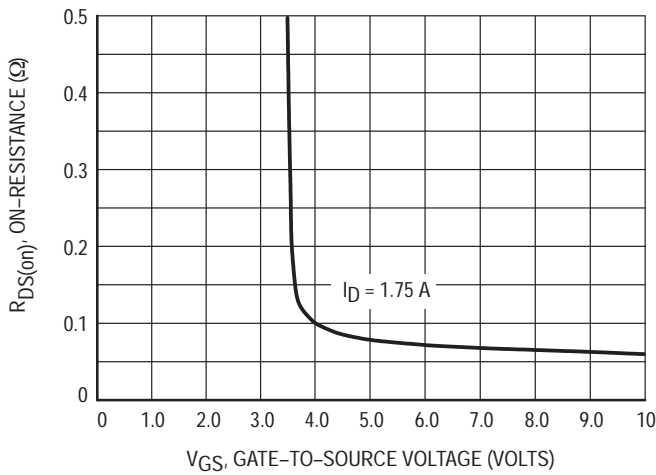


Figure 9. On-Resistance versus Gate-to-Source Voltage

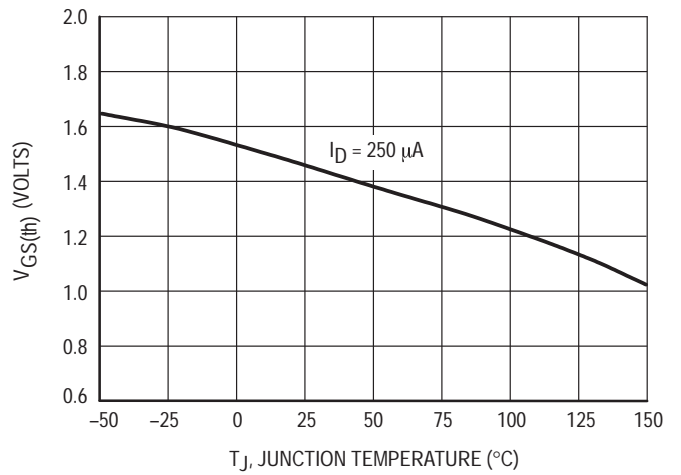


Figure 10. Threshold Voltage

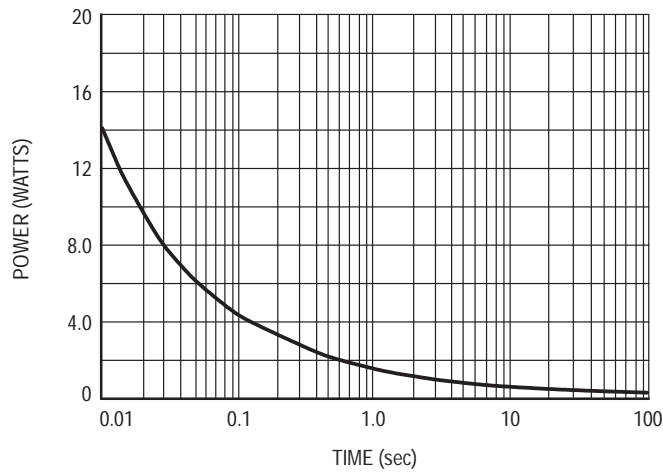


Figure 11. Single Pulse Power

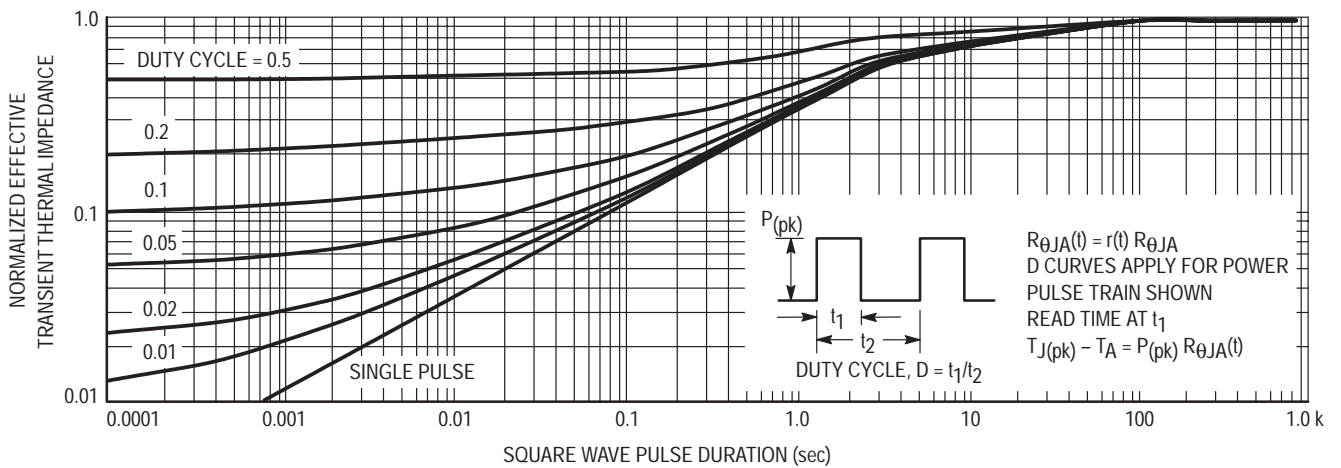


Figure 12. Normalized Thermal Transient Impedance, Junction-to-Ambient



Preliminary Information

MGSF3455VT1

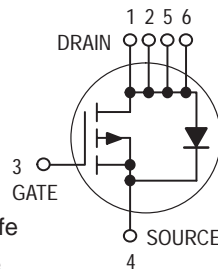
Motorola Preferred Device

**Low $r_{DS(on)}$ Small-Signal MOSFETs
TMOS Single P-Channel
Field Effect Transistors**

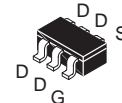
Part of the GreenLine™ Portfolio of devices with energy-conserving traits.

These miniature surface mount MOSFETs utilize Motorola's High Cell Density, HDTMOS process. Low $r_{DS(on)}$ assures minimal power loss and conserves energy, making this device ideal for use in small power management circuitry. Typical applications are dc-dc converters, power management in portable and battery-powered products such as computers, printers, PCMCIA cards, cellular and cordless telephones.

- Low $r_{DS(on)}$ Provides Higher Efficiency and Extends Battery Life
- Miniature TSOP 6 Surface Mount Package Saves Board Space
- Visit our Web Site at <http://www.mot-sps.com/ospd>



P-CHANNEL
ENHANCEMENT-MODE
TMOS MOSFET
 $r_{DS(on)} = 80 \text{ m}\Omega$ (TYP)



CASE 318G-02, Style 1
TSOP 6 PLASTIC

MAXIMUM RATINGS ($T_J = 25^\circ\text{C}$ unless otherwise noted)

Rating	Symbol	Value	Unit
Drain-to-Source Voltage	V_{DSS}	30	Vdc
Gate-to-Source Voltage — Continuous	V_{GS}	± 20	Vdc
Drain Current — Continuous @ $T_A = 25^\circ\text{C}$ — Pulsed Drain Current ($t_p \leq 10 \mu\text{s}$)	I_D I_{DM}	3.5 20	A
Total Power Dissipation @ $T_A = 25^\circ\text{C}$ Mounted on FR4 $t \leq 5 \text{ sec}$	P_D	2.0	W
Operating and Storage Temperature Range	T_J, T_{stg}	-55 to 150	$^\circ\text{C}$
Thermal Resistance — Junction-to-Ambient	$R_{\theta JA}$	62.5	$^\circ\text{C/W}$
Maximum Lead Temperature for Soldering Purposes, for 10 seconds	T_L	260	$^\circ\text{C}$

ORDERING INFORMATION

Device	Reel Size	Tape Width	Quantity
MGSF3455VT1	7"	8 mm embossed tape	3000
MGSF3455VT3	13"	8 mm embossed tape	10,000

This document contains information on a product under development. Motorola reserves the right to change or discontinue this product without notice.

Preferred devices are Motorola recommended choices for future use and best overall value.

ELECTRICAL CHARACTERISTICS ($T_A = 25^\circ\text{C}$ unless otherwise noted)

Characteristic	Symbol	Min	Typ	Max	Unit
----------------	--------	-----	-----	-----	------

OFF CHARACTERISTICS

Drain-to-Source Breakdown Voltage ($V_{GS} = 0\text{ Vdc}$, $I_D = 10\ \mu\text{A}$)	$V_{(BR)DSS}$	30	—	—	Vdc
Zero Gate Voltage Drain Current ($V_{DS} = 30\text{ Vdc}$, $V_{GS} = 0\text{ Vdc}$) ($V_{DS} = 30\text{ Vdc}$, $V_{GS} = 0\text{ Vdc}$, $T_J = 70^\circ\text{C}$)	I_{DSS}	—	—	1.0 5.0	μAdc
Gate-Body Leakage Current ($V_{GS} = \pm 20\text{ Vdc}$, $V_{DS} = 0$)	I_{GSS}	—	—	± 100	nAdc

ON CHARACTERISTICS(1)

Gate Threshold Voltage ($V_{DS} = V_{GS}$, $I_D = 250\ \mu\text{Adc}$)	$V_{GS(th)}$	1.0	—	—	Vdc
Static Drain-to-Source On-Resistance ($V_{GS} = 10\text{ Vdc}$, $I_D = 3.5\text{ A}$) ($V_{GS} = 4.5\text{ Vdc}$, $I_D = 2.5\text{ A}$)	$r_{DS(on)}$	—	0.080 0.134	0.100 0.190	Ohms

DYNAMIC CHARACTERISTICS

Input Capacitance	($V_{DS} = 5.0\text{ V}$)	C_{iss}	—	90	—	pF
Output Capacitance	($V_{DS} = 5.0\text{ V}$)	C_{oss}	—	50	—	
Transfer Capacitance	($V_{DG} = 5.0\text{ V}$)	C_{rss}	—	10	—	

SWITCHING CHARACTERISTICS(2)

Turn-On Delay Time	(V _{DD} = 15 Vdc, I _D = 1.0 A, V _{GEN} = 10 V, R _L = 10 Ω)	$t_{d(on)}$	—	10	20	ns
Rise Time		t_r	—	15	30	
Turn-Off Delay Time		$t_{d(off)}$	—	20	35	
Fall Time		t_f	—	10	20	
Gate Charge		Q_T	—	3000	—	pC

SOURCE-DRAIN DIODE CHARACTERISTICS

Continuous Current	I_S	—	—	1.0	A
Pulsed Current	I_{SM}	—	—	5.0	A
Forward Voltage ⁽²⁾	V_{SD}	—	—	1.2	V

(1) Pulse Test: Pulse Width $\leq 300\ \mu\text{s}$, Duty Cycle $\leq 2\%$.

(2) Switching characteristics are independent of operating junction temperature.

TYPICAL ELECTRICAL CHARACTERISTICS

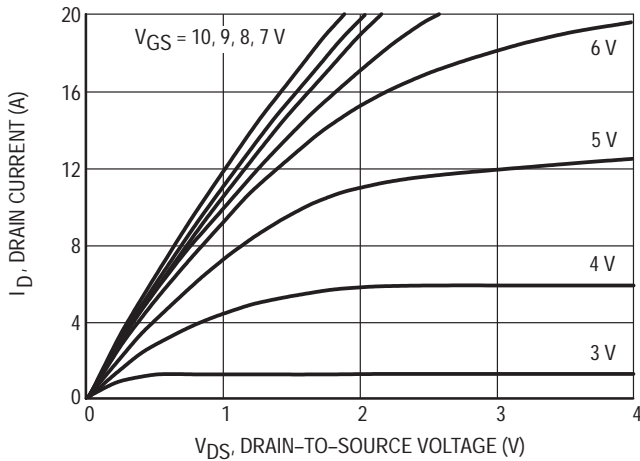


Figure 1. Output Characteristics

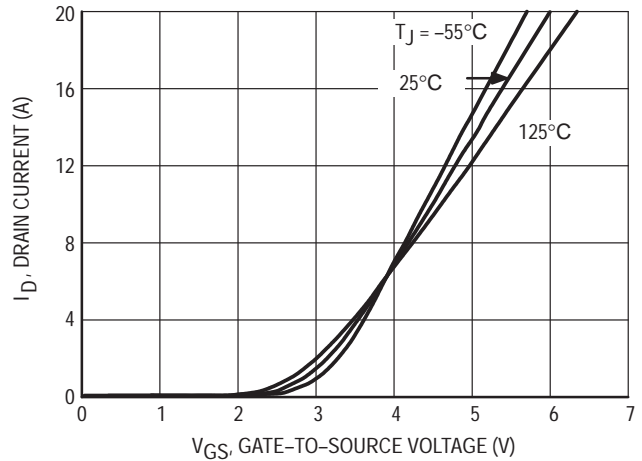


Figure 2. Transfer Characteristics

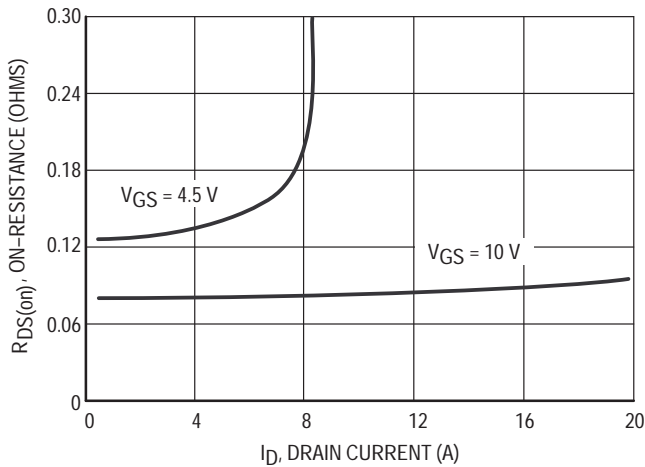


Figure 3. On-Resistance vs. Drain Current

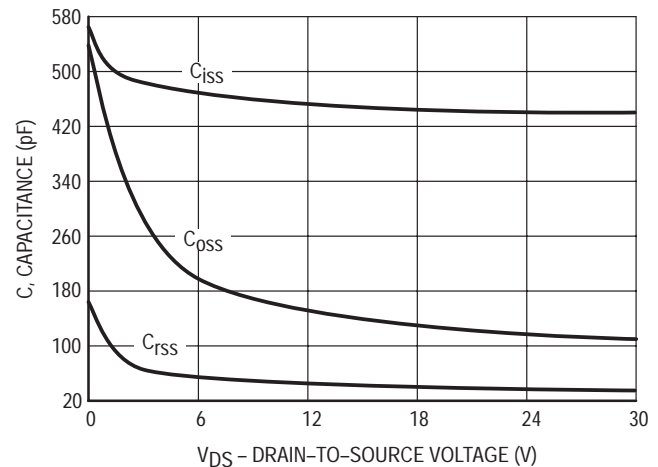


Figure 4. Capacitance

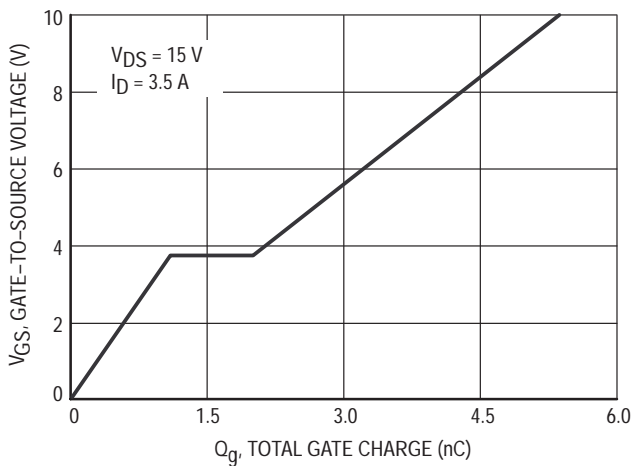


Figure 5. Gate Charge

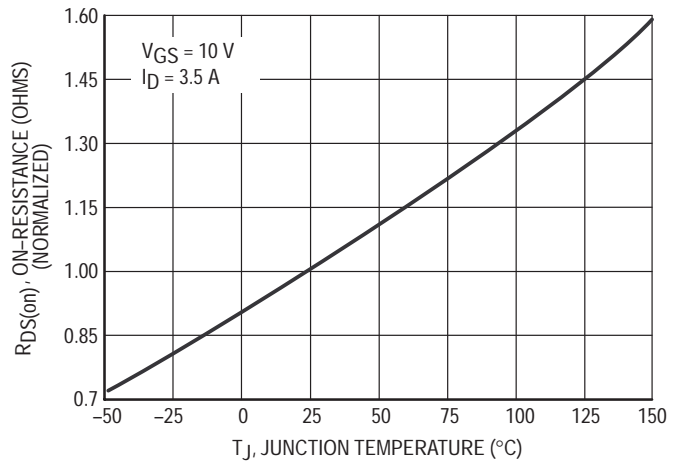


Figure 6. On-Resistance vs. Junction Temperature

TYPICAL ELECTRICAL CHARACTERISTICS

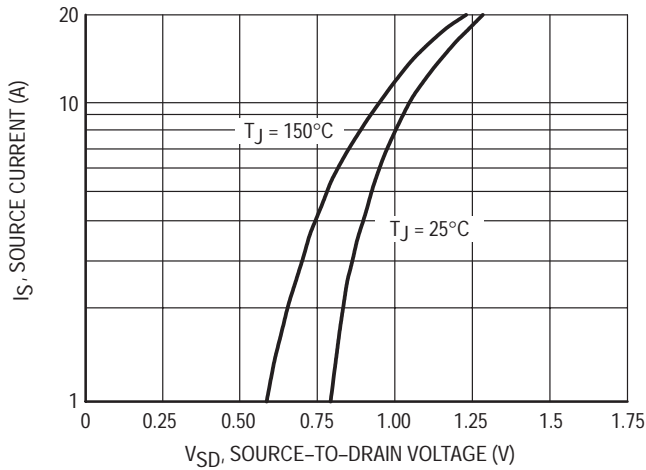


Figure 7. Source-Drain Diode Forward Voltage

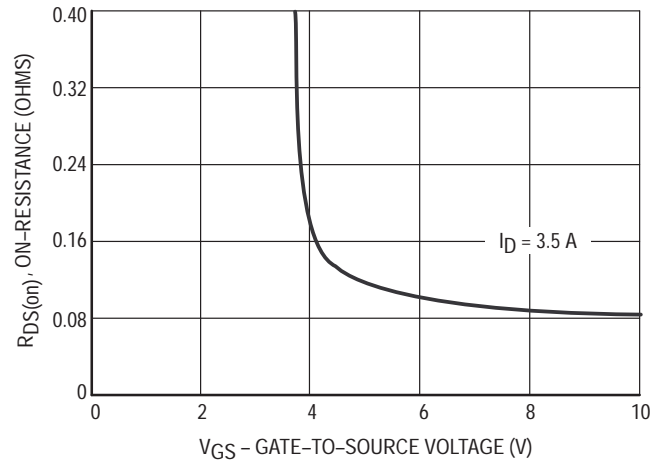


Figure 8. On-Resistance vs. Gate-to-Source Voltage

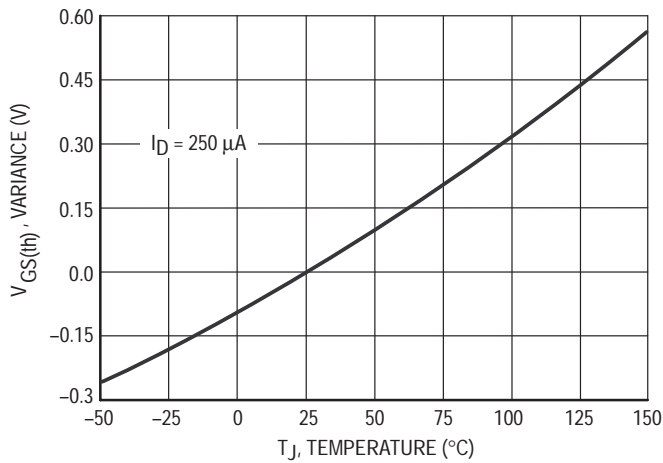


Figure 9. Threshold Voltage

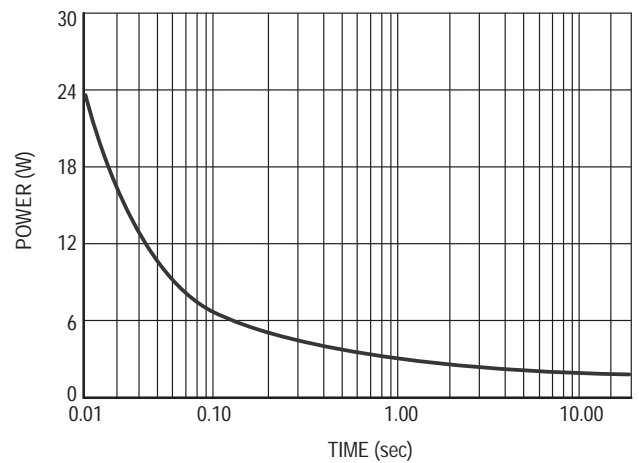


Figure 10. Single Pulse Power

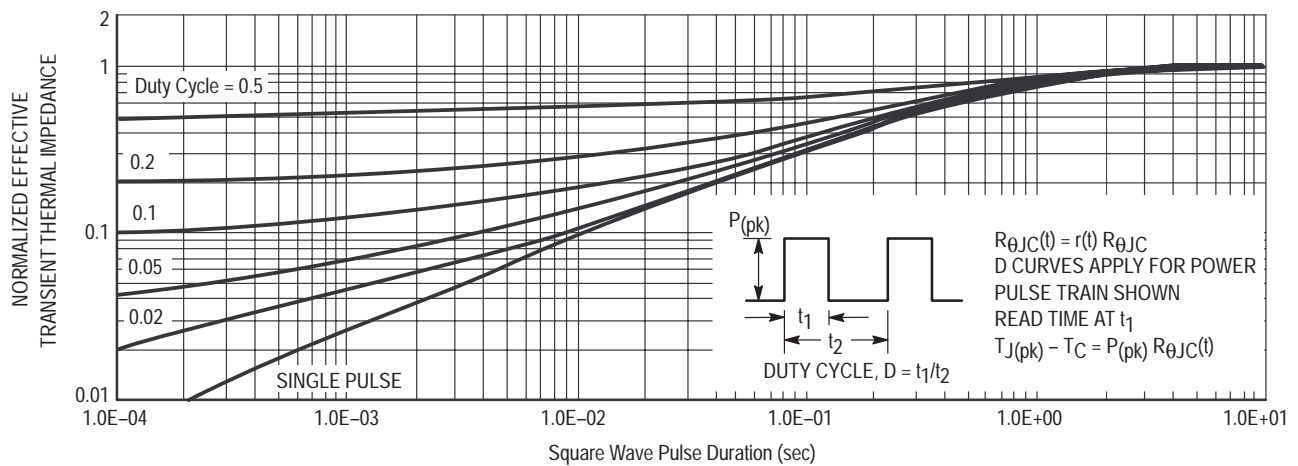


Figure 11. Normalized Thermal Transient Impedance, Junction-to-Ambient



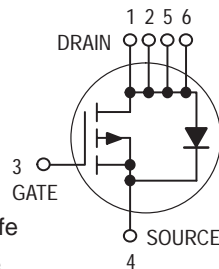
Preliminary Information

Low $r_{DS(on)}$ Small-Signal MOSFETs TMOS Single P-Channel Field Effect Transistors

Part of the GreenLine™ Portfolio of devices with energy-conserving traits.

These miniature surface mount MOSFETs utilize Motorola's High Cell Density, HDTMOS process. Low $r_{DS(on)}$ assures minimal power loss and conserves energy, making this device ideal for use in small power management circuitry. Typical applications are dc-dc converters, power management in portable and battery-powered products such as computers, printers, PCMCIA cards, cellular and cordless telephones.

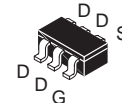
- Low $r_{DS(on)}$ Provides Higher Efficiency and Extends Battery Life
- Miniature TSOP 6 Surface Mount Package Saves Board Space
- Visit our Web Site at <http://www.mot-sps.com/ospd>



MGSF3455XT1

Motorola Preferred Device

P-CHANNEL
ENHANCEMENT-MODE
TMOS MOSFET
 $r_{DS(on)} = 80 \text{ m}\Omega$ (TYP)



CASE 318G-02, Style 1
TSOP 6 PLASTIC

MAXIMUM RATINGS ($T_J = 25^\circ\text{C}$ unless otherwise noted)

Rating	Symbol	Value	Unit
Drain-to-Source Voltage	V_{DSS}	30	Vdc
Gate-to-Source Voltage — Continuous	V_{GS}	± 20	Vdc
Drain Current — Continuous @ $T_A = 25^\circ\text{C}$ — Pulsed Drain Current ($t_p \leq 10 \mu\text{s}$)	I_D I_{DM}	1.45 10	A
Total Power Dissipation @ $T_A = 25^\circ\text{C}$	P_D	400	mW
Operating and Storage Temperature Range	T_J, T_{stg}	-55 to 150	$^\circ\text{C}$
Thermal Resistance — Junction-to-Ambient	$R_{\theta JA}$	300	$^\circ\text{C}/\text{W}$
Maximum Lead Temperature for Soldering Purposes, for 10 seconds	T_L	260	$^\circ\text{C}$

ORDERING INFORMATION

Device	Reel Size	Tape Width	Quantity
MGSF3455XT1	7"	8 mm embossed tape	3000
MGSF3455XT3	13"	8 mm embossed tape	10,000

This document contains information on a product under development. Motorola reserves the right to change or discontinue this product without notice.

Preferred devices are Motorola recommended choices for future use and best overall value.

ELECTRICAL CHARACTERISTICS ($T_A = 25^\circ\text{C}$ unless otherwise noted)

Characteristic	Symbol	Min	Typ	Max	Unit
----------------	--------	-----	-----	-----	------

OFF CHARACTERISTICS

Drain-to-Source Breakdown Voltage ($V_{GS} = 0\text{ Vdc}$, $I_D = 10\ \mu\text{A}$)	$V_{(BR)DSS}$	30	—	—	Vdc
Zero Gate Voltage Drain Current ($V_{DS} = 30\text{ Vdc}$, $V_{GS} = 0\text{ Vdc}$) ($V_{DS} = 30\text{ Vdc}$, $V_{GS} = 0\text{ Vdc}$, $T_J = 70^\circ\text{C}$)	I_{DSS}	—	—	1.0 5.0	μAdc
Gate-Body Leakage Current ($V_{GS} = \pm 20\text{ Vdc}$, $V_{DS} = 0$)	I_{GSS}	—	—	± 100	nAdc

ON CHARACTERISTICS(1)

Gate Threshold Voltage ($V_{DS} = V_{GS}$, $I_D = 250\ \mu\text{Adc}$)	$V_{GS(th)}$	1.0	—	—	Vdc
Static Drain-to-Source On-Resistance ($V_{GS} = 10\text{ Vdc}$, $I_D = 1.45\text{ A}$) ($V_{GS} = 4.5\text{ Vdc}$, $I_D = 1.2\text{ A}$)	$r_{DS(on)}$	—	0.080 0.134	0.100 0.190	Ohms

DYNAMIC CHARACTERISTICS

Input Capacitance	($V_{DS} = 5.0\text{ V}$)	C_{iss}	—	90	—	pF
Output Capacitance	($V_{DS} = 5.0\text{ V}$)	C_{oss}	—	50	—	
Transfer Capacitance	($V_{DG} = 5.0\text{ V}$)	C_{rss}	—	10	—	

SWITCHING CHARACTERISTICS(2)

Turn-On Delay Time	(V _{DD} = 15 Vdc, I _D = 1.0 A, V _{GEN} = 10 V, R _L = 10 Ω)	$t_{d(on)}$	—	10	20	ns
Rise Time		t_r	—	15	30	
Turn-Off Delay Time		$t_{d(off)}$	—	20	35	
Fall Time		t_f	—	10	20	
Gate Charge		Q_T	—	3000	—	pC

SOURCE-DRAIN DIODE CHARACTERISTICS

Continuous Current	I_S	—	—	1.0	A
Pulsed Current	I_{SM}	—	—	5.0	A
Forward Voltage ⁽²⁾	V_{SD}	—	0.85	—	V

(1) Pulse Test: Pulse Width $\leq 300\ \mu\text{s}$, Duty Cycle $\leq 2\%$.

(2) Switching characteristics are independent of operating junction temperature.



Switching Diode

Part of the GreenLine™ Portfolio of devices with energy-conserving traits.

This switching diode has the following features:

- Very Low Leakage (≤ 500 pA) promotes extended battery life by decreasing energy waste
- Offered in four Surface Mount package types
- Available in 8 mm Tape and Reel in quantities of 3,000

Applications

- ESD Protection
- Reverse Polarity Protection
- Steering Logic
- Medium-Speed Switching

MAXIMUM RATINGS

Rating	Symbol	Value	Unit
Continuous Reverse Voltage	V_R	30	Vdc
Peak Forward Current	I_F	200	mAdc
Peak Forward Surge Current	I_{FM} (surge)	500	mA

DEVICE MARKING

MMBD1000LT1 = AY
MMBD2000T1 = DH
MMBD3000T1 = XP
MMSD1000T1 = 4K

THERMAL CHARACTERISTICS

Characteristic	Symbol	Max	Unit
Total Device Dissipation FR-4 Board (1) $T_A = 25^\circ\text{C}$	P_D	225	mW
MMBD1000LT1, MMBD3000T1, MMSD1000T1			
MMBD2000T1			
Derate above 25°C	P_D	1.8	mW/ $^\circ\text{C}$
MMBD1000LT1, MMBD3000T1, MMSD1000T1			
MMBD2000T1			
Thermal Resistance Junction to Ambient	$R_{\theta JA}$	556	$^\circ\text{C}/\text{W}$
MMBD1000LT1, MMBD3000T1, MMSD1000T1			
MMBD2000T1			
Junction and Storage Temperature	T_J, T_{stg}	-55 to +150	$^\circ\text{C}$

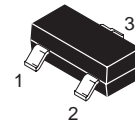
(1) Device mounted on a FR-4 glass epoxy printed circuit board using the minimum recommended footprint.

Preferred devices are Motorola recommended choices for future use and best overall value.

MMBD1000LT1
MMBD2000T1
MMBD3000T1
MMSD1000T1

Motorola Preferred Devices

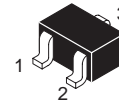
MMBD1000LT1



CASE 318-08, STYLE 8
SOT-23 (TO-236AB)



MMBD2000T1



CASE 419-02, STYLE 2
SC-70/SOT-323



MMBD3000T1



CASE 318D-04, STYLE 2
SC-59



MMSD1000T1

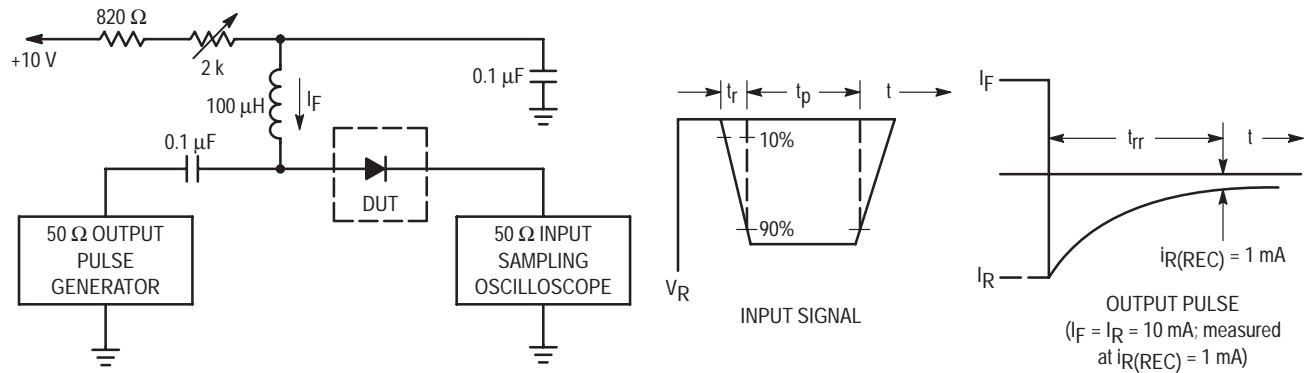


CASE 425-04, STYLE 1
SOD-123



ELECTRICAL CHARACTERISTICS ($T_A = 25^\circ\text{C}$ unless otherwise noted)

Characteristic	Symbol	Min	Max	Unit
OFF CHARACTERISTICS				
Reverse Breakdown Voltage ($I_{BR} = 100 \mu\text{A}$)	$V_{(BR)}$	30	—	V
Reverse Voltage Leakage Current ($V_R = 75 \text{ V}$)	I_R	—	500	pA
Forward Voltage ($I_F = 1.0 \text{ mA}$) ($I_F = 10 \text{ mA}$)	V_F	— —	850 950	mV
Diode Capacitance ($V_R = 0 \text{ V}$, $f = 1.0 \text{ MHz}$)	C_D	—	2.0	pF
Reverse Recovery Time ($I_F = I_R = 10 \text{ mA}$) (Figure 1)	t_{rr}	—	3.0	μs



- Notes: 1. A 2.0 k Ω variable resistor adjusted for a Forward Current (I_F) of 10 mA.
 2. Input pulse is adjusted so $I_{R(\text{peak})}$ is equal to 10 mA.
 3. $t_p \gg t_{rr}$

Figure 1. Recovery Time Equivalent Test Circuit



Switching Diode

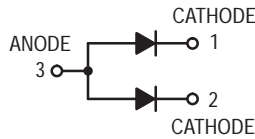
Part of the GreenLine™ Portfolio of devices with energy-conserving traits.

This switching diode has the following features:

- Very Low Leakage (≤ 500 pA) promotes extended battery life by decreasing energy waste. Guaranteed leakage limit is for each diode in the pair contingent upon the other diode being in a non-forward-biased condition.
- Offered in four Surface Mount package types
- Available in 8 mm Tape and Reel in quantities of 3,000

Applications

- ESD Protection
- Reverse Polarity Protection
- Steering Logic
- Medium-Speed Switching



MAXIMUM RATINGS

Rating	Symbol	Value	Unit
Continuous Reverse Voltage	V_R	30	Vdc
Peak Forward Current	I_F	200	mAdc
Peak Forward Surge Current	I_{FM} (surge)	500	mA

DEVICE MARKING

MMBD1005LT1 = A3
MMBD2005T1 = DI
MMBD3005T1 = XQ

THERMAL CHARACTERISTICS

Characteristic	Symbol	Max	Unit
Total Device Dissipation FR-4 Board (1) $T_A = 25^\circ\text{C}$	P_D	225	mW
MMBD1005LT1, MMBD3005T1 MMBD2005T1		150	
Derate above 25°C		1.8	mW/ $^\circ\text{C}$
MMBD1005LT1, MMBD3005T1 MMBD2005T1		1.2	
Thermal Resistance Junction to Ambient MMBD1005LT1, MMBD3005T1 MMBD2005T1	$R_{\theta JA}$	556 833	$^\circ\text{C/W}$
Junction and Storage Temperature	T_J, T_{stg}	-55 to +150	$^\circ\text{C}$

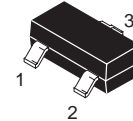
(1) Device mounted on a FR-4 glass epoxy printed circuit board using the minimum recommended footprint.

Preferred devices are Motorola recommended choices for future use and best overall value.

MMBD1005LT1 MMBD2005T1 MMBD3005T1

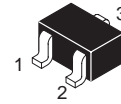
Motorola Preferred Devices

MMBD1005LT1



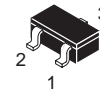
CASE 318-08, STYLE 12
SOT-23 (TO-236AB)

MMBD2005T1



CASE 419-02, STYLE 4
SC-70/SOT-323

MMBD3005T1

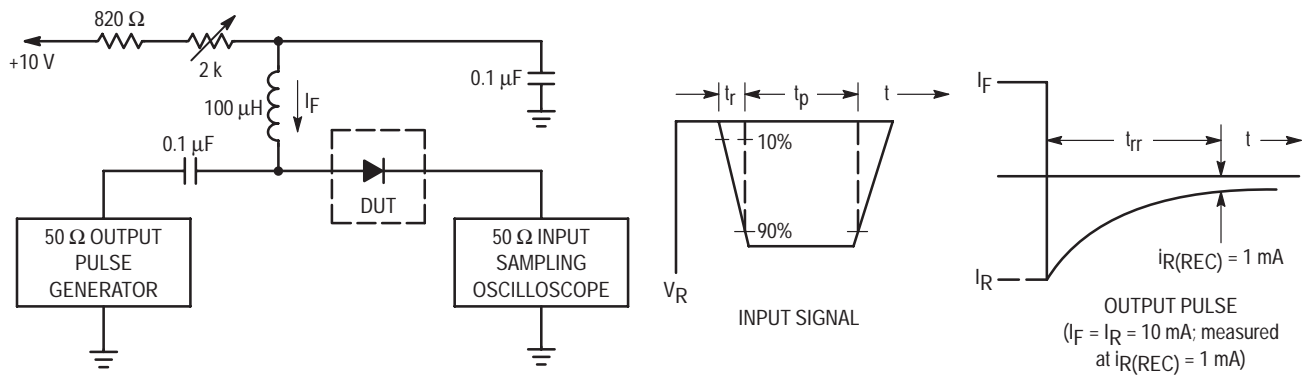


CASE 318D-04, STYLE 5
SC-59

ELECTRICAL CHARACTERISTICS ($T_A = 25^\circ\text{C}$ unless otherwise noted)

Characteristic	Symbol	Min	Max	Unit
OFF CHARACTERISTICS				
Reverse Breakdown Voltage ($I_{BR} = 100 \mu\text{A}$)	$V_{(BR)}$	30	—	V
Reverse Voltage Leakage Current ($V_R = 75 \text{V}$)(2)	I_R	—	500	pA
Forward Voltage ($I_F = 1.0 \text{mA}$) ($I_F = 10 \text{mA}$)	V_F	— —	850 950	mV
Diode Capacitance ($V_R = 0 \text{V}$, $f = 1.0 \text{MHz}$)	C_D	—	2.0	pF
Reverse Recovery Time ($I_F = I_R = 10 \text{mA}$) (Figure 1)	t_{rr}	—	3.0	μs

(2) Guaranteed leakage limit is for each diode in the pair contingent upon the other diode being in a non-forward-biased condition.



- Notes: 1. A 2.0 k Ω variable resistor adjusted for a Forward Current (I_F) of 10 mA.
- 2. Input pulse is adjusted so $I_{R(\text{peak})}$ is equal to 10 mA.
- 3. $t_p \gg t_{rr}$

Figure 1. Recovery Time Equivalent Test Circuit



Switching Diode

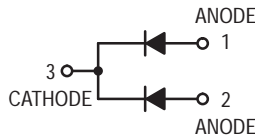
Part of the GreenLine™ Portfolio of devices with energy-conserving traits.

This switching diode has the following features:

- Very Low Leakage (≤ 500 pA) promotes extended battery life by decreasing energy waste. Guaranteed leakage limit is for each diode in the pair contingent upon the other diode being in a non-forward-biased condition.
- Offered in four Surface Mount package types
- Available in 8 mm Tape and Reel in quantities of 3,000

Applications

- ESD Protection
- Reverse Polarity Protection
- Steering Logic
- Medium-Speed Switching



MAXIMUM RATINGS

Rating	Symbol	Value	Unit
Continuous Reverse Voltage	V_R	30	Vdc
Peak Forward Current	I_F	200	mAdc
Peak Forward Surge Current	I_{FM} (surge)	500	mA

DEVICE MARKING

MMBD1010LT1 = A5
MMBD2010T1 = DP
MMBD3010T1 = XS

THERMAL CHARACTERISTICS

Characteristic	Symbol	Max	Unit
Total Device Dissipation FR-4 Board (1) $T_A = 25^\circ\text{C}$	P_D	225	mW
		150	
Derate above 25°C		1.8	mW/ $^\circ\text{C}$
		1.2	
Thermal Resistance Junction to Ambient	$R_{\theta JA}$	556	$^\circ\text{C}/\text{W}$
		833	
Junction and Storage Temperature	T_J, T_{stg}	-55 to +150	$^\circ\text{C}$

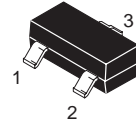
(1) Device mounted on a FR-4 glass epoxy printed circuit board using the minimum recommended footprint.

Preferred devices are Motorola recommended choices for future use and best overall value.

MMBD1010LT1 MMBD2010T1 MMBD3010T1

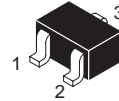
Motorola Preferred Devices

MMBD1010LT1



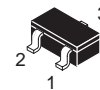
CASE 318-08, STYLE 9
SOT-23 (TO-236AB)

MMBD2010T1



CASE 419-02, STYLE 5
SC-70/SOT-323

MMBD3010T1

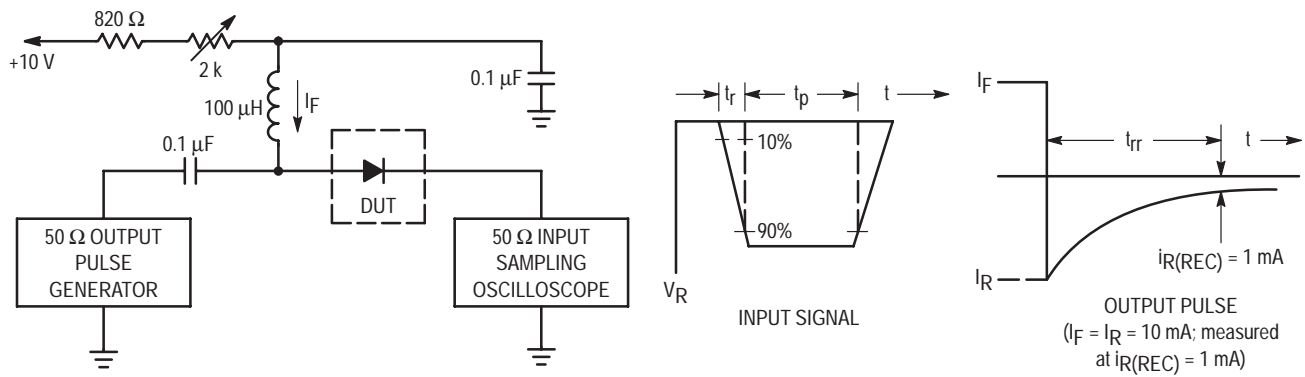


CASE 318D-04, STYLE 3
SC-59

ELECTRICAL CHARACTERISTICS ($T_A = 25^\circ\text{C}$ unless otherwise noted)

Characteristic	Symbol	Min	Max	Unit
OFF CHARACTERISTICS				
Reverse Breakdown Voltage ($I_{BR} = 100 \mu\text{A}$)	$V_{(BR)}$	30	—	V
Reverse Voltage Leakage Current ($V_R = 75 \text{V}$)(2)	I_R	—	500	pA
Forward Voltage ($I_F = 1.0 \text{mA}$) ($I_F = 10 \text{mA}$)	V_F	— —	850 950	mV
Diode Capacitance ($V_R = 0 \text{V}$, $f = 1.0 \text{MHz}$)	C_D	—	2.0	pF
Reverse Recovery Time ($I_F = I_R = 10 \text{mA}$) (Figure 1)	t_{rr}	—	3.0	μs

(2) Guaranteed leakage limit is for each diode in the pair contingent upon the other diode being in a non-forward-biased condition.



- Notes: 1. A 2.0 k Ω variable resistor adjusted for a Forward Current (I_F) of 10 mA.
- 2. Input pulse is adjusted so $I_{R(\text{peak})}$ is equal to 10 mA.
- 3. $t_p \gg t_{rr}$

Figure 1. Recovery Time Equivalent Test Circuit



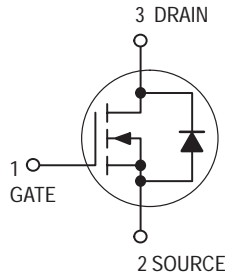
Low $r_{DS(on)}$ Small-Signal MOSFETs

TMOS Single N-Channel Field Effect Transistors

Part of the GreenLine™ Portfolio of devices with energy-conserving traits.

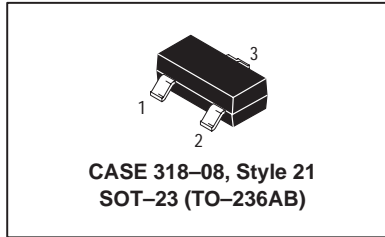
These miniature surface mount MOSFETs utilize Motorola's High Cell Density, HDTMOS process. Low $r_{DS(on)}$ assures minimal power loss and conserves energy, making this device ideal for use in small power management circuitry. Typical applications are dc-dc converters, power management in portable and battery-powered products such as computers, printers, PCMCIA cards, cellular and cordless telephones.

- Low $r_{DS(on)}$ Provides Higher Efficiency and Extends Battery Life
- Miniature SOT-23 Surface Mount Package Saves Board Space



MMBF0201NLT1
Motorola Preferred Device

**N-CHANNEL
ENHANCEMENT-MODE
TMOS MOSFET**
 $r_{DS(on)} = 1.0 \text{ OHM}$



MAXIMUM RATINGS ($T_J = 25^\circ\text{C}$ unless otherwise noted)

Rating	Symbol	Value	Unit
Drain-to-Source Voltage	V_{DSS}	20	Vdc
Gate-to-Source Voltage — Continuous	V_{GS}	± 20	Vdc
Drain Current — Continuous @ $T_A = 25^\circ\text{C}$ — Continuous @ $T_A = 70^\circ\text{C}$ — Pulsed Drain Current ($t_p \leq 10 \mu\text{s}$)	I_D I_D I_{DM}	300 240 750	mAdc
Total Power Dissipation @ $T_A = 25^\circ\text{C}^{(1)}$	P_D	225	mW
Operating and Storage Temperature Range	T_J, T_{stg}	-55 to 150	$^\circ\text{C}$
Thermal Resistance — Junction-to-Ambient	$R_{\theta JA}$	556	$^\circ\text{C/W}$
Maximum Lead Temperature for Soldering Purposes, 1/8" from case for 10 seconds	T_L	260	$^\circ\text{C}$

DEVICE MARKING

N1

(1) Mounted on G10/FR4 glass epoxy board using minimum recommended footprint.

ORDERING INFORMATION

Device	Reel Size	Tape Width	Quantity
MMBF0201NLT1	7"	12 mm embossed tape	3000
MMBF0201NLT3	13"	12 mm embossed tape	10,000

Preferred devices are Motorola recommended choices for future use and best overall value.

ELECTRICAL CHARACTERISTICS ($T_A = 25^\circ\text{C}$ unless otherwise noted)

Characteristic	Symbol	Min	Typ	Max	Unit
----------------	--------	-----	-----	-----	------

OFF CHARACTERISTICS

Drain-to-Source Breakdown Voltage ($V_{GS} = 0\text{ Vdc}$, $I_D = 10\ \mu\text{A}$)	$V_{(BR)DSS}$	20	—	—	Vdc
Zero Gate Voltage Drain Current ($V_{DS} = 16\text{ Vdc}$, $V_{GS} = 0\text{ Vdc}$) ($V_{DS} = 16\text{ Vdc}$, $V_{GS} = 0\text{ Vdc}$, $T_J = 125^\circ\text{C}$)	I_{DSS}	—	—	1.0 10	μAdc
Gate-Body Leakage Current ($V_{GS} = \pm 20\text{ Vdc}$, $V_{DS} = 0$)	I_{GSS}	—	—	± 100	nAdc

ON CHARACTERISTICS(1)

Gate Threshold Voltage ($V_{DS} = V_{GS}$, $I_D = 250\ \mu\text{Adc}$)	$V_{GS(th)}$	1.0	1.7	2.4	Vdc
Static Drain-to-Source On-Resistance ($V_{GS} = 10\text{ Vdc}$, $I_D = 300\text{ mAdc}$) ($V_{GS} = 4.5\text{ Vdc}$, $I_D = 100\text{ mAdc}$)	$r_{DS(on)}$	—	0.75 1.0	1.0 1.4	Ohms
Forward Transconductance ($V_{DS} = 10\text{ Vdc}$, $I_D = 200\text{ mAdc}$)	g_{FS}	—	450	—	mMhos

DYNAMIC CHARACTERISTICS

Input Capacitance	($V_{DS} = 5.0\text{ V}$)	C_{iss}	—	45	—	pF
Output Capacitance	($V_{DS} = 5.0\text{ V}$)	C_{oss}	—	25	—	
Transfer Capacitance	($V_{DG} = 5.0\text{ V}$)	C_{rss}	—	5.0	—	

SWITCHING CHARACTERISTICS(2)

Turn-On Delay Time	$(V_{DD} = 15\text{ Vdc}$, $I_D = 300\text{ mAdc}$, $R_L = 50\ \Omega)$	$t_{d(on)}$	—	2.5	—	ns
Rise Time		t_r	—	2.5	—	
Turn-Off Delay Time		$t_{d(off)}$	—	15	—	
Fall Time		t_f	—	0.8	—	
Gate Charge (See Figure 5)		Q_T	—	1400	—	pC

SOURCE-DRAIN DIODE CHARACTERISTICS

Continuous Current	I_S	—	—	0.3	A
Pulsed Current	I_{SM}	—	—	0.75	
Forward Voltage ⁽²⁾	V_{SD}	—	0.85	—	V

(1) Pulse Test: Pulse Width $\leq 300\ \mu\text{s}$, Duty Cycle $\leq 2\%$.

(2) Switching characteristics are independent of operating junction temperature.

TYPICAL ELECTRICAL CHARACTERISTICS

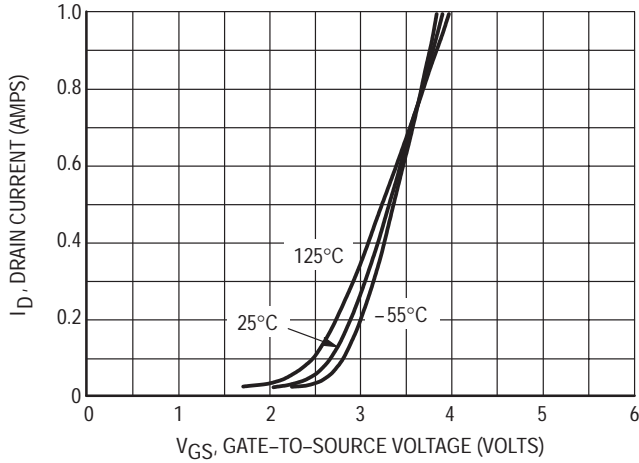


Figure 1. Transfer Characteristics

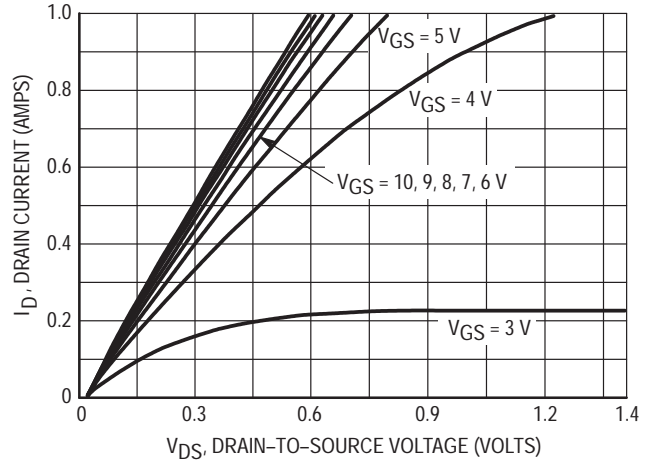


Figure 2. On-Region Characteristics

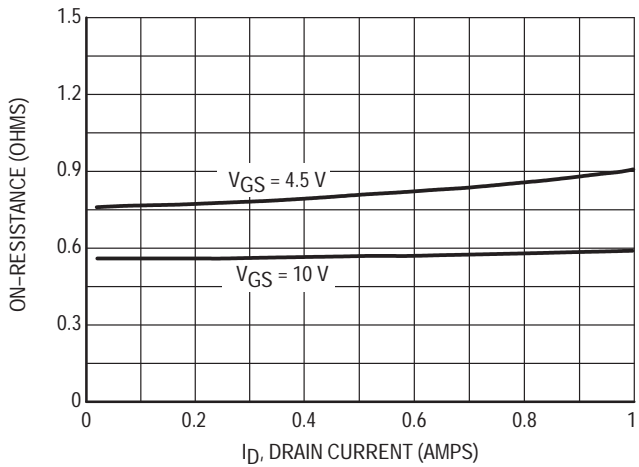


Figure 3. On-Resistance versus Drain Current

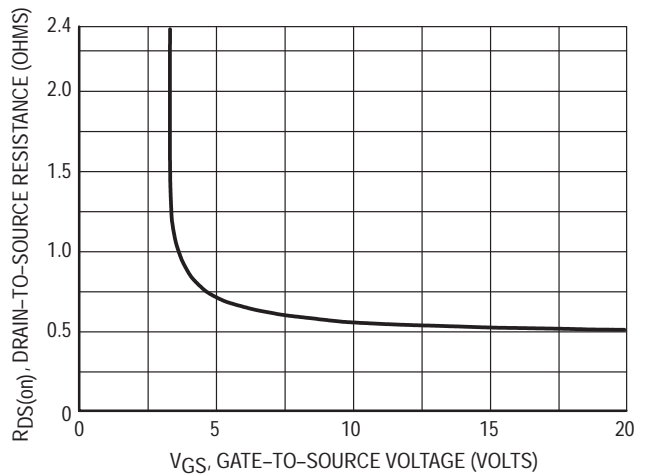


Figure 4. On-Resistance versus Gate-to-Source Voltage

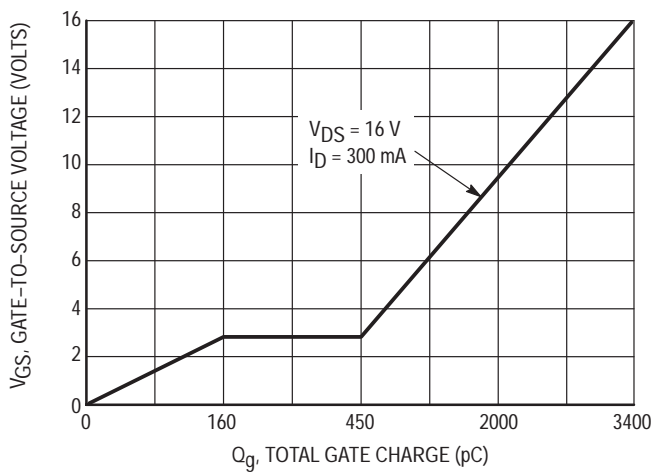


Figure 5. Gate Charge

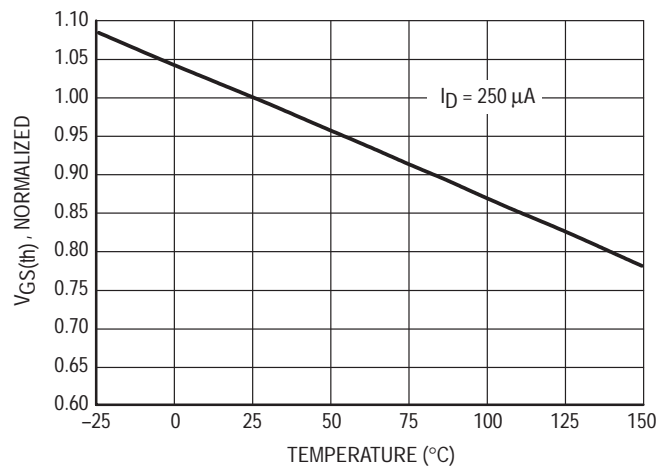


Figure 6. Threshold Voltage Variance Over Temperature

TYPICAL ELECTRICAL CHARACTERISTICS

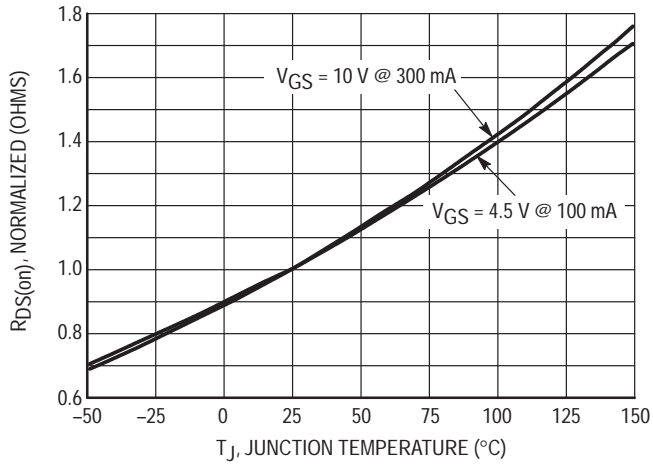


Figure 7. On-Resistance versus Junction Temperature

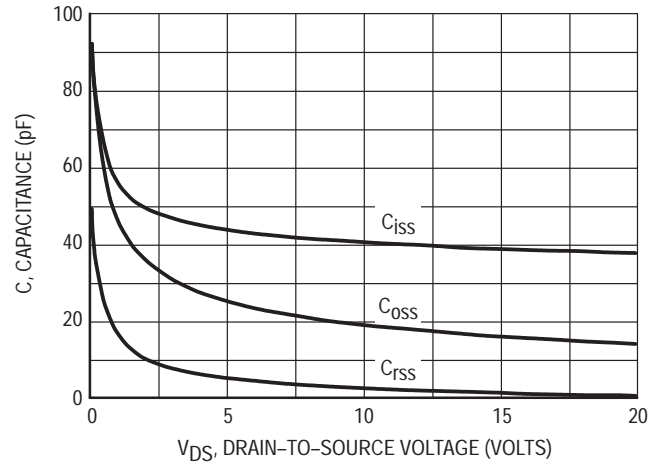


Figure 8. Capacitance

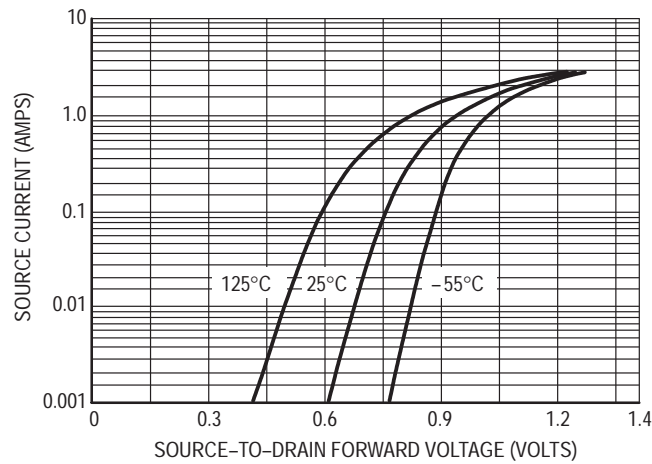


Figure 9. Source-to-Drain Forward Voltage versus Continuous Current (I_S)



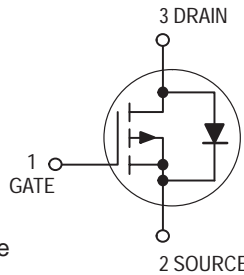
Low $r_{DS(on)}$ Small-Signal MOSFETs

TMOS Single P-Channel Field Effect Transistors

Part of the GreenLine™ Portfolio of devices with energy-conserving traits.

These miniature surface mount MOSFETs utilize Motorola's High Cell Density, HDTMOS process. Low $r_{DS(on)}$ assures minimal power loss and conserves energy, making this device ideal for use in small power management circuitry. Typical applications are dc-dc converters, power management in portable and battery-powered products such as computers, printers, PCMCIA cards, cellular and cordless telephones.

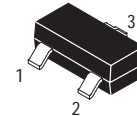
- Low $r_{DS(on)}$ Provides Higher Efficiency and Extends Battery Life
- Miniature SOT-23 Surface Mount Package Saves Board Space



MMBF0202PLT1

Motorola Preferred Device

P-CHANNEL
ENHANCEMENT-MODE
TMOS MOSFET
 $r_{DS(on)} = 1.4 \text{ OHM}$



CASE 318-08, Style 21
SOT-23 (TO-236AB)

MAXIMUM RATINGS ($T_J = 25^\circ\text{C}$ unless otherwise noted)

Rating	Symbol	Value	Unit
Drain-to-Source Voltage	V_{DSS}	20	Vdc
Gate-to-Source Voltage — Continuous	V_{GS}	± 20	Vdc
Drain Current — Continuous @ $T_A = 25^\circ\text{C}$ — Continuous @ $T_A = 70^\circ\text{C}$ — Pulsed Drain Current ($t_p \leq 10 \mu\text{s}$)	I_D I_D I_{DM}	300 240 750	mAdc
Total Power Dissipation @ $T_A = 25^\circ\text{C}$ (1)	P_D	225	mW
Operating and Storage Temperature Range	T_J, T_{stg}	-55 to 150	$^\circ\text{C}$
Thermal Resistance — Junction-to-Ambient	$R_{\theta JA}$	625	$^\circ\text{C/W}$
Maximum Lead Temperature for Soldering Purposes, 1/8" from case for 10 seconds	T_L	260	$^\circ\text{C}$

DEVICE MARKING

P3

(1) Mounted on G10/FR4 glass epoxy board using minimum recommended footprint.

ORDERING INFORMATION

Device	Reel Size	Tape Width	Quantity
MMBF0202PLT1	7"	12 mm embossed tape	3000
MMBF0202PLT3	13"	12 mm embossed tape	10,000

Preferred devices are Motorola recommended choices for future use and best overall value.

(Replaces MMBF0202P/D)

ELECTRICAL CHARACTERISTICS ($T_A = 25^\circ\text{C}$ unless otherwise noted)

Characteristic	Symbol	Min	Typ	Max	Unit
OFF CHARACTERISTICS					
Drain-to-Source Breakdown Voltage ($V_{GS} = 0\text{ Vdc}$, $I_D = 10\ \mu\text{A}$)	$V_{(BR)DSS}$	20	—	—	Vdc
Zero Gate Voltage Drain Current ($V_{DS} = 16\text{ Vdc}$, $V_{GS} = 0\text{ Vdc}$) ($V_{DS} = 16\text{ Vdc}$, $V_{GS} = 0\text{ Vdc}$, $T_J = 125^\circ\text{C}$)	I_{DSS}	—	—	1.0 10	μAdc
Gate-Body Leakage Current ($V_{GS} = \pm 20\text{ Vdc}$, $V_{DS} = 0$)	I_{GSS}	—	—	± 100	nAdc
ON CHARACTERISTICS(1)					
Gate Threshold Voltage ($V_{DS} = V_{GS}$, $I_D = 250\ \mu\text{Adc}$)	$V_{GS(th)}$	1.0	1.7	2.4	Vdc
Static Drain-to-Source On-Resistance ($V_{GS} = 10\text{ Vdc}$, $I_D = 200\text{ mAdc}$) ($V_{GS} = 4.5\text{ Vdc}$, $I_D = 50\text{ mAdc}$)	$r_{DS(on)}$	—	0.9 2.0	1.4 3.5	Ohms
Forward Transconductance ($V_{DS} = 10\text{ Vdc}$, $I_D = 200\text{ mAdc}$)	g_{FS}	—	600	—	mMhos
DYNAMIC CHARACTERISTICS					
Input Capacitance	($V_{DS} = 5.0\text{ V}$)	C_{iss}	—	50	pF
Output Capacitance	($V_{DS} = 5.0\text{ V}$)	C_{oss}	—	45	
Transfer Capacitance	($V_{DG} = 5.0\text{ V}$)	C_{rss}	—	20	
SWITCHING CHARACTERISTICS(2)					
Turn-On Delay Time	($V_{DD} = -15\text{ Vdc}$, $R_L = 75\ \Omega$, $I_D = 200\text{ mAdc}$, $V_{GEN} = -10\text{ V}$, $R_G = 6.0\ \Omega$)	$t_{d(on)}$	—	2.5	ns
Rise Time		t_r	—	1.0	
Turn-Off Delay Time		$t_{d(off)}$	—	16	
Fall Time		t_f	—	8.0	
Gate Charge (See Figure 5)	($V_{DS} = 16\text{ V}$, $V_{GS} = 10\text{ V}$, $I_D = 200\text{ mA}$)	Q_T	—	2700	pC
SOURCE-DRAIN DIODE CHARACTERISTICS					
Continuous Current	I_S	—	—	0.3	A
Pulsed Current	I_{SM}	—	—	0.75	
Forward Voltage ⁽²⁾	V_{SD}	—	1.5	—	V

(1) Pulse Test: Pulse Width $\leq 300\ \mu\text{s}$, Duty Cycle $\leq 2\%$.

(2) Switching characteristics are independent of operating junction temperature.

TYPICAL ELECTRICAL CHARACTERISTICS

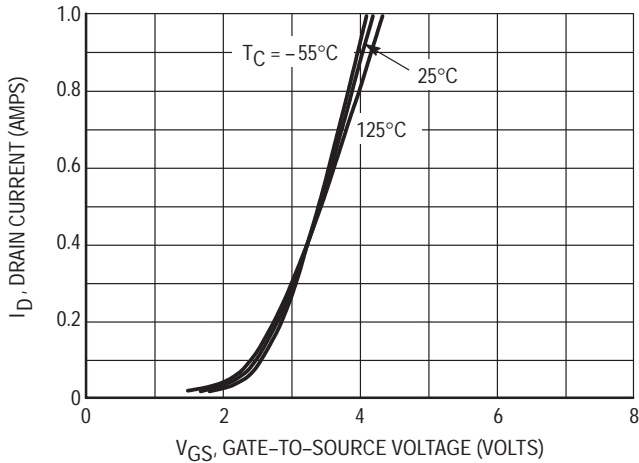


Figure 1. Transfer Characteristics

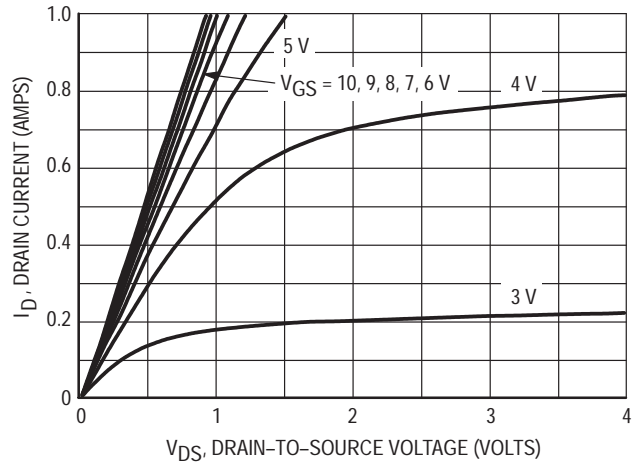


Figure 2. On-Region Characteristics

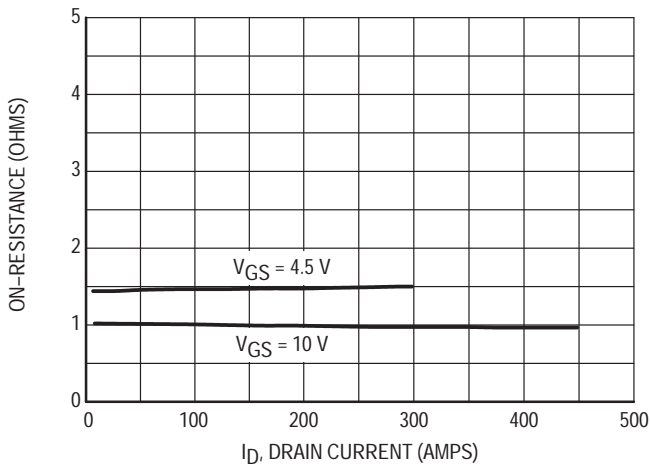


Figure 3. On-Resistance versus Drain Current

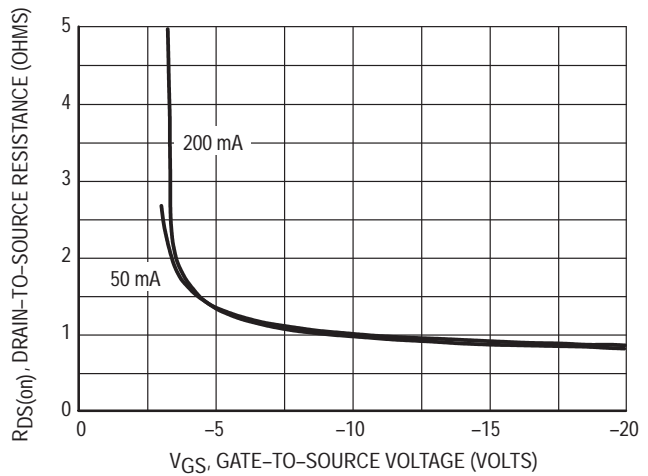


Figure 4. On-Resistance versus Gate-to-Source Voltage

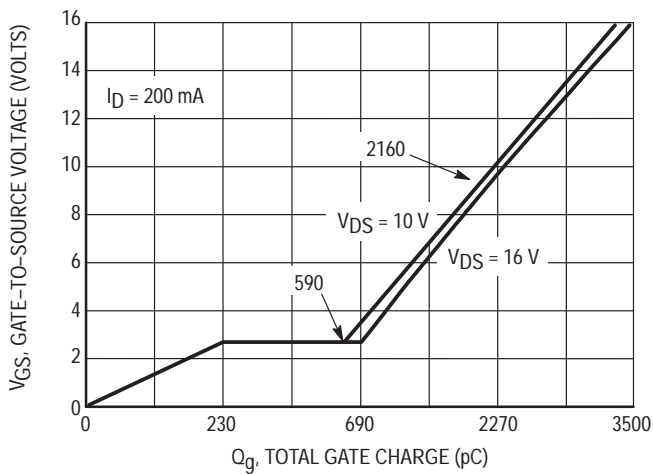


Figure 5. Gate Charge

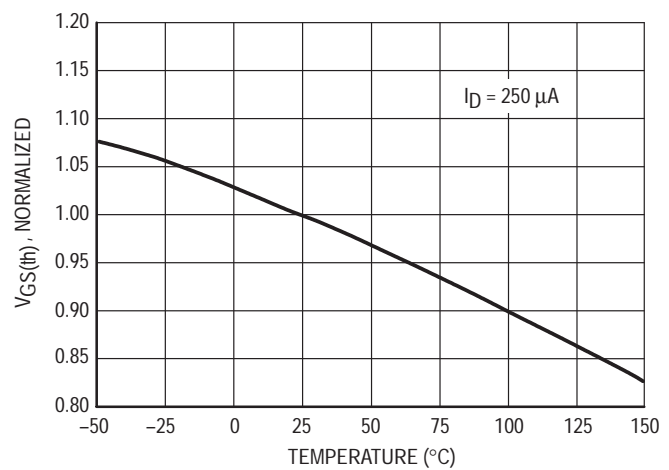


Figure 6. Threshold Voltage Variance Over Temperature

TYPICAL ELECTRICAL CHARACTERISTICS

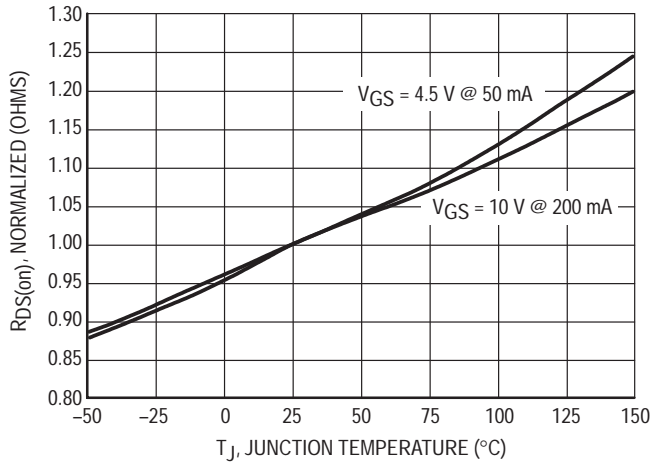


Figure 7. On-Resistance versus Junction Temperature

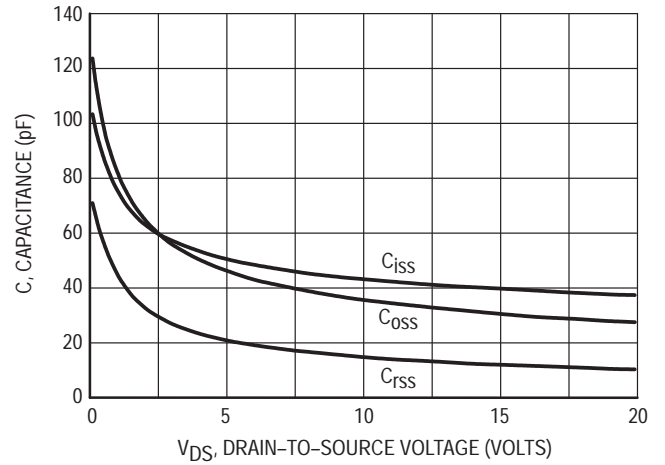


Figure 8. Capacitance

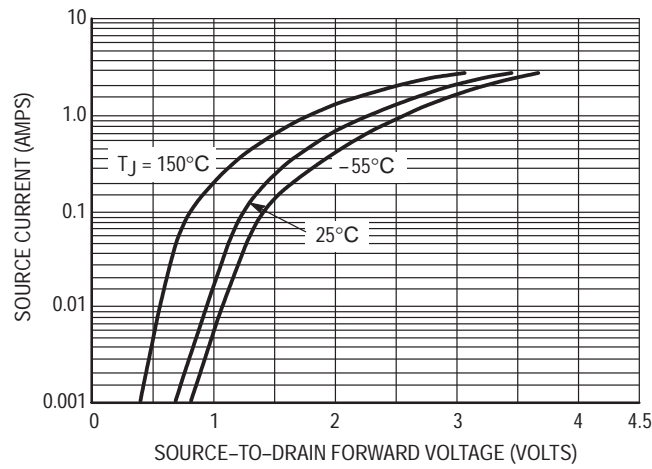


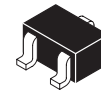
Figure 9. Source-to-Drain Forward Voltage versus Continuous Current (I_S)



MMBF2201NT1

Motorola Preferred Device

**N-CHANNEL
ENHANCEMENT-MODE
TMOS MOSFET**
 $r_{DS(on)} = 1.0 \text{ OHM}$



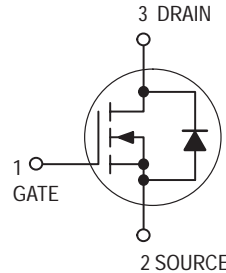
CASE 419-02, Style 7
SC-70/SOT-323

**Low $r_{DS(on)}$ Small-Signal MOSFETs
TMOS Single N-Channel
Field Effect Transistors**

Part of the GreenLine™ Portfolio of devices with energy-conserving traits.

These miniature surface mount MOSFETs utilize Motorola's High Cell Density, HDTMOS process. Low $r_{DS(on)}$ assures minimal power loss and conserves energy, making this device ideal for use in small power management circuitry. Typical applications are dc-dc converters, power management in portable and battery-powered products such as computers, printers, PCMCIA cards, cellular and cordless telephones.

- Low $r_{DS(on)}$ Provides Higher Efficiency and Extends Battery Life
- Miniature SC-70/SOT-323 Surface Mount Package Saves Board Space



MAXIMUM RATINGS ($T_J = 25^\circ\text{C}$ unless otherwise noted)

Rating	Symbol	Value	Unit
Drain-to-Source Voltage	V_{DSS}	20	Vdc
Gate-to-Source Voltage — Continuous	V_{GS}	± 20	Vdc
Drain Current — Continuous @ $T_A = 25^\circ\text{C}$ — Continuous @ $T_A = 70^\circ\text{C}$ — Pulsed Drain Current ($t_p \leq 10 \mu\text{s}$)	I_D I_D I_{DM}	300 240 750	mAdc
Total Power Dissipation @ $T_A = 25^\circ\text{C}$ (1) Derate above 25°C	P_D	150 1.2	mW mW/ $^\circ\text{C}$
Operating and Storage Temperature Range	T_J, T_{stg}	-55 to 150	$^\circ\text{C}$
Thermal Resistance — Junction-to-Ambient	$R_{\theta JA}$	833	$^\circ\text{C}/\text{W}$
Maximum Lead Temperature for Soldering Purposes, for 10 seconds	T_L	260	$^\circ\text{C}$

DEVICE MARKING

N1

(1) Mounted on G10/FR4 glass epoxy board using minimum recommended footprint.

ORDERING INFORMATION

Device	Reel Size	Tape Width	Quantity
MMBF2201NT1	7"	8 mm embossed tape	3000
MMBF2201NT3	13"	8 mm embossed tape	10,000

Preferred devices are Motorola recommended choices for future use and best overall value.

ELECTRICAL CHARACTERISTICS ($T_A = 25^\circ\text{C}$ unless otherwise noted)

Characteristic	Symbol	Min	Typ	Max	Unit
OFF CHARACTERISTICS					
Drain-to-Source Breakdown Voltage ($V_{GS} = 0\text{ Vdc}$, $I_D = 10\ \mu\text{A}$)	$V_{(BR)DSS}$	20	—	—	Vdc
Zero Gate Voltage Drain Current ($V_{DS} = 16\text{ Vdc}$, $V_{GS} = 0\text{ Vdc}$) ($V_{DS} = 16\text{ Vdc}$, $V_{GS} = 0\text{ Vdc}$, $T_J = 125^\circ\text{C}$)	I_{DSS}	—	—	1.0 10	μAdc
Gate-Body Leakage Current ($V_{GS} = \pm 20\text{ Vdc}$, $V_{DS} = 0$)	I_{GSS}	—	—	± 100	nAdc

ON CHARACTERISTICS(1)

Gate Threshold Voltage ($V_{DS} = V_{GS}$, $I_D = 250\ \mu\text{Adc}$)	$V_{GS(th)}$	1.0	1.7	2.4	Vdc
Static Drain-to-Source On-Resistance ($V_{GS} = 10\text{ Vdc}$, $I_D = 300\text{ mAdc}$) ($V_{GS} = 4.5\text{ Vdc}$, $I_D = 100\text{ mAdc}$)	$r_{DS(on)}$	—	0.75 1.0	1.0 1.4	Ohms
Forward Transconductance ($V_{DS} = 10\text{ Vdc}$, $I_D = 200\text{ mAdc}$)	g_{FS}	—	450	—	mMhos

DYNAMIC CHARACTERISTICS

Input Capacitance	($V_{DS} = 5.0\text{ V}$)	C_{iss}	—	45	—	pF
Output Capacitance	($V_{DS} = 5.0\text{ V}$)	C_{oss}	—	25	—	
Transfer Capacitance	($V_{DG} = 5.0\text{ V}$)	C_{rss}	—	5.0	—	

SWITCHING CHARACTERISTICS(2)

Turn-On Delay Time	$(V_{DD} = 15\text{ Vdc}$, $I_D = 300\text{ mAdc}$, $R_L = 50\ \Omega)$	$t_{d(on)}$	—	2.5	—	ns
Rise Time		t_r	—	2.5	—	
Turn-Off Delay Time		$t_{d(off)}$	—	15	—	
Fall Time		t_f	—	0.8	—	
Gate Charge (See Figure 5)		Q_T	—	1400	—	pC

SOURCE-DRAIN DIODE CHARACTERISTICS

Continuous Current	I_S	—	—	0.3	A
Pulsed Current	I_{SM}	—	—	0.75	
Forward Voltage(2)	V_{SD}	—	0.85	—	V

- (1) Pulse Test: Pulse Width $\leq 300\ \mu\text{s}$, Duty Cycle $\leq 2\%$.
- (2) Switching characteristics are independent of operating junction temperature.

TYPICAL CHARACTERISTICS

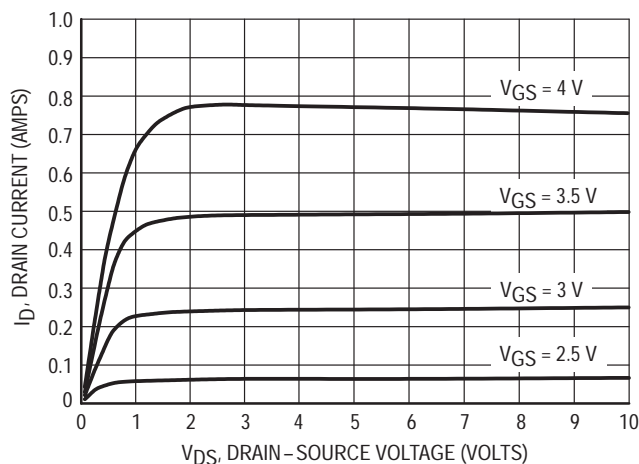


Figure 1. Typical Drain Characteristics

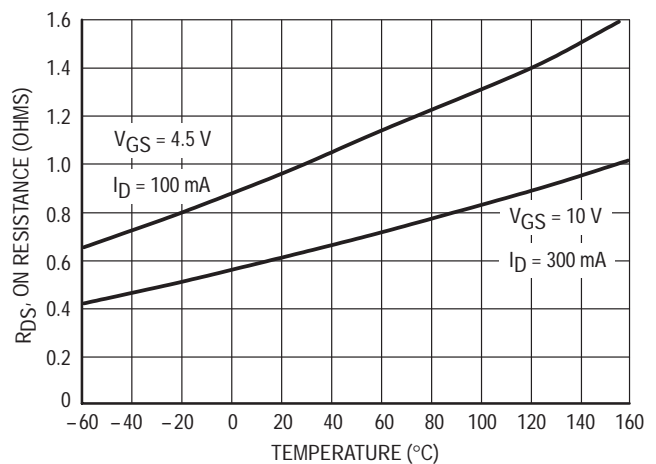


Figure 2. On Resistance versus Temperature

TYPICAL CHARACTERISTICS

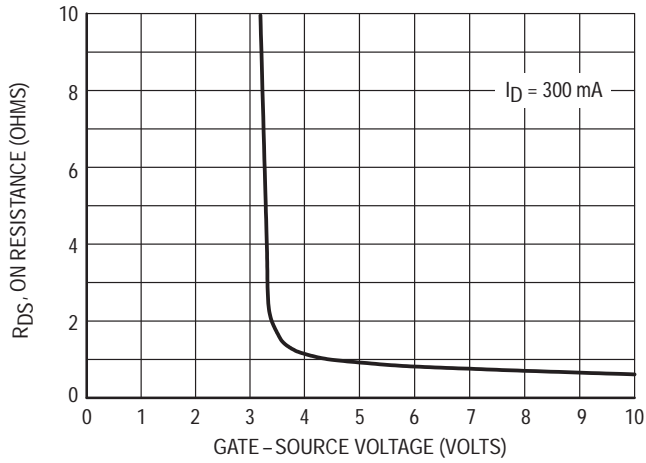


Figure 3. On Resistance versus Gate-Source Voltage

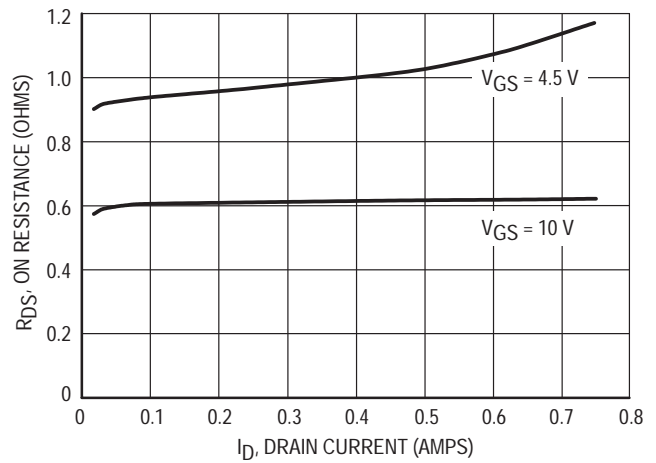


Figure 4. On Resistance versus Drain Current

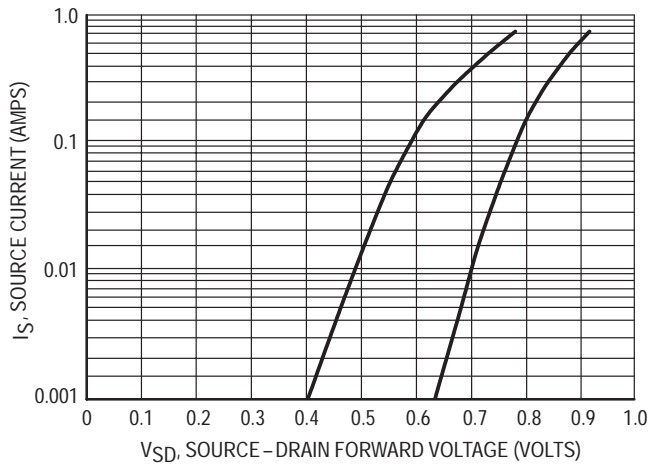


Figure 5. Source-Drain Forward Voltage

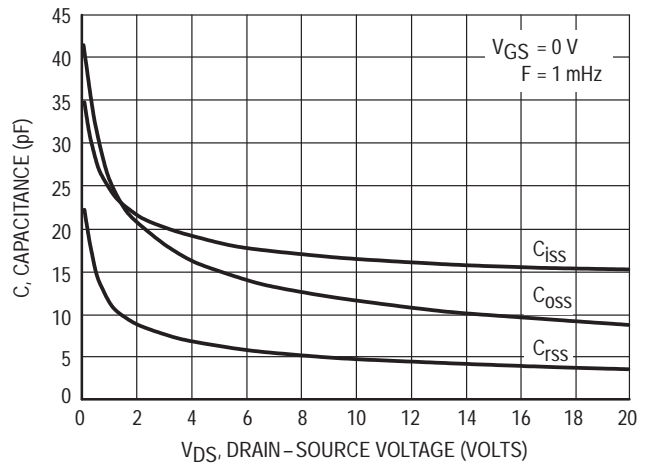


Figure 6. Capacitance Variation

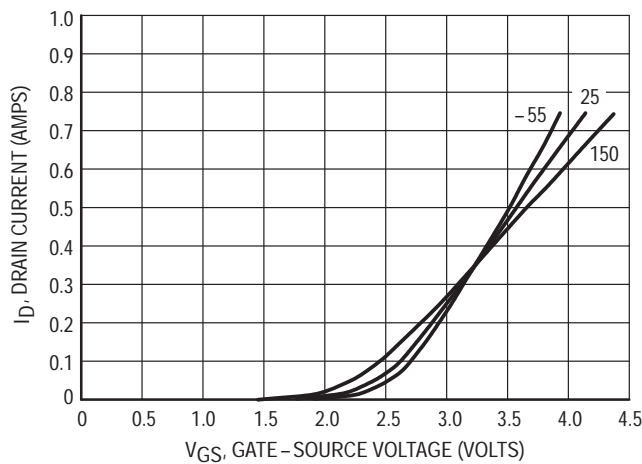


Figure 7. Transfer Characteristics

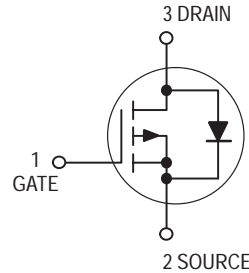


Low $r_{DS(on)}$ Small-Signal MOSFETs TMOS Single P-Channel Field Effect Transistors

Part of the GreenLine™ Portfolio of devices with energy-conserving traits.

These miniature surface mount MOSFETs utilize Motorola's High Cell Density, HDTMOS process. Low $r_{DS(on)}$ assures minimal power loss and conserves energy, making this device ideal for use in small power management circuitry. Typical applications are dc-dc converters, power management in portable and battery-powered products such as computers, printers, PCMCIA cards, cellular and cordless telephones.

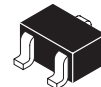
- Low $r_{DS(on)}$ Provides Higher Efficiency and Extends Battery Life
- Miniature SC-70/SOT-323 Surface Mount Package Saves Board Space



MMBF2202PT1

Motorola Preferred Device

P-CHANNEL
ENHANCEMENT-MODE
TMOS MOSFET
 $r_{DS(on)} = 2.2 \text{ OHM}$



CASE 419-02, STYLE 7
SC-70/SOT-323

MAXIMUM RATINGS ($T_J = 25^\circ\text{C}$ unless otherwise noted)

Rating	Symbol	Value	Unit
Drain-to-Source Voltage	V_{DS}	20	Vdc
Gate-to-Source Voltage — Continuous	V_{GS}	± 20	Vdc
Drain Current — Continuous @ $T_A = 25^\circ\text{C}$ — Continuous @ $T_A = 70^\circ\text{C}$ — Pulsed Drain Current ($t_p \leq 10 \mu\text{s}$)	I_D I_D I_{DM}	300 240 750	mAdc
Total Power Dissipation @ $T_A = 25^\circ\text{C}$ (1) Derate above 25°C	P_D	150 1.2	mW mW/°C
Operating and Storage Temperature Range	T_J, T_{stg}	-55 to 150	°C
Thermal Resistance — Junction-to-Ambient	$R_{\theta JA}$	833	°C/W
Maximum Lead Temperature for Soldering Purposes, for 10 seconds	T_L	260	°C

DEVICE MARKING

P3

(1) Mounted on G10/FR4 glass epoxy board using minimum recommended footprint.

ORDERING INFORMATION

Device	Reel Size	Tape Width	Quantity
MMBF2202PT1	7"	8 mm embossed tape	3000
MMBF2202PT3	13"	8 mm embossed tape	10,000

Preferred devices are Motorola recommended choices for future use and best overall value.

MMBF2202PT1

ELECTRICAL CHARACTERISTICS (T_A = 25°C unless otherwise noted)

Characteristic	Symbol	Min	Typ	Max	Unit
----------------	--------	-----	-----	-----	------

OFF CHARACTERISTICS

Drain-to-Source Breakdown Voltage (V _{GS} = 0 Vdc, I _D = 10 μA)	V _{(BR)DSS}	20	—	—	Vdc
Zero Gate Voltage Drain Current (V _{DS} = 16 Vdc, V _{GS} = 0 Vdc) (V _{DS} = 16 Vdc, V _{GS} = 0 Vdc, T _J = 125°C)	I _{DSS}	—	—	1.0 10	μAdc
Gate-Body Leakage Current (V _{GS} = ± 20 Vdc, V _{DS} = 0)	I _{GSS}	—	—	±100	nAdc

ON CHARACTERISTICS(1)

Gate Threshold Voltage (V _{DS} = V _{GS} , I _D = 250 μAdc)	V _{GS(th)}	1.0	1.7	2.4	Vdc
Static Drain-to-Source On-Resistance (V _{GS} = 10 Vdc, I _D = 200 mAdc) (V _{GS} = 4.5 Vdc, I _D = 50 mAdc)	r _{DS(on)}	—	1.5 2.0	2.2 3.5	Ohms
Forward Transconductance (V _{DS} = 10 Vdc, I _D = 200 mAdc)	g _{FS}	—	600	—	mMhos

DYNAMIC CHARACTERISTICS

Input Capacitance	(V _{DS} = 5.0 V)	C _{iss}	—	50	—	pF
Output Capacitance	(V _{DS} = 5.0 V)	C _{oss}	—	45	—	
Transfer Capacitance	(V _{DG} = 5.0 V)	C _{rss}	—	20	—	

SWITCHING CHARACTERISTICS(2)

Turn-On Delay Time	(V _{DD} = -15 Vdc, R _L = 75 Ω, I _D = 200 mAdc, V _{GEN} = -10 V, R _G = 6.0 Ω)	t _{d(on)}	—	2.5	—	ns
Rise Time		t _r	—	1.0	—	
Turn-Off Delay Time		t _{d(off)}	—	16	—	
Fall Time		t _f	—	8.0	—	
Gate Charge (See Figure 5)	(V _{DS} = 16 V, V _{GS} = 10 V, I _D = 200 mA)	Q _T	—	2700	—	pC

SOURCE-DRAIN DIODE CHARACTERISTICS

Continuous Current	I _S	—	—	0.3	A
Pulsed Current	I _{SM}	—	—	0.75	
Forward Voltage(2)	V _{SD}	—	1.5	—	V

(1) Pulse Test: Pulse Width ≤ 300 μs, Duty Cycle ≤ 2%.

(2) Switching characteristics are independent of operating junction temperature.

TYPICAL CHARACTERISTICS

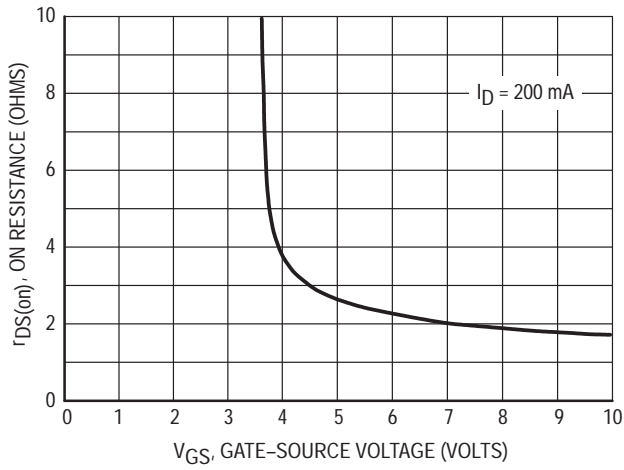


Figure 1. On Resistance versus Gate-Source Voltage

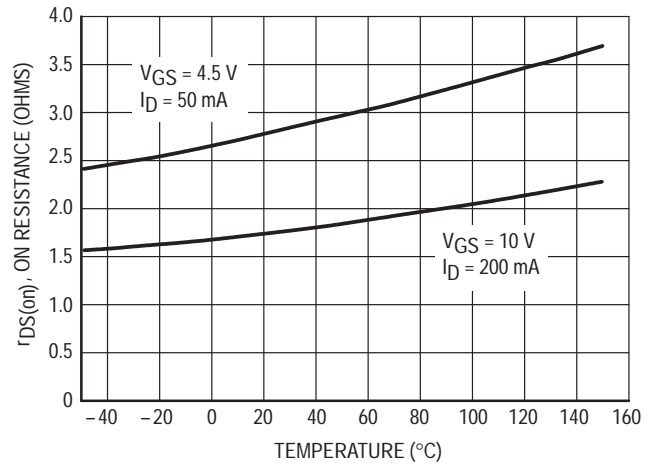


Figure 2. On Resistance versus Temperature

MMBF2202PT1

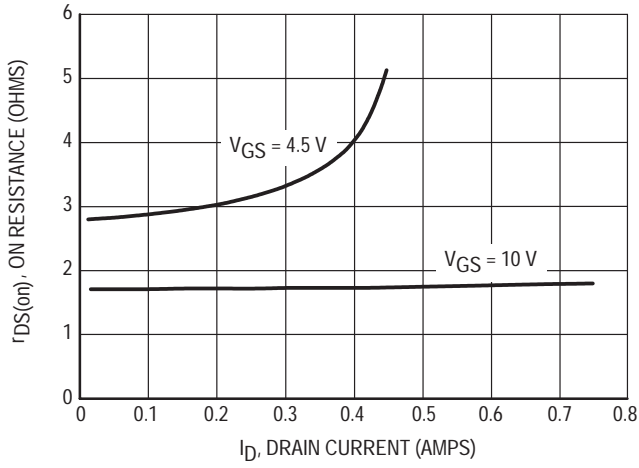


Figure 3. On Resistance versus Drain Current

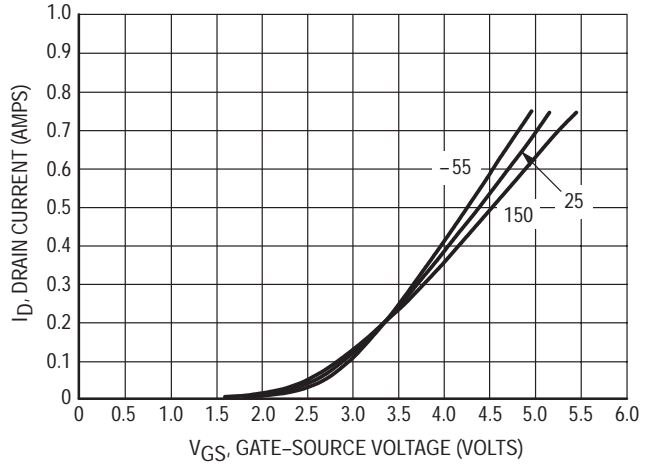


Figure 4. Transfer Characteristics

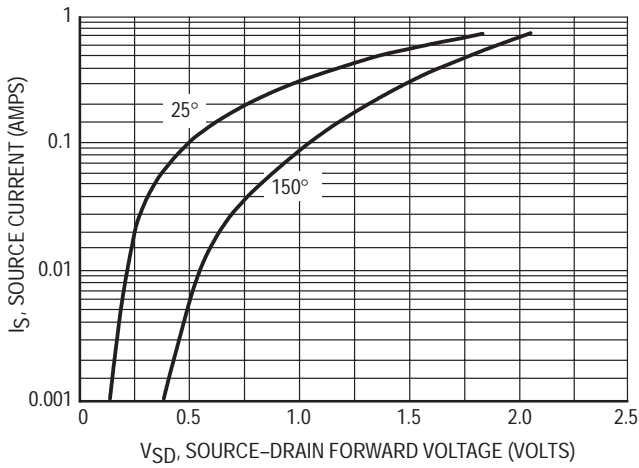


Figure 5. Source-Drain Forward Voltage

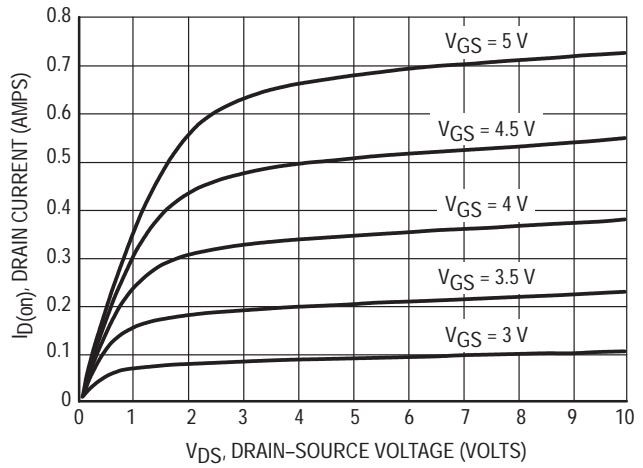


Figure 6. On Region Characteristics

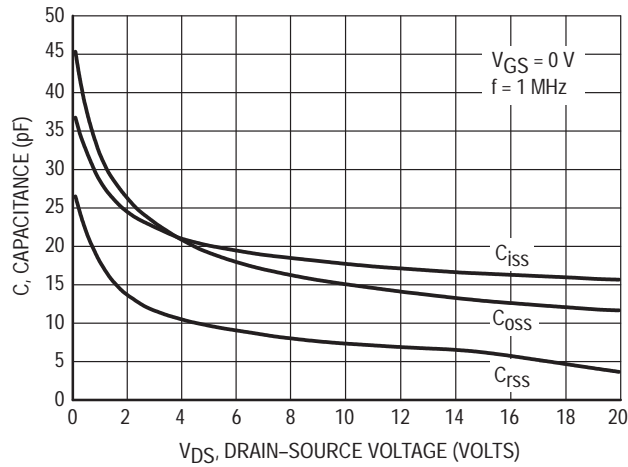


Figure 7. Capacitance Variation



Low Saturation Voltage PNP Silicon Driver Transistors

Part of the GreenLine™ Portfolio of devices with energy-conserving traits.

This PNP Silicon Epitaxial Planar Transistor is designed to conserve energy in general purpose driver applications. This device is housed in the SOT-23 and SC-59 packages which are designed for low power surface mount applications.

- Low $V_{CE(sat)}$, < 0.1 V at 50 mA

Applications

- LCD Backlight Driver
- Annunciator Driver
- General Output Device Driver

MAXIMUM RATINGS ($T_A = 25^\circ\text{C}$)

Rating	Symbol	Value	Unit
Collector-Base Voltage	$V_{(BR)CBO}$	45	Vdc
Collector-Emitter Voltage	$V_{(BR)CEO}$	15	Vdc
Emitter-Base Voltage	$V_{(BR)EBO}$	5.0	Vdc
Collector Current — Continuous	I_C	100	mAdc

DEVICE MARKING

MMBT1010LT1 = GLP MSD1010T1 = GLP

THERMAL CHARACTERISTICS

Rating	Symbol	Max	Unit
Power Dissipation $T_A = 25^\circ\text{C}$ Derate above 25°C	$P_D^{(1)}$	250 1.8	mW mW/°C
Thermal Resistance Junction to Ambient	$R_{\theta JA}$	556	°C/W
Junction Temperature	T_J	150	°C
Storage Temperature Range	T_{stg}	-55 ~ +150	°C

ELECTRICAL CHARACTERISTICS

Characteristic	Symbol	Condition	Min	Max	Unit
Collector-Emitter Breakdown Voltage	$V_{(BR)CEO}$	$I_C = 10\text{ mA}, I_B = 0$	15	—	Vdc
Emitter-Base Breakdown Voltage	$V_{(BR)EBO}$	$I_E = 10\ \mu\text{A}, I_C = 0$	5.0	—	Vdc
Collector-Base Cutoff Current	I_{CBO}	$V_{CB} = 20\text{ V}, I_E = 0$	—	0.1	μA
Collector-Emitter Cutoff Current	I_{CEO}	$V_{CE} = 10\text{ V}, I_B = 0$	—	100	μA
DC Current Gain	$h_{FE1}^{(2)}$	$V_{CE} = 5\text{ V}, I_C = 100\text{ mA}$	300	600	—
Collector-Emitter Saturation Voltage	$V_{CE(sat)}^{(2)}$	$I_C = 10\text{ mA}, I_B = 1.0\text{ mA}$ $I_C = 50\text{ mA}, I_B = 5.0\text{ mA}$ $I_C = 100\text{ mA}, I_B = 10\text{ mA}$	— —	0.1 0.1 0.19	Vdc
Base-Emitter Saturation Voltage	$V_{BE(sat)}^{(2)}$	$I_C = 100\text{ mA}, I_B = 10\text{ mA}$	—	1.1	Vdc

(1) Device mounted on a FR-4 glass epoxy printed circuit board using the minimum recommended footprint.

(2) Pulse Test: Pulse Width $\leq 300\ \mu\text{s}$, D.C. $\leq 2\%$.

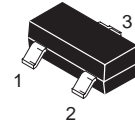
Preferred devices are Motorola recommended choices for future use and best overall value.

REV 2

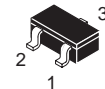
MMBT1010LT1 MSD1010T1

Motorola Preferred Devices

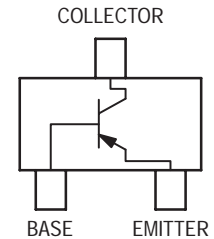
PNP GENERAL PURPOSE DRIVER TRANSISTORS SURFACE MOUNT



CASE 318-08, STYLE 6
SOT-23



CASE 318D-04, STYLE 1
SC-59



Section 4

Small-Signal Field-Effect Transistors and MOSFETs

In Brief . . .

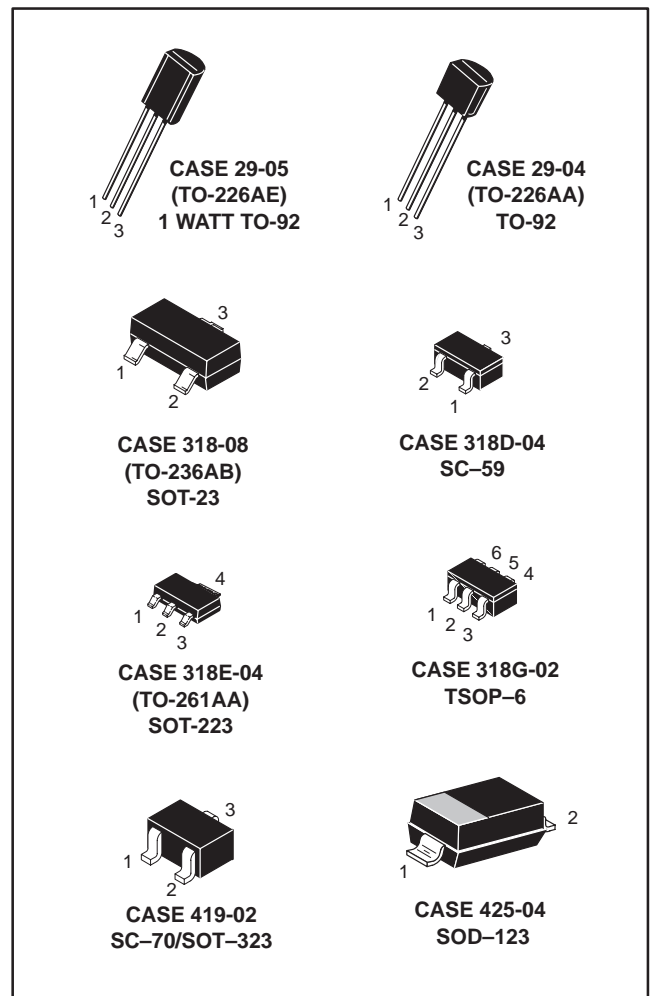
The data sheets on the following pages are designed to emphasize those FETs that by virtue of widespread industry use, ease of manufacture, and low relative cost, merit first consideration for new equipment design.

CAUTION:

Static electricity is a surface phenomenon which most commonly occurs when two dissimilar materials come into contact and then separate. Electro Static Discharge (ESD) damage of semiconductor components by operating personnel is quickly becoming a very prominent and significant problem. From simple bipolar designs to sensitive MOSFET structures, ESD has its unforgiving effect of degradation or destruction.

Motorola believes it is important to extend any emphasizing note of cautiousness when handling and testing ANY FET product. Precautions include, but are not limited to, the implementation of static safe workstations and proper handling techniques. Additionally, it is very important to keep FET devices in their antistatic shipping containers and away from static-generating materials.

NOTE: All SOT-23 package devices have had a "T1" suffix added to the device title.



EMBOSSSED TAPE AND REEL

SOT-23 and SOT-223 packages are available only in Tape and Reel. Use the appropriate suffix indicated below to order any of the SOT-23 and SOT-223 packages. (See Section 6 on Packaging for additional information).

SOT-23: available in 8 mm Tape and Reel
Use the device title (which already includes the "T1" suffix) to order the 7 inch/3000 unit reel.
Replace the "T1" suffix in the device title with a "T3" suffix to order the 13 inch/10,000 unit reel.

SOT-223: available in 12 mm Tape and Reel
Use the device title (which already includes the "T1" suffix) to order the 7 inch/1000 unit reel.
Replace the "T1" suffix in the device title with a "T3" suffix to order the 13 inch/4000 unit reel.

RADIAL TAPE IN FAN FOLD BOX OR REEL

TO-92 packages are available in both bulk shipments and in Radial Tape in Fan Fold Boxes or Reels. Fan Fold Boxes and Radial Tape Reel are the best methods for capturing devices for automatic insertion in printed circuit boards.

TO-92: available in Fan Fold Box
Add an "RLR" suffix and the appropriate Style code* to the device title to order the Fan Fold box.

available in 365 mm Radial Tape Reel
Add an "RLR" suffix and the appropriate Style code* to the device title to order the Radial Tape Reel.

*Refer to Section 6 on Packaging for Style code characters and additional information on ordering requirements.

DEVICE MARKINGS/DATE CODE CHARACTERS

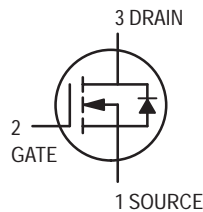
The **SOT-23 package has a device marking and a date code etched on the device.** The generic example below depicts both the device marking and a representation of the date code that appears on the SOT-23 package.



The "D" represents a smaller alpha digit Date Code. The Date Code indicates the actual month in which the part was manufactured.

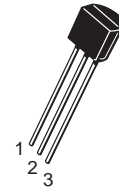
TMOS FET Transistor

N-Channel — Enhancement



2N7000

Motorola Preferred Device



CASE 29-04, STYLE 22
TO-92 (TO-226AA)

MAXIMUM RATINGS

Rating	Symbol	Value	Unit
Drain-Source Voltage	V_{DSS}	60	Vdc
Drain-Gate Voltage ($R_{GS} = 1.0 \text{ M}\Omega$)	V_{DGR}	60	Vdc
Gate-Source Voltage	V_{GS} V_{GSM}	± 20	Vdc
— Continuous — Non-repetitive ($t_p \leq 50 \mu\text{s}$)		± 40	Vpk
Drain Current	I_D I_{DM}	200	mAdc
— Continuous — Pulsed		500	
Total Power Dissipation @ $T_C = 25^\circ\text{C}$ Derate above 25°C	P_D	350 2.8	mW mW/ $^\circ\text{C}$
Operating and Storage Temperature Range	T_J, T_{stg}	-55 to +150	$^\circ\text{C}$

THERMAL CHARACTERISTICS

Characteristic	Symbol	Max	Unit
Thermal Resistance, Junction to Ambient	$R_{\theta JA}$	357	$^\circ\text{C}/\text{W}$
Maximum Lead Temperature for Soldering Purposes, 1/16" from case for 10 seconds	T_L	300	$^\circ\text{C}$

ELECTRICAL CHARACTERISTICS ($T_C = 25^\circ\text{C}$ unless otherwise noted)

Characteristic	Symbol	Min	Max	Unit
----------------	--------	-----	-----	------

OFF CHARACTERISTICS

Drain-Source Breakdown Voltage ($V_{GS} = 0, I_D = 10 \mu\text{Adc}$)	$V_{(BR)DSS}$	60	—	Vdc
Zero Gate Voltage Drain Current ($V_{DS} = 48 \text{ Vdc}, V_{GS} = 0$) ($V_{DS} = 48 \text{ Vdc}, V_{GS} = 0, T_J = 125^\circ\text{C}$)	I_{DSS}	— —	1.0 1.0	μAdc mAdc
Gate-Body Leakage Current, Forward ($V_{GSF} = 15 \text{ Vdc}, V_{DS} = 0$)	I_{GSSF}	—	-10	nAdc

ON CHARACTERISTICS(1)

Gate Threshold Voltage ($V_{DS} = V_{GS}, I_D = 1.0 \text{ mAdc}$)	$V_{GS(th)}$	0.8	3.0	Vdc
Static Drain-Source On-Resistance ($V_{GS} = 10 \text{ Vdc}, I_D = 0.5 \text{ Adc}$) ($V_{GS} = 4.5 \text{ Vdc}, I_D = 75 \text{ mAdc}$)	$r_{DS(on)}$	— —	5.0 6.0	Ohm
Drain-Source On-Voltage ($V_{GS} = 10 \text{ Vdc}, I_D = 0.5 \text{ Adc}$) ($V_{GS} = 4.5 \text{ Vdc}, I_D = 75 \text{ mAdc}$)	$V_{DS(on)}$	— —	2.5 0.45	Vdc

1. Pulse Test: Pulse Width $\leq 300 \mu\text{s}$, Duty Cycle $\leq 2.0\%$.

Preferred devices are Motorola recommended choices for future use and best overall value.

REV 3

ELECTRICAL CHARACTERISTICS ($T_C = 25^\circ\text{C}$ unless otherwise noted) (Continued)

Characteristic	Symbol	Min	Max	Unit
----------------	--------	-----	-----	------

ON CHARACTERISTICS(1) (continued)

On-State Drain Current ($V_{GS} = 4.5\text{ Vdc}$, $V_{DS} = 10\text{ Vdc}$)	$I_{d(on)}$	75	—	mAdc
Forward Transconductance ($V_{DS} = 10\text{ Vdc}$, $I_D = 200\text{ mAdc}$)	g_{fs}	100	—	μmhos

DYNAMIC CHARACTERISTICS

Input Capacitance	$(V_{DS} = 25\text{ V}$, $V_{GS} = 0$, $f = 1.0\text{ MHz}$)	C_{iss}	—	60	pF
Output Capacitance		C_{oss}	—	25	
Reverse Transfer Capacitance		C_{rss}	—	5.0	

SWITCHING CHARACTERISTICS(1)

Turn-On Delay Time	$(V_{DD} = 15\text{ V}$, $I_D = 500\text{ mA}$, $R_{gen} = 25\text{ ohms}$, $R_L = 25\text{ ohms}$)	t_{on}	—	10	ns
Turn-Off Delay Time		t_{off}	—	10	

1. Pulse Test: Pulse Width $\leq 300\ \mu\text{s}$, Duty Cycle $\leq 2.0\%$.

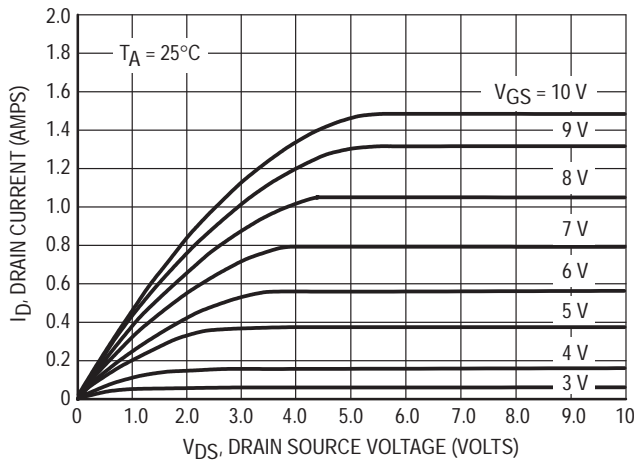


Figure 1. Ohmic Region

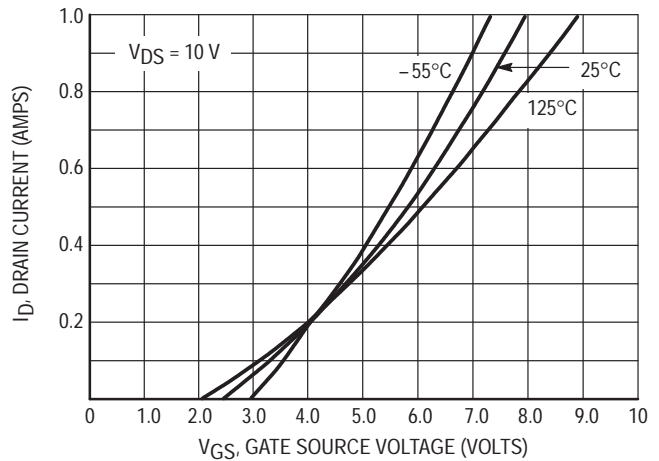


Figure 2. Transfer Characteristics

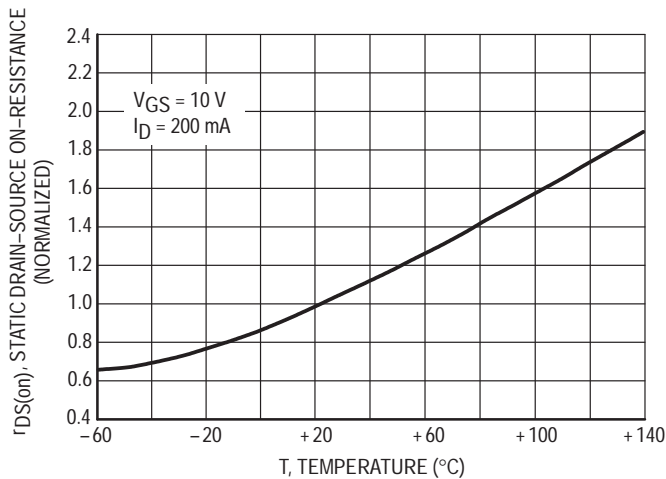


Figure 3. Temperature versus Static Drain-Source On-Resistance

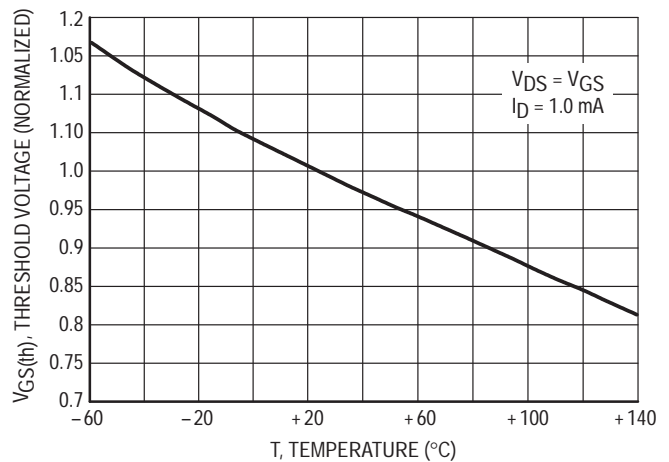


Figure 4. Temperature versus Gate Threshold Voltage

2N7002LT1

ELECTRICAL CHARACTERISTICS ($T_A = 25^\circ\text{C}$ unless otherwise noted) (Continued)

Characteristic	Symbol	Min	Typ	Max	Unit
ON CHARACTERISTICS(2)					
Gate Threshold Voltage ($V_{DS} = V_{GS}$, $I_D = 250 \mu\text{Adc}$)	$V_{GS(th)}$	1.0	—	2.5	Vdc
On-State Drain Current ($V_{DS} \geq 2.0 V_{DS(on)}$, $V_{GS} = 10 \text{ Vdc}$)	$I_{D(on)}$	500	—	—	mA
Static Drain-Source On-State Voltage ($V_{GS} = 10 \text{ Vdc}$, $I_D = 500 \text{ mAdc}$) ($V_{GS} = 5.0 \text{ Vdc}$, $I_D = 50 \text{ mAdc}$)	$V_{DS(on)}$	— —	— —	3.75 0.375	Vdc
Static Drain-Source On-State Resistance ($V_{GS} = 10 \text{ V}$, $I_D = 500 \text{ mAdc}$) $T_C = 25^\circ\text{C}$ $T_C = 125^\circ\text{C}$ ($V_{GS} = 5.0 \text{ Vdc}$, $I_D = 50 \text{ mAdc}$) $T_C = 25^\circ\text{C}$ $T_C = 125^\circ\text{C}$	$r_{DS(on)}$	— — — —	— — — —	7.5 13.5 7.5 13.5	Ohms
Forward Transconductance ($V_{DS} \geq 2.0 V_{DS(on)}$, $I_D = 200 \text{ mAdc}$)	g_{FS}	80	—	—	mmhos

DYNAMIC CHARACTERISTICS

Input Capacitance ($V_{DS} = 25 \text{ Vdc}$, $V_{GS} = 0$, $f = 1.0 \text{ MHz}$)	C_{iss}	—	—	50	pF
Output Capacitance ($V_{DS} = 25 \text{ Vdc}$, $V_{GS} = 0$, $f = 1.0 \text{ MHz}$)	C_{oss}	—	—	25	pF
Reverse Transfer Capacitance ($V_{DS} = 25 \text{ Vdc}$, $V_{GS} = 0$, $f = 1.0 \text{ MHz}$)	C_{rss}	—	—	5.0	pF

SWITCHING CHARACTERISTICS(2)

Turn-On Delay Time	($V_{DD} = 25 \text{ Vdc}$, $I_D \cong 500 \text{ mAdc}$, $R_G = 25 \Omega$, $R_L = 50 \Omega$)	$t_{d(on)}$	—	—	30	ns
Turn-Off Delay Time		$t_{d(off)}$	—	—	40	ns

BODY-DRAIN DIODE RATINGS

Diode Forward On-Voltage ($I_S = 11.5 \text{ mAdc}$, $V_{GS} = 0 \text{ V}$)	V_{SD}	—	—	-1.5	Vdc
Source Current Continuous (Body Diode)	I_S	—	—	-115	mAdc
Source Current Pulsed	I_{SM}	—	—	-800	mAdc

2. Pulse Test: Pulse Width $\leq 300 \mu\text{s}$, Duty Cycle $\leq 2.0\%$.

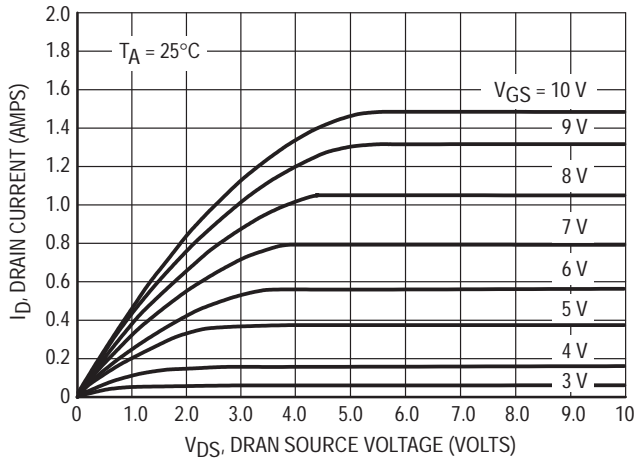


Figure 1. Ohmic Region

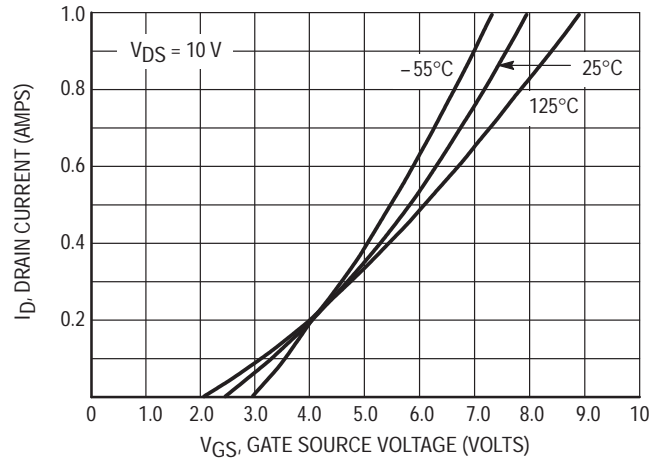


Figure 2. Transfer Characteristics

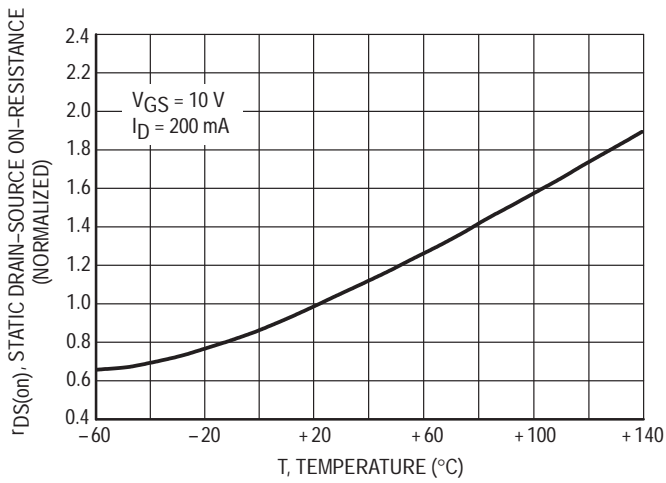


Figure 3. Temperature versus Static Drain-Source On-Resistance

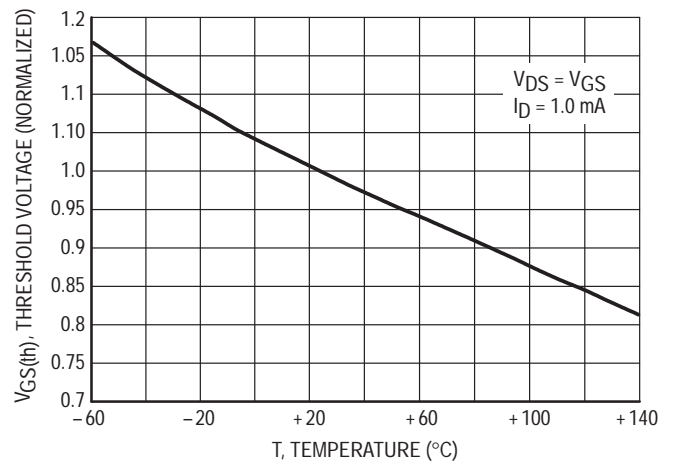
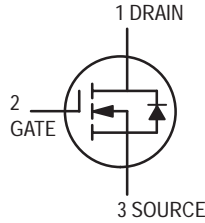


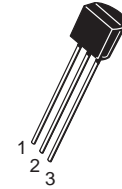
Figure 4. Temperature versus Gate Threshold Voltage

TMOS Switching

N-Channel — Enhancement



BS107
BS107A



CASE 29-04, STYLE 30
TO-92 (TO-226AA)

MAXIMUM RATINGS

Rating	Symbol	Value	Unit
Drain-Source Voltage	V_{DS}	200	Vdc
Gate-Source Voltage	V_{GS}	± 20	Vdc
— Continuous	V_{GS}	± 20	Vdc
— Non-repetitive ($t_p \leq 50 \mu s$)	V_{GSM}	± 30	Vpk
Drain Current	I_D	250	mAdc
Continuous(1)	I_D	250	mAdc
Pulsed(2)	I_{DM}	500	mAdc
Total Device Dissipation @ $T_A = 25^\circ C$ Derate above $25^\circ C$	P_D	350	mW
Operating and Storage Junction Temperature Range	T_J, T_{stg}	-55 to 150	$^\circ C$

ELECTRICAL CHARACTERISTICS ($T_A = 25^\circ C$ unless otherwise noted)

Characteristic	Symbol	Min	Typ	Max	Unit
----------------	--------	-----	-----	-----	------

OFF CHARACTERISTICS

Zero-Gate-Voltage Drain Current ($V_{DS} = 130 \text{ Vdc}, V_{GS} = 0$)	I_{DSS}	—	—	30	nAdc
Drain-Source Breakdown Voltage ($V_{GS} = 0, I_D = 100 \mu \text{Adc}$)	$V_{(BR)DSX}$	200	—	—	Vdc
Gate Reverse Current ($V_{GS} = 15 \text{ Vdc}, V_{DS} = 0$)	I_{GSS}	—	0.01	10	nAdc

ON CHARACTERISTICS(2)

Gate Threshold Voltage ($I_D = 1.0 \text{ mAdc}, V_{DS} = V_{GS}$)	$V_{GS(Th)}$	1.0	—	3.0	Vdc
Static Drain-Source On Resistance	$r_{DS(on)}$	—	—	—	Ohms
BS107 ($V_{GS} = 2.6 \text{ Vdc}, I_D = 20 \text{ mAdc}$)		—	—	28	
($V_{GS} = 10 \text{ Vdc}, I_D = 200 \text{ mAdc}$)		—	—	14	
BS107A ($V_{GS} = 10 \text{ Vdc}$)		—	4.5	6.0	
($I_D = 100 \text{ mAdc}$)		—	4.8	6.4	
($I_D = 250 \text{ mAdc}$)		—	—	—	

SMALL-SIGNAL CHARACTERISTICS

Input Capacitance ($V_{DS} = 25 \text{ Vdc}, V_{GS} = 0, f = 1.0 \text{ MHz}$)	C_{iss}	—	60	—	pF
Reverse Transfer Capacitance ($V_{DS} = 25 \text{ Vdc}, V_{GS} = 0, f = 1.0 \text{ MHz}$)	C_{rss}	—	6.0	—	pF
Output Capacitance ($V_{DS} = 25 \text{ Vdc}, V_{GS} = 0, f = 1.0 \text{ MHz}$)	C_{oss}	—	30	—	pF
Forward Transconductance ($V_{DS} = 25 \text{ Vdc}, I_D = 250 \text{ mAdc}$)	g_{fs}	200	400	—	mmhos

SWITCHING CHARACTERISTICS

Turn-On Time	t_{on}	—	6.0	15	ns
Turn-Off Time	t_{off}	—	12	15	ns

1. The Power Dissipation of the package may result in a lower continuous drain current.
2. Pulse Test: Pulse Width $\leq 300 \mu s$, Duty Cycle $\leq 2.0\%$.

RESISTIVE SWITCHING

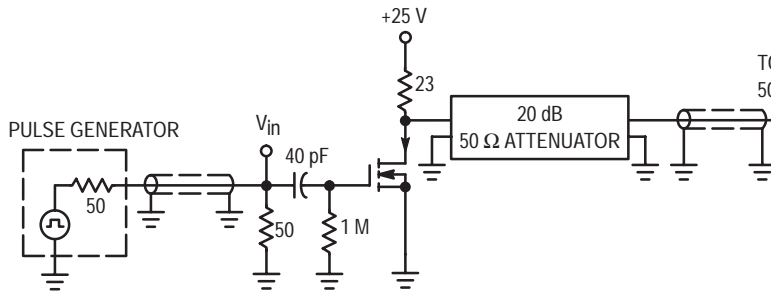


Figure 1. Switching Test Circuit

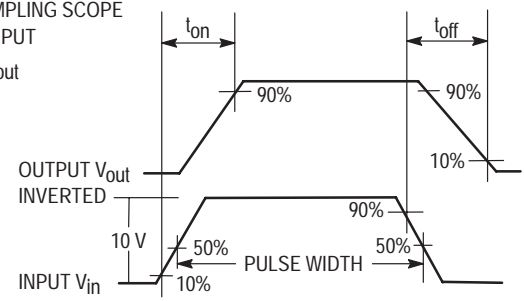


Figure 2. Switching Waveforms

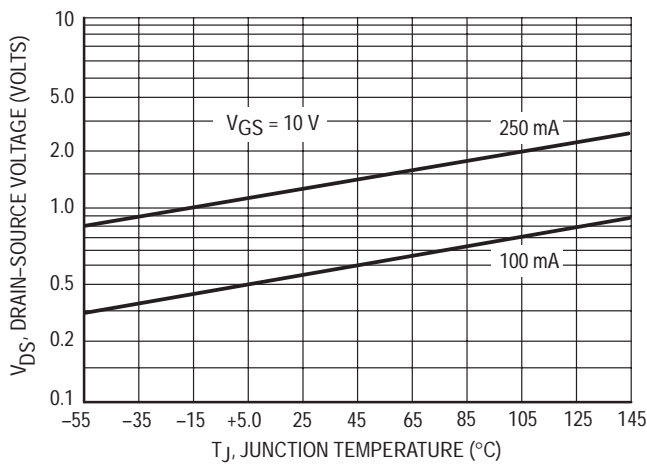


Figure 3. On Voltage versus Temperature

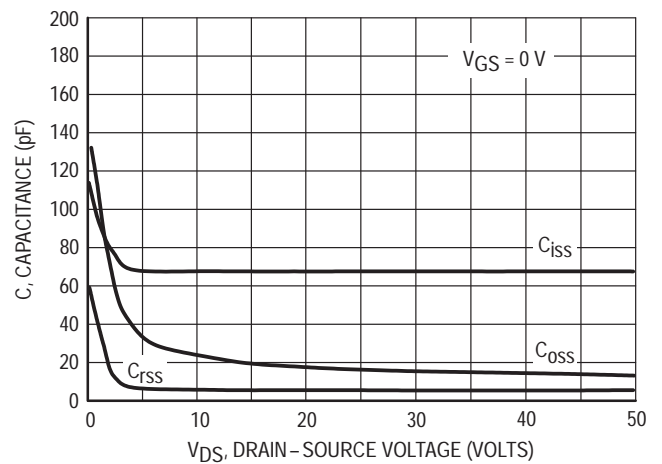


Figure 4. Capacitance Variation

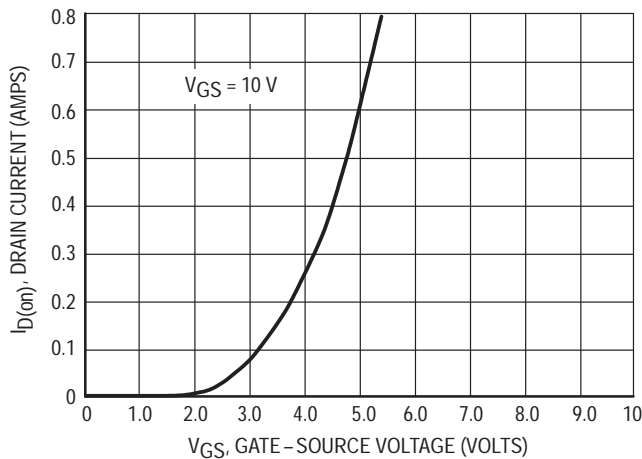


Figure 5. Transfer Characteristic

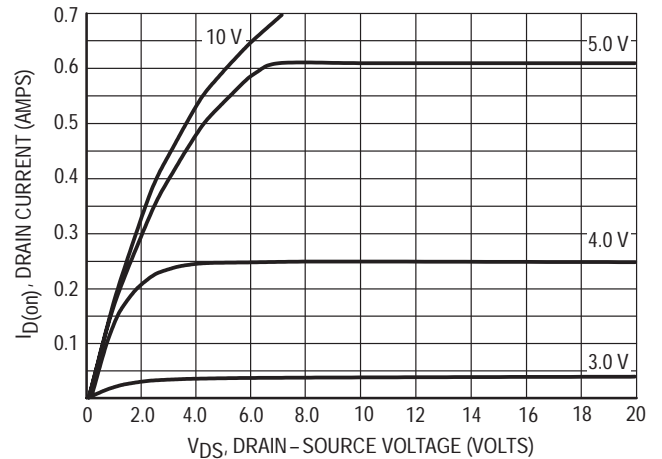


Figure 6. Output Characteristic

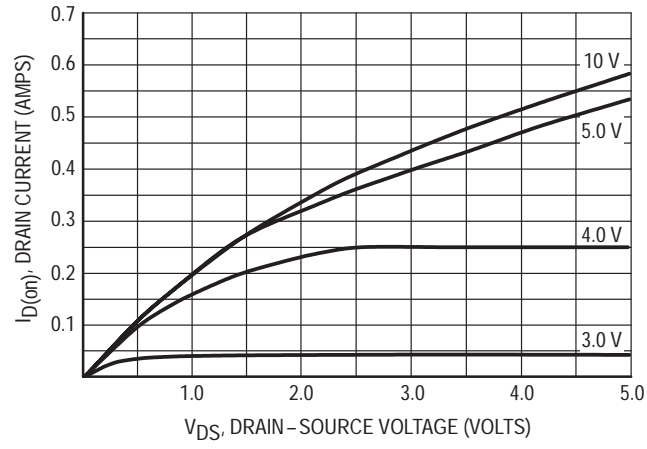
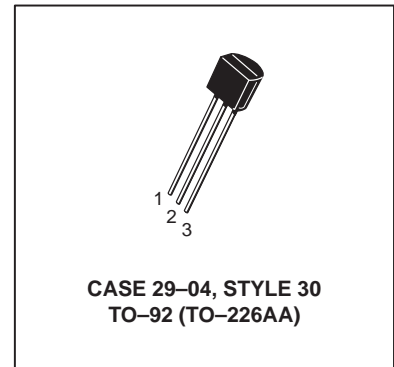
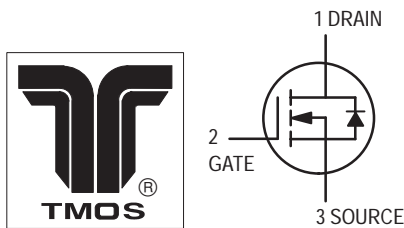


Figure 7. Saturation Characteristic

TMOS FET Switching

N-Channel — Enhancement



MAXIMUM RATINGS

Rating	Symbol	Value	Unit
Drain-Source Voltage	V_{DS}	60	Vdc
Gate-Source Voltage	V_{GS}	± 20	Vdc
— Continuous	V_{GSM}	± 40	Vpk
— Non-repetitive ($t_p \leq 50 \mu s$)			
Drain Current ⁽¹⁾	I_D	0.5	Adc
Total Device Dissipation @ $T_A = 25^\circ C$	P_D	350	mW
Operating and Storage Junction Temperature Range	T_J, T_{stg}	-55 to +150	$^\circ C$

ELECTRICAL CHARACTERISTICS ($T_A = 25^\circ C$ unless otherwise noted)

Characteristic	Symbol	Min	Typ	Max	Unit
----------------	--------	-----	-----	-----	------

OFF CHARACTERISTICS

Gate Reverse Current ($V_{GS} = 15 \text{ Vdc}, V_{DS} = 0$)	I_{GSS}	—	0.01	10	nAdc
Drain-Source Breakdown Voltage ($V_{GS} = 0, I_D = 100 \mu \text{Adc}$)	$V_{(BR)DSS}$	60	90	—	Vdc

ON CHARACTERISTICS⁽²⁾

Gate Threshold Voltage ($V_{DS} = V_{GS}, I_D = 1.0 \text{ mAdc}$)	$V_{GS(Th)}$	0.8	2.0	3.0	Vdc
Static Drain-Source On Resistance ($V_{GS} = 10 \text{ Vdc}, I_D = 200 \text{ mAdc}$)	$r_{DS(on)}$	—	1.8	5.0	Ω
Drain Cutoff Current ($V_{DS} = 25 \text{ Vdc}, V_{GS} = 0 \text{ Vdc}$)	$I_{D(off)}$	—	—	0.5	μA
Forward Transconductance ($V_{DS} = 10 \text{ Vdc}, I_D = 250 \text{ mAdc}$)	g_{fs}	—	200	—	mmhos

SMALL-SIGNAL CHARACTERISTICS

Input Capacitance ($V_{DS} = 10 \text{ Vdc}, V_{GS} = 0, f = 1.0 \text{ MHz}$)	C_{iss}	—	—	60	pF
-------------------------------------------------------------------------------------	-----------	---	---	----	----

SWITCHING CHARACTERISTICS

Turn-On Time ($I_D = 0.2 \text{ Adc}$) See Figure 1	t_{on}	—	4.0	10	ns
Turn-Off Time ($I_D = 0.2 \text{ Adc}$) See Figure 1	t_{off}	—	4.0	10	ns

1. The Power Dissipation of the package may result in a lower continuous drain current.
2. Pulse Test: Pulse Width $\leq 300 \mu s$, Duty Cycle $\leq 2.0\%$.

RESISTIVE SWITCHING

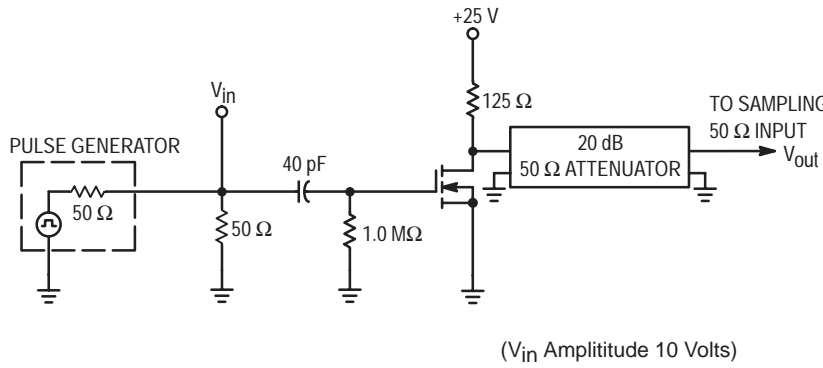


Figure 1. Switching Test Circuit

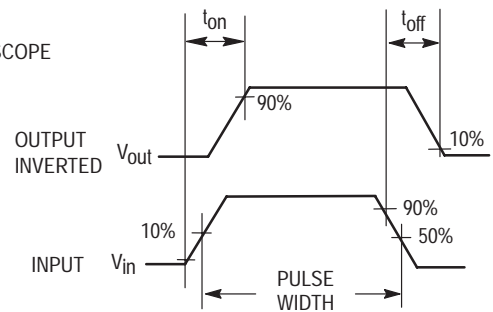


Figure 2. Switching Waveforms

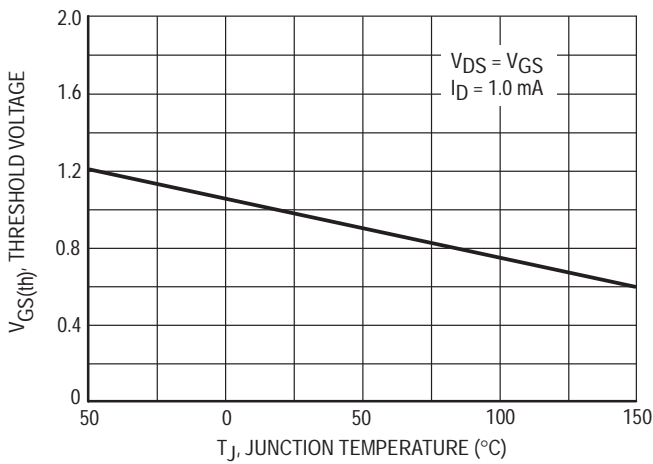


Figure 3. $V_{GS(th)}$ Normalized versus Temperature

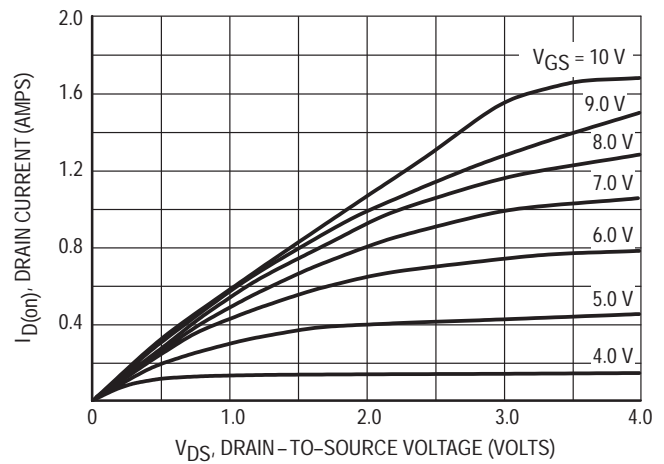


Figure 4. On-Region Characteristics

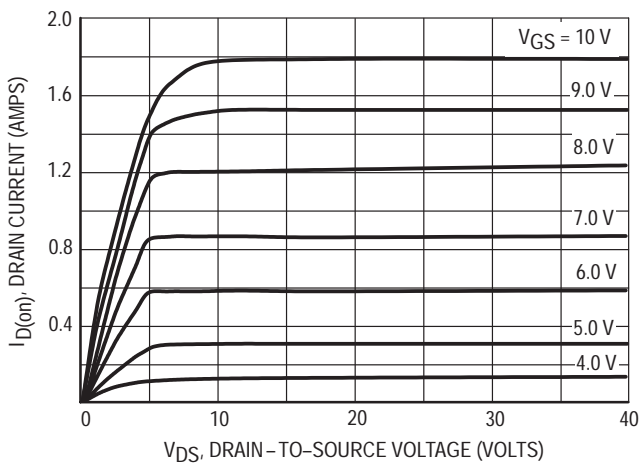


Figure 5. Output Characteristics

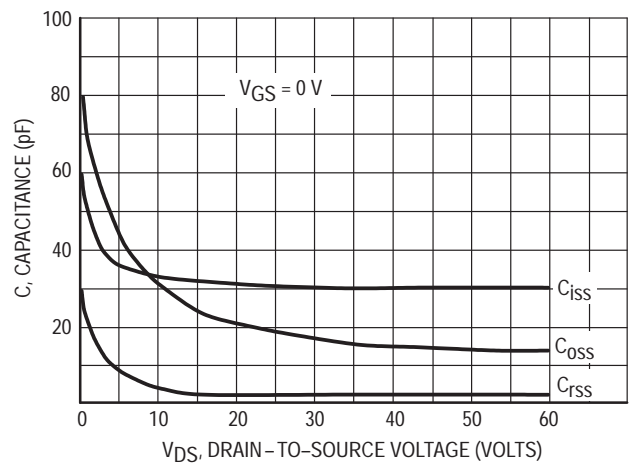


Figure 6. Capacitance versus Drain-To-Source Voltage

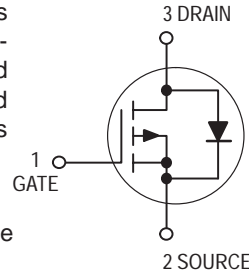


Low $r_{DS(on)}$ Small-Signal MOSFETs TMOS Single P-Channel Field Effect Transistors

Part of the Greenline™ Portfolio of devices with energy-conserving traits.

These miniature surface mount MOSFETs utilize Motorola's High Cell Density, HDTMOS process. Reduced power loss conserves energy, making this device ideal for use in small power management circuitry. Typical applications are dc-dc converters, load switching, power management in portable and battery-powered products such as computers, printers, cellular and cordless telephones.

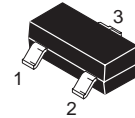
- Energy Efficient
- Miniature SOT-23 Surface Mount Package Saves Board Space



BSS84LT1

Motorola Preferred Device

P-CHANNEL
ENHANCEMENT-MODE
TMOS MOSFET



CASE 318-08, Style 21
SOT-23 (TO-236AB)

MAXIMUM RATINGS ($T_J = 25^\circ\text{C}$ unless otherwise noted)

Rating	Symbol	Value	Unit
Drain-to-Source Voltage	V_{DSS}	50	Vdc
Gate-to-Source Voltage — Continuous	V_{GS}	± 20	Vdc
Drain Current — Continuous @ $T_A = 25^\circ\text{C}$ — Pulsed Drain Current ($t_p \leq 10 \mu\text{s}$)	I_D I_{DM}	130 520	mA
Total Power Dissipation @ $T_A = 25^\circ\text{C}$	P_D	225	mW
Operating and Storage Temperature Range	T_J, T_{stg}	- 55 to 150	$^\circ\text{C}$
Thermal Resistance — Junction-to-Ambient	$R_{\theta JA}$	556	$^\circ\text{C/W}$
Maximum Lead Temperature for Soldering Purposes, for 10 seconds	T_L	260	$^\circ\text{C}$

DEVICE MARKING

BSS84LT1 = PD

ORDERING INFORMATION

Device	Reel Size	Tape Width	Quantity
BSS84LT1	7"	8mm embossed tape	3000
BSS84LT3	13"	8mm embossed tape	10,000

Preferred devices are Motorola recommended choices for future use and best overall value.

BSS84LT1

ELECTRICAL CHARACTERISTICS (T_A = 25°C unless otherwise noted)

Characteristic	Symbol	Min	Typ	Max	Unit
Drain-to-Source Breakdown Voltage (V _{GS} = 0 Vdc, I _D = 250 μAdc)	V _{(BR)DSS}	50	—	—	Vdc
Zero Gate Voltage Drain Current (V _{DS} = 25 Vdc, V _{GS} = 0 Vdc) (V _{DS} = 50 Vdc, V _{GS} = 0 Vdc) (V _{DS} = 50 Vdc, V _{GS} = 0 Vdc, T _J = 125°C)	I _{DSS}	—	—	0.1 15 60	μAdc
Gate-Body Leakage Current (V _{GS} = ± 20 Vdc, V _{DS} = 0 Vdc)	I _{GSS}	—	—	±60	μAdc

ON CHARACTERISTICS(1)

Gate-Source Threshold Voltage (V _{DS} = V _{GS} , I _D = 1.0 mAdc)	V _{GS(th)}	0.8	—	2.0	Vdc
Static Drain-to-Source On-Resistance (V _{GS} = 5.0 Vdc, I _D = 100 mAdc)	r _{DS(on)}	—	5.0	10	Ohms
Transfer Admittance (V _{DS} = 25 Vdc, I _D = 100 mAdc, f = 1.0 kHz)	y _{fs}	50	—	—	mS

DYNAMIC CHARACTERISTICS

Input Capacitance	(V _{DS} = 5.0 Vdc)	C _{iss}	—	30	—	pF
Output Capacitance	(V _{DS} = 5.0 Vdc)	C _{oss}	—	10	—	
Transfer Capacitance	(V _{DG} = 5.0 Vdc)	C _{rss}	—	5.0	—	

SWITCHING CHARACTERISTICS(2)

Turn-On Delay Time	(V _{DD} = -15 Vdc, I _D = -2.5 Adc, R _L = 50 Ω)	t _{d(on)}	—	2.5	—	ns
Rise Time		t _r	—	1.0	—	
Turn-Off Delay Time		t _{d(off)}	—	16	—	
Fall Time		t _f	—	8.0	—	
Gate Charge		Q _T	—	6000	—	pC

SOURCE-DrAIN DIODE CHARACTERISTICS

Continuous Current	I _S	—	—	0.130	A
Pulsed Current	I _{SM}	—	—	0.520	
Forward Voltage(2)	V _{SD}	—	2.5	—	V

(1) Pulse Test: Pulse Width ≤ 300 μs, Duty Cycle ≤ 2%.

(2) Switching characteristics are independent of operating junction temperature.

TYPICAL ELECTRICAL CHARACTERISTICS

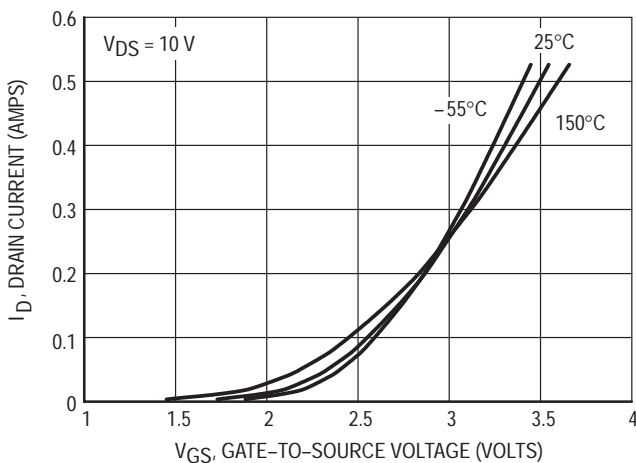


Figure 1. Transfer Characteristics

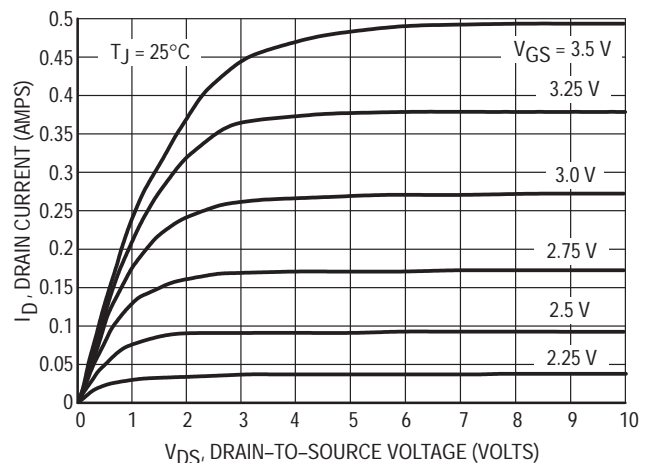


Figure 2. On-Region Characteristics

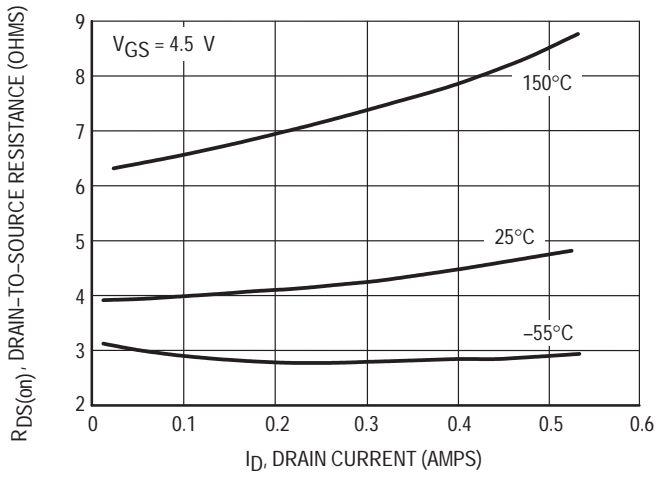


Figure 3. On-Resistance versus Drain Current

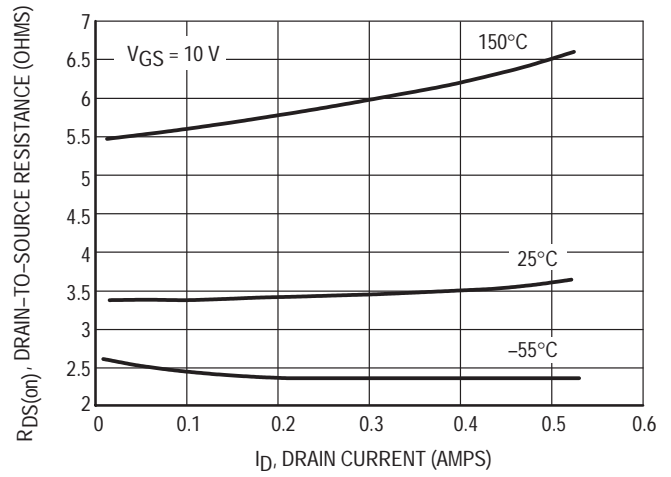


Figure 4. On-Resistance versus Drain Current

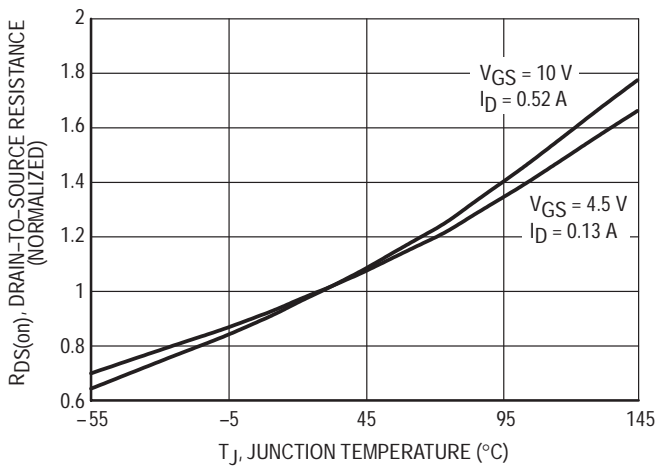


Figure 5. On-Resistance Variation with Temperature

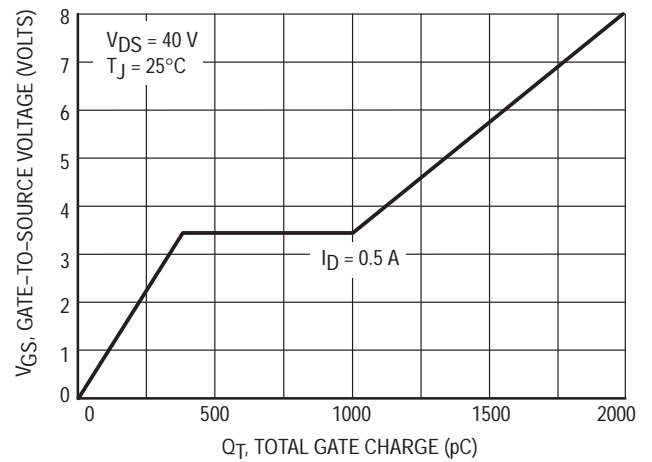


Figure 6. Gate Charge

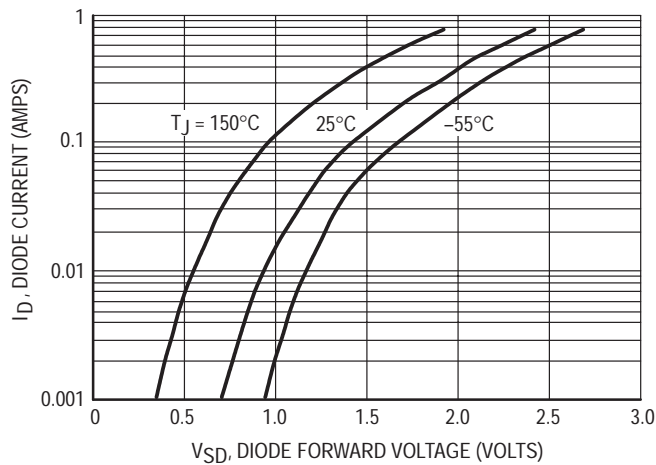
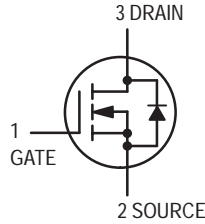


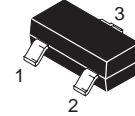
Figure 7. Body Diode Forward Voltage

TMOS FET Transistor
N-Channel



BSS123LT1

Motorola Preferred Device



CASE 318-08, STYLE 21
SOT-23 (TO-236AB)

MAXIMUM RATINGS

Rating	Symbol	Value	Unit
Drain-Source Voltage	V_{DSS}	100	Vdc
Gate-Source Voltage — Continuous — Non-repetitive ($t_p \leq 50 \mu s$)	V_{GS} V_{GSM}	± 20 ± 40	Vdc Vpk
Drain Current Continuous(1) Pulsed(2)	I_D I_{DM}	0.17 0.68	Adc

THERMAL CHARACTERISTICS

Characteristic	Symbol	Max	Unit
Total Device Dissipation FR-5 Board(3) $T_A = 25^\circ C$ Derate above $25^\circ C$	P_D	225 1.8	mW mW/ $^\circ C$
Thermal Resistance, Junction to Ambient	$R_{\theta JA}$	556	$^\circ C/W$
Junction and Storage Temperature	T_J, T_{stg}	-55 to +150	$^\circ C$

DEVICE MARKING

BSS123LT1 = SA

ELECTRICAL CHARACTERISTICS ($T_A = 25^\circ C$ unless otherwise noted)

Characteristic	Symbol	Min	Typ	Max	Unit
----------------	--------	-----	-----	-----	------

OFF CHARACTERISTICS

Drain-Source Breakdown Voltage ($V_{GS} = 0, I_D = 250 \mu A$)	$V_{(BR)DSS}$	100	—	—	Vdc
Zero Gate Voltage Drain Current ($V_{GS} = 0, V_{DS} = 100 Vdc$) $T_J = 25^\circ C$ $T_J = 125^\circ C$	I_{DSS}	— —	— —	15 60	μA dc
Gate-Body Leakage Current ($V_{GS} = 20 Vdc, V_{DS} = 0$)	I_{GSS}	—	—	50	nAdc

ON CHARACTERISTICS(4)

Gate Threshold Voltage ($V_{DS} = V_{GS}, I_D = 1.0 mA$ dc)	$V_{GS(th)}$	0.8	—	2.8	Vdc
Static Drain-Source On-Resistance ($V_{GS} = 10 Vdc, I_D = 100 mA$ dc)	$r_{DS(on)}$	—	5.0	6.0	Ω
Forward Transconductance ($V_{DS} = 25 Vdc, I_D = 100 mA$ dc)	g_{fs}	80	—	—	mmhos

1. The Power Dissipation of the package may result in a lower continuous drain current.
2. Pulse Width $\leq 300 \mu s$, Duty Cycle $\leq 2.0\%$.
3. FR-5 = $1.0 \times 0.75 \times 0.062$ in.
4. Pulse Test: Pulse Width $\leq 300 \mu s$, Duty Cycle $\leq 2.0\%$.

Preferred devices are Motorola recommended choices for future use and best overall value.

REV 2

ELECTRICAL CHARACTERISTICS ($T_A = 25^\circ\text{C}$ unless otherwise noted) (Continued)

Characteristic	Symbol	Min	Typ	Max	Unit	
DYNAMIC CHARACTERISTICS						
Input Capacitance ($V_{DS} = 25\text{ Vdc}$, $V_{GS} = 0$, $f = 1.0\text{ MHz}$)	C_{iss}	—	20	—	pF	
Output Capacitance ($V_{DS} = 25\text{ Vdc}$, $V_{GS} = 0$, $f = 1.0\text{ MHz}$)	C_{oss}	—	9.0	—	pF	
Reverse Transfer Capacitance ($V_{DS} = 25\text{ Vdc}$, $V_{GS} = 0$, $f = 1.0\text{ MHz}$)	C_{rss}	—	4.0	—	pF	
SWITCHING CHARACTERISTICS(4)						
Turn-On Delay Time	($V_{CC} = 30\text{ Vdc}$, $I_C = 0.28\text{ Adc}$, $V_{GS} = 10\text{ Vdc}$, $R_{GS} = 50\ \Omega$)	$t_{d(on)}$	—	20	—	ns
Turn-Off Delay Time		$t_{d(off)}$	—	40	—	ns
REVERSE DIODE						
Diode Forward On-Voltage ($I_D = 0.34\text{ Adc}$, $V_{GS} = 0\text{ Vdc}$)	V_{SD}	—	—	1.3	V	

4. Pulse Test: Pulse Width $\leq 300\ \mu\text{s}$, Duty Cycle $\leq 2.0\%$.

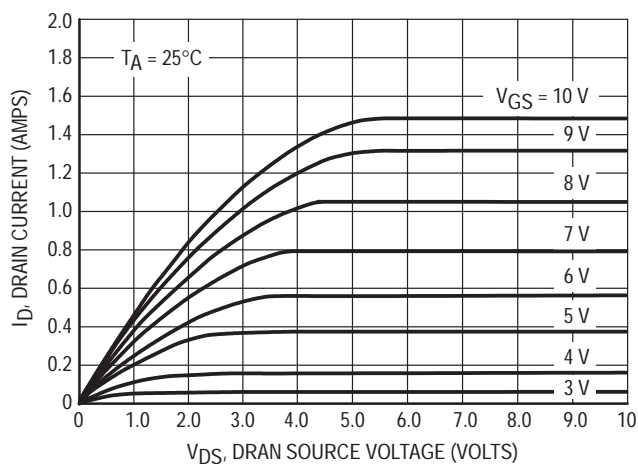


Figure 1. Ohmic Region

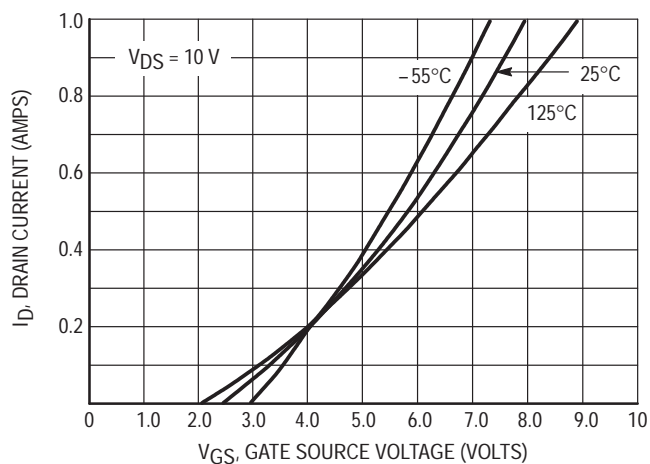


Figure 2. Transfer Characteristics

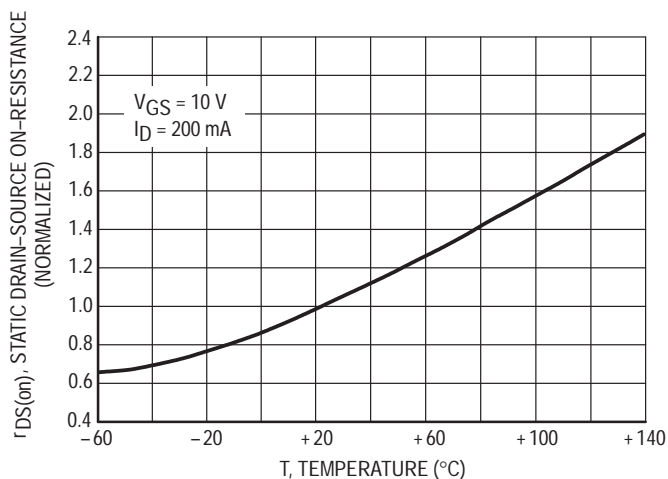


Figure 3. Temperature versus Static Drain-Source On-Resistance

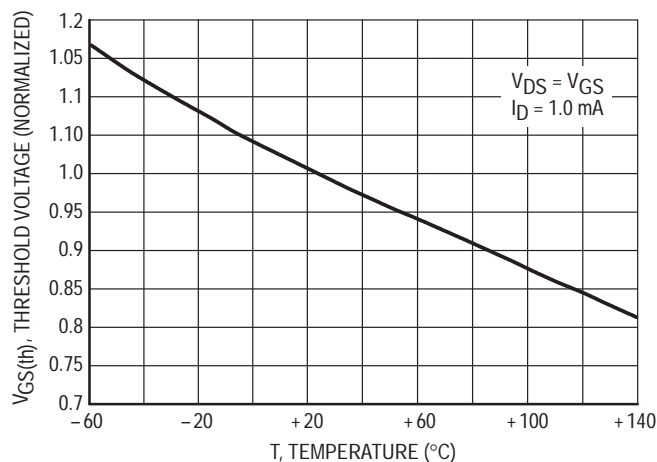


Figure 4. Temperature versus Gate Threshold Voltage



BSS138LT1

Motorola Preferred Device

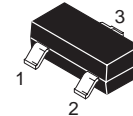
N-Channel Enhancement Mode Logic Level SOT-23 MOSFET

Typical applications are dc–dc converters, power management in portable and battery–powered products such as computers, printers, PCMCIA cards, cellular and cordless telephones.

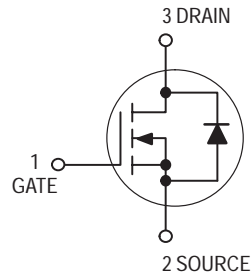
- Low Threshold Voltage ($V_{GS(th)}$: 0.5V...1.5V) makes it ideal for low voltage applications
- Miniature SOT–23 Surface Mount Package saves board space



N-CHANNEL
LOGIC LEVEL
TMOS FET
TRANSISTOR



CASE 318–08, Style 21
SOT–23 (TO–236A)



MAXIMUM RATINGS ($T_A = 25^\circ\text{C}$ unless otherwise noted)

Rating	Symbol	Value	Unit
Drain–to–Source Voltage	V_{DSS}	50	Vdc
Gate–to–Source Voltage — Continuous	V_{GS}	± 20	Vdc
Drain Current — Continuous @ $T_A = 25^\circ\text{C}$ — Pulsed Drain Current ($t_p \leq 10 \mu\text{s}$)	I_D I_{DM}	200 800	mA
Total Power Dissipation @ $T_A = 25^\circ\text{C}$	P_D	225	mW
Operating and Storage Temperature Range	T_J, T_{stg}	– 55 to 150	$^\circ\text{C}$
Thermal Resistance — Junction–to–Ambient	$R_{\theta JA}$	556	$^\circ\text{C}/\text{W}$
Maximum Lead Temperature for Soldering Purposes, for 10 seconds	T_L	260	$^\circ\text{C}$

DEVICE MARKING

BSS138LT1 = J1

ORDERING INFORMATION

Device	Reel Size	Tape Width	Quantity
BSS138LT1	7"	8mm embossed tape	3000
BSS138LT3	13"	8mm embossed tape	10,000

Preferred devices are Motorola recommended choices for future use and best overall value.

ELECTRICAL CHARACTERISTICS ($T_A = 25^\circ\text{C}$ unless otherwise noted)

Characteristic	Symbol	Min	Typ	Max	Unit
----------------	--------	-----	-----	-----	------

OFF CHARACTERISTICS

Drain-to-Source Breakdown Voltage ($V_{GS} = 0\text{ Vdc}$, $I_D = 250\ \mu\text{Adc}$)	$V_{(BR)DSS}$	50	—	—	Vdc
Zero Gate Voltage Drain Current ($V_{DS} = 25\text{ Vdc}$, $V_{GS} = 0\text{ Vdc}$) ($V_{DS} = 50\text{ Vdc}$, $V_{GS} = 0\text{ Vdc}$)	I_{DSS}	— —	— —	0.1 0.5	μAdc
Gate-Source Leakage Current ($V_{GS} = \pm 20\text{ Vdc}$, $V_{DS} = 0\text{ Vdc}$)	I_{GSS}	—	—	± 0.1	μAdc

ON CHARACTERISTICS(1)

Gate-Source Threshold Voltage ($V_{DS} = V_{GS}$, $I_D = 1.0\text{ mAdc}$)	$V_{GS(th)}$	0.5	—	1.5	Vdc
Static Drain-to-Source On-Resistance ($V_{GS} = 2.75\text{ Vdc}$, $I_D < 200\text{ mAdc}$, $T_A = -40^\circ\text{C}$ to $+85^\circ\text{C}$) ($V_{GS} = 5.0\text{ Vdc}$, $I_D = 200\text{ mAdc}$)	$r_{DS(on)}$	— —	5.6 —	10 3.5	Ohms
Forward Transconductance ($V_{DS} = 25\text{ Vdc}$, $I_D = 200\text{ mAdc}$, $f = 1.0\text{ kHz}$)	g_{fs}	100	—	—	mmhos

DYNAMIC CHARACTERISTICS

Input Capacitance	($V_{DS} = 25\text{ Vdc}$, $V_{GS} = 0$, $f = 1\text{ MHz}$)	C_{iss}	—	40	50	pF
Output Capacitance	($V_{DS} = 25\text{ Vdc}$, $V_{GS} = 0$, $f = 1\text{ MHz}$)	C_{oss}	—	12	25	
Transfer Capacitance	($V_{DG} = 25\text{ Vdc}$, $V_{GS} = 0$, $f = 1\text{ MHz}$)	C_{rss}	—	3.5	5.0	

SWITCHING CHARACTERISTICS(2)

Turn-On Delay Time	($V_{DD} = 30\text{ Vdc}$, $I_D = 0.2\text{ Adc}$,)	$t_{d(on)}$	—	—	20	ns
Turn-Off Delay Time		$t_{d(off)}$	—	—	20	

(1) Pulse Test: Pulse Width $\leq 300\ \mu\text{s}$, Duty Cycle $\leq 2\%$.

(2) Switching characteristics are independent of operating junction temperature.

TYPICAL ELECTRICAL CHARACTERISTICS

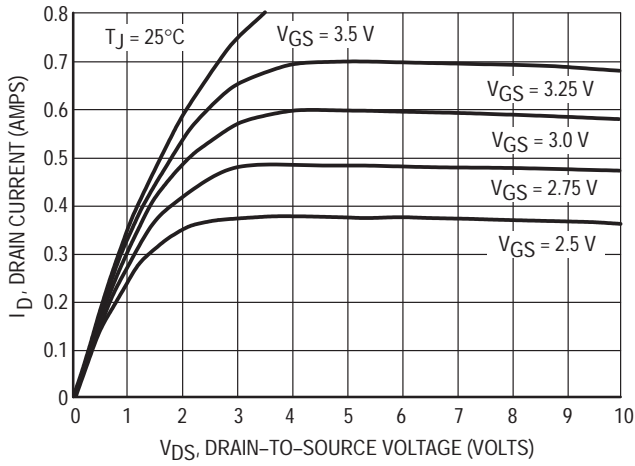


Figure 1. On-Region Characteristics

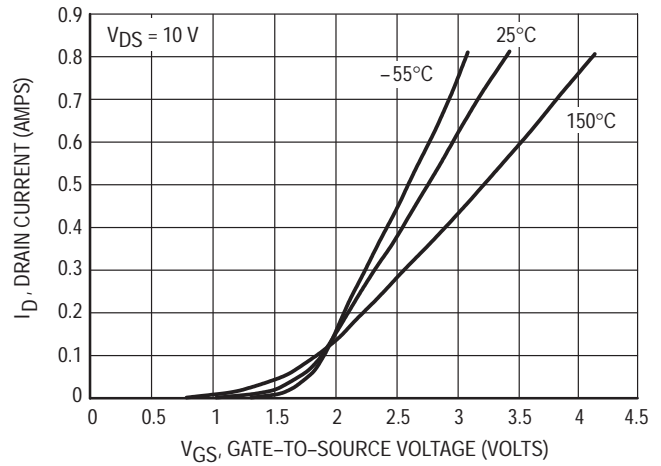


Figure 2. Transfer Characteristics

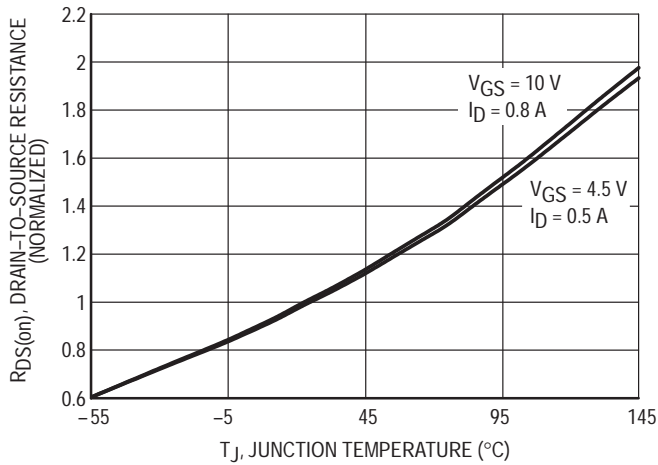


Figure 3. On-Resistance Variation with Temperature

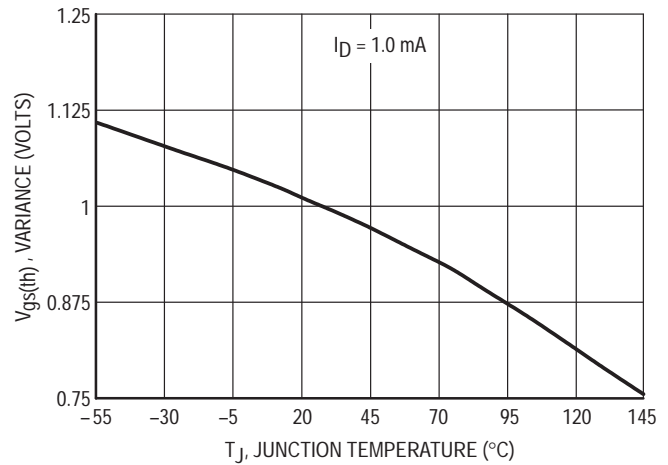


Figure 4. Threshold Voltage Variation with Temperature

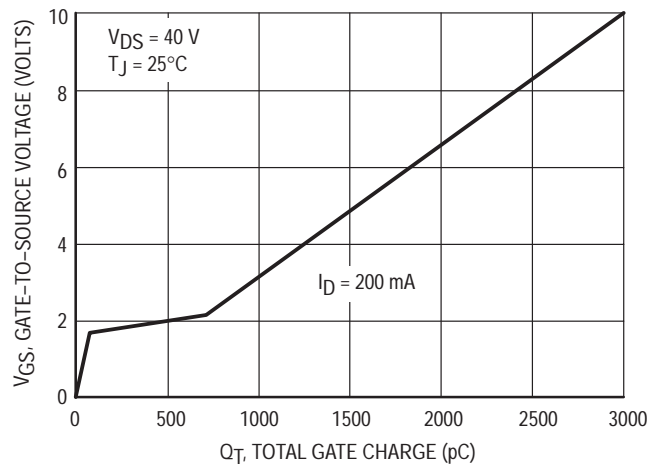


Figure 5. Gate Charge

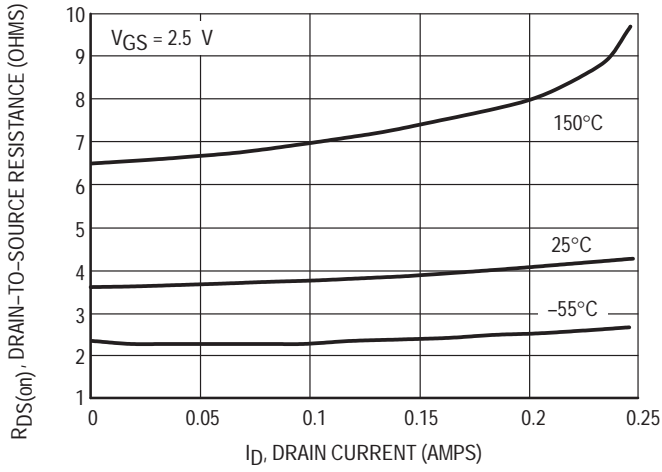


Figure 6. On-Resistance versus Drain Current

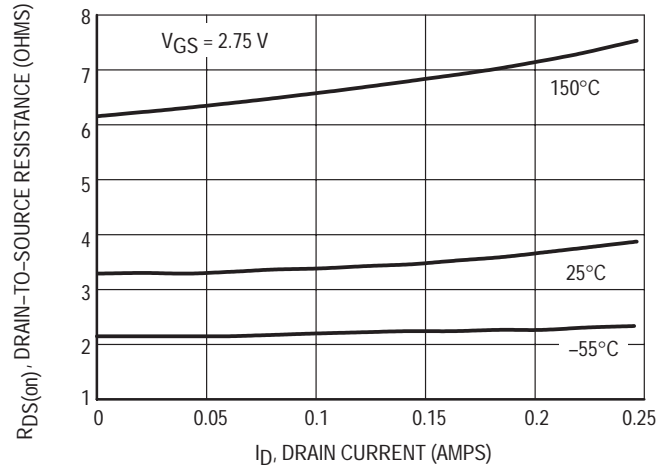


Figure 7. On-Resistance versus Drain Current

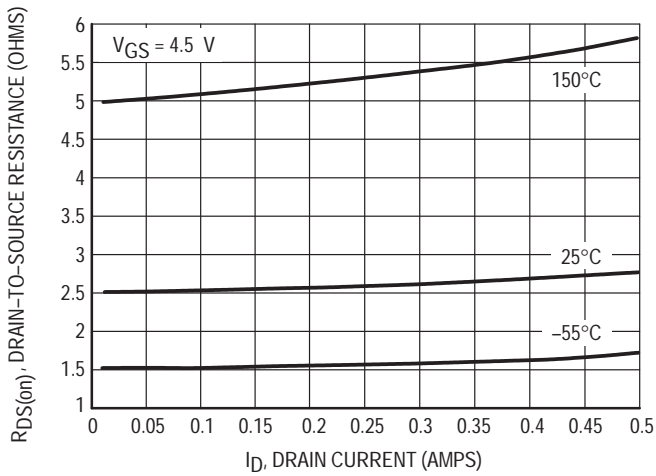


Figure 8. On-Resistance versus Drain Current

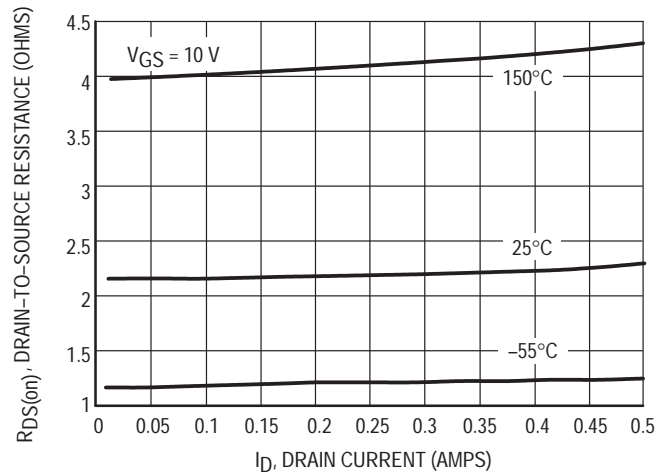


Figure 9. On-Resistance versus Drain Current

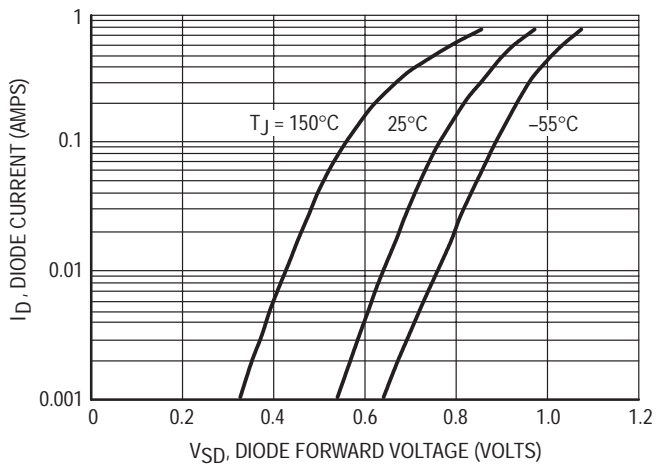


Figure 10. Body Diode Forward Voltage

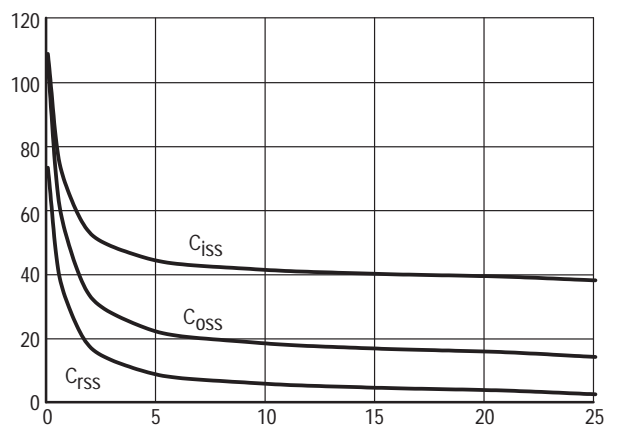


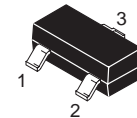
Figure 11. Capacitance



MGSF1N02LT1

Motorola Preferred Device

**N-CHANNEL
ENHANCEMENT-MODE
TMOS MOSFET**



**CASE 318-08, Style 21
SOT-23 (TO-236AB)**

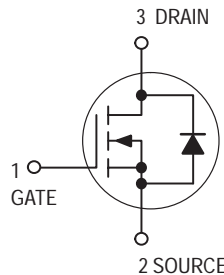
Low $r_{DS(on)}$ Small-Signal MOSFETs

TMOS Single N-Channel Field Effect Transistors

Part of the GreenLine™ Portfolio of devices with energy-conserving traits.

These miniature surface mount MOSFETs utilize Motorola's High Cell Density, HDTMOS process. Low $r_{DS(on)}$ assures minimal power loss and conserves energy, making this device ideal for use in space sensitive power management circuitry. Typical applications are dc-dc converters and power management in portable and battery-powered products such as computers, printers, PCMCIA cards, cellular and cordless telephones.

- Low $r_{DS(on)}$ Provides Higher Efficiency and Extends Battery Life
- Miniature SOT-23 Surface Mount Package Saves Board Space



MAXIMUM RATINGS ($T_J = 25^\circ\text{C}$ unless otherwise noted)

Rating	Symbol	Value	Unit
Drain-to-Source Voltage	V_{DSS}	20	Vdc
Gate-to-Source Voltage — Continuous	V_{GS}	± 20	Vdc
Drain Current — Continuous @ $T_A = 25^\circ\text{C}$ — Pulsed Drain Current ($t_p \leq 10 \mu\text{s}$)	I_D I_{DM}	750 2000	mA
Total Power Dissipation @ $T_A = 25^\circ\text{C}$	P_D	400	mW
Operating and Storage Temperature Range	T_J, T_{stg}	-55 to 150	$^\circ\text{C}$
Thermal Resistance — Junction-to-Ambient	$R_{\theta JA}$	300	$^\circ\text{C/W}$
Maximum Lead Temperature for Soldering Purposes, 1/8" from case for 10 seconds	T_L	260	$^\circ\text{C}$

Device Marking: NZ

ORDERING INFORMATION

Device	Reel Size	Tape Width	Quantity
MGSF1N02LT1	7"	8mm embossed tape	3000
MGSF1N02LT3	13"	8mm embossed tape	10,000

Preferred devices are Motorola recommended choices for future use and best overall value.

ELECTRICAL CHARACTERISTICS ($T_A = 25^\circ\text{C}$ unless otherwise noted)

Characteristic	Symbol	Min	Typ	Max	Unit
OFF CHARACTERISTICS					
Drain-to-Source Breakdown Voltage ($V_{GS} = 0\text{ Vdc}$, $I_D = 10\ \mu\text{Adc}$)	$V_{(BR)DSS}$	20	—	—	Vdc
Zero Gate Voltage Drain Current ($V_{DS} = 20\text{ Vdc}$, $V_{GS} = 0\text{ Vdc}$) ($V_{DS} = 20\text{ Vdc}$, $V_{GS} = 0\text{ Vdc}$, $T_J = 125^\circ\text{C}$)	I_{DSS}	—	—	1.0 10	μAdc
Gate-Body Leakage Current ($V_{GS} = \pm 20\text{ Vdc}$, $V_{DS} = 0\text{ Vdc}$)	I_{GSS}	—	—	± 100	nAdc

ON CHARACTERISTICS(1)

Gate Threshold Voltage ($V_{DS} = V_{GS}$, $I_D = 250\ \mu\text{Adc}$)	$V_{GS(th)}$	1.0	1.7	2.4	Vdc
Static Drain-to-Source On-Resistance ($V_{GS} = 10\text{ Vdc}$, $I_D = 1.2\text{ Adc}$) ($V_{GS} = 4.5\text{ Vdc}$, $I_D = 1.0\text{ Adc}$)	$r_{DS(on)}$	—	0.075 0.115	0.090 0.130	Ohms

DYNAMIC CHARACTERISTICS

Input Capacitance	($V_{DS} = 5.0\text{ Vdc}$)	C_{iss}	—	125	—	pF
Output Capacitance	($V_{DS} = 5.0\text{ Vdc}$)	C_{oss}	—	120	—	
Transfer Capacitance	($V_{DG} = 5.0\text{ Vdc}$)	C_{rss}	—	45	—	

SWITCHING CHARACTERISTICS(2)

Turn-On Delay Time	$(V_{DD} = 15\text{ Vdc}$, $I_D = 1.0\text{ Adc}$, $R_L = 50\ \Omega$)	$t_{d(on)}$	—	2.5	—	ns
Rise Time		t_r	—	1.0	—	
Turn-Off Delay Time		$t_{d(off)}$	—	16	—	
Fall Time		t_f	—	8.0	—	
Gate Charge (See Figure 6)		Q_T	—	6000	—	pC

SOURCE-DRAIN DIODE CHARACTERISTICS

Continuous Current	I_S	—	—	0.6	A
Pulsed Current	I_{SM}	—	—	0.75	
Forward Voltage(2)	V_{SD}	—	0.8	—	V

(1) Pulse Test: Pulse Width $\leq 300\ \mu\text{s}$, Duty Cycle $\leq 2\%$.

(2) Switching characteristics are independent of operating junction temperature.

TYPICAL ELECTRICAL CHARACTERISTICS

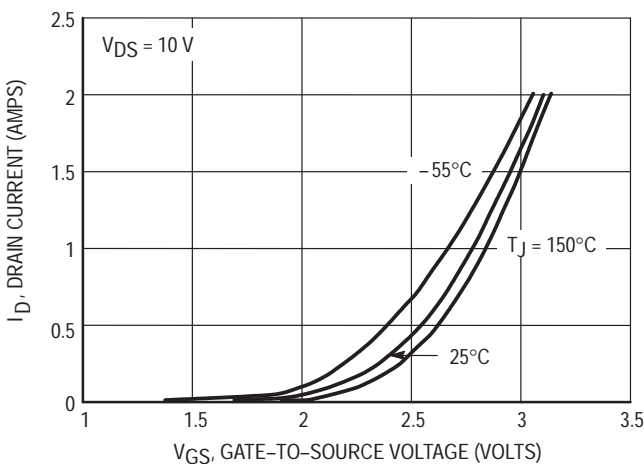


Figure 1. Transfer Characteristics

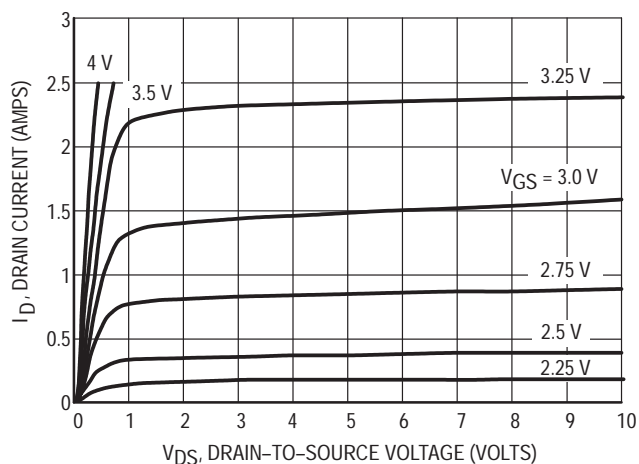


Figure 2. On-Region Characteristics

MGSF1N02LT1

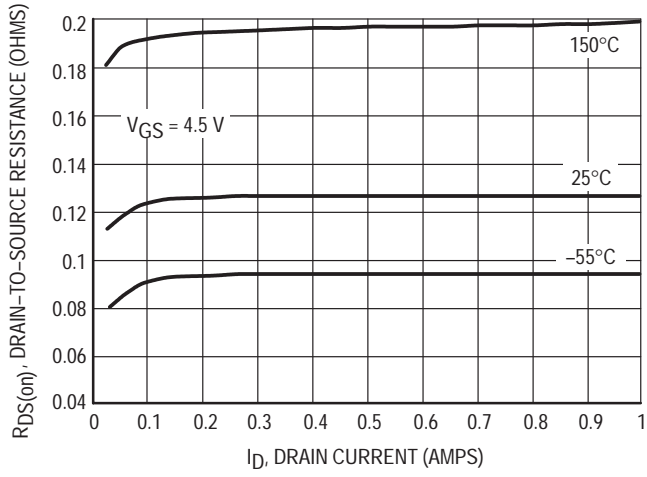


Figure 3. On-Resistance versus Drain Current

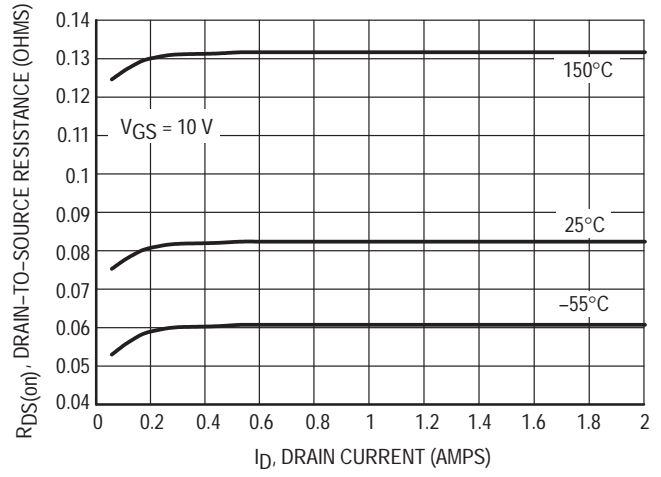


Figure 4. On-Resistance versus Drain Current

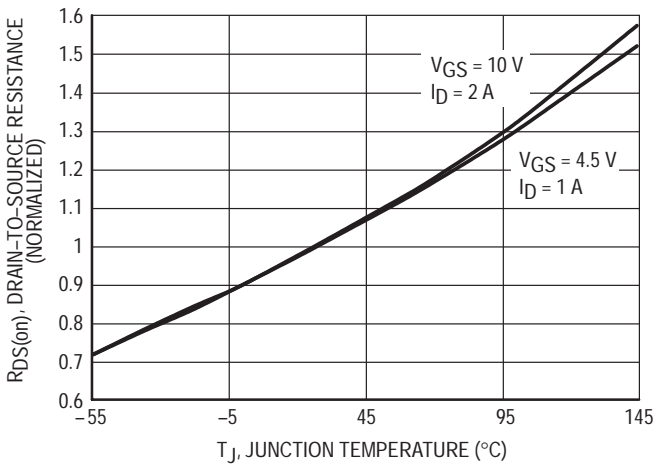


Figure 5. On-Resistance Variation with Temperature

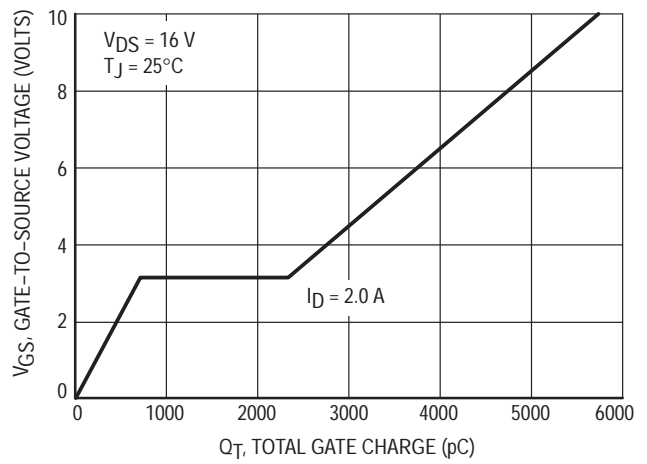


Figure 6. Gate Charge

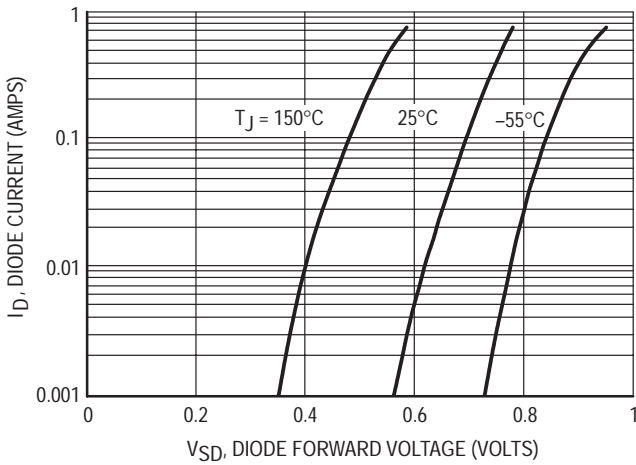


Figure 7. Body Diode Forward Voltage

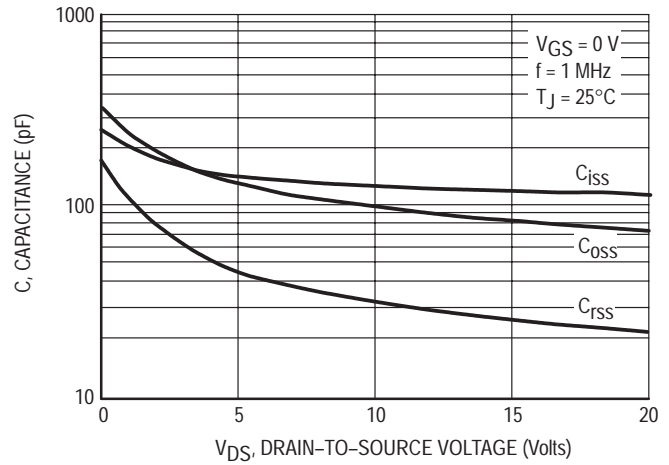


Figure 8. Capacitance



MGSF1N03LT1

Motorola Preferred Device

**Low $r_{DS(on)}$ Small-Signal MOSFETs
TMOS Single N-Channel
Field Effect Transistors**

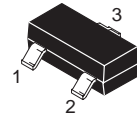
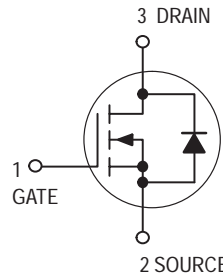
Part of the GreenLine™ Portfolio of devices with energy-conserving traits.

These miniature surface mount MOSFETs utilize Motorola's High Cell Density, HDTMOS process. Low $r_{DS(on)}$ assures minimal power loss and conserves energy, making this device ideal for use in space sensitive power management circuitry. Typical applications are dc-dc converters and power management in portable and battery-powered products such as computers, printers, PCMCIA cards, cellular and cordless telephones.

- Low $r_{DS(on)}$ Provides Higher Efficiency and Extends Battery Life
- Miniature SOT-23 Surface Mount Package Saves Board Space



**N-CHANNEL
ENHANCEMENT-MODE
TMOS MOSFET**



**CASE 318-08, Style 21
SOT-23 (TO-236AB)**

MAXIMUM RATINGS ($T_J = 25^\circ\text{C}$ unless otherwise noted)

Rating	Symbol	Value	Unit
Drain-to-Source Voltage	V_{DS}	30	Vdc
Gate-to-Source Voltage — Continuous	V_{GS}	± 20	Vdc
Drain Current — Continuous @ $T_A = 25^\circ\text{C}$ — Pulsed Drain Current ($t_p \leq 10 \mu\text{s}$)	I_D I_{DM}	750 2000	mA
Total Power Dissipation @ $T_A = 25^\circ\text{C}$	P_D	400	mW
Operating and Storage Temperature Range	T_J, T_{stg}	- 55 to 150	$^\circ\text{C}$
Thermal Resistance — Junction-to-Ambient	$R_{\theta JA}$	300	$^\circ\text{C/W}$
Maximum Lead Temperature for Soldering Purposes, 1/8" from case for 10 seconds	T_L	260	$^\circ\text{C}$

Device Marking: N3

ORDERING INFORMATION

Device	Reel Size	Tape Width	Quantity
MGSF1N03LT1	7"	8mm embossed tape	3000
MGSF1N03LT3	13"	8mm embossed tape	10,000

Preferred devices are Motorola recommended choices for future use and best overall value.

MGSF1N03LT1

ELECTRICAL CHARACTERISTICS (T_A = 25°C unless otherwise noted)

Characteristic	Symbol	Min	Typ	Max	Unit
----------------	--------	-----	-----	-----	------

OFF CHARACTERISTICS

Drain-to-Source Breakdown Voltage (V _{GS} = 0 Vdc, I _D = 10 μAdc)	V _{(BR)DSS}	30	—	—	Vdc
Zero Gate Voltage Drain Current (V _{DS} = 30 Vdc, V _{GS} = 0 Vdc) (V _{DS} = 30 Vdc, V _{GS} = 0 Vdc, T _J = 125°C)	I _{DSS}	—	—	1.0 10	μAdc
Gate-Body Leakage Current (V _{GS} = ± 20 Vdc, V _{DS} = 0 Vdc)	I _{GSS}	—	—	±100	nAdc

ON CHARACTERISTICS(1)

Gate Threshold Voltage (V _{DS} = V _{GS} , I _D = 250 μAdc)	V _{GS(th)}	1.0	1.7	2.4	Vdc
Static Drain-to-Source On-Resistance (V _{GS} = 10 Vdc, I _D = 1.2 Adc) (V _{GS} = 4.5 Vdc, I _D = 1.0 Adc)	r _{DS(on)}	—	0.08 0.125	0.10 0.145	Ohms

DYNAMIC CHARACTERISTICS

Input Capacitance	(V _{DS} = 5.0 Vdc)	C _{iss}	—	140	—	pF
Output Capacitance	(V _{DS} = 5.0 Vdc)	C _{oss}	—	100	—	
Transfer Capacitance	(V _{DG} = 5.0 Vdc)	C _{rss}	—	40	—	

SWITCHING CHARACTERISTICS(2)

Turn-On Delay Time	(V _{DD} = 15 Vdc, I _D = 1.0 Adc, R _L = 50 Ω)	t _{d(on)}	—	2.5	—	ns
Rise Time		t _r	—	1.0	—	
Turn-Off Delay Time		t _{d(off)}	—	16	—	
Fall Time		t _f	—	8.0	—	
Gate Charge (See Figure 6)		Q _T	—	6000	—	pC

SOURCE-DRAIN DIODE CHARACTERISTICS

Continuous Current	I _S	—	—	0.6	A
Pulsed Current	I _{SM}	—	—	0.75	
Forward Voltage(2)	V _{SD}	—	0.8	—	V

(1) Pulse Test: Pulse Width ≤ 300 μs, Duty Cycle ≤ 2%.

(2) Switching characteristics are independent of operating junction temperature.

TYPICAL ELECTRICAL CHARACTERISTICS

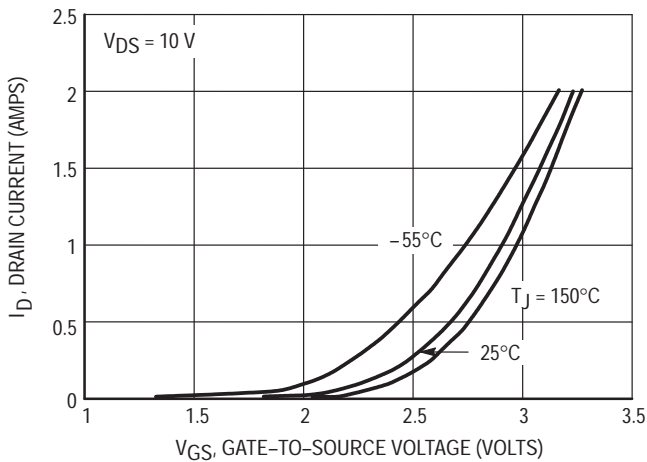


Figure 1. Transfer Characteristics

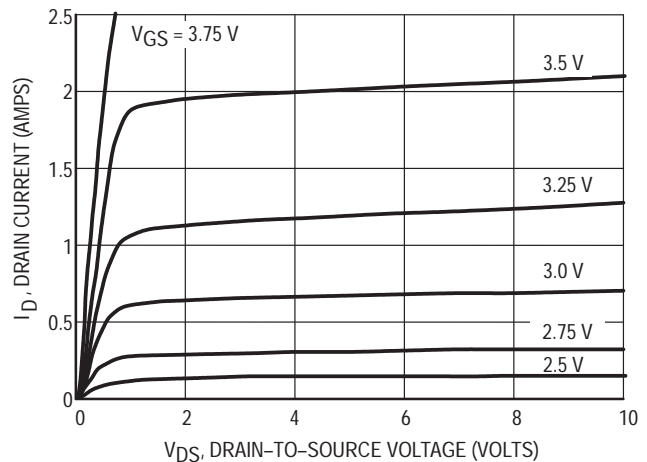


Figure 2. On-Region Characteristics

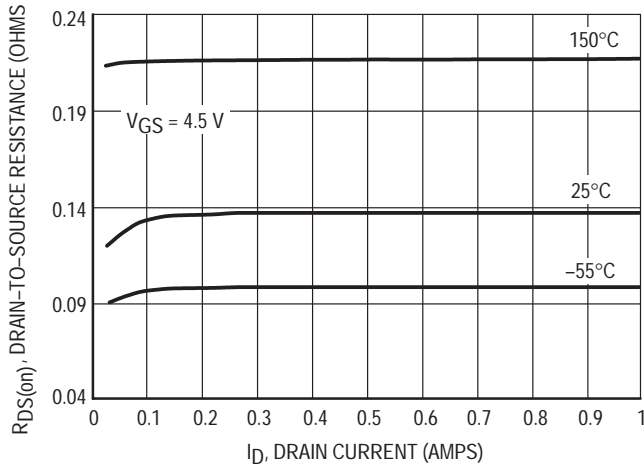


Figure 3. On-Resistance versus Drain Current

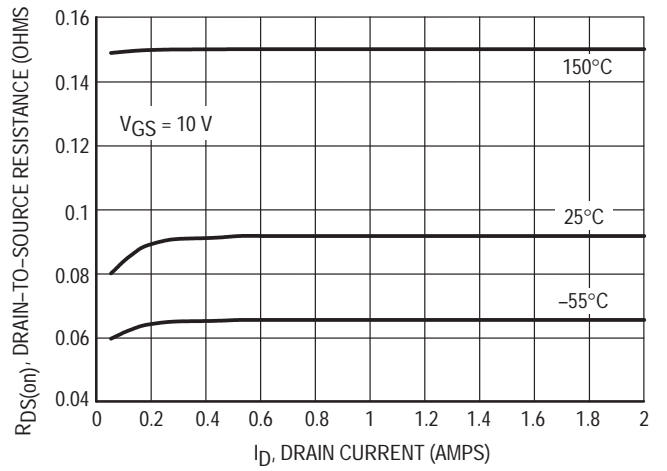


Figure 4. On-Resistance versus Drain Current

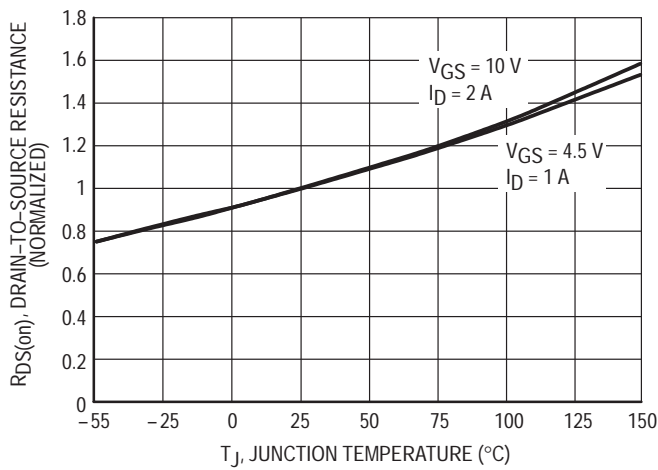


Figure 5. On-Resistance Variation with Temperature

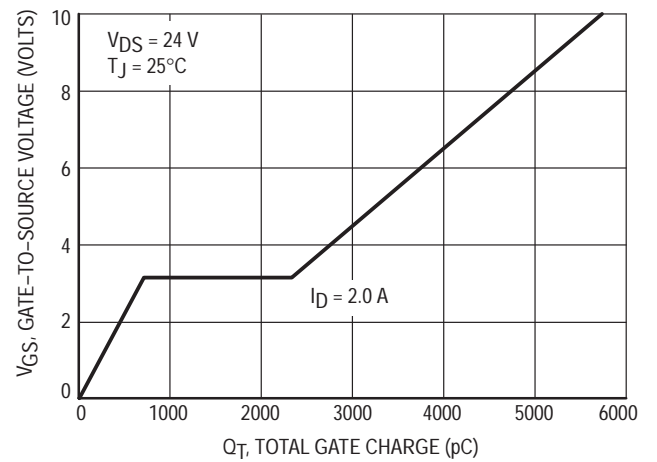


Figure 6. Gate Charge

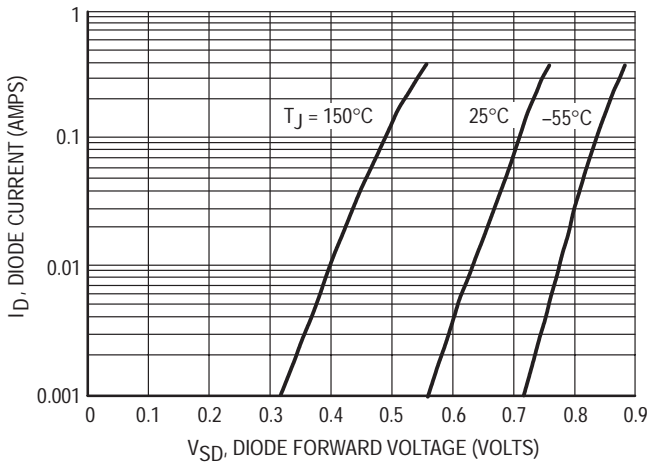


Figure 7. Body Diode Forward Voltage

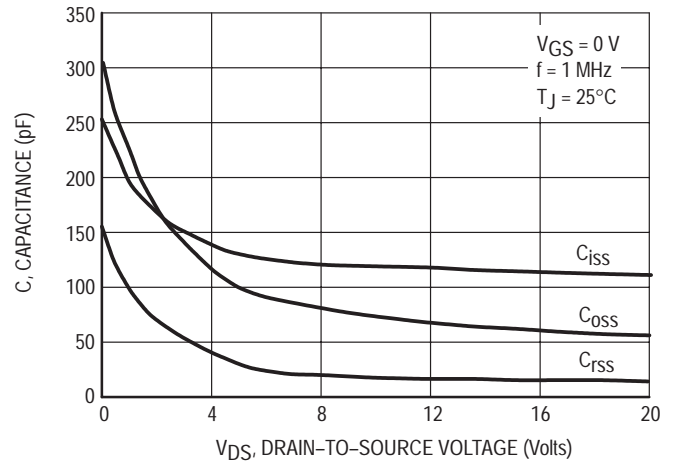


Figure 8. Capacitance



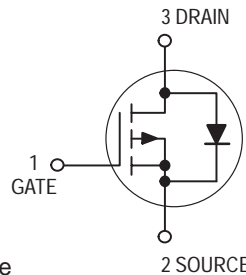
Preliminary Information

Low $r_{DS(on)}$ Small-Signal MOSFETs TMOS Single P-Channel Field Effect Transistors

Part of the GreenLine™ Portfolio of devices with energy-conserving traits.

These miniature surface mount MOSFETs utilize Motorola's High Cell Density, HDTMOS process. Low $r_{DS(on)}$ assures minimal power loss and conserves energy, making this device ideal for use in space sensitive power management circuitry. Typical applications are dc-dc converters and power management in portable and battery-powered products such as computers, printers, PCMCIA cards, cellular and cordless telephones.

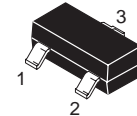
- Low $r_{DS(on)}$ Provides Higher Efficiency and Extends Battery Life
- Miniature SOT-23 Surface Mount Package Saves Board Space



MGSF1P02ELT1

Motorola Preferred Device

**P-CHANNEL
ENHANCEMENT-MODE
TMOS MOSFET**



**CASE 318-08, Style 21
SOT-23 (TO-236AB)**

MAXIMUM RATINGS (T_J = 25°C unless otherwise noted)

Rating	Symbol	Value	Unit
Drain-to-Source Voltage	V _{DSS}	20	Vdc
Gate-to-Source Voltage — Continuous	V _{GS}	± 8.0	Vdc
Drain Current — Continuous @ T _A = 25°C — Pulsed Drain Current (t _p ≤ 10 μs)	I _D I _{DM}	750 2000	mA
Total Power Dissipation @ T _A = 25°C	P _D	400	mW
Operating and Storage Temperature Range	T _J , T _{stg}	- 55 to 150	°C
Thermal Resistance — Junction-to-Ambient	R _{θJA}	300	°C/W
Maximum Lead Temperature for Soldering Purposes, 1/8" from case for 10 seconds	T _L	260	°C

Device Marking: PC

ORDERING INFORMATION

Device	Reel Size	Tape Width	Quantity
MGSF1P02ELT1	7"	8mm embossed tape	3000
MGSF1P02ELT3	13"	8mm embossed tape	10,000

Preferred devices are Motorola recommended choices for future use and best overall value.

ELECTRICAL CHARACTERISTICS ($T_A = 25^\circ\text{C}$ unless otherwise noted)

Characteristic	Symbol	Min	Typ	Max	Unit
----------------	--------	-----	-----	-----	------

OFF CHARACTERISTICS

Drain-to-Source Breakdown Voltage ($V_{GS} = 0\text{ Vdc}$, $I_D = 250\ \mu\text{Adc}$)	$V_{(BR)DSS}$	20	—	—	Vdc
Zero Gate Voltage Drain Current ($V_{DS} = 16\text{ Vdc}$, $V_{GS} = 0\text{ Vdc}$) ($V_{DS} = 16\text{ Vdc}$, $V_{GS} = 0\text{ Vdc}$, $T_J = 125^\circ\text{C}$)	I_{DSS}	—	—	1.0 10	μAdc
Gate-Body Leakage Current ($V_{GS} = \pm 8.0\text{ Vdc}$, $V_{DS} = 0\text{ Vdc}$)	I_{GSS}	—	—	± 100	nAdc

ON CHARACTERISTICS(1)

Gate Threshold Voltage ($V_{DS} = V_{GS}$, $I_D = 250\ \mu\text{Adc}$)	$V_{GS(th)}$	0.7	0.85	1.2	Vdc
Static Drain-to-Source On-Resistance ($V_{GS} = 4.5\text{ Vdc}$, $I_D = 0.75\text{ Adc}$) ($V_{GS} = 2.5\text{ Vdc}$, $I_D = 0.5\text{ Adc}$)	$r_{DS(on)}$	—	0.20 0.32	0.26 0.50	Ohms

DYNAMIC CHARACTERISTICS

Input Capacitance	($V_{DS} = 5.0\text{ Vdc}$)	C_{iss}	—	130	—	pF
Output Capacitance	($V_{DS} = 5.0\text{ Vdc}$)	C_{oss}	—	120	—	
Transfer Capacitance	($V_{DG} = 5.0\text{ Vdc}$)	C_{rss}	—	60	—	

SWITCHING CHARACTERISTICS(2)

Turn-On Delay Time	$(V_{DD} = 15\text{ Vdc}$, $I_D = 1.0\text{ Adc}$, $R_L = 50\ \Omega)$	$t_{d(on)}$	—	2.5	—	ns
Rise Time		t_r	—	1.0	—	
Turn-Off Delay Time		$t_{d(off)}$	—	16	—	
Fall Time		t_f	—	8.0	—	
Gate Charge (See Figure 6)		Q_T	—	6000	—	pC

SOURCE-DRAIN DIODE CHARACTERISTICS

Continuous Current	I_S	—	—	0.6	A
Pulsed Current	I_{SM}	—	—	0.75	
Forward Voltage(2)	V_{SD}	—	1.5	—	V

(1) Pulse Test: Pulse Width $\leq 300\ \mu\text{s}$, Duty Cycle $\leq 2\%$.

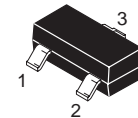
(2) Switching characteristics are independent of operating junction temperature.



MGSF1P02LT1

Motorola Preferred Device

**P-CHANNEL
ENHANCEMENT-MODE
TMOS MOSFET**



**CASE 318-08, Style 21
SOT-23 (TO-236AB)**

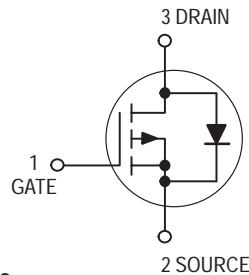
Low $r_{DS(on)}$ Small-Signal MOSFETs

TMOS Single P-Channel Field Effect Transistors

Part of the GreenLine™ Portfolio of devices with energy-conserving traits.

These miniature surface mount MOSFETs utilize Motorola's High Cell Density, HDTMOS process. Low $r_{DS(on)}$ assures minimal power loss and conserves energy, making this device ideal for use in space sensitive power management circuitry. Typical applications are dc-dc converters and power management in portable and battery-powered products such as computers, printers, PCMCIA cards, cellular and cordless telephones.

- Low $r_{DS(on)}$ Provides Higher Efficiency and Extends Battery Life
- Miniature SOT-23 Surface Mount Package Saves Board Space



MAXIMUM RATINGS ($T_J = 25^\circ\text{C}$ unless otherwise noted)

Rating	Symbol	Value	Unit
Drain-to-Source Voltage	V_{DSS}	20	Vdc
Gate-to-Source Voltage — Continuous	V_{GS}	± 20	Vdc
Drain Current — Continuous @ $T_A = 25^\circ\text{C}$ — Pulsed Drain Current ($t_p \leq 10 \mu\text{s}$)	I_D I_{DM}	750 2000	mA
Total Power Dissipation @ $T_A = 25^\circ\text{C}$	P_D	400	mW
Operating and Storage Temperature Range	T_J, T_{stg}	-55 to 150	$^\circ\text{C}$
Thermal Resistance — Junction-to-Ambient	$R_{\theta JA}$	300	$^\circ\text{C/W}$
Maximum Lead Temperature for Soldering Purposes, 1/8" from case for 10 seconds	T_L	260	$^\circ\text{C}$

Device Marking: PC

ORDERING INFORMATION

Device	Reel Size	Tape Width	Quantity
MGSF1P02LT1	7"	8mm embossed tape	3000
MGSF1P02LT3	13"	8mm embossed tape	10,000

Preferred devices are Motorola recommended choices for future use and best overall value.

ELECTRICAL CHARACTERISTICS ($T_A = 25^\circ\text{C}$ unless otherwise noted)

Characteristic	Symbol	Min	Typ	Max	Unit
----------------	--------	-----	-----	-----	------

OFF CHARACTERISTICS

Drain-to-Source Breakdown Voltage ($V_{GS} = 0\text{ Vdc}$, $I_D = 10\ \mu\text{Adc}$)	$V_{(BR)DSS}$	20	—	—	Vdc
Zero Gate Voltage Drain Current ($V_{DS} = 20\text{ Vdc}$, $V_{GS} = 0\text{ Vdc}$) ($V_{DS} = 20\text{ Vdc}$, $V_{GS} = 0\text{ Vdc}$, $T_J = 125^\circ\text{C}$)	I_{DSS}	—	—	1.0 10	μAdc
Gate-Body Leakage Current ($V_{GS} = \pm 20\text{ Vdc}$, $V_{DS} = 0\text{ Vdc}$)	I_{GSS}	—	—	± 100	nAdc

ON CHARACTERISTICS(1)

Gate Threshold Voltage ($V_{DS} = V_{GS}$, $I_D = 250\ \mu\text{Adc}$)	$V_{GS(th)}$	1.0	1.7	2.4	Vdc
Static Drain-to-Source On-Resistance ($V_{GS} = 10\text{ Vdc}$, $I_D = 1.5\text{ Adc}$) ($V_{GS} = 4.5\text{ Vdc}$, $I_D = 0.75\text{ Adc}$)	$r_{DS(on)}$	—	0.235 0.375	0.350 0.500	Ohms

DYNAMIC CHARACTERISTICS

Input Capacitance	($V_{DS} = 5.0\text{ Vdc}$)	C_{iss}	—	130	—	pF
Output Capacitance	($V_{DS} = 5.0\text{ Vdc}$)	C_{oss}	—	120	—	
Transfer Capacitance	($V_{DG} = 5.0\text{ Vdc}$)	C_{rss}	—	60	—	

SWITCHING CHARACTERISTICS(2)

Turn-On Delay Time	$(V_{DD} = 15\text{ Vdc}$, $I_D = 1.0\text{ Adc}$, $R_L = 50\ \Omega)$	$t_{d(on)}$	—	2.5	—	ns
Rise Time		t_r	—	1.0	—	
Turn-Off Delay Time		$t_{d(off)}$	—	16	—	
Fall Time		t_f	—	8.0	—	
Gate Charge (See Figure 6)		Q_T	—	6000	—	pC

SOURCE-DRAIN DIODE CHARACTERISTICS

Continuous Current	I_S	—	—	0.6	A
Pulsed Current	I_{SM}	—	—	0.75	
Forward Voltage(2)	V_{SD}	—	1.5	—	V

(1) Pulse Test: Pulse Width $\leq 300\ \mu\text{s}$, Duty Cycle $\leq 2\%$.

(2) Switching characteristics are independent of operating junction temperature.

TYPICAL ELECTRICAL CHARACTERISTICS

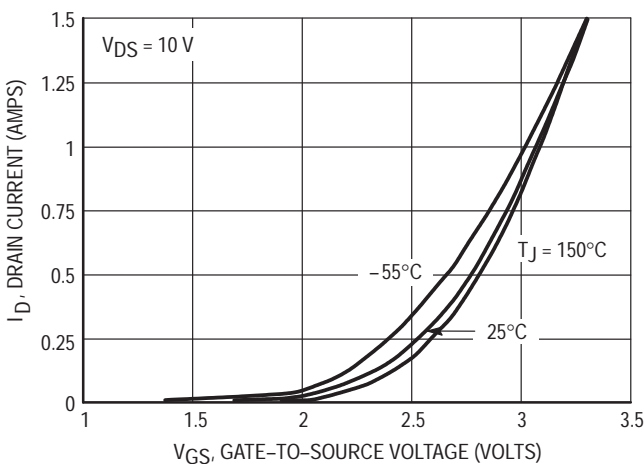


Figure 1. Transfer Characteristics

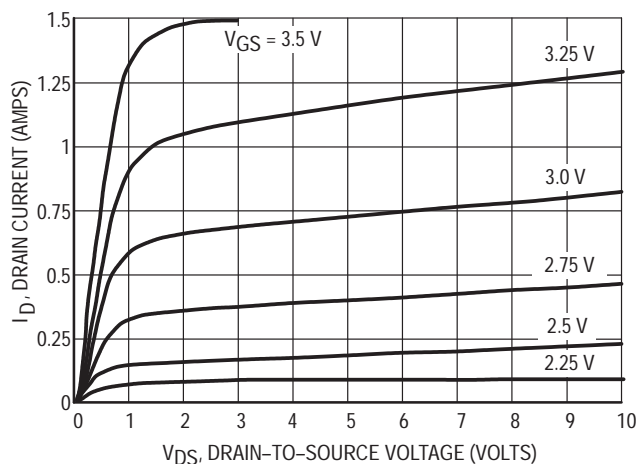


Figure 2. On-Region Characteristics

MGSF1P02LT1

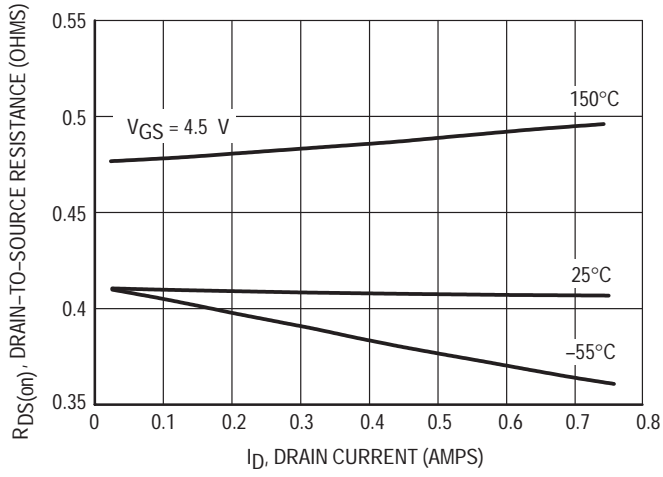


Figure 3. On-Resistance versus Drain Current

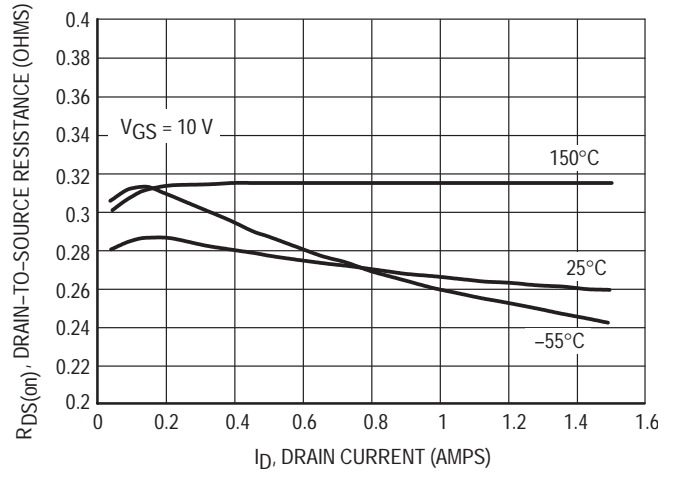


Figure 4. On-Resistance versus Drain Current

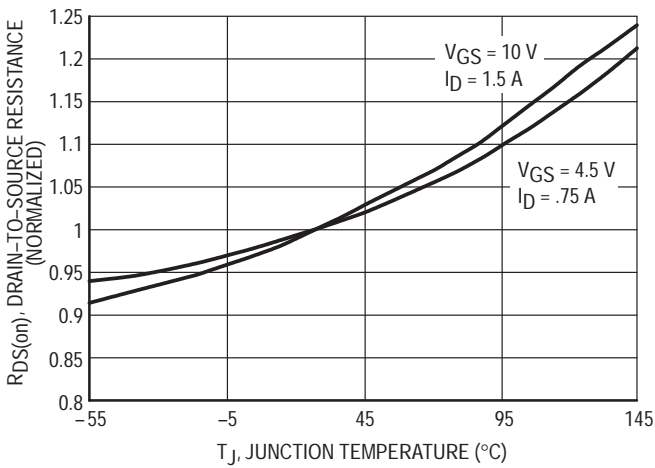


Figure 5. On-Resistance Variation with Temperature

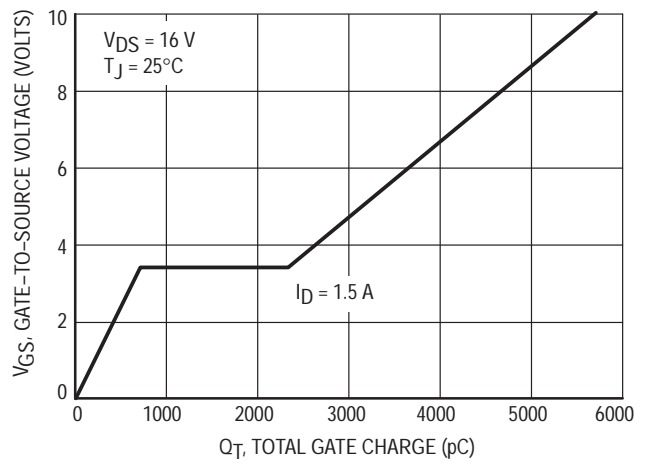


Figure 6. Gate Charge

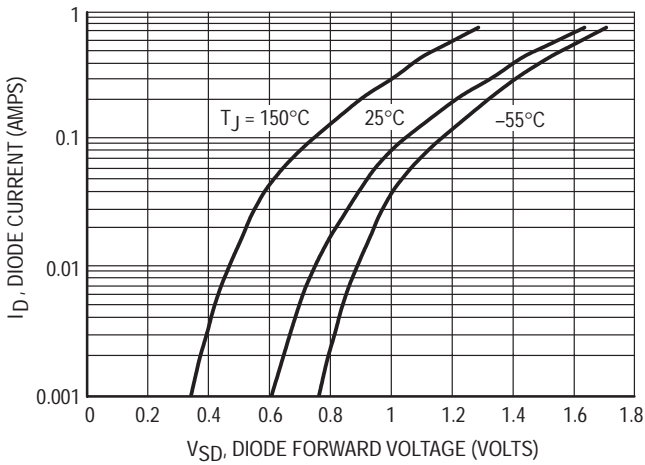


Figure 7. Body Diode Forward Voltage

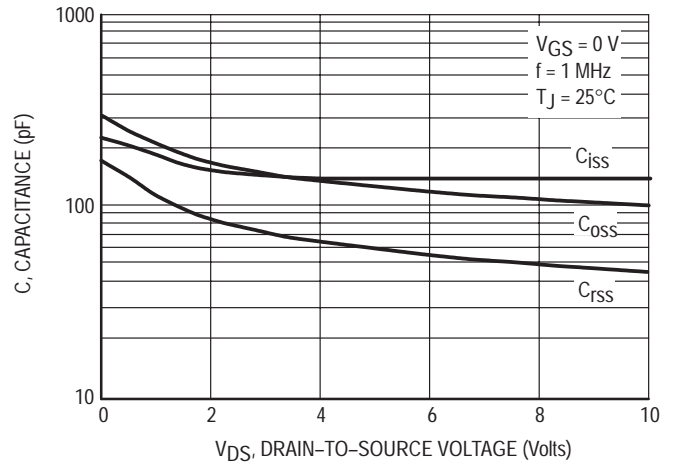


Figure 8. Capacitance



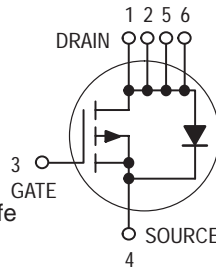
Preliminary Information

Low $r_{DS(on)}$ Small-Signal MOSFETs TMOS Single P-Channel Field Effect Transistors

Part of the GreenLine™ Portfolio of devices with energy-conserving traits.

These miniature surface mount MOSFETs utilize Motorola's High Cell Density, HDTMOS process. Low $r_{DS(on)}$ assures minimal power loss and conserves energy, making this device ideal for use in small power management circuitry. Typical applications are dc-dc converters, power management in portable and battery-powered products such as computers, printers, PCMCIA cards, cellular and cordless telephones.

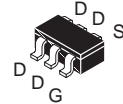
- Low $r_{DS(on)}$ Provides Higher Efficiency and Extends Battery Life
- Miniature TSOP 6 Surface Mount Package Saves Board Space
- Visit our Web Site at <http://www.mot-sps.com/ospd>



MGSF3441VT1

Motorola Preferred Device

P-CHANNEL
ENHANCEMENT-MODE
TMOS MOSFET
 $r_{DS(on)} = 78 \text{ m}\Omega$ (TYP)



CASE 318G-02, Style 1
TSOP 6 PLASTIC

2.5V RATED

MAXIMUM RATINGS ($T_J = 25^\circ\text{C}$ unless otherwise noted)

Rating	Symbol	Value	Unit
Drain-to-Source Voltage	V_{DSS}	20	Vdc
Gate-to-Source Voltage — Continuous	V_{GS}	± 8.0	Vdc
Drain Current — Continuous @ $T_A = 25^\circ\text{C}$ — Pulsed Drain Current ($t_p \leq 10 \mu\text{s}$)	I_D I_{DM}	3.3 20	A
Total Power Dissipation @ $T_A = 25^\circ\text{C}$ Mounted on FR4 $t \leq 5 \text{ sec}$	P_D	2.0	W
Operating and Storage Temperature Range	T_J, T_{stg}	-55 to 150	$^\circ\text{C}$
Thermal Resistance — Junction-to-Ambient	$R_{\theta JA}$	128	$^\circ\text{C/W}$
Maximum Lead Temperature for Soldering Purposes, for 10 seconds	T_L	260	$^\circ\text{C}$

ORDERING INFORMATION

Device	Reel Size	Tape Width	Quantity
MGSF3441VT1	7"	8 mm embossed tape	3000
MGSF3441VT3	13"	8 mm embossed tape	10,000

This document contains information on a product under development. Motorola reserves the right to change or discontinue this product without notice.

Preferred devices are Motorola recommended choices for future use and best overall value.

MGSF3441VT1

ELECTRICAL CHARACTERISTICS (T_A = 25°C unless otherwise noted)

Characteristic	Symbol	Min	Typ	Max	Unit	
OFF CHARACTERISTICS						
Drain-to-Source Breakdown Voltage (V _{GS} = 0 Vdc, I _D = 10 μA)	V _{(BR)DSS}	20	—	—	Vdc	
Zero Gate Voltage Drain Current (V _{DS} = 20 Vdc, V _{GS} = 0 Vdc) (V _{DS} = 20 Vdc, V _{GS} = 0 Vdc, T _J = 70°C)	I _{DSS}	—	—	1.0 4.0	μAdc	
Gate-Body Leakage Current (V _{GS} = ± 8.0 Vdc, V _{DS} = 0)	I _{GSS}	—	—	±100	nAdc	
ON CHARACTERISTICS(1)						
Gate Threshold Voltage (V _{DS} = V _{GS} , I _D = 250 μAdc)	V _{GS(th)}	0.45	—	—	Vdc	
Static Drain-to-Source On-Resistance (V _{GS} = 4.5 Vdc, I _D = 3.3 A) (V _{GS} = 2.5 Vdc, I _D = 2.9 A)	r _{DS(on)}	—	0.078 0.110	0.090 0.135	Ohms	
DYNAMIC CHARACTERISTICS						
Input Capacitance	(V _{DS} = 5.0 V)	C _{iss}	—	90	pF	
Output Capacitance	(V _{DS} = 5.0 V)	C _{oss}	—	50		
Transfer Capacitance	(V _{DG} = 5.0 V)	C _{rss}	—	10		
SWITCHING CHARACTERISTICS(2)						
Turn-On Delay Time	(V _{DD} = 15 Vdc, I _D = 1.0 A, V _{GEN} = 10 V, R _L = 10 Ω)	t _{d(on)}	—	27	50	ns
Rise Time		t _r	—	17	30	
Turn-Off Delay Time		t _{d(off)}	—	52	80	
Fall Time		t _f	—	45	70	
Gate Charge		Q _T	—	3000	—	pC
SOURCE-DRAIN DIODE CHARACTERISTICS						
Continuous Current	I _S	—	—	1.0	A	
Pulsed Current	I _{SM}	—	—	20	A	
Forward Voltage(2)	V _{SD}	—	0.80	1.2	V	

(1) Pulse Test: Pulse Width ≤ 300 μs, Duty Cycle ≤ 2%.

(2) Switching characteristics are independent of operating junction temperature.

TYPICAL ELECTRICAL CHARACTERISTICS

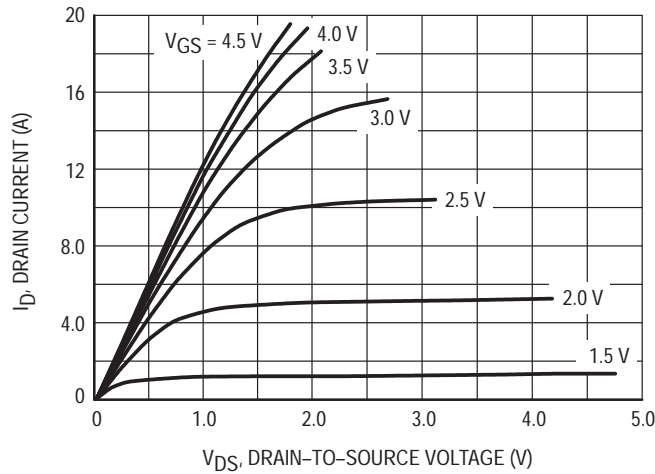


Figure 1. Output Characteristics

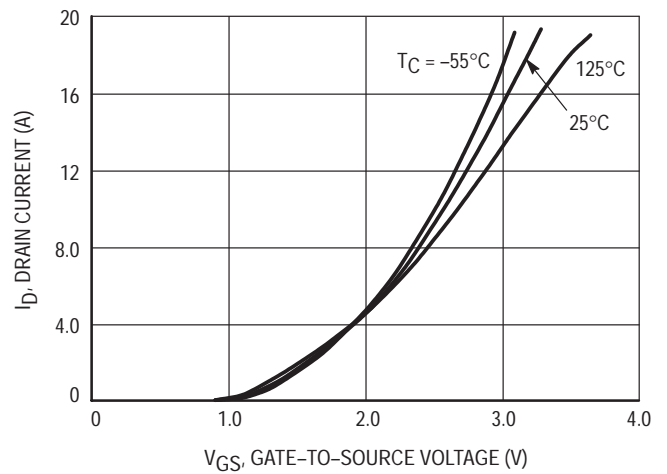


Figure 2. Transfer Characteristics

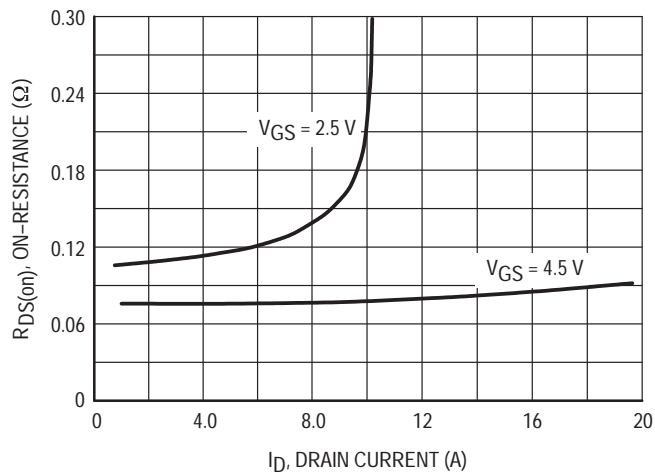


Figure 3. On-Resistance versus Drain Current

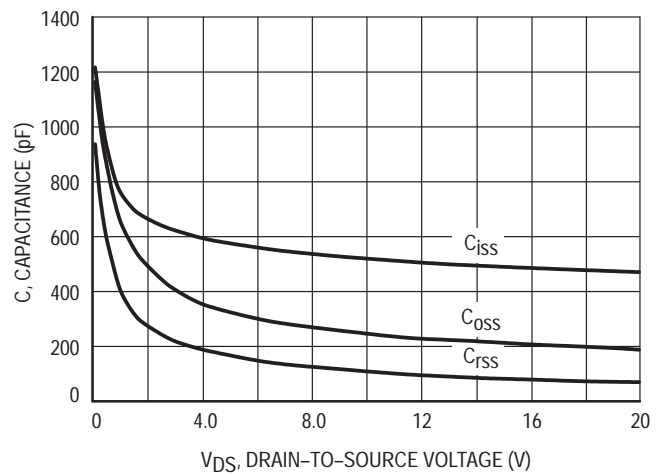


Figure 4. Capacitance

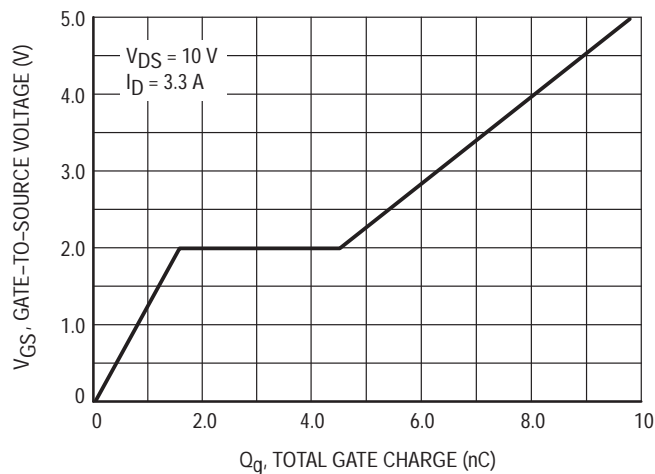


Figure 5. Gate Charge

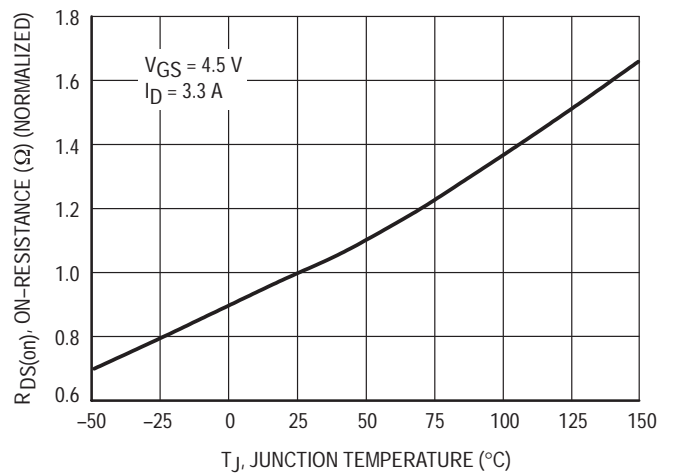


Figure 6. On-Resistance versus Junction Temperature

TYPICAL ELECTRICAL CHARACTERISTICS

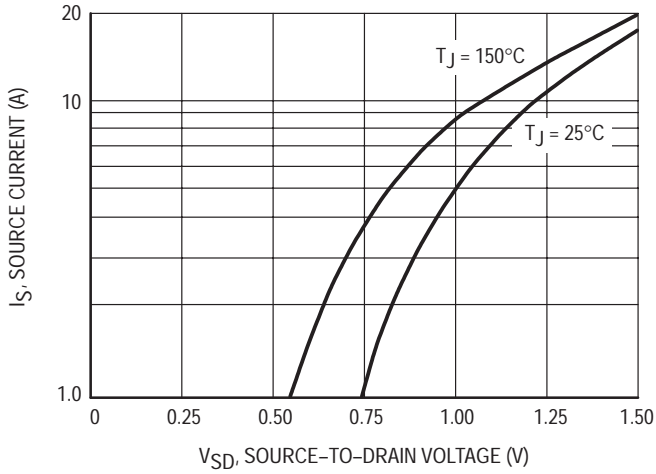


Figure 7. Source-Drain Diode Forward Voltage

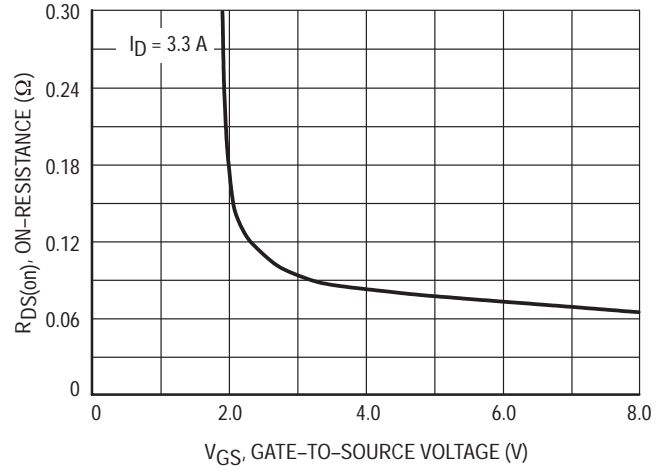


Figure 8. On-Resistance versus Gate-to-Source Voltage

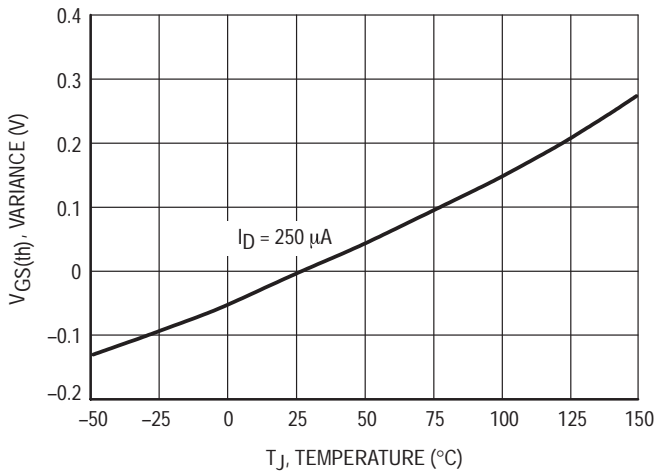


Figure 9. Threshold Voltage

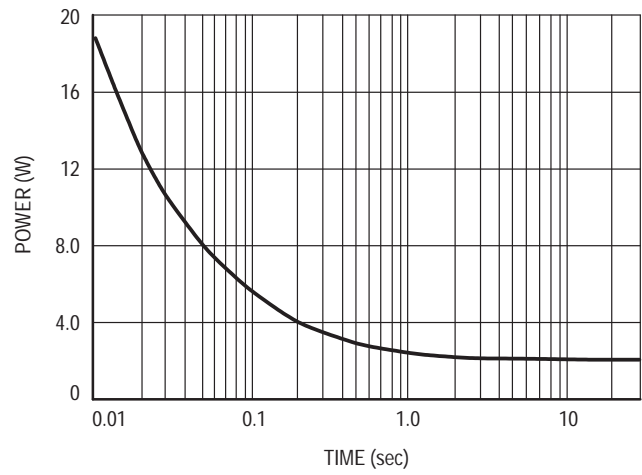


Figure 10. Single Pulse Power

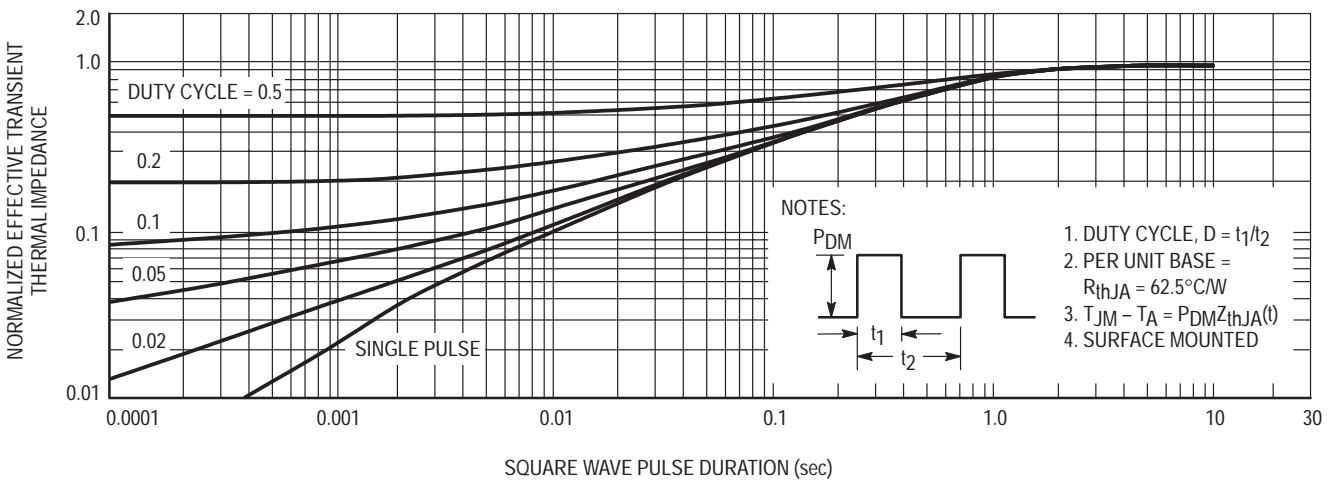


Figure 11. Normalized Thermal Transient Impedance, Junction-to-Ambient



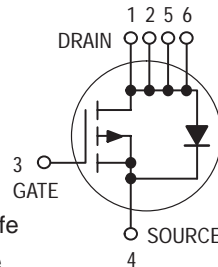
Preliminary Information

Low $r_{DS(on)}$ Small-Signal MOSFETs TMOS Single P-Channel Field Effect Transistors

Part of the GreenLine™ Portfolio of devices with energy-conserving traits.

These miniature surface mount MOSFETs utilize Motorola's High Cell Density, HDTMOS process. Low $r_{DS(on)}$ assures minimal power loss and conserves energy, making this device ideal for use in small power management circuitry. Typical applications are dc-dc converters, power management in portable and battery-powered products such as computers, printers, PCMCIA cards, cellular and cordless telephones.

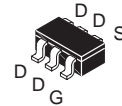
- Low $r_{DS(on)}$ Provides Higher Efficiency and Extends Battery Life
- Miniature TSOP 6 Surface Mount Package Saves Board Space
- Visit our Web Site at <http://www.mot-sps.com/ospd>



MGSF3441XT1

Motorola Preferred Device

P-CHANNEL
ENHANCEMENT-MODE
TMOS MOSFET
 $r_{DS(on)} = 78 \text{ m}\Omega$ (TYP)



CASE 318G-02, Style 1
TSOP 6 PLASTIC

2.5V RATED

MAXIMUM RATINGS ($T_J = 25^\circ\text{C}$ unless otherwise noted)

Rating	Symbol	Value	Unit
Drain-to-Source Voltage	V_{DSS}	20	Vdc
Gate-to-Source Voltage — Continuous	V_{GS}	± 8.0	Vdc
Drain Current — Continuous @ $T_A = 25^\circ\text{C}$ — Pulsed Drain Current ($t_p \leq 10 \mu\text{s}$)	I_D I_{DM}	1.5 20	A
Total Power Dissipation @ $T_A = 25^\circ\text{C}$	P_D	950	mW
Operating and Storage Temperature Range	T_J, T_{stg}	-55 to 150	$^\circ\text{C}$
Thermal Resistance — Junction-to-Ambient	$R_{\theta JA}$	132	$^\circ\text{C}/\text{W}$
Maximum Lead Temperature for Soldering Purposes, for 10 seconds	T_L	260	$^\circ\text{C}$

ORDERING INFORMATION

Device	Reel Size	Tape Width	Quantity
MGSF3441XT1	7"	8 mm embossed tape	3000
MGSF3441XT3	13"	8 mm embossed tape	10,000

This document contains information on a product under development. Motorola reserves the right to change or discontinue this product without notice.

Preferred devices are Motorola recommended choices for future use and best overall value.

MGSF3441XT1

ELECTRICAL CHARACTERISTICS (T_A = 25°C unless otherwise noted)

Characteristic	Symbol	Min	Typ	Max	Unit
----------------	--------	-----	-----	-----	------

OFF CHARACTERISTICS

Drain-to-Source Breakdown Voltage (V _{GS} = 0 Vdc, I _D = 10 μA)	V _{(BR)DSS}	20	—	—	Vdc
Zero Gate Voltage Drain Current (V _{DS} = 20 Vdc, V _{GS} = 0 Vdc) (V _{DS} = 20 Vdc, V _{GS} = 0 Vdc, T _J = 70°C)	I _{DSS}	—	—	1.0 4.0	μAdc
Gate-Body Leakage Current (V _{GS} = ± 8.0 Vdc, V _{DS} = 0)	I _{GSS}	—	—	±100	nAdc

ON CHARACTERISTICS(1)

Gate Threshold Voltage (V _{DS} = V _{GS} , I _D = 250 μAdc)	V _{GS(th)}	0.45	—	—	Vdc
Static Drain-to-Source On-Resistance (V _{GS} = 4.5 Vdc, I _D = 1.5 A) (V _{GS} = 2.5 Vdc, I _D = 1.2 A)	r _{DS(on)}	—	0.078 0.110	0.100 0.135	Ohms

DYNAMIC CHARACTERISTICS

Input Capacitance	(V _{DS} = 5.0 V)	C _{iss}	—	90	—	pF
Output Capacitance	(V _{DS} = 5.0 V)	C _{oss}	—	50	—	
Transfer Capacitance	(V _{DG} = 5.0 V)	C _{rss}	—	10	—	

SWITCHING CHARACTERISTICS(2)

Turn-On Delay Time	(V _{DD} = 15 Vdc, I _D = 1.0 A, V _{GEN} = 10 V, R _L = 10 Ω)	t _{d(on)}	—	27	50	ns
Rise Time		t _r	—	17	30	
Turn-Off Delay Time		t _{d(off)}	—	52	80	
Fall Time		t _f	—	45	70	
Gate Charge		Q _T	—	3000	—	pC

SOURCE-DRAIN DIODE CHARACTERISTICS

Continuous Current	I _S	—	—	1.0	A
Pulsed Current	I _{SM}	—	—	20	A
Forward Voltage(2)	V _{SD}	—	0.80	1.2	V

(1) Pulse Test: Pulse Width ≤ 300 μs, Duty Cycle ≤ 2%.

(2) Switching characteristics are independent of operating junction temperature.



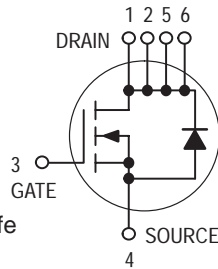
Preliminary Information

Low $r_{DS(on)}$ Small-Signal MOSFETs TMOS Single N-Channel Field Effect Transistors

Part of the GreenLine™ Portfolio of devices with energy-conserving traits.

These miniature surface mount MOSFETs utilize Motorola's High Cell Density, HDTMOS process. Low $r_{DS(on)}$ assures minimal power loss and conserves energy, making this device ideal for use in small power management circuitry. Typical applications are dc-dc converters, power management in portable and battery-powered products such as computers, printers, PCMCIA cards, cellular and cordless telephones.

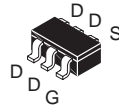
- Low $r_{DS(on)}$ Provides Higher Efficiency and Extends Battery Life
- Miniature TSOP 6 Surface Mount Package Saves Board Space
- Visit our Web Site at <http://www.mot-sps.com/ospd>



MGSF3442VT1

Motorola Preferred Device

N-CHANNEL
ENHANCEMENT-MODE
TMOS MOSFET
 $r_{DS(on)} = 58 \text{ m}\Omega$ (TYP)



CASE 318G-02, Style 1
TSOP 6 PLASTIC

2.5V RATED

MAXIMUM RATINGS ($T_J = 25^\circ\text{C}$ unless otherwise noted)

Rating	Symbol	Value	Unit
Drain-to-Source Voltage	V_{DSS}	20	Vdc
Gate-to-Source Voltage — Continuous	V_{GS}	± 8.0	Vdc
Drain Current — Continuous @ $T_A = 25^\circ\text{C}$ — Pulsed Drain Current ($t_p \leq 10 \mu\text{s}$)	I_D I_{DM}	4.0 20	A
Total Power Dissipation @ $T_A = 25^\circ\text{C}$ Mounted on FR4 $t \leq 5 \text{ sec}$	P_D	2.0	W
Operating and Storage Temperature Range	T_J, T_{stg}	-55 to 150	$^\circ\text{C}$
Thermal Resistance — Junction-to-Ambient	$R_{\theta JA}$	62.5	$^\circ\text{C/W}$
Maximum Lead Temperature for Soldering Purposes, for 10 seconds	T_L	260	$^\circ\text{C}$

ORDERING INFORMATION

Device	Reel Size	Tape Width	Quantity
MGSF3442VT1	7"	8 mm embossed tape	3000
MGSF3442VT3	13"	8 mm embossed tape	10,000

This document contains information on a product under development. Motorola reserves the right to change or discontinue this product without notice.

Preferred devices are Motorola recommended choices for future use and best overall value.

MGSF3442VT1

ELECTRICAL CHARACTERISTICS (T_A = 25°C unless otherwise noted)

Characteristic	Symbol	Min	Typ	Max	Unit
----------------	--------	-----	-----	-----	------

OFF CHARACTERISTICS

Drain-to-Source Breakdown Voltage (V _{GS} = 0 Vdc, I _D = 10 μA)	V _{(BR)DSS}	20	—	—	Vdc
Zero Gate Voltage Drain Current (V _{DS} = 20 Vdc, V _{GS} = 0 Vdc) (V _{DS} = 20 Vdc, V _{GS} = 0 Vdc, T _J = 70°C)	I _{DSS}	—	—	1.0 5.0	μAdc
Gate-Body Leakage Current (V _{GS} = ± 8.0 Vdc, V _{DS} = 0)	I _{GSS}	—	—	±100	nAdc

ON CHARACTERISTICS(1)

Gate Threshold Voltage (V _{DS} = V _{GS} , I _D = 250 μAdc)	V _{GS(th)}	0.6	—	—	Vdc
Static Drain-to-Source On-Resistance (V _{GS} = 4.5 Vdc, I _D = 4.0 A) (V _{GS} = 2.5 Vdc, I _D = 3.4 A)	r _{DS(on)}	—	0.058 0.072	0.070 0.095	Ohms

DYNAMIC CHARACTERISTICS

Input Capacitance	(V _{DS} = 5.0 V)	C _{iss}	—	90	—	pF
Output Capacitance	(V _{DS} = 5.0 V)	C _{oss}	—	50	—	
Transfer Capacitance	(V _{DG} = 5.0 V)	C _{rss}	—	10	—	

SWITCHING CHARACTERISTICS(2)

Turn-On Delay Time	(V _{DD} = 10 Vdc, I _D = 1.0 A, V _{GEN} = 10 V, R _L = 10 Ω)	t _{d(on)}	—	8.0	20	ns
Rise Time		t _r	—	24	40	
Turn-Off Delay Time		t _{d(off)}	—	36	60	
Fall Time		t _f	—	10	20	
Gate Charge		Q _T	—	—	—	nC

SOURCE-DRAIN DIODE CHARACTERISTICS

Continuous Current	I _S	—	—	1.0	A
Pulsed Current	I _{SM}	—	—	5.0	A
Forward Voltage(2)	V _{SD}	—	—	1.2	V

(1) Pulse Test: Pulse Width ≤ 300 μs, Duty Cycle ≤ 2%.

(2) Switching characteristics are independent of operating junction temperature.

TYPICAL ELECTRICAL CHARACTERISTICS

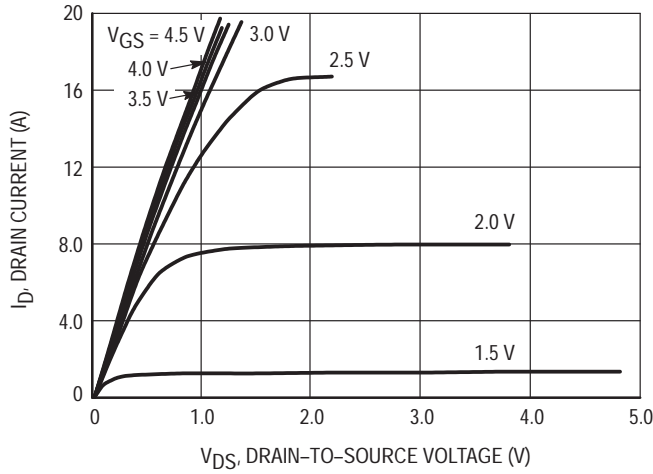


Figure 1. Output Characteristics

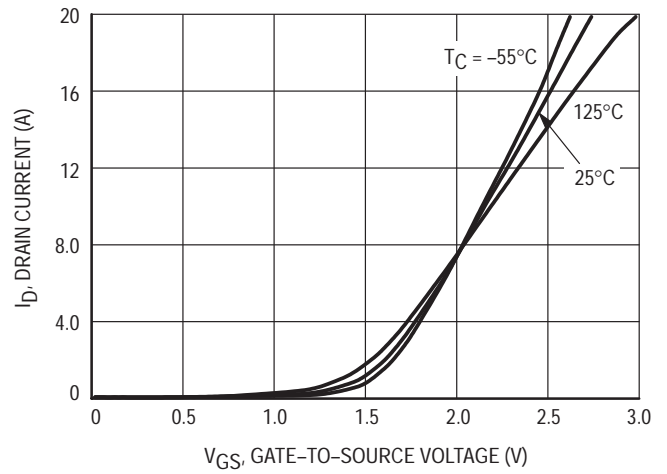


Figure 2. Transfer Characteristics

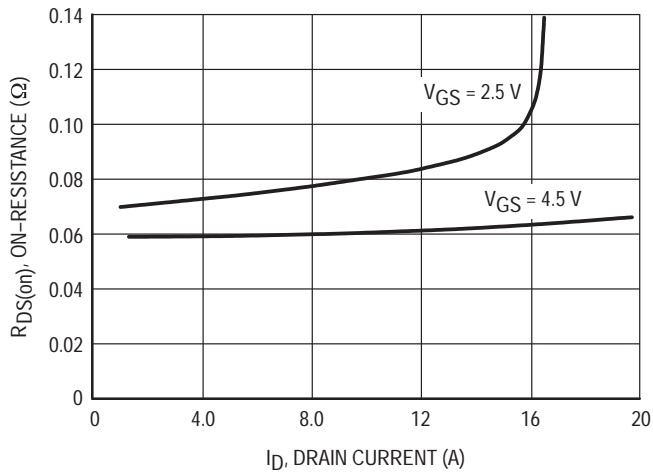


Figure 3. On-Resistance versus Drain Current

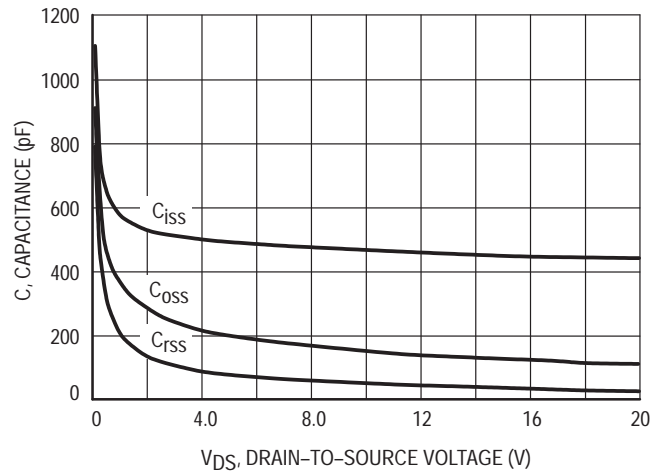


Figure 4. Capacitance

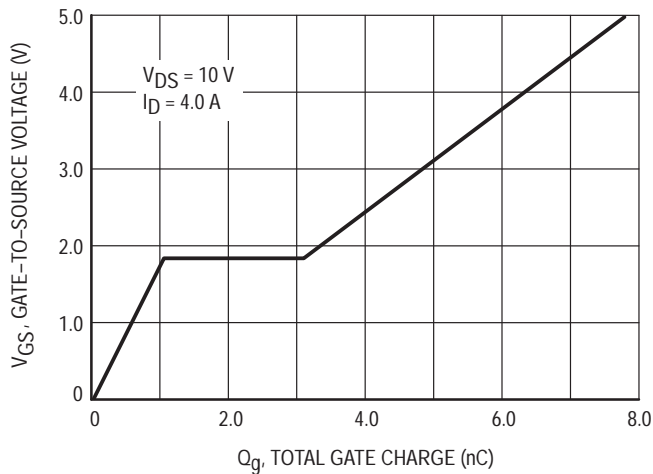


Figure 5. Gate Charge

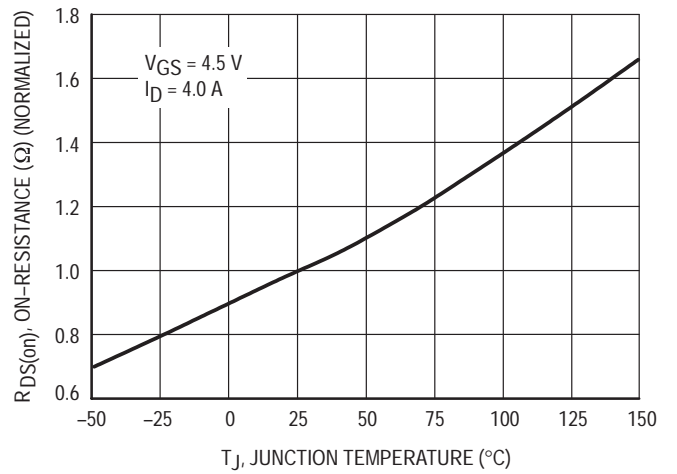


Figure 6. On-Resistance versus Junction Temperature

TYPICAL ELECTRICAL CHARACTERISTICS

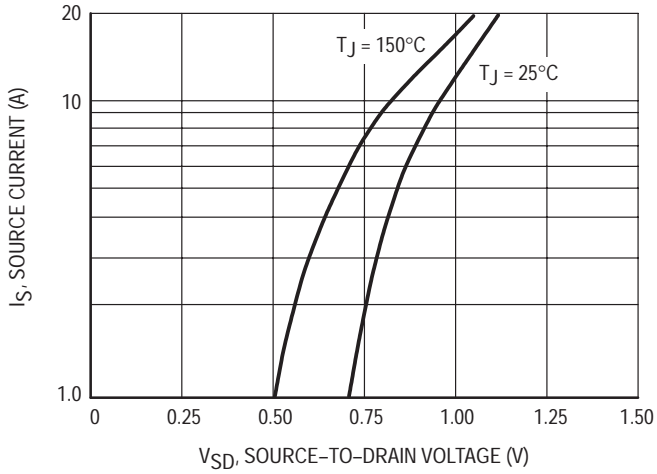


Figure 7. Source-Drain Diode Forward Voltage

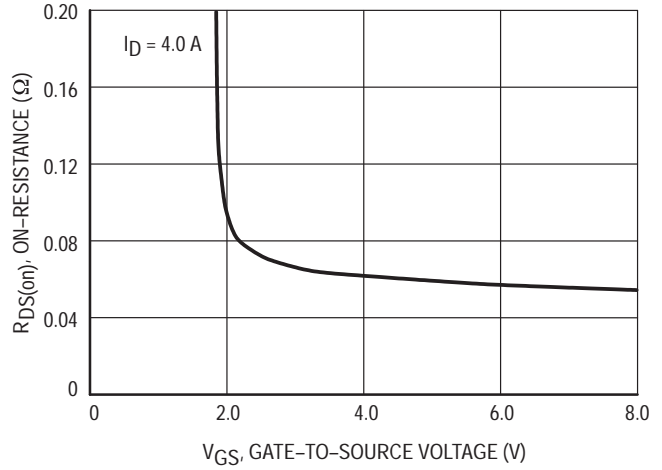


Figure 8. On-Resistance versus Gate-to-Source Voltage

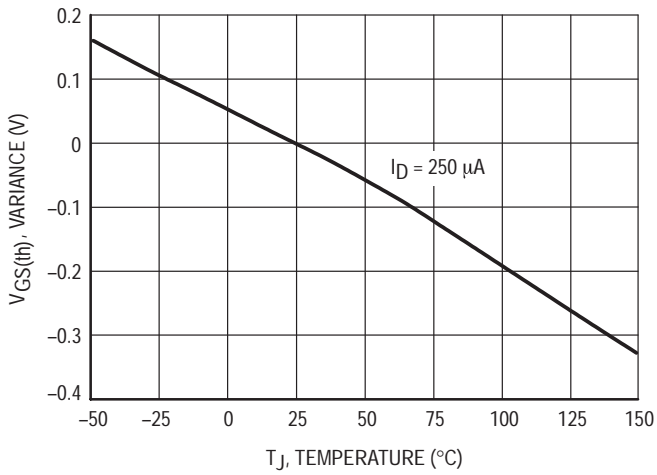


Figure 9. Threshold Voltage

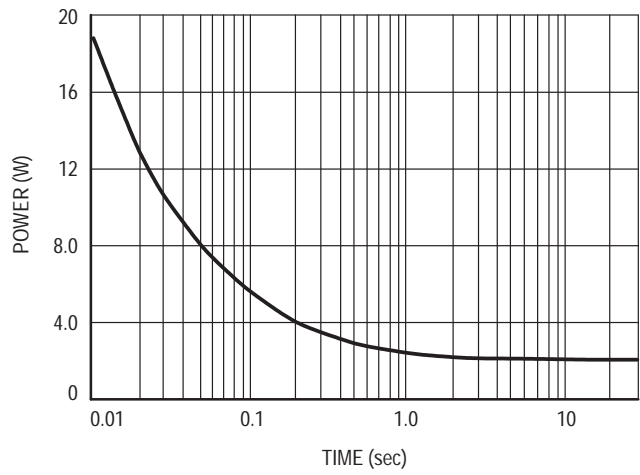


Figure 10. Single Pulse Power

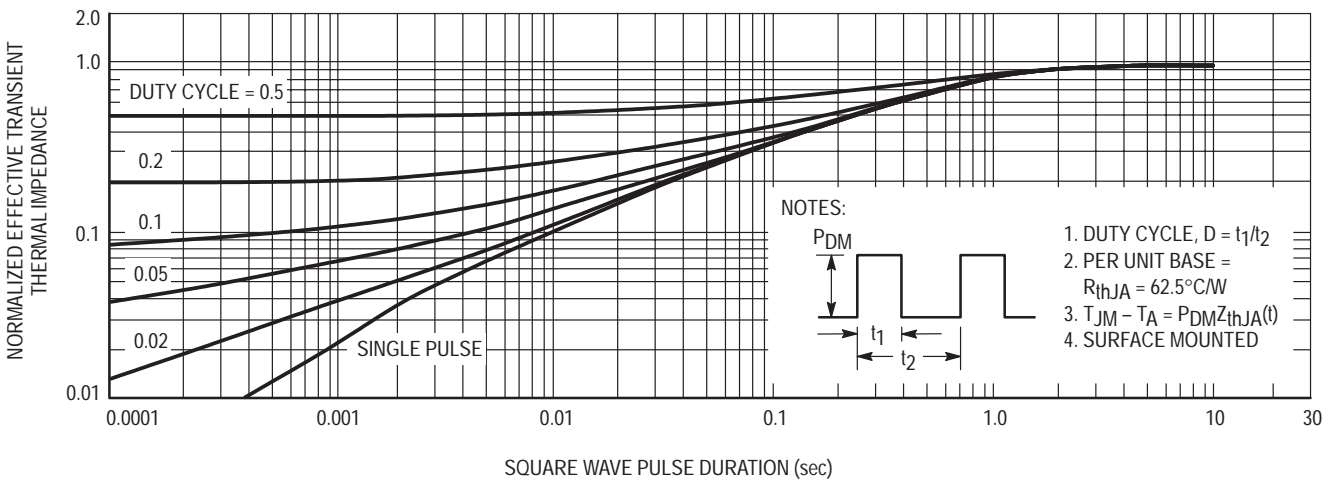


Figure 11. Normalized Thermal Transient Impedance, Junction-to-Ambient



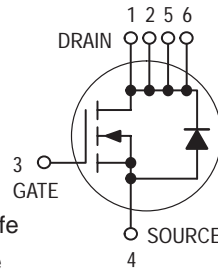
Preliminary Information

Low $r_{DS(on)}$ Small-Signal MOSFETs TMOS Single N-Channel Field Effect Transistors

Part of the GreenLine™ Portfolio of devices with energy-conserving traits.

These miniature surface mount MOSFETs utilize Motorola's High Cell Density, HDTMOS process. Low $r_{DS(on)}$ assures minimal power loss and conserves energy, making this device ideal for use in small power management circuitry. Typical applications are dc-dc converters, power management in portable and battery-powered products such as computers, printers, PCMCIA cards, cellular and cordless telephones.

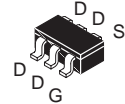
- Low $r_{DS(on)}$ Provides Higher Efficiency and Extends Battery Life
- Miniature TSOP 6 Surface Mount Package Saves Board Space
- Visit our Web Site at <http://www.mot-sps.com/ospd>



MGSF3442XT1

Motorola Preferred Device

N-CHANNEL
ENHANCEMENT-MODE
TMOS MOSFET
 $r_{DS(on)} = 58 \text{ m}\Omega$ (TYP)



CASE 318G-02, Style 1
TSOP 6 PLASTIC

2.5V RATED

MAXIMUM RATINGS ($T_J = 25^\circ\text{C}$ unless otherwise noted)

Rating	Symbol	Value	Unit
Drain-to-Source Voltage	V_{DSS}	20	Vdc
Gate-to-Source Voltage — Continuous	V_{GS}	± 8.0	Vdc
Drain Current — Continuous @ $T_A = 25^\circ\text{C}$ — Pulsed Drain Current ($t_p \leq 10 \mu\text{s}$)	I_D I_{DM}	1.7 20	A
Total Power Dissipation @ $T_A = 25^\circ\text{C}$	P_D	400	mW
Operating and Storage Temperature Range	T_J, T_{stg}	-55 to 150	$^\circ\text{C}$
Thermal Resistance — Junction-to-Ambient	$R_{\theta JA}$	300	$^\circ\text{C}/\text{W}$
Maximum Lead Temperature for Soldering Purposes, for 10 seconds	T_L	260	$^\circ\text{C}$

ORDERING INFORMATION

Device	Reel Size	Tape Width	Quantity
MGSF3442XT1	7"	8 mm embossed tape	3000
MGSF3442XT3	13"	8 mm embossed tape	10,000

This document contains information on a product under development. Motorola reserves the right to change or discontinue this product without notice.

Preferred devices are Motorola recommended choices for future use and best overall value.

MGSF3442XT1

ELECTRICAL CHARACTERISTICS (T_A = 25°C unless otherwise noted)

Characteristic	Symbol	Min	Typ	Max	Unit
----------------	--------	-----	-----	-----	------

OFF CHARACTERISTICS

Drain-to-Source Breakdown Voltage (V _{GS} = 0 Vdc, I _D = 10 μA)	V _{(BR)DSS}	20	—	—	Vdc
Zero Gate Voltage Drain Current (V _{DS} = 20 Vdc, V _{GS} = 0 Vdc) (V _{DS} = 20 Vdc, V _{GS} = 0 Vdc, T _J = 70°C)	I _{DSS}	—	—	1.0 5.0	μAdc
Gate-Body Leakage Current (V _{GS} = ± 8.0 Vdc, V _{DS} = 0)	I _{GSS}	—	—	±100	nAdc

ON CHARACTERISTICS(1)

Gate Threshold Voltage (V _{DS} = V _{GS} , I _D = 250 μAdc)	V _{GS(th)}	0.6	—	—	Vdc
Static Drain-to-Source On-Resistance (V _{GS} = 4.5 Vdc, I _D = 1.7 A) (V _{GS} = 2.5 Vdc, I _D = 1.3 A)	r _{DS(on)}	—	0.058 0.072	0.070 0.095	Ohms

DYNAMIC CHARACTERISTICS

Input Capacitance	(V _{DS} = 5.0 V)	C _{iss}	—	90	—	pF
Output Capacitance	(V _{DS} = 5.0 V)	C _{oss}	—	50	—	
Transfer Capacitance	(V _{DG} = 5.0 V)	C _{rss}	—	10	—	

SWITCHING CHARACTERISTICS(2)

Turn-On Delay Time	(V _{DD} = 10 Vdc, I _D = 1.0 A, V _{GEN} = 10 V, R _L = 10 Ω)	t _{d(on)}	—	8.0	20	ns
Rise Time		t _r	—	24	40	
Turn-Off Delay Time		t _{d(off)}	—	36	60	
Fall Time		t _f	—	10	20	
Gate Charge		Q _T	—	—	—	nC

SOURCE-DRAIN DIODE CHARACTERISTICS

Continuous Current	I _S	—	—	1.0	A
Pulsed Current	I _{SM}	—	—	5.0	A
Forward Voltage(2)	V _{SD}	—	—	1.2	V

(1) Pulse Test: Pulse Width ≤ 300 μs, Duty Cycle ≤ 2%.

(2) Switching characteristics are independent of operating junction temperature.



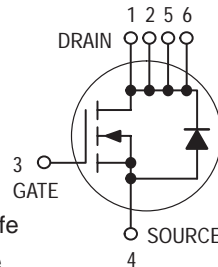
Preliminary Information

Low $r_{DS(on)}$ Small-Signal MOSFETs TMOS Single N-Channel Field Effect Transistors

Part of the GreenLine™ Portfolio of devices with energy-conserving traits.

These miniature surface mount MOSFETs utilize Motorola's High Cell Density, HDTMOS process. Low $r_{DS(on)}$ assures minimal power loss and conserves energy, making this device ideal for use in small power management circuitry. Typical applications are dc-dc converters, power management in portable and battery-powered products such as computers, printers, PCMCIA cards, cellular and cordless telephones.

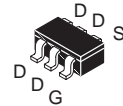
- Low $r_{DS(on)}$ Provides Higher Efficiency and Extends Battery Life
- Miniature TSOP 6 Surface Mount Package Saves Board Space
- Visit our Web Site at <http://www.mot-sps.com/ospd>



MGSF3454VT1

Motorola Preferred Device

N-CHANNEL
ENHANCEMENT-MODE
TMOS MOSFET
 $r_{DS(on)} = 50 \text{ m}\Omega$ (TYP)



CASE 318G-02, Style 1
TSOP 6 PLASTIC

MAXIMUM RATINGS ($T_J = 25^\circ\text{C}$ unless otherwise noted)

Rating	Symbol	Value	Unit
Drain-to-Source Voltage	V_{DSS}	30	Vdc
Gate-to-Source Voltage — Continuous	V_{GS}	± 20	Vdc
Drain Current — Continuous @ $T_A = 25^\circ\text{C}$ — Pulsed Drain Current ($t_p \leq 10 \mu\text{s}$)	I_D I_{DM}	4.2 20	A
Total Power Dissipation @ $T_A = 25^\circ\text{C}$ Mounted on FR4 $t \leq 5 \text{ sec}$	P_D	2.0	W
Operating and Storage Temperature Range	T_J, T_{stg}	-55 to 150	$^\circ\text{C}$
Thermal Resistance — Junction-to-Ambient	$R_{\theta JA}$	62.5	$^\circ\text{C/W}$
Maximum Lead Temperature for Soldering Purposes, for 10 seconds	T_L	260	$^\circ\text{C}$

ORDERING INFORMATION

Device	Reel Size	Tape Width	Quantity
MGSF3454VT1	7"	8 mm embossed tape	3000
MGSF3454VT3	13"	8 mm embossed tape	10,000

This document contains information on a product under development. Motorola reserves the right to change or discontinue this product without notice.

Preferred devices are Motorola recommended choices for future use and best overall value.

MGSF3454VT1

ELECTRICAL CHARACTERISTICS (T_A = 25°C unless otherwise noted)

Characteristic	Symbol	Min	Typ	Max	Unit
----------------	--------	-----	-----	-----	------

OFF CHARACTERISTICS

Drain-to-Source Breakdown Voltage (V _{GS} = 0 Vdc, I _D = 10 μA)	V _{(BR)DSS}	30	—	—	Vdc
Zero Gate Voltage Drain Current (V _{DS} = 30 Vdc, V _{GS} = 0 Vdc) (V _{DS} = 30 Vdc, V _{GS} = 0 Vdc, T _J = 70°C)	I _{DSS}	—	—	1.0 25	μAdc
Gate-Body Leakage Current (V _{GS} = ± 20 Vdc, V _{DS} = 0)	I _{GSS}	—	—	±100	nAdc

ON CHARACTERISTICS(1)

Gate Threshold Voltage (V _{DS} = V _{GS} , I _D = 250 μAdc)	V _{GS(th)}	1.0	—	—	Vdc
Static Drain-to-Source On-Resistance (V _{GS} = 10 Vdc, I _D = 4.2 A) (V _{GS} = 4.5 Vdc, I _D = 3.4 A)	r _{DS(on)}	—	0.05 0.07	0.065 0.095	Ohms

DYNAMIC CHARACTERISTICS

Input Capacitance	(V _{DS} = 5.0 V)	C _{iss}	—	90	—	pF
Output Capacitance	(V _{DS} = 5.0 V)	C _{oss}	—	50	—	
Transfer Capacitance	(V _{DG} = 5.0 V)	C _{rss}	—	10	—	

SWITCHING CHARACTERISTICS(2)

Turn-On Delay Time	(V _{DD} = 10 Vdc, I _D = 1.0 A, V _{GEN} = 10 V, R _L = 10 Ω)	t _{d(on)}	—	10	20	ns
Rise Time		t _r	—	15	30	
Turn-Off Delay Time		t _{d(off)}	—	20	35	
Fall Time		t _f	—	10	20	
Gate Charge		Q _T	—	—	15	nC

SOURCE-DRAIN DIODE CHARACTERISTICS

Continuous Current	I _S	—	—	1.0	A
Pulsed Current	I _{SM}	—	—	5.0	A
Forward Voltage(2)	V _{SD}	—	—	1.2	V

(1) Pulse Test: Pulse Width ≤ 300 μs, Duty Cycle ≤ 2%.

(2) Switching characteristics are independent of operating junction temperature.

TYPICAL ELECTRICAL CHARACTERISTICS

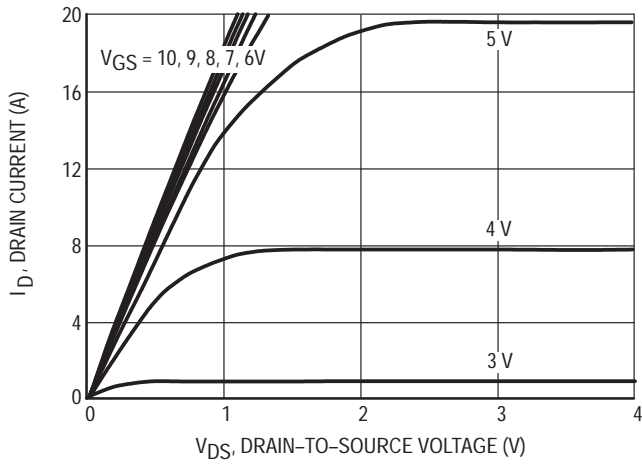


Figure 1. Output Characteristics

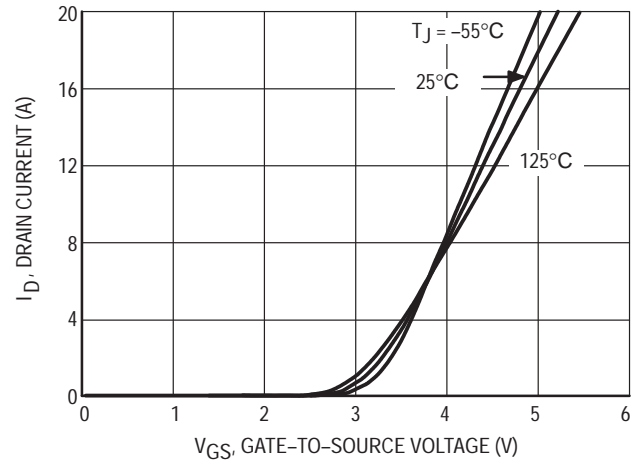


Figure 2. Transfer Characteristics

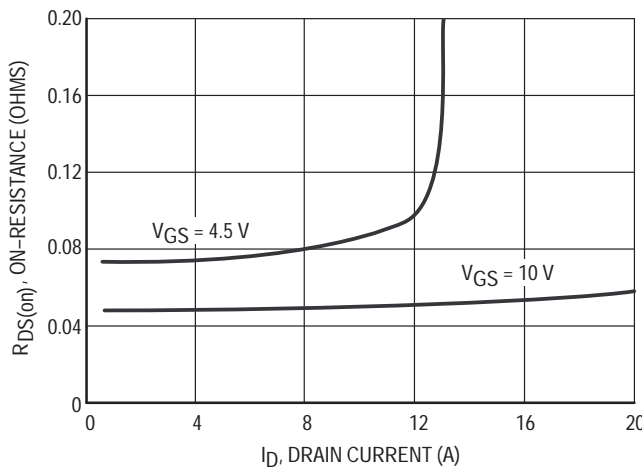


Figure 3. On-Resistance vs. Drain Current

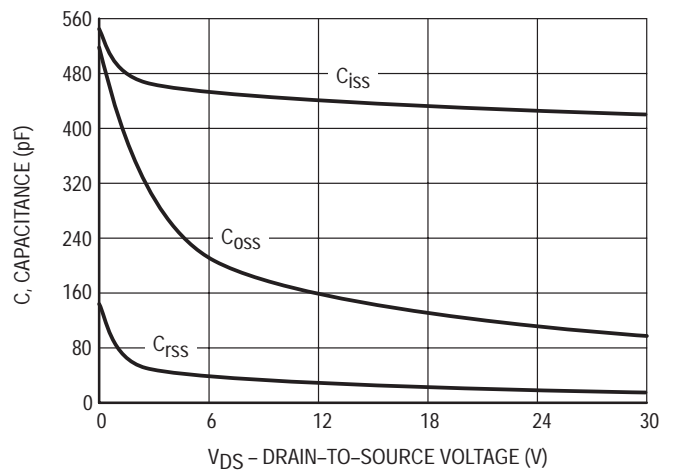


Figure 4. Capacitance

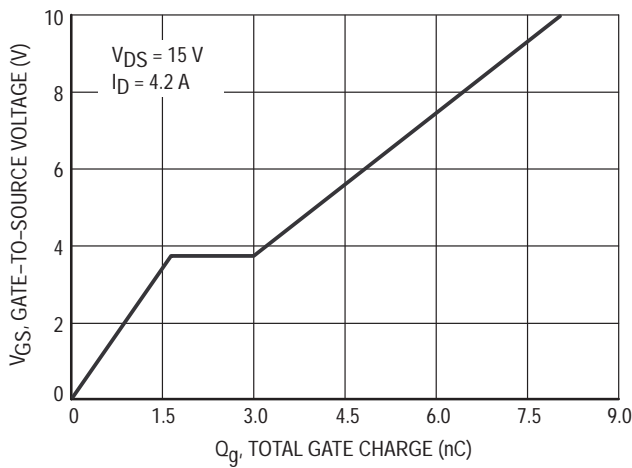


Figure 5. Gate Charge

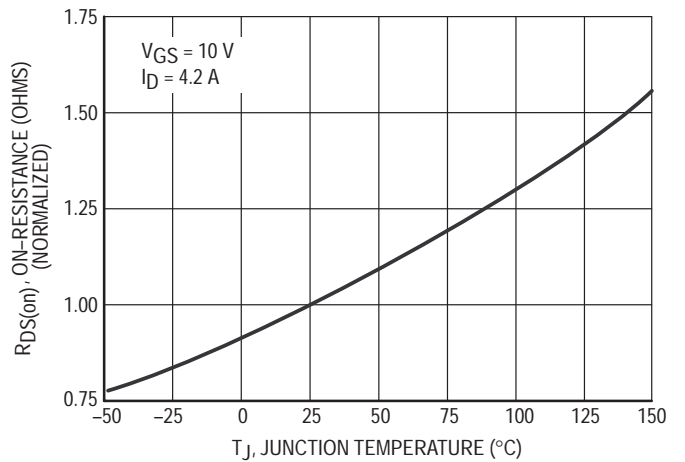


Figure 6. On-Resistance vs. Junction Temperature

TYPICAL ELECTRICAL CHARACTERISTICS

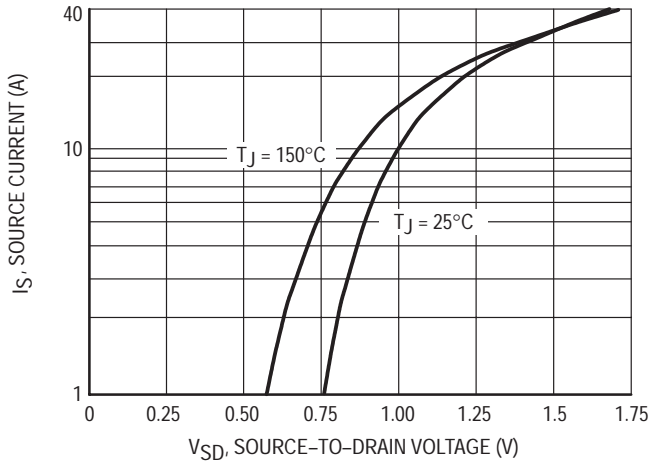


Figure 7. Source-Drain Diode Forward Voltage

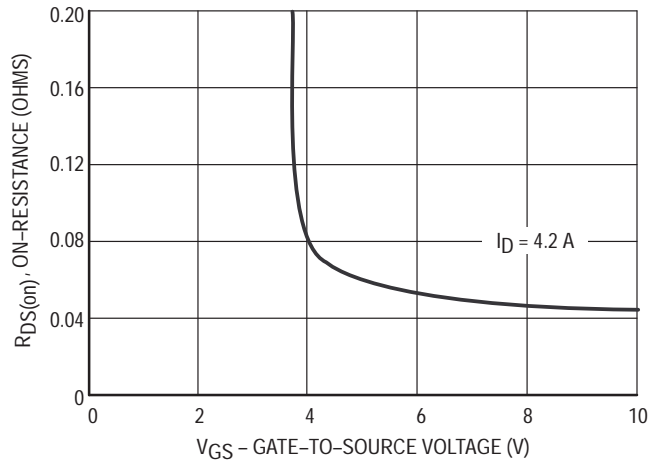


Figure 8. On-Resistance vs. Gate-to-Source Voltage

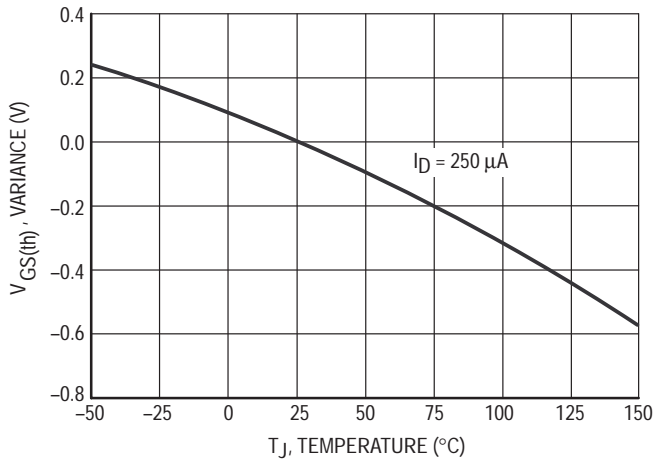


Figure 9. Threshold Voltage

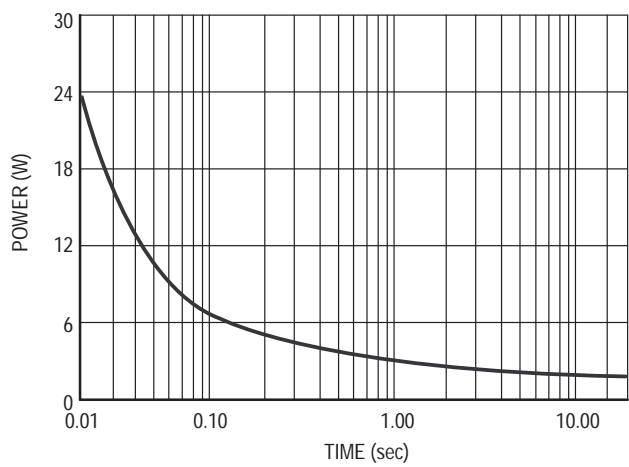


Figure 10. Single Pulse Power

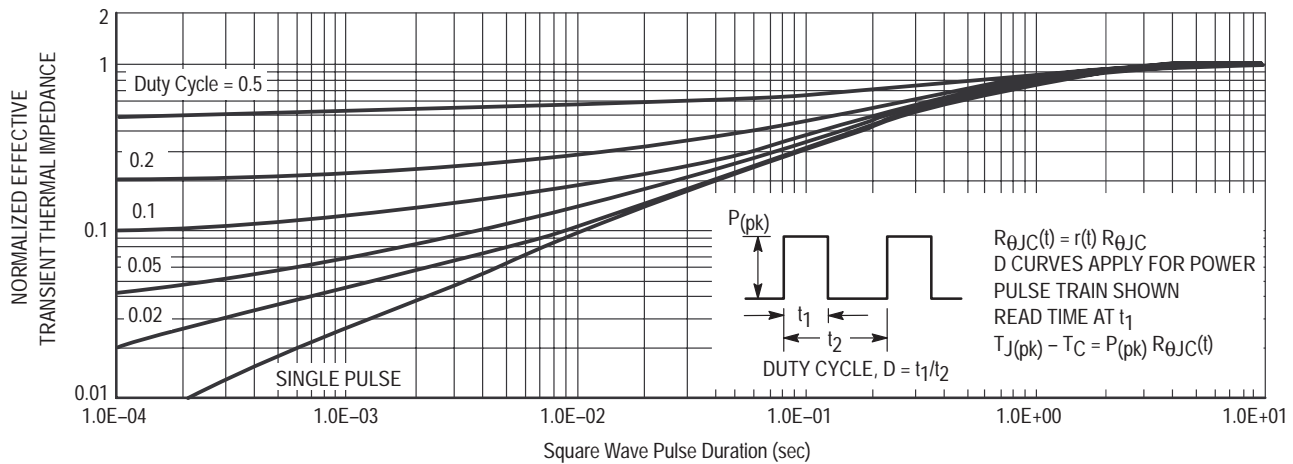


Figure 11. Normalized Thermal Transient Impedance, Junction-to-Ambient



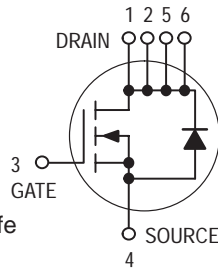
Preliminary Information

Low $r_{DS(on)}$ Small-Signal MOSFETs TMOS Single N-Channel Field Effect Transistors

Part of the GreenLine™ Portfolio of devices with energy-conserving traits.

These miniature surface mount MOSFETs utilize Motorola's High Cell Density, HDTMOS process. Low $r_{DS(on)}$ assures minimal power loss and conserves energy, making this device ideal for use in small power management circuitry. Typical applications are dc-dc converters, power management in portable and battery-powered products such as computers, printers, PCMCIA cards, cellular and cordless telephones.

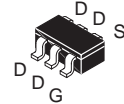
- Low $r_{DS(on)}$ Provides Higher Efficiency and Extends Battery Life
- Miniature TSOP 6 Surface Mount Package Saves Board Space
- Visit our Web Site at <http://www.mot-sps.com/ospd>



MGSF3454XT1

Motorola Preferred Device

N-CHANNEL
ENHANCEMENT-MODE
TMOS MOSFET
 $r_{DS(on)} = 50 \text{ m}\Omega$ (TYP)



CASE 318G-02, Style 1
TSOP 6 PLASTIC

MAXIMUM RATINGS ($T_J = 25^\circ\text{C}$ unless otherwise noted)

Rating	Symbol	Value	Unit
Drain-to-Source Voltage	V_{DSS}	30	Vdc
Gate-to-Source Voltage — Continuous	V_{GS}	± 20	Vdc
Drain Current — Continuous @ $T_A = 25^\circ\text{C}$ — Pulsed Drain Current ($t_p \leq 10 \mu\text{s}$)	I_D I_{DM}	1.75 20	A
Total Power Dissipation @ $T_A = 25^\circ\text{C}$	P_D	950	mW
Operating and Storage Temperature Range	T_J, T_{stg}	-55 to 150	$^\circ\text{C}$
Thermal Resistance — Junction-to-Ambient	$R_{\theta JA}$	250	$^\circ\text{C}/\text{W}$
Maximum Lead Temperature for Soldering Purposes, for 10 seconds	T_L	260	$^\circ\text{C}$

Device Marking = 3G

ORDERING INFORMATION

Device	Reel Size	Tape Width	Quantity
MGSF3454XT1	7"	8 mm embossed tape	3000
MGSF3454XT3	13"	8 mm embossed tape	10,000

This document contains information on a product under development. Motorola reserves the right to change or discontinue this product without notice.

Preferred devices are Motorola recommended choices for future use and best overall value.

MGSF3454XT1

ELECTRICAL CHARACTERISTICS (T_A = 25°C unless otherwise noted)

Characteristic	Symbol	Min	Typ	Max	Unit
----------------	--------	-----	-----	-----	------

OFF CHARACTERISTICS

Drain-to-Source Breakdown Voltage (V _{GS} = 0 Vdc, I _D = 10 μA)	V _{(BR)DSS}	30	—	—	Vdc
Zero Gate Voltage Drain Current (V _{DS} = 30 Vdc, V _{GS} = 0 Vdc) (V _{DS} = 30 Vdc, V _{GS} = 0 Vdc, T _J = 70°C)	I _{DSS}	—	—	1.0 25	μAdc
Gate-Body Leakage Current (V _{GS} = ± 20 Vdc, V _{DS} = 0)	I _{GSS}	—	—	±100	nAdc

ON CHARACTERISTICS(1)

Gate Threshold Voltage (V _{DS} = V _{GS} , I _D = 250 μAdc)	V _{GS(th)}	1.0	—	—	Vdc
Static Drain-to-Source On-Resistance (V _{GS} = 10 Vdc, I _D = 1.75 A) (V _{GS} = 4.5 Vdc, I _D = 1.5 A)	r _{DS(on)}	—	0.05 0.07	0.065 0.095	Ohms

DYNAMIC CHARACTERISTICS

Input Capacitance	(V _{DS} = 5.0 V)	C _{iss}	—	345	—	pF
Output Capacitance	(V _{DS} = 5.0 V)	C _{oss}	—	215	—	
Transfer Capacitance	(V _{DG} = 5.0 V)	C _{rss}	—	140	—	

SWITCHING CHARACTERISTICS(2)

Turn-On Delay Time	(V _{DD} = 10 Vdc, I _D = 1.0 A, V _{GEN} = 10 V, R _L = 10 Ω)	t _{d(on)}	—	10	—	ns
Rise Time		t _r	—	15	—	
Turn-Off Delay Time		t _{d(off)}	—	20	—	
Fall Time		t _f	—	10	—	
Gate Charge		Q _T	—	—	15	nC

SOURCE-DRAIN DIODE CHARACTERISTICS

Continuous Current	I _S	—	—	1.0	A
Pulsed Current	I _{SM}	—	—	5.0	A
Forward Voltage(2)	V _{SD}	—	—	1.2	V

(1) Pulse Test: Pulse Width ≤ 300 μs, Duty Cycle ≤ 2%.

(2) Switching characteristics are independent of operating junction temperature.

TYPICAL ELECTRICAL CHARACTERISTICS

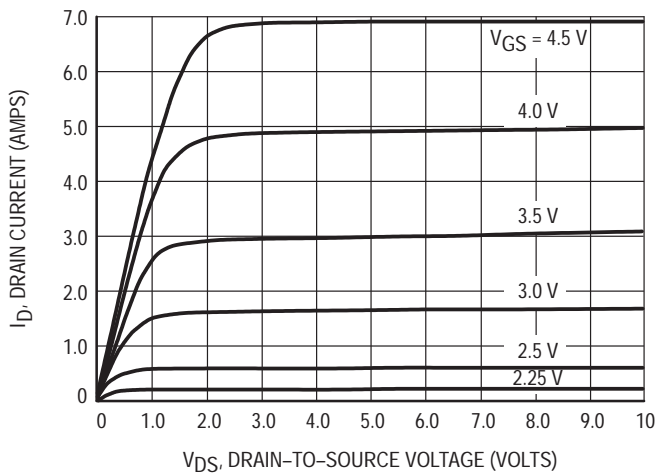


Figure 1. Output Characteristics

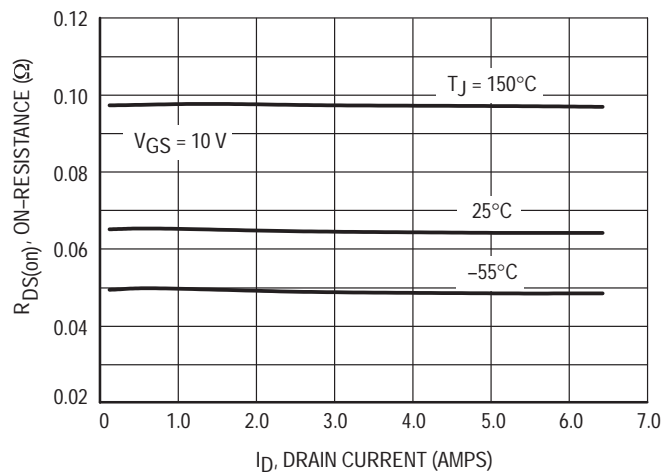


Figure 2. On-Resistance versus Drain Current

TYPICAL ELECTRICAL CHARACTERISTICS

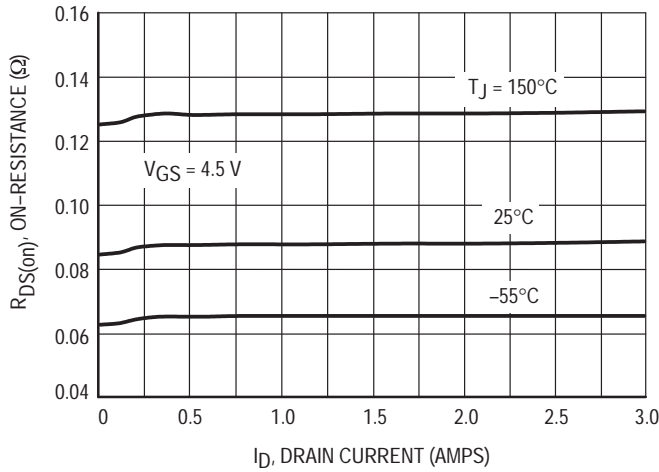


Figure 3. On-Resistance versus Drain Current

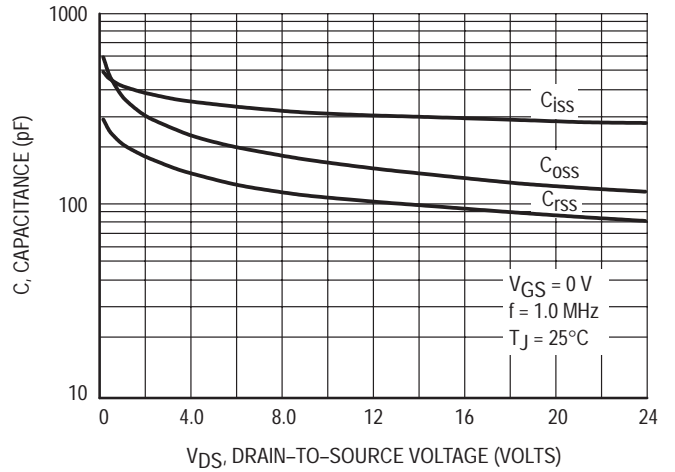


Figure 4. Capacitance

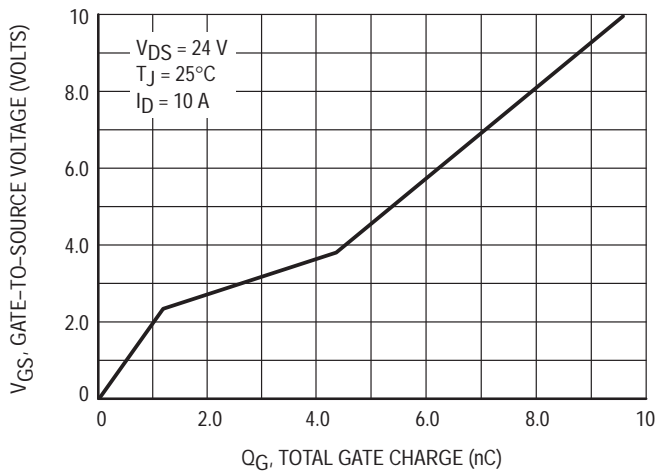


Figure 5. Gate Charge

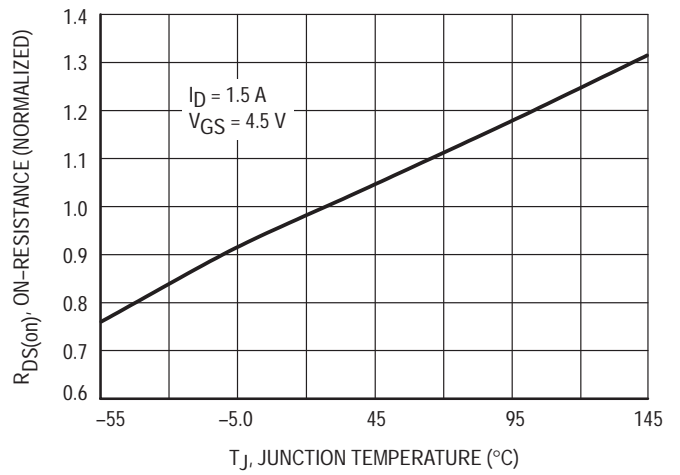


Figure 6. On-Resistance versus Junction Temperature

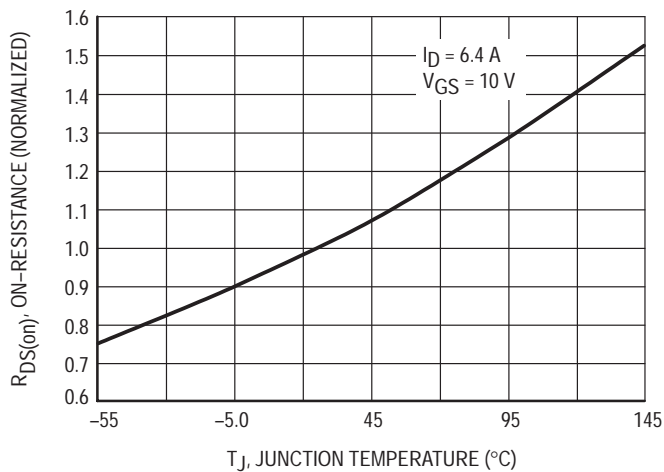


Figure 7. On-Resistance versus Junction Temperature

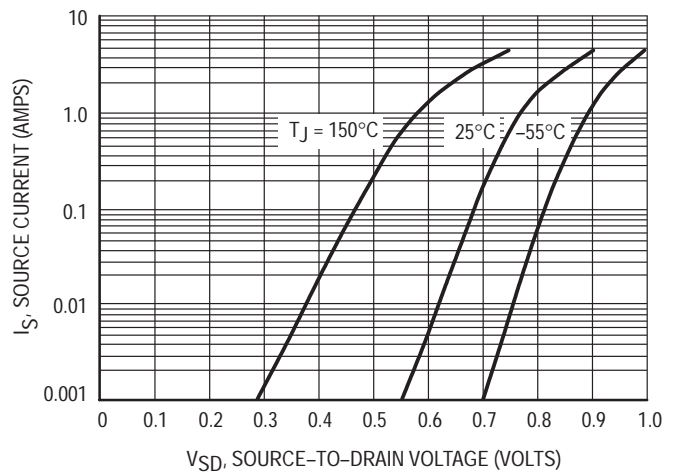


Figure 8. Source-Drain Diode Forward Voltage

TYPICAL ELECTRICAL CHARACTERISTICS

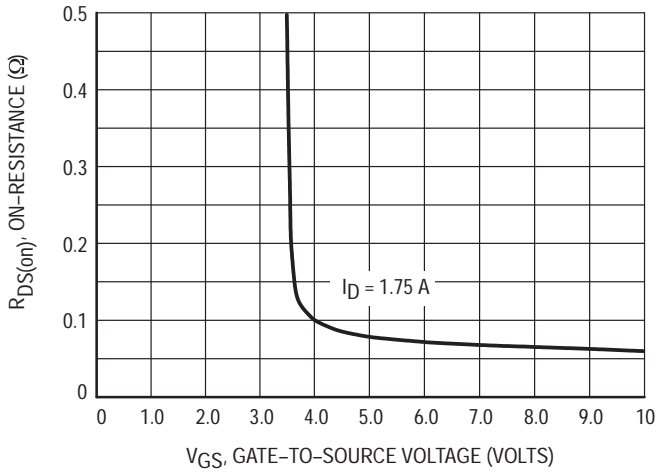


Figure 9. On-Resistance versus Gate-to-Source Voltage

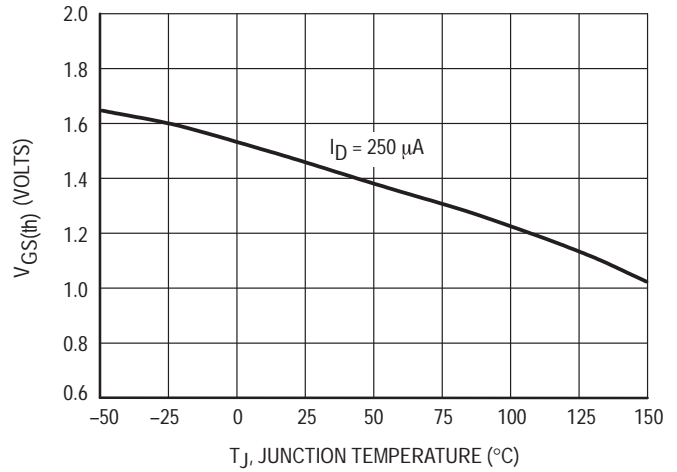


Figure 10. Threshold Voltage

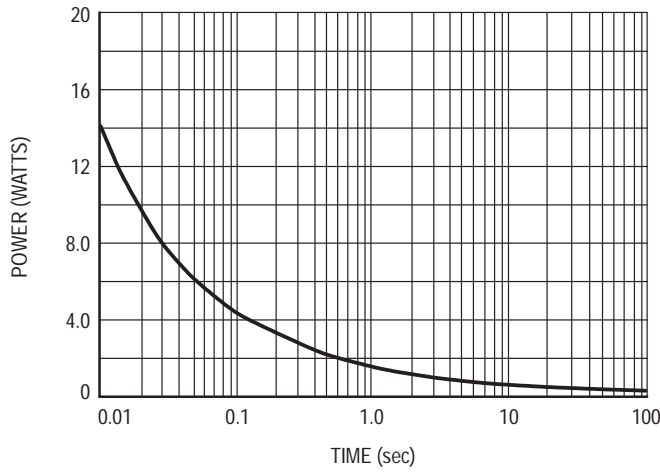


Figure 11. Single Pulse Power

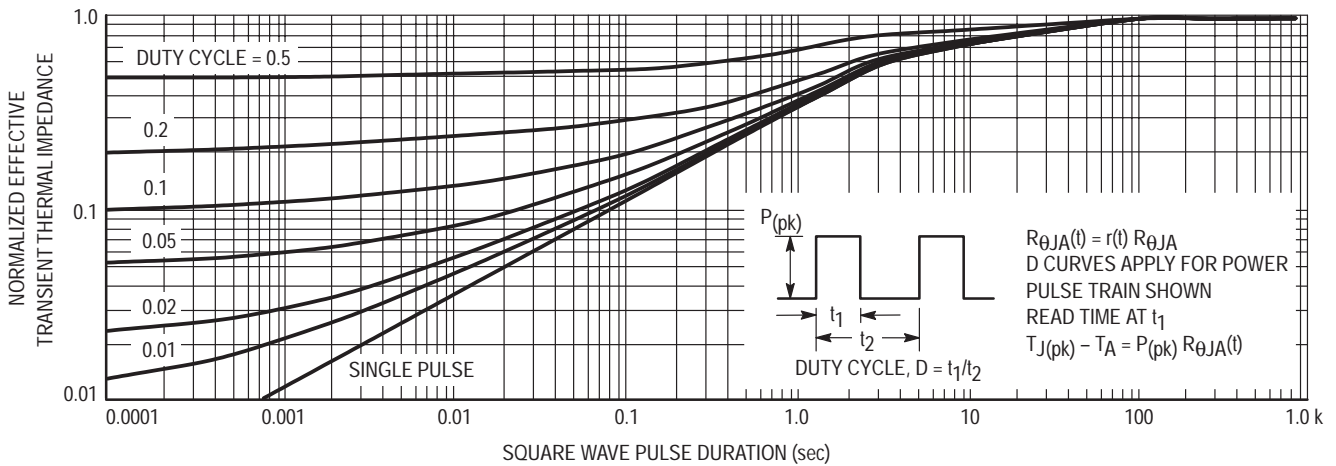


Figure 12. Normalized Thermal Transient Impedance, Junction-to-Ambient



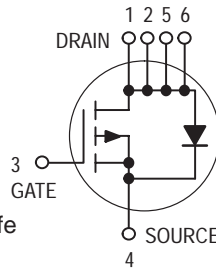
Preliminary Information

Low $r_{DS(on)}$ Small-Signal MOSFETs TMOS Single P-Channel Field Effect Transistors

Part of the GreenLine™ Portfolio of devices with energy-conserving traits.

These miniature surface mount MOSFETs utilize Motorola's High Cell Density, HDTMOS process. Low $r_{DS(on)}$ assures minimal power loss and conserves energy, making this device ideal for use in small power management circuitry. Typical applications are dc-dc converters, power management in portable and battery-powered products such as computers, printers, PCMCIA cards, cellular and cordless telephones.

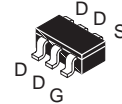
- Low $r_{DS(on)}$ Provides Higher Efficiency and Extends Battery Life
- Miniature TSOP 6 Surface Mount Package Saves Board Space
- Visit our Web Site at <http://www.mot-sps.com/ospd>



MGSF3455VT1

Motorola Preferred Device

P-CHANNEL
ENHANCEMENT-MODE
TMOS MOSFET
 $r_{DS(on)} = 80 \text{ m}\Omega$ (TYP)



CASE 318G-02, Style 1
TSOP 6 PLASTIC

MAXIMUM RATINGS ($T_J = 25^\circ\text{C}$ unless otherwise noted)

Rating	Symbol	Value	Unit
Drain-to-Source Voltage	V_{DSS}	30	Vdc
Gate-to-Source Voltage — Continuous	V_{GS}	± 20	Vdc
Drain Current — Continuous @ $T_A = 25^\circ\text{C}$ — Pulsed Drain Current ($t_p \leq 10 \mu\text{s}$)	I_D I_{DM}	3.5 20	A
Total Power Dissipation @ $T_A = 25^\circ\text{C}$ Mounted on FR4 $t \leq 5 \text{ sec}$	P_D	2.0	W
Operating and Storage Temperature Range	T_J, T_{stg}	-55 to 150	$^\circ\text{C}$
Thermal Resistance — Junction-to-Ambient	$R_{\theta JA}$	62.5	$^\circ\text{C/W}$
Maximum Lead Temperature for Soldering Purposes, for 10 seconds	T_L	260	$^\circ\text{C}$

ORDERING INFORMATION

Device	Reel Size	Tape Width	Quantity
MGSF3455VT1	7"	8 mm embossed tape	3000
MGSF3455VT3	13"	8 mm embossed tape	10,000

This document contains information on a product under development. Motorola reserves the right to change or discontinue this product without notice.

Preferred devices are Motorola recommended choices for future use and best overall value.

MGSF3455VT1

ELECTRICAL CHARACTERISTICS (T_A = 25°C unless otherwise noted)

Characteristic	Symbol	Min	Typ	Max	Unit
----------------	--------	-----	-----	-----	------

OFF CHARACTERISTICS

Drain-to-Source Breakdown Voltage (V _{GS} = 0 Vdc, I _D = 10 μA)	V _{(BR)DSS}	30	—	—	Vdc
Zero Gate Voltage Drain Current (V _{DS} = 30 Vdc, V _{GS} = 0 Vdc) (V _{DS} = 30 Vdc, V _{GS} = 0 Vdc, T _J = 70°C)	I _{DSS}	—	—	1.0 5.0	μAdc
Gate-Body Leakage Current (V _{GS} = ± 20 Vdc, V _{DS} = 0)	I _{GSS}	—	—	±100	nAdc

ON CHARACTERISTICS(1)

Gate Threshold Voltage (V _{DS} = V _{GS} , I _D = 250 μAdc)	V _{GS(th)}	1.0	—	—	Vdc
Static Drain-to-Source On-Resistance (V _{GS} = 10 Vdc, I _D = 3.5 A) (V _{GS} = 4.5 Vdc, I _D = 2.5 A)	r _{DS(on)}	—	0.080 0.134	0.100 0.190	Ohms

DYNAMIC CHARACTERISTICS

Input Capacitance	(V _{DS} = 5.0 V)	C _{iss}	—	90	—	pF
Output Capacitance	(V _{DS} = 5.0 V)	C _{oss}	—	50	—	
Transfer Capacitance	(V _{DG} = 5.0 V)	C _{rss}	—	10	—	

SWITCHING CHARACTERISTICS(2)

Turn-On Delay Time	(V _{DD} = 15 Vdc, I _D = 1.0 A, V _{GEN} = 10 V, R _L = 10 Ω)	t _{d(on)}	—	10	20	ns
Rise Time		t _r	—	15	30	
Turn-Off Delay Time		t _{d(off)}	—	20	35	
Fall Time		t _f	—	10	20	
Gate Charge		Q _T	—	3000	—	pC

SOURCE-DRAIN DIODE CHARACTERISTICS

Continuous Current	I _S	—	—	1.0	A
Pulsed Current	I _{SM}	—	—	5.0	A
Forward Voltage(2)	V _{SD}	—	—	1.2	V

(1) Pulse Test: Pulse Width ≤ 300 μs, Duty Cycle ≤ 2%.

(2) Switching characteristics are independent of operating junction temperature.

TYPICAL ELECTRICAL CHARACTERISTICS

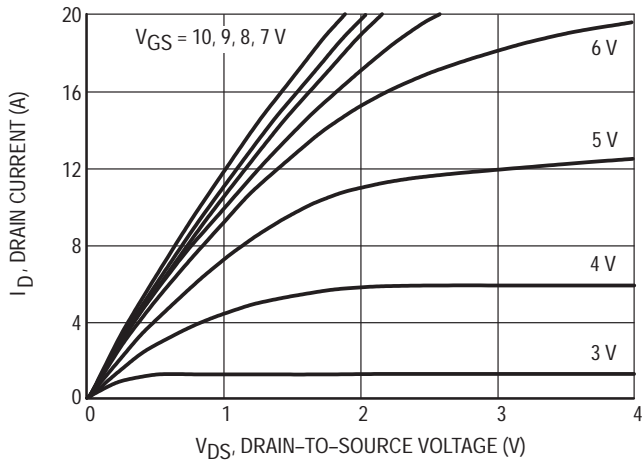


Figure 1. Output Characteristics

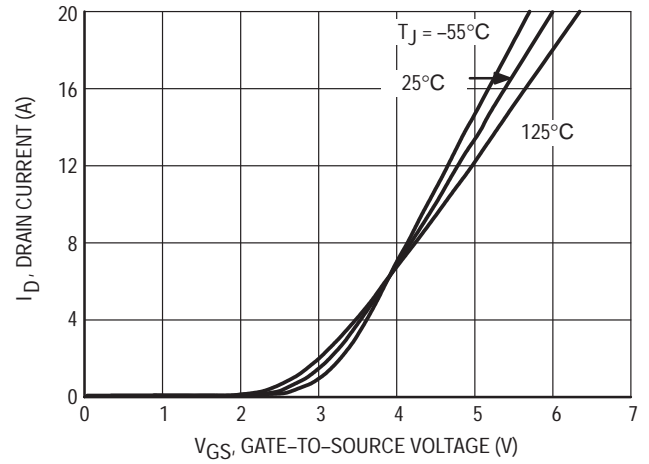


Figure 2. Transfer Characteristics

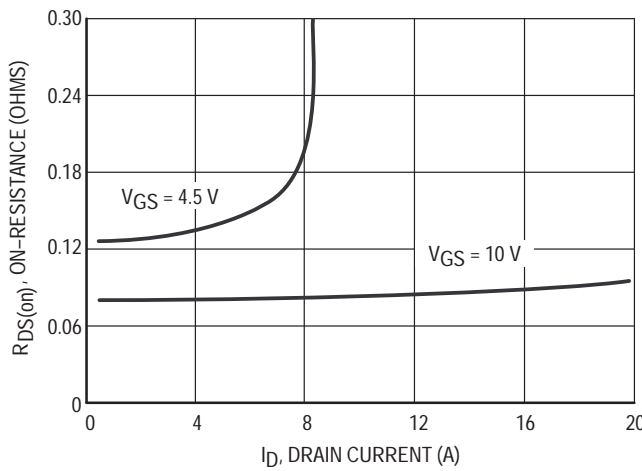


Figure 3. On-Resistance vs. Drain Current

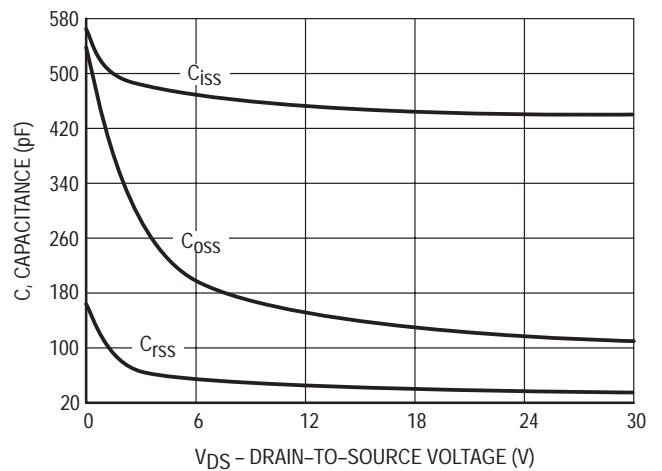


Figure 4. Capacitance

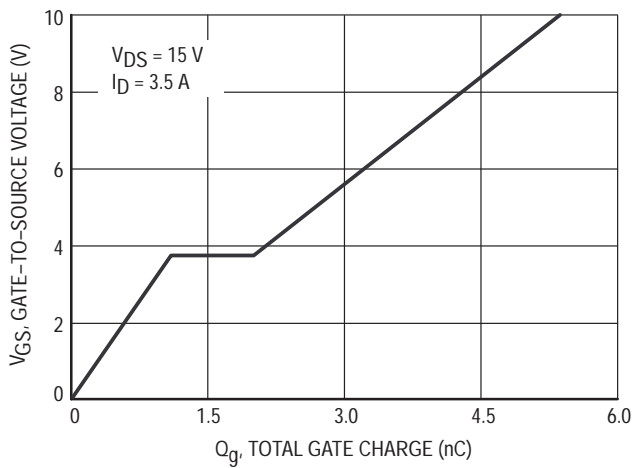


Figure 5. Gate Charge

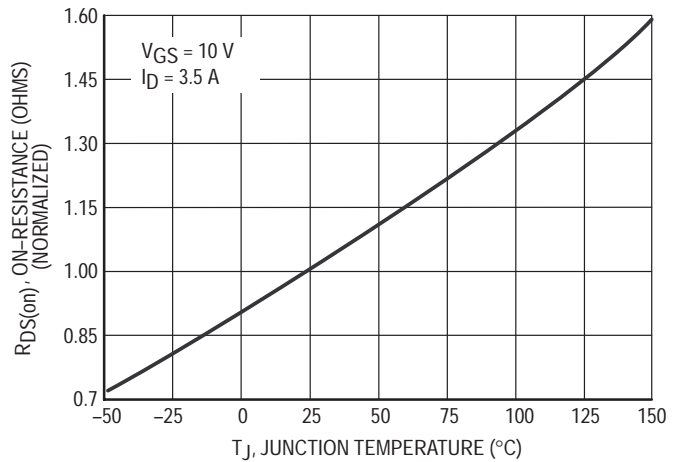


Figure 6. On-Resistance vs. Junction Temperature

TYPICAL ELECTRICAL CHARACTERISTICS

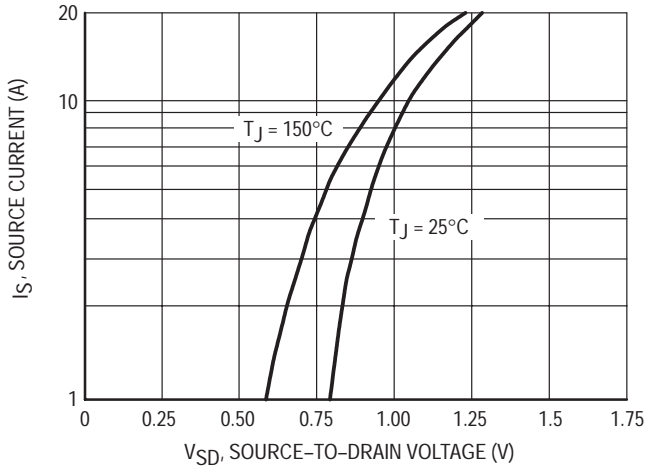


Figure 7. Source-Drain Diode Forward Voltage

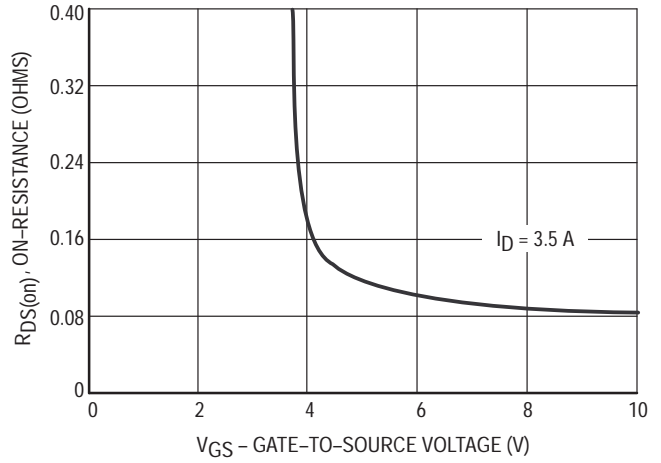


Figure 8. On-Resistance vs. Gate-to-Source Voltage

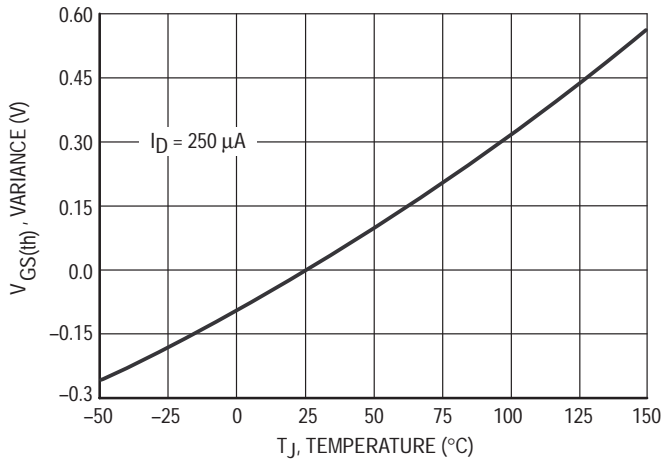


Figure 9. Threshold Voltage

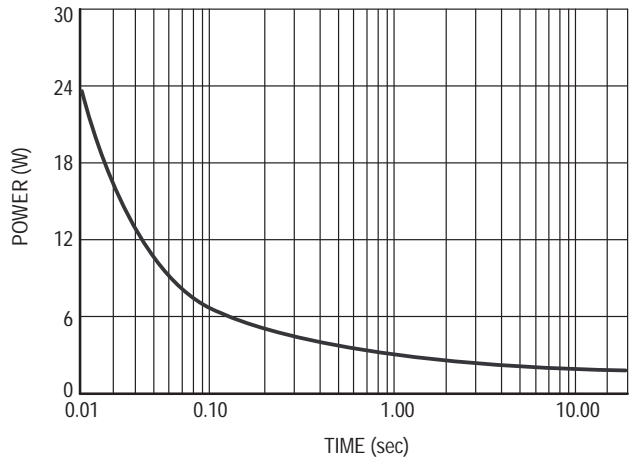


Figure 10. Single Pulse Power

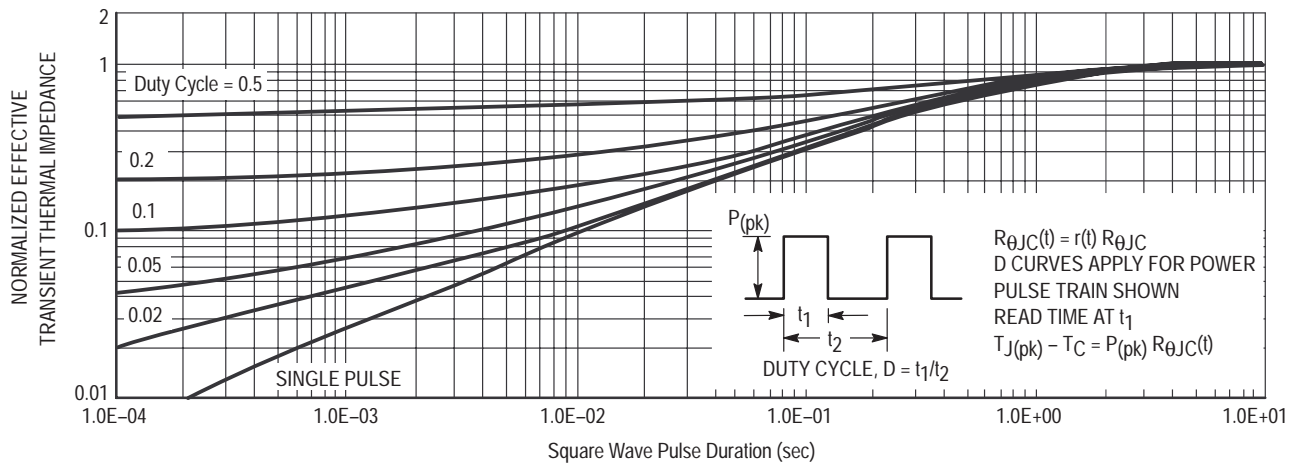


Figure 11. Normalized Thermal Transient Impedance, Junction-to-Ambient



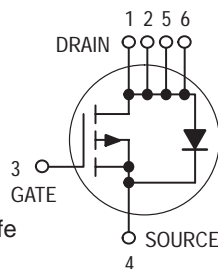
Preliminary Information

Low $r_{DS(on)}$ Small-Signal MOSFETs TMOS Single P-Channel Field Effect Transistors

Part of the GreenLine™ Portfolio of devices with energy-conserving traits.

These miniature surface mount MOSFETs utilize Motorola's High Cell Density, HDTMOS process. Low $r_{DS(on)}$ assures minimal power loss and conserves energy, making this device ideal for use in small power management circuitry. Typical applications are dc-dc converters, power management in portable and battery-powered products such as computers, printers, PCMCIA cards, cellular and cordless telephones.

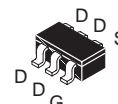
- Low $r_{DS(on)}$ Provides Higher Efficiency and Extends Battery Life
- Miniature TSOP 6 Surface Mount Package Saves Board Space
- Visit our Web Site at <http://www.mot-sps.com/ospd>



MGSF3455XT1

Motorola Preferred Device

P-CHANNEL
ENHANCEMENT-MODE
TMOS MOSFET
 $r_{DS(on)} = 80 \text{ m}\Omega$ (TYP)



CASE 318G-02, Style 1
TSOP 6 PLASTIC

MAXIMUM RATINGS ($T_J = 25^\circ\text{C}$ unless otherwise noted)

Rating	Symbol	Value	Unit
Drain-to-Source Voltage	V_{DSS}	30	Vdc
Gate-to-Source Voltage — Continuous	V_{GS}	± 20	Vdc
Drain Current — Continuous @ $T_A = 25^\circ\text{C}$ — Pulsed Drain Current ($t_p \leq 10 \mu\text{s}$)	I_D I_{DM}	1.45 10	A
Total Power Dissipation @ $T_A = 25^\circ\text{C}$	P_D	400	mW
Operating and Storage Temperature Range	T_J, T_{stg}	-55 to 150	$^\circ\text{C}$
Thermal Resistance — Junction-to-Ambient	$R_{\theta JA}$	300	$^\circ\text{C}/\text{W}$
Maximum Lead Temperature for Soldering Purposes, for 10 seconds	T_L	260	$^\circ\text{C}$

ORDERING INFORMATION

Device	Reel Size	Tape Width	Quantity
MGSF3455XT1	7"	8 mm embossed tape	3000
MGSF3455XT3	13"	8 mm embossed tape	10,000

This document contains information on a product under development. Motorola reserves the right to change or discontinue this product without notice.

Preferred devices are Motorola recommended choices for future use and best overall value.

MGSF3455XT1

ELECTRICAL CHARACTERISTICS (T_A = 25°C unless otherwise noted)

Characteristic	Symbol	Min	Typ	Max	Unit
----------------	--------	-----	-----	-----	------

OFF CHARACTERISTICS

Drain-to-Source Breakdown Voltage (V _{GS} = 0 Vdc, I _D = 10 μA)	V _{(BR)DSS}	30	—	—	Vdc
Zero Gate Voltage Drain Current (V _{DS} = 30 Vdc, V _{GS} = 0 Vdc) (V _{DS} = 30 Vdc, V _{GS} = 0 Vdc, T _J = 70°C)	I _{DSS}	—	—	1.0 5.0	μAdc
Gate-Body Leakage Current (V _{GS} = ± 20 Vdc, V _{DS} = 0)	I _{GSS}	—	—	±100	nAdc

ON CHARACTERISTICS(1)

Gate Threshold Voltage (V _{DS} = V _{GS} , I _D = 250 μAdc)	V _{GS(th)}	1.0	—	—	Vdc
Static Drain-to-Source On-Resistance (V _{GS} = 10 Vdc, I _D = 1.45 A) (V _{GS} = 4.5 Vdc, I _D = 1.2 A)	r _{DS(on)}	—	0.080 0.134	0.100 0.190	Ohms

DYNAMIC CHARACTERISTICS

Input Capacitance	(V _{DS} = 5.0 V)	C _{iss}	—	90	—	pF
Output Capacitance	(V _{DS} = 5.0 V)	C _{oss}	—	50	—	
Transfer Capacitance	(V _{DG} = 5.0 V)	C _{rss}	—	10	—	

SWITCHING CHARACTERISTICS(2)

Turn-On Delay Time	(V _{DD} = 15 Vdc, I _D = 1.0 A, V _{GEN} = 10 V, R _L = 10 Ω)	t _{d(on)}	—	10	20	ns
Rise Time		t _r	—	15	30	
Turn-Off Delay Time		t _{d(off)}	—	20	35	
Fall Time		t _f	—	10	20	
Gate Charge		Q _T	—	3000	—	pC

SOURCE-DRAIN DIODE CHARACTERISTICS

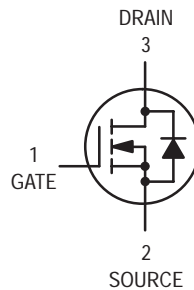
Continuous Current	I _S	—	—	1.0	A
Pulsed Current	I _{SM}	—	—	5.0	A
Forward Voltage(2)	V _{SD}	—	0.85	—	V

(1) Pulse Test: Pulse Width ≤ 300 μs, Duty Cycle ≤ 2%.

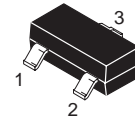
(2) Switching characteristics are independent of operating junction temperature.

TMOS FET Transistor

N-Channel



MMBF170LT1



CASE 318-08, STYLE 21
SOT-23 (TO-236AB)

MAXIMUM RATINGS

Rating	Symbol	Value	Unit
Drain-Source Voltage	V_{DSS}	60	Vdc
Drain-Gate Voltage	V_{DGS}	60	Vdc
Gate-Source Voltage	V_{GS} V_{GSM}	± 20	Vdc
— Continuous — Non-repetitive ($t_p \leq 50 \mu s$)		± 40	Vpk
Drain Current – Continuous	I_D I_{DM}	0.5	Adc
— Pulsed		0.8	

THERMAL CHARACTERISTICS

Characteristic	Symbol	Max	Unit
Total Device Dissipation FR-5 Board ⁽¹⁾ $T_A = 25^\circ C$ Derate above $25^\circ C$	P_D	225	mW
		1.8	mW/ $^\circ C$
Thermal Resistance, Junction to Ambient	$R_{\theta JA}$	556	$^\circ C/W$
Junction and Storage Temperature	T_J, T_{stg}	-55 to +150	$^\circ C$

DEVICE MARKING

MMBF170LT1 = 6Z

ELECTRICAL CHARACTERISTICS ($T_C = 25^\circ C$ unless otherwise noted)

Characteristic	Symbol	Min	Max	Unit
----------------	--------	-----	-----	------

OFF CHARACTERISTICS

Drain-Source Breakdown Voltage ($V_{GS} = 0, I_D = 100 \mu A$)	$V_{(BR)DSS}$	60	—	Vdc
Gate-Body Leakage Current, Forward ($V_{GSF} = 15 Vdc, V_{DS} = 0$)	I_{GSS}	—	10	nAdc

ON CHARACTERISTICS (2)

Gate Threshold Voltage ($V_{DS} = V_{GS}, I_D = 1.0 mA$)	$V_{GS(th)}$	0.8	3.0	Vdc
Static Drain-Source On-Resistance ($V_{GS} = 10 Vdc, I_D = 200 mA$)	$r_{DS(on)}$	—	5.0	Ω
On-State Drain Current ($V_{DS} = 25 Vdc, V_{GS} = 0$)	$I_{D(off)}$	—	0.5	μA

DYNAMIC CHARACTERISTICS

Input Capacitance ($V_{DS} = 10 Vdc, V_{GS} = 0 V, f = 1.0 MHz$)	C_{iss}	—	60	pF
-----------------------------------------------------------------------	-----------	---	----	----

SWITCHING CHARACTERISTICS (2)

Turn-On Delay Time	($V_{DD} = 25 Vdc, I_D = 500 mA, R_{gen} = 50 \Omega$) Figure 1	$t_{d(on)}$	—	10	ns
Turn-Off Delay Time		$t_{d(off)}$	—	10	

1. FR-5 = $1.0 \times 0.75 \times 0.062$ in.

2. Pulse Test: Pulse Width $\leq 300 \mu s$, Duty Cycle $\leq 2.0\%$.

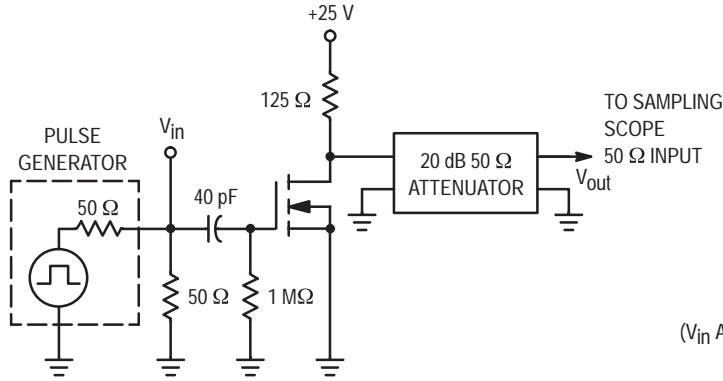


Figure 1. Switching Test Circuit

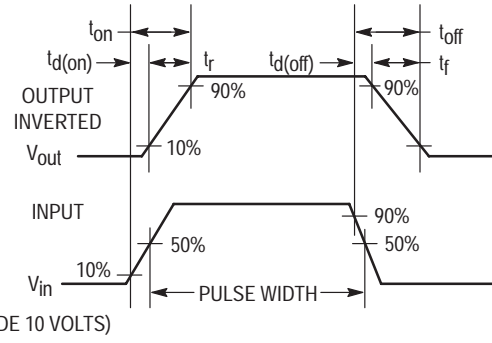


Figure 2. Switching Waveform

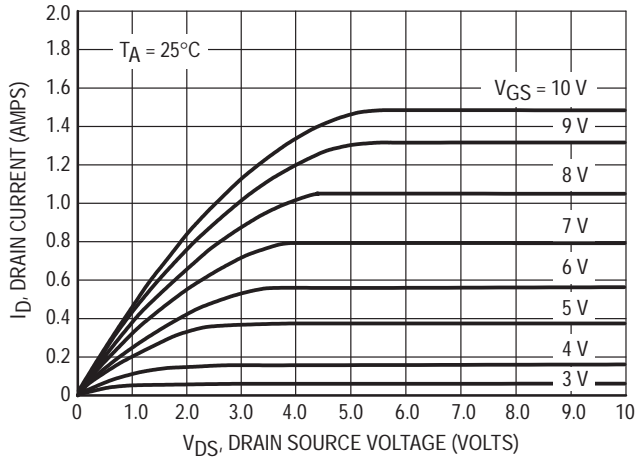


Figure 3. Ohmic Region

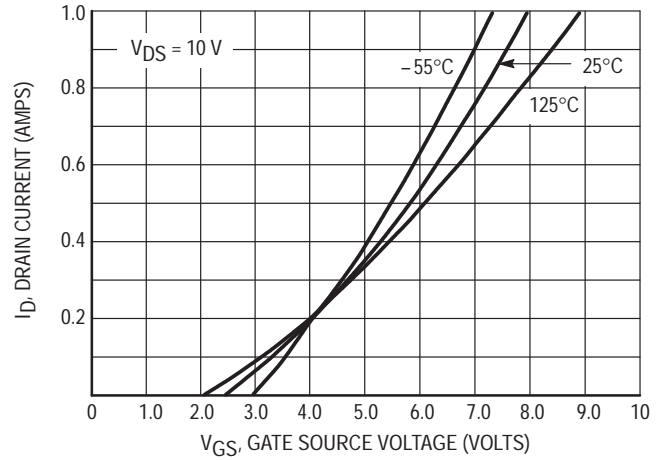


Figure 4. Transfer Characteristics

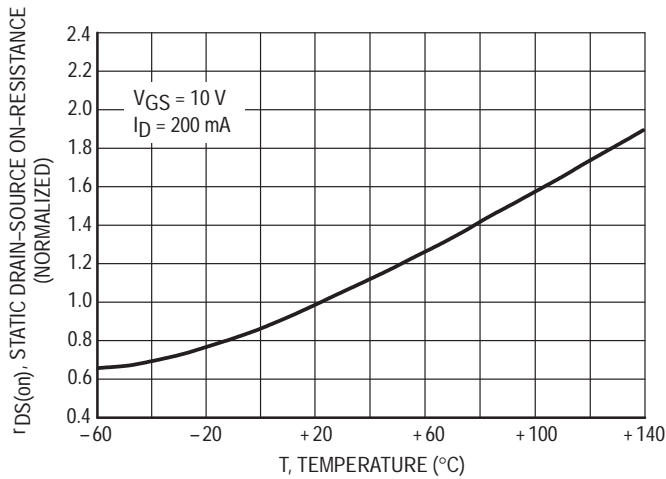


Figure 5. Temperature versus Static Drain-Source On-Resistance

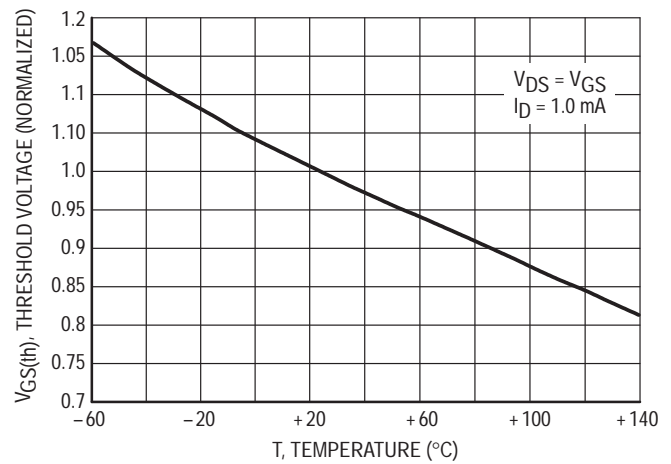


Figure 6. Temperature versus Gate Threshold Voltage



Low $r_{DS(on)}$ Small-Signal MOSFETs

TMOS Single N-Channel Field Effect Transistors

Part of the GreenLine™ Portfolio of devices with energy-conserving traits.

These miniature surface mount MOSFETs utilize Motorola's High Cell Density, HDTMOS process. Low $r_{DS(on)}$ assures minimal power loss and conserves energy, making this device ideal for use in small power management circuitry. Typical applications are dc-dc converters, power management in portable and battery-powered products such as computers, printers, PCMCIA cards, cellular and cordless telephones.

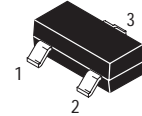
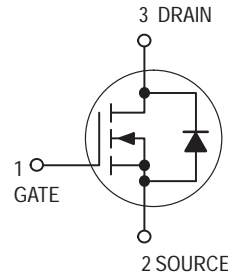
- Low $r_{DS(on)}$ Provides Higher Efficiency and Extends Battery Life
- Miniature SOT-23 Surface Mount Package Saves Board Space

MMBF0201NLT1

Motorola Preferred Device



**N-CHANNEL
ENHANCEMENT-MODE
TMOS MOSFET**
 $r_{DS(on)} = 1.0 \text{ OHM}$



CASE 318-08, Style 21
SOT-23 (TO-236AB)

MAXIMUM RATINGS ($T_J = 25^\circ\text{C}$ unless otherwise noted)

Rating	Symbol	Value	Unit
Drain-to-Source Voltage	V_{DSS}	20	Vdc
Gate-to-Source Voltage — Continuous	V_{GS}	± 20	Vdc
Drain Current — Continuous @ $T_A = 25^\circ\text{C}$ — Continuous @ $T_A = 70^\circ\text{C}$ — Pulsed Drain Current ($t_p \leq 10 \mu\text{s}$)	I_D I_D I_{DM}	300 240 750	mAdc
Total Power Dissipation @ $T_A = 25^\circ\text{C}^{(1)}$	P_D	225	mW
Operating and Storage Temperature Range	T_J, T_{stg}	-55 to 150	$^\circ\text{C}$
Thermal Resistance — Junction-to-Ambient	$R_{\theta JA}$	556	$^\circ\text{C/W}$
Maximum Lead Temperature for Soldering Purposes, 1/8" from case for 10 seconds	T_L	260	$^\circ\text{C}$

DEVICE MARKING

N1

(1) Mounted on G10/FR4 glass epoxy board using minimum recommended footprint.

ORDERING INFORMATION

Device	Reel Size	Tape Width	Quantity
MMBF0201NLT1	7"	12 mm embossed tape	3000
MMBF0201NLT3	13"	12 mm embossed tape	10,000

Preferred devices are Motorola recommended choices for future use and best overall value.

MMBF0201NLT1

ELECTRICAL CHARACTERISTICS (T_A = 25°C unless otherwise noted)

Characteristic	Symbol	Min	Typ	Max	Unit
----------------	--------	-----	-----	-----	------

OFF CHARACTERISTICS

Drain-to-Source Breakdown Voltage (V _{GS} = 0 Vdc, I _D = 10 μA)	V _{(BR)DSS}	20	—	—	Vdc
Zero Gate Voltage Drain Current (V _{DS} = 16 Vdc, V _{GS} = 0 Vdc) (V _{DS} = 16 Vdc, V _{GS} = 0 Vdc, T _J = 125°C)	I _{DSS}	—	—	1.0 10	μAdc
Gate-Body Leakage Current (V _{GS} = ± 20 Vdc, V _{DS} = 0)	I _{GSS}	—	—	±100	nAdc

ON CHARACTERISTICS(1)

Gate Threshold Voltage (V _{DS} = V _{GS} , I _D = 250 μAdc)	V _{GS(th)}	1.0	1.7	2.4	Vdc
Static Drain-to-Source On-Resistance (V _{GS} = 10 Vdc, I _D = 300 mAdc) (V _{GS} = 4.5 Vdc, I _D = 100 mAdc)	r _{DS(on)}	—	0.75 1.0	1.0 1.4	Ohms
Forward Transconductance (V _{DS} = 10 Vdc, I _D = 200 mAdc)	g _{FS}	—	450	—	mMhos

DYNAMIC CHARACTERISTICS

Input Capacitance	(V _{DS} = 5.0 V)	C _{iss}	—	45	—	pF
Output Capacitance	(V _{DS} = 5.0 V)	C _{oss}	—	25	—	
Transfer Capacitance	(V _{DG} = 5.0 V)	C _{rss}	—	5.0	—	

SWITCHING CHARACTERISTICS(2)

Turn-On Delay Time	(V _{DD} = 15 Vdc, I _D = 300 mAdc, R _L = 50 Ω)	t _{d(on)}	—	2.5	—	ns
Rise Time		t _r	—	2.5	—	
Turn-Off Delay Time		t _{d(off)}	—	15	—	
Fall Time		t _f	—	0.8	—	
Gate Charge (See Figure 5)		Q _T	—	1400	—	pC

SOURCE-DRAIN DIODE CHARACTERISTICS

Continuous Current	I _S	—	—	0.3	A
Pulsed Current	I _{SM}	—	—	0.75	
Forward Voltage(2)	V _{SD}	—	0.85	—	V

(1) Pulse Test: Pulse Width ≤ 300 μs, Duty Cycle ≤ 2%.

(2) Switching characteristics are independent of operating junction temperature.

TYPICAL ELECTRICAL CHARACTERISTICS

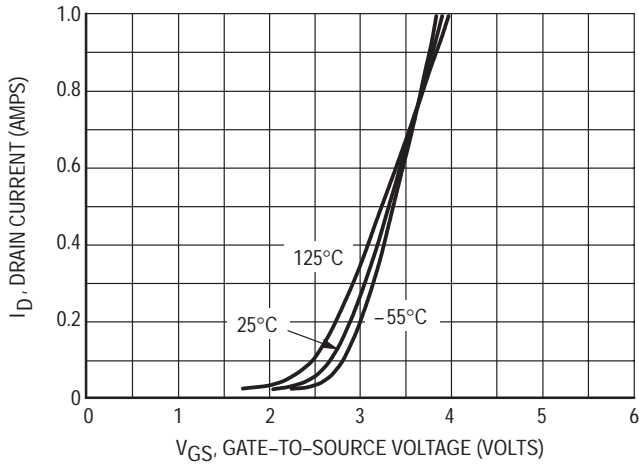


Figure 1. Transfer Characteristics

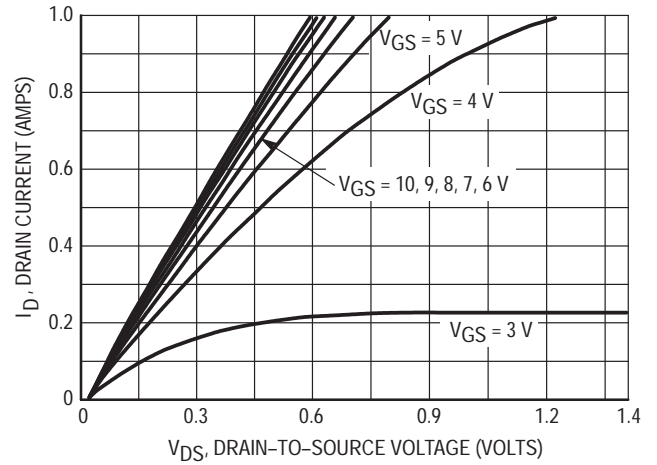


Figure 2. On-Region Characteristics

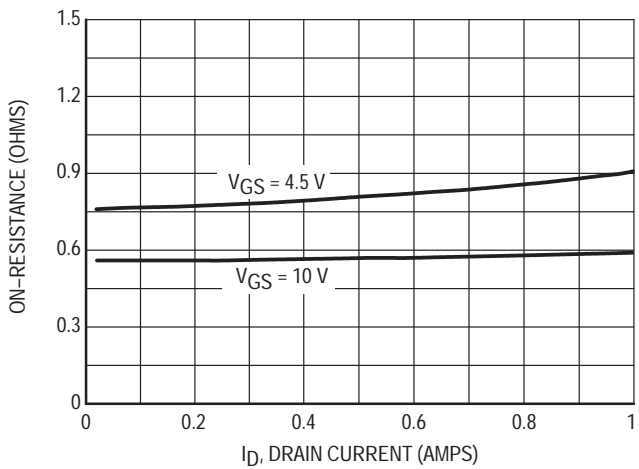


Figure 3. On-Resistance versus Drain Current

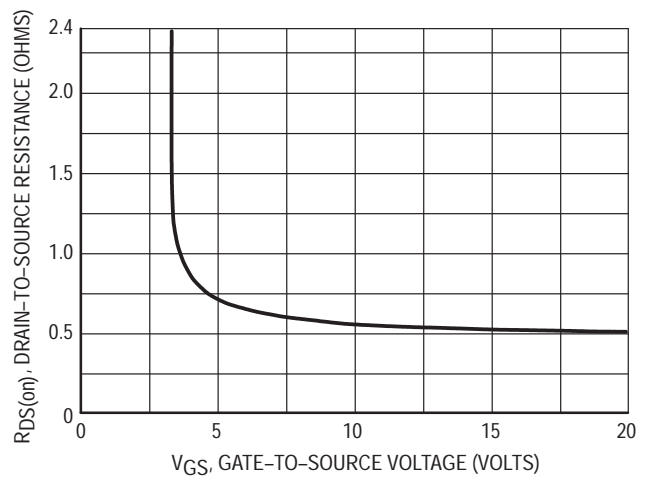


Figure 4. On-Resistance versus Gate-to-Source Voltage

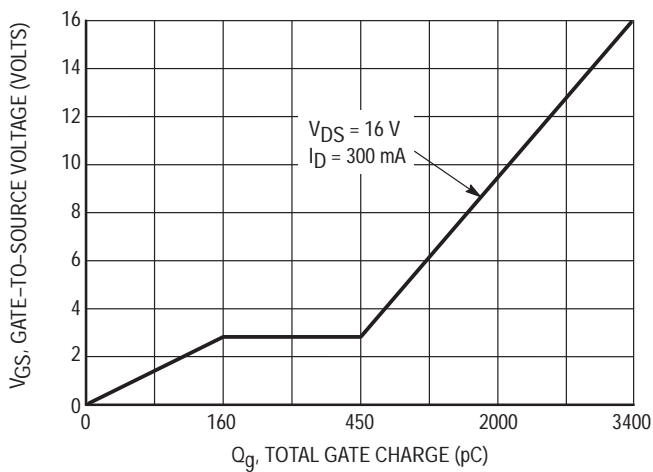


Figure 5. Gate Charge

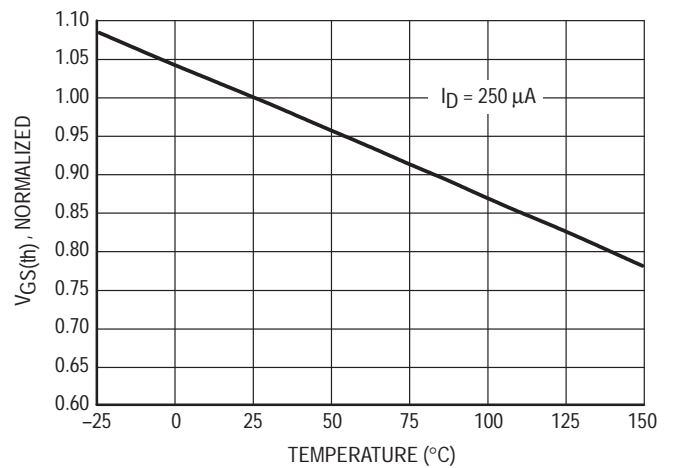


Figure 6. Threshold Voltage Variance Over Temperature

TYPICAL ELECTRICAL CHARACTERISTICS

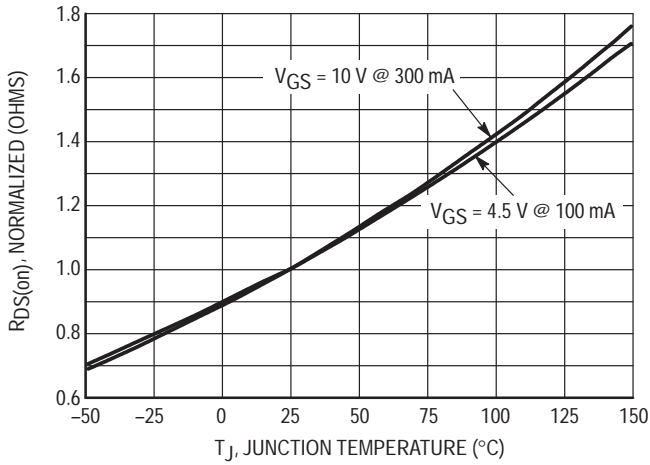


Figure 7. On-Resistance versus Junction Temperature

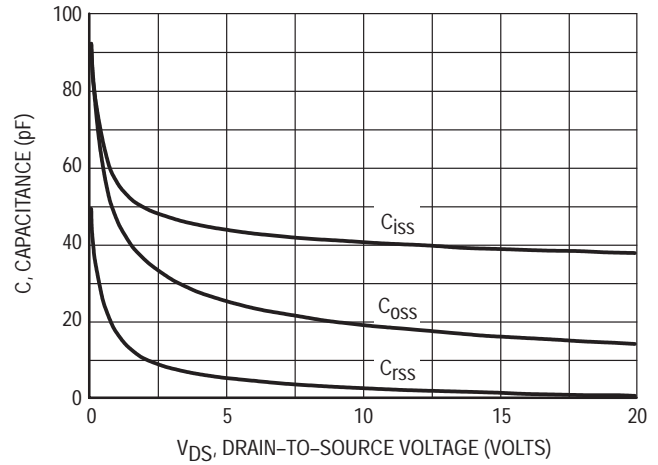


Figure 8. Capacitance

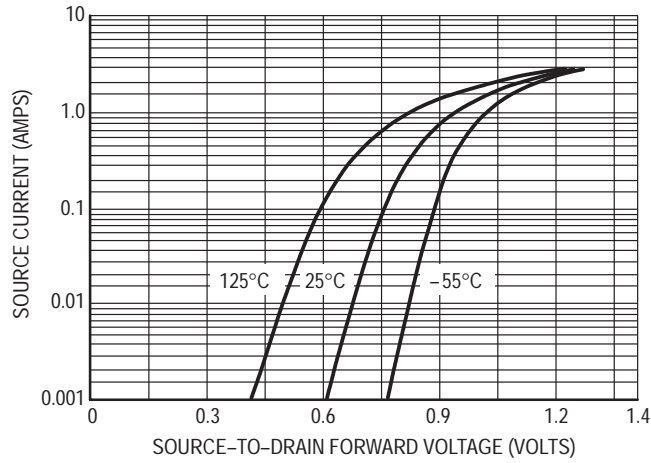


Figure 9. Source-to-Drain Forward Voltage versus Continuous Current (I_S)

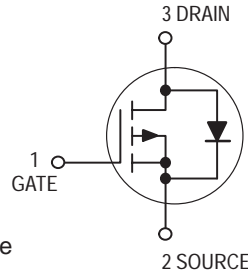


Low $r_{DS(on)}$ Small-Signal MOSFETs TMOS Single P-Channel Field Effect Transistors

Part of the GreenLine™ Portfolio of devices with energy-conserving traits.

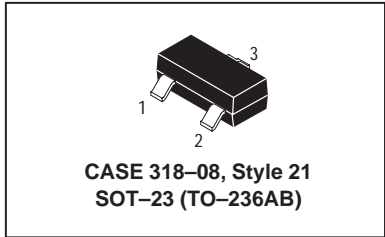
These miniature surface mount MOSFETs utilize Motorola's High Cell Density, HDTMOS process. Low $r_{DS(on)}$ assures minimal power loss and conserves energy, making this device ideal for use in small power management circuitry. Typical applications are dc-dc converters, power management in portable and battery-powered products such as computers, printers, PCMCIA cards, cellular and cordless telephones.

- Low $r_{DS(on)}$ Provides Higher Efficiency and Extends Battery Life
- Miniature SOT-23 Surface Mount Package Saves Board Space



MMBF0202PLT1
Motorola Preferred Device

**P-CHANNEL
ENHANCEMENT-MODE
TMOS MOSFET**
 $r_{DS(on)} = 1.4 \text{ OHM}$



MAXIMUM RATINGS ($T_J = 25^\circ\text{C}$ unless otherwise noted)

Rating	Symbol	Value	Unit
Drain-to-Source Voltage	V_{DSS}	20	Vdc
Gate-to-Source Voltage — Continuous	V_{GS}	± 20	Vdc
Drain Current — Continuous @ $T_A = 25^\circ\text{C}$ — Continuous @ $T_A = 70^\circ\text{C}$ — Pulsed Drain Current ($t_p \leq 10 \mu\text{s}$)	I_D I_D I_{DM}	300 240 750	mAdc
Total Power Dissipation @ $T_A = 25^\circ\text{C}$ (1)	P_D	225	mW
Operating and Storage Temperature Range	T_J, T_{stg}	-55 to 150	$^\circ\text{C}$
Thermal Resistance — Junction-to-Ambient	$R_{\theta JA}$	625	$^\circ\text{C/W}$
Maximum Lead Temperature for Soldering Purposes, 1/8" from case for 10 seconds	T_L	260	$^\circ\text{C}$

DEVICE MARKING

P3

(1) Mounted on G10/FR4 glass epoxy board using minimum recommended footprint.

ORDERING INFORMATION

Device	Reel Size	Tape Width	Quantity
MMBF0202PLT1	7"	12 mm embossed tape	3000
MMBF0202PLT3	13"	12 mm embossed tape	10,000

Preferred devices are Motorola recommended choices for future use and best overall value.

(Replaces MMBF0202P/D)

MMBF0202PLT1

ELECTRICAL CHARACTERISTICS (T_A = 25°C unless otherwise noted)

Characteristic	Symbol	Min	Typ	Max	Unit
----------------	--------	-----	-----	-----	------

OFF CHARACTERISTICS

Drain-to-Source Breakdown Voltage (V _{GS} = 0 Vdc, I _D = 10 μA)	V _{(BR)DSS}	20	—	—	Vdc
Zero Gate Voltage Drain Current (V _{DS} = 16 Vdc, V _{GS} = 0 Vdc) (V _{DS} = 16 Vdc, V _{GS} = 0 Vdc, T _J = 125°C)	I _{DSS}	—	—	1.0 10	μAdc
Gate-Body Leakage Current (V _{GS} = ± 20 Vdc, V _{DS} = 0)	I _{GSS}	—	—	±100	nAdc

ON CHARACTERISTICS(1)

Gate Threshold Voltage (V _{DS} = V _{GS} , I _D = 250 μAdc)	V _{GS(th)}	1.0	1.7	2.4	Vdc
Static Drain-to-Source On-Resistance (V _{GS} = 10 Vdc, I _D = 200 mAdc) (V _{GS} = 4.5 Vdc, I _D = 50 mAdc)	r _{DS(on)}	—	0.9 2.0	1.4 3.5	Ohms
Forward Transconductance (V _{DS} = 10 Vdc, I _D = 200 mAdc)	g _{FS}	—	600	—	mMhos

DYNAMIC CHARACTERISTICS

Input Capacitance	(V _{DS} = 5.0 V)	C _{iss}	—	50	—	pF
Output Capacitance	(V _{DS} = 5.0 V)	C _{oss}	—	45	—	
Transfer Capacitance	(V _{DG} = 5.0 V)	C _{rss}	—	20	—	

SWITCHING CHARACTERISTICS(2)

Turn-On Delay Time	(V _{DD} = -15 Vdc, R _L = 75 Ω, I _D = 200 mAdc, V _{GEN} = -10 V, R _G = 6.0 Ω)	t _{d(on)}	—	2.5	—	ns
Rise Time		t _r	—	1.0	—	
Turn-Off Delay Time		t _{d(off)}	—	16	—	
Fall Time		t _f	—	8.0	—	
Gate Charge (See Figure 5)	(V _{DS} = 16 V, V _{GS} = 10 V, I _D = 200 mA)	Q _T	—	2700	—	pC

SOURCE-DRAIN DIODE CHARACTERISTICS

Continuous Current	I _S	—	—	0.3	A
Pulsed Current	I _{SM}	—	—	0.75	
Forward Voltage(2)	V _{SD}	—	1.5	—	V

(1) Pulse Test: Pulse Width ≤ 300 μs, Duty Cycle ≤ 2%.

(2) Switching characteristics are independent of operating junction temperature.

TYPICAL ELECTRICAL CHARACTERISTICS

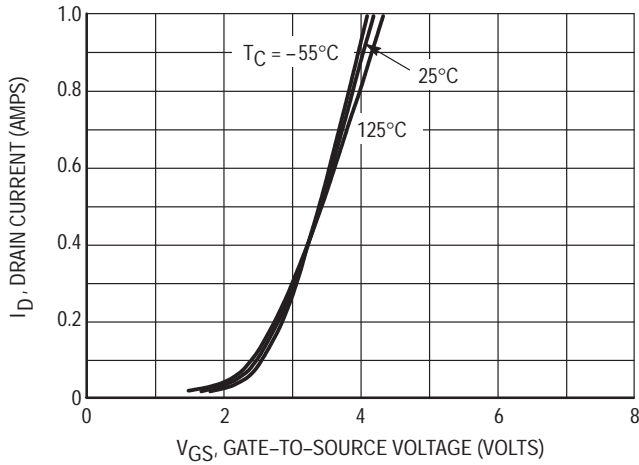


Figure 1. Transfer Characteristics

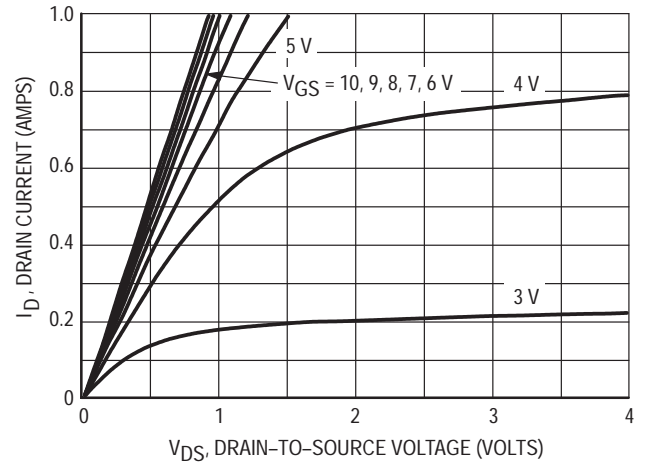


Figure 2. On-Region Characteristics

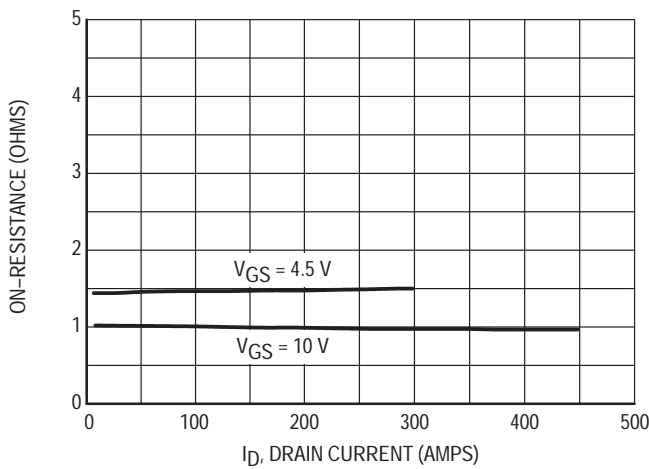


Figure 3. On-Resistance versus Drain Current

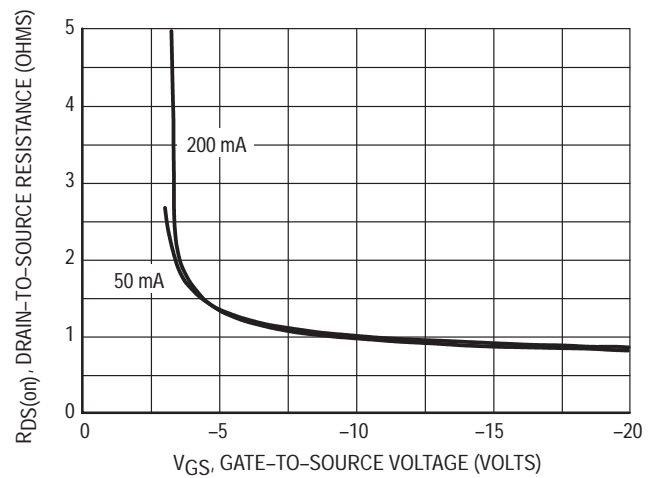


Figure 4. On-Resistance versus Gate-to-Source Voltage

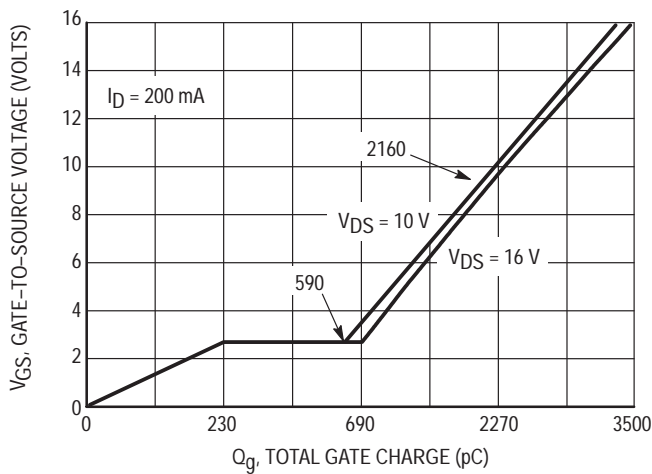


Figure 5. Gate Charge

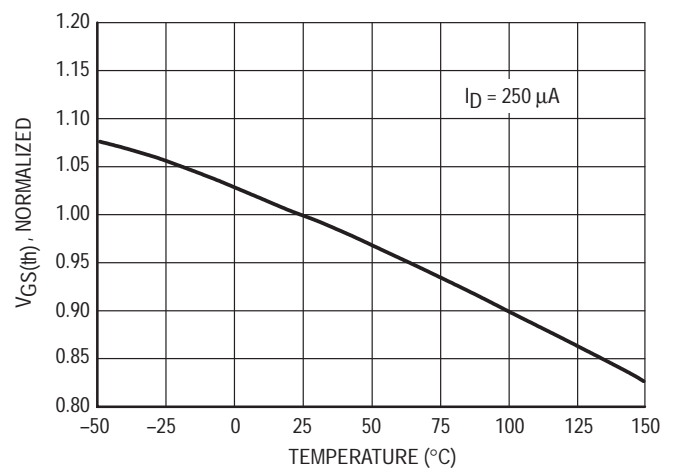


Figure 6. Threshold Voltage Variance Over Temperature

TYPICAL ELECTRICAL CHARACTERISTICS

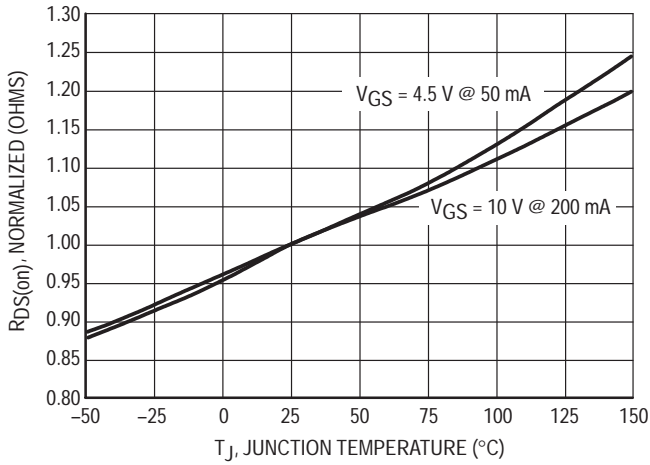


Figure 7. On-Resistance versus Junction Temperature

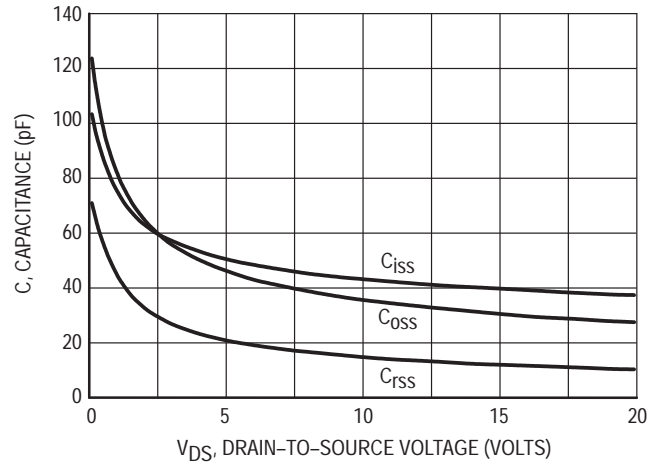


Figure 8. Capacitance

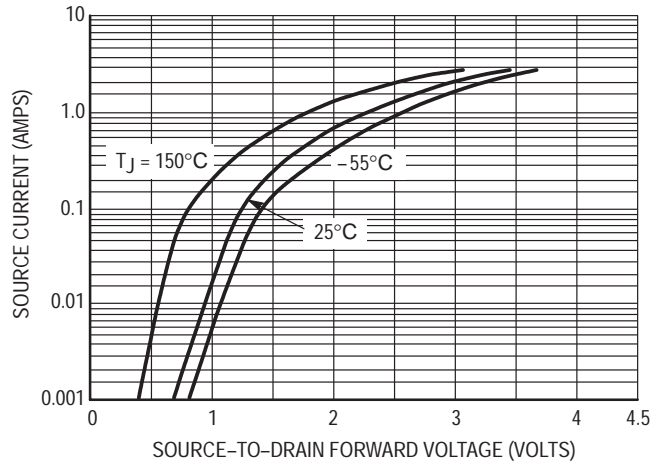


Figure 9. Source-to-Drain Forward Voltage versus Continuous Current (I_S)

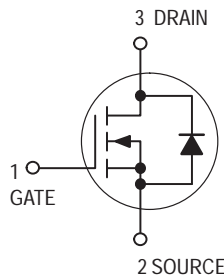


Low $r_{DS(on)}$ Small-Signal MOSFETs TMOS Single N-Channel Field Effect Transistors

Part of the GreenLine™ Portfolio of devices with energy-conserving traits.

These miniature surface mount MOSFETs utilize Motorola's High Cell Density, HDTMOS process. Low $r_{DS(on)}$ assures minimal power loss and conserves energy, making this device ideal for use in small power management circuitry. Typical applications are dc-dc converters, power management in portable and battery-powered products such as computers, printers, PCMCIA cards, cellular and cordless telephones.

- Low $r_{DS(on)}$ Provides Higher Efficiency and Extends Battery Life
- Miniature SC-70/SOT-323 Surface Mount Package Saves Board Space



MMBF2201NT1

Motorola Preferred Device

N-CHANNEL
ENHANCEMENT-MODE
TMOS MOSFET
 $r_{DS(on)} = 1.0 \text{ OHM}$



CASE 419-02, Style 7
SC-70/SOT-323

MAXIMUM RATINGS ($T_J = 25^\circ\text{C}$ unless otherwise noted)

Rating	Symbol	Value	Unit
Drain-to-Source Voltage	V_{DSS}	20	Vdc
Gate-to-Source Voltage — Continuous	V_{GS}	± 20	Vdc
Drain Current — Continuous @ $T_A = 25^\circ\text{C}$ — Continuous @ $T_A = 70^\circ\text{C}$ — Pulsed Drain Current ($t_p \leq 10 \mu\text{s}$)	I_D I_D I_{DM}	300 240 750	mAdc
Total Power Dissipation @ $T_A = 25^\circ\text{C}$ (1) Derate above 25°C	P_D	150 1.2	mW mW/°C
Operating and Storage Temperature Range	T_J, T_{stg}	-55 to 150	°C
Thermal Resistance — Junction-to-Ambient	$R_{\theta JA}$	833	°C/W
Maximum Lead Temperature for Soldering Purposes, for 10 seconds	T_L	260	°C

DEVICE MARKING

N1

(1) Mounted on G10/FR4 glass epoxy board using minimum recommended footprint.

ORDERING INFORMATION

Device	Reel Size	Tape Width	Quantity
MMBF2201NT1	7"	8 mm embossed tape	3000
MMBF2201NT3	13"	8 mm embossed tape	10,000

Preferred devices are Motorola recommended choices for future use and best overall value.

MMBF2201NT1

ELECTRICAL CHARACTERISTICS (T_A = 25°C unless otherwise noted)

Characteristic	Symbol	Min	Typ	Max	Unit
----------------	--------	-----	-----	-----	------

OFF CHARACTERISTICS

Drain-to-Source Breakdown Voltage (V _{GS} = 0 Vdc, I _D = 10 μA)	V _{(BR)DSS}	20	—	—	Vdc
Zero Gate Voltage Drain Current (V _{DS} = 16 Vdc, V _{GS} = 0 Vdc) (V _{DS} = 16 Vdc, V _{GS} = 0 Vdc, T _J = 125°C)	I _{DSS}	—	—	1.0 10	μAdc
Gate-Body Leakage Current (V _{GS} = ± 20 Vdc, V _{DS} = 0)	I _{GSS}	—	—	±100	nAdc

ON CHARACTERISTICS(1)

Gate Threshold Voltage (V _{DS} = V _{GS} , I _D = 250 μAdc)	V _{GS(th)}	1.0	1.7	2.4	Vdc
Static Drain-to-Source On-Resistance (V _{GS} = 10 Vdc, I _D = 300 mAdc) (V _{GS} = 4.5 Vdc, I _D = 100 mAdc)	r _{DS(on)}	—	0.75 1.0	1.0 1.4	Ohms
Forward Transconductance (V _{DS} = 10 Vdc, I _D = 200 mAdc)	g _{FS}	—	450	—	mMhos

DYNAMIC CHARACTERISTICS

Input Capacitance	(V _{DS} = 5.0 V)	C _{iSS}	—	45	—	pF
Output Capacitance	(V _{DS} = 5.0 V)	C _{oSS}	—	25	—	
Transfer Capacitance	(V _{DG} = 5.0 V)	C _{rSS}	—	5.0	—	

SWITCHING CHARACTERISTICS(2)

Turn-On Delay Time	(V _{DD} = 15 Vdc, I _D = 300 mAdc, R _L = 50 Ω)	t _{d(on)}	—	2.5	—	ns
Rise Time		t _r	—	2.5	—	
Turn-Off Delay Time		t _{d(off)}	—	15	—	
Fall Time		t _f	—	0.8	—	
Gate Charge (See Figure 5)		Q _T	—	1400	—	pC

SOURCE-DRAIN DIODE CHARACTERISTICS

Continuous Current	I _S	—	—	0.3	A
Pulsed Current	I _{SM}	—	—	0.75	
Forward Voltage(2)	V _{SD}	—	0.85	—	V

(1) Pulse Test: Pulse Width ≤ 300 μs, Duty Cycle ≤ 2%.

(2) Switching characteristics are independent of operating junction temperature.

TYPICAL CHARACTERISTICS

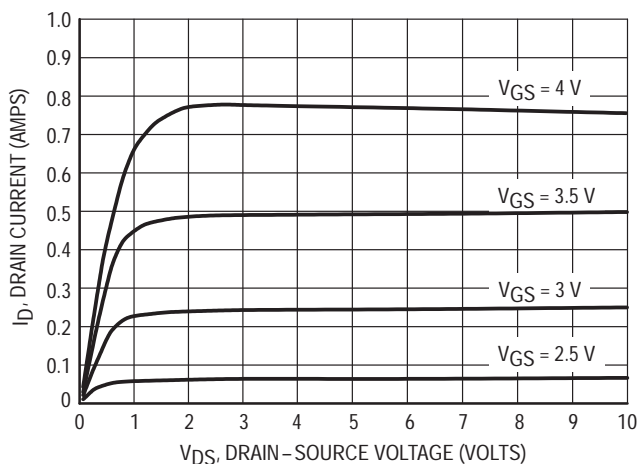


Figure 1. Typical Drain Characteristics

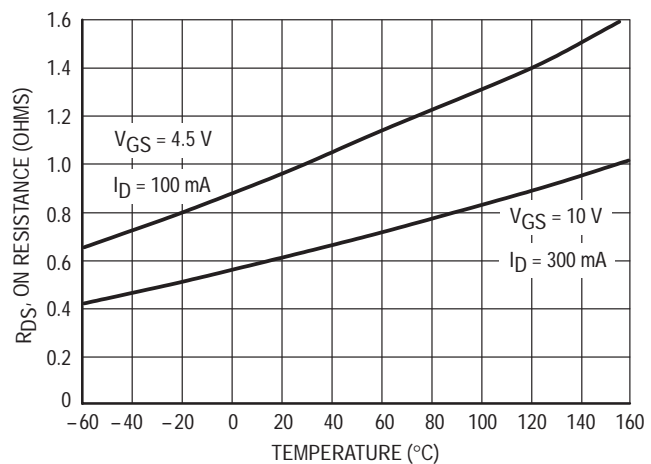


Figure 2. On Resistance versus Temperature

TYPICAL CHARACTERISTICS

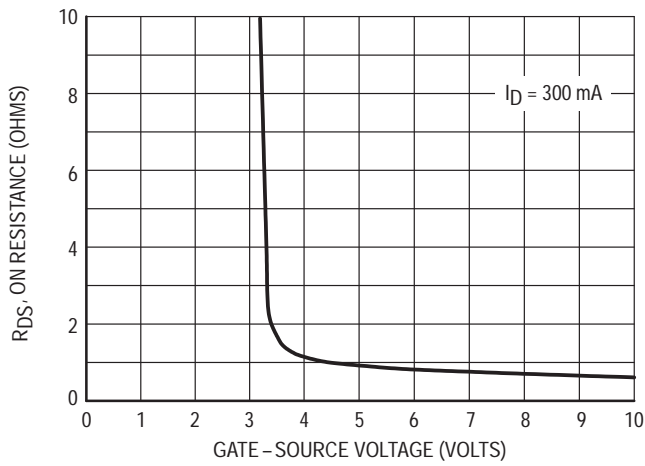


Figure 3. On Resistance versus Gate-Source Voltage

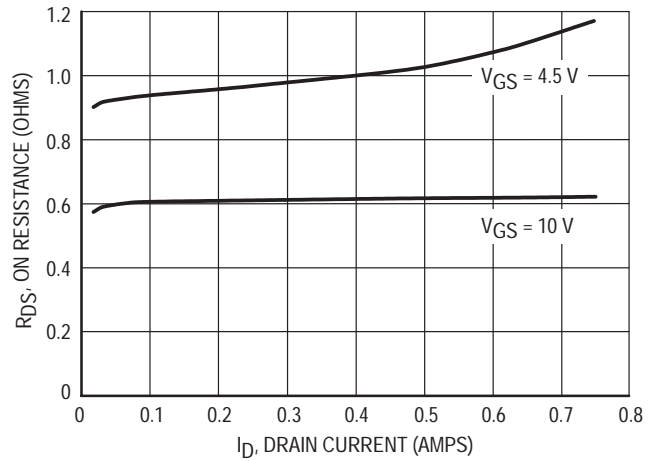


Figure 4. On Resistance versus Drain Current

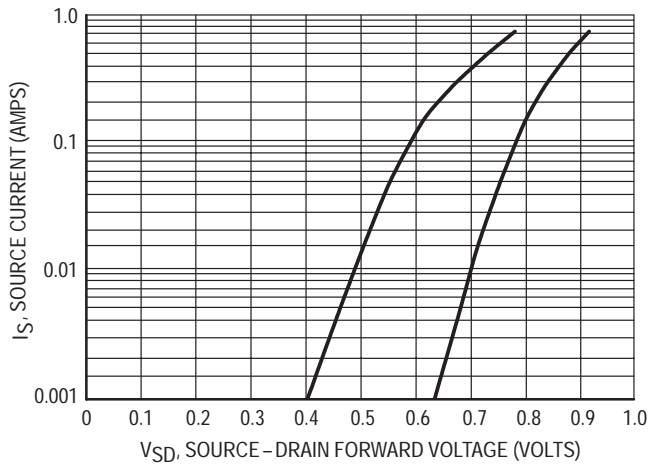


Figure 5. Source-Drain Forward Voltage

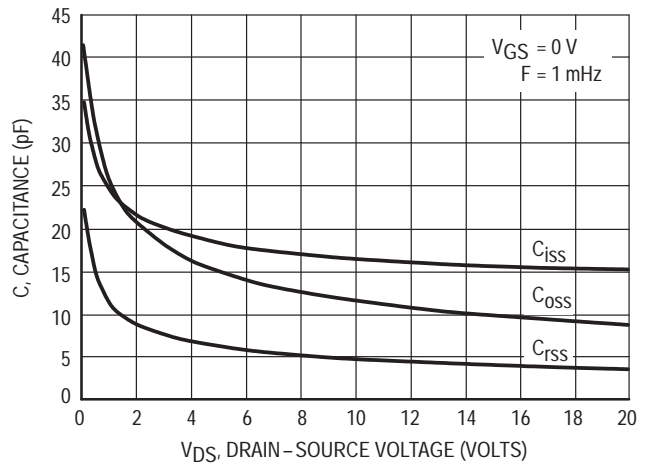


Figure 6. Capacitance Variation

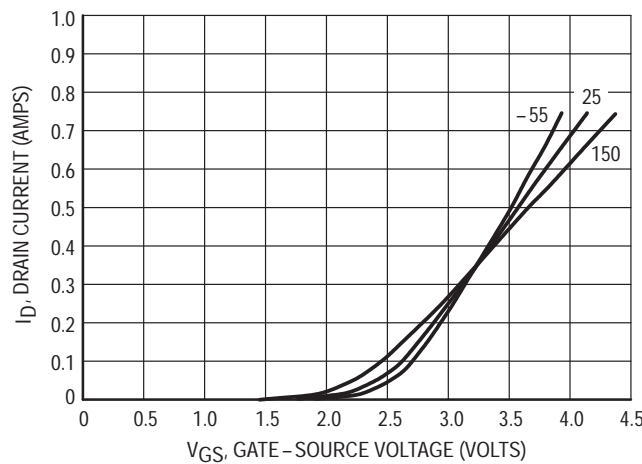


Figure 7. Transfer Characteristics



MMBF2202PT1

Motorola Preferred Device

Low $r_{DS(on)}$ Small-Signal MOSFETs
TMOS Single P-Channel
Field Effect Transistors

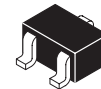
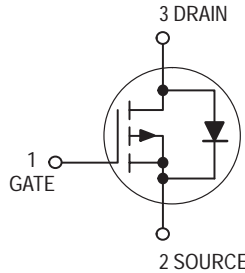
Part of the GreenLine™ Portfolio of devices with energy-conserving traits.

These miniature surface mount MOSFETs utilize Motorola's High Cell Density, HDTMOS process. Low $r_{DS(on)}$ assures minimal power loss and conserves energy, making this device ideal for use in small power management circuitry. Typical applications are dc-dc converters, power management in portable and battery-powered products such as computers, printers, PCMCIA cards, cellular and cordless telephones.

- Low $r_{DS(on)}$ Provides Higher Efficiency and Extends Battery Life
- Miniature SC-70/SOT-323 Surface Mount Package Saves Board Space



P-CHANNEL
ENHANCEMENT-MODE
TMOS MOSFET
 $r_{DS(on)} = 2.2 \text{ OHM}$



CASE 419-02, STYLE 7
SC-70/SOT-323

MAXIMUM RATINGS ($T_J = 25^\circ\text{C}$ unless otherwise noted)

Rating	Symbol	Value	Unit
Drain-to-Source Voltage	V_{DSS}	20	Vdc
Gate-to-Source Voltage — Continuous	V_{GS}	± 20	Vdc
Drain Current — Continuous @ $T_A = 25^\circ\text{C}$ — Continuous @ $T_A = 70^\circ\text{C}$ — Pulsed Drain Current ($t_p \leq 10 \mu\text{s}$)	I_D I_D I_{DM}	300 240 750	mAdc
Total Power Dissipation @ $T_A = 25^\circ\text{C}$ (1) Derate above 25°C	P_D	150 1.2	mW mW/°C
Operating and Storage Temperature Range	T_J, T_{stg}	-55 to 150	°C
Thermal Resistance — Junction-to-Ambient	$R_{\theta JA}$	833	°C/W
Maximum Lead Temperature for Soldering Purposes, for 10 seconds	T_L	260	°C

DEVICE MARKING

P3

(1) Mounted on G10/FR4 glass epoxy board using minimum recommended footprint.

ORDERING INFORMATION

Device	Reel Size	Tape Width	Quantity
MMBF2202PT1	7"	8 mm embossed tape	3000
MMBF2202PT3	13"	8 mm embossed tape	10,000

Preferred devices are Motorola recommended choices for future use and best overall value.

ELECTRICAL CHARACTERISTICS ($T_A = 25^\circ\text{C}$ unless otherwise noted)

Characteristic	Symbol	Min	Typ	Max	Unit
OFF CHARACTERISTICS					
Drain-to-Source Breakdown Voltage ($V_{GS} = 0\text{ Vdc}$, $I_D = 10\ \mu\text{A}$)	$V_{(BR)DSS}$	20	—	—	Vdc
Zero Gate Voltage Drain Current ($V_{DS} = 16\text{ Vdc}$, $V_{GS} = 0\text{ Vdc}$) ($V_{DS} = 16\text{ Vdc}$, $V_{GS} = 0\text{ Vdc}$, $T_J = 125^\circ\text{C}$)	I_{DSS}	—	—	1.0 10	μAdc
Gate-Body Leakage Current ($V_{GS} = \pm 20\text{ Vdc}$, $V_{DS} = 0$)	I_{GSS}	—	—	± 100	nAdc
ON CHARACTERISTICS(1)					
Gate Threshold Voltage ($V_{DS} = V_{GS}$, $I_D = 250\ \mu\text{Adc}$)	$V_{GS(th)}$	1.0	1.7	2.4	Vdc
Static Drain-to-Source On-Resistance ($V_{GS} = 10\text{ Vdc}$, $I_D = 200\text{ mAdc}$) ($V_{GS} = 4.5\text{ Vdc}$, $I_D = 50\text{ mAdc}$)	$r_{DS(on)}$	—	1.5 2.0	2.2 3.5	Ohms
Forward Transconductance ($V_{DS} = 10\text{ Vdc}$, $I_D = 200\text{ mAdc}$)	g_{FS}	—	600	—	mMhos
DYNAMIC CHARACTERISTICS					
Input Capacitance	($V_{DS} = 5.0\text{ V}$)	C_{iss}	—	50	pF
Output Capacitance	($V_{DS} = 5.0\text{ V}$)	C_{oss}	—	45	
Transfer Capacitance	($V_{DG} = 5.0\text{ V}$)	C_{rss}	—	20	
SWITCHING CHARACTERISTICS(2)					
Turn-On Delay Time	($V_{DD} = -15\text{ Vdc}$, $R_L = 75\ \Omega$, $I_D = 200\text{ mAdc}$, $V_{GEN} = -10\text{ V}$, $R_G = 6.0\ \Omega$)	$t_{d(on)}$	—	2.5	ns
Rise Time		t_r	—	1.0	
Turn-Off Delay Time		$t_{d(off)}$	—	16	
Fall Time		t_f	—	8.0	
Gate Charge (See Figure 5)	($V_{DS} = 16\text{ V}$, $V_{GS} = 10\text{ V}$, $I_D = 200\text{ mA}$)	Q_T	—	2700	pC
SOURCE-DRAIN DIODE CHARACTERISTICS					
Continuous Current	I_S	—	—	0.3	A
Pulsed Current	I_{SM}	—	—	0.75	
Forward Voltage ⁽²⁾	V_{SD}	—	1.5	—	V

(1) Pulse Test: Pulse Width $\leq 300\ \mu\text{s}$, Duty Cycle $\leq 2\%$.

(2) Switching characteristics are independent of operating junction temperature.

TYPICAL CHARACTERISTICS

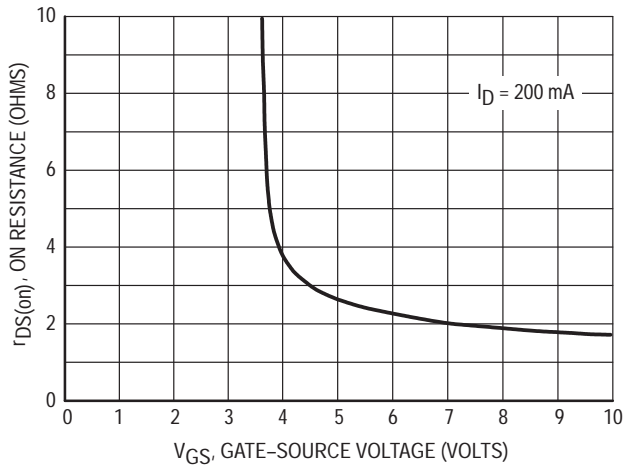


Figure 1. On Resistance versus Gate-Source Voltage

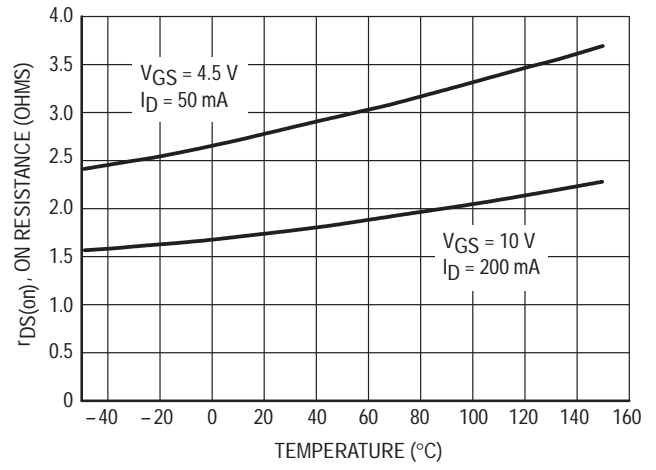


Figure 2. On Resistance versus Temperature

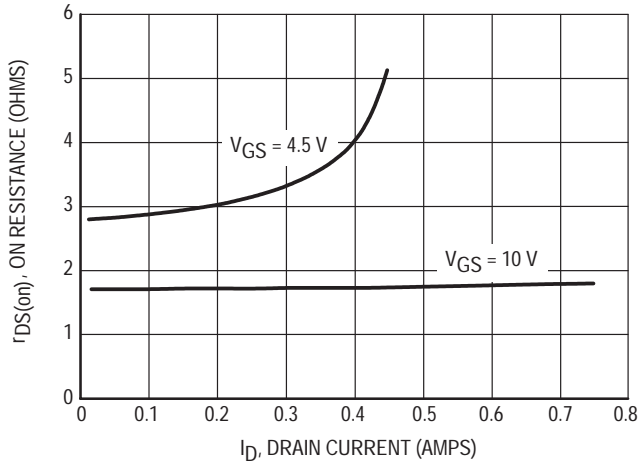


Figure 3. On Resistance versus Drain Current

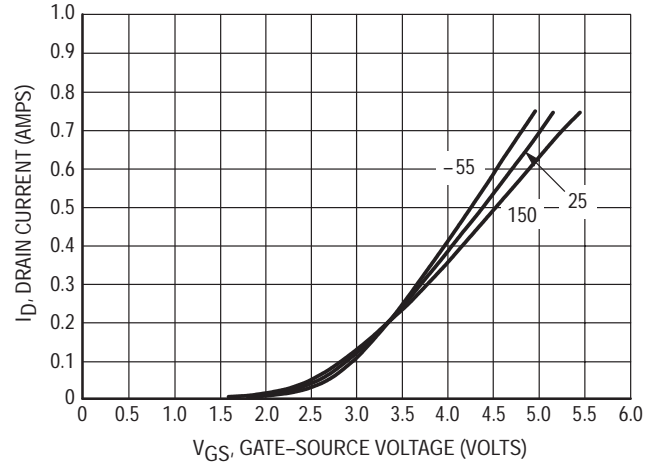


Figure 4. Transfer Characteristics

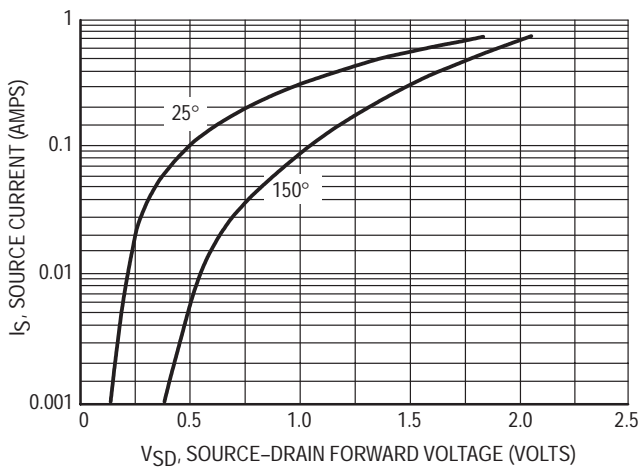


Figure 5. Source-Drain Forward Voltage

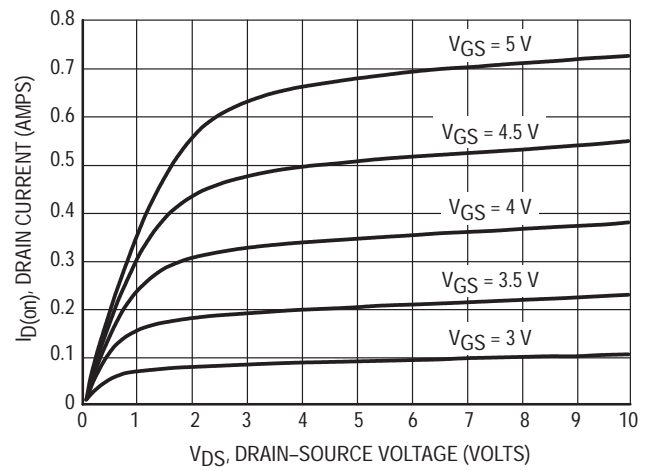


Figure 6. On Region Characteristics

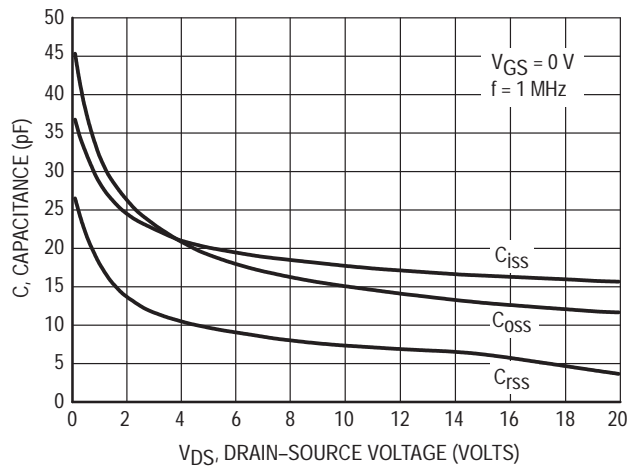


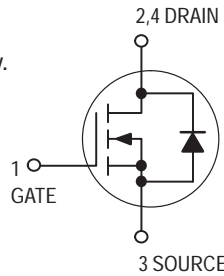
Figure 7. Capacitance Variation

Medium Power Field Effect Transistor

N-Channel Enhancement-Mode Silicon Gate TMOS SOT-223 for Surface Mount

This TMOS medium power field effect transistor is designed for high speed, low loss power switching applications such as switching regulators, dc-dc converters, solenoid and relay drivers. The device is housed in the SOT-223 package which is designed for medium power surface mount applications.

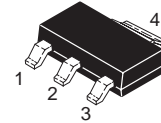
- Silicon Gate for Fast Switching Speeds
- $R_{DS(on)} = 14 \text{ Ohm Max}$
- Low Drive Requirement
- The SOT-223 Package can be soldered using wave or reflow. The formed leads absorb thermal stress during soldering eliminating the possibility of damage to the die.
- Available in 12 mm Tape and Reel
 - Use MMFT107T1 to order the 7 inch/1000 unit reel
 - Use MMFT107T3 to order the 13 inch/4000 unit reel



MMFT107T1

Motorola Preferred Device

MEDIUM POWER
TMOS FET
250 mA, 200 VOLTS
 $R_{DS(on)} = 14 \text{ OHM MAX}$



CASE 318E-04, STYLE 3
TO-261AA

MAXIMUM RATINGS ($T_C = 25^\circ\text{C}$ unless otherwise noted)

Rating	Symbol	Value	Unit
Drain-to-Source Voltage	V_{DSS}	200	Volts
Gate-to-Source Voltage — Non-Repetitive	V_{GS}	± 20	Volts
Drain Current	I_D	250	mA _{dc}
Total Power Dissipation @ $T_A = 25^\circ\text{C}$ (1) Derate above 25°C	P_D	0.8 6.4	Watts mW/ $^\circ\text{C}$
Operating and Storage Temperature Range	T_J, T_{stg}	-65 to 150	$^\circ\text{C}$

DEVICE MARKING

FT107

THERMAL CHARACTERISTICS

Thermal Resistance — Junction-to-Ambient	$R_{\theta JA}$	156	$^\circ\text{C}/\text{W}$
Maximum Temperature for Soldering Purposes Time in Solder Bath	T_L	260 10	$^\circ\text{C}$ Sec

1. Device mounted on FR-4 glass epoxy printed circuit using minimum recommended footprint.

Preferred devices are Motorola recommended choices for future use and best overall value.

ELECTRICAL CHARACTERISTICS ($T_A = 25^\circ\text{C}$ unless otherwise noted)

Characteristic	Symbol	Min	Typ	Max	Unit
OFF CHARACTERISTICS					
Drain-to-Source Breakdown Voltage ($V_{GS} = 0, I_D = 10 \mu\text{A}$)	$V_{(BR)DSS}$	200	—	—	Vdc
Zero Gate Voltage Drain Current ($V_{DS} = 130 \text{ V}, V_{GS} = 0$)	I_{DSS}	—	—	30	nAdc
Gate-Body Leakage Current — Reverse ($V_{GS} = 15 \text{ Vdc}, V_{DS} = 0$)	I_{GSS}	—	—	10	nAdc

ON CHARACTERISTICS(1)

Gate Threshold Voltage ($V_{DS} = V_{GS}, I_D = 1.0 \text{ mAdc}$)	$V_{GS(th)}$	1.0	—	3.0	Vdc
Static Drain-to-Source On-Resistance ($V_{GS} = 10 \text{ Vdc}, I_D = 200 \text{ mA}$)	$R_{DS(on)}$	—	—	14	Ohms
Drain-to-Source On-Voltage ($V_{GS} = 10 \text{ V}, I_D = 200 \text{ mA}$)	$V_{DS(on)}$	—	—	2.8	Vdc
Forward Transconductance ($V_{DS} = 25 \text{ V}, I_D = 250 \text{ mA}$)	g_{fs}	—	300	—	mmhos

DYNAMIC CHARACTERISTICS

Input Capacitance	$(V_{DS} = 25 \text{ V}, V_{GS} = 0, f = 1.0 \text{ MHz})$	C_{iss}	—	60	—	pF
Output Capacitance		C_{oss}	—	30	—	
Transfer Capacitance		C_{rss}	—	6.0	—	

SOURCE DRAIN DIODE CHARACTERISTICS

Diode Forward Voltage	$(V_{GS} = 0, I_S = 250 \text{ mA})$	V_F	—	0.8	—	V
Continuous Source Current, Body Diode		I_S	—	—	250	mA
Pulsed Source Current, Body Diode		I_{SM}	—	—	500	

1. Pulse Test: Pulse Width $\leq 300 \mu\text{s}$, Duty Cycle $\leq 2.0\%$.

TYPICAL ELECTRICAL CHARACTERISTICS

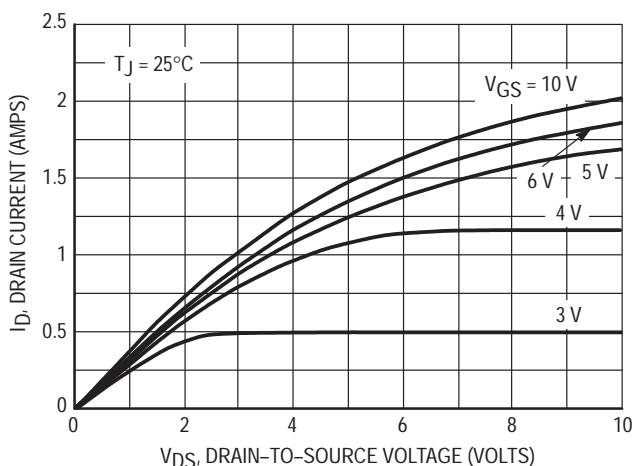


Figure 1. On-Region Characteristics

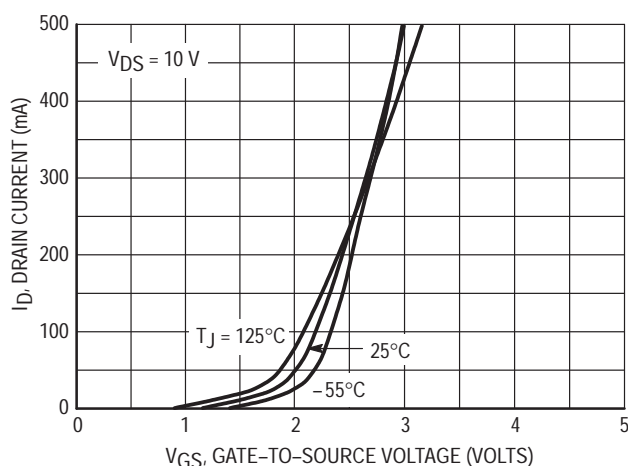


Figure 2. Transfer Characteristics

TYPICAL ELECTRICAL CHARACTERISTICS

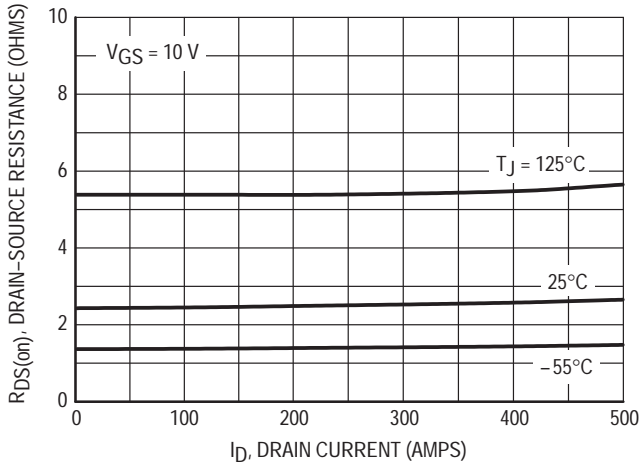


Figure 3. On-Resistance versus Drain Current

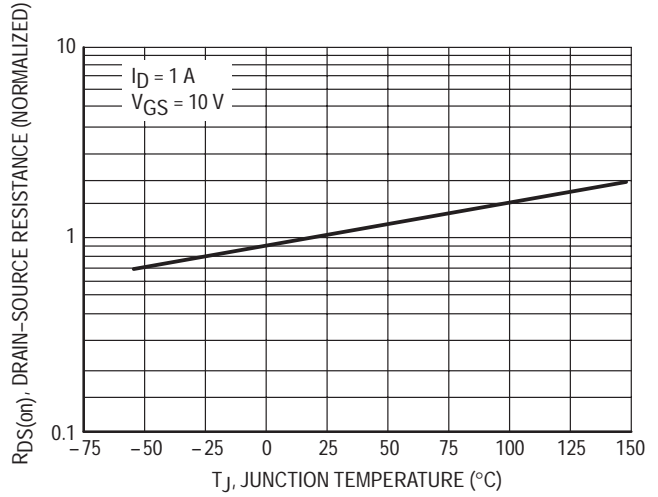


Figure 4. On-Resistance Variation with Temperature

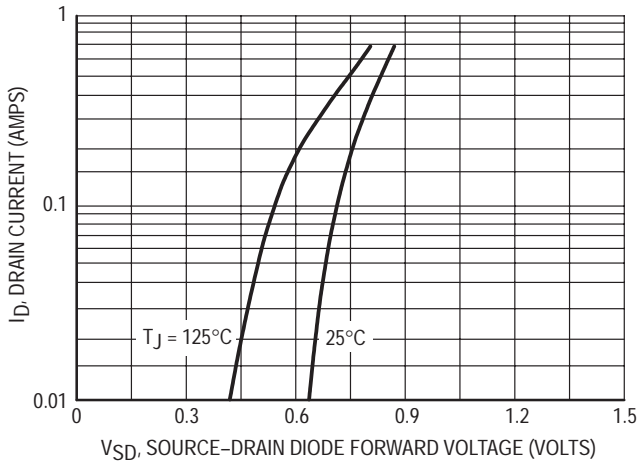


Figure 5. Source-Drain Diode Forward Voltage

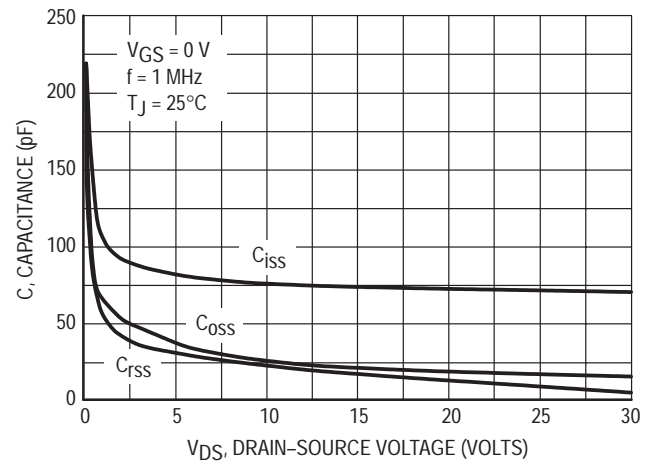


Figure 6. Capacitance Variation

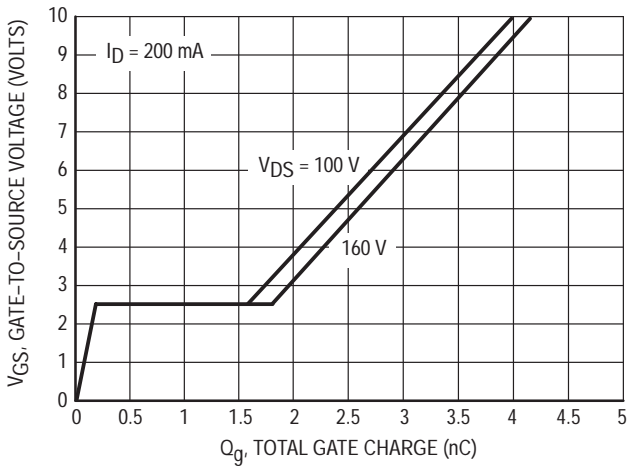


Figure 7. Gate Charge versus Gate-to-Source Voltage

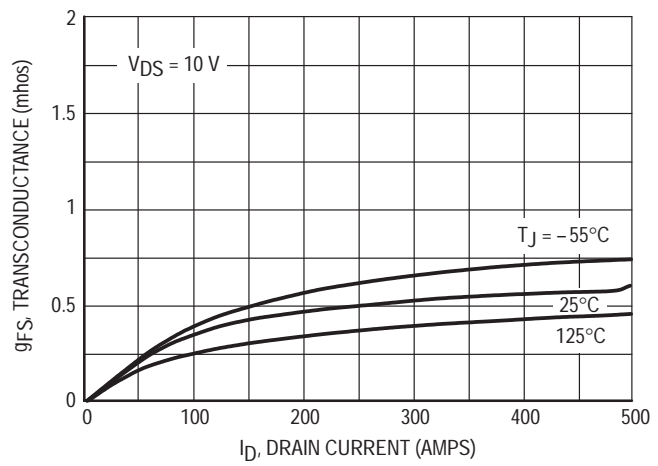


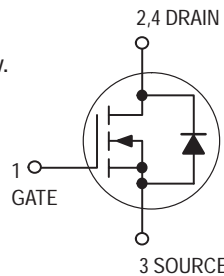
Figure 8. Transconductance

Medium Power Field Effect Transistor

N-Channel Enhancement-Mode Silicon Gate TMOS SOT-223 for Surface Mount

This TMOS medium power field effect transistor is designed for high speed, low loss power switching applications such as switching regulators, dc-dc converters, solenoid and relay drivers. The device is housed in the SOT-223 package which is designed for medium power surface mount applications.

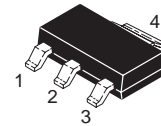
- Silicon Gate for Fast Switching Speeds
- $R_{DS(on)} = 1.7 \text{ Ohm Max}$
- Low Drive Requirement
- The SOT-223 Package can be soldered using wave or reflow. The formed leads absorb thermal stress during soldering eliminating the possibility of damage to the die.
- Available in 12 mm Tape and Reel
 - Use MMFT960T1 to order the 7 inch/1000 unit reel
 - Use MMFT960T3 to order the 13 inch/4000 unit reel



MMFT960T1

Motorola Preferred Device

**MEDIUM POWER
TMOS FET**
300 mA
60 VOLTS
 $R_{DS(on)} = 1.7 \text{ OHM MAX}$



**CASE 318E-04, STYLE 3
TO-261AA**

MAXIMUM RATINGS ($T_C = 25^\circ\text{C}$ unless otherwise noted)

Rating	Symbol	Value	Unit
Drain-to-Source Voltage	V_{DS}	60	Volts
Gate-to-Source Voltage — Non-Repetitive	V_{GS}	± 30	Volts
Drain Current	I_D	300	mAdc
Total Power Dissipation @ $T_A = 25^\circ\text{C}$ ⁽¹⁾ Derate above 25°C	P_D	0.8 6.4	Watts mW/ $^\circ\text{C}$
Operating and Storage Temperature Range	T_J, T_{stg}	-65 to 150	$^\circ\text{C}$

DEVICE MARKING

FT960

THERMAL CHARACTERISTICS

Thermal Resistance — Junction-to-Ambient	$R_{\theta JA}$	156	$^\circ\text{C/W}$
Maximum Temperature for Soldering Purposes Time in Solder Bath	T_L	260 10	$^\circ\text{C}$ Sec

1. Device mounted on a FR-4 glass epoxy printed circuit board using minimum recommended footprint.

Preferred devices are Motorola recommended choices for future use and best overall value.

MMFT960T1

ELECTRICAL CHARACTERISTICS (T_A = 25°C unless otherwise noted)

Characteristic	Symbol	Min	Typ	Max	Unit
OFF CHARACTERISTICS					
Drain-to-Source Breakdown Voltage (V _{GS} = 0, I _D = 10 μA)	V _{(BR)DSS}	60	—	—	Vdc
Zero Gate Voltage Drain Current (V _{DS} = 60 V, V _{GS} = 0)	I _{DSS}	—	—	10	μAdc
Gate-Body Leakage Current (V _{GS} = 15 Vdc, V _{DS} = 0)	I _{GSS}	—	—	50	nAdc

ON CHARACTERISTICS(1)

Gate Threshold Voltage (V _{DS} = V _{GS} , I _D = 1.0 mA)	V _{GS(th)}	1.0	—	3.5	Vdc
Static Drain-to-Source On-Resistance (V _{GS} = 10 Vdc, I _D = 1.0 A)	R _{DS(on)}	—	—	1.7	Ohms
Drain-to-Source On-Voltage (V _{GS} = 10 V, I _D = 0.5 A) (V _{GS} = 10 V, I _D = 1.0 A)	V _{DS(on)}	—	—	0.8 1.7	Vdc
Forward Transconductance (V _{DS} = 25 V, I _D = 0.5 A)	g _{fs}	—	600	—	mmhos

DYNAMIC CHARACTERISTICS

Input Capacitance	(V _{DS} = 25 V, V _{GS} = 0, f = 1.0 MHz)	C _{iSS}	—	65	—	pF
Output Capacitance		C _{oSS}	—	33	—	
Transfer Capacitance		C _{rSS}	—	7.0	—	
Total Gate Charge	(V _{GS} = 10 V, I _D = 1.0 A, V _{DS} = 48 V)	Q _g	—	3.2	—	nC
Gate-Source Charge		Q _{gs}	—	1.2	—	
Gate-Drain Charge		Q _{gd}	—	2.0	—	

1. Pulse Test: Pulse Width ≤ 300 μs, Duty Cycle ≤ 2.0%.

TYPICAL ELECTRICAL CHARACTERISTICS

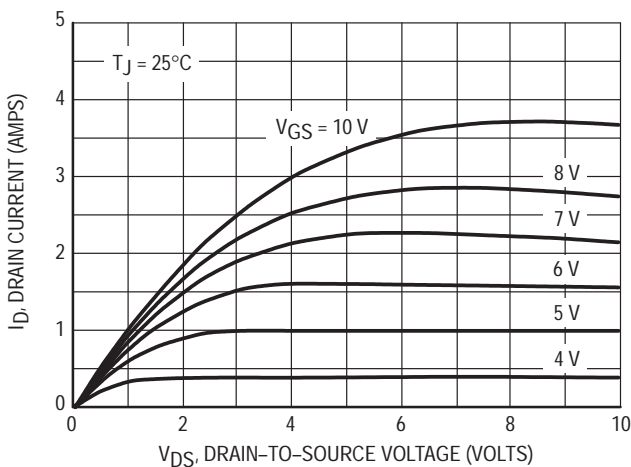


Figure 1. On-Region Characteristics

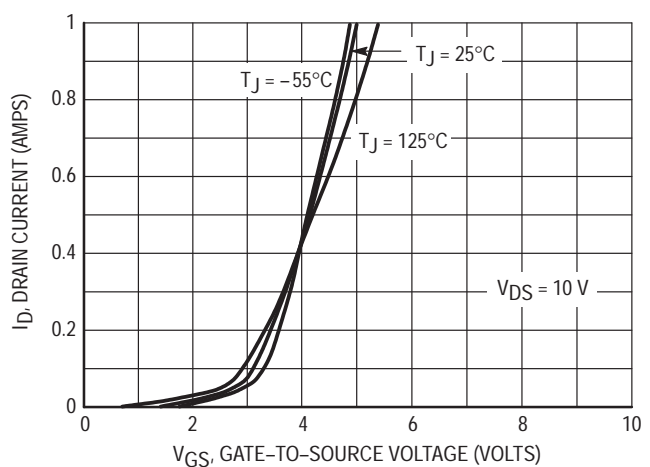


Figure 2. Transfer Characteristics

TYPICAL ELECTRICAL CHARACTERISTICS

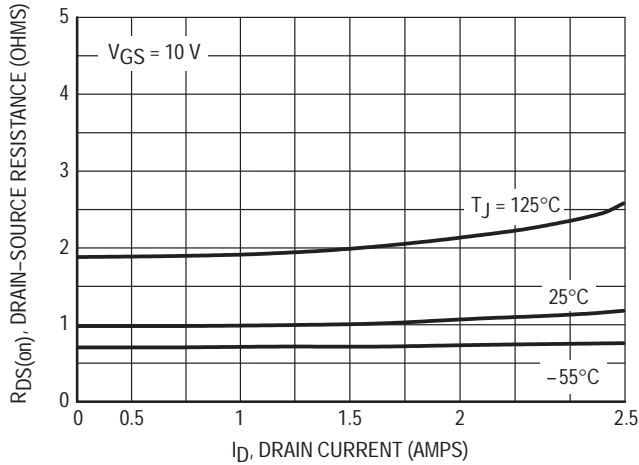


Figure 3. On-Resistance versus Drain Current

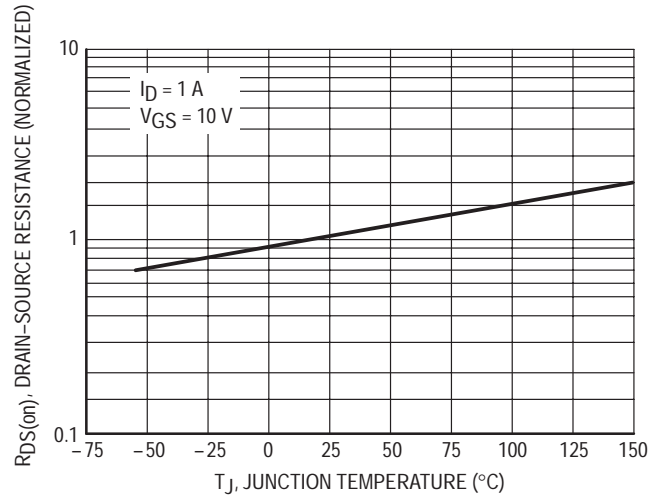


Figure 4. On-Resistance Variation with Temperature

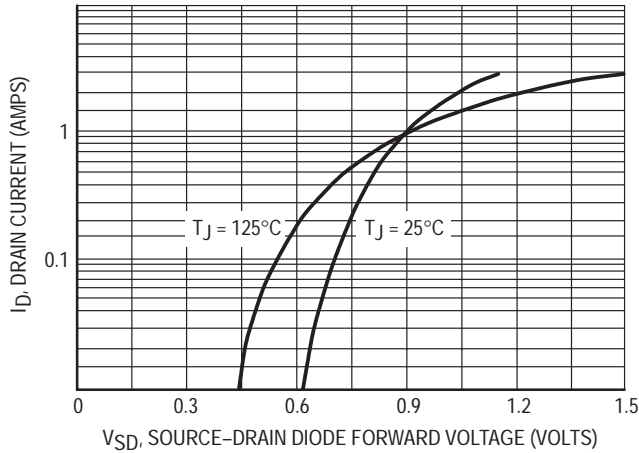


Figure 5. Source-Drain Diode Forward Voltage

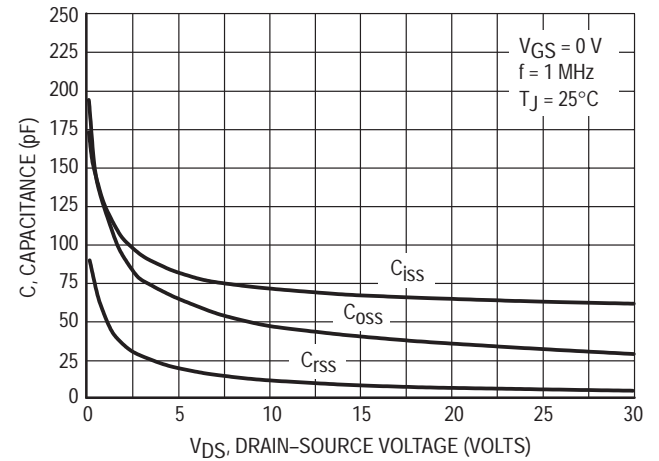


Figure 6. Capacitance Variation

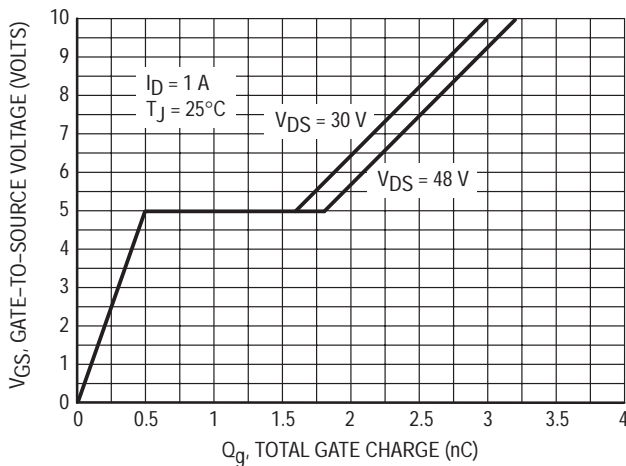


Figure 7. Gate Charge versus Gate-to-Source Voltage

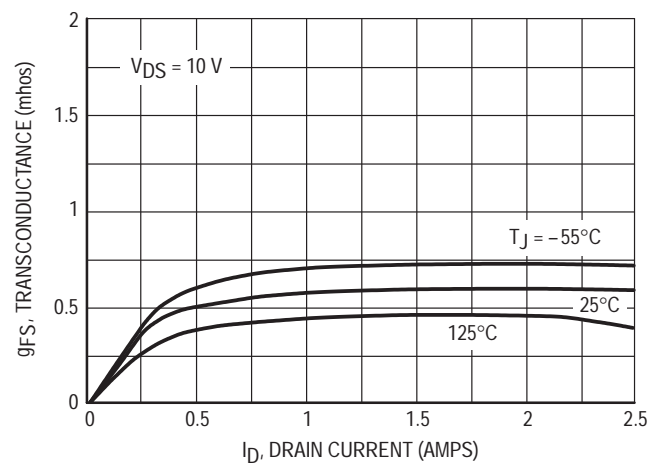


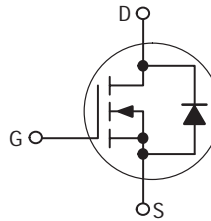
Figure 8. Transconductance

Medium Power Field Effect Transistor

N-Channel Enhancement Mode Silicon Gate TMOS E-FET™ SOT-223 for Surface Mount

This TMOS medium power field effect transistor is designed for high speed, low loss power switching applications such as switching regulators, converters, solenoid and relay drivers. The device is housed in the SOT-223 package which is designed for medium power surface mount applications.

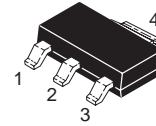
- Silicon Gate for Fast Switching Speeds
- High Voltage — 240 Vdc
- Low Drive Requirement
- The SOT-223 Package can be soldered using wave or reflow. The formed leads absorb thermal stress during soldering, eliminating the possibility of damage to the die.
- Available in 12 mm Tape and Reel
 - Use MMFT2406T1 to order the 7 inch/1000 unit reel.
 - Use MMFT2406T3 to order the 13 inch/4000 unit reel.



MMFT2406T1

Motorola Preferred Device

**MEDIUM POWER
TMOS FET
700 mA
240 VOLTS
R_{DS(on)} = 6.0 OHM**



**CASE 318E-04, STYLE 3
TO-261AA**

MAXIMUM RATINGS (T_C = 25°C unless otherwise noted)

Rating	Symbol	Value	Unit
Drain-to-Source Voltage	V _{DS}	240	Vdc
Gate-to-Source Voltage — Continuous	V _{GS}	±20	Vdc
Drain Current	I _D	700	mAdc
Total Power Dissipation @ T _A = 25°C ⁽¹⁾ Derate above 25°C	P _D	1.5 12	Watts mW/°C
Operating and Storage Temperature Range	T _J , T _{stg}	-65 to 150	°C

DEVICE MARKING

T2406

THERMAL CHARACTERISTICS

Thermal Resistance — Junction-to-Ambient (surface mounted) ⁽¹⁾	R _{θJA}	83.3	°C/W
Lead Temperature for Soldering Purposes, 1/16" from case Time in Solder Bath	T _L	260 10	°C Sec

1. Device mounted on a glass epoxy printed circuit board 1.575 in. x 1.575 in. x 0.059 in.; mounting pad for the collector lead min. 0.93 sq. in.

Preferred devices are Motorola recommended choices for future use and best overall value.

ELECTRICAL CHARACTERISTICS ($T_A = 25^\circ\text{C}$ unless otherwise noted)

Characteristics	Symbol	Min	Max	Unit
-----------------	--------	-----	-----	------

OFF CHARACTERISTICS

Drain-to-Source Breakdown Voltage ($V_{GS} = 0$, $I_D = 100 \mu\text{A}$)	$V_{(BR)DSS}$	240	—	Vdc
Zero Gate Voltage Drain Current ($V_{DS} = 120 \text{V}$, $V_{GS} = 0$)	I_{DSS}	—	10	μAdc
Gate-Body Leakage Current ($V_{GS} = 15 \text{Vdc}$, $V_{DS} = 0$)	I_{GSS}	—	100	nAdc

ON CHARACTERISTICS(2)

Gate Threshold Voltage ($V_{DS} = V_{GS}$, $I_D = 1.0 \text{mAdc}$)	$V_{GS(th)}$	0.8	2.0	Vdc
Static Drain-to-Source On-Resistance ($V_{GS} = 2.5 \text{Vdc}$, $I_D = 0.1 \text{Adc}$) ($V_{GS} = 10 \text{Vdc}$, $I_D = 0.5 \text{Adc}$)	$R_{DS(on)}$	— —	10 6.0	Ohms
Drain-to-Source On-Voltage ($V_{GS} = 10 \text{V}$, $I_D = 0.5 \text{A}$)	$V_{DS(on)}$	—	3.0	Vdc
Forward Transconductance ($V_{DS} = 6.0 \text{V}$, $I_D = 0.5 \text{A}$)	g_{FS}	300	—	mmhos

DYNAMIC CHARACTERISTICS

Input Capacitance	$(V_{DS} = 25 \text{V}, V_{GS} = 0,$ $f = 1.0 \text{MHz})$	C_{iss}	—	125	pF
Output Capacitance		C_{oss}	—	50	
Transfer Capacitance		C_{rss}	—	20	

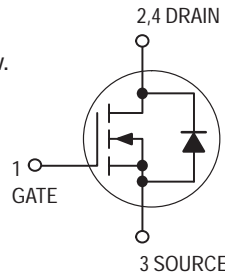
2. Pulse Test: Pulse Width $\leq 300 \mu\text{s}$, Duty Cycle $\leq 2.0\%$.

Medium Power Field Effect Transistor

N-Channel Enhancement-Mode Silicon Gate TMOS SOT-223 for Surface Mount

This TMOS medium power field effect transistor is designed for high speed, low loss power switching applications such as switching regulators, dc-dc converters, solenoid and relay drivers. The device is housed in the SOT-223 package which is designed for medium power surface mount applications.

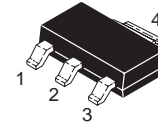
- Silicon Gate for Fast Switching Speeds
- $R_{DS(on)} = 4.0$ Ohm Max
- Low Drive Requirement, $V_{GS} = 2.0$ Volts Max
- The SOT-223 Package can be soldered using wave or reflow. The formed leads absorb thermal stress during soldering eliminating the possibility of damage to the die.
- Available in 12 mm Tape and Reel
 - Use MMFT6661T1 to order the 7 inch/1000 unit reel
 - Use MMFT6661T3 to order the 13 inch/4000 unit reel



MMFT6661T1

Motorola Preferred Device

**MEDIUM POWER
TMOS FET
500 mA
90 VOLTS
 $R_{DS(on)} = 4.0$ OHM MAX**



**CASE 318E-04, STYLE 3
TO-261AA**

MAXIMUM RATINGS ($T_C = 25^\circ\text{C}$ unless otherwise noted)

Rating	Symbol	Value	Unit
Drain-to-Source Voltage	V_{DS}	90	Vdc
Gate-to-Source Voltage — Non-Repetitive	V_{GS}	± 30	Vdc
Drain Current	I_D	500	mAdc
Total Power Dissipation @ $T_A = 25^\circ\text{C}$ (1) Derate above 25°C	P_D	0.8 6.4	Watts mW/ $^\circ\text{C}$
Operating and Storage Temperature Range	T_J, T_{stg}	-65 to 150	$^\circ\text{C}$

DEVICE MARKING

T6661

THERMAL CHARACTERISTICS

Thermal Resistance — Junction-to-Ambient	$R_{\theta JA}$	156	$^\circ\text{C}/\text{W}$
Maximum Temperature for Soldering Purposes Time in Solder Bath	T_L	260 10	$^\circ\text{C}$ Sec

1. Device mounted on FR-4 glass epoxy printed circuit board using minimum recommended footprint.

Preferred devices are Motorola recommended choices for future use and best overall value.

ELECTRICAL CHARACTERISTICS ($T_A = 25^\circ\text{C}$ unless otherwise noted)

Characteristic	Symbol	Min	Typ	Max	Unit
OFF CHARACTERISTICS					
Drain-to-Source Breakdown Voltage ($V_{GS} = 0, I_D = 10 \mu\text{A}$)	$V_{(BR)DSS}$	90	—	—	Vdc
Zero Gate Voltage Drain Current ($V_{DS} = 90 \text{ V}, V_{GS} = 0$)	I_{DSS}	—	—	10	μA dc
Gate-Body Leakage Current ($V_{GS} = 15 \text{ Vdc}, V_{DS} = 0$)	I_{GSS}	—	—	100	nA dc

ON CHARACTERISTICS(2)

Gate Threshold Voltage ($V_{DS} = V_{GS}, I_D = 1.0 \text{ mAdc}$)	$V_{GS(th)}$	0.8	—	2.0	Vdc
Static Drain-to-Source On-Resistance ($V_{GS} = 10 \text{ Vdc}, I_D = 1.0 \text{ Adc}$)	$R_{DS(on)}$	—	—	4.0	Ohms
Drain-to-Source On-Voltage ($V_{GS} = 10 \text{ V}, I_D = 1.0 \text{ A}$) ($V_{GS} = 5.0 \text{ V}, I_D = 0.3 \text{ A}$)	$V_{DS(on)}$	—	—	4.0 1.6	Vdc
Forward Transconductance ($V_{DS} = 25 \text{ V}, I_D = 0.5 \text{ A}$)	g_{FS}	—	200	—	mmhos

DYNAMIC CHARACTERISTICS

Input Capacitance	$(V_{DS} = 25 \text{ V}, V_{GS} = 0, f = 1.0 \text{ MHz})$	C_{iss}	—	36	—	pF
Output Capacitance		C_{oss}	—	16	—	
Transfer Capacitance		C_{rss}	—	6.0	—	
Total Gate Charge	$(V_{GS} = 10 \text{ V}, I_D = 1.0 \text{ A}, V_{DS} = 72 \text{ V})$	Q_g	—	1.7	—	nC
Gate-Source Charge		Q_{gs}	—	0.34	—	
Gate-Drain Charge		Q_{gd}	—	0.23	—	

2. Pulse Test: Pulse Width $\leq 300 \mu\text{s}$, Duty Cycle $\leq 2.0\%$

TYPICAL ELECTRICAL CHARACTERISTICS

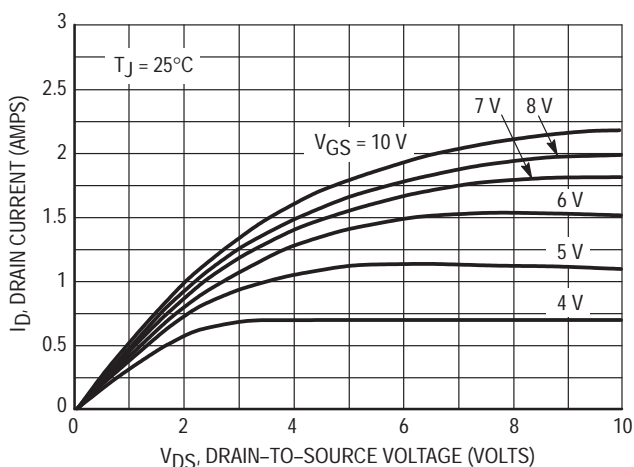


Figure 1. On-Region Characteristics

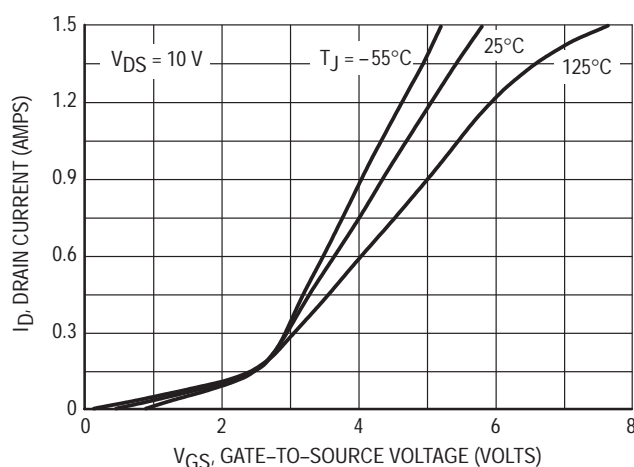


Figure 2. Transfer Characteristics

TYPICAL ELECTRICAL CHARACTERISTICS

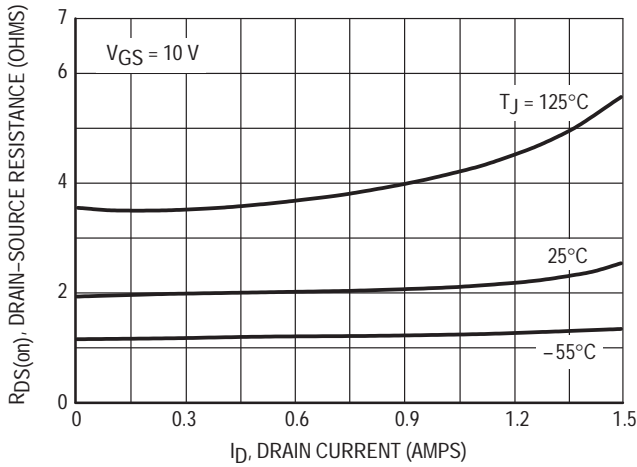


Figure 3. On-Resistance versus Drain Current

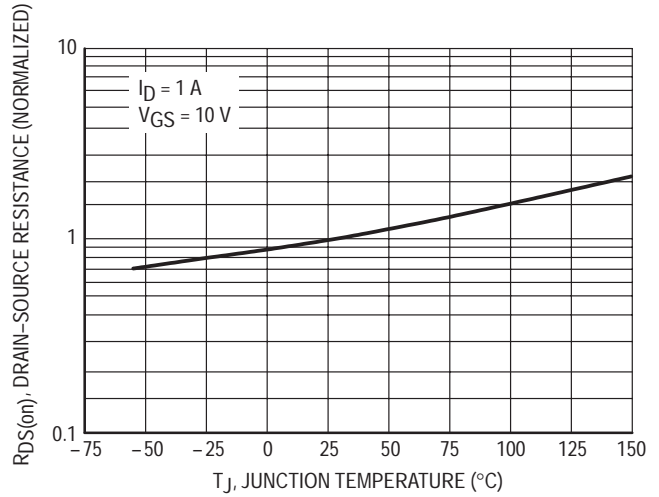


Figure 4. On-Resistance Variation with Temperature

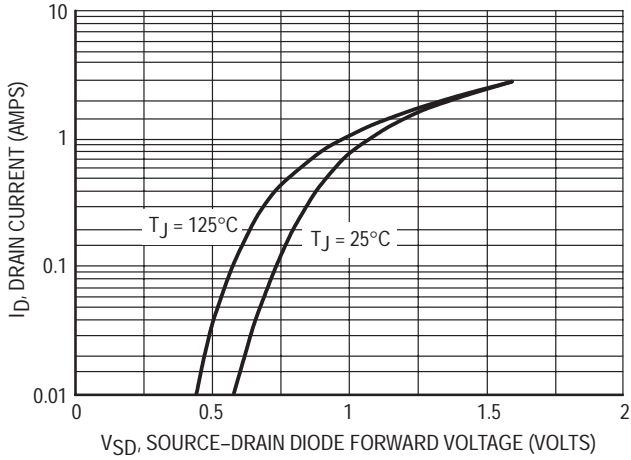


Figure 5. Source-Drain Diode Forward Voltage

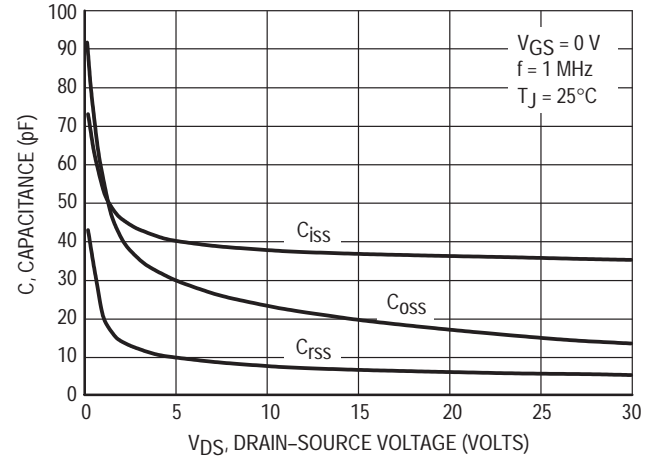


Figure 6. Capacitance versus Drain-Source Voltage

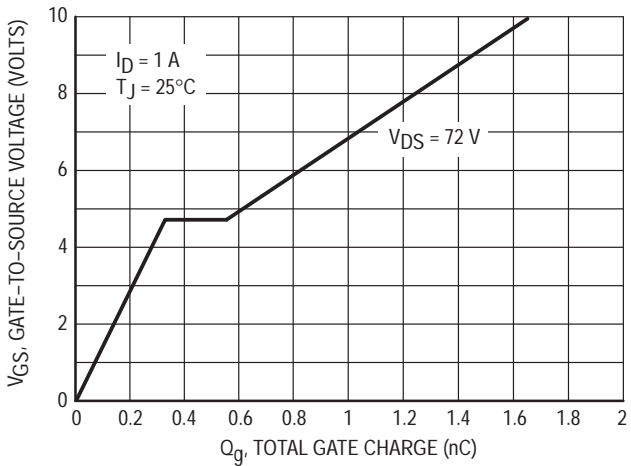


Figure 7. Gate Charge versus Gate-to-Source Voltage

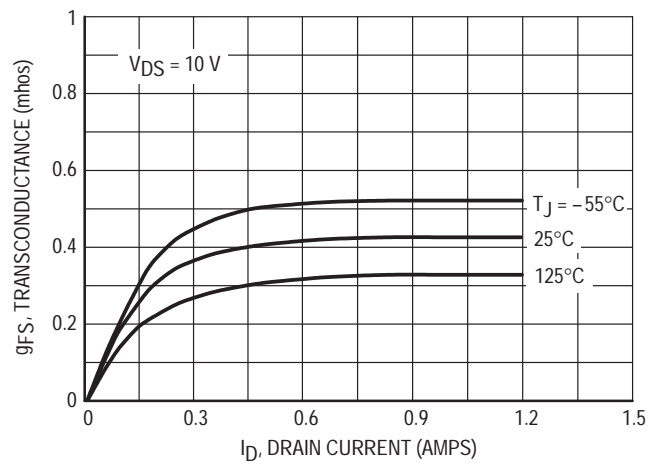
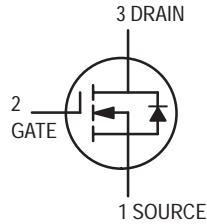


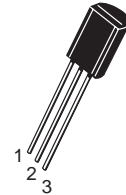
Figure 8. Transconductance

TMOS Switching

N-Channel — Enhancement



MPF910



CASE 29-05, STYLE 22
TO-92 (TO-226AE)

MAXIMUM RATINGS

Rating	Symbol	Value	Unit
Drain-Source Voltage	V_{DS}	60	Vdc
Gate-Source Voltage — Continuous — Non-repetitive ($t_p \leq 50 \mu s$)	V_{GS} V_{GSM}	± 20 ± 40	Vdc Vpk
Drain Current — Continuous ⁽¹⁾ — Pulsed ⁽²⁾	I_D I_{DM}	0.5 1.0	Adc
Total Device Dissipation @ $T_A = 25^\circ C$ Derate above $25^\circ C$ MPF910	P_D	1.0 8.0	Watts mW/ $^\circ C$
Total Device Dissipation @ $T_C = 25^\circ C$ Derate above $25^\circ C$ MFE910	P_D	6.25 50	Watts mW/ $^\circ C$
Operating and Storage Junction Temperature Range	T_J, T_{stg}	-65 to +150	$^\circ C$

ELECTRICAL CHARACTERISTICS ($T_A = 25^\circ C$ unless otherwise noted)

Characteristic	Symbol	Min	Typ	Max	Unit
----------------	--------	-----	-----	-----	------

OFF CHARACTERISTICS

Zero-Gate-Voltage Drain Current ($V_{DS} = 40 V, V_{GS} = 0$)	I_{DSS}	—	0.1	10	μA_{dc}
Gate Reverse Current ($V_{GS} = 10 V, V_{DS} = 0$)	I_{GSS}	—	0.01	10	nAdc
Drain-Source Breakdown Voltage ($V_{GS} = 0, I_D = 100 \mu A$)	$V_{(BR)DSS}$	60	90	—	Vdc

ON CHARACTERISTICS

Gate Threshold Voltage ($V_{DS} = V_{GS}, I_D = 1.0 mA$)	$V_{GS(th)}$	0.3	1.5	2.5	Vdc
Drain-Source On-Voltage ($V_{GS} = 10 V, I_D = 500 mA$)	$V_{DS(on)}$	—	—	2.5	Vdc
On-State Drain Current ($V_{DS} = 25 V, V_{GS} = 10 V$)	$I_{D(on)}$	500	—	—	mA
Forward Transconductance ($V_{DS} = 15 V, I_D = 500 mA$)	g_{fs}	100	—	—	mmhos

1. The Power Dissipation of the package may result in a lower continuous drain current.
2. Pulse Test: Pulse Width $\leq 300 \mu s$, Duty Cycle $\leq 2.0\%$.

RESISTIVE SWITCHING

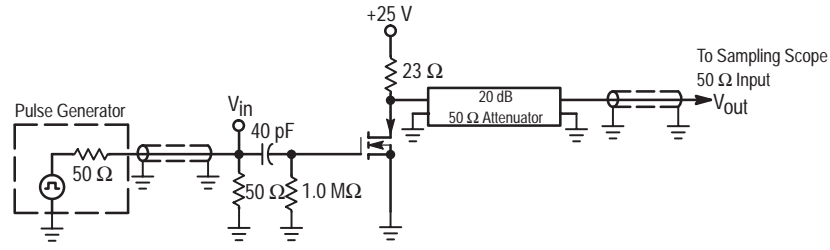


Figure 1. Switching Test Circuit

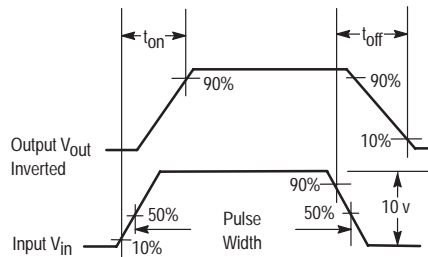


Figure 2. Switching Waveforms

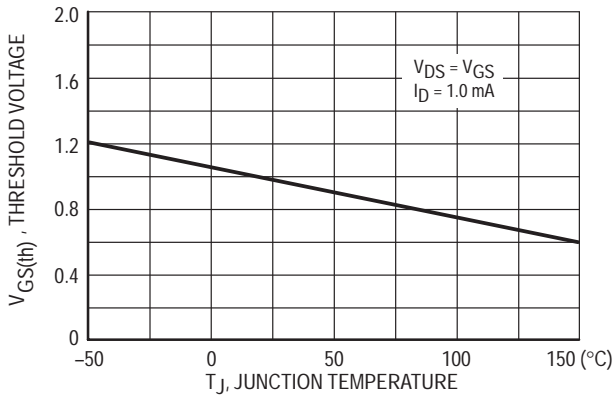


Figure 3. $V_{GS(th)}$ Normalized versus Temperature

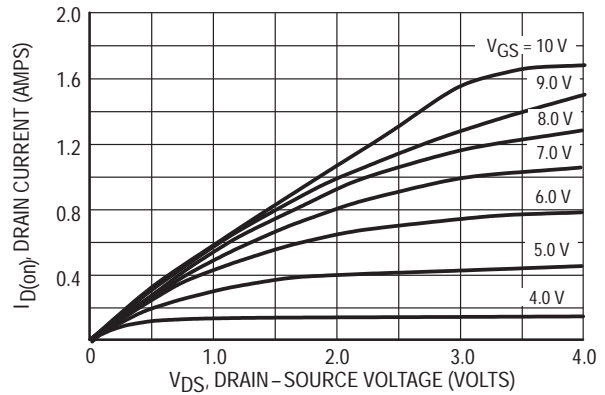


Figure 4. On-Region Characteristics

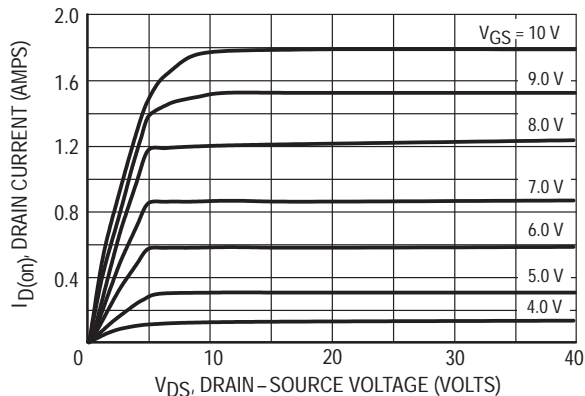


Figure 5. Output Characteristics

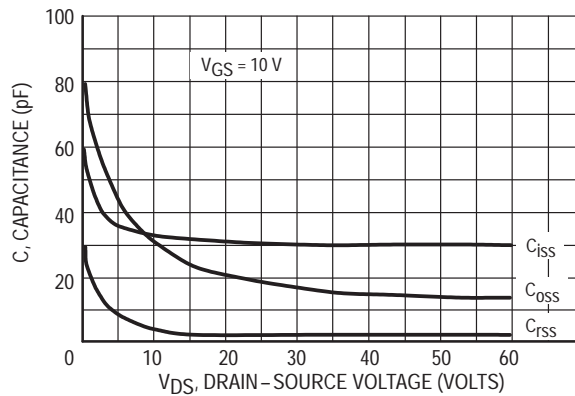


Figure 6. Capacitance versus Drain-to-Source Voltage

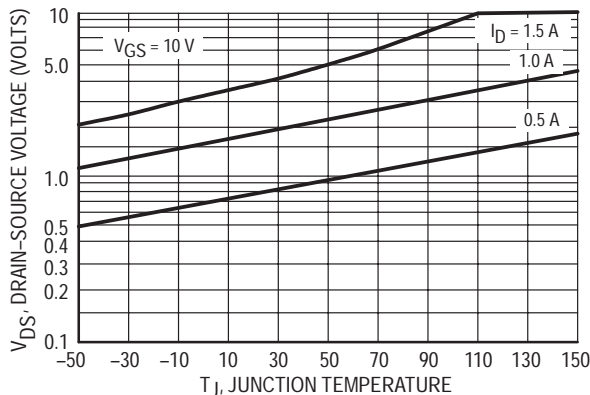
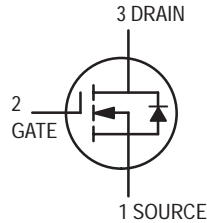


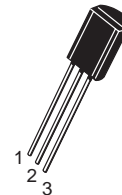
Figure 7. On Voltage versus Temperature

TMOS Switching

N-Channel — Enhancement



MPF930
MPF960
MPF990



CASE 29-05, STYLE 22
TO-92 (TO-226AE)

MAXIMUM RATINGS

Rating	Symbol	MPF930	MPF960	MPF990	Unit
Drain-Source Voltage	V_{DS}	35	60	90	Vdc
Drain-Gate Voltage	V_{DG}	35	60	90	Vdc
Gate-Source Voltage — Continuous — Non-repetitive ($t_p \leq 50 \mu s$)	V_{GS} V_{GSM}		± 20 ± 40		Vdc Vpk
Drain Current Continuous(1) Pulsed(2)	I_D I_{DM}		2.0 3.0		Adc
Total Device Dissipation @ $T_A = 25^\circ C$ Derate above $25^\circ C$	P_D		1.0 8.0		Watts mW/ $^\circ C$
Operating and Storage Junction Temperature Range	T_J, T_{stg}		-55 to 150		$^\circ C$
Thermal Resistance	θ_{JA}		125		$^\circ C/W$

ELECTRICAL CHARACTERISTICS ($T_A = 25^\circ C$ unless otherwise noted)

Characteristic	Symbol	Min	Typ	Max	Unit
----------------	--------	-----	-----	-----	------

OFF CHARACTERISTICS

Drain-Source Breakdown Voltage ($V_{GS} = 0, I_D = 10 \mu A_{dc}$)	$V_{(BR)DSX}$	35 60 90	— — —	— — —	Vdc
Gate Reverse Current ($V_{GS} = 15 V_{dc}, V_{DS} = 0$)	I_{GSS}	—	—	50	nAdc

ON CHARACTERISTICS(2)

Zero-Gate-Voltage Drain Current ($V_{DS} = \text{Maximum Rating}, V_{GS} = 0$)	I_{DSS}	—	—	10	μA_{dc}
Gate Threshold Voltage ($I_D = 1.0 \text{ mAdc}, V_{DS} = V_{GS}$)	$V_{GS(Th)}$	1.0	—	3.5	Vdc
Drain-Source On-Voltage ($V_{GS} = 10 V_{dc}$) ($I_D = 0.5 \text{ Adc}$)	$V_{DS(on)}$	MPF930 MPF960 MPF990	— — —	0.4 0.6 0.6	0.7 0.8 1.2
($I_D = 1.0 \text{ Adc}$)		MPF930 MPF960 MPF990	— — —	0.9 1.2 1.2	1.4 1.7 2.4
($I_D = 2.0 \text{ Adc}$)		MPF930 MPF960 MPF990	— — —	2.2 2.8 2.8	3.0 3.5 4.8

1. The Power Dissipation of the package may result in a lower continuous drain current.
2. Pulse Test: Pulse Width $\leq 300 \mu s$, Duty Cycle $\leq 2.0\%$.

ELECTRICAL CHARACTERISTICS ($T_A = 25^\circ\text{C}$ unless otherwise noted) (Continued)

Characteristic	Symbol	Min	Typ	Max	Unit
ON CHARACTERISTICS(2) (Continued)					
Static Drain–Source On Resistance ($V_{GS} = 10\text{ Vdc}$, $I_D = 1.0\text{ Adc}$)	$r_{DS(on)}$	—	0.9	1.4	Ω
	MPF930	—	1.2	1.7	
	MPF960	—	1.2	2.0	
On–State Drain Current ($V_{DS} = 25\text{ Vdc}$, $V_{GS} = 10\text{ Vdc}$)	$I_{D(on)}$	1.0	2.0	—	Amps

SMALL–SIGNAL CHARACTERISTICS

Input Capacitance ($V_{DS} = 25\text{ Vdc}$, $V_{GS} = 0$, $f = 1.0\text{ MHz}$)	C_{iss}	—	70	—	pF
Reverse Transfer Capacitance ($V_{DS} = 25\text{ Vdc}$, $V_{GS} = 0$, $f = 1.0\text{ MHz}$)	C_{rss}	—	20	—	pF
Output Capacitance ($V_{DS} = 25\text{ Vdc}$, $V_{GS} = 0$, $f = 1.0\text{ MHz}$)	C_{oss}	—	49	—	pF
Forward Transconductance ($V_{DS} = 25\text{ Vdc}$, $I_D = 0.5\text{ Adc}$)	g_{fs}	200	380	—	mmhos

SWITCHING CHARACTERISTICS

Turn–On Time	t_{on}	—	7.0	15	ns
Turn–Off Time	t_{off}	—	7.0	15	ns

2. Pulse Test: Pulse Width $\leq 300\ \mu\text{s}$, Duty Cycle $\leq 2.0\%$.

RESISTIVE SWITCHING

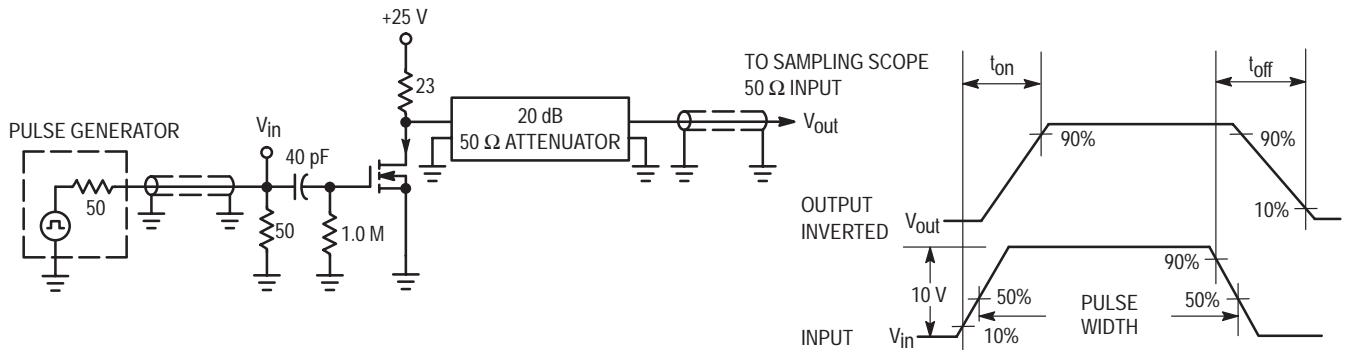


Figure 1. Switching Test Circuit

Figure 2. Switching Waveforms

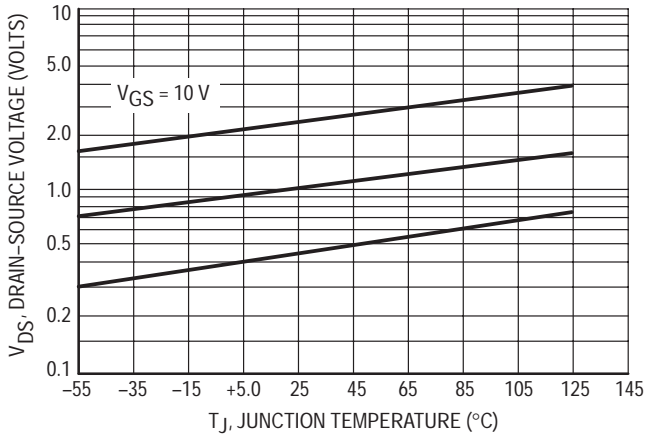


Figure 3. On Voltage versus Temperature

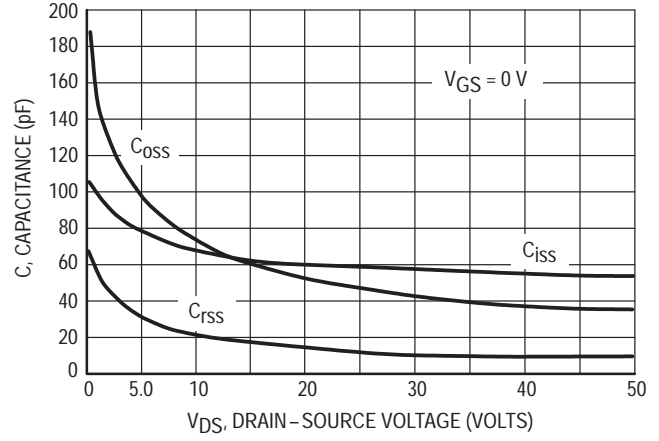


Figure 4. Capacitance Variation

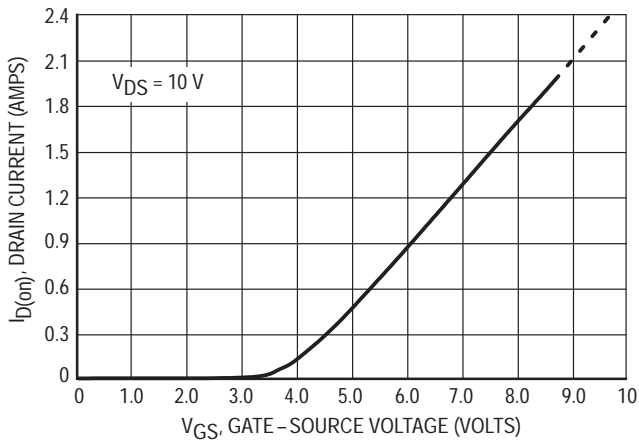


Figure 5. Transfer Characteristic

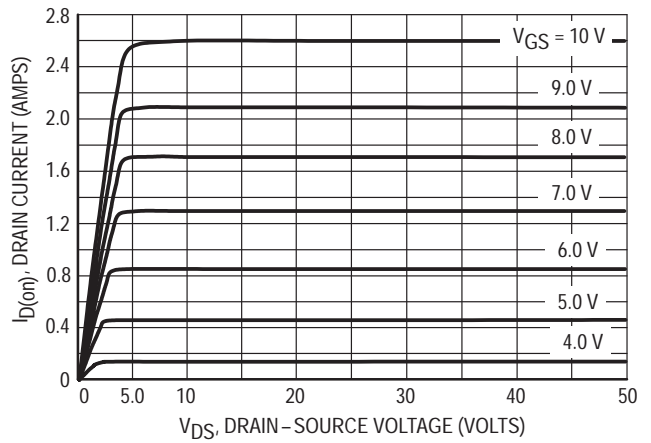


Figure 6. Output Characteristic

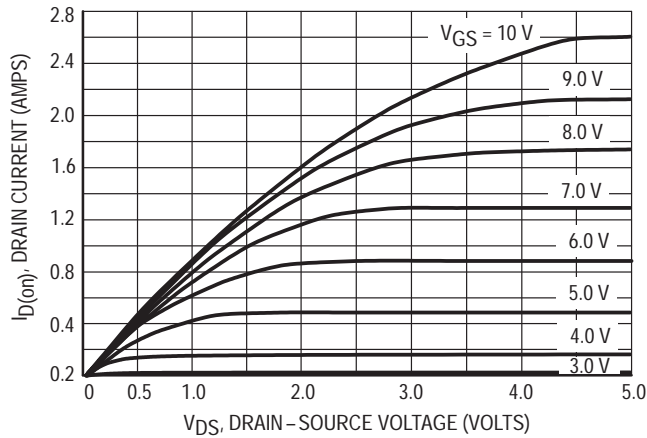
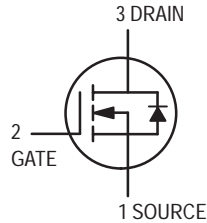


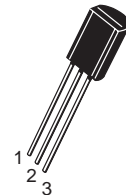
Figure 7. Saturation Characteristic

TMOS FET Transistors

N-Channel — Enhancement



MPF6659
MPF6660
MPF6661



CASE 29-05, STYLE 22
TO-92 (TO-226AE)

MAXIMUM RATINGS

Rating	Symbol	MPF6659	MPF6660	MPF6661	Unit
Drain-Source Voltage	V_{DS}	35	60	90	Vdc
Drain-Gate Voltage	V_{DG}	35	60	90	Vdc
Gate-Source Voltage — Continuous — Non-repetitive ($t_p \leq 50 \mu s$)	V_{GS} V_{GSM}		± 20 ± 40		Vdc Vpk
Drain Current Continuous(1) Pulsed(2)	I_D I_{DM}		2.0 3.0		Adc
Total Device Dissipation @ $T_C = 25^\circ C$ Derate above $25^\circ C$	P_D		2.5 20		Watts mW/ $^\circ C$
Total Device Dissipation @ $T_A = 25^\circ C$ Derate above $25^\circ C$	P_D		1.0 8.0		Watts mW/ $^\circ C$
Operating and Storage Junction Temperature Range	T_J, T_{stg}		-55 to +150		$^\circ C$

ELECTRICAL CHARACTERISTICS ($T_A = 25^\circ C$ unless otherwise noted)

Characteristic	Symbol	Min	Typ	Max	Unit
----------------	--------	-----	-----	-----	------

OFF CHARACTERISTICS

Zero-Gate-Voltage Drain Current ($V_{DS} = \text{Maximum Rating}, V_{GS} = 0$)	I_{DSS}	—	—	10	μA_{dc}
Gate-Body Leakage Current ($V_{GS} = 15 \text{ Vdc}, V_{DS} = 0$)	I_{GSS}	—	—	100	nAdc
Drain-Source Breakdown Voltage ($V_{GS} = 0, I_D = 10 \mu A_{dc}$)	$V_{(BR)DSX}$	MPF6659 35 MPF6660 60 MPF6661 90	— — —	— — —	Vdc

ON CHARACTERISTICS(2)

Gate Threshold Voltage ($V_{DS} = V_{GS}, I_D = 1.0 \text{ mA}_{dc}$)	$V_{GS(Th)}$	0.8	1.4	2.0	Vdc
Drain-Source On-Voltage ($V_{GS} = 10 \text{ Vdc}, I_D = 1.0 \text{ Adc}$)	$V_{DS(on)}$	MPF6659 — MPF6660 — MPF6661 —	— — —	1.8 3.0 4.0	Vdc
($V_{GS} = 5.0 \text{ Vdc}, I_D = 0.3 \text{ Adc}$)		MPF6659 — MPF6660 — MPF6661 —	0.8 — 0.9 — 0.9	1.5 1.5 1.6	

1. The Power Dissipation of the package may result in a lower continuous drain current.
2. Pulse Test: Pulse Width $\leq 300 \mu s$, Duty Cycle $\leq 2.0\%$.

MPF6659 MPF6660 MPF6661

ELECTRICAL CHARACTERISTICS ($T_A = 25^\circ\text{C}$ unless otherwise noted) (Continued)

Characteristic	Symbol	Min	Typ	Max	Unit
ON CHARACTERISTICS(2) (Continued)					
Static Drain–Source On Resistance ($V_{GS} = 10\text{ Vdc}$, $I_D = 1.0\text{ Adc}$)	$r_{DS(on)}$	—	—	1.8	Ω
				3.0	
				4.0	
On–State Drain Current ($V_{DS} = 25\text{ Vdc}$, $V_{GS} = 10\text{ Vdc}$)	$I_{D(on)}$	1.0	2.0	—	Amps

SMALL–SIGNAL CHARACTERISTICS

Input Capacitance ($V_{DS} = 25\text{ Vdc}$, $V_{GS} = 0$, $f = 1.0\text{ MHz}$)	C_{iss}	—	30	—	pF
Reverse Transfer Capacitance ($V_{DS} = 25\text{ Vdc}$, $V_{GS} = 0$, $f = 1.0\text{ MHz}$)	C_{rss}	—	3.6	—	pF
Output Capacitance ($V_{DS} = 25\text{ Vdc}$, $V_{GS} = 0$, $f = 1.0\text{ MHz}$)	C_{oss}	—	20	—	pF
Forward Transconductance ($V_{DS} = 25\text{ Vdc}$, $I_D = 0.5\text{ Adc}$)	g_{fs}	170	—	—	mmhos

SWITCHING CHARACTERISTICS(2)

Rise Time	t_r	—	—	5.0	ns
Fall Time	t_f	—	—	5.0	ns
Turn–On Time	t_{on}	—	—	5.0	ns
Turn–Off Time	t_{off}	—	—	5.0	ns

2. Pulse Test: Pulse Width $\leq 300\ \mu\text{s}$, Duty Cycle $\leq 2.0\%$.

RESISTIVE SWITCHING

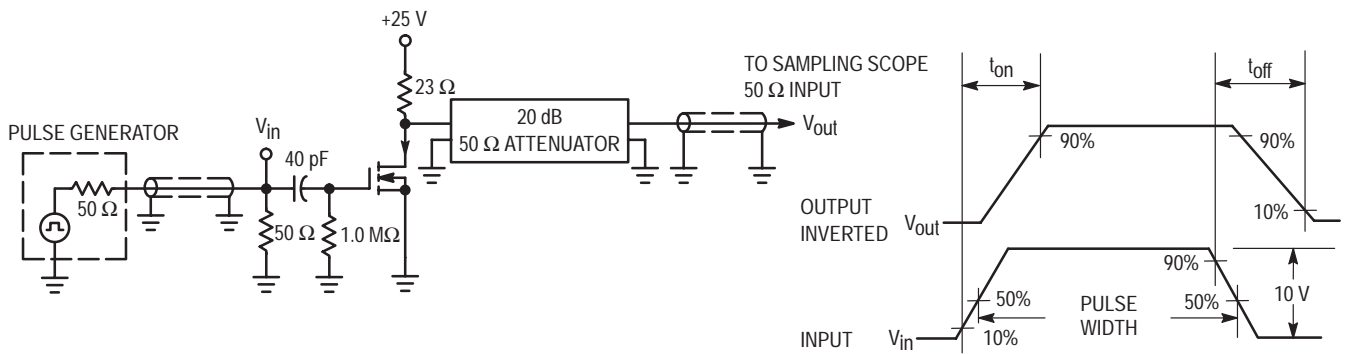


Figure 1. Switching Test Circuit

Figure 2. Switching Waveforms

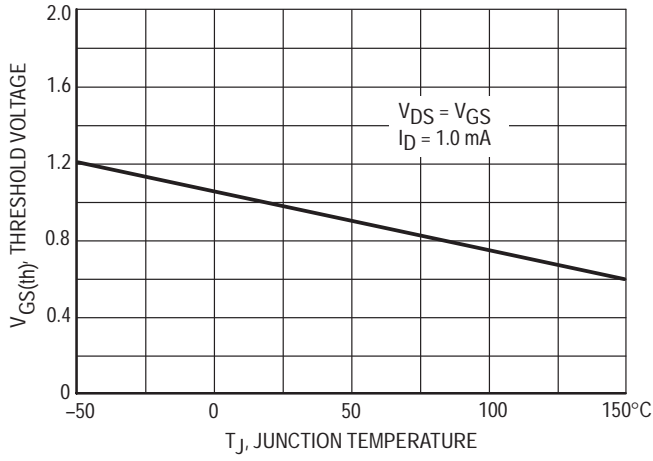


Figure 3. $V_{GS(th)}$ Normalized versus Temperature

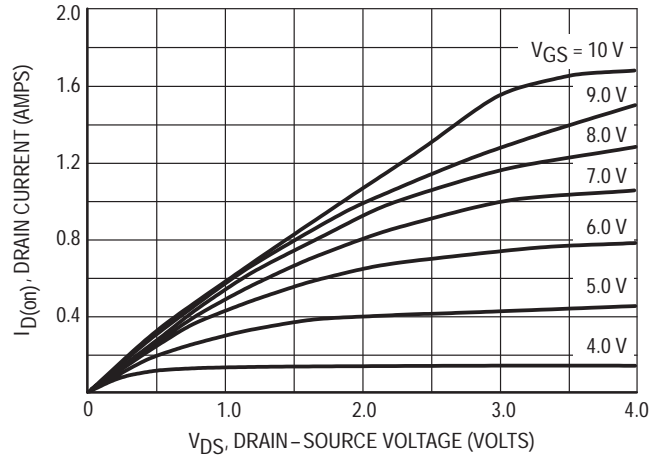


Figure 4. On-Region Characteristics

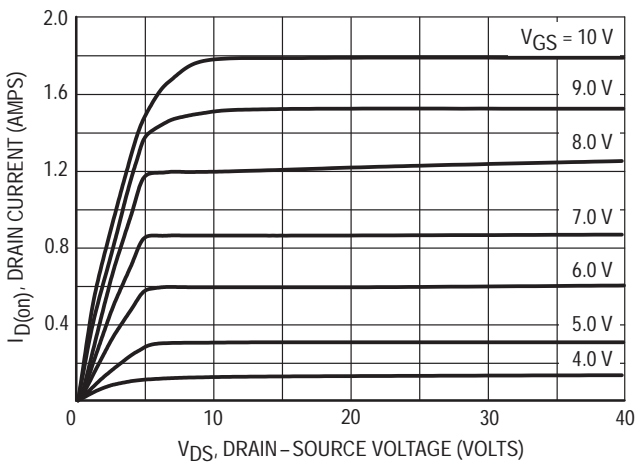


Figure 5. Output Characteristics

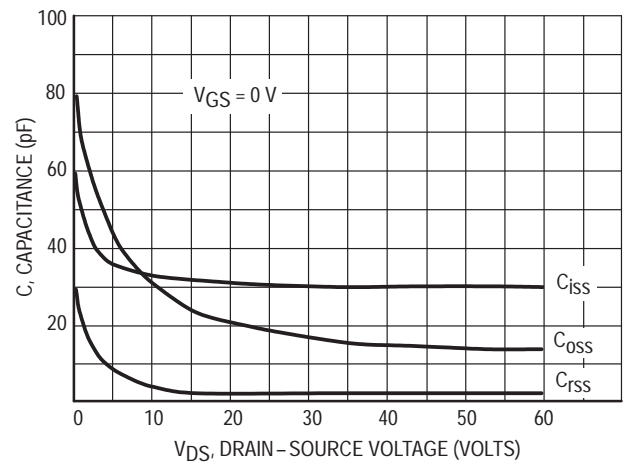


Figure 6. Capacitance versus Drain-To-Source Voltage

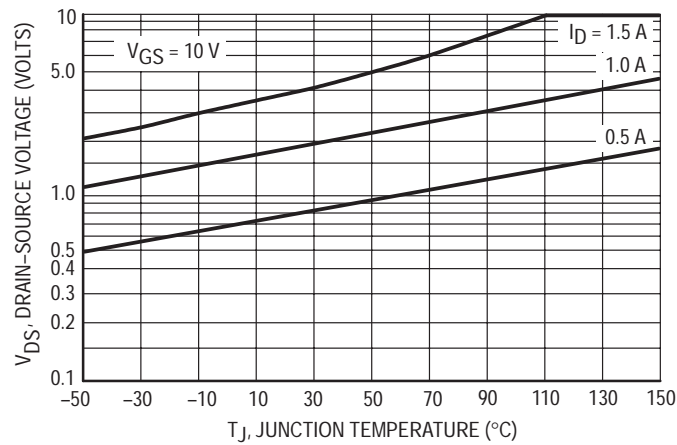
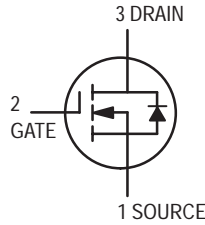


Figure 7. On-Voltage versus Temperature

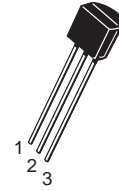
TMOS FET Transistor

N-Channel — Enhancement



VN0300L

Motorola Preferred Device



CASE 29-04, STYLE 22
TO-92 (TO-226AA)

MAXIMUM RATINGS

Rating	Symbol	Value	Unit
Drain-Source Voltage	V_{DSS}	60	V
Drain-Gate Voltage	V_{DGR}	60	V
Gate-Source Voltage - Continuous - Non-repetitive ($t_p \leq 50 \mu s$)	V_{GS} V_{GSM}	± 20 ± 40	Vdc Vpk
Continuous Drain Current	I_D	200	mA
Pulsed Drain Current	I_{DM}	500	mA
Power Dissipation @ $T_C = 25^\circ C$ Derate above $25^\circ C$	P_D	350 2.8	mW mW/ $^\circ C$
Operating and Storage Temperature	T_J, T_{stg}	—	$^\circ C$

THERMAL CHARACTERISTICS

Characteristics	Symbol	Max	Unit
Thermal Resistance, Junction to Ambient	$R_{\theta JA}$	312.5	$^\circ C/W$
Maximum Lead Temperature for Soldering Purposes, 1/16" from case for 10 seconds	T_L	300	$^\circ C$

ELECTRICAL CHARACTERISTICS ($T_A = 25^\circ C$ unless otherwise noted)

Characteristic	Symbol	Min	Max	Unit
----------------	--------	-----	-----	------

STATIC CHARACTERISTICS

Drain-Source Breakdown Voltage ($V_{DS} = 0, I_D = 10 \mu A$)	$V_{(BR)DSS}$	30	—	V
Zero Gate Voltage Drain Current ($V_{DS} = 48 V_{dc}, V_{GS} = 0$) ($V_{DS} = 48 V_{dc}, V_{GS} = 0, T_A = 125^\circ C$)	I_{DSS}	— —	10 500	μA
Gate-Body Leakage ($V_{DS} = 0, V_{GS} = \pm 30 V$)	I_{GSS}	—	± 100	nA
Gate Threshold Voltage ($V_{DS} = V_{GS}, I_D = 1.0 mA$)	$V_{GS(th)}$	0.8	2.5	V
On-State Drain Current ⁽¹⁾ ($V_{DS} = V_{GS}, I_D = 1.0 mA$)	$I_{D(on)}$	1.0	—	A
Drain-Source On Resistance ⁽¹⁾ ($V_{GS} = 5.0 V, I_D = 0.3 A$) ($V_{GS} = 10 V, I_D = 1.0 A$)	$r_{DS(on)}$	— —	3.3 1.2	Ω
Forward Transconductance ⁽¹⁾ ($V_{DS} = 10 V, I_D = 0.5 A$)	g_{fs}	200	—	mS

1. Pulse Test; Pulse Width $< 300 \mu s$, Duty Cycle $\leq 2.0\%$.

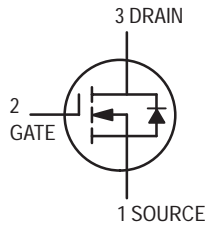
Preferred devices are Motorola recommended choices for future use and best overall value.

ELECTRICAL CHARACTERISTICS ($T_A = 25^\circ\text{C}$ unless otherwise noted) (Continued)

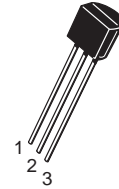
Characteristic	Symbol	Min	Max	Unit	
DYNAMIC CHARACTERISTICS					
Input Capacitance	$(V_{DS} = 15 \text{ Vdc}, V_{GS} = 0, f = 1.0 \text{ MHz})$	—	100	pF	
Output Capacitance					C_{iss}
Reverse Transfer Capacitance					C_{oss}
	C_{rss}	—	25	pF	
SWITCHING CHARACTERISTICS					
Turn-On Time	$(V_{DD} = 25 \text{ Vdc}, I_D = 1.0 \text{ A}, R_L = 24 \Omega, R_G = 25 \Omega)$	—	30	ns	
Turn-Off Time					t_{on}
	t_{off}	—	30	ns	

TMOS FET Transistor

N-Channel — Enhancement



VN0610LL



CASE 29-04, STYLE 22
TO-92 (TO-226AA)

MAXIMUM RATINGS

Rating	Symbol	Value	Unit
Drain-Source Voltage	V_{DSS}	60	Vdc
Drain-Gate Voltage ($R_{GS} = 1\text{ M}\Omega$)	V_{DGR}	60	Vdc
Gate-Source Voltage	V_{GS}	± 20	Vdc
— Continuous	V_{GSM}	± 40	Vpk
— Non-repetitive ($t_p \leq 50\ \mu\text{s}$)			
Drain Current	I_D	190	mAdc
— Continuous	I_{DM}	1000	
— Pulsed			
Total Power Dissipation @ $T_A = 25^\circ\text{C}$	P_D	400	mW
— Derate above 25°C		3.2	mW/ $^\circ\text{C}$
Operating and Storage Temperature Range	T_J, T_{stg}	-55 to +150	$^\circ\text{C}$

THERMAL CHARACTERISTICS

Characteristics	Symbol	Max	Unit
Thermal Resistance, Junction to Ambient	$R_{\theta JA}$	312.5	$^\circ\text{C}/\text{W}$
Maximum Lead Temperature for Soldering Purposes, 1/16" from case for 10 seconds	T_L	300	$^\circ\text{C}$

ELECTRICAL CHARACTERISTICS ($T_C = 25^\circ\text{C}$ unless otherwise noted)

Characteristic	Symbol	Min	Max	Unit
----------------	--------	-----	-----	------

OFF CHARACTERISTICS

Drain-Source Breakdown Voltage ($V_{GS} = 0, I_D = 100\ \mu\text{A}$)	$V_{(BR)DSS}$	60	—	Vdc
Zero Gate Voltage Drain Current ($V_{DS} = 48\ \text{Vdc}, V_{GS} = 0$) ($V_{DS} = 48\ \text{Vdc}, V_{GS} = 0, T_J = 125^\circ\text{C}$)	I_{DSS}	—	10 500	μAdc
Gate-Body Leakage Current, Forward ($V_{GSF} = 30\ \text{V}, V_{DS} = 0$)	I_{GSSF}	—	-100	nAdc

ON CHARACTERISTICS(1)

Gate Threshold Voltage ($V_{DS} = V_{GS}, I_D = 1.0\ \text{mA}$)	$V_{GS(th)}$	0.8	2.5	Vdc
Static Drain-Source On-Resistance ($V_{GS} = 10\ \text{V}, I_D = 500\ \text{mA}$) ($V_{GS} = 10\ \text{V}, I_D = 500\ \text{mA}, T_C = 125^\circ\text{C}$)	$r_{DS(on)}$	—	5.0 9.0	Ω
Drain-Source On-Voltage ($V_{GS} = 5.0\ \text{V}, I_D = 200\ \text{mA}$) ($V_{GS} = 10\ \text{V}, I_D = 500\ \text{mA}$)	$V_{DS(on)}$	—	1.5 2.5	Vdc
On-State Drain Current ($V_{GS} = 10\ \text{V}, V_{DS} \geq 2.0\ V_{DS(on)}$)	$I_{D(on)}$	750	—	mAdc
Forward Transconductance ($V_{DS} \geq 2.0\ V_{DS(on)}, I_D = 500\ \text{mA}$)	g_{fs}	100	—	μmhos

1. Pulse Test: Pulse Width $\leq 300\ \mu\text{s}$, Duty Cycle $\leq 2.0\%$.

ELECTRICAL CHARACTERISTICS ($T_A = 25^\circ\text{C}$ unless otherwise noted) (Continued)

Characteristic	Symbol	Min	Max	Unit	
DYNAMIC CHARACTERISTICS					
Input Capacitance	$(V_{DS} = 25 \text{ Vdc}, V_{GS} = 0, f = 1.0 \text{ MHz})$	—	60	pF	
Output Capacitance					C_{iss}
Reverse Transfer Capacitance					C_{oss}
	C_{rss}	—	5.0		
SWITCHING CHARACTERISTICS(1)					
Turn-On Delay Time	$(V_{DD} = 15 \text{ Vdc}, I_D = 600 \text{ mA}, R_{gen} = 25 \Omega, R_L = 23 \Omega)$	—	10	ns	
Turn-Off Delay Time					t_{on}
	t_{off}	—	10		

1. Pulse Test: Pulse Width $\leq 300 \text{ ms}$, Duty Cycle $\leq 10\%$.

RESISTIVE SWITCHING

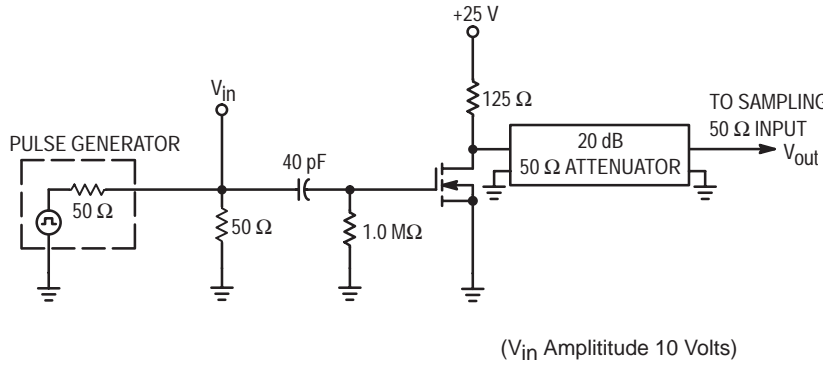


Figure 1. Switching Test Circuit

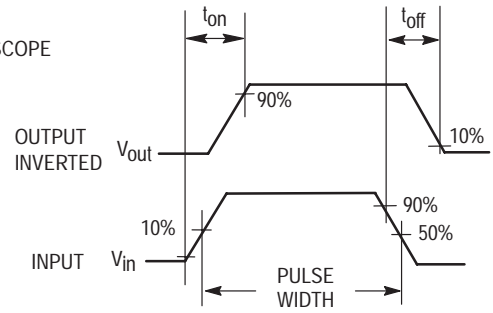


Figure 2. Switching Waveforms

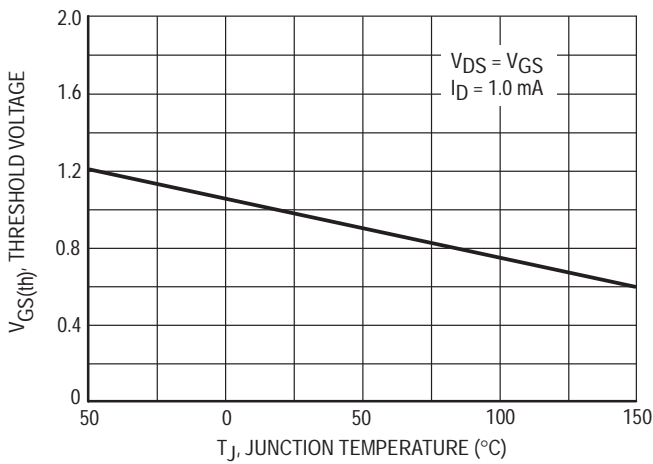


Figure 3. $V_{GS(th)}$ Normalized versus Temperature

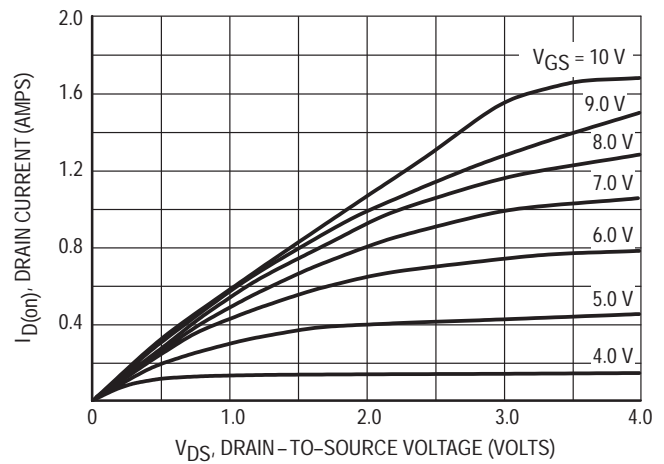


Figure 4. On-Region Characteristics

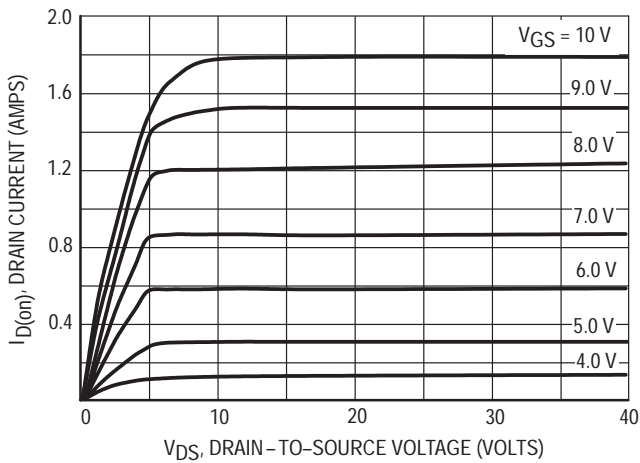


Figure 5. Output Characteristics

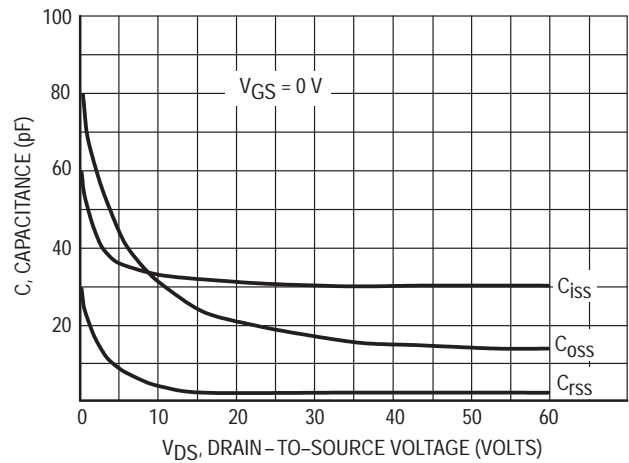
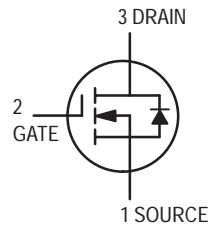


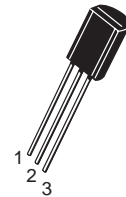
Figure 6. Capacitance versus Drain-To-Source Voltage

TMOS FET Transistor

N-Channel — Enhancement



VN10LM



CASE 29-05, STYLE 22
TO-92 (TO-226AE)

MAXIMUM RATINGS

Rating	Symbol	Value	Unit
Drain-Source Voltage	V_{DSS}	60	Vdc
Gate-Source Voltage — Continuous — Non-repetitive ($t_p \leq 50 \mu s$)	V_{GS} V_{GSM}	± 20 ± 40	Vdc Vpk
Drain Current — Continuous ⁽¹⁾ — Pulsed ⁽²⁾	I_D I_{DM}	0.3 1.0	Adc
Total Device Dissipation @ $T_A = 25^\circ C$ Derate above $25^\circ C$	P_D	1.0 8.0	Watts mW/ $^\circ C$
Operating and Storage Temperature Range	T_J, T_{stg}	-40 to +150	$^\circ C$

ELECTRICAL CHARACTERISTICS ($T_A = 25^\circ C$ unless otherwise noted)

Characteristic	Symbol	Min	Typ	Max	Unit
----------------	--------	-----	-----	-----	------

OFF CHARACTERISTICS

Drain-Source Breakdown Voltage ($V_{GS} = 0, I_D = 100 \mu A$)	$V_{(BR)DSS}$	60	—	—	Vdc
Zero-Gate-Voltage Drain Current ($V_{DS} = 45 V, V_{GS} = 0$)	I_{DSS}	—	0.1	10	μA_{dc}
Gate-Body Leakage Current ($V_{GS} = -15 V, V_{DS} = 0$)	I_{GSS}^1	—	—	100	nAdc
Gate-Body Leakage Current ($V_{GS} = 15 V, V_{DS} = 0$)	I_{GSS}^2	—	—	-100	nAdc

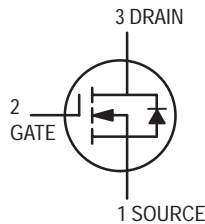
1. The Power Dissipation of the package may result in a lower continuous drain current.
2. Pulse Width $\leq 300 \mu s$, Duty Cycle.

VN10LM**ELECTRICAL CHARACTERISTICS** ($T_A = 25^\circ\text{C}$ unless otherwise noted) (Continued)

Characteristic	Symbol	Min	Typ	Max	Unit
ON CHARACTERISTICS					
Gate Threshold Voltage ($V_{DS} = V_{GS}$, $I_D = 1.0\text{ mA}$)	$V_{GS(th)}$	0.8	—	2.5	Vdc
On-State Drain Current ($V_{DS} = 15\text{ V}$, $V_{GS} = 10\text{ V}$)	$I_{D(on)}$	750	—	—	mA
Forward Transconductance ($V_{DS} = 15\text{ V}$, $I_D = 500\text{ mA}$)	g_{fs}	200	—	—	mmhos
Drain-Source On-Voltage ($V_{GS} = 5.0\text{ V}$, $I_D = 200\text{ mA}$)	$V_{DS(on)}^1$	—	—	1.5	Vdc
Drain-Source On-Voltage ($V_{GS} = 10\text{ V}$, $I_D = 500\text{ mA}$)	$V_{DS(on)}^2$	—	—	2.5	Vdc
Drain-Source On-Resistance ($V_{GS} = 5.0\text{ V}$, $I_D = 200\text{ mA}$)	$r_{DS(on)}^1$	—	—	7.5	Ω
Drain-Source On-Resistance ($V_{GS} = 10\text{ V}$, $I_D = 500\text{ mA}$)	$r_{DS(on)}^2$	—	—	5.0	Ω
Input Capacitance ($V_{DS} = 25\text{ V}$, $V_{GS} = 0$, $f = 1.0\text{ MHz}$)	C_{iss}	—	—	60	pF
Output Capacitance ($V_{DS} = 25\text{ V}$, $V_{GS} = 0$, $f = 1.0\text{ MHz}$)	C_{oss}	—	—	25	pF
Reverse Transfer Capacitance ($V_{DS} = 25\text{ V}$, $V_{GS} = 0$, $f = 1.0\text{ MHz}$)	C_{rss}	—	—	5.0	pF
Turn-On Time ($V_{DS} = 15\text{ V}$, $R_L = 23\ \Omega$, $R_G = 50\ \Omega$, $V_{in} = 20\text{ V}$)	t_{on}	—	—	10	ns
Turn-Off Time ($V_{DS} = 15\text{ V}$, $R_L = 23\ \Omega$, $R_G = 50\ \Omega$, $V_{in} = 20\text{ V}$)	t_{off}	—	—	10	ns

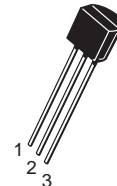
TMOS FET Transistor

N-Channel — Enhancement



VN2222LL

Motorola Preferred Device



CASE 29-04, STYLE 22
TO-92 (TO-226AA)

MAXIMUM RATINGS

Rating	Symbol	Value	Unit
Drain-Source Voltage	V_{DSS}	60	Vdc
Drain-Gate Voltage ($R_{GS} = 1.0\text{ M}\Omega$)	V_{DGR}	60	Vdc
Gate-Source Voltage	V_{GS}	± 20	Vdc
— Continuous	V_{GSM}	± 40	Vpk
— Non-repetitive ($t_p \leq 50\ \mu\text{s}$)			
Drain Current			mAdc
Continuous	I_D	150	
Pulsed	I_{DM}	1000	
Total Power Dissipation @ $T_A = 25^\circ\text{C}$	P_D	400	mW
Derate above 25°C		3.2	mW/ $^\circ\text{C}$
Operating and Storage Temperature Range	T_J, T_{stg}	-55 to +150	$^\circ\text{C}$

THERMAL CHARACTERISTICS

Characteristic	Symbol	Max	Unit
Thermal Resistance, Junction to Ambient	$R_{\theta JA}$	312.5	$^\circ\text{C}/\text{W}$
Maximum Lead Temperature for Soldering Purposes, 1/16" from case for 10 seconds	T_L	300	$^\circ\text{C}$

ELECTRICAL CHARACTERISTICS ($T_C = 25^\circ\text{C}$ unless otherwise noted)

Characteristic	Symbol	Min	Max	Unit
----------------	--------	-----	-----	------

OFF CHARACTERISTICS

Drain-Source Breakdown Voltage ($V_{GS} = 0, I_D = 100\ \mu\text{Adc}$)	$V_{(BR)DSS}$	60	—	Vdc
Zero Gate Voltage Drain Current ($V_{DS} = 48\ \text{Vdc}, V_{GS} = 0$) ($V_{DS} = 48\ \text{Vdc}, V_{GS} = 0, T_J = 125^\circ\text{C}$)	I_{DSS}	—	10 500	μAdc
Gate-Body Leakage Current, Forward ($V_{GSSF} = 30\ \text{Vdc}, V_{DS} = 0$)	I_{GSSF}	—	-100	nAdc

ON CHARACTERISTICS(1)

Gate Threshold Voltage ($V_{DS} = V_{GS}, I_D = 1.0\ \text{mAdc}$)	$V_{GS(th)}$	0.6	2.5	Vdc
Static Drain-Source On-Resistance ($V_{GS} = 10\ \text{Vdc}, I_D = 0.5\ \text{Adc}$) ($V_{GS} = 10\ \text{Vdc}, I_D = 0.5\ \text{Vdc}, T_C = 125^\circ\text{C}$)	$r_{DS(on)}$	—	7.5 13.5	Ω

1. Pulse Test: Pulse Width $\leq 300\ \mu\text{s}$, Duty Cycle $\leq 2.0\%$.

Preferred devices are Motorola recommended choices for future use and best overall value.

REV 1

ELECTRICAL CHARACTERISTICS ($T_C = 25^\circ\text{C}$ unless otherwise noted) (Continued)

Characteristic	Symbol	Min	Max	Unit
ON CHARACTERISTICS(1) (Continued)				
Drain–Source On–Voltage ($V_{GS} = 5.0\text{ Vdc}$, $I_D = 200\text{ mAdc}$) ($V_{GS} = 10\text{ Vdc}$, $I_D = 500\text{ mAdc}$)	$V_{DS(on)}$	— —	1.5 3.75	Vdc
On–State Drain Current ($V_{GS} = 10\text{ Vdc}$, $V_{DS} \geq 2.0\text{ V}_{DS(on)}$)	$I_{D(on)}$	750	—	mA
Forward Transconductance ($V_{DS} = 10\text{ Vdc}$, $I_D = 500\text{ mAdc}$)	g_{fs}	100	—	μmhos

DYNAMIC CHARACTERISTICS

Input Capacitance	$(V_{DS} = 25\text{ Vdc}$, $V_{GS} = 0$, $f = 1.0\text{ MHz}$)	C_{iss}	—	60	pF
Output Capacitance		C_{oss}	—	25	
Reverse Transfer Capacitance		C_{rss}	—	5.0	

SWITCHING CHARACTERISTICS(1)

Turn–On Delay Time	$(V_{DD} = 15\text{ Vdc}$, $I_D = 600\text{ mA}$, $R_{gen} = 25\ \Omega$, $R_L = 23\ \Omega$)	t_{on}	—	10	ns
Turn–Off Delay Time		t_{off}	—	10	

1. Pulse Test: Pulse Width $\leq 300\ \mu\text{s}$, Duty Cycle $\leq 2.0\%$.

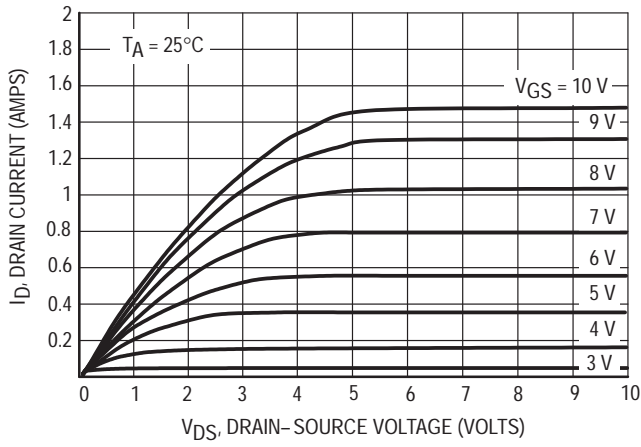


Figure 1. Ohmic Region

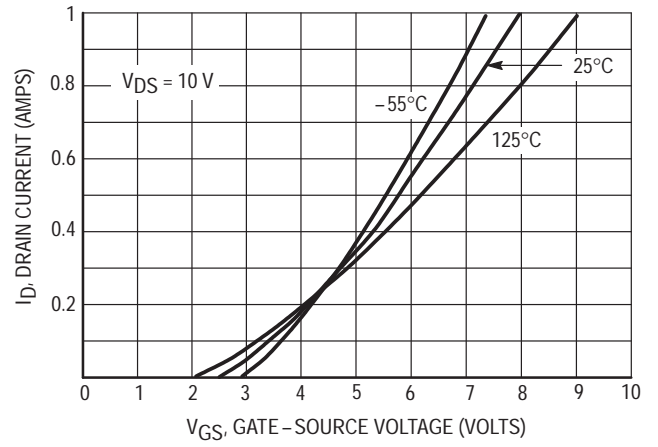


Figure 2. Transfer Characteristics

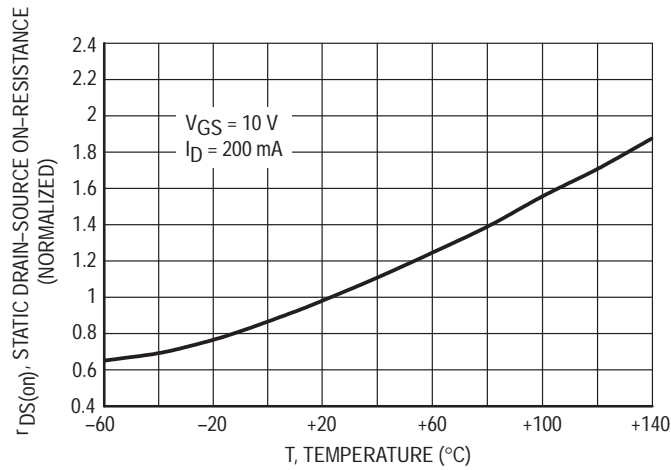


Figure 3. Temperature versus Static Drain-Source On-Resistance

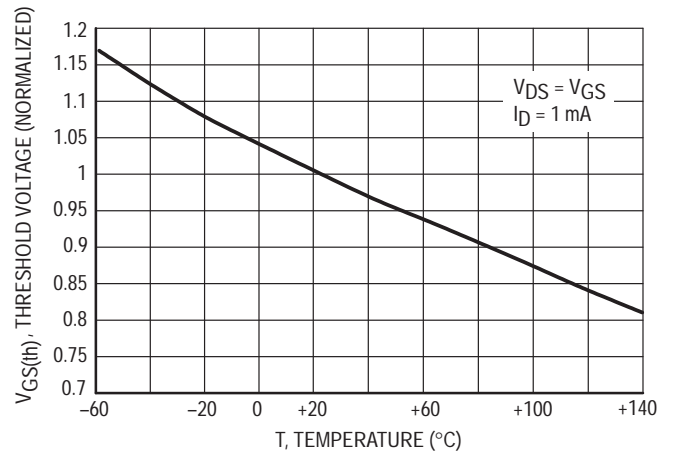
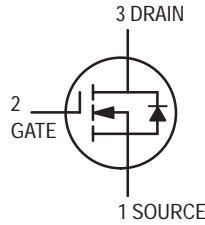


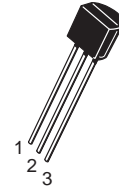
Figure 4. Temperature versus Gate Threshold Voltage

TMOS FET Transistor
N-Channel — Enhancement



VN2406L

Motorola Preferred Device



CASE 29-04, STYLE 22
TO-92 (TO-226AA)

MAXIMUM RATINGS

Rating	Symbol	Value	Unit
Drain-Source Voltage	V_{DSS}	240	Vdc
Drain-Gate Voltage	V_{DGR}	60	Vdc
Gate-Source Voltage - Continuous - Non-repetitive ($t_p \leq 50 \mu s$)	V_{GS} V_{GSM}	± 20 ± 40	Vdc Vpk
Continuous Drain Current	I_D	200	mAdc
Pulsed Drain Current	I_{DM}	500	mAdc
Power Dissipation @ $T_C = 25^\circ C$ Derate above $25^\circ C$	P_D	350 2.8	mW mW/ $^\circ C$
Operating and Storage Temperature	T_J, T_{stg}	—	$^\circ C$

THERMAL CHARACTERISTICS

Characteristic	Symbol	Max	Unit
Thermal Resistance, Junction to Ambient	$R_{\theta JA}$	312.5	$^\circ C/W$
Maximum Lead Temperature for Soldering Purposes, 1/16" from case for 10 seconds	T_L	300	$^\circ C$

ELECTRICAL CHARACTERISTICS ($T_A = 25^\circ C$ unless otherwise noted)

Characteristic	Symbol	Min	Max	Unit
----------------	--------	-----	-----	------

STATIC CHARACTERISTICS

Drain-Source Breakdown Voltage ($V_{GS} = 0, I_D = 100 \mu A$)	$V_{(BR)DSS}$	240	—	Vdc
Zero Gate Voltage Drain Current ($V_{DS} = 120 Vdc, V_{GS} = 0$) ($V_{DS} = 120 Vdc, V_{GS} = 0, T_A = 125^\circ C$)	I_{DSS}	— —	10 500	μAdc
Gate-Body Leakage ($V_{DS} = 0, V_{GS} = \pm 15 V$)	I_{GSS}	—	± 100	nAdc
Gate Threshold Voltage ($V_{DS} = V_{GS}, I_D = 1.0 mA$)	$V_{GS(th)}$	0.8	2.0	Vdc
On-State Drain Current ⁽¹⁾ ($V_{GS} = 10 V, V_{DS} \geq 2.0 V_{DS(on)}$)	$I_{D(on)}$	1.0	—	Adc
Drain-Source On Resistance ⁽¹⁾ ($V_{GS} = 2.5 V, I_D = 0.1 A$) ($V_{GS} = 10 V, I_D = 0.5 A$)	$r_{DS(on)}$	— —	10 6.0	Ω
Forward Transconductance ⁽¹⁾ ($V_{DS} = 10 V, I_D = 0.5 A$)	g_{fs}	300	—	mS

1. Pulse Test; Pulse Width < 300 μs , Duty Cycle $\leq 2.0\%$.

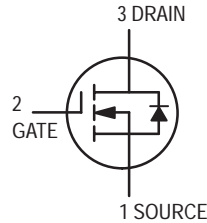
Preferred devices are Motorola recommended choices for future use and best overall value.

ELECTRICAL CHARACTERISTICS ($T_A = 25^\circ\text{C}$ unless otherwise noted) (Continued)

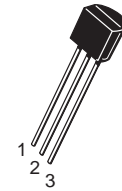
Characteristic	Symbol	Min	Max	Unit	
DYNAMIC CHARACTERISTICS					
Input Capacitance	$(V_{DS} = 25 \text{ Vdc}, V_{GS} = 0, f = 1.0 \text{ MHz})$	C_{iss}	—	125	pF
Output Capacitance		C_{oss}	—	50	pF
Reverse Transfer Capacitance		C_{rss}	—	20	pF
SWITCHING CHARACTERISTICS					
Turn-On Time	$(V_{DD} = 60 \text{ Vdc}, I_D = 0.4 \text{ A}, R_L = 150 \Omega, R_G = 25 \Omega)$	$t_{(on)}$	—	8.0	ns
		$t_{(r)}$	—	8.0	ns
Turn-Off Time		$t_{(off)}$	—	23	ns
		$t_{(f)}$	—	34	ns

TMOS FET Transistor

N-Channel — Enhancement



VN2410L



CASE 29-04, STYLE 22
TO-92 (TO-226AA)

MAXIMUM RATINGS

Rating	Symbol	Value	Unit
Drain-Source Voltage	V_{DSS}	240	Vdc
Drain-Gate Voltage	V_{DGR}	60	Vdc
Gate-Source Voltage - Continuous - Non-repetitive ($t_p \leq 50 \mu s$)	V_{GS} V_{GSM}	± 20 ± 40	Vdc Vpk
Continuous Drain Current	I_D	200	mAdc
Pulsed Drain Current	I_{DM}	500	mAdc
Power Dissipation @ $T_C = 25^\circ C$ Derate above $25^\circ C$	P_D	350 2.8	mW mW/ $^\circ C$
Operating and Storage Temperature	T_J, T_{stg}	—	$^\circ C$

THERMAL CHARACTERISTICS

Characteristic	Symbol	Max	Unit
Thermal Resistance, Junction to Ambient	$R_{\theta JA}$	312.5	$^\circ C/W$
Maximum Lead Temperature for Soldering Purposes, 1/16" from case for 10 seconds	T_L	300	$^\circ C$

ELECTRICAL CHARACTERISTICS ($T_A = 25^\circ C$ unless otherwise noted)

Characteristic	Symbol	Min	Max	Unit
----------------	--------	-----	-----	------

STATIC CHARACTERISTICS

Drain-Source Breakdown Voltage ($V_{GS} = 0, I_D = 100 \mu A$)	$V_{(BR)DSS}$	240	—	Vdc
Zero Gate Voltage Drain Current ($V_{DS} = 120 Vdc, V_{GS} = 0$) ($V_{DS} = 120 Vdc, V_{GS} = 0, T_A = 125^\circ C$)	I_{DSS}	— —	10 500	μAdc
Gate-Body Leakage ($V_{DS} = 0, V_{GS} = \pm 15 V$)	I_{GSS}	—	± 100	nAdc
Gate Threshold Voltage ($V_{DS} = V_{GS}, I_D = 1.0 mA$)	$V_{GS(th)}$	0.8	2.0	Vdc
On-State Drain Current ⁽¹⁾ ($V_{GS} = 10 V, V_{DS} \geq 2.0 V_{DS(on)}$)	$I_{D(on)}$	1.0	—	Adc
Drain-Source On Resistance ⁽¹⁾ ($V_{GS} = 2.5 V, I_D = 0.1 A$) ($V_{GS} = 10 V, I_D = 0.5 A$)	$r_{DS(on)}$	— —	10 10	Ω
Forward Transconductance ⁽¹⁾ ($V_{DS} = 10 V, I_D = 0.5 A$)	g_{fs}	300	—	mS

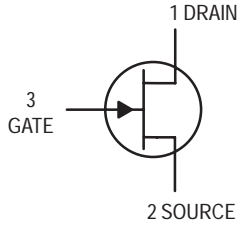
1. Pulse Test; Pulse Width $< 300 \mu s$, Duty Cycle $\leq 2.0\%$.

ELECTRICAL CHARACTERISTICS ($T_A = 25^\circ\text{C}$ unless otherwise noted) (Continued)

Characteristic		Symbol	Min	Max	Unit
DYNAMIC CHARACTERISTICS					
Input Capacitance	(V _{DS} = 25 Vdc, V _{GS} = 0, f = 1.0 MHz)	C _{iss}	—	125	pF
Output Capacitance		C _{oss}	—	50	pF
Reverse Transfer Capacitance		C _{rss}	—	20	pF
SWITCHING CHARACTERISTICS					
Turn-On Time	(V _{DD} = 60 Vdc, I _D = 0.4 A, R _L = 150 Ω , R _G = 25 Ω)	t _(on)	—	8.0	ns
		t _(r)	—	8.0	ns
Turn-Off Time		t _(off)	—	23	ns
		t _(f)	—	34	ns

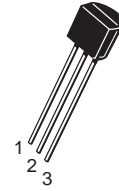
JFETs — General Purpose

N-Channel — Depletion



2N5457

*Motorola Preferred Device



CASE 29-04, STYLE 5
TO-92 (TO-226AA)

MAXIMUM RATINGS

Rating	Symbol	Value	Unit
Drain-Source Voltage	V_{DS}	25	Vdc
Drain-Gate Voltage	V_{DG}	25	Vdc
Reverse Gate-Source Voltage	V_{GSR}	-25	Vdc
Gate Current	I_G	10	mAdc
Total Device Dissipation @ $T_A = 25^\circ\text{C}$ Derate above 25°C	P_D	310 2.82	mW mW/ $^\circ\text{C}$
Junction Temperature Range	T_J	125	$^\circ\text{C}$
Storage Channel Temperature Range	T_{stg}	-65 to +150	$^\circ\text{C}$

ELECTRICAL CHARACTERISTICS ($T_A = 25^\circ\text{C}$ unless otherwise noted)

Characteristic	Symbol	Min	Typ	Max	Unit
----------------	--------	-----	-----	-----	------

OFF CHARACTERISTICS

Gate-Source Breakdown Voltage ($I_G = -10 \mu\text{Adc}$, $V_{DS} = 0$)	$V_{(BR)GSS}$	-25	—	—	Vdc
Gate Reverse Current ($V_{GS} = -15 \text{Vdc}$, $V_{DS} = 0$) ($V_{GS} = -15 \text{Vdc}$, $V_{DS} = 0$, $T_A = 100^\circ\text{C}$)	I_{GSS}	—	—	-1.0 -200	nAdc
Gate-Source Cutoff Voltage ($V_{DS} = 15 \text{Vdc}$, $I_D = 10 \text{nAdc}$)	$V_{GS(off)}$	-0.5	—	-6.0	Vdc
Gate-Source Voltage ($V_{DS} = 15 \text{Vdc}$, $I_D = 100 \mu\text{Adc}$)	V_{GS}	—	-2.5	—	Vdc

ON CHARACTERISTICS

Zero-Gate-Voltage Drain Current (1) ($V_{DS} = 15 \text{Vdc}$, $V_{GS} = 0$)	I_{DSS}	1.0	3.0	5.0	mAdc
------------------------------------------------------------------------------------	-----------	-----	-----	-----	------

SMALL-SIGNAL CHARACTERISTICS

Forward Transfer Admittance Common Source (1) ($V_{DS} = 15 \text{Vdc}$, $V_{GS} = 0$, $f = 1.0 \text{kHz}$)	$ y_{fs} $	1000	—	5000	μmhos
Output Admittance Common Source (1) ($V_{DS} = 15 \text{Vdc}$, $V_{GS} = 0$, $f = 1.0 \text{kHz}$)	$ y_{os} $	—	10	50	μmhos
Input Capacitance ($V_{DS} = 15 \text{Vdc}$, $V_{GS} = 0$, $f = 1.0 \text{MHz}$)	C_{iss}	—	4.5	7.0	pF
Reverse Transfer Capacitance ($V_{DS} = 15 \text{Vdc}$, $V_{GS} = 0$, $f = 1.0 \text{MHz}$)	C_{rss}	—	1.5	3.0	pF

1. Pulse Test; Pulse Width $\leq 630 \text{ms}$, Duty Cycle $\leq 10\%$.

Preferred devices are Motorola recommended choices for future use and best overall value.

TYPICAL CHARACTERISTICS

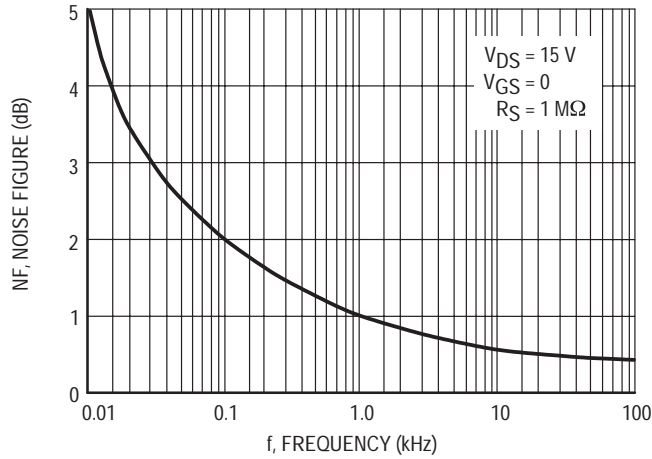


Figure 1. Noise Figure versus Frequency

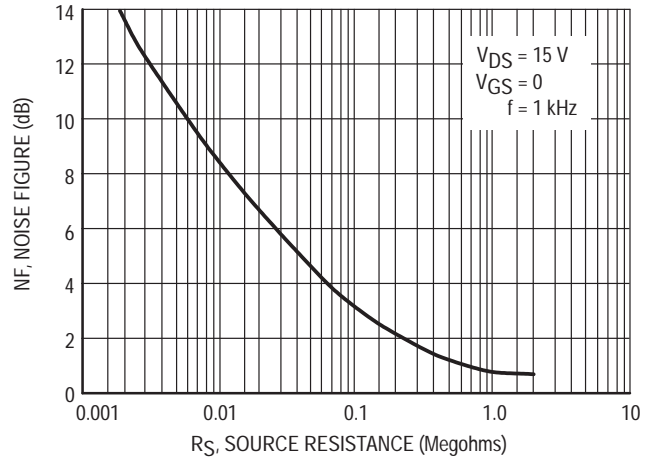


Figure 2. Noise Figure versus Source Resistance

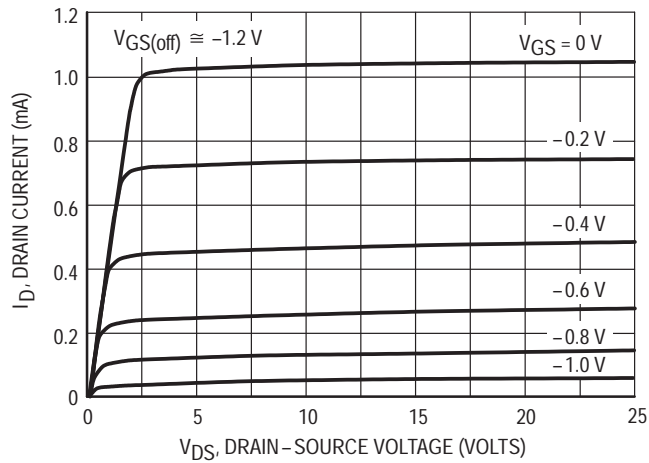


Figure 3. Typical Drain Characteristics

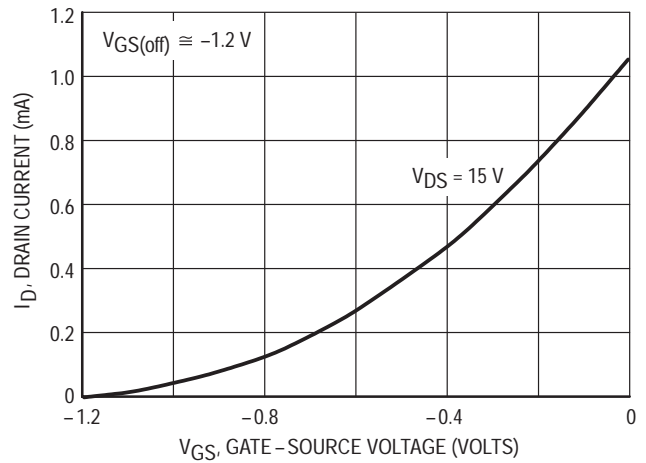


Figure 4. Common Source Transfer Characteristics

TYPICAL CHARACTERISTICS

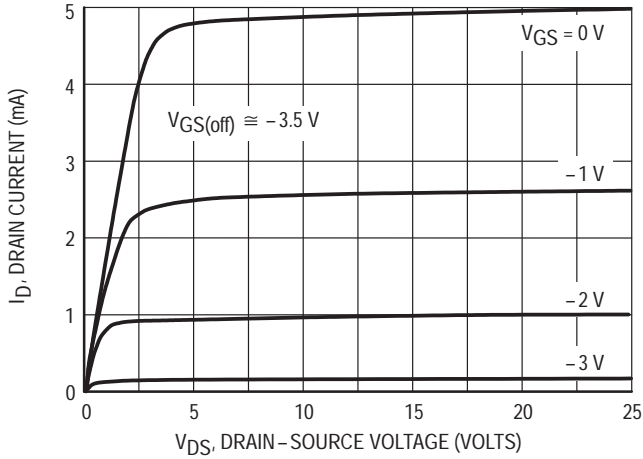


Figure 5. Typical Drain Characteristics

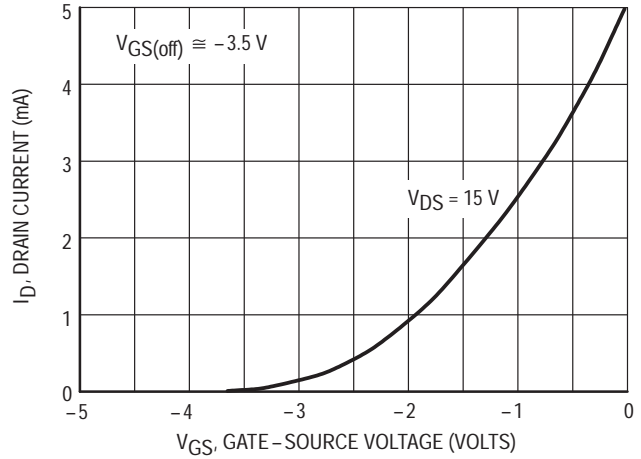


Figure 6. Common Source Transfer Characteristics

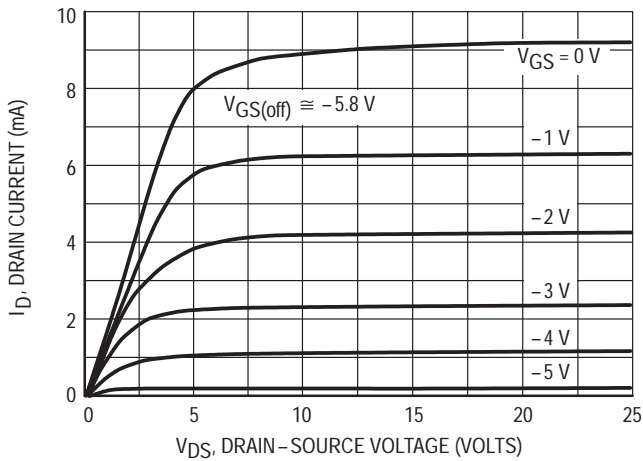


Figure 7. Typical Drain Characteristics

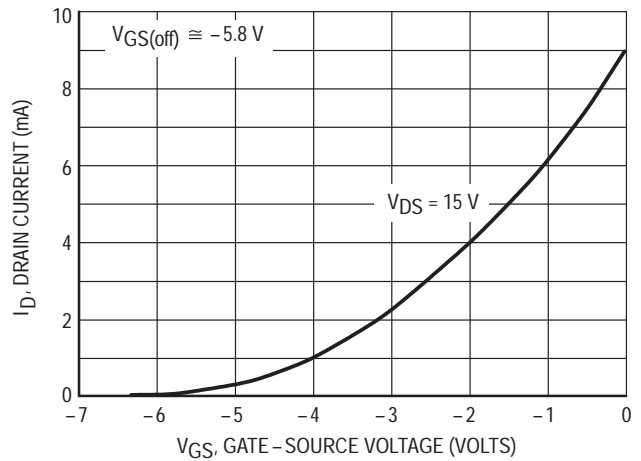
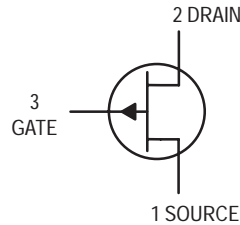


Figure 8. Common Source Transfer Characteristics

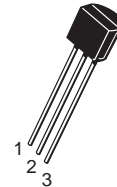
Note: Graphical data is presented for dc conditions. Tabular data is given for pulsed conditions (Pulse Width = 630 ms, Duty Cycle = 10%). Under dc conditions, self heating in higher I_{DSS} units reduces I_{DSS} .

JFET Amplifiers

P-Channel — Depletion



2N5460
2N5461
2N5462



CASE 29-04, STYLE 7
TO-92 (TO-226AA)

MAXIMUM RATINGS

Rating	Symbol	Value	Unit
Drain–Gate Voltage	V_{DG}	40	Vdc
Reverse Gate–Source Voltage	V_{GSR}	40	Vdc
Forward Gate Current	$I_{G(f)}$	10	mAdc
Total Device Dissipation @ $T_A = 25^\circ\text{C}$ Derate above 25°C	P_D	350 2.8	mW mW/°C
Junction Temperature Range	T_J	-65 to +135	°C
Storage Channel Temperature Range	T_{stg}	-65 to +150	°C

ELECTRICAL CHARACTERISTICS ($T_A = 25^\circ\text{C}$ unless otherwise noted)

Characteristic	Symbol	Min	Typ	Max	Unit
----------------	--------	-----	-----	-----	------

OFF CHARACTERISTICS

Gate–Source Breakdown Voltage ($I_G = 10 \mu\text{Adc}$, $V_{DS} = 0$)	2N5460, 2N5461, 2N5462	$V_{(BR)GSS}$	40	—	—	Vdc
Gate Reverse Current ($V_{GS} = 20 \text{ Vdc}$, $V_{DS} = 0$) ($V_{GS} = 30 \text{ Vdc}$, $V_{DS} = 0$)	2N5460, 2N5461, 2N5462	I_{GSS}	—	—	5.0	nAdc
($V_{GS} = 20 \text{ Vdc}$, $V_{DS} = 0$, $T_A = 100^\circ\text{C}$) ($V_{GS} = 30 \text{ Vdc}$, $V_{DS} = 0$, $T_A = 100^\circ\text{C}$)	2N5460, 2N5461, 2N5462		—	—	1.0	μAdc
Gate–Source Cutoff Voltage ($V_{DS} = 15 \text{ Vdc}$, $I_D = 1.0 \mu\text{Adc}$)	2N5460 2N5461 2N5462	$V_{GS(off)}$	0.75 1.0 1.8	— — —	6.0 7.5 9.0	Vdc
Gate–Source Voltage ($V_{DS} = 15 \text{ Vdc}$, $I_D = 0.1 \text{ mAdc}$) ($V_{DS} = 15 \text{ Vdc}$, $I_D = 0.2 \text{ mAdc}$) ($V_{DS} = 15 \text{ Vdc}$, $I_D = 0.4 \text{ mAdc}$)	2N5460 2N5461 2N5462	V_{GS}	0.5 0.8 1.5	— — —	4.0 4.5 6.0	Vdc

ON CHARACTERISTICS

Zero–Gate–Voltage Drain Current ($V_{DS} = 15 \text{ Vdc}$, $V_{GS} = 0$, $f = 1.0 \text{ kHz}$)	2N5460 2N5461 2N5462	I_{DSS}	-1.0 -2.0 -4.0	— — —	-5.0 -9.0 -16	mAdc
---------------------------------------------------------------------------------------------------------	----------------------------	-----------	----------------------	-------------	---------------------	------

SMALL-SIGNAL CHARACTERISTICS

Forward Transfer Admittance ($V_{DS} = 15 \text{ Vdc}$, $V_{GS} = 0$, $f = 1.0 \text{ kHz}$)	2N5460 2N5461 2N5462	$ y_{fs} $	1000 1500 2000	— — —	4000 5000 6000	μmhos
Output Admittance ($V_{DS} = 15 \text{ Vdc}$, $V_{GS} = 0$, $f = 1.0 \text{ kHz}$)		$ y_{os} $	—	—	75	μmhos
Input Capacitance ($V_{DS} = 15 \text{ Vdc}$, $V_{GS} = 0$, $f = 1.0 \text{ MHz}$)		C_{iss}	—	5.0	7.0	pF
Reverse Transfer Capacitance ($V_{DS} = 15 \text{ Vdc}$, $V_{GS} = 0$, $f = 1.0 \text{ MHz}$)		C_{rss}	—	1.0	2.0	pF

FUNCTIONAL CHARACTERISTICS

Noise Figure ($V_{DS} = 15 \text{ Vdc}$, $V_{GS} = 0$, $R_G = 1.0 \text{ Megohm}$, $f = 100 \text{ Hz}$, $BW = 1.0 \text{ Hz}$)		NF	—	1.0	2.5	dB
Equivalent Short–Circuit Input Noise Voltage ($V_{DS} = 15 \text{ Vdc}$, $V_{GS} = 0$, $f = 100 \text{ Hz}$, $BW = 1.0 \text{ Hz}$)		e_n	—	60	115	$\text{nV}/\sqrt{\text{Hz}}$

DRAIN CURRENT versus GATE SOURCE VOLTAGE

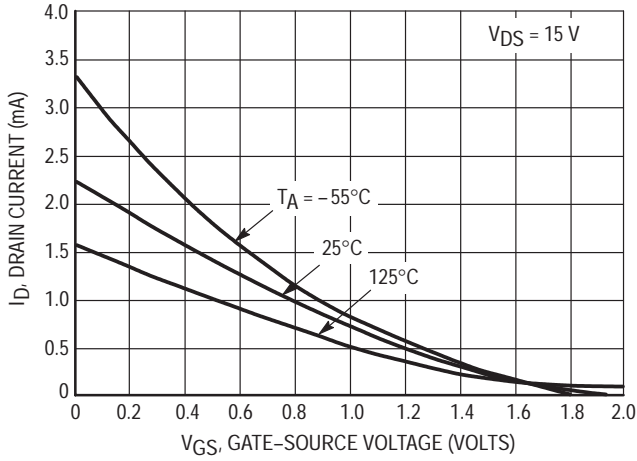


Figure 1. $V_{GS(off)} = 2.0$ Volts

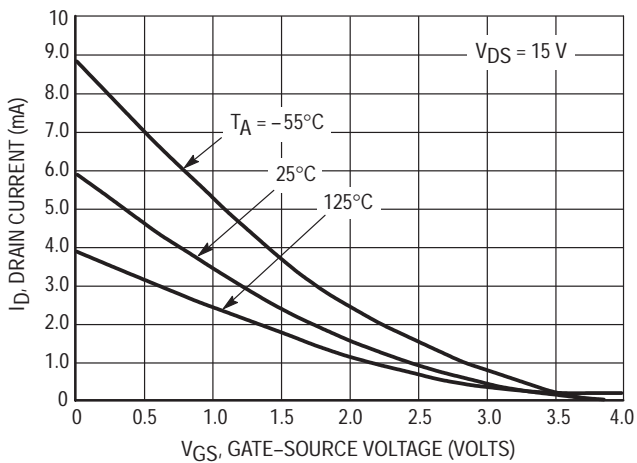


Figure 2. $V_{GS(off)} = 4.0$ Volts

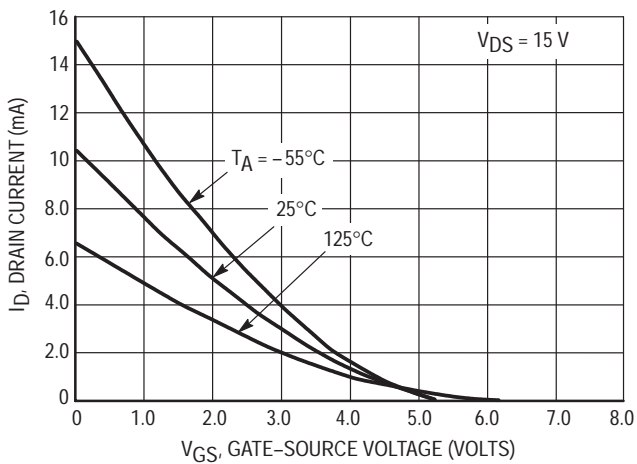


Figure 3. $V_{GS(off)} = 5.0$ Volts

FORWARD TRANSFER ADMITTANCE versus DRAIN CURRENT

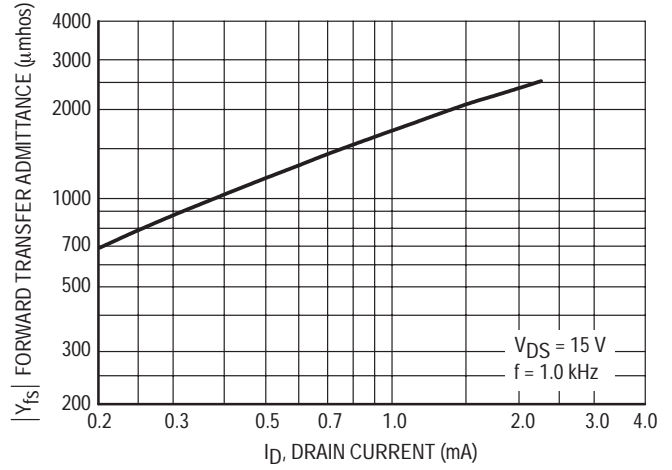


Figure 4. $V_{GS(off)} = 2.0$ Volts

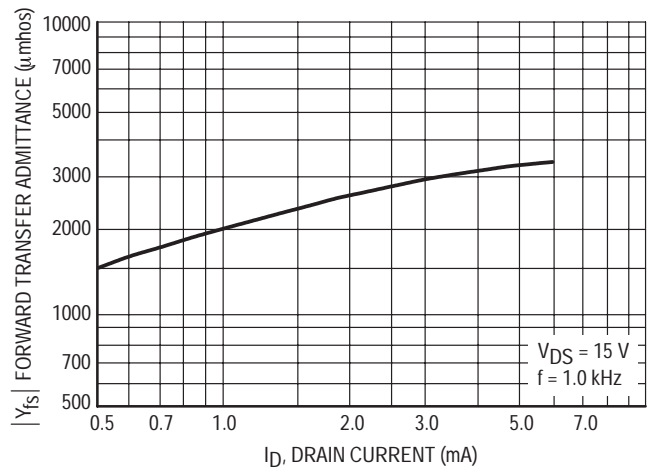


Figure 5. $V_{GS(off)} = 4.0$ Volts

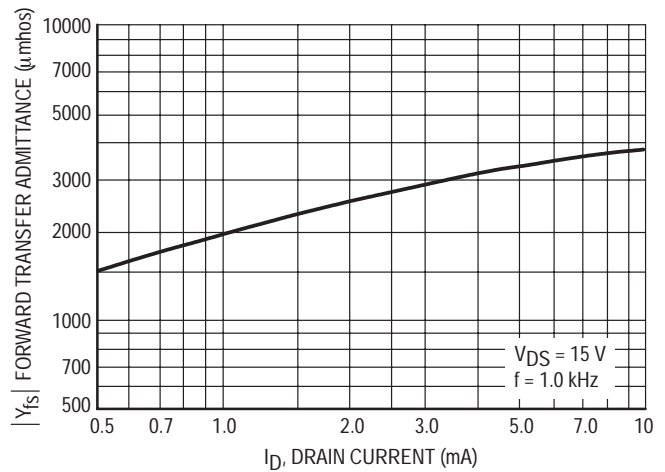


Figure 6. $V_{GS(off)} = 5.0$ Volts

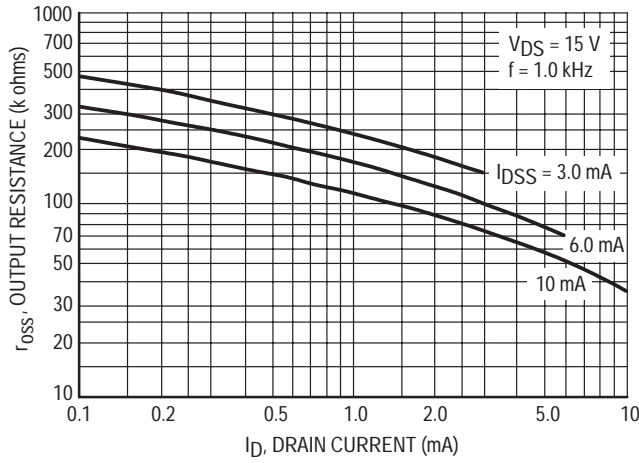


Figure 7. Output Resistance versus Drain Current

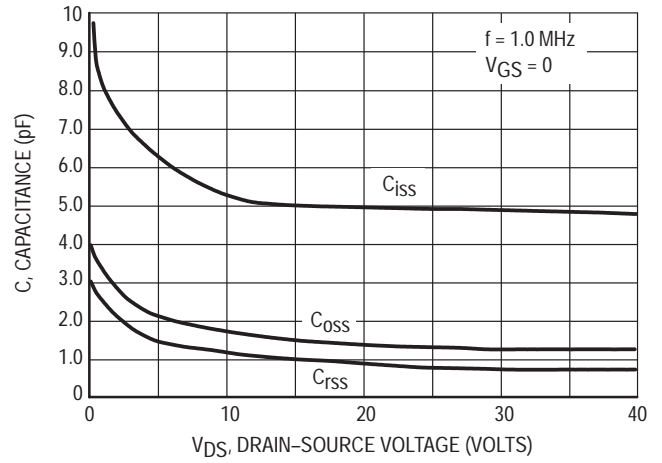


Figure 8. Capacitance versus Drain-Source Voltage

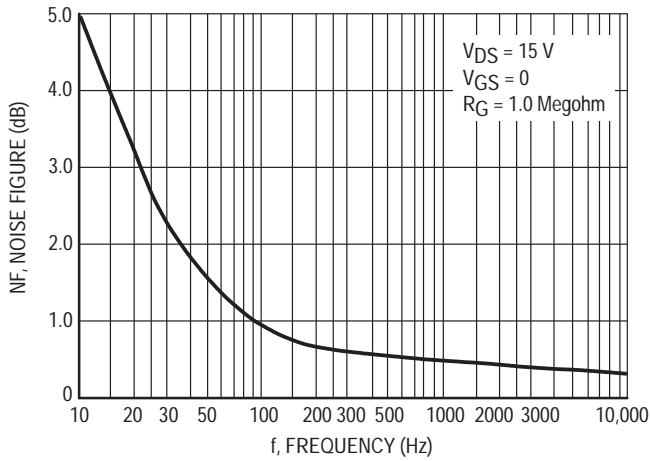


Figure 9. Noise Figure versus Frequency

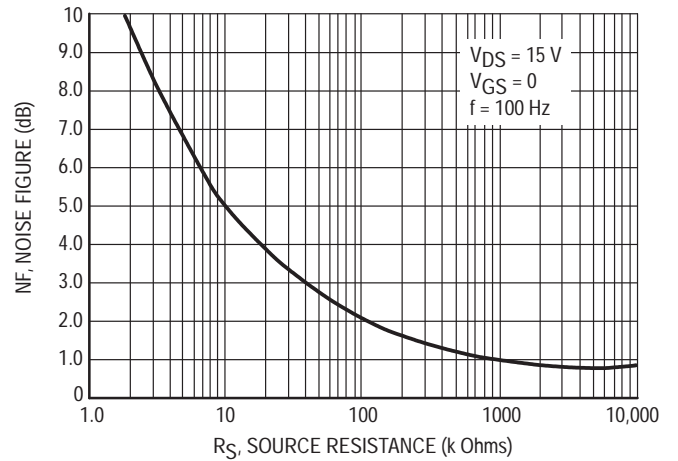
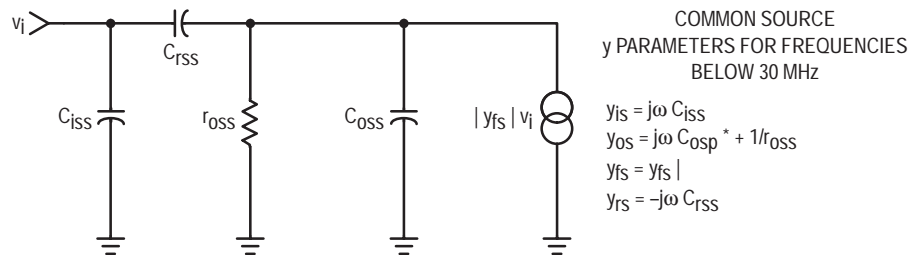


Figure 10. Noise Figure versus Source Resistance



* C_{osp} is C_{oss} in parallel with Series Combination of C_{iss} and C_{rss} .

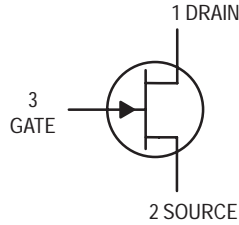
NOTE:

- Graphical data is presented for dc conditions. Tabular data is given for pulsed conditions (Pulse Width = 630 ms, Duty Cycle = 10%).

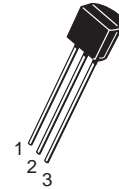
Figure 11. Equivalent Low Frequency Circuit

JFET VHF/UHF Amplifiers

N-Channel — Depletion



2N5484
2N5486



CASE 29-04, STYLE 5
TO-92 (TO-226AA)

MAXIMUM RATINGS

Rating	Symbol	Value	Unit
Drain–Gate Voltage	V_{DG}	25	Vdc
Reverse Gate–Source Voltage	V_{GSR}	25	Vdc
Drain Current	I_D	30	mAdc
Forward Gate Current	$I_{G(f)}$	10	mAdc
Total Device Dissipation @ $T_C = 25^\circ\text{C}$ Derate above 25°C	P_D	350 2.8	mW mW/ $^\circ\text{C}$
Operating and Storage Junction Temperature Range	T_J, T_{stg}	-65 to +150	$^\circ\text{C}$

ELECTRICAL CHARACTERISTICS ($T_A = 25^\circ\text{C}$ unless otherwise noted)

Characteristic	Symbol	Min	Typ	Max	Unit
----------------	--------	-----	-----	-----	------

OFF CHARACTERISTICS

Gate–Source Breakdown Voltage ($I_G = -1.0 \mu\text{Adc}$, $V_{DS} = 0$)	$V_{(BR)GSS}$	-25	—	—	Vdc	
Gate Reverse Current ($V_{GS} = -20 \text{ Vdc}$, $V_{DS} = 0$) ($V_{GS} = -20 \text{ Vdc}$, $V_{DS} = 0$, $T_A = 100^\circ\text{C}$)	I_{GSS}	— —	— —	-1.0 -0.2	nAdc μAdc	
Gate Source Cutoff Voltage ($V_{DS} = 15 \text{ Vdc}$, $I_D = 10 \text{ nAdc}$)	$V_{GS(off)}$	2N5484 2N5486	-0.3 -2.0	— —	-3.0 -6.0	Vdc

ON CHARACTERISTICS

Zero–Gate–Voltage Drain Current ($V_{DS} = 15 \text{ Vdc}$, $V_{GS} = 0$)	2N5484 2N5486	I_{DSS}	1.0 8.0	— —	5.0 20	mAdc
---------------------------------------------------------------------------------	------------------	-----------	------------	--------	-----------	------

SMALL-SIGNAL CHARACTERISTICS

Forward Transfer Admittance ($V_{DS} = 15 \text{ Vdc}$, $V_{GS} = 0$, $f = 1.0 \text{ kHz}$)	2N5484 2N5486	$ y_{fs} $	3000 4000	— —	6000 8000	μhos
Input Admittance ($V_{DS} = 15 \text{ Vdc}$, $V_{GS} = 0$, $f = 100 \text{ MHz}$) ($V_{DS} = 15 \text{ Vdc}$, $V_{GS} = 0$, $f = 400 \text{ MHz}$)	2N5484 2N5486	$\text{Re}(y_{is})$	— —	— —	100 1000	μhos
Output Admittance ($V_{DS} = 15 \text{ Vdc}$, $V_{GS} = 0$, $f = 1.0 \text{ kHz}$)	2N5484 2N5486	$ y_{os} $	— —	— —	50 75	μhos
Output Conductance ($V_{DS} = 15 \text{ Vdc}$, $V_{GS} = 0$, $f = 100 \text{ MHz}$) ($V_{DS} = 15 \text{ Vdc}$, $V_{GS} = 0$, $f = 400 \text{ MHz}$)	2N5484 2N5486	$\text{Re}(y_{os})$	— —	— —	75 100	μhos
Forward Transconductance ($V_{DS} = 15 \text{ Vdc}$, $V_{GS} = 0$, $f = 100 \text{ MHz}$) ($V_{DS} = 15 \text{ Vdc}$, $V_{GS} = 0$, $f = 400 \text{ MHz}$)	2N5484 2N5486	$\text{Re}(y_{fs})$	2500 3500	— —	— —	μhos

ELECTRICAL CHARACTERISTICS ($T_A = 25^\circ\text{C}$ unless otherwise noted) (Continued)

Characteristic	Symbol	Min	Typ	Max	Unit
SMALL-SIGNAL CHARACTERISTICS (continued)					
Input Capacitance ($V_{DS} = 15\text{ Vdc}$, $V_{GS} = 0$, $f = 1.0\text{ MHz}$)	C_{iss}	—	—	5.0	pF
Reverse Transfer Capacitance ($V_{DS} = 15\text{ Vdc}$, $V_{GS} = 0$, $f = 1.0\text{ MHz}$)	C_{rss}	—	—	1.0	pF
Output Capacitance ($V_{DS} = 15\text{ Vdc}$, $V_{GS} = 0$, $f = 1.0\text{ MHz}$)	C_{oss}	—	—	2.0	pF

FUNCTIONAL CHARACTERISTICS

Noise Figure ($V_{DS} = 15\text{ Vdc}$, $V_{GS} = 0$, $R_G = 1.0\text{ Megohm}$, $f = 1.0\text{ kHz}$) ($V_{DS} = 15\text{ Vdc}$, $I_D = 1.0\text{ mAdc}$, $R_G \approx 1.0\text{ k}\Omega$, $f = 100\text{ MHz}$) 2N5484 ($V_{DS} = 15\text{ Vdc}$, $I_D = 1.0\text{ mAdc}$, $R_G \approx 1.0\text{ k}\Omega$, $f = 200\text{ MHz}$) 2N5484 ($V_{DS} = 15\text{ Vdc}$, $I_D = 4.0\text{ mAdc}$, $R_G \approx 1.0\text{ k}\Omega$, $f = 100\text{ MHz}$) 2N5486 ($V_{DS} = 15\text{ Vdc}$, $I_D = 4.0\text{ mAdc}$, $R_G \approx 1.0\text{ k}\Omega$, $f = 400\text{ MHz}$) 2N5486	NF	—	—	2.5	dB
Common Source Power Gain ($V_{DS} = 15\text{ Vdc}$, $I_D = 1.0\text{ mAdc}$, $f = 100\text{ MHz}$) 2N5484 ($V_{DS} = 15\text{ Vdc}$, $I_D = 1.0\text{ mAdc}$, $f = 200\text{ MHz}$) 2N5484 ($V_{DS} = 15\text{ Vdc}$, $I_D = 4.0\text{ mAdc}$, $f = 100\text{ MHz}$) 2N5486 ($V_{DS} = 15\text{ Vdc}$, $I_D = 4.0\text{ mAdc}$, $f = 400\text{ MHz}$) 2N5486	G_{ps}	16	—	25	dB
		—	14	—	
		18	—	30	
		10	—	20	

POWER GAIN

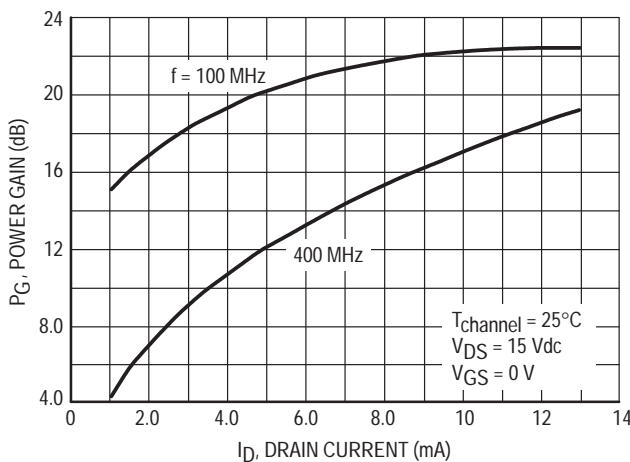
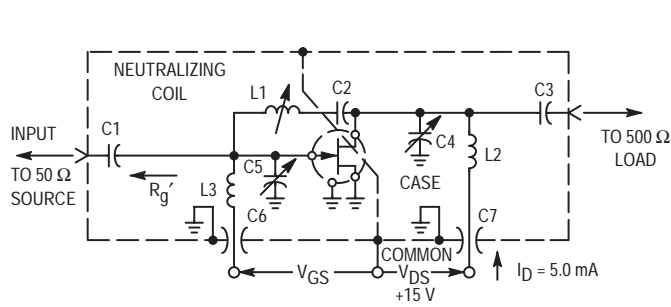


Figure 1. Effects of Drain Current



Adjust V_{GS} for $I_D = 50 \text{ mA}$
 $V_{GS} < 0 \text{ Volts}$

NOTE: The noise source is a hot-cold body (AIL type 70 or equivalent) with a test receiver (AIL type 136 or equivalent).

Reference Designation	VALUE	
	100 MHz	400 MHz
C1	7.0 pF	1.8 pF
C2	1000 pF	17 pF
C3	3.0 pF	1.0 pF
C4	1–12 pF	0.8–8.0 pF
C5	1–12 pF	0.8–8.0 pF
C6	0.0015 μF	0.001 μF
C7	0.0015 μF	0.001 μF
L1	3.0 μH^*	0.2 μH^{**}
L2	0.15 μH^*	0.03 μH^{**}
L3	0.14 μH^*	0.022 μH^{**}

- *L1 17 turns, (approx. — depends upon circuit layout) AWG #28 enameled copper wire, close wound on 9/32" ceramic coil form. Tuning provided by a powdered iron slug.
- L2 4–1/2 turns, AWG #18 enameled copper wire, 5/16" long, 3/8" I.D. (AIR CORE).
- L3 3–1/2 turns, AWG #18 enameled copper wire, 1/4" long, 3/8" I.D. (AIR CORE).

- **L1 6 turns, (approx. — depends upon circuit layout) AWG #24 enameled copper wire, close wound on 7/32" ceramic coil form. Tuning provided by an aluminum slug.
- L2 1 turn, AWG #16 enameled copper wire, 3/8" I.D. (AIR CORE).
- L3 1/2 turn, AWG #16 enameled copper wire, 1/4" I.D. (AIR CORE).

Figure 2. 100 MHz and 400 MHz Neutralized Test Circuit

NOISE FIGURE
 ($T_{\text{channel}} = 25^\circ\text{C}$)

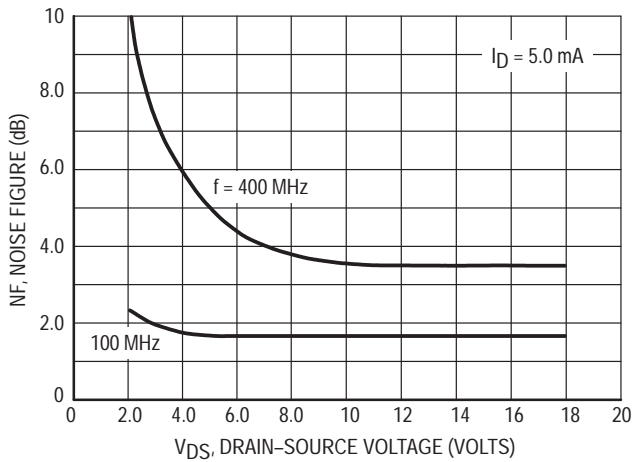


Figure 3. Effects of Drain-Source Voltage

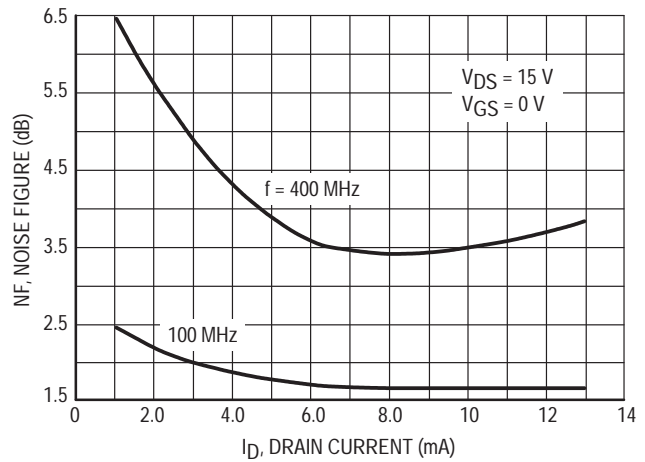


Figure 4. Effects of Drain Current

INTERMODULATION CHARACTERISTICS

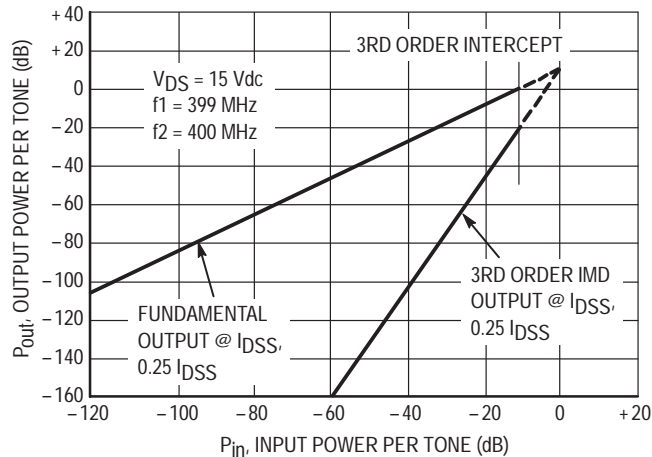


Figure 5. Third Order Intermodulation Distortion

COMMON SOURCE CHARACTERISTICS

ADMITTANCE PARAMETERS

($V_{DS} = 15 \text{ Vdc}$, $T_{\text{channel}} = 25^\circ\text{C}$)

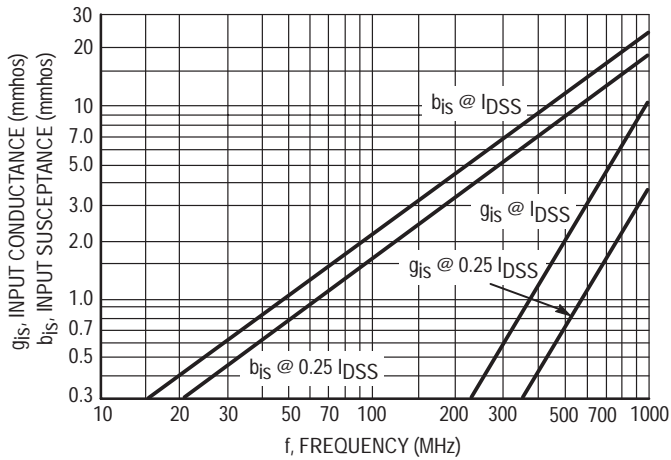


Figure 6. Input Admittance (y_{is})

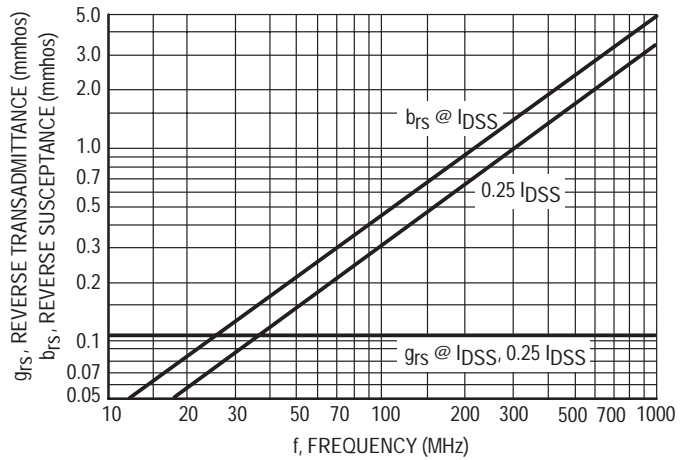


Figure 7. Reverse Transfer Admittance (y_{rs})

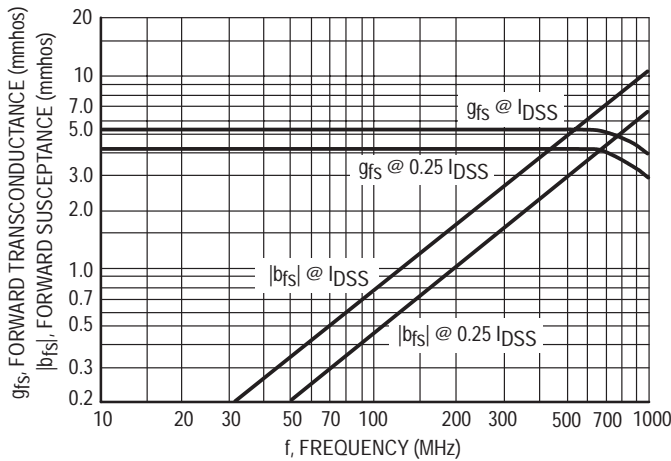


Figure 8. Forward Transadmittance (y_{fs})

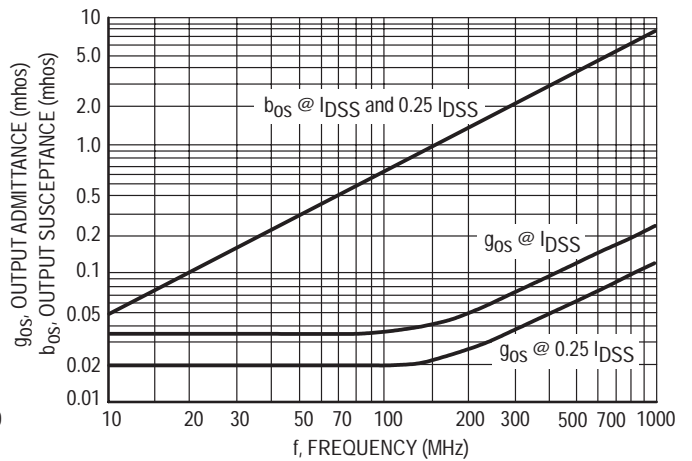


Figure 9. Output Admittance (y_{os})

COMMON SOURCE CHARACTERISTICS
S-PARAMETERS
 ($V_{DS} = 15 \text{ Vdc}$, $T_{\text{channel}} = 25^\circ\text{C}$, Data Points in MHz)

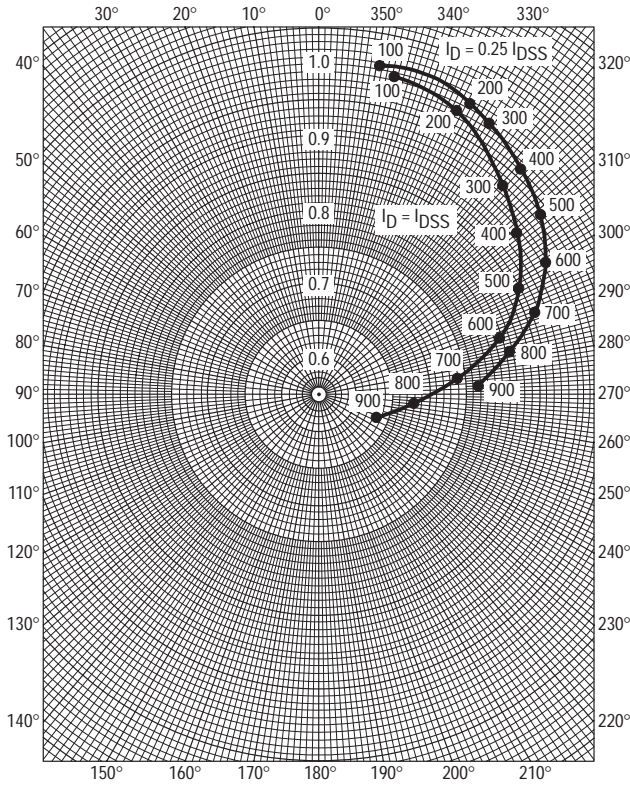


Figure 10. S_{11s}

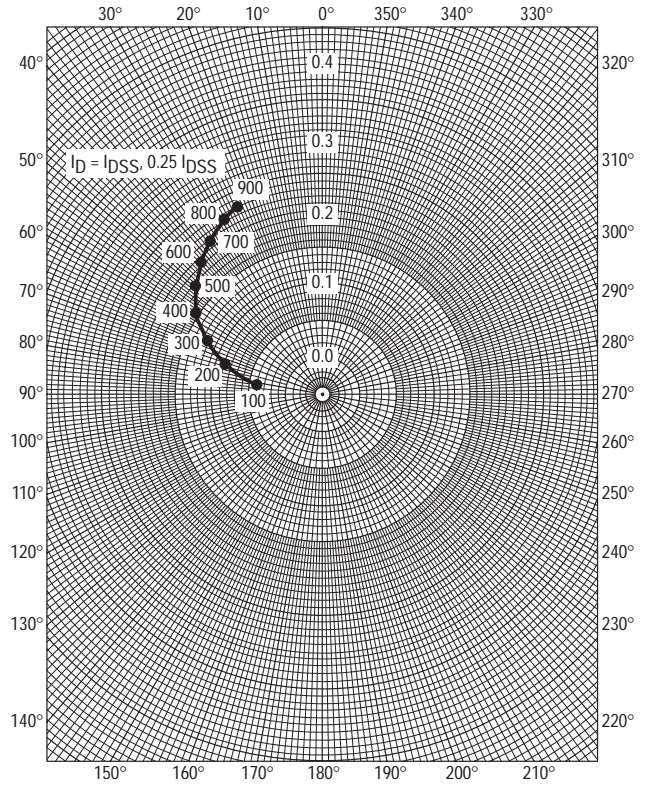


Figure 11. S_{12s}

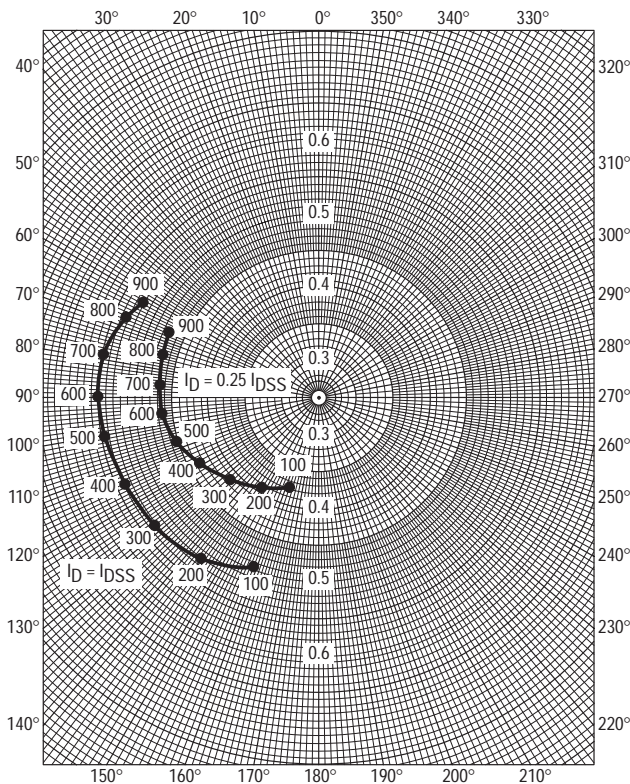


Figure 12. S_{21s}

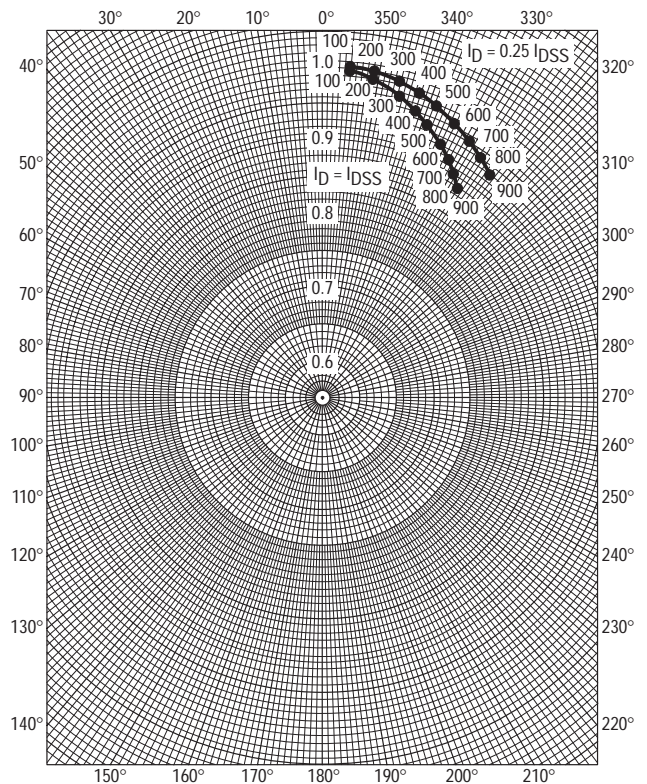


Figure 13. S_{22s}

COMMON GATE CHARACTERISTICS

ADMITTANCE PARAMETERS

($V_{DG} = 15 \text{ Vdc}$, $T_{channel} = 25^\circ\text{C}$)

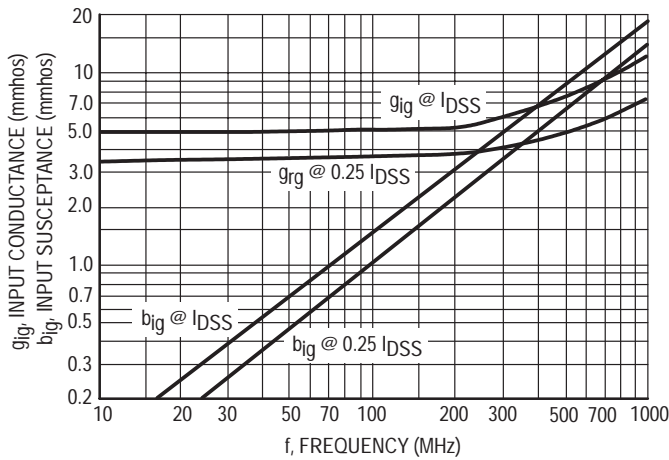


Figure 14. Input Admittance (y_{ig})

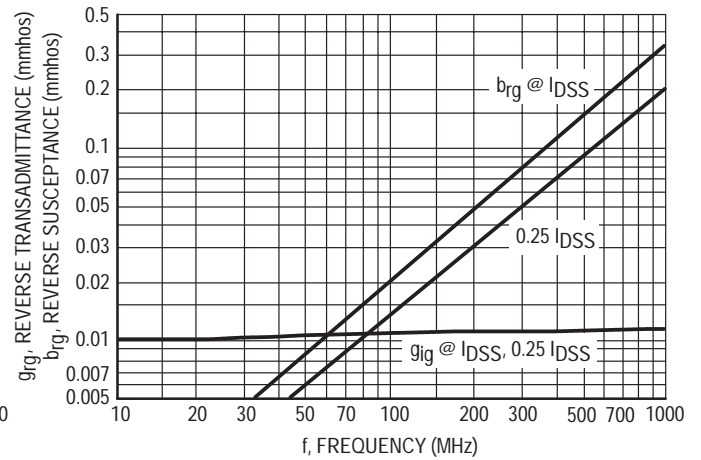


Figure 15. Reverse Transfer Admittance (y_{rg})

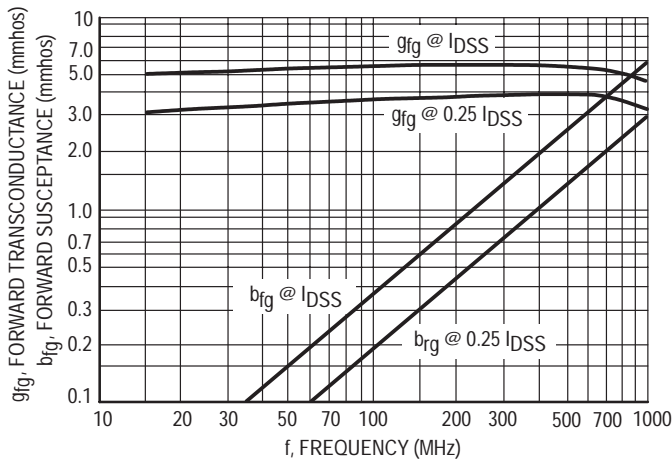


Figure 16. Forward Transfer Admittance (y_{fg})

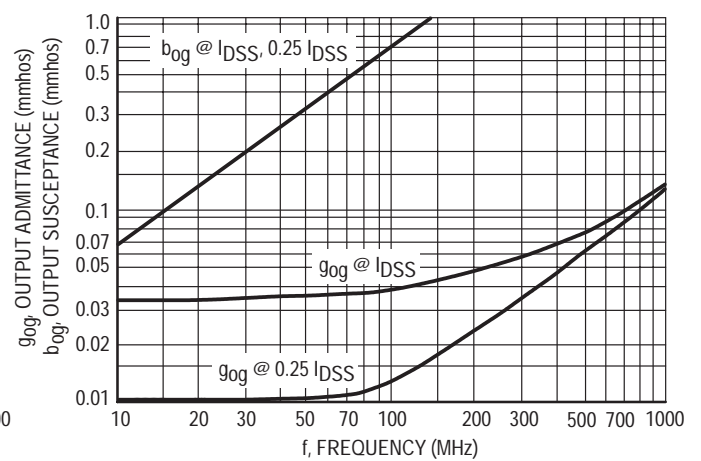


Figure 17. Output Admittance (y_{og})

COMMON GATE CHARACTERISTICS
S-PARAMETERS

($V_{DS} = 15 \text{ Vdc}$, $T_{channel} = 25^\circ\text{C}$, Data Points in MHz)

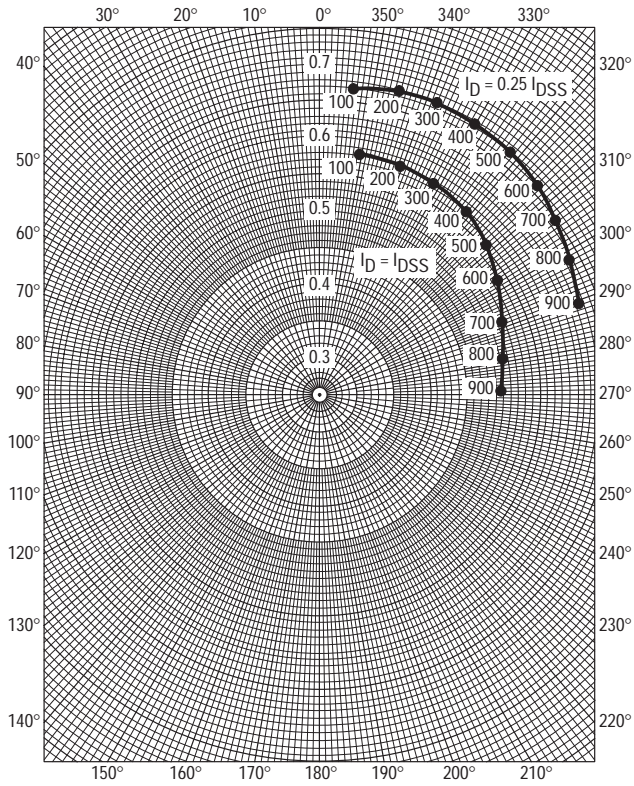


Figure 18. S11g

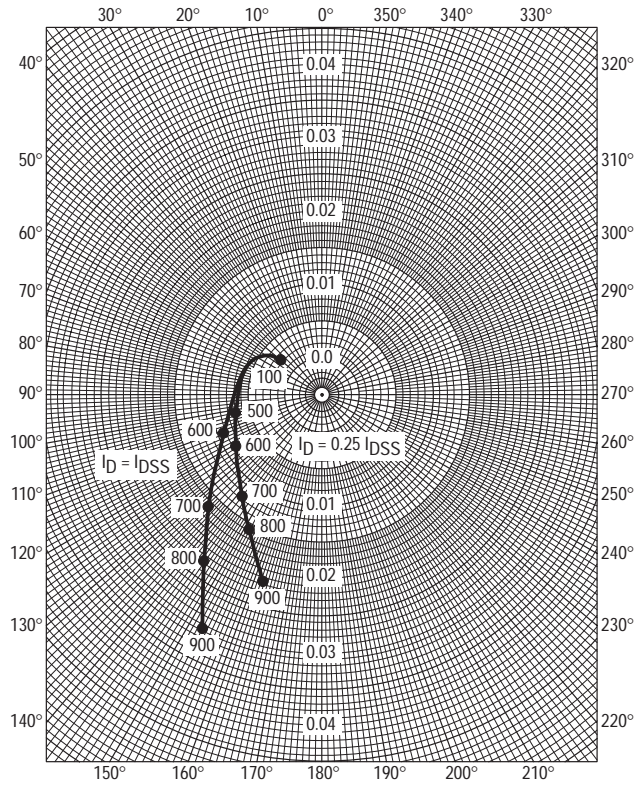


Figure 19. S12g

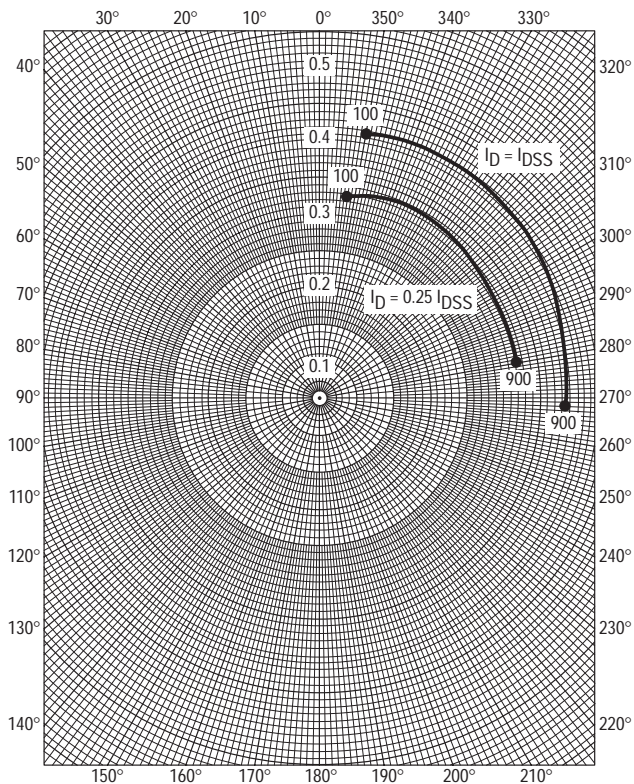


Figure 20. S21g

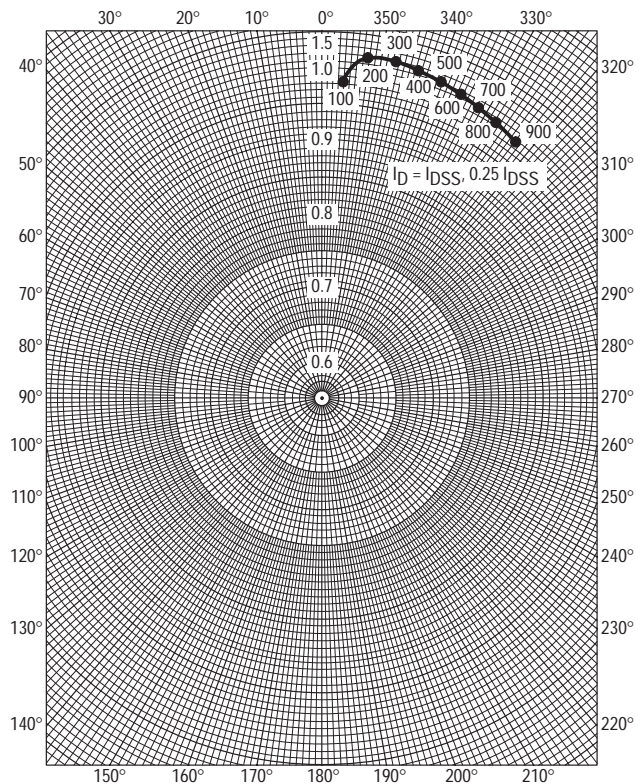
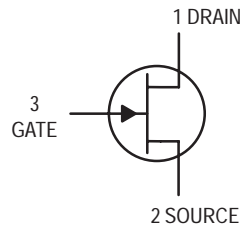


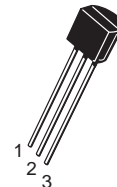
Figure 21. S22g

JFET Switching

N-Channel — Depletion



2N5555



CASE 29-04, STYLE 5
TO-92 (TO-226AA)

MAXIMUM RATINGS

Rating	Symbol	Value	Unit
Drain-Source Voltage	V_{DS}	25	Vdc
Drain-Gate Voltage	V_{DG}	25	Vdc
Gate-Source Voltage	V_{GS}	25	Vdc
Forward Gate Current	I_{GF}	10	mAdc
Total Device Dissipation @ $T_C = 25^\circ\text{C}$ Derate above 25°C	P_D	350 2.8	mW mW/ $^\circ\text{C}$
Junction Temperature Range	T_J	-65 to +150	$^\circ\text{C}$
Storage Temperature Range	T_{stg}	-65 to +150	$^\circ\text{C}$

ELECTRICAL CHARACTERISTICS ($T_A = 25^\circ\text{C}$ unless otherwise noted)

Characteristic	Symbol	Min	Max	Unit
----------------	--------	-----	-----	------

OFF CHARACTERISTICS

Gate-Source Breakdown Voltage ($I_G = 10 \mu\text{Adc}$, $V_{DS} = 0$)	$V_{(BR)GSS}$	25	—	Vdc
Gate Reverse Current ($V_{GS} = 15 \text{ Vdc}$, $V_{DS} = 0$)	I_{GSS}	—	1.0	nAdc
Drain Cutoff Current ($V_{DS} = 12 \text{ Vdc}$, $V_{GS} = -10 \text{ V}$) ($V_{DS} = 12 \text{ Vdc}$, $V_{GS} = -10 \text{ V}$, $T_A = 100^\circ\text{C}$)	$I_{D(off)}$	—	10 2.0	nAdc μAdc

ON CHARACTERISTICS

Zero-Gate-Voltage Drain Current ⁽¹⁾ ($V_{DS} = 15 \text{ Vdc}$, $V_{GS} = 0$)	I_{DSS}	15	—	mAdc
Gate-Source Forward Voltage ($I_G(f) = 1.0 \text{ mAdc}$, $V_{DS} = 0$)	$V_{GS(f)}$	—	1.0	Vdc
Drain-Source On-Voltage ($I_D = 7.0 \text{ mAdc}$, $V_{GS} = 0$)	$V_{DS(on)}$	—	1.5	Vdc
Static Drain-Source On Resistance ($I_D = 0.1 \text{ mAdc}$, $V_{GS} = 0$)	$r_{DS(on)}$	—	150	Ohms

SMALL-SIGNAL CHARACTERISTICS

Small-Signal Drain-Source "ON" Resistance ($V_{GS} = 0$, $I_D = 0$, $f = 1.0 \text{ kHz}$)	$r_{ds(on)}$	—	150	Ohms
Input Capacitance ($V_{DS} = 15 \text{ Vdc}$, $V_{GS} = 0$, $f = 1.0 \text{ MHz}$)	C_{iss}	—	5.0	pF
Reverse Transfer Capacitance ($V_{DS} = 0$, $V_{GS} = 10 \text{ Vdc}$, $f = 1.0 \text{ MHz}$)	C_{rss}	—	1.2	pF

SWITCHING CHARACTERISTICS

Turn-On Delay Time	$(V_{DD} = 10 \text{ Vdc}$, $I_{D(on)} = 7.0 \text{ mAdc}$, $V_{GS(on)} = 0$, $V_{GS(off)} = -10 \text{ Vdc}$) (See Figure 1)	$t_{d(on)}$	—	5.0	ns
Rise Time		t_r	—	5.0	ns
Turn-Off Delay Time	$(V_{DD} = 10 \text{ Vdc}$, $I_{D(on)} = 7.0 \text{ mAdc}$, $V_{GS(on)} = 0$, $V_{GS(off)} = -10 \text{ Vdc}$) (See Figure 1)	$t_{d(off)}$	—	15	ns
Fall Time		t_f	—	10	ns

1. Pulse Test: Pulse Width < 300 μs , Duty Cycle < 3.0%.

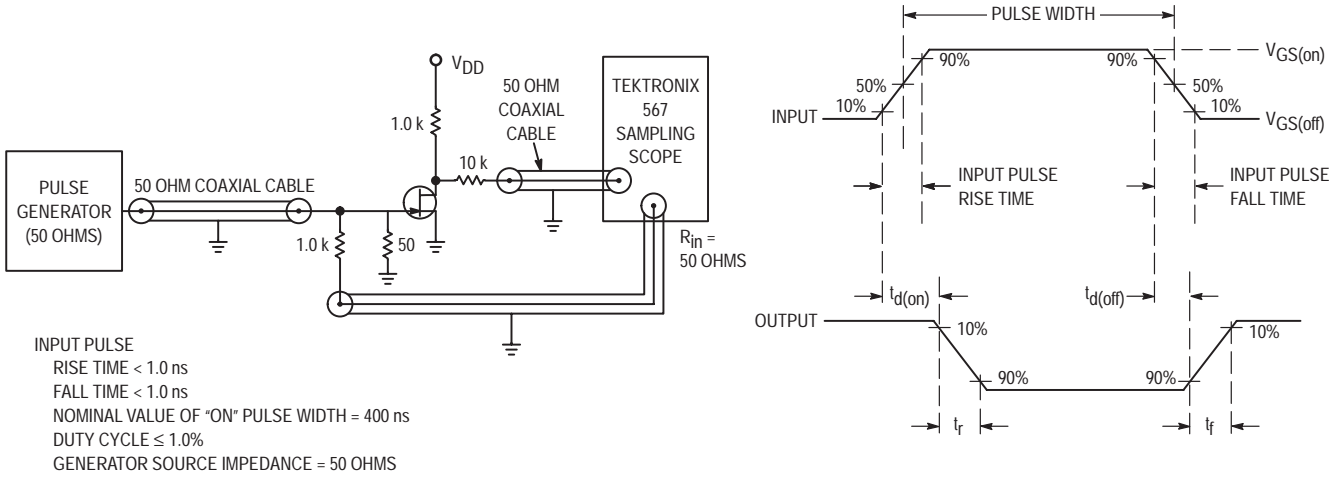


Figure 1. Switching Times Test Circuit

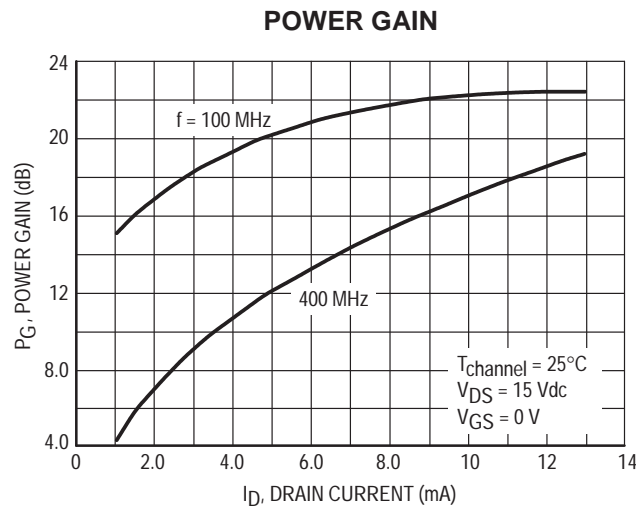
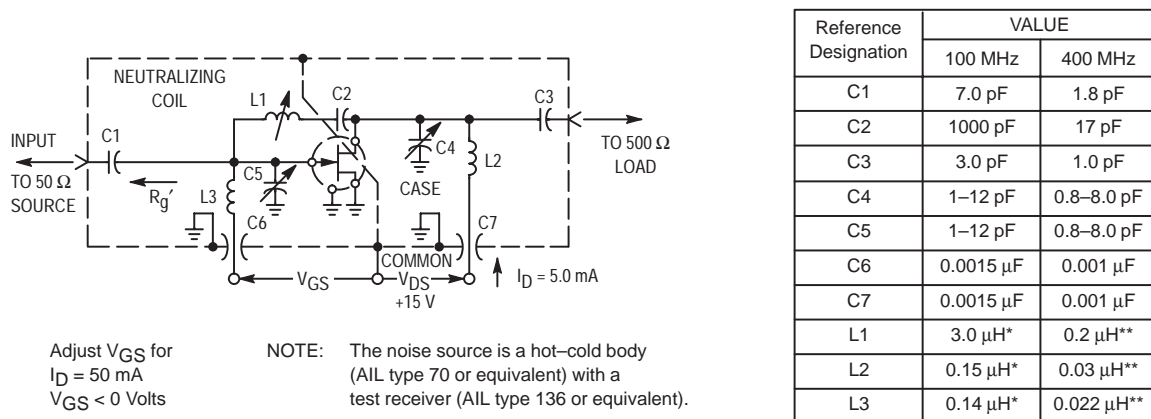


Figure 2. Effects of Drain Current



*L1 17 turns, (approx. — depends upon circuit layout) AWG #28 enameled copper wire, close wound on 9/32" ceramic coil form. Tuning provided by a powdered iron slug.
 L2 4–1/2 turns, AWG #18 enameled copper wire, 5/16" long, 3/8" I.D. (AIR CORE).
 L3 3–1/2 turns, AWG #18 enameled copper wire, 1/4" long, 3/8" I.D. (AIR CORE).

**L1 6 turns, (approx. — depends upon circuit layout) AWG #24 enameled copper wire, close wound on 7/32" ceramic coil form. Tuning provided by an aluminum slug.
 L2 1 turn, AWG #16 enameled copper wire, 3/8" I.D. (AIR CORE).
 L3 1/2 turn, AWG #16 enameled copper wire, 1/4" I.D. (AIR CORE).

Figure 3. 100 MHz and 400 MHz Neutralized Test Circuit

NOISE FIGURE

($T_{channel} = 25^{\circ}C$)

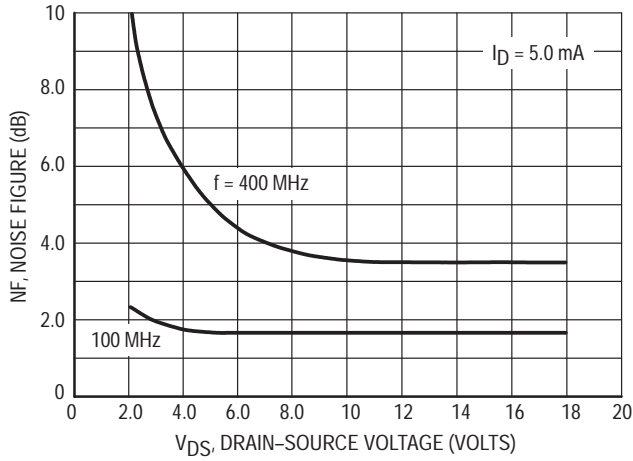


Figure 4. Effects of Drain-Source Voltage

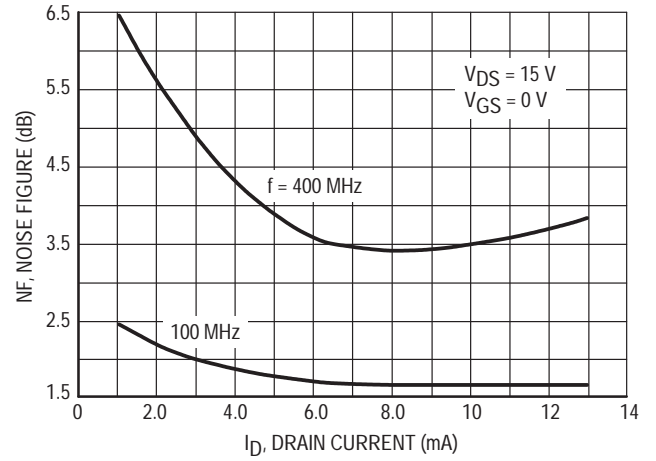


Figure 5. Effects of Drain Current

INTERMODULATION CHARACTERISTICS

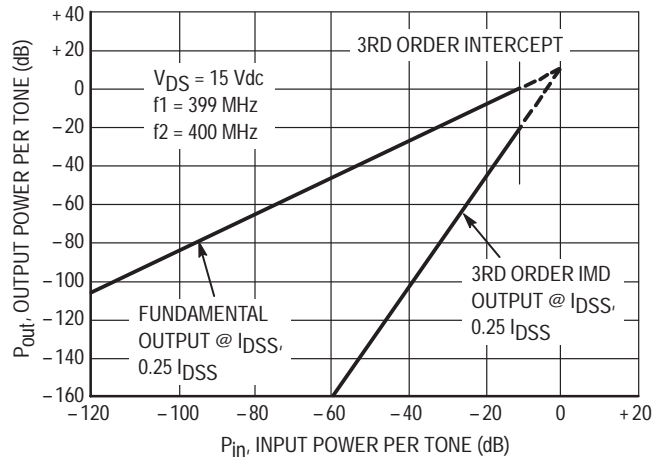


Figure 6. Third Order Intermodulation Distortion

COMMON SOURCE CHARACTERISTICS

ADMITTANCE PARAMETERS

($V_{DS} = 15 \text{ Vdc}$, $T_{channel} = 25^\circ\text{C}$)

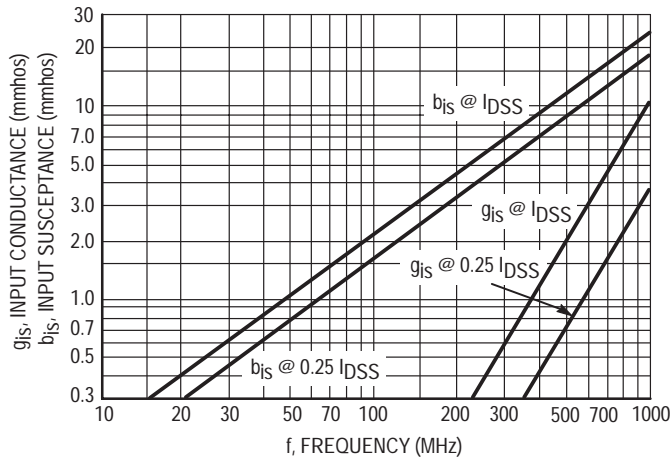


Figure 7. Input Admittance (y_{is})

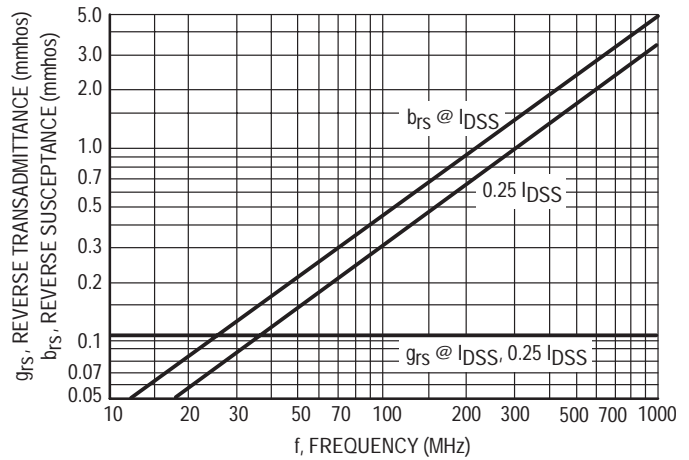


Figure 8. Reverse Transfer Admittance (y_{rs})

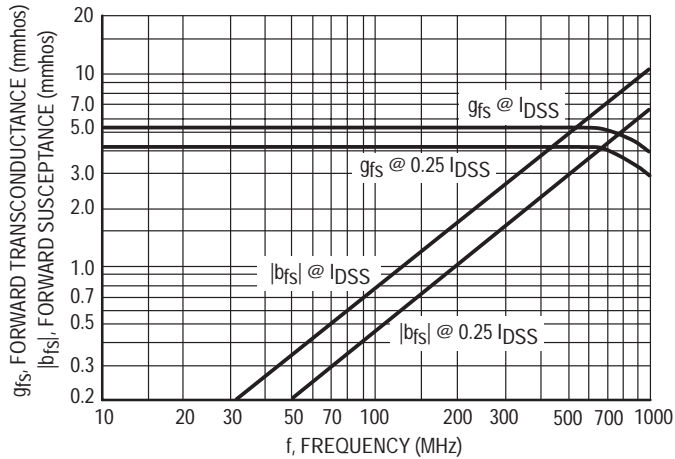


Figure 9. Forward Transadmittance (y_{fs})

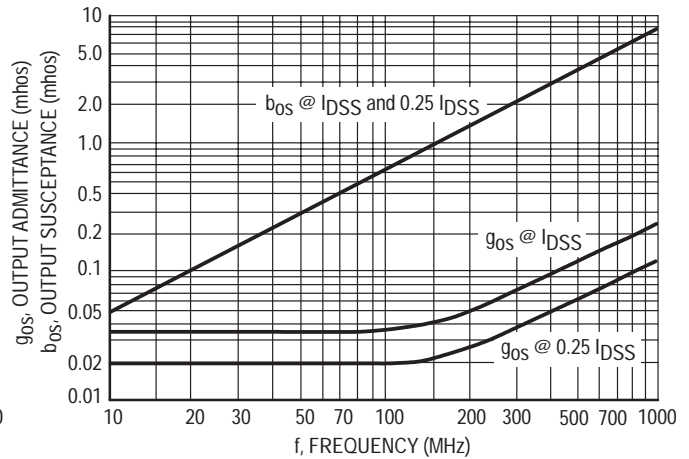


Figure 10. Output Admittance (y_{os})

COMMON SOURCE CHARACTERISTICS
S-PARAMETERS
 ($V_{DS} = 15 \text{ Vdc}$, $T_{\text{channel}} = 25^\circ\text{C}$, Data Points in MHz)

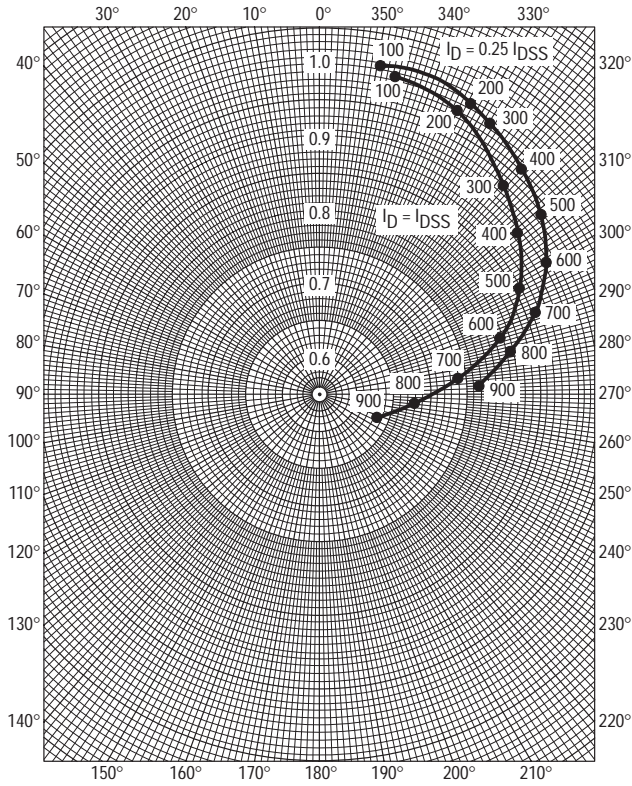


Figure 11. S_{11s}

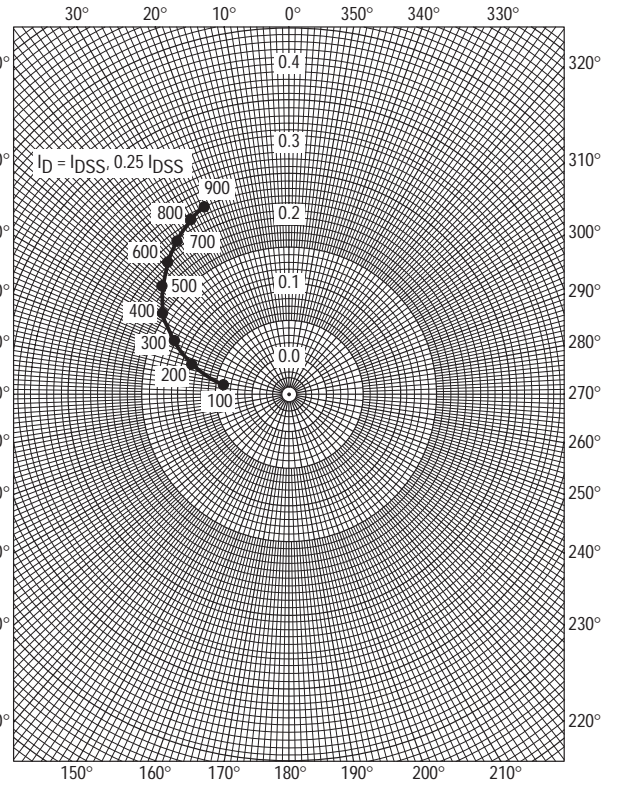


Figure 12. S_{12s}

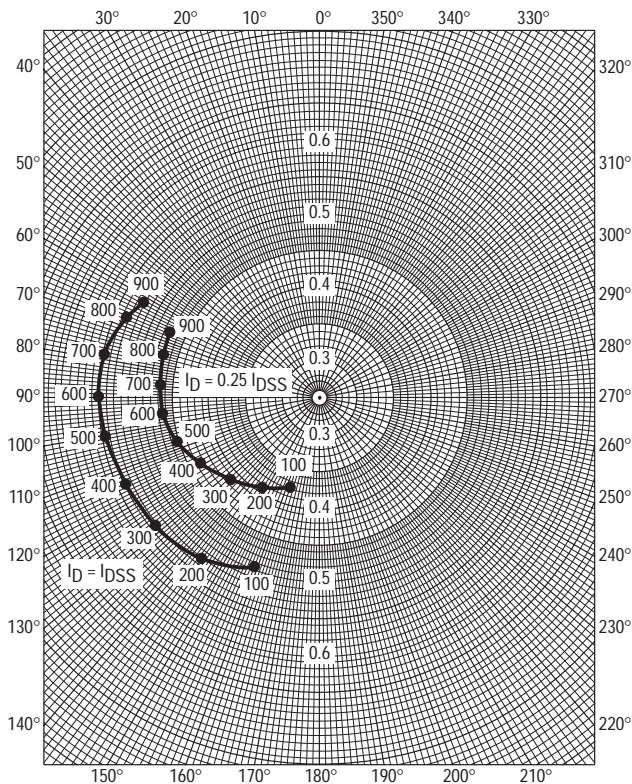


Figure 13. S_{21s}

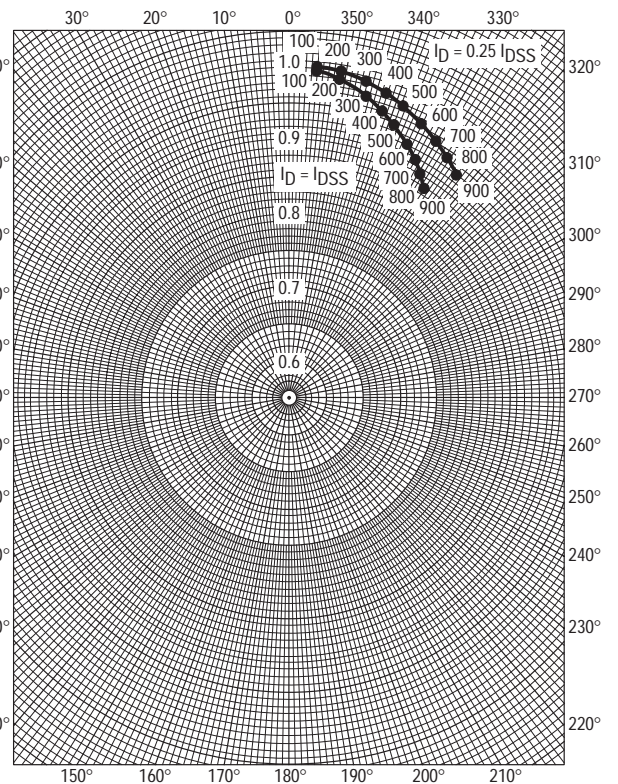


Figure 14. S_{22s}

COMMON GATE CHARACTERISTICS
ADMITTANCE PARAMETERS
 (VDG = 15 Vdc, Tchannel = 25°C)

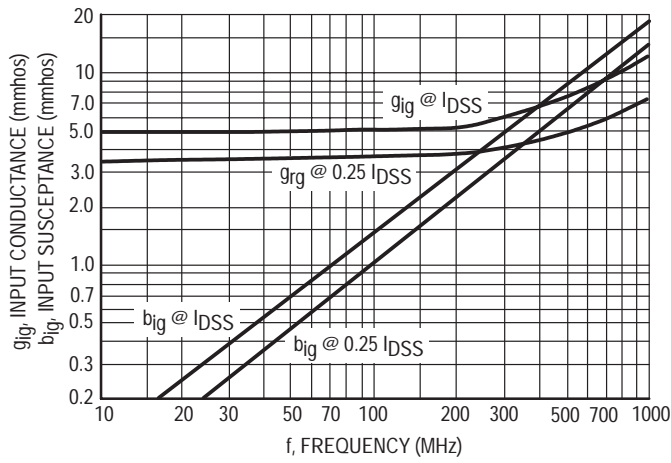


Figure 15. Input Admittance (y_{ig})

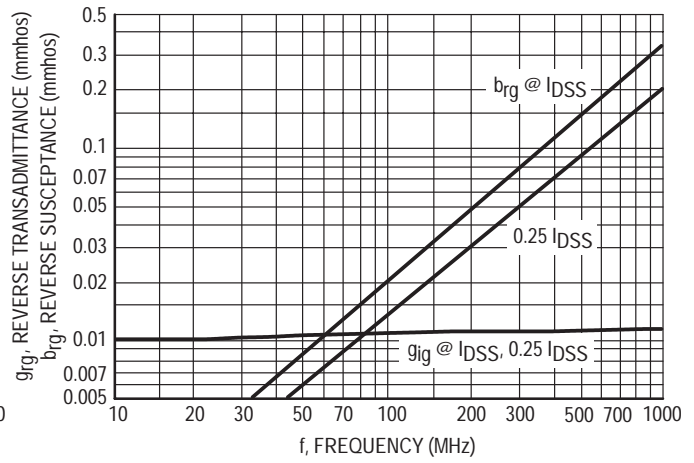


Figure 16. Reverse Transfer Admittance (y_{rg})

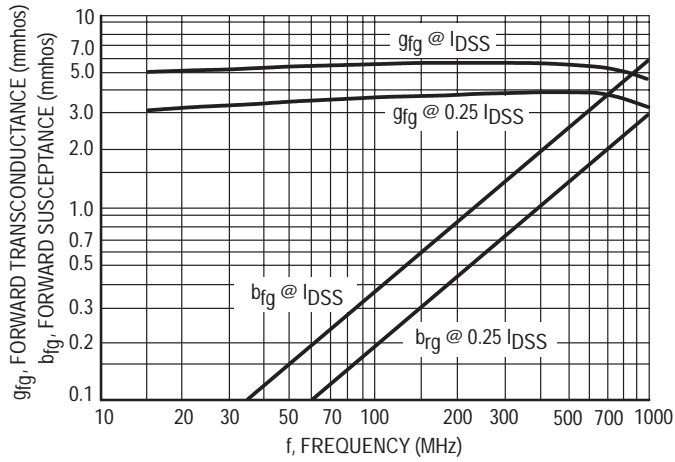


Figure 17. Forward Transfer Admittance (y_{fg})

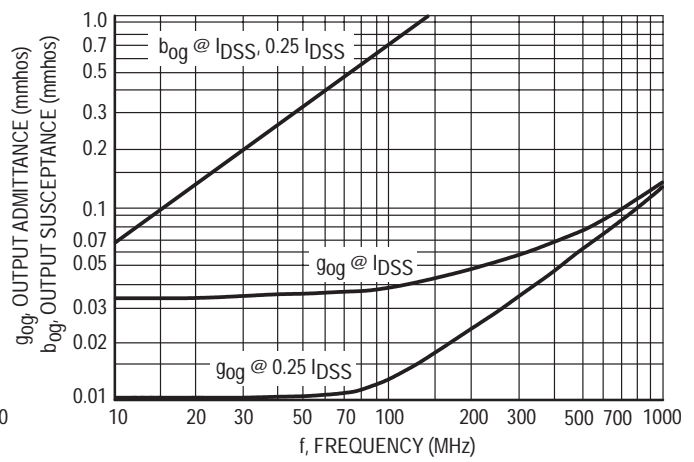


Figure 18. Output Admittance (y_{og})

COMMON GATE CHARACTERISTICS
S-PARAMETERS

($V_{DS} = 15 \text{ Vdc}$, $T_{channel} = 25^\circ\text{C}$, Data Points in MHz)

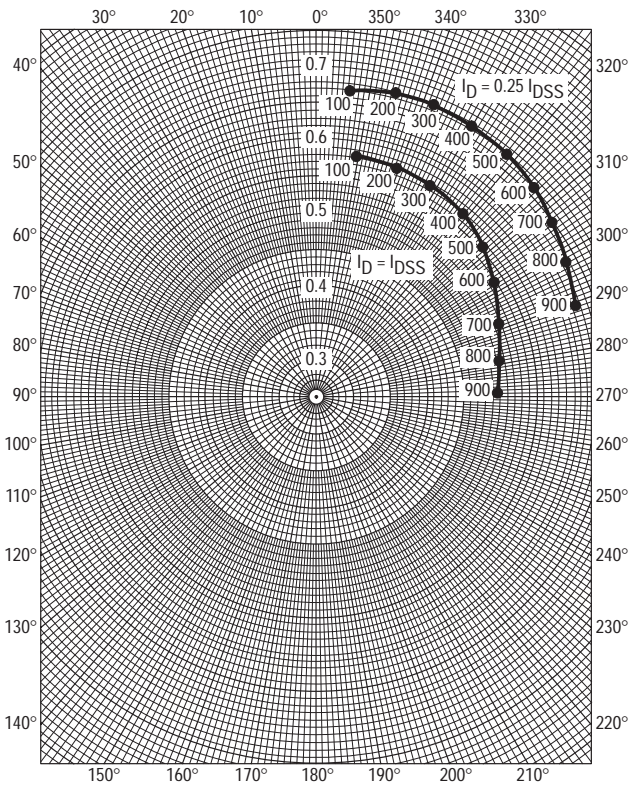


Figure 19. S_{11g}

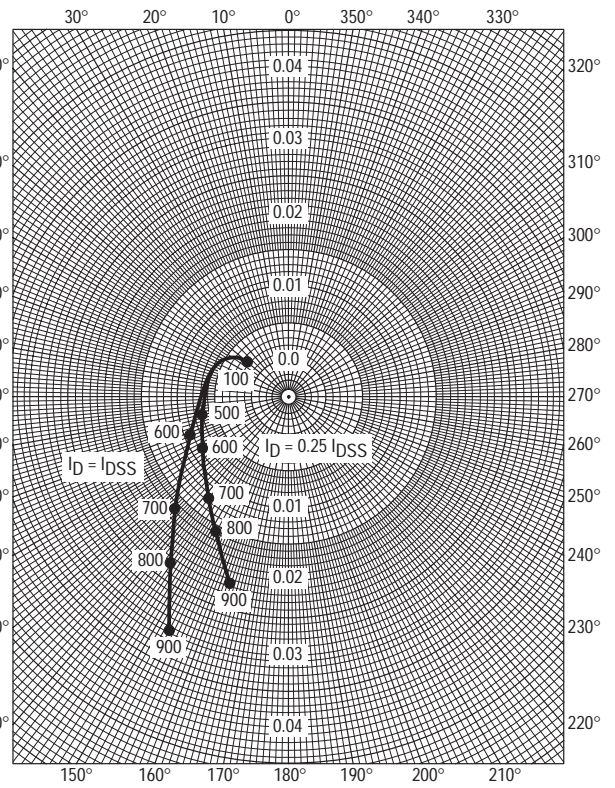


Figure 20. S_{12g}

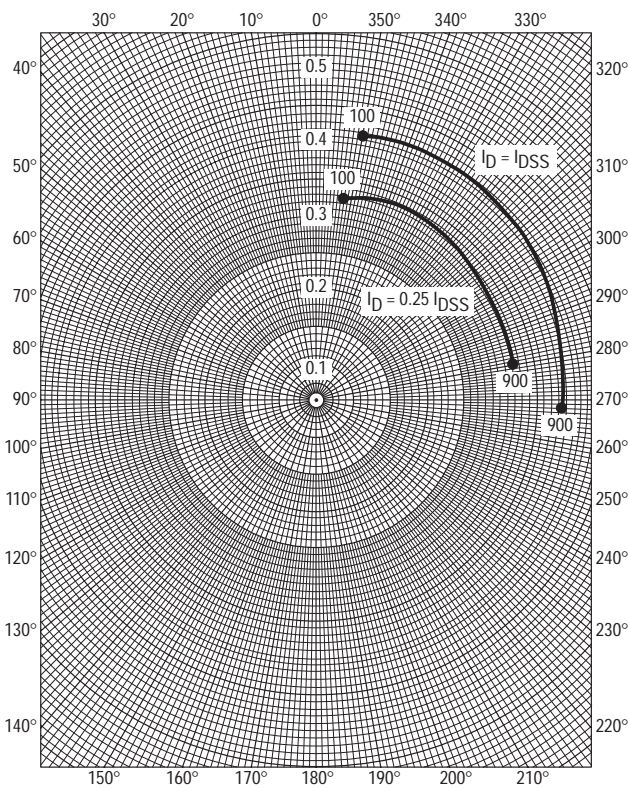


Figure 21. S_{21g}

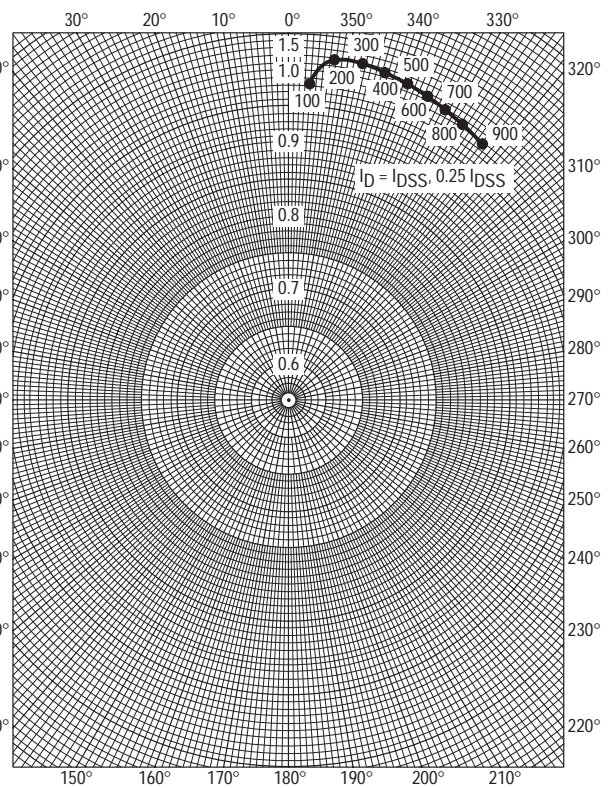
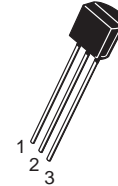
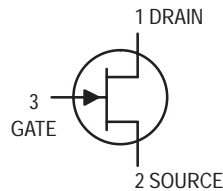


Figure 22. S_{22g}

JFETs Switching

N-Channel — Depletion

2N5640



CASE 29-04, STYLE 5
TO-92 (TO-226AA)

Rating	Symbol	Value	Unit
Drain-Source Voltage	V_{DS}	30	Vdc
Drain-Gate Voltage	V_{DG}	30	Vdc
Reverse Gate-Source Voltage	V_{GSR}	30	Vdc
Forward Gate Current	I_{GF}	10	mAdc
Total Device Dissipation @ $T_A = 25^\circ\text{C}$ Derate above 25°C	P_D	350 2.8	mW mW/°C
Thermal Resistance, Junction to Ambient	$R_{\theta JA}$	357	°C/W
Junction Temperature Range	T_J	-65 to +150	°C
Storage Temperature Range	T_{stg}	-65 to +150	°C

ELECTRICAL CHARACTERISTICS ($T_A = 25^\circ\text{C}$ unless otherwise noted)

Characteristic	Symbol	Min	Max	Unit
OFF CHARACTERISTICS				
Gate-Source Breakdown Voltage ($I_G = 10 \mu\text{Adc}$, $V_{DS} = 0$)	$V_{(BR)GSS}$	30	—	Vdc
Gate Reverse Current ($V_{GS} = -15 \text{ Vdc}$, $V_{DS} = 0$) ($V_{GS} = -15 \text{ Vdc}$, $V_{DS} = 0$, $T_A = 100^\circ\text{C}$)	I_{GSS}	—	1.0 1.0	nAdc μAdc
Drain Cutoff Current ($V_{DS} = 15 \text{ Vdc}$, $V_{GS} = -6.0 \text{ Vdc}$) ($V_{DS} = 15 \text{ Vdc}$, $V_{GS} = -6.0 \text{ Vdc}$, $T_A = 100^\circ\text{C}$)	$I_{D(off)}$	—	1.0 1.0	nAdc μAdc

ON CHARACTERISTICS

Zero-Gate-Voltage Drain Current ⁽¹⁾ ($V_{DS} = 20 \text{ Vdc}$, $V_{GS} = 0$)	I_{DSS}	5.0	—	mAdc
Drain-Source On-Voltage ($I_D = 3.0 \text{ mAdc}$, $V_{GS} = 0$)	$V_{DS(on)}$	—	0.5	Vdc
Static Drain-Source On Resistance ($I_D = 1.0 \text{ mAdc}$, $V_{GS} = 0$)	$r_{DS(on)}$	—	100	Ohms

1. Pulse Test: Pulse Width $\leq 300 \mu\text{s}$, Duty Cycle $\leq 3.0\%$.

ELECTRICAL CHARACTERISTICS ($T_A = 25^\circ\text{C}$ unless otherwise noted) (Continued)

Characteristic		Symbol	Min	Max	Unit	
SMALL-SIGNAL CHARACTERISTICS						
Static Drain-Source "ON" Resistance ($V_{GS} = 0, I_D = 0, f = 1.0 \text{ kHz}$)		$r_{ds(on)}$	—	100	Ohms	
Input Capacitance ($V_{DS} = 0, V_{GS} = -12 \text{ Vdc}, f = 1.0 \text{ MHz}$)		C_{iss}	—	10	pF	
Reverse Transfer Capacitance ($V_{DS} = 0, V_{GS} = -12 \text{ Vdc}, f = 1.0 \text{ MHz}$)		C_{rss}	—	4.0	pF	
SWITCHING CHARACTERISTICS						
Turn-On Delay Time	$V_{DD} = 10 \text{ Vdc},$ $V_{GS(on)} = 0,$ $V_{GS(off)} = -10 \text{ Vdc},$ $R_G' = 50 \Omega$	$I_{D(on)} = 3.0 \text{ mAdc}$	$t_{d(on)}$	—	8.0	ns
Rise Time		$I_{D(on)} = 3.0 \text{ mAdc}$	t_r	—	10	ns
Turn-Off Delay Time		$I_{D(on)} = 3.0 \text{ mAdc}$	$t_{d(off)}$	—	15	ns
Fall Time		$I_{D(on)} = 3.0 \text{ mAdc}$	t_f	—	30	ns

TYPICAL SWITCHING CHARACTERISTICS

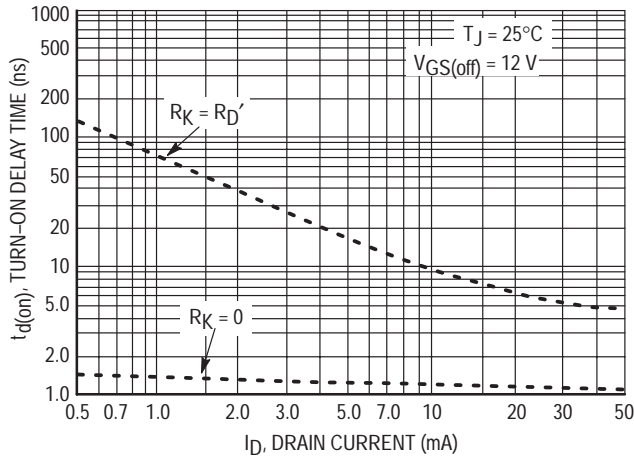


Figure 1. Turn-On Delay Time

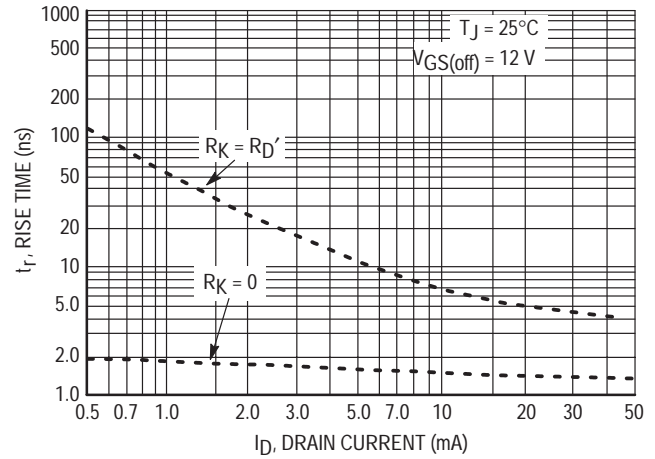


Figure 2. Rise Time

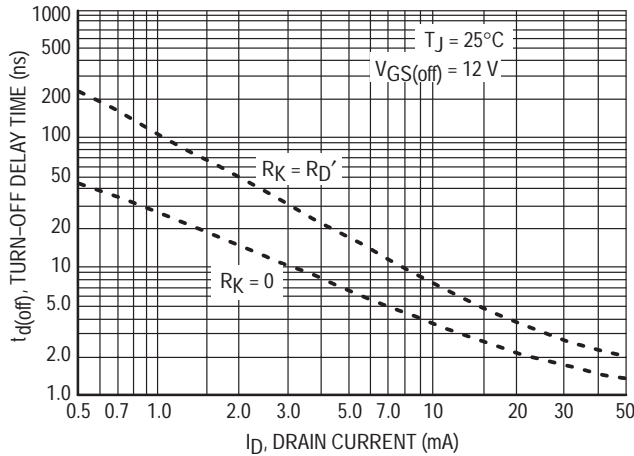


Figure 3. Turn-Off Delay Time

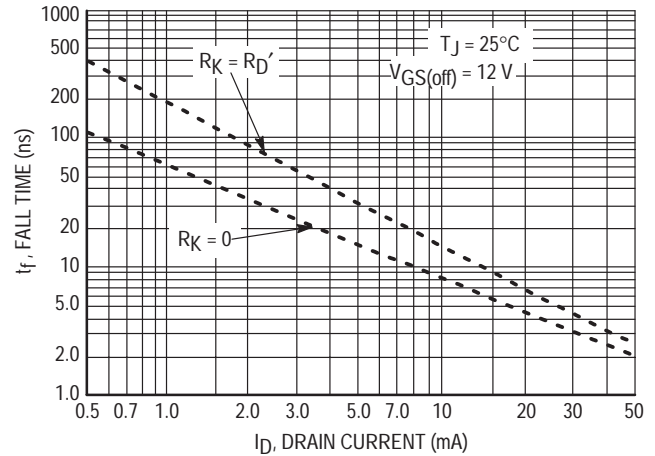


Figure 4. Fall Time

NOTE 1

The switching characteristics shown above were measured using a test circuit similar to Figure 5. At the beginning of the switching interval, the gate voltage is at Gate Supply Voltage ($-V_{GG}$). The Drain-Source Voltage (V_{DS}) is slightly lower than Drain Supply Voltage (V_{DD}) due to the voltage divider. Thus Reverse Transfer Capacitance (C_{RS}) or Gate-Drain Capacitance (C_{gd}) is charged to $V_{GG} + V_{DS}$.

During the turn-on interval, Gate-Source Capacitance (C_{gs}) discharges through the series combination of R_{GEN} and R_K . C_{gd} must discharge to $V_{DS(on)}$ through R_G and R_K in series with the parallel combination of effective load impedance (R'_D) and Drain-Source Resistance (r_{ds}). During the turn-off, this charge flow is reversed.

Predicting turn-on time is somewhat difficult as the channel resistance r_{ds} is a function of the gate-source voltage. While C_{gs} discharges, V_{GS} approaches zero and r_{ds} decreases. Since C_{gd} discharges through r_{ds} , turn-on time is non-linear. During turn-off, the situation is reversed with r_{ds} increasing as C_{gd} charges.

The above switching curves show two impedance conditions; 1) R_K is equal to R_D , which simulates the switching behavior of cascaded stages where the driving source impedance is normally the load impedance of the previous stage, and 2) $R_K = 0$ (low impedance) the driving source impedance is that of the generator.

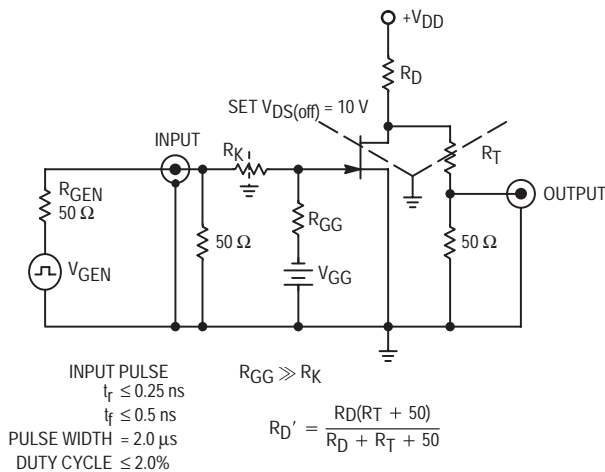


Figure 5. Switching Time Test Circuit

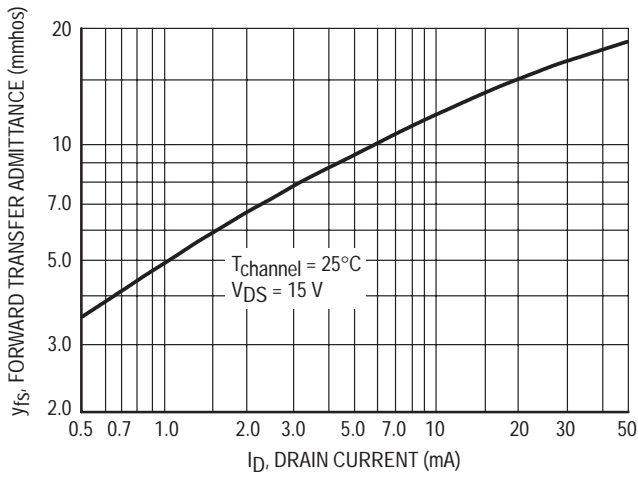


Figure 6. Typical Forward Transfer Admittance

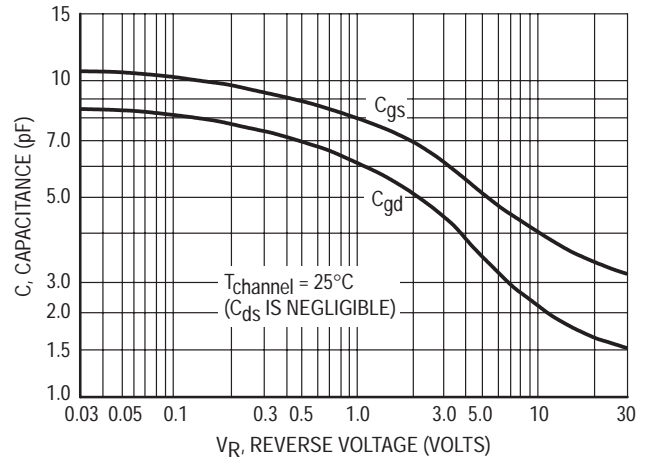


Figure 7. Typical Capacitance

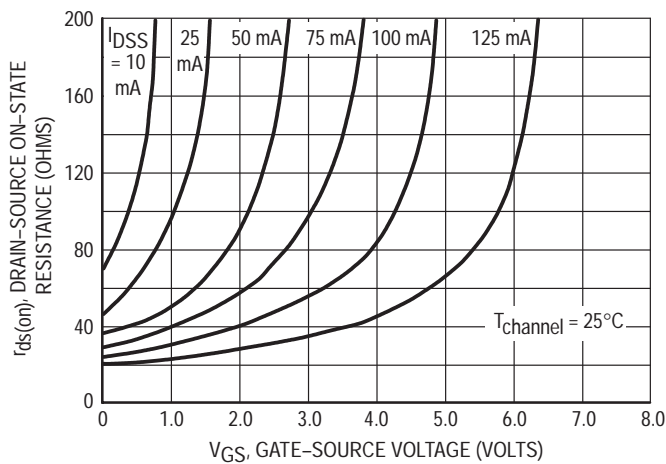


Figure 8. Effect of Gate-Source Voltage On Drain-Source Resistance

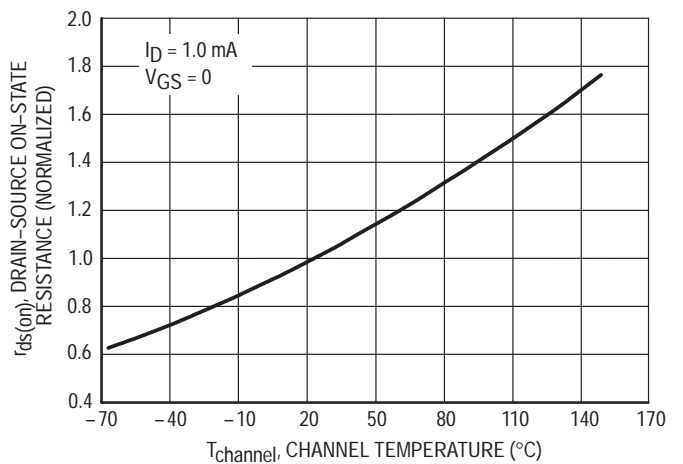


Figure 9. Effect of Temperature On Drain-Source On-State Resistance

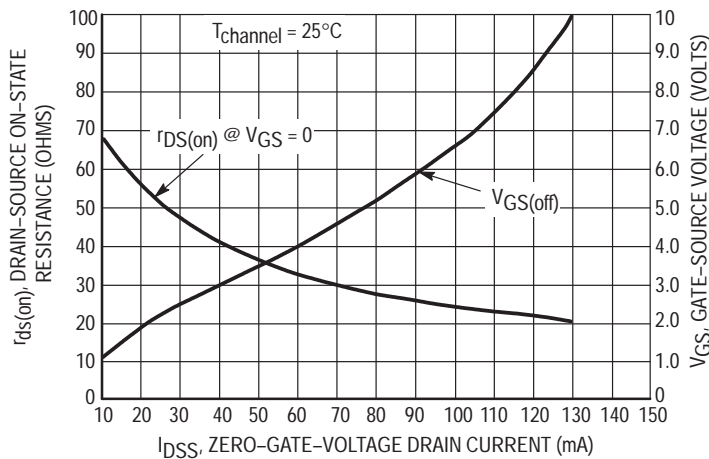


Figure 10. Effect of I_{DSS} On Drain-Source Resistance and Gate-Source Voltage

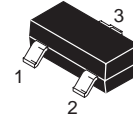
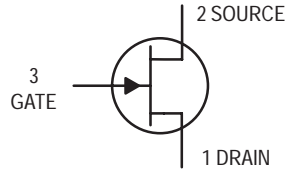
NOTE 2

The Zero-Gate-Voltage Drain Current (I_{DSS}), is the principle determinant of other J-FET characteristics. Figure 10 shows the relationship of Gate-Source Off Voltage ($V_{GS(off)}$) and Drain-Source On Resistance ($r_{ds(on)}$) to I_{DSS} . Most of the devices will be within $\pm 10\%$ of the values shown in Figure 10. This data will be useful in predicting the characteristic variations for a given part number.

JFET Amplifiers

N-Channel

BFR30LT1
BFR31LT1



CASE 318-08, STYLE 10
SOT-23 (TO-236AB)

MAXIMUM RATINGS

Rating	Symbol	Value	Unit
Drain-Source Voltage	V_{DS}	25	Vdc
Gate-Source Voltage	V_{GS}	25	Vdc

THERMAL CHARACTERISTICS

Characteristic	Symbol	Max	Unit
Total Device Dissipation ⁽¹⁾ $T_A = 25^\circ\text{C}$ Derate above 25°C	P_D	225 1.8	mW mW/ $^\circ\text{C}$
Thermal Resistance Junction to Ambient	$R_{\theta JA}$	556	$^\circ\text{C}/\text{W}$
Total Device Dissipation Alumina Substrate, ⁽²⁾ $T_A = 25^\circ\text{C}$ Derate above 25°C	P_D	300 2.4	mW mW/ $^\circ\text{C}$
Thermal Resistance Junction to Ambient	$R_{\theta JA}$	417	$^\circ\text{C}/\text{W}$
Junction and Storage Temperature	T_J, T_{stg}	-55 to +150	$^\circ\text{C}$

DEVICE MARKING

BFR30LT1 = M1; BFR31LT1 = M2

ELECTRICAL CHARACTERISTICS ($T_A = 25^\circ\text{C}$ unless otherwise noted)

Characteristic	Symbol	Min	Max	Unit
----------------	--------	-----	-----	------

OFF CHARACTERISTICS

Gate Reverse Current	($V_{GS} = 10 \text{ Vdc}, V_{DS} = 0$)	I_{GSS}	—	0.2	nAdc	
Gate Source Cutoff Voltage	($I_D = 0.5 \text{ nAdc}, V_{DS} = 10 \text{ Vdc}$)	BFR30	$V_{GS(OFF)}$	—	5.0	Vdc
		BFR31		—	2.5	
Gate Source Voltage	($I_D = 1.0 \text{ mAdc}, V_{DS} = 10 \text{ Vdc}$)	BFR30	V_{GS}	-0.7	-3.0	Vdc
		BFR31		—	-1.3	
	($I_D = 50 \mu\text{Adc}, V_{DS} = 10 \text{ Vdc}$)	BFR30		—	-4.0	
		BFR31		—	-2.0	

1. Device mounted on FR4 glass epoxy printed circuit board using the recommended footprint.
2. Alumina = 0.4 x 0.3 x 0.024 in. 99.5% alumina.

ELECTRICAL CHARACTERISTICS ($T_A = 25^\circ\text{C}$ unless otherwise noted) (Continued)

Characteristic		Symbol	Min	Max	Unit
ON CHARACTERISTICS					
Zero-Gate-Voltage Drain Current ($V_{DS} = 10\text{ Vdc}$, $V_{GS} = 0$)	BFR30 BFR31	I_{DSS}	4.0 1.0	10 5.0	mAdc
SMALL-SIGNAL CHARACTERISTICS					
Forward Transconductance ($I_D = 1.0\text{ mAdc}$, $V_{DS} = 10\text{ Vdc}$, $f = 1.0\text{ kHz}$) ($I_D = 200\text{ }\mu\text{Adc}$, $V_{DS} = 10\text{ Vdc}$, $f = 1.0\text{ kHz}$)	BFR30 BFR31 BFR30 BFR31	$ y_{fs} $	1.0 1.5 0.5 0.75	4.0 4.5 — —	mAdc
Output Admittance ($I_D = 1.0\text{ mAdc}$, $V_{DS} = 10\text{ Vdc}$, $f = 1.0\text{ kHz}$) ($I_D = 200\text{ }\mu\text{Adc}$, $V_{DS} = 10\text{ Vdc}$)	BFR30 BFR31	$ y_{os} $	40 20	25 15	μAdc
Input Capacitance ($I_D = 1.0\text{ mAdc}$, $V_{DS} = 10\text{ Vdc}$, $f = 1.0\text{ MHz}$) ($I_D = 200\text{ }\mu\text{Adc}$, $V_{DS} = 10\text{ Vdc}$, $f = 1.0\text{ MHz}$)		C_{iss}	— —	5.0 4.0	pF
Reverse Transfer Capacitance ($I_D = 1.0\text{ mAdc}$, $V_{DS} = 10\text{ Vdc}$, $f = 1.0\text{ MHz}$) ($I_D = 200\text{ }\mu\text{Adc}$, $V_{DS} = 10\text{ Vdc}$, $f = 1.0\text{ MHz}$)		C_{rss}	— —	1.5 1.5	pF

TYPICAL CHARACTERISTICS

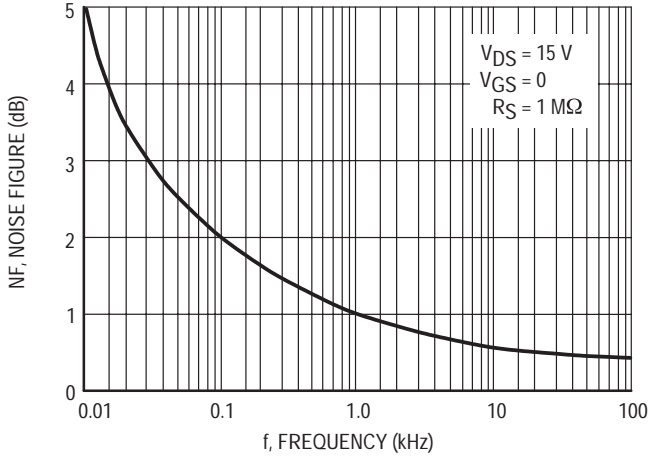


Figure 1. Noise Figure versus Frequency

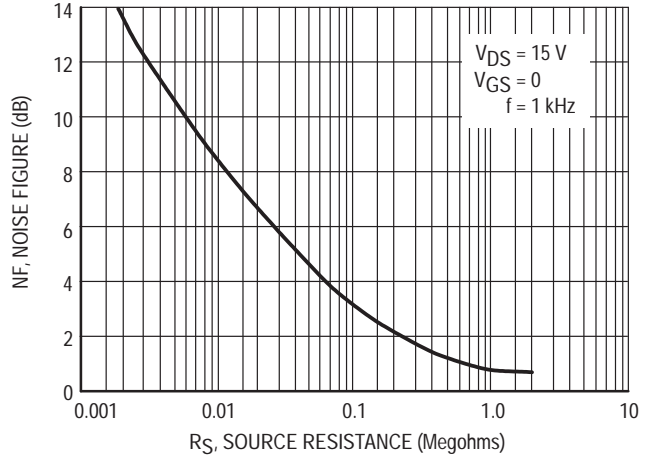


Figure 2. Noise Figure versus Source Resistance

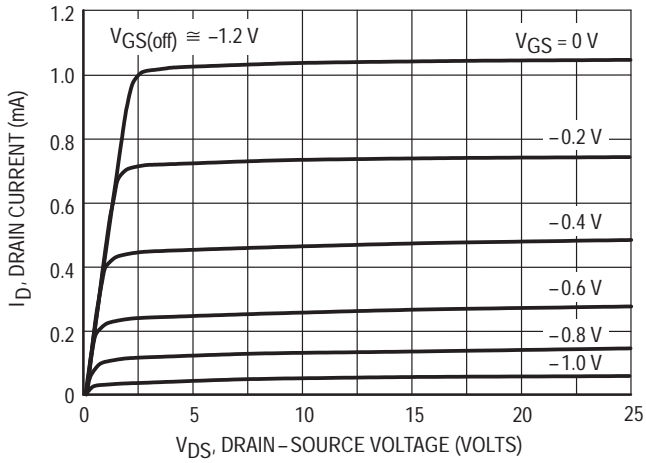


Figure 3. Typical Drain Characteristics

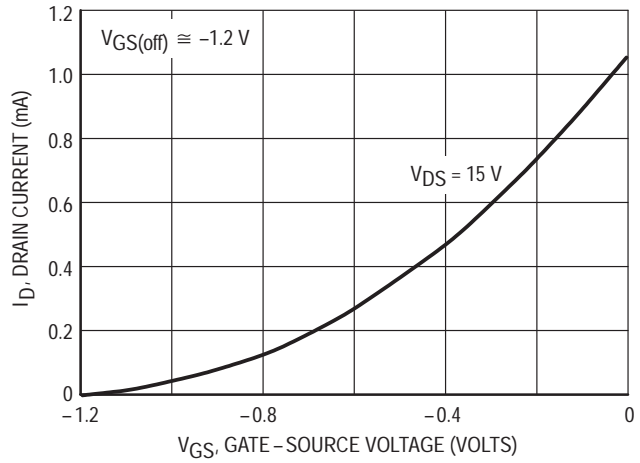


Figure 4. Common Source Transfer Characteristics

TYPICAL CHARACTERISTICS

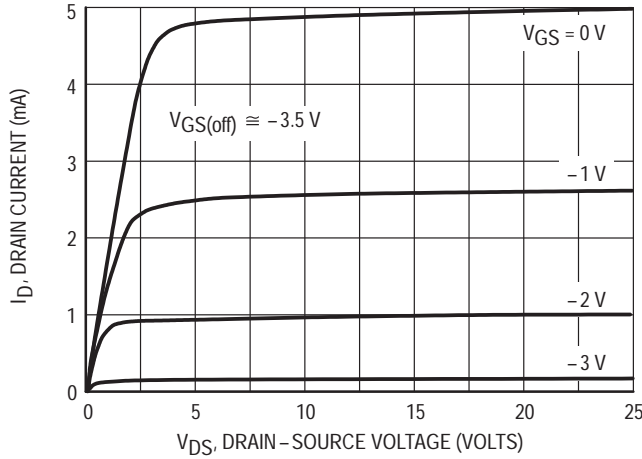


Figure 5. Typical Drain Characteristics

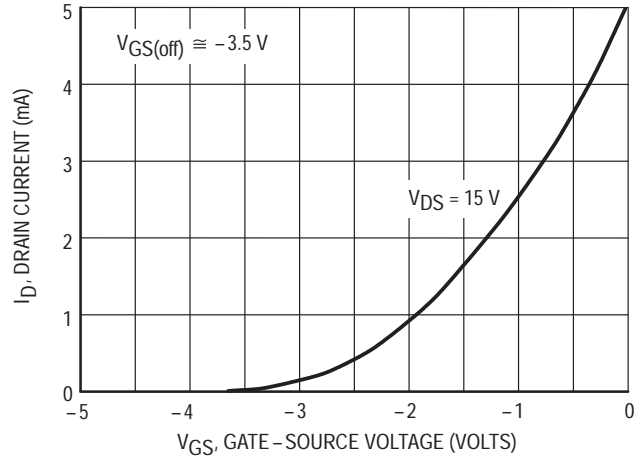


Figure 6. Common Source Transfer Characteristics

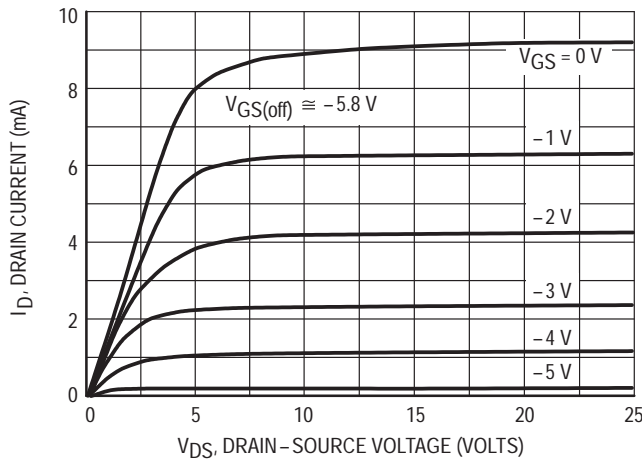


Figure 7. Typical Drain Characteristics

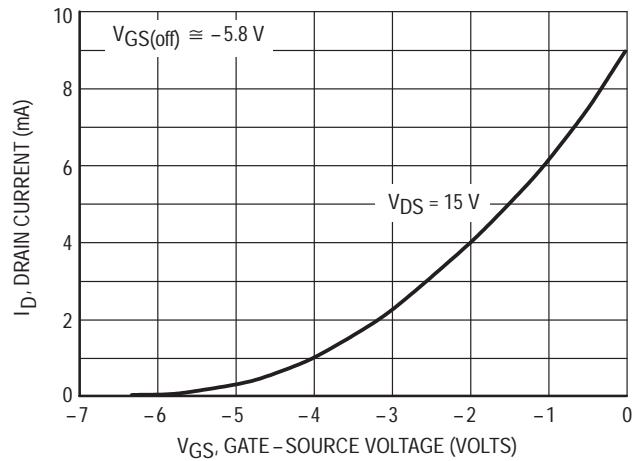
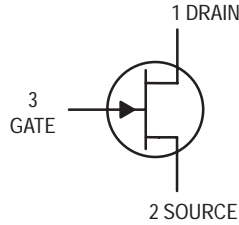


Figure 8. Common Source Transfer Characteristics

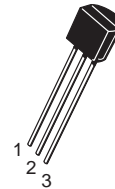
Note: Graphical data is presented for dc conditions. Tabular data is given for pulsed conditions (Pulse Width = 630 ms, Duty Cycle = 10%). Under dc conditions, self heating in higher I_{DSS} units reduces I_{DSS} .

JFET Chopper Transistor

N-Channel — Depletion



J112



CASE 29-04, STYLE 5
TO-92 (TO-226AA)

MAXIMUM RATINGS

Rating	Symbol	Value	Unit
Drain–Gate Voltage	V_{DG}	–35	Vdc
Gate–Source Voltage	V_{GS}	–35	Vdc
Gate Current	I_G	50	mAdc
Total Device Dissipation @ $T_A = 25^\circ\text{C}$ Derate above 25°C	P_D	350 2.8	mW mW/ $^\circ\text{C}$
Lead Temperature	T_L	300	$^\circ\text{C}$
Operating and Storage Junction Temperature Range	T_J, T_{stg}	–65 to +150	$^\circ\text{C}$

ELECTRICAL CHARACTERISTICS ($T_A = 25^\circ\text{C}$ unless otherwise noted)

Characteristic	Symbol	Min	Max	Unit
----------------	--------	-----	-----	------

OFF CHARACTERISTICS

Gate–Source Breakdown Voltage ($I_G = -1.0 \mu\text{Adc}$)	$V_{(BR)GSS}$	35	—	Vdc
Gate Reverse Current ($V_{GS} = -15 \text{Vdc}$)	I_{GSS}	—	–1.0	nAdc
Gate Source Cutoff Voltage ($V_{DS} = 5.0 \text{Vdc}$, $I_D = 1.0 \mu\text{Adc}$)	$V_{GS(off)}$	–1.0	–5.0	Vdc
Drain–Cutoff Current ($V_{DS} = 5.0 \text{Vdc}$, $V_{GS} = -10 \text{Vdc}$)	$I_{D(off)}$	—	1.0	nAdc

ON CHARACTERISTICS

Zero–Gate–Voltage Drain Current ⁽¹⁾ ($V_{DS} = 15 \text{Vdc}$)	I_{DSS}	5.0	—	mAdc
Static Drain–Source On Resistance ($V_{DS} = 0.1 \text{Vdc}$)	$r_{DS(on)}$	—	50	Ω
Drain Gate and Source Gate On–Capacitance ($V_{DS} = V_{GS} = 0$, $f = 1.0 \text{MHz}$)	$C_{dg(on)}$ + $C_{sg(on)}$	—	28	pF
Drain Gate Off–Capacitance ($V_{GS} = -10 \text{Vdc}$, $f = 1.0 \text{MHz}$)	$C_{dg(off)}$	—	5.0	pF
Source Gate Off–Capacitance ($V_{GS} = -10 \text{Vdc}$, $f = 1.0 \text{MHz}$)	$C_{sg(off)}$	—	5.0	pF

1. Pulse Width = 300 μs , Duty Cycle = 3.0%.

(Replaces J111/D)

TYPICAL SWITCHING CHARACTERISTICS

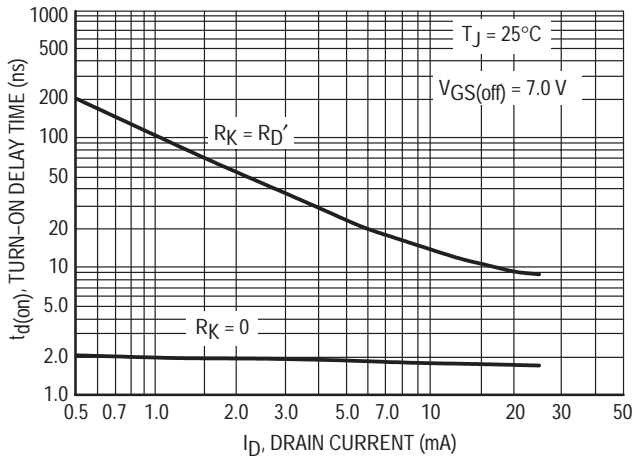


Figure 1. Turn-On Delay Time

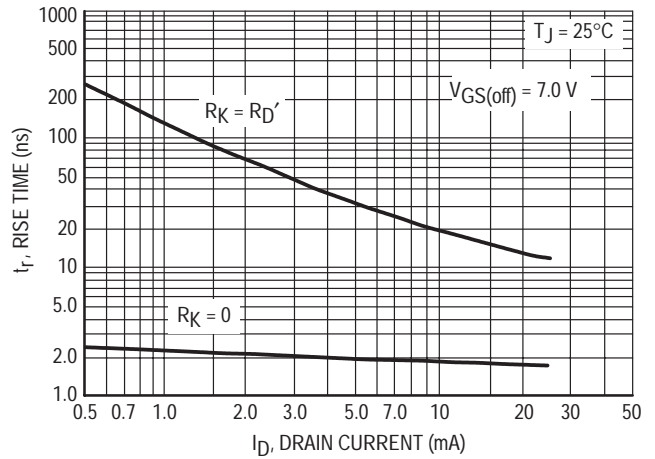


Figure 2. Rise Time

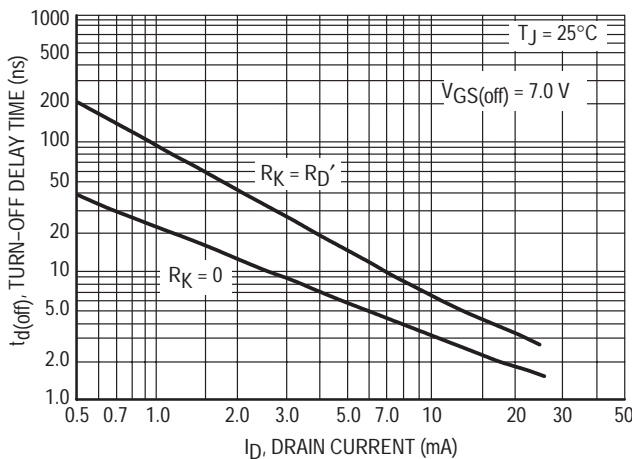


Figure 3. Turn-Off Delay Time

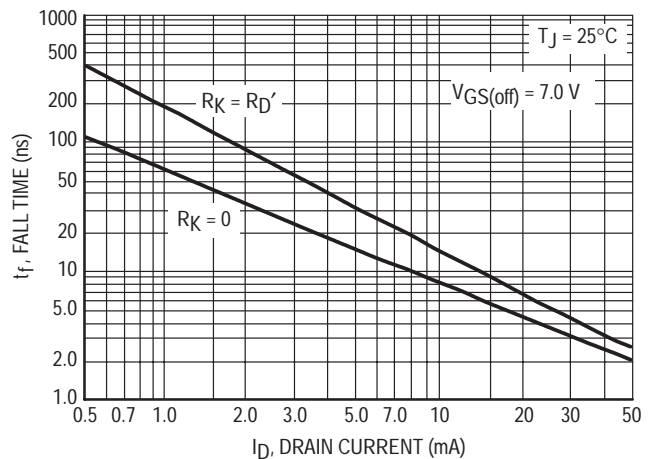


Figure 4. Fall Time

NOTE 1

The switching characteristics shown above were measured using a test circuit similar to Figure 5. At the beginning of the switching interval, the gate voltage is at Gate Supply Voltage ($-V_{GG}$). The Drain-Source Voltage (V_{DS}) is slightly lower than Drain Supply Voltage (V_{DD}) due to the voltage divider. Thus Reverse Transfer Capacitance (C_{rss}) or Gate-Drain Capacitance (C_{gd}) is charged to $V_{GG} + V_{DS}$.

During the turn-on interval, Gate-Source Capacitance (C_{gs}) discharges through the series combination of R_{Gen} and R_K . C_{gd} must discharge to $V_{DS(on)}$ through R_G and R_K in series with the parallel combination of effective load impedance (R'_D) and Drain-Source Resistance (r_{ds}). During the turn-off, this charge flow is reversed.

Predicting turn-on time is somewhat difficult as the channel resistance r_{ds} is a function of the gate-source voltage. While C_{gs} discharges, V_{GS} approaches zero and r_{ds} decreases. Since C_{gd} discharges through r_{ds} , turn-on time is non-linear. During turn-off, the situation is reversed with r_{ds} increasing as C_{gd} charges.

The above switching curves show two impedance conditions; 1) R_K is equal to R_D , which simulates the switching behavior of cascaded stages where the driving source impedance is normally the load impedance of the previous stage, and 2) $R_K = 0$ (low impedance) the driving source impedance is that of the generator.

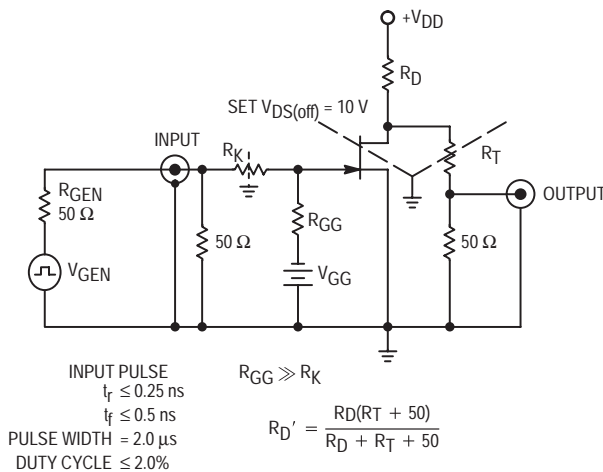


Figure 5. Switching Time Test Circuit

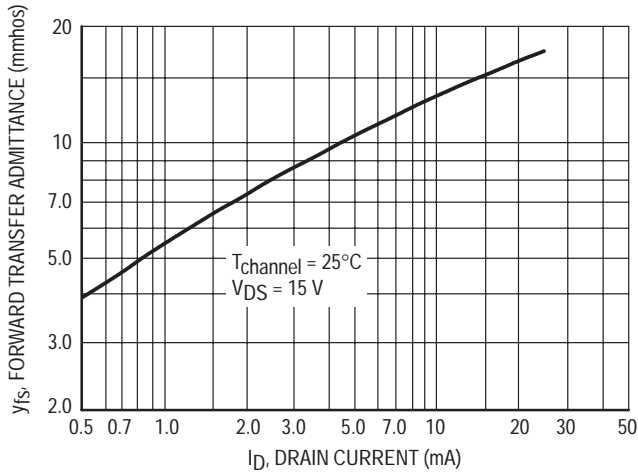


Figure 6. Typical Forward Transfer Admittance

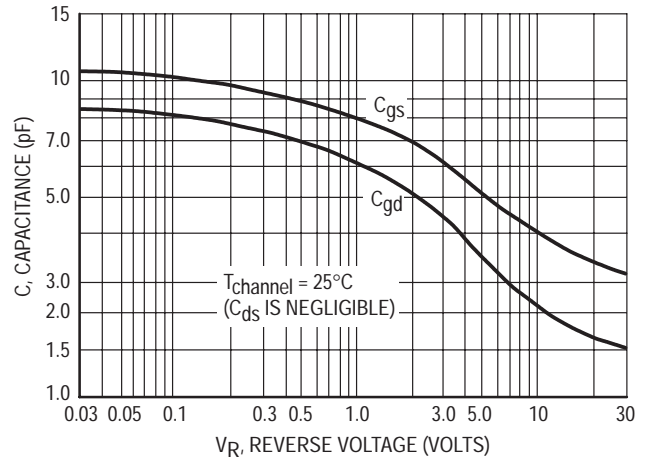


Figure 7. Typical Capacitance

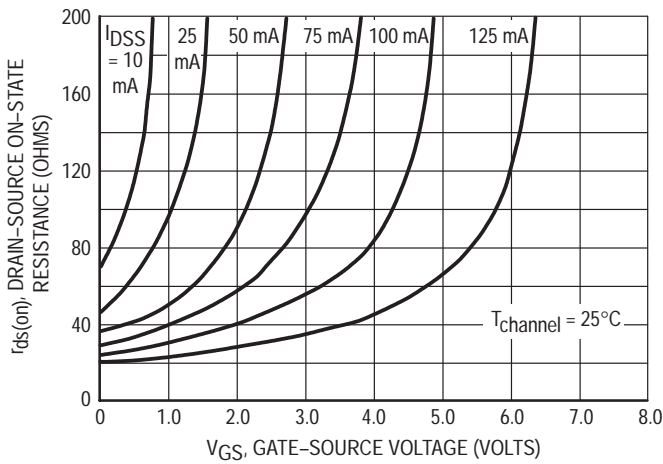


Figure 8. Effect of Gate-Source Voltage On Drain-Source Resistance

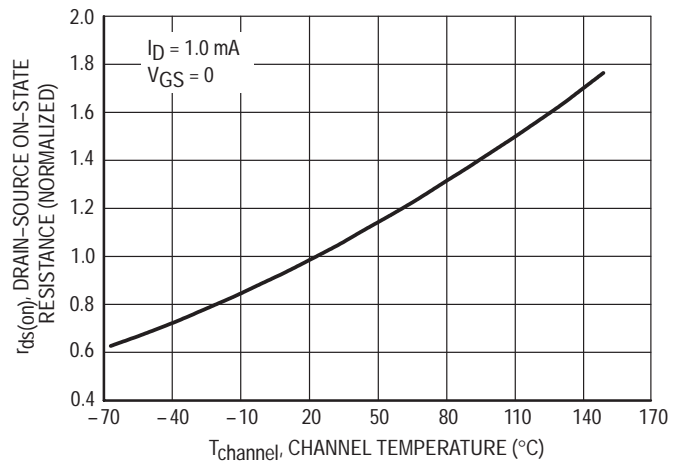


Figure 9. Effect of Temperature On Drain-Source On-State Resistance

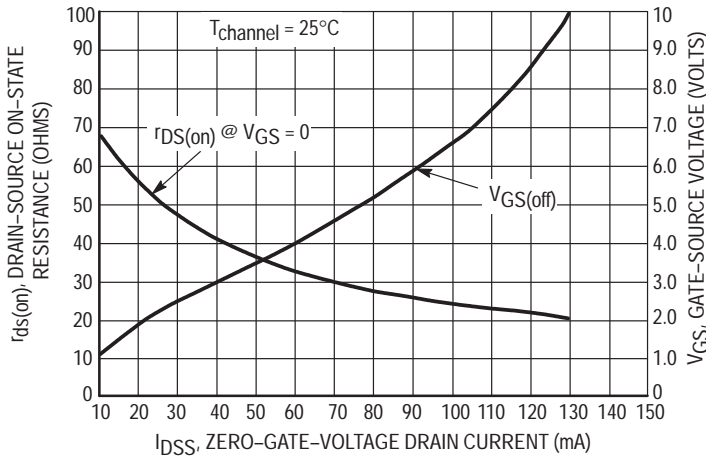


Figure 10. Effect of IDSS On Drain-Source Resistance and Gate-Source Voltage

NOTE 2

The Zero-Gate-Voltage Drain Current (I_{DSS}), is the principle determinant of other J-FET characteristics. Figure 10 shows the relationship of Gate-Source Off Voltage ($V_{GS(off)}$) and Drain-Source On Resistance ($r_{ds(on)}$) to I_{DSS} . Most of the devices will be within $\pm 10\%$ of the values shown in Figure 10. This data will be useful in predicting the characteristic variations for a given part number.

For example:

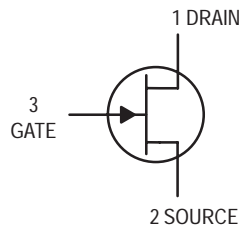
Unknown

$r_{ds(on)}$ and V_{GS} range for an J112

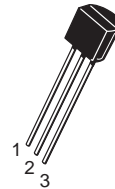
The electrical characteristics table indicates that an J112 has an I_{DSS} range of 25 to 75 mA. Figure 10, shows $r_{ds(on)} = 52$ Ohms for $I_{DSS} = 25$ mA and 30 Ohms for $I_{DSS} = 75$ mA. The corresponding V_{GS} values are 2.2 volts and 4.8 volts.

JFETs Low Frequency/ Low Noise

N-Channel — Depletion



J202



CASE 29-04, STYLE 5
TO-92 (TO-226AA)

MAXIMUM RATINGS

Rating	Symbol	Value	Unit
Drain-Source Voltage	V_{DS}	40	Vdc
Drain-Gate Voltage	V_{DG}	40	Vdc
Gate-Source Voltage	V_{GS}	40	Vdc
Gate Current	I_G	50	mAdc
Total Device Dissipation @ $T_A = 25^\circ\text{C}$ Derate above 25°C	P_D	310 2.82	mW mW/ $^\circ\text{C}$
Storage Temperature Range	T_{stg}	-65 to +150	$^\circ\text{C}$

ELECTRICAL CHARACTERISTICS ($T_A = 25^\circ\text{C}$ unless otherwise noted)

Characteristic	Symbol	Min	Max	Unit
----------------	--------	-----	-----	------

OFF CHARACTERISTICS

Gate-Source Breakdown Voltage ($I_G = -1.0 \mu\text{Adc}$)	$V_{(BR)GSS}$	-40	—	Vdc
Gate Reverse Current ($V_{GS} = -20 \text{Vdc}$)	I_{GSS}	—	-100	pA
Gate Source Cutoff Voltage ($V_{DS} = 20 \text{Vdc}$, $I_D = 10 \text{nAdc}$)	$V_{GS(off)}$	-0.8	-4.0	Vdc

ON CHARACTERISTICS

Zero-Gate-Voltage Drain Current ⁽¹⁾ ($V_{DS} = 20 \text{Vdc}$)	I_{DSS}	0.9	4.5	mAdc
--------------------------------------------------------------------------------	-----------	-----	-----	------

SMALL-SIGNAL CHARACTERISTICS

Forward Transfer Admittance ⁽¹⁾ ($V_{DS} = 20 \text{Vdc}$, $f = 1.0 \text{kHz}$)	$ y_{fs} $	1000	—	μhos
---------------------------------------------------------------------------------------------------	------------	------	---	-----------------

1. Pulse Width $\leq 2.0 \text{ms}$.

TYPICAL CHARACTERISTICS

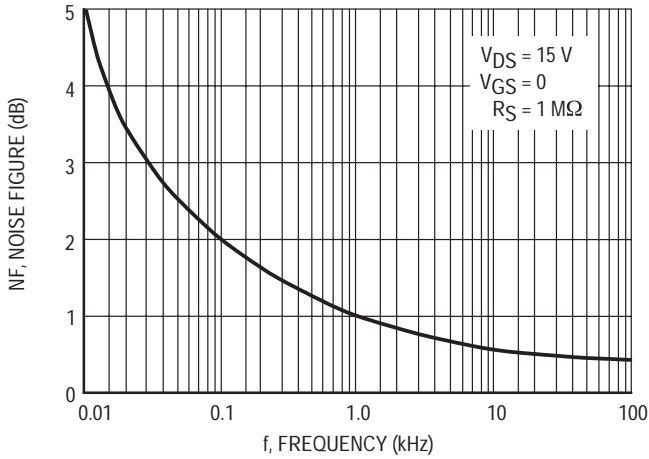


Figure 1. Noise Figure versus Frequency

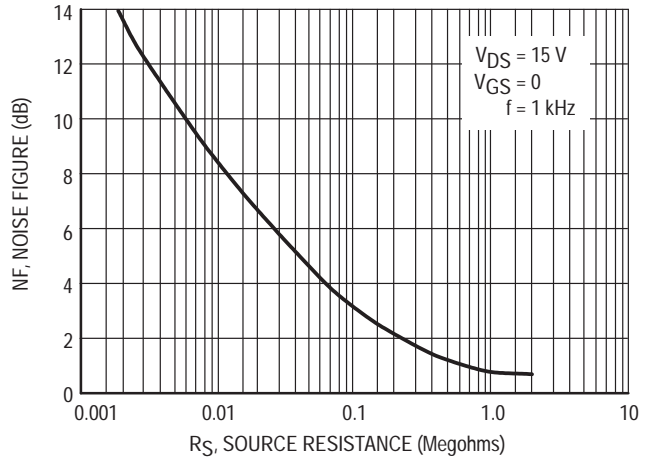


Figure 2. Noise Figure versus Source Resistance

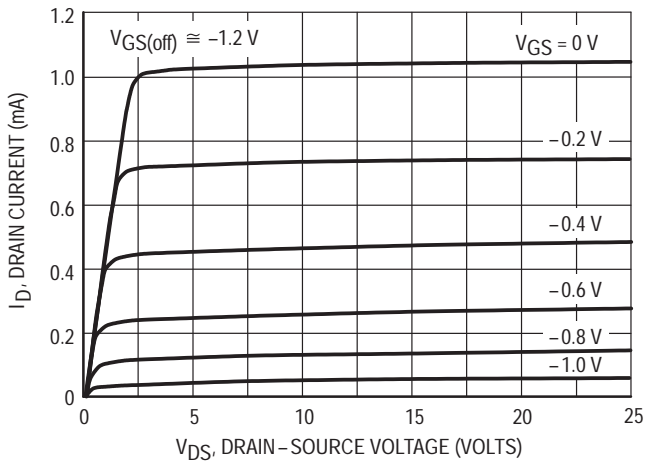


Figure 3. Typical Drain Characteristics

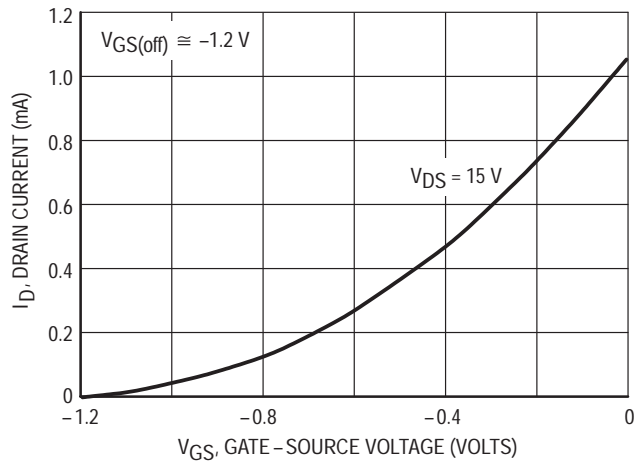


Figure 4. Common Source Transfer Characteristics

TYPICAL CHARACTERISTICS

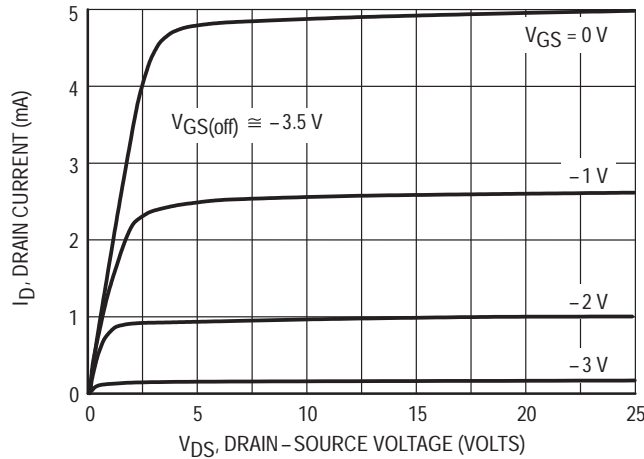


Figure 5. Typical Drain Characteristics

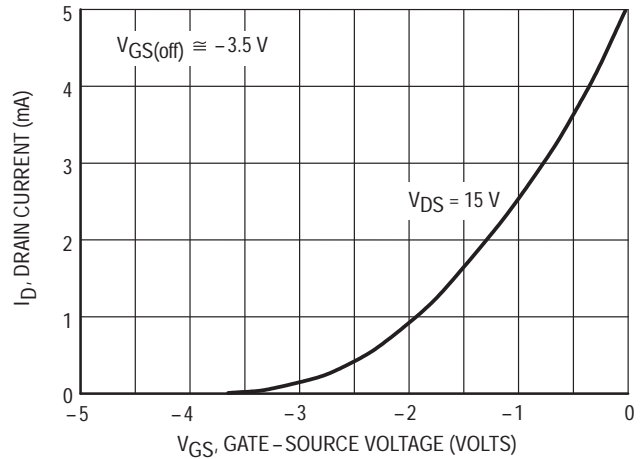


Figure 6. Common Source Transfer Characteristics

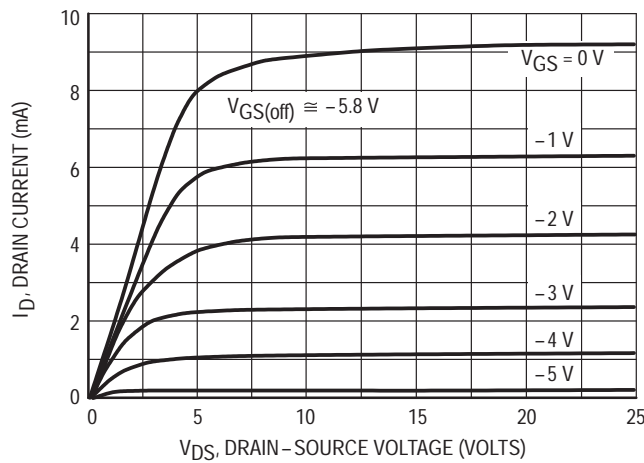


Figure 7. Typical Drain Characteristics

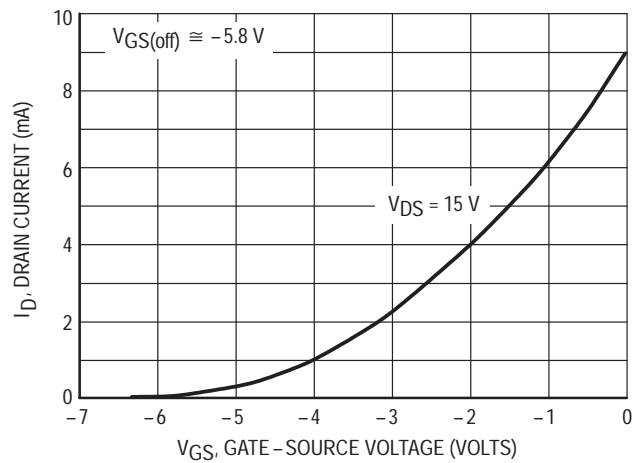
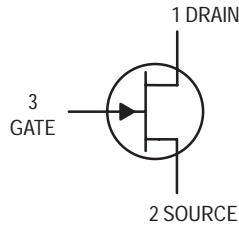


Figure 8. Common Source Transfer Characteristics

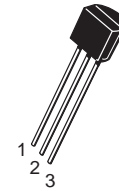
Note: Graphical data is presented for dc conditions. Tabular data is given for pulsed conditions (Pulse Width = 630 ms, Duty Cycle = 10%). Under dc conditions, self heating in higher I_{DSS} units reduces I_{DSS} .

JFET High Frequency Amplifier

N-Channel — Depletion



J304



CASE 29-04, STYLE 5
TO-92 (TO-226AA)

MAXIMUM RATINGS

Rating	Symbol	Value	Unit
Drain-Source Voltage	V_{DS}	-30	Vdc
Gate-Source Voltage	V_{GS}	-30	Vdc
Gate Current	I_G	10	mA
Total Device Dissipation @ $T_A = 25^\circ\text{C}$ Derate above 25°C	P_D	350 2.8	mW mW/ $^\circ\text{C}$
Lead Temperature (1/16" from Case for 10 Seconds)	T_L	300	$^\circ\text{C}$
Operating and Storage Junction Temperature Range	T_J, T_{stg}	-65 to +150	$^\circ\text{C}$

ELECTRICAL CHARACTERISTICS ($T_A = 25^\circ\text{C}$ unless otherwise noted)

Characteristic	Symbol	Min	Max	Unit
----------------	--------	-----	-----	------

OFF CHARACTERISTICS

Gate-Source Breakdown Voltage ($I_G = 1.0 \mu\text{Adc}$, $V_{DS} = 0$)	$V_{(BR)GSS}$	30	—	Vdc
Gate Reverse Current ($V_{GS} = -20 \text{ Vdc}$, $V_{DS} = 0$)	I_{GSS}	—	100	pA
Gate-Source Cutoff Voltage ($V_{DS} = 15 \text{ Vdc}$, $I_D = 1.0 \text{ nAdc}$)	$V_{GS(off)}$	-2.0	-6.0	Vdc

ON CHARACTERISTICS

Zero-Gate-Voltage Drain Current ($V_{DS} = 15 \text{ Vdc}$, $V_{GS} = 0$)	I_{DSS}	5.0	15	mA
---------------------------------------------------------------------------------	-----------	-----	----	----

SMALL-SIGNAL CHARACTERISTICS

Output Admittance ($V_{DS} = 15 \text{ Vdc}$, $V_{GS} = 0$, $f = 1.0 \text{ kHz}$)	$ y_{os} $	—	50	μmhos
Forward Transconductance ($V_{DS} = 15 \text{ Vdc}$, $V_{GS} = 0$, $f = 1.0 \text{ kHz}$)	$\text{Re}(y_{fs})$	4500	7500	μmhos

POWER GAIN

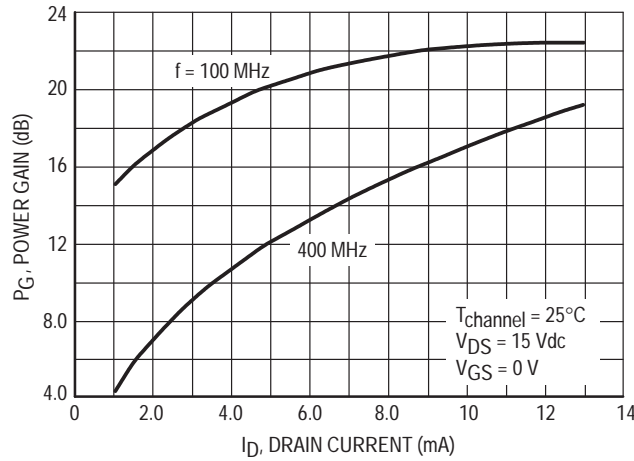
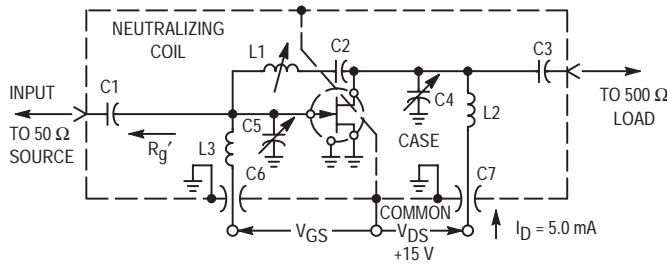


Figure 1. Effects of Drain Current



Adjust V_{GS} for $I_D = 50$ mA
 $V_{GS} < 0$ Volts

NOTE: The noise source is a hot-cold body (AIL type 70 or equivalent) with a test receiver (AIL type 136 or equivalent).

Reference Designation	VALUE	
	100 MHz	400 MHz
C1	7.0 pF	1.8 pF
C2	1000 pF	17 pF
C3	3.0 pF	1.0 pF
C4	1-12 pF	0.8-8.0 pF
C5	1-12 pF	0.8-8.0 pF
C6	0.0015 μ F	0.001 μ F
C7	0.0015 μ F	0.001 μ F
L1	3.0 μ H*	0.2 μ H**
L2	0.15 μ H*	0.03 μ H**
L3	0.14 μ H*	0.022 μ H**

- *L1 17 turns, (approx. — depends upon circuit layout) AWG #28 enameled copper wire, close wound on 9/32" ceramic coil form. Tuning provided by a powdered iron slug.
- L2 4-1/2 turns, AWG #18 enameled copper wire, 5/16" long, 3/8" I.D. (AIR CORE).
- L3 3-1/2 turns, AWG #18 enameled copper wire, 1/4" long, 3/8" I.D. (AIR CORE).

- **L1 6 turns, (approx. — depends upon circuit layout) AWG #24 enameled copper wire, close wound on 7/32" ceramic coil form. Tuning provided by an aluminum slug.
- L2 1 turn, AWG #16 enameled copper wire, 3/8" I.D. (AIR CORE).
- L3 1/2 turn, AWG #16 enameled copper wire, 1/4" I.D. (AIR CORE).

Figure 2. 100 MHz and 400 MHz Neutralized Test Circuit

NOISE FIGURE

($T_{channel} = 25^{\circ}C$)

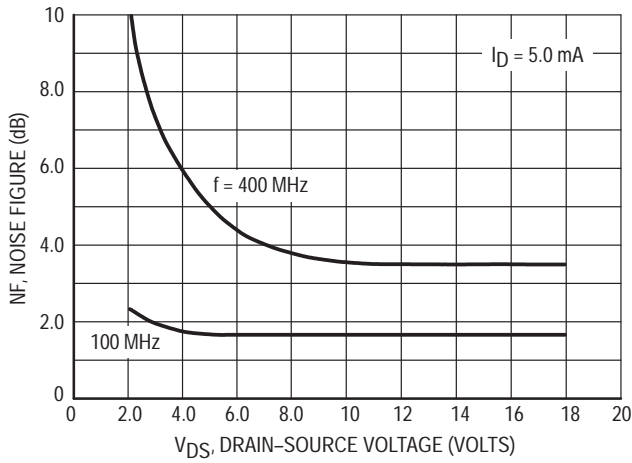


Figure 3. Effects of Drain-Source Voltage

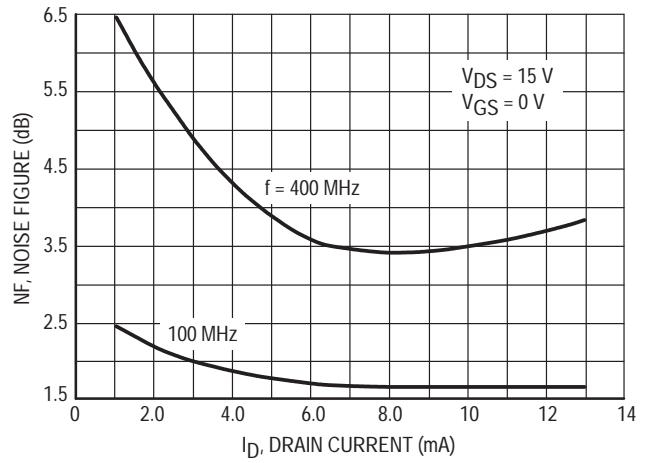


Figure 4. Effects of Drain Current

INTERMODULATION CHARACTERISTICS

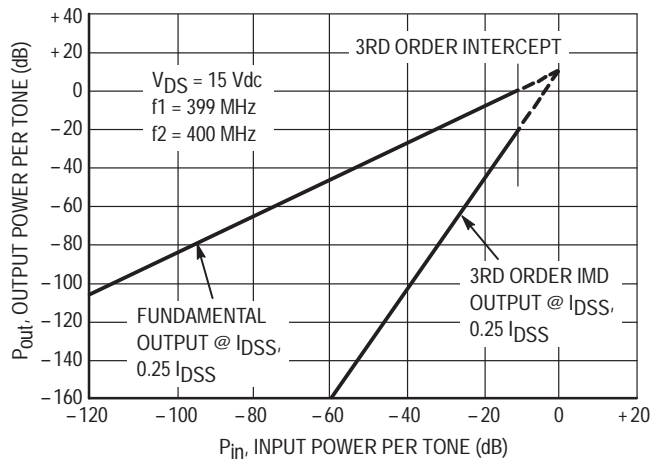


Figure 5. Third Order Intermodulation Distortion

COMMON SOURCE CHARACTERISTICS

ADMITTANCE PARAMETERS

($V_{DS} = 15 \text{ Vdc}$, $T_{channel} = 25^\circ\text{C}$)

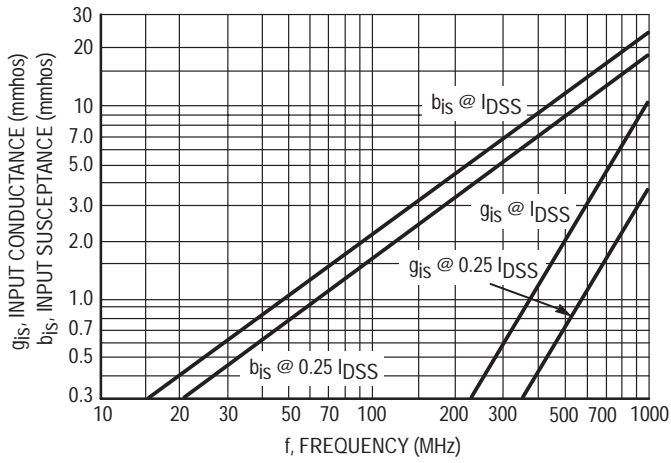


Figure 6. Input Admittance (y_{is})

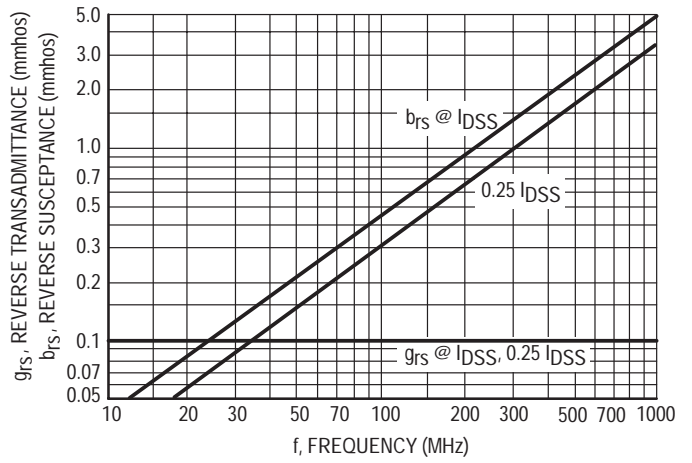


Figure 7. Reverse Transfer Admittance (y_{rs})

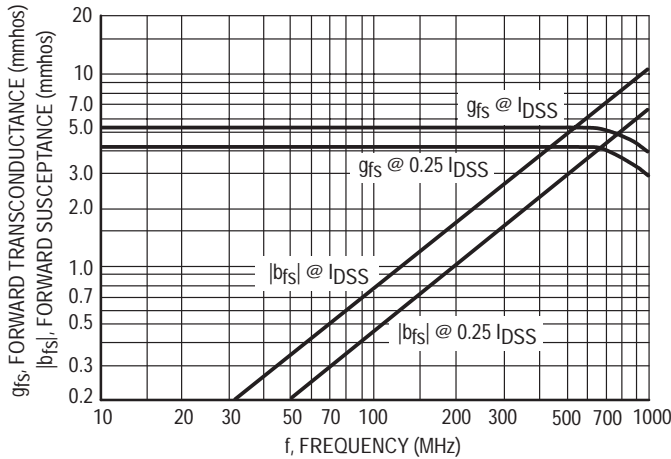


Figure 8. Forward Transadmittance (y_{fs})

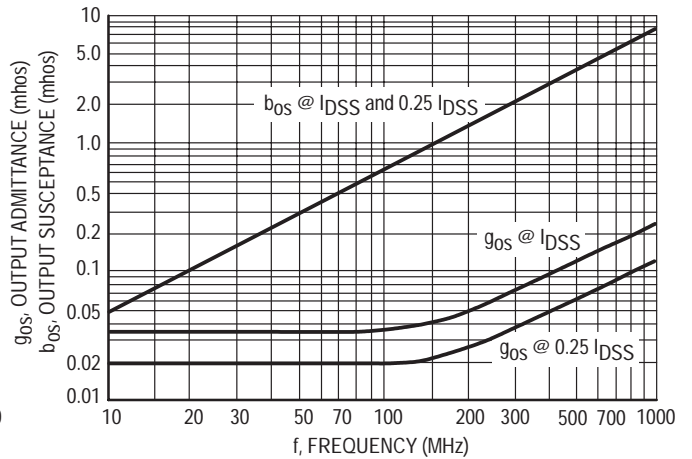


Figure 9. Output Admittance (y_{os})

COMMON SOURCE CHARACTERISTICS
S-PARAMETERS
 ($V_{DS} = 15 \text{ Vdc}$, $T_{\text{channel}} = 25^\circ\text{C}$, Data Points in MHz)

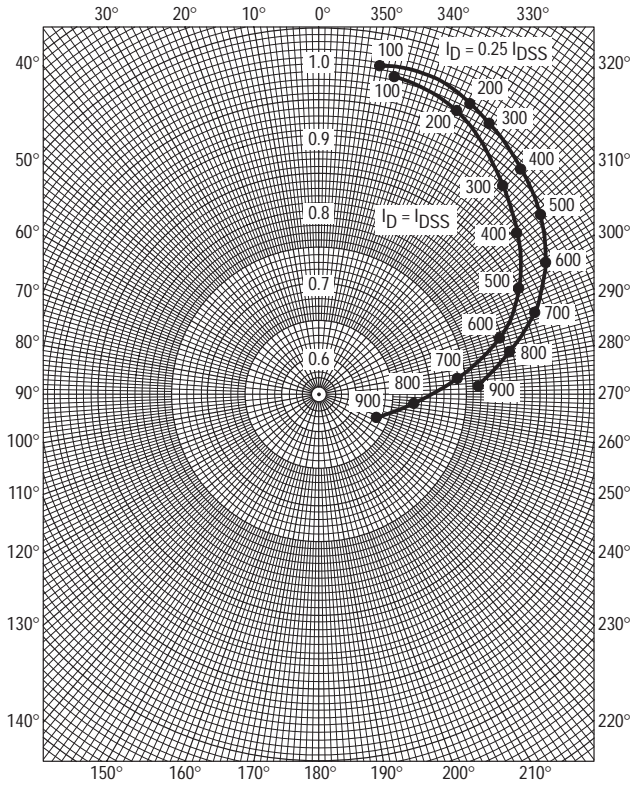


Figure 10. S_{11s}

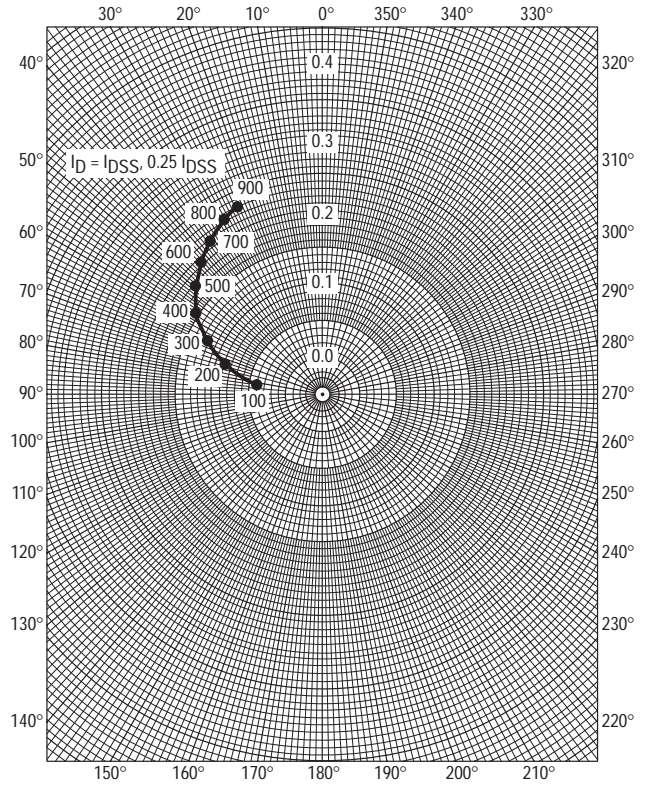


Figure 11. S_{12s}

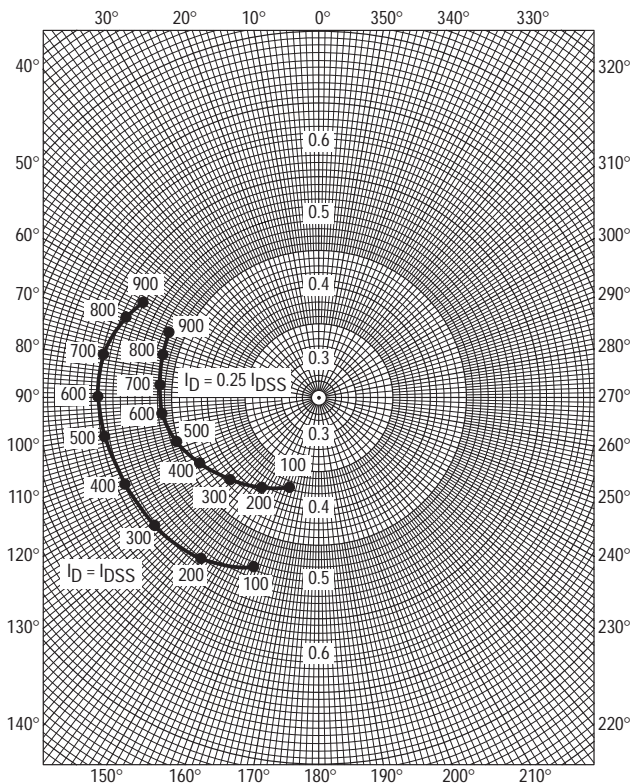


Figure 12. S_{21s}

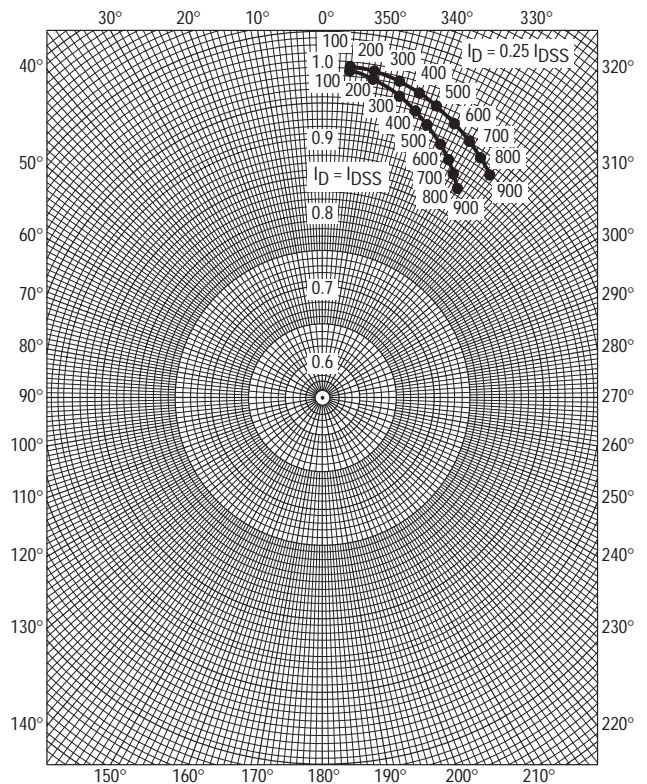


Figure 13. S_{22s}

COMMON GATE CHARACTERISTICS

ADMITTANCE PARAMETERS

($V_{DG} = 15 \text{ Vdc}$, $T_{channel} = 25^\circ\text{C}$)

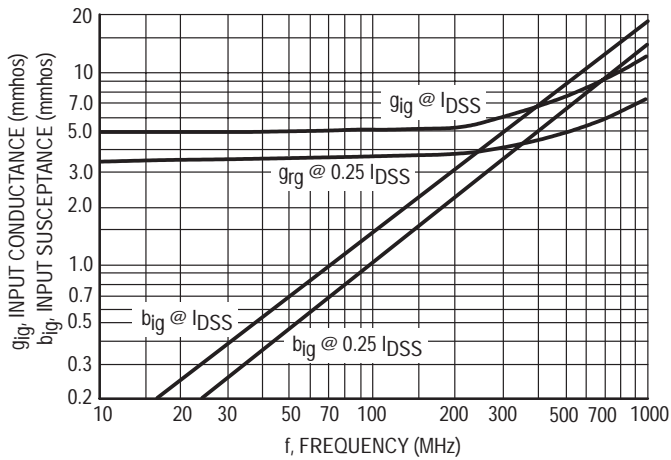


Figure 14. Input Admittance (y_{ig})

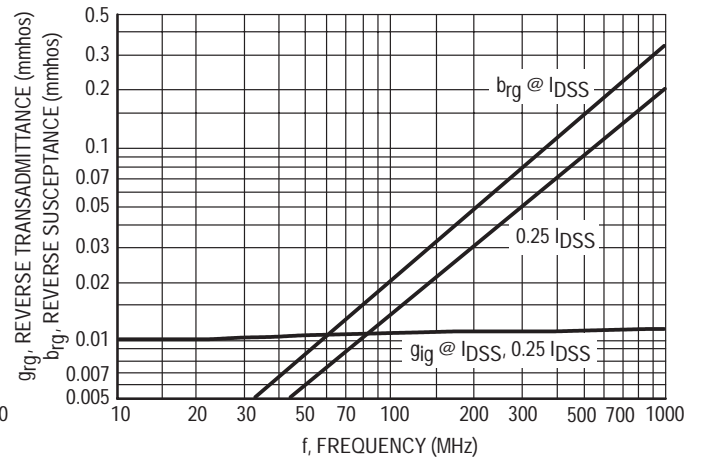


Figure 15. Reverse Transfer Admittance (y_{rg})

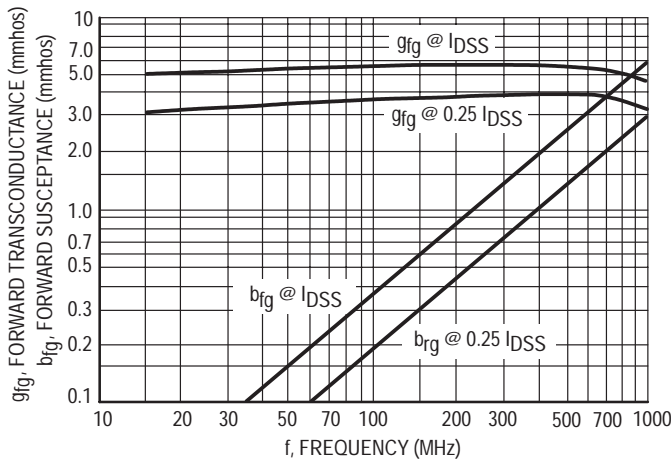


Figure 16. Forward Transfer Admittance (y_{fg})

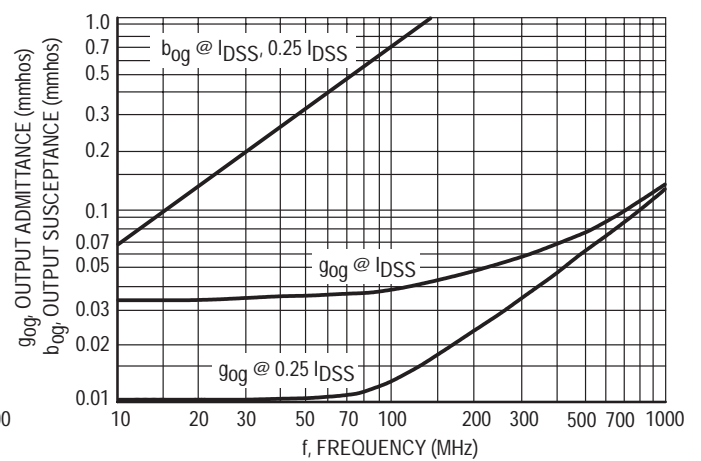


Figure 17. Output Admittance (y_{og})

COMMON GATE CHARACTERISTICS
S-PARAMETERS

($V_{DS} = 15 \text{ Vdc}$, $T_{channel} = 25^\circ\text{C}$, Data Points in MHz)

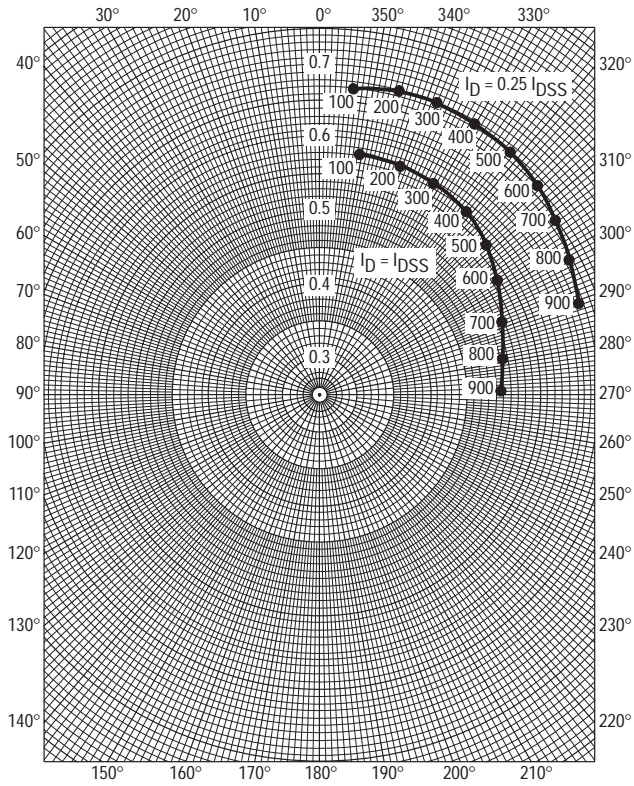


Figure 18. S11g

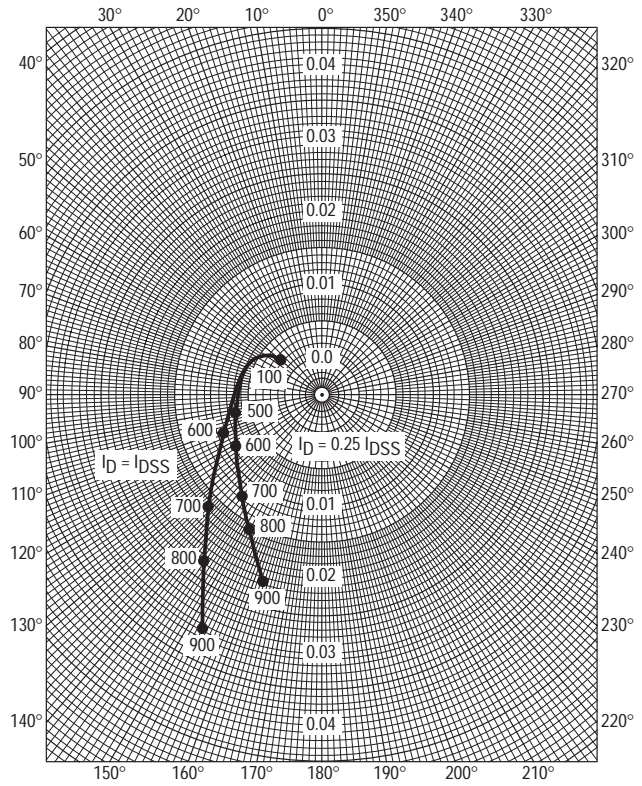


Figure 19. S12g

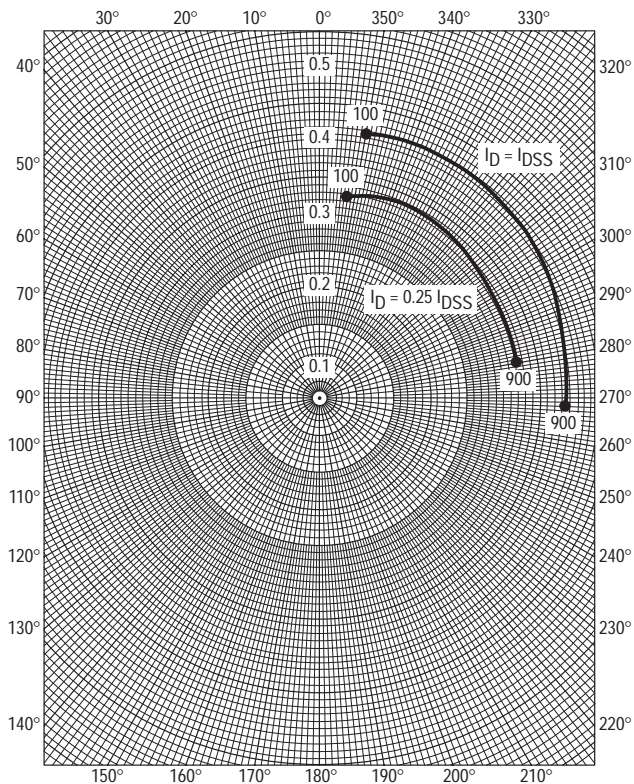


Figure 20. S21g

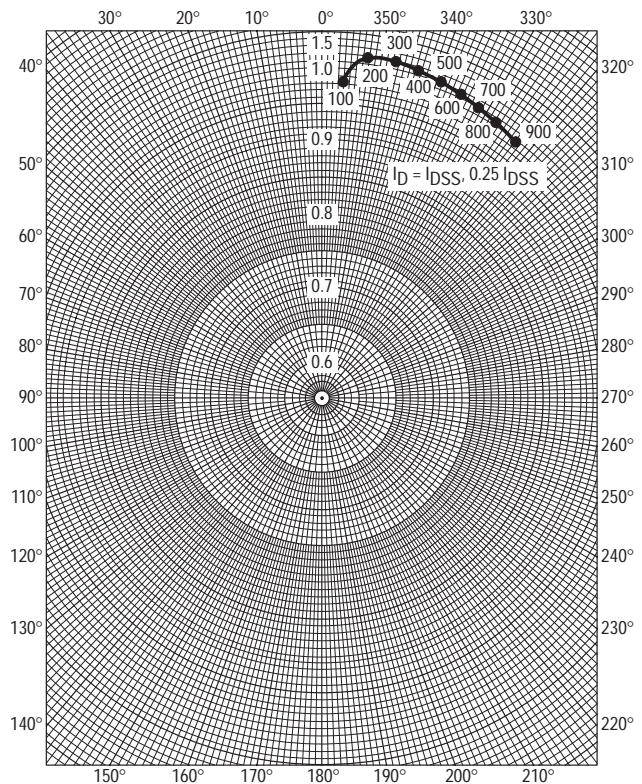
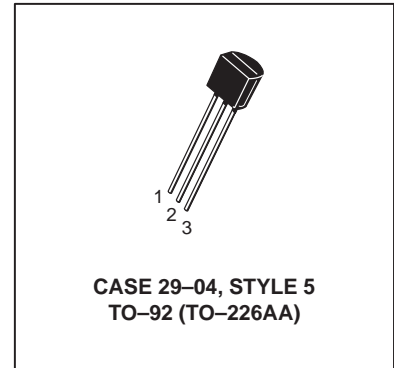
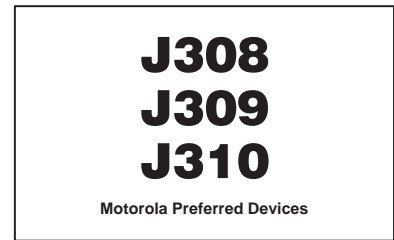
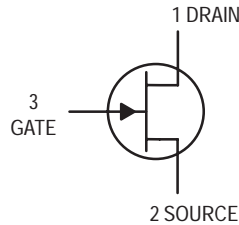


Figure 21. S22g

JFET VHF/UHF Amplifiers

N-Channel — Depletion



MAXIMUM RATINGS

Rating	Symbol	Value	Unit
Drain-Source Voltage	V_{DS}	25	Vdc
Gate-Source Voltage	V_{GS}	25	Vdc
Forward Gate Current	I_{GF}	10	mAdc
Total Device Dissipation @ $T_A = 25^\circ\text{C}$ Derate above 25°C	P_D	350 2.8	mW mW/ $^\circ\text{C}$
Junction Temperature Range	T_J	-65 to +125	$^\circ\text{C}$
Storage Temperature Range	T_{stg}	-65 to +150	$^\circ\text{C}$

ELECTRICAL CHARACTERISTICS ($T_A = 25^\circ\text{C}$ unless otherwise noted)

Characteristic	Symbol	Min	Typ	Max	Unit
----------------	--------	-----	-----	-----	------

OFF CHARACTERISTICS

Gate-Source Breakdown Voltage ($I_G = -1.0 \mu\text{Adc}$, $V_{DS} = 0$)	$V_{(BR)GSS}$	-25	—	—	Vdc
Gate Reverse Current ($V_{GS} = -15 \text{ Vdc}$, $V_{DS} = 0$, $T_A = 25^\circ\text{C}$) ($V_{GS} = -15 \text{ Vdc}$, $V_{DS} = 0$, $T_A = +125^\circ\text{C}$)	I_{GSS}	— —	— —	-1.0 -1.0	nAdc μAdc
Gate Source Cutoff Voltage ($V_{DS} = 10 \text{ Vdc}$, $I_D = 1.0 \text{ nAdc}$)	$V_{GS(off)}$	-1.0 -1.0 -2.0	— — —	-6.5 -4.0 -6.5	Vdc
	J308 J309 J310				

ON CHARACTERISTICS

Zero-Gate-Voltage Drain Current ⁽¹⁾ ($V_{DS} = 10 \text{ Vdc}$, $V_{GS} = 0$)	I_{DSS}	12 12 24	— — —	60 30 60	mAdc
	J308 J309 J310				
Gate-Source Forward Voltage ($V_{DS} = 0$, $I_G = 1.0 \text{ mAdc}$)	$V_{GS(f)}$	—	—	1.0	Vdc

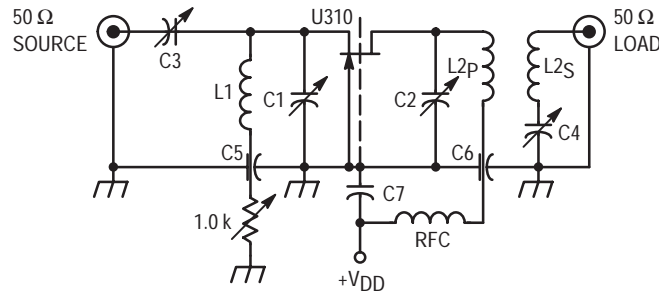
SMALL-SIGNAL CHARACTERISTICS

Common-Source Input Conductance ($V_{DS} = 10 \text{ Vdc}$, $I_D = 10 \text{ mAdc}$, $f = 100 \text{ MHz}$)	$\text{Re}(y_{is})$	— — —	0.7 0.7 0.5	— — —	mmhos
	J308 J309 J310				
Common-Source Output Conductance ($V_{DS} = 10 \text{ Vdc}$, $I_D = 10 \text{ mAdc}$, $f = 100 \text{ MHz}$)	$\text{Re}(y_{os})$	—	0.25	—	mmhos
Common-Gate Power Gain ($V_{DS} = 10 \text{ Vdc}$, $I_D = 10 \text{ mAdc}$, $f = 100 \text{ MHz}$)	G_{pg}	—	16	—	dB

1. Pulse Test: Pulse Width $\leq 300 \mu\text{s}$, Duty Cycle $\leq 3.0\%$.

J308 J309 J310
ELECTRICAL CHARACTERISTICS ($T_A = 25^\circ\text{C}$ unless otherwise noted) (Continued)

Characteristic	Symbol	Min	Typ	Max	Unit
SMALL-SIGNAL CHARACTERISTICS (continued)					
Common-Source Forward Transconductance ($V_{DS} = 10\text{ Vdc}$, $I_D = 10\text{ mA dc}$, $f = 100\text{ MHz}$)	$Re(y_{fs})$	—	12	—	mmhos
Common-Gate Input Conductance ($V_{DS} = 10\text{ Vdc}$, $I_D = 10\text{ mA dc}$, $f = 100\text{ MHz}$)	$Re(y_{ig})$	—	12	—	mmhos
Common-Source Forward Transconductance ($V_{DS} = 10\text{ Vdc}$, $I_D = 10\text{ mA dc}$, $f = 1.0\text{ kHz}$)	g_{fs}				μmhos
	J308	8000	—	20000	
	J309	10000	—	20000	
	J310	8000	—	18000	
Common-Source Output Conductance ($V_{DS} = 10\text{ Vdc}$, $I_D = 10\text{ mA dc}$, $f = 1.0\text{ kHz}$)	g_{os}	—	—	250	μmhos
Common-Gate Forward Transconductance ($V_{DS} = 10\text{ Vdc}$, $I_D = 10\text{ mA dc}$, $f = 1.0\text{ kHz}$)	g_{fg}				μmhos
	J308	—	13000	—	
	J309	—	13000	—	
	J310	—	12000	—	
Common-Gate Output Conductance ($V_{DS} = 10\text{ Vdc}$, $I_D = 10\text{ mA dc}$, $f = 1.0\text{ kHz}$)	g_{og}				μmhos
	J308	—	150	—	
	J309	—	100	—	
	J310	—	150	—	
Gate-Drain Capacitance ($V_{DS} = 0$, $V_{GS} = -10\text{ Vdc}$, $f = 1.0\text{ MHz}$)	C_{gd}	—	1.8	2.5	pF
Gate-Source Capacitance ($V_{DS} = 0$, $V_{GS} = -10\text{ Vdc}$, $f = 1.0\text{ MHz}$)	C_{gs}	—	4.3	5.0	pF
FUNCTIONAL CHARACTERISTICS					
Noise Figure ($V_{DS} = 10\text{ Vdc}$, $I_D = 10\text{ mA dc}$, $f = 450\text{ MHz}$)	NF	—	1.5	—	dB
Equivalent Short-Circuit Input Noise Voltage ($V_{DS} = 10\text{ Vdc}$, $I_D = 10\text{ mA dc}$, $f = 100\text{ Hz}$)	e_n	—	10	—	$\text{nV}/\sqrt{\text{Hz}}$



- C1 = C2 = 0.8 – 10 pF, JFD #MVM010W.
- C3 = C4 = 8.35 pF Erie #539-002D.
- C5 = C6 = 5000 pF Erie (2443-000).
- C7 = 1000 pF, Allen Bradley #FA5C.
- RFC = 0.33 μH Miller #9230-30.
- L1 = One Turn #16 Cu, 1/4" I.D. (Air Core).
- L2p = One Turn #16 Cu, 1/4" I.D. (Air Core).
- L2s = One Turn #16 Cu, 1/4" I.D. (Air Core).

Figure 1. 450 MHz Common-Gate Amplifier Test Circuit

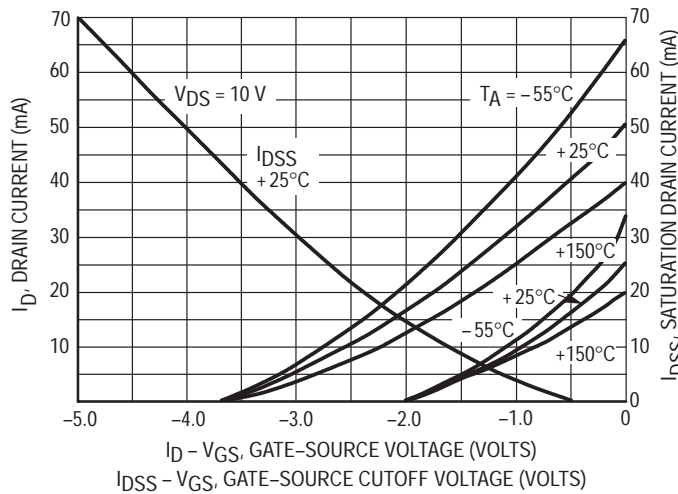


Figure 2. Drain Current and Transfer Characteristics versus Gate-Source Voltage

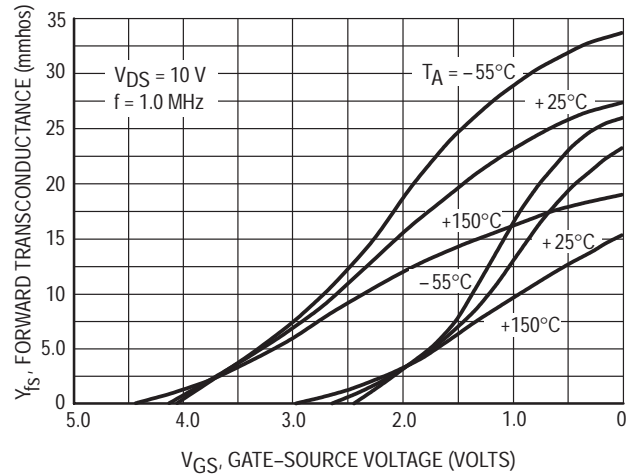


Figure 3. Forward Transconductance versus Gate-Source Voltage

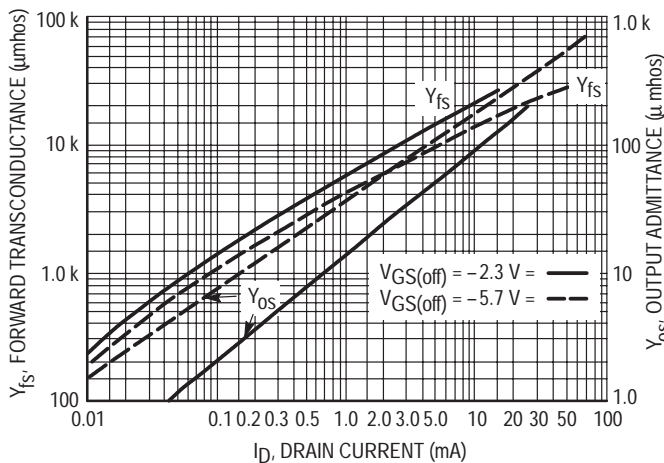


Figure 4. Common-Source Output Admittance and Forward Transconductance versus Drain Current

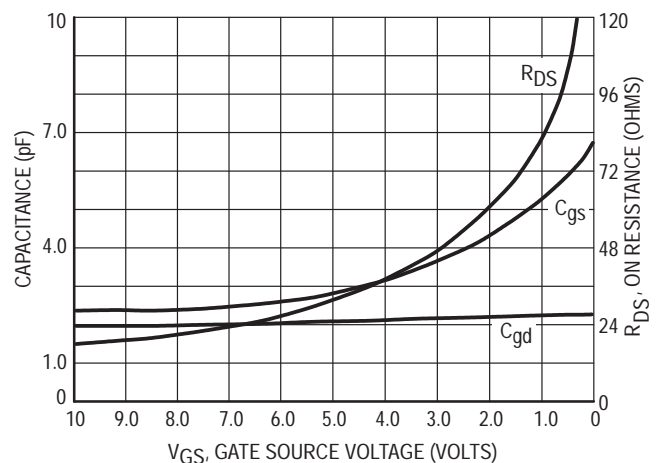


Figure 5. On Resistance and Junction Capacitance versus Gate-Source Voltage

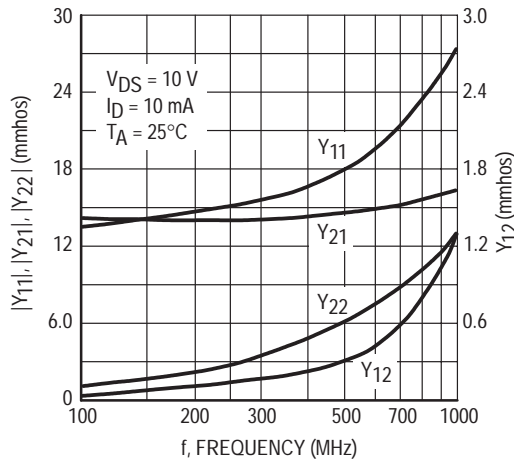


Figure 6. Common-Gate Y Parameter Magnitude versus Frequency

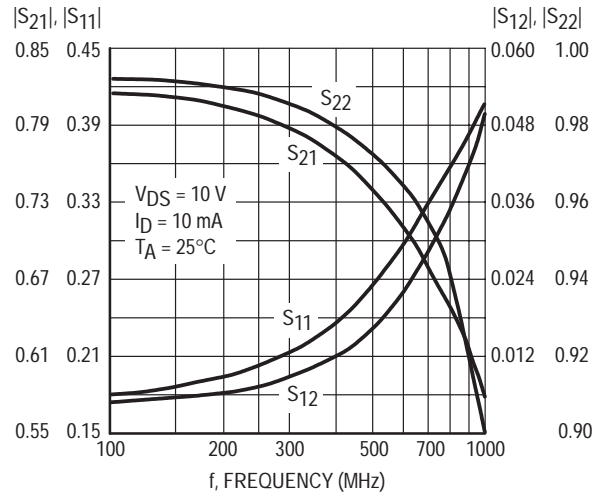


Figure 7. Common-Gate S Parameter Magnitude versus Frequency

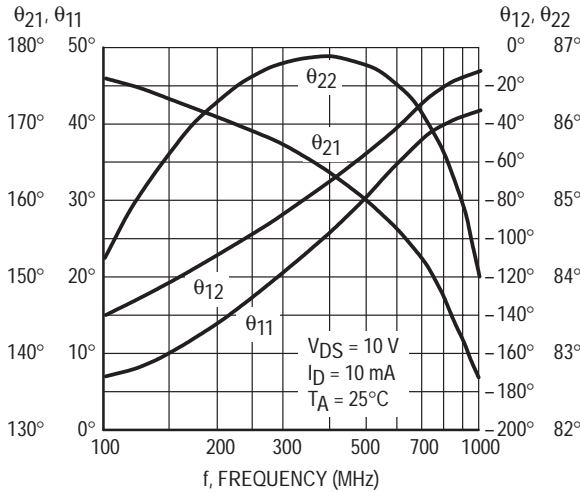


Figure 8. Common-Gate Y Parameter Phase-Angle versus Frequency

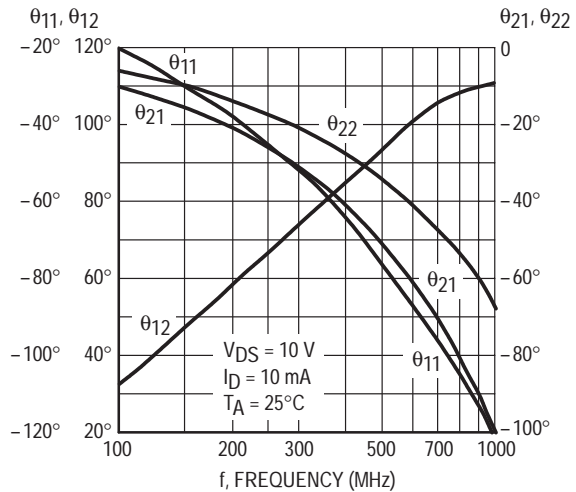


Figure 9. S Parameter Phase-Angle versus Frequency

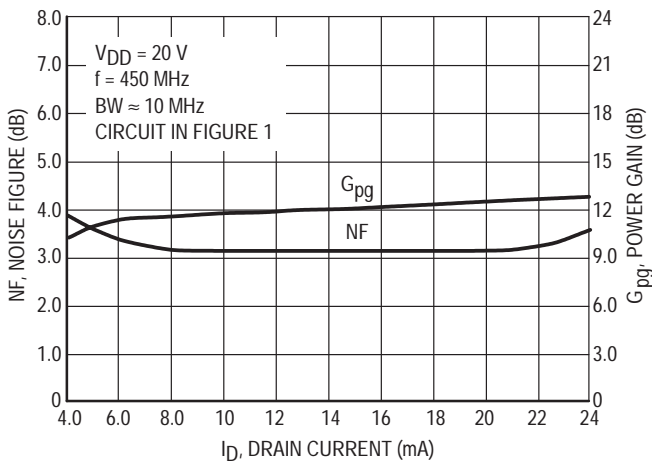


Figure 10. Noise Figure and Power Gain versus Drain Current

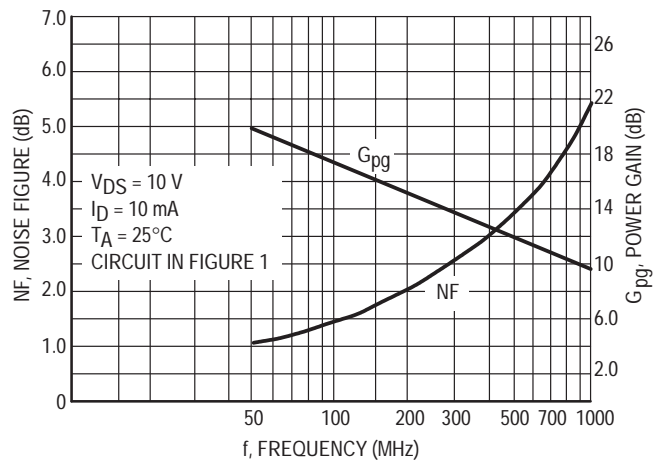
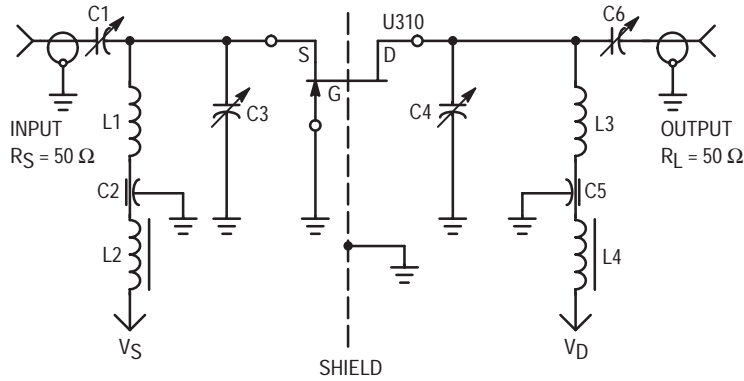


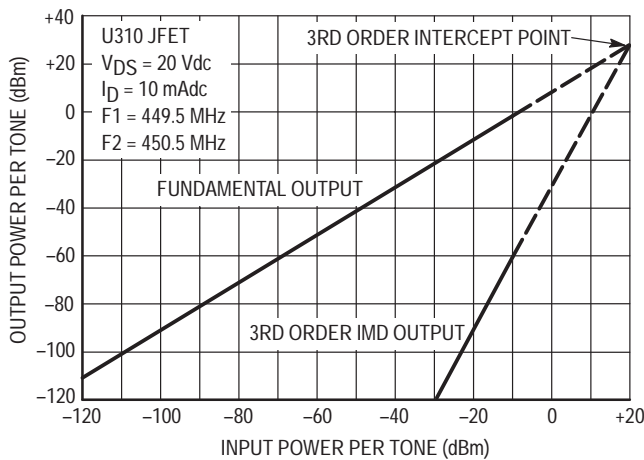
Figure 11. Noise Figure and Power Gain versus Frequency



BW (3 dB) – 36.5 MHz
 I_D – 10 mAdc
 V_{DS} – 20 Vdc
 Device case grounded
 IM test tones – $f_1 = 449.5$ MHz, $f_2 = 450.5$ MHz
 $C_1 = 1-10$ pF Johanson Air variable trimmer.
 $C_2, C_5 = 100$ pF feed thru button capacitor.
 $C_3, C_4, C_6 = 0.5-6$ pF Johanson Air variable trimmer.
 $L_1 = 1/8'' \times 1/32'' \times 1-5/8''$ copper bar.
 $L_2, L_4 =$ Ferroxcube Vk200 choke.
 $L_3 = 1/8'' \times 1/32'' \times 1-7/8''$ copper bar.

Figure 12. 450 MHz IMD Evaluation Amplifier

Amplifier power gain and IMD products are a function of the load impedance. For the amplifier design shown above with C_4 and C_6 adjusted to reflect a load to the drain resulting in a nominal power gain of 9 dB, the 3rd order intercept point (IP) value is 29 dBm. Adjusting C_4, C_6 to provide larger load values will result in higher gain, smaller bandwidth and lower IP values. For example, a nominal gain of 13 dB can be achieved with an intercept point of 19 dBm.

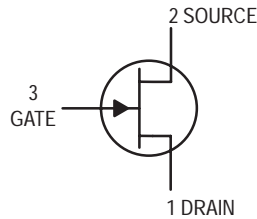


Example of intercept point plot use:
 Assume two in-band signals of -20 dBm at the amplifier input. They will result in a 3rd order IMD signal at the output of -90 dBm. Also, each signal level at the output will be -11 dBm, showing an amplifier gain of 9.0 dB and an intermodulation ratio (IMR) capability of 79 dB. The gain and IMR values apply only for signal levels below comparison.

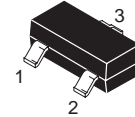
Figure 13. Two Tone 3rd Order Intercept Point

JFET Switching Transistors

N-Channel



MMBF4391LT1
MMBF4392LT1
MMBF4393LT1



CASE 318-08, STYLE 10
SOT-23 (TO-236AB)

MAXIMUM RATINGS

Rating	Symbol	Value	Unit
Drain-Source Voltage	V_{DS}	30	Vdc
Drain-Gate Voltage	V_{DG}	30	Vdc
Gate-Source Voltage	V_{GS}	30	Vdc
Forward Gate Current	$I_{G(f)}$	50	mAdc

THERMAL CHARACTERISTICS

Characteristic	Symbol	Max	Unit
Total Device Dissipation FR-5 Board ⁽¹⁾ $T_A = 25^\circ\text{C}$ Derate above 25°C	P_D	225 1.8	mW mW/ $^\circ\text{C}$
Thermal Resistance, Junction to Ambient	$R_{\theta JA}$	556	$^\circ\text{C}/\text{W}$
Junction and Storage Temperature	T_J, T_{stg}	-55 to +150	$^\circ\text{C}$

DEVICE MARKING

MMBF4391LT1 = 6J; MMBF4392LT1 = 6K; MMBF4393LT1 = 6G

ELECTRICAL CHARACTERISTICS ($T_A = 25^\circ\text{C}$ unless otherwise noted)

Characteristic	Symbol	Min	Max	Unit
----------------	--------	-----	-----	------

OFF CHARACTERISTICS

Gate-Source Breakdown Voltage ($I_G = 1.0 \mu\text{Adc}, V_{DS} = 0$)	$V_{(BR)GSS}$	30	—	Vdc	
Gate Reverse Current ($V_{GS} = 15 \text{ Vdc}, V_{DS} = 0, T_A = 25^\circ\text{C}$) ($V_{GS} = 15 \text{ Vdc}, V_{DS} = 0, T_A = 100^\circ\text{C}$)	I_{GSS}	— —	1.0 0.20	nAdc μAdc	
Gate-Source Cutoff Voltage ($V_{DS} = 15 \text{ Vdc}, I_D = 10 \text{ nAdc}$)	$V_{GS(off)}$	MMBF4391LT1 MMBF4392LT1 MMBF4393LT1	-4.0 -2.0 -0.5	-10 -5.0 -3.0	Vdc
Off-State Drain Current ($V_{DS} = 15 \text{ Vdc}, V_{GS} = -12 \text{ Vdc}$) ($V_{DS} = 15 \text{ Vdc}, V_{GS} = -12 \text{ Vdc}, T_A = 100^\circ\text{C}$)	$I_{D(off)}$	— —	1.0 1.0	nAdc μAdc	

1. FR-5 = $1.0 \times 0.75 \times 0.062$ in.

ELECTRICAL CHARACTERISTICS (T_A = 25°C unless otherwise noted) (Continued)

Characteristic	Symbol	Min	Max	Unit
ON CHARACTERISTICS				
Zero-Gate-Voltage Drain Current (V _{DS} = 15 Vdc, V _{GS} = 0)	I _{DSS}	50	150	mAdc
	MMBF4391LT1	25	75	
	MMBF4392LT1	5.0	30	
Drain-Source On-Voltage (I _D = 12 mAdc, V _{GS} = 0) (I _D = 6.0 mAdc, V _{GS} = 0) (I _D = 3.0 mAdc, V _{GS} = 0)	V _{DS(on)}	—	0.4	Vdc
	MMBF4391LT1	—	0.4	
	MMBF4392LT1	—	0.4	
	MMBF4393LT1	—	0.4	
Static Drain-Source On-Resistance (I _D = 1.0 mAdc, V _{GS} = 0)	r _{DS(on)}	—	30	Ω
	MMBF4391LT1	—	60	
	MMBF4392LT1	—	100	
	MMBF4393LT1	—		

SMALL-SIGNAL CHARACTERISTICS

Input Capacitance (V _{DS} = 15 Vdc, V _{GS} = 0, f = 1.0 MHz)	C _{iss}	—	14	pF
Reverse Transfer Capacitance (V _{DS} = 0, V _{GS} = 12 Vdc, f = 1.0 MHz)	C _{rss}	—	3.5	pF

TYPICAL CHARACTERISTICS

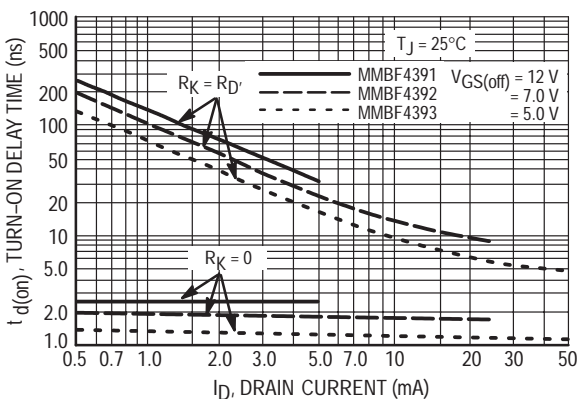


Figure 1. Turn-On Delay Time

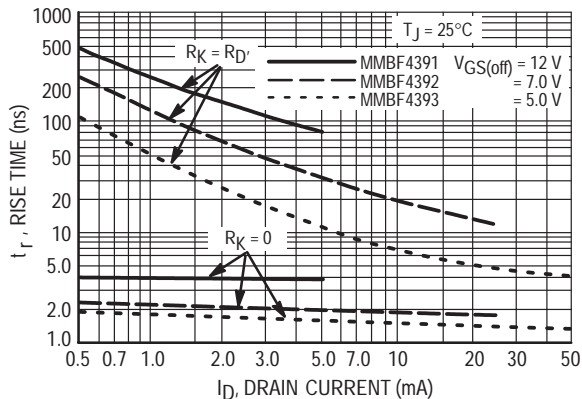


Figure 2. Rise Time

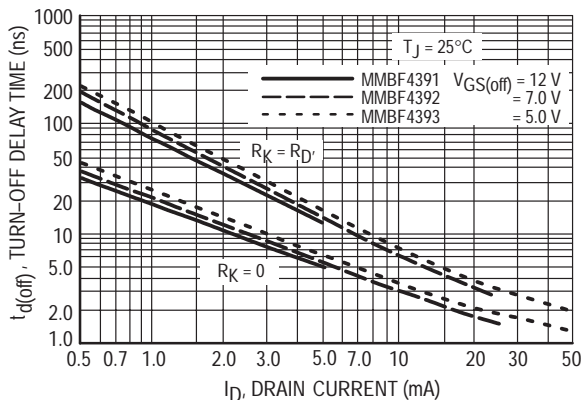


Figure 3. Turn-Off Delay Time

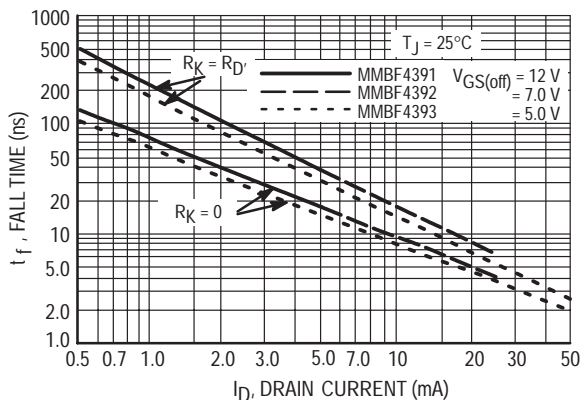


Figure 4. Fall Time

NOTE 1

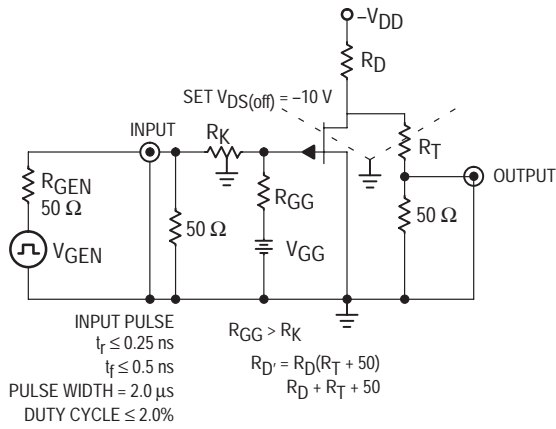


Figure 5. Switching Time Test Circuit

The switching characteristics shown above were measured using a test circuit similar to Figure 5. At the beginning of the switching interval, the gate voltage is at Gate Supply Voltage ($-V_{GG}$). The Drain-Source Voltage (V_{DS}) is slightly lower than Drain Supply Voltage (V_{DD}) due to the voltage divider. Thus Reverse Transfer Capacitance (C_{RS}) of Gate-Drain Capacitance (C_{gd}) is charged to $V_{GG} + V_{DS}$.

During the turn-on interval, Gate-Source Capacitance (C_{gs}) discharges through the series combination of R_{Gen} and R_K . C_{gd} must discharge to $V_{DS(on)}$ through R_G and R_K in series with the parallel combination of effective load impedance (R'_D) and Drain-Source Resistance (r_{DS}). During the turn-off, this charge flow is reversed.

Predicting turn-on time is somewhat difficult as the channel resistance r_{DS} is a function of the gate-source voltage. While C_{gs} discharges, V_{GS} approaches zero and r_{DS} decreases. Since C_{gd} discharges through r_{DS} , turn-on time is non-linear. During turn-off, the situation is reversed with r_{DS} increasing as C_{gd} charges.

The above switching curves show two impedance conditions; 1) R_K is equal to R_D which simulates the switching behavior of cascaded stages where the driving source impedance is normally the load impedance of the previous stage, and 2) $R_K = 0$ (low impedance) the driving source impedance is that of the generator.

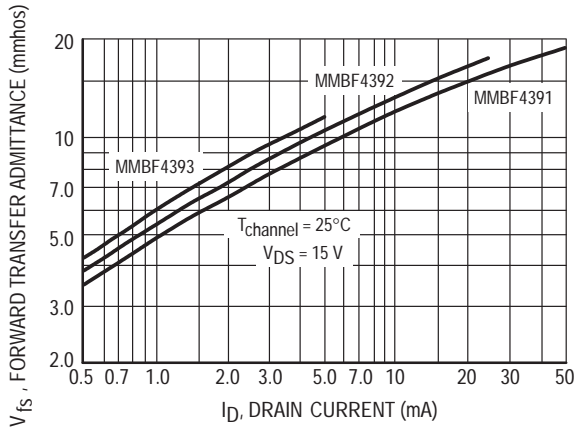


Figure 6. Typical Forward Transfer Admittance

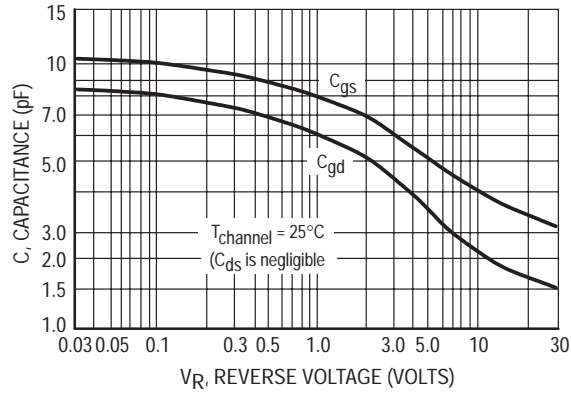


Figure 7. Typical Capacitance

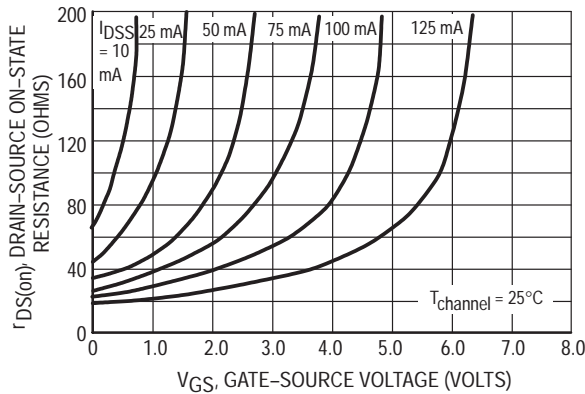


Figure 8. Effect of Gate-Source Voltage on Drain-Source Resistance

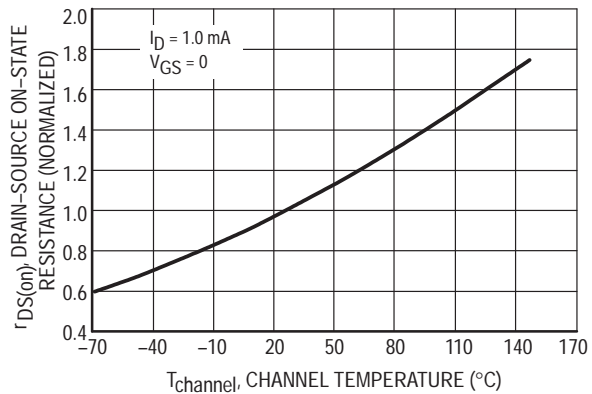


Figure 9. Effect of Temperature on Drain-Source On-State Resistance

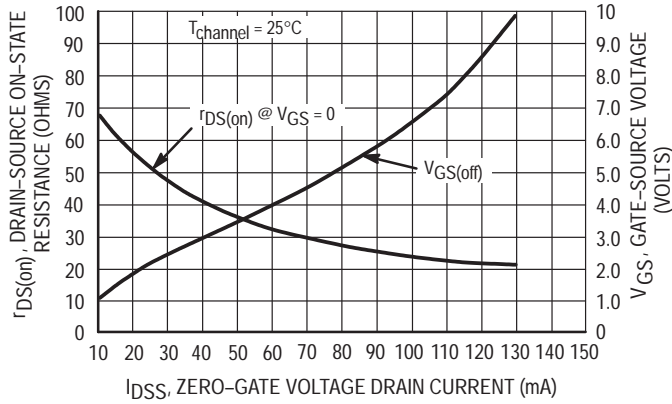


Figure 10. Effect of I_{DSS} on Drain-Source Resistance and Gate-Source Voltage

NOTE 2

The Zero-Gate-Voltage Drain Current (I_{DSS}) is the principle determinant of other J-FET characteristics. Figure 10 shows the relationship of Gate-Source Off Voltage ($V_{GS(off)}$) and Drain-Source On Resistance ($r_{DS(on)}$) to I_{DSS} . Most of the devices will be within $\pm 10\%$ of the values shown in Figure 10. This data will be useful in predicting the characteristic variations for a given part number.

For example:

Unknown

$r_{DS(on)}$ and V_{GS} range for an MMBF4392

The electrical characteristics table indicates that an MMBF4392 has an I_{DSS} range of 25 to 75 mA. Figure 10 shows $r_{DS(on)} = 52$ Ohms for $I_{DSS} = 25$ mA and 30 Ohms for $I_{DSS} = 75$ mA. The corresponding V_{GS} values are 2.2 volts and 4.8 volts.

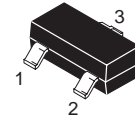
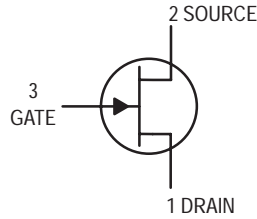
JFET

VHF/UHF Amplifier Transistor

N-Channel

MMBF4416LT1

Motorola Preferred Device



CASE 318-08, STYLE 10
SOT-23 (TO-236AB)

MAXIMUM RATINGS

Rating	Symbol	Value	Unit
Drain-Source Voltage	V_{DS}	30	Vdc
Drain-Gate Voltage	V_{DG}	30	Vdc
Gate-Source Voltage	V_{GS}	30	Vdc
Gate Current	I_G	10	mAdc

THERMAL CHARACTERISTICS

Characteristic	Symbol	Max	Unit
Total Device Dissipation FR-5 Board ⁽¹⁾ $T_A = 25^\circ\text{C}$ Derate above 25°C	P_D	225 1.8	mW mW/ $^\circ\text{C}$
Thermal Resistance, Junction to Ambient	$R_{\theta JA}$	556	$^\circ\text{C}/\text{W}$
Junction and Storage Temperature	T_J, T_{stg}	-55 to +150	$^\circ\text{C}$

DEVICE MARKING

MMBF4416LT1 = M6A

ELECTRICAL CHARACTERISTICS ($T_A = 25^\circ\text{C}$ unless otherwise noted)

Characteristic	Symbol	Min	Max	Unit
----------------	--------	-----	-----	------

OFF CHARACTERISTICS

Gate-Source Breakdown Voltage ($I_G = 1.0 \mu\text{Adc}$, $V_{DS} = 0$)	$V_{(BR)GSS}$	30	—	Vdc
Gate Reverse Current ($V_{GS} = 20 \text{ Vdc}$, $V_{DS} = 0$) ($V_{GS} = 20 \text{ Vdc}$, $V_{DS} = 0$, $T_A = 150^\circ\text{C}$)	I_{GSS}	— —	1.0 200	nAdc
Gate Source Cutoff Voltage ($I_D = 1.0 \text{ nAdc}$, $V_{DS} = 15 \text{ Vdc}$)	$V_{GS(off)}$	—	-6.0	Vdc
Gate Source Voltage ($I_D = 0.5 \text{ mAdc}$, $V_{DS} = 15 \text{ Vdc}$)	V_{GS}	-1.0	-5.5	Vdc

ON CHARACTERISTICS

Zero-Gate-Voltage Drain Current ($V_{GS} = 15 \text{ Vdc}$, $V_{GS} = 0$)	I_{DSS}	5.0	15	mAdc
Gate-Source Forward Voltage ($I_G = 1.0 \text{ mAdc}$, $V_{DS} = 0$)	$V_{GS(f)}$	—	1.0	Vdc

1. FR-5 = $1.0 \times 0.75 \times 0.062 \text{ in.}$

Preferred devices are Motorola recommended choices for future use and best overall value.

ELECTRICAL CHARACTERISTICS ($T_A = 25^\circ\text{C}$ unless otherwise noted) (Continued)

Characteristic	Symbol	Min	Max	Unit
SMALL-SIGNAL CHARACTERISTICS				
Forward Transfer Admittance ($V_{DS} = 15\text{ Vdc}$, $V_{GS} = 0$, $f = 1.0\text{ kHz}$)	$ Y_{fs} $	4500	7500	μmhos
Output Admittance ($V_{DS} = 15\text{ Vdc}$, $V_{GS} = 0$, $f = 1.0\text{ kHz}$)	$ y_{os} $	—	50	μmhos
Input Capacitance ($V_{DS} = 15\text{ Vdc}$, $V_{GS} = 0$, $f = 1.0\text{ MHz}$)	C_{iss}	—	4.0	pF
Reverse Transfer Capacitance ($V_{DS} = 15\text{ Vdc}$, $V_{GS} = 0$, $f = 10\text{ MHz}$)	C_{rss}	—	0.8	pF
Output Capacitance ($V_{DS} = 15\text{ Vdc}$, $V_{GS} = 0$, $f = 1.0\text{ MHz}$)	C_{oss}	—	2.0	pF

FUNCTIONAL CHARACTERISTICS

Noise Figure ($V_{DS} = 15\text{ Vdc}$, $I_D = 5.0\text{ mAdc}$, $R_g \approx 1000\ \Omega$, $f = 100\text{ MHz}$) ($V_{DS} = 15\text{ Vdc}$, $I_D = 5.0\text{ mAdc}$, $R_g \approx 1000\ \Omega$, $f = 400\text{ MHz}$)	NF	—	2.0 4.0	dB
Common Source Power Gain ($V_{DS} = 15\text{ Vdc}$, $I_D = 5.0\text{ mAdc}$, $f = 100\text{ MHz}$) ($V_{DS} = 15\text{ Vdc}$, $I_D = 5.0\text{ mAdc}$, $f = 400\text{ MHz}$)	G_{ps}	18 10	— —	dB

POWER GAIN

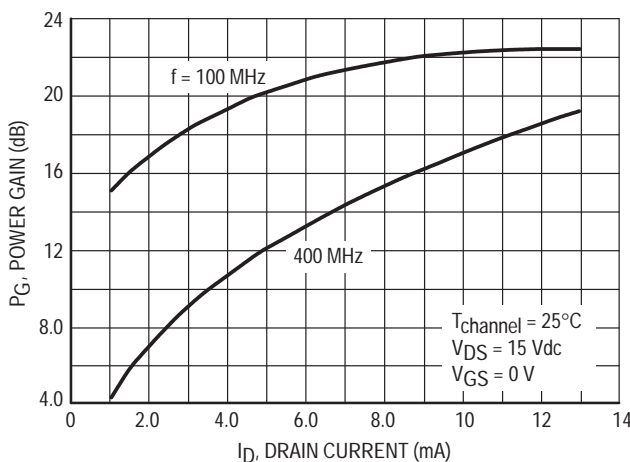
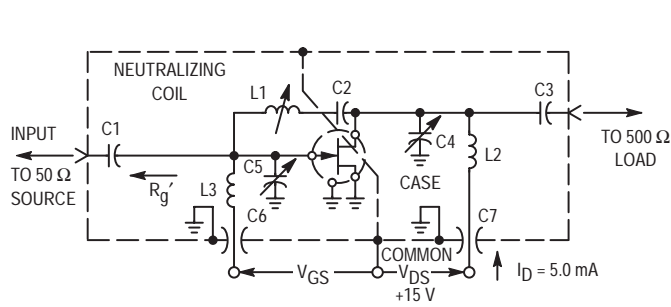


Figure 1. Effects of Drain Current



Adjust V_{GS} for $I_D = 5.0 \text{ mA}$
 $V_{GS} < 0 \text{ Volts}$

NOTE: The noise source is a hot-cold body (AIL type 70 or equivalent) with a test receiver (AIL type 136 or equivalent).

Reference Designation	VALUE	
	100 MHz	400 MHz
C1	7.0 pF	1.8 pF
C2	1000 pF	17 pF
C3	3.0 pF	1.0 pF
C4	1–12 pF	0.8–8.0 pF
C5	1–12 pF	0.8–8.0 pF
C6	0.0015 μF	0.001 μF
C7	0.0015 μF	0.001 μF
L1	3.0 μH^*	0.2 μH^{**}
L2	0.15 μH^*	0.03 μH^{**}
L3	0.14 μH^*	0.022 μH^{**}

- *L1 17 turns, (approx. — depends upon circuit layout) AWG #28 enameled copper wire, close wound on 9/32" ceramic coil form. Tuning provided by a powdered iron slug.
- L2 4–1/2 turns, AWG #18 enameled copper wire, 5/16" long, 3/8" I.D. (AIR CORE).
- L3 3–1/2 turns, AWG #18 enameled copper wire, 1/4" long, 3/8" I.D. (AIR CORE).

- **L1 6 turns, (approx. — depends upon circuit layout) AWG #24 enameled copper wire, close wound on 7/32" ceramic coil form. Tuning provided by an aluminum slug.
- L2 1 turn, AWG #16 enameled copper wire, 3/8" I.D. (AIR CORE).
- L3 1/2 turn, AWG #16 enameled copper wire, 1/4" I.D. (AIR CORE).

Figure 2. 100 MHz and 400 MHz Neutralized Test Circuit

NOISE FIGURE
 ($T_{\text{channel}} = 25^\circ\text{C}$)

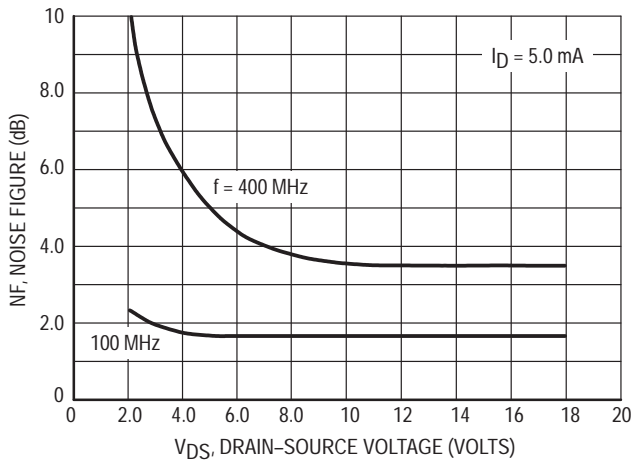


Figure 3. Effects of Drain-Source Voltage

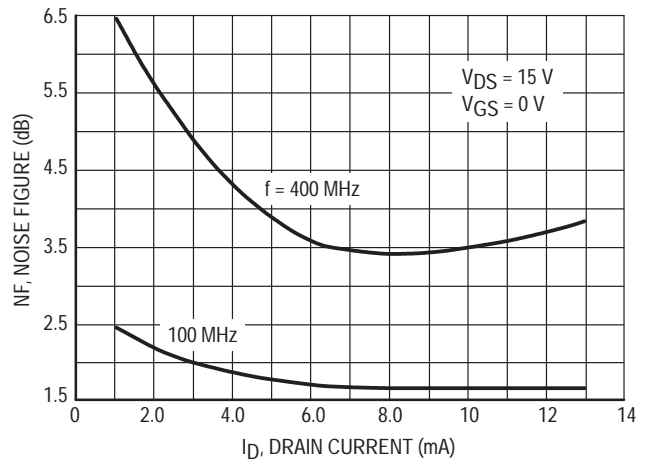


Figure 4. Effects of Drain Current

INTERMODULATION CHARACTERISTICS

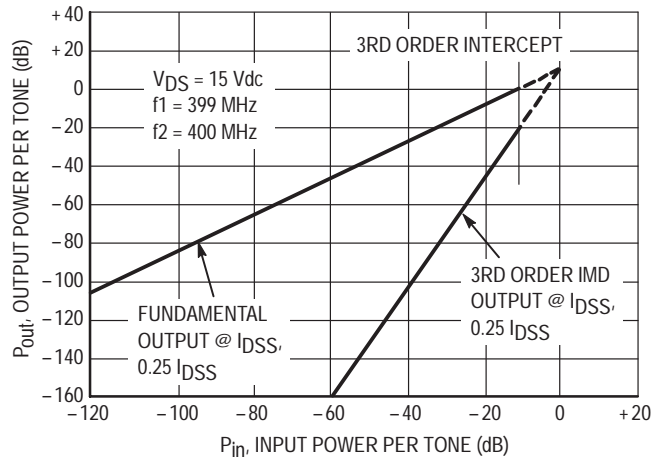
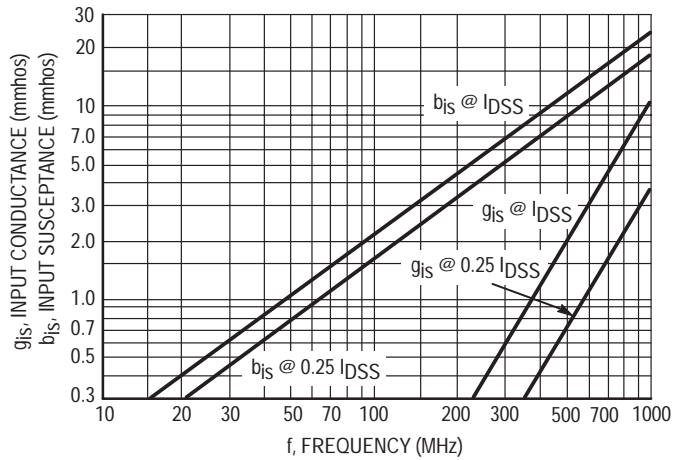
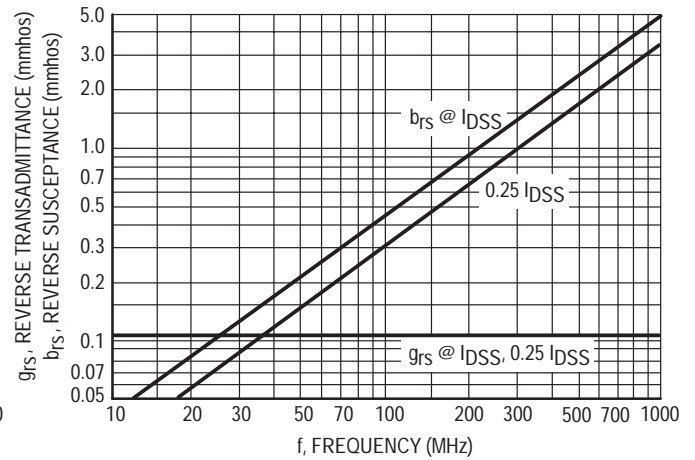
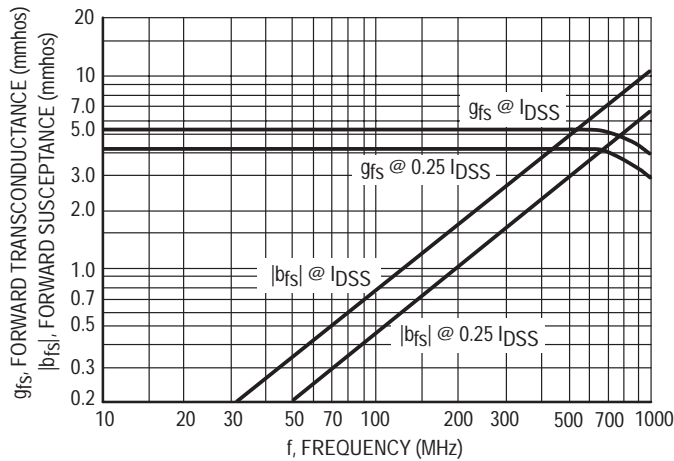
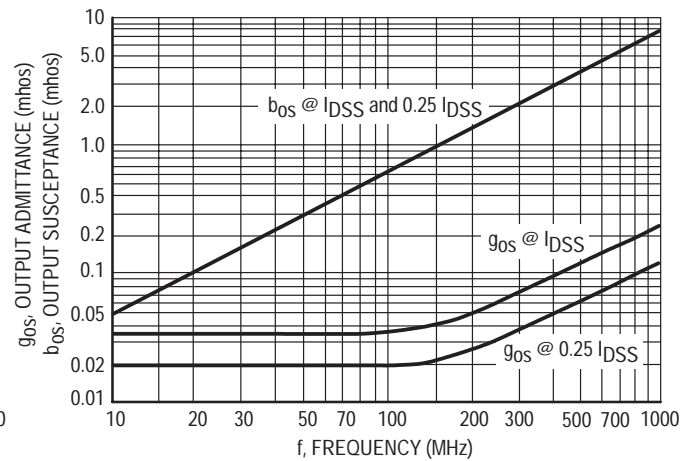


Figure 5. Third Order Intermodulation Distortion

COMMON SOURCE CHARACTERISTICS

ADMITTANCE PARAMETERS

(V_{DS} = 15 Vdc, T_{channel} = 25°C)Figure 6. Input Admittance (y_{is})Figure 7. Reverse Transfer Admittance (y_{rs})Figure 8. Forward Transadmittance (y_{fs})Figure 9. Output Admittance (y_{os})

COMMON SOURCE CHARACTERISTICS
S-PARAMETERS
 ($V_{DS} = 15 \text{ Vdc}$, $T_{\text{channel}} = 25^\circ\text{C}$, Data Points in MHz)

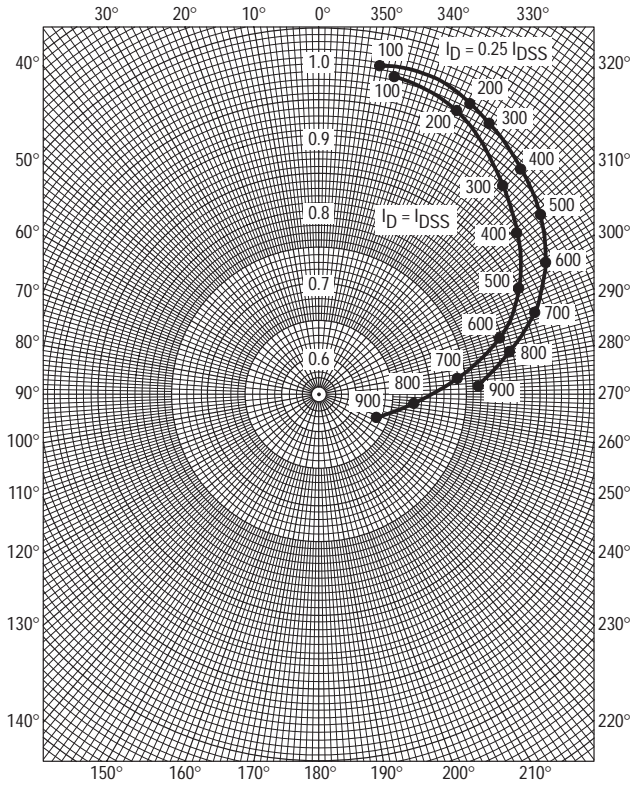


Figure 10. S_{11s}

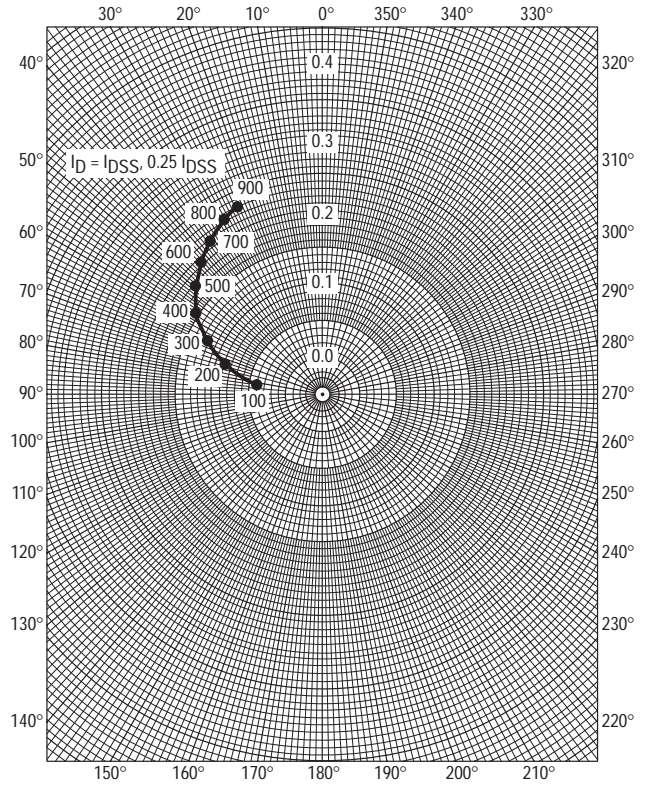


Figure 11. S_{12s}

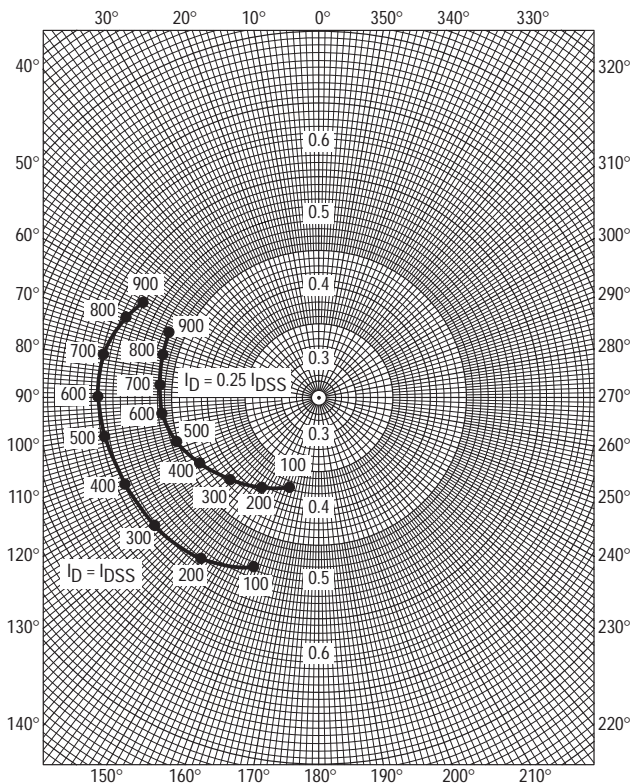


Figure 12. S_{21s}

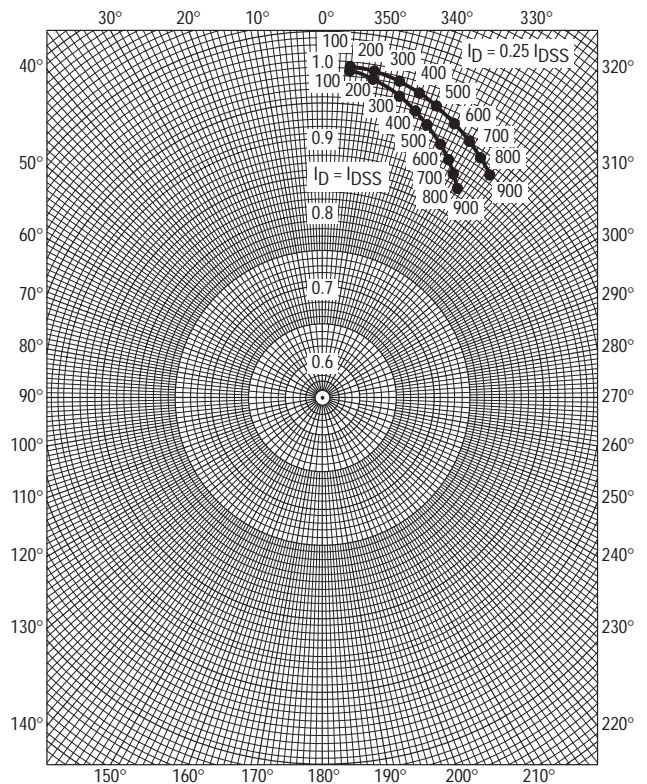
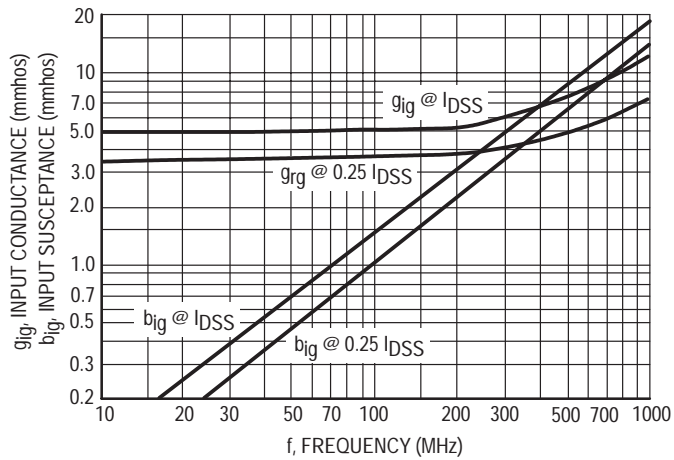
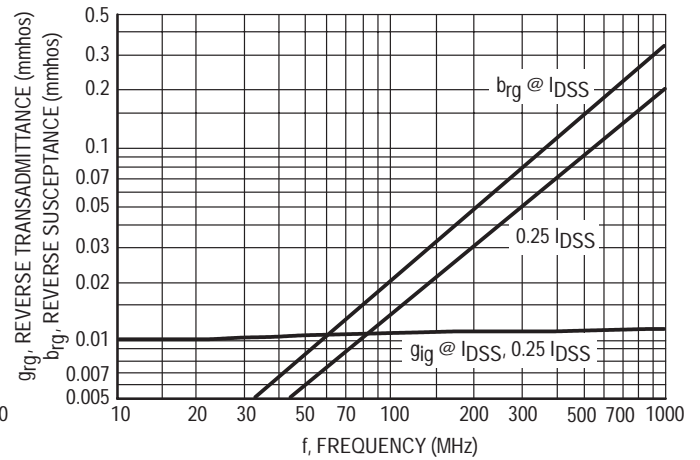
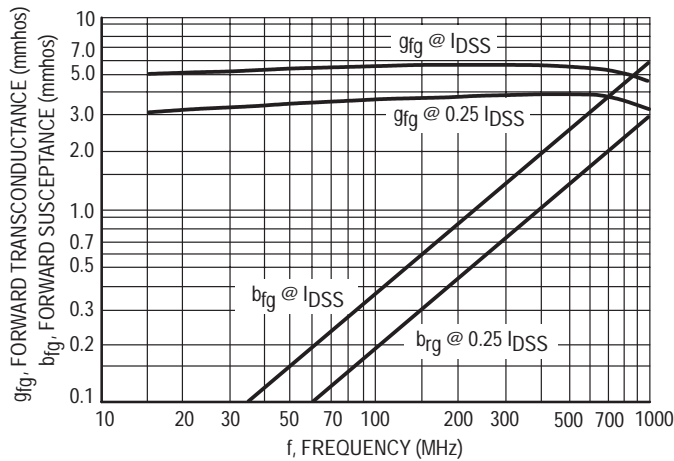
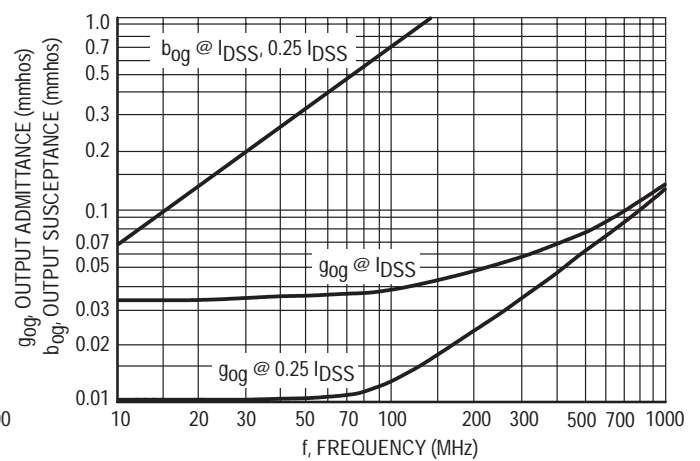


Figure 13. S_{22s}

COMMON GATE CHARACTERISTICS

ADMITTANCE PARAMETERS

(V_{DG} = 15 Vdc, T_{channel} = 25°C)Figure 14. Input Admittance (y_{ig})Figure 15. Reverse Transfer Admittance (y_{rg})Figure 16. Forward Transfer Admittance (y_{fg})Figure 17. Output Admittance (y_{og})

COMMON GATE CHARACTERISTICS
S-PARAMETERS

($V_{DS} = 15 \text{ Vdc}$, $T_{channel} = 25^\circ\text{C}$, Data Points in MHz)

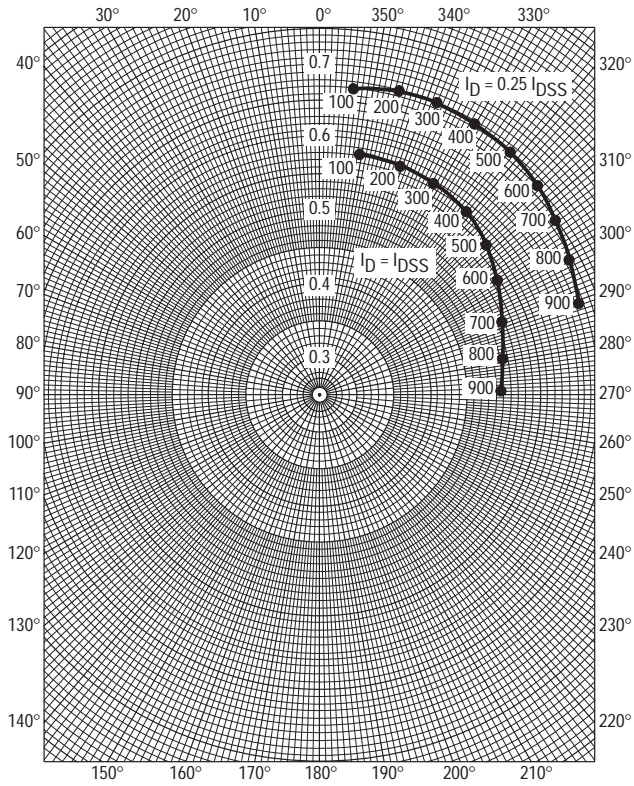


Figure 18. $S_{11}g$

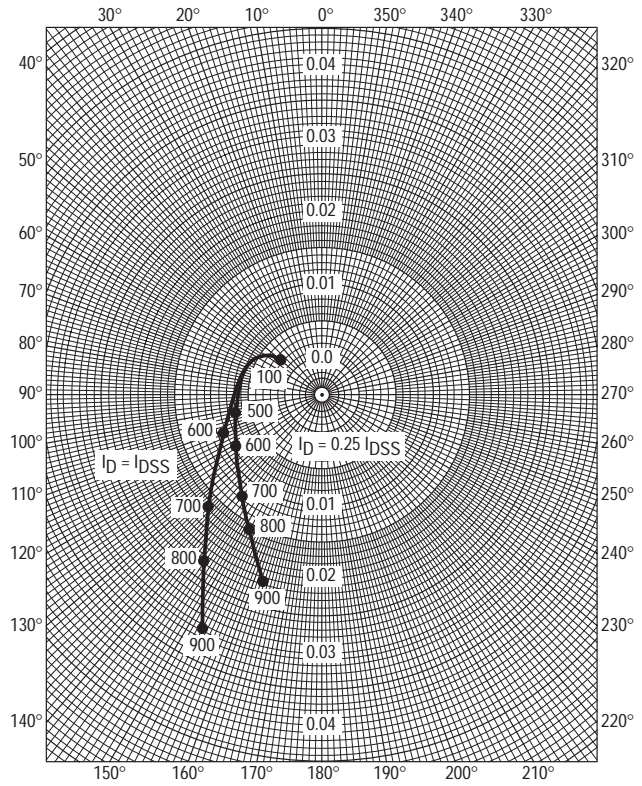


Figure 19. $S_{12}g$

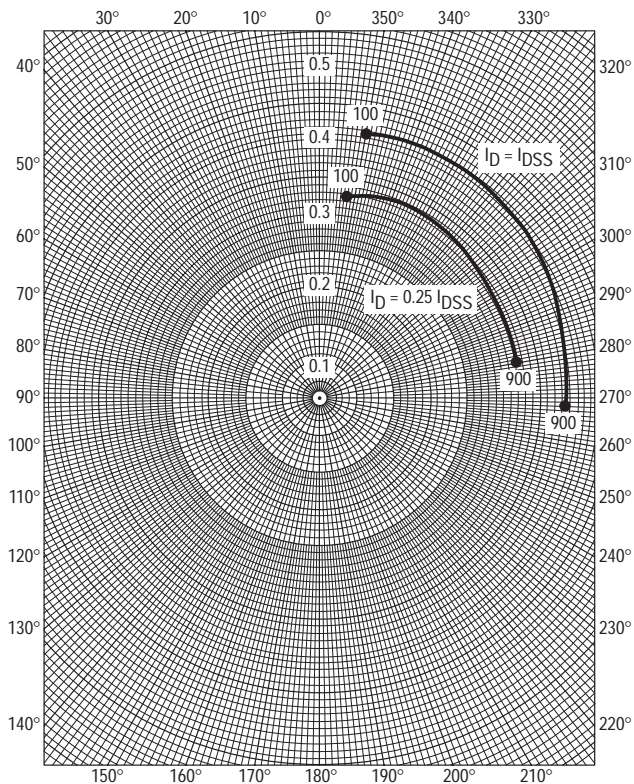


Figure 20. $S_{21}g$

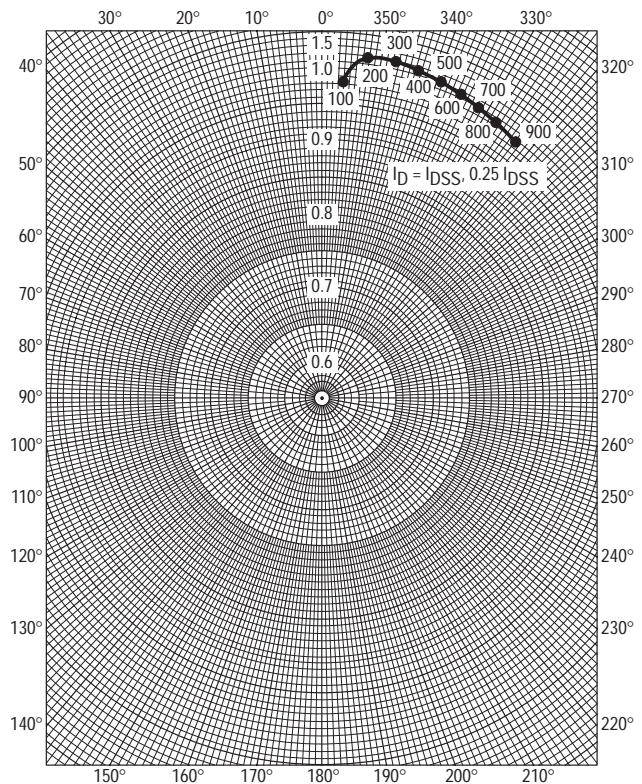
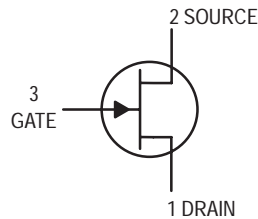


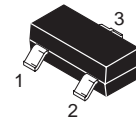
Figure 21. $S_{22}g$

JFET — General Purpose Transistor

N-Channel



MMBF5457LT1



CASE 318-08, STYLE 10
SOT-23 (TO-236AB)

MAXIMUM RATINGS

Rating	Symbol	Value	Unit
Drain-Source Voltage	V_{DS}	25	Vdc
Drain-Gate Voltage	V_{DG}	25	Vdc
Reverse Gate-Source Voltage	$V_{GS(r)}$	25	Vdc
Gate Current	I_G	10	mAdc

THERMAL CHARACTERISTICS

Characteristic	Symbol	Max	Unit
Total Device Dissipation FR-5 Board ⁽¹⁾ $T_A = 25^\circ\text{C}$ Derate above 25°C	P_D	225	mW
		1.8	mW/ $^\circ\text{C}$
Thermal Resistance, Junction to Ambient	$R_{\theta JA}$	556	$^\circ\text{C}/\text{W}$
Junction and Storage Temperature	T_J, T_{stg}	-55 to +150	$^\circ\text{C}$

DEVICE MARKING

MMBF5457LT1 = 6D

ELECTRICAL CHARACTERISTICS ($T_A = 25^\circ\text{C}$ unless otherwise noted)

Characteristic	Symbol	Min	Typ	Max	Unit
----------------	--------	-----	-----	-----	------

OFF CHARACTERISTICS

Gate-Source Breakdown Voltage ($I_G = 10 \mu\text{Adc}, V_{DS} = 0$)	$V_{(BR)GSS}$	25	—	—	Vdc
Gate Reverse Current ($V_{GS} = 15 \text{Vdc}, V_{DS} = 0$) ($V_{GS} = 15 \text{Vdc}, V_{DS} = 0, T_A = 100^\circ\text{C}$)	I_{GSS}	—	—	1.0 200	nAdc
Gate Source Cutoff Voltage ($V_{DS} = 15 \text{Vdc}, I_D = 10 \text{nAdc}$)	$V_{GS(off)}$	0.5	—	-6.0	Vdc
Gate Source Voltage ($V_{DS} = 15 \text{Vdc}, I_D = 100 \mu\text{Adc}$)	V_{GS}	—	-2.5	—	Vdc

ON CHARACTERISTICS

Zero-Gate-Voltage Drain Current ⁽²⁾ ($V_{DS} = 15 \text{Vdc}, V_{GS} = 0$)	I_{DSS}	1.0	—	5.0	mAdc
--------------------------------------------------------------------------------------------	-----------	-----	---	-----	------

1. FR-5 = $1.0 \times 0.75 \times 0.062$ in.

2. Pulse Test: Pulse Width ≤ 630 ms, Duty Cycle $\leq 10\%$.

ELECTRICAL CHARACTERISTICS (T_A = 25°C unless otherwise noted) (Continued)

Characteristic	Symbol	Min	Typ	Max	Unit
SMALL-SIGNAL CHARACTERISTICS					
Forward Transfer Admittance ⁽²⁾ (V _{DS} = 15 Vdc, V _{GS} = 0, f = 1.0 kHz)	Y _{fs}	1000	—	5000	μmhos
Reverse Transfer Admittance (V _{DS} = 15 Vdc, V _{GS} = 0, f = 1.0 kHz)	Y _{rs}	—	10	50	μmhos
Input Capacitance (V _{DS} = 15 Vdc, V _{GS} = 0, f = 1.0 MHz)	C _{iss}	—	4.5	7.0	pF
Reverse Transfer Capacitance (V _{DS} = 15 Vdc, V _{GS} = 0, f = 1.0 MHz)	C _{rss}	—	1.5	3.0	pF

2. Pulse Test: Pulse Width ≤ 630 ms, Duty Cycle ≤ 10%.

TYPICAL CHARACTERISTICS

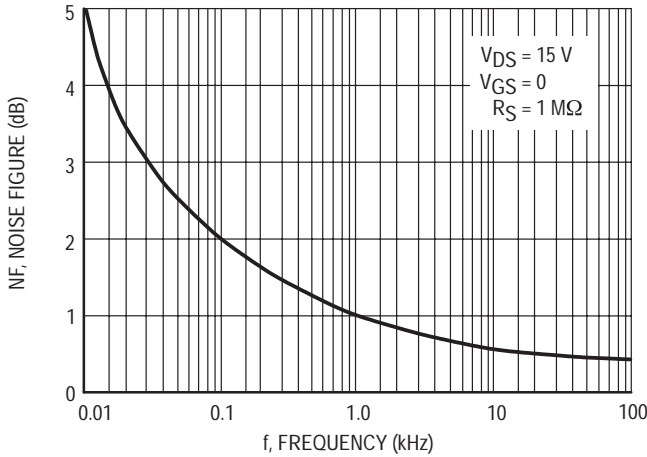


Figure 1. Noise Figure versus Frequency

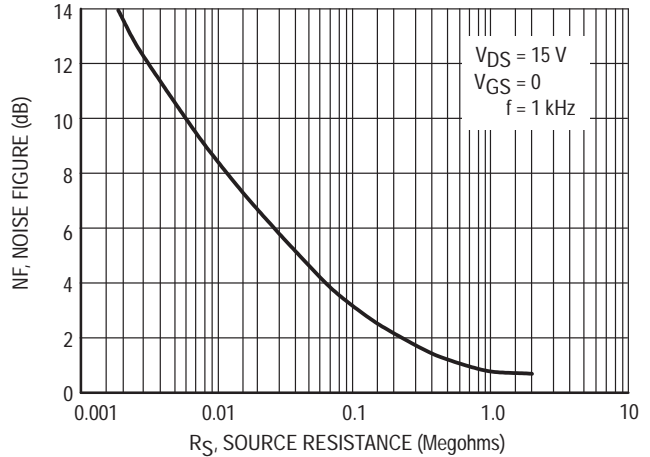


Figure 2. Noise Figure versus Source Resistance

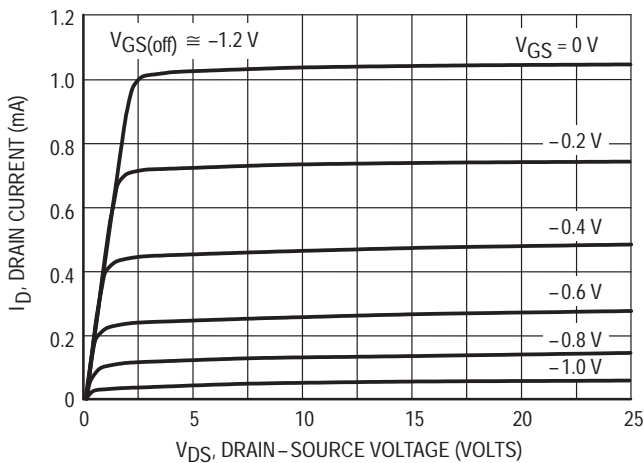


Figure 3. Typical Drain Characteristics

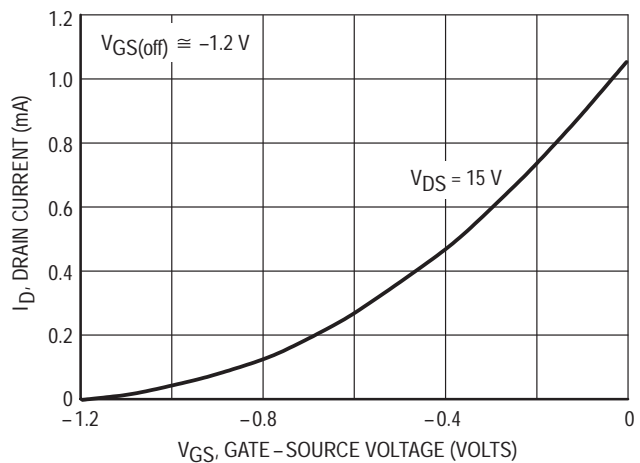


Figure 4. Common Source Transfer Characteristics

TYPICAL CHARACTERISTICS

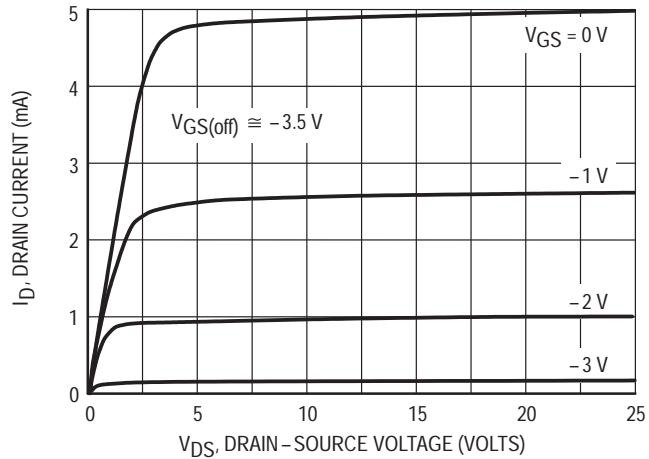


Figure 5. Typical Drain Characteristics

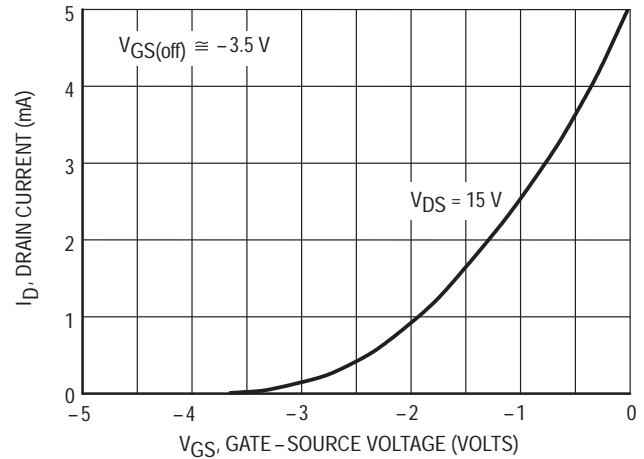


Figure 6. Common Source Transfer Characteristics

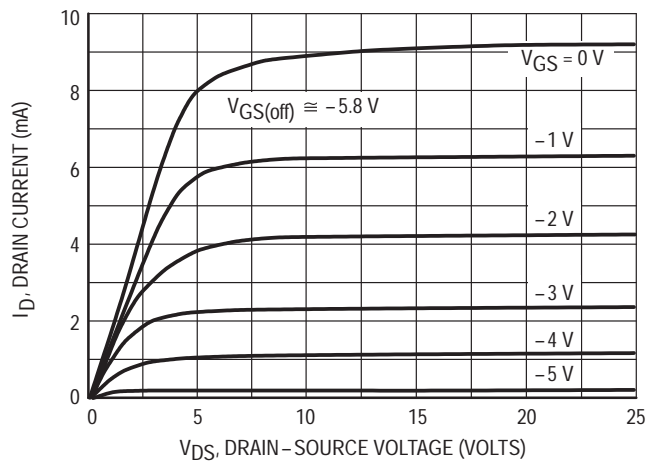


Figure 7. Typical Drain Characteristics

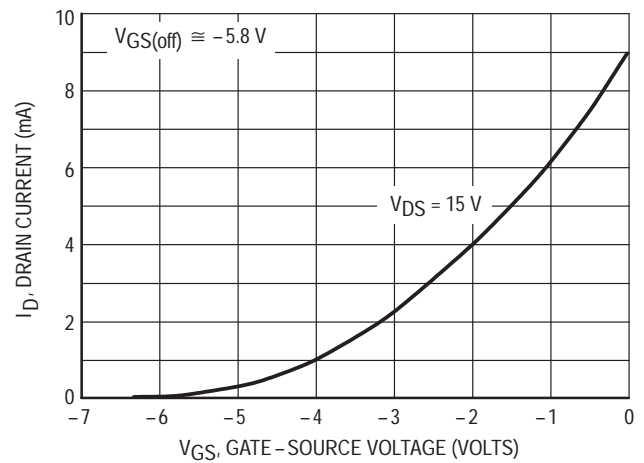
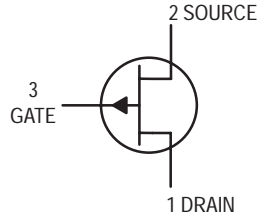


Figure 8. Common Source Transfer Characteristics

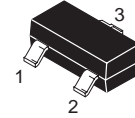
Note: Graphical data is presented for dc conditions. Tabular data is given for pulsed conditions (Pulse Width = 630 ms, Duty Cycle = 10%). Under dc conditions, self heating in higher I_{DSS} units reduces I_{DSS} .

JFET General Purpose Transistor

P-Channel



MMBF5460LT1



CASE 318-08, STYLE 10
SOT-23 (TO-236AB)

MAXIMUM RATINGS

Rating	Symbol	Value	Unit
Drain-Source Voltage	V_{DS}	40	Vdc
Reverse Gate-Source Voltage	V_{GSR}	40	Vdc
Forward Gate Current	I_{GF}	10	mAdc

THERMAL CHARACTERISTICS

Characteristic	Symbol	Max	Unit
Total Device Dissipation FR-5 Board ⁽¹⁾ $T_A = 25^\circ\text{C}$ Derate above 25°C	P_D	225	mW
		1.8	mW/ $^\circ\text{C}$
Thermal Resistance, Junction to Ambient	$R_{\theta JA}$	556	$^\circ\text{C}/\text{W}$
Junction and Storage Temperature	T_J, T_{stg}	-55 to +150	$^\circ\text{C}$

DEVICE MARKING

MMBF5460LT1 = 6E

ELECTRICAL CHARACTERISTICS ($T_A = 25^\circ\text{C}$ unless otherwise noted)

Characteristic	Symbol	Min	Typ	Max	Unit
----------------	--------	-----	-----	-----	------

OFF CHARACTERISTICS

Gate-Source Breakdown Voltage ($I_G = 10 \mu\text{Adc}, V_{DS} = 0$)	$V_{(BR)GSS}$	40	—	—	Vdc
Gate Reverse Current ($V_{GS} = 20 \text{ Vdc}, V_{DS} = 0$) ($V_{GS} = 20 \text{ Vdc}, V_{DS} = 0, T_A = 100^\circ\text{C}$)	I_{GSS}	—	—	5.0 1.0	nAdc μAdc
Gate Source Cutoff Voltage ($V_{DS} = 15 \text{ Vdc}, I_D = 1.0 \mu\text{Adc}$)	$V_{GS(off)}$	0.75	—	6.0	Vdc
Gate Source Voltage ($V_{DS} = 15 \text{ Vdc}, I_D = 0.1 \text{ mAdc}$)	V_{GS}	0.5	—	4.0	Vdc

ON CHARACTERISTICS

Zero-Gate-Voltage Drain Current ($V_{DS} = 15 \text{ Vdc}, V_{GS} = 0$)	I_{DSS}	-1.0	—	-5.0	mAdc
---------------------------------------------------------------------------	-----------	------	---	------	------

SMALL-SIGNAL CHARACTERISTICS

Forward Transfer Admittance ($V_{DS} = 15 \text{ Vdc}, V_{GS} = 0, f = 1.0 \text{ kHz}$)	$ Y_{fs} $	1000	—	4000	μmhos
Output Admittance ($V_{DS} = 15 \text{ Vdc}, V_{GS} = 0, f = 1.0 \text{ kHz}$)	$ Y_{os} $	—	—	75	μmhos
Input Capacitance ($V_{DS} = 15 \text{ Vdc}, V_{GS} = 0, f = 1.0 \text{ MHz}$)	C_{iss}	—	5.0	7.0	pF
Reverse Transfer Capacitance ($V_{DS} = 15 \text{ Vdc}, V_{GS} = 0, f = 1.0 \text{ MHz}$)	C_{rss}	—	1.0	2.0	pF
Equivalent Short-Circuit Input Noise Voltage ($V_{DS} = 15 \text{ Vdc}, V_{GS} = 0, R_G = 1.0 \text{ M}\Omega$, $f = 100 \text{ Hz}, \text{BW} = 1.0 \text{ Hz}$)	e_n	—	20	—	$\text{nV}/\sqrt{\text{Hz}}$

1. FR-5 = $1.0 \times 0.75 \times 0.062 \text{ in.}$

DRAIN CURRENT versus GATE SOURCE VOLTAGE

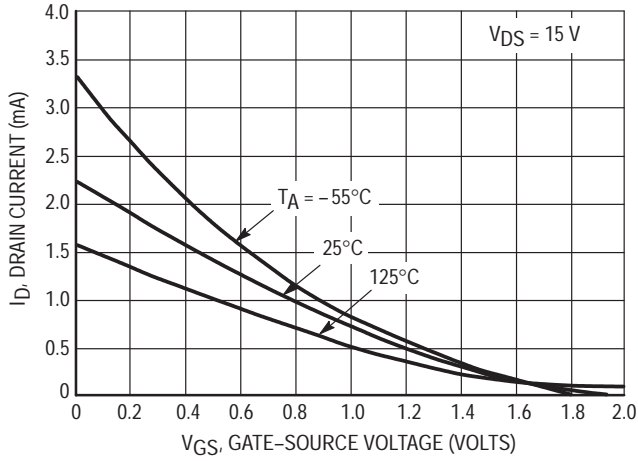


Figure 1. $V_{GS(off)} = 2.0$ Volts

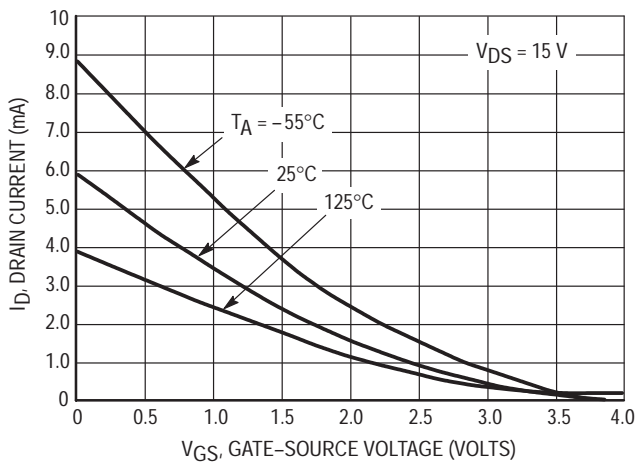


Figure 2. $V_{GS(off)} = 4.0$ Volts

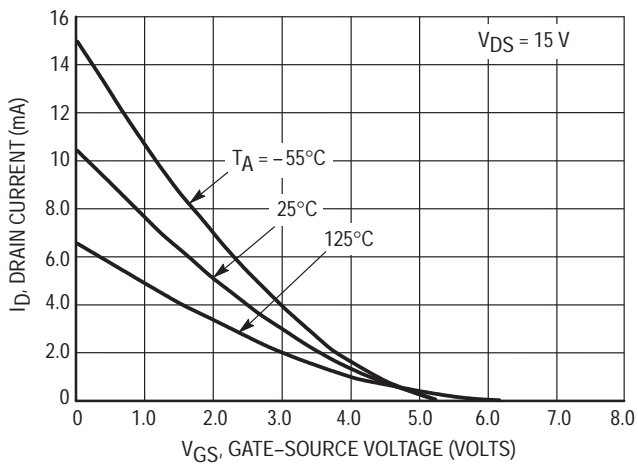


Figure 3. $V_{GS(off)} = 5.0$ Volts

FORWARD TRANSFER ADMITTANCE versus DRAIN CURRENT

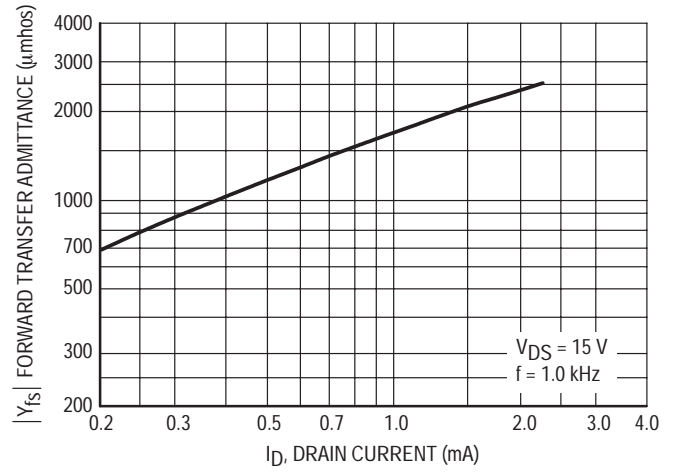


Figure 4. $V_{GS(off)} = 2.0$ Volts

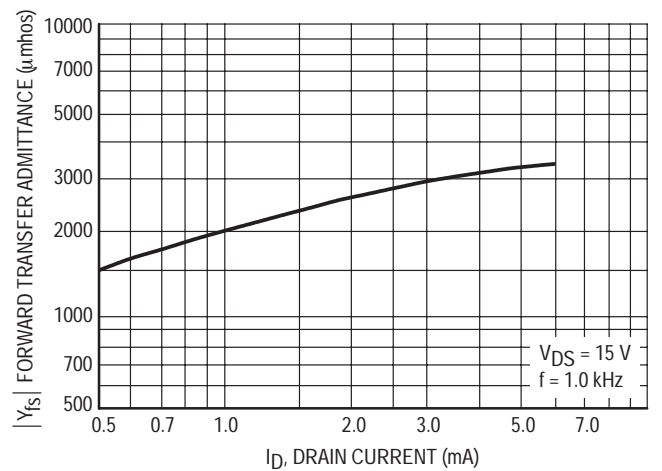


Figure 5. $V_{GS(off)} = 4.0$ Volts

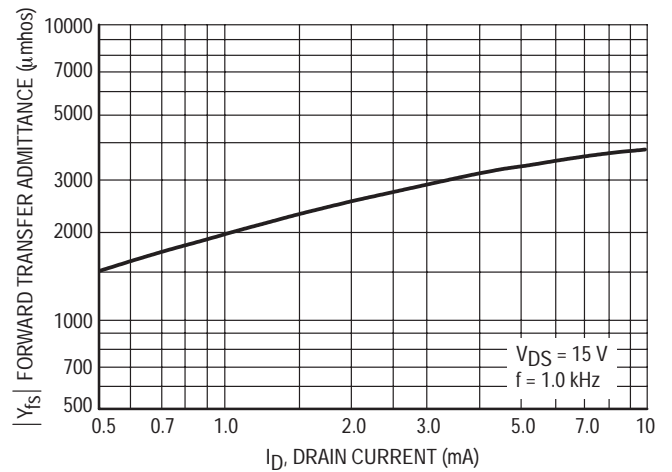


Figure 6. $V_{GS(off)} = 5.0$ Volts

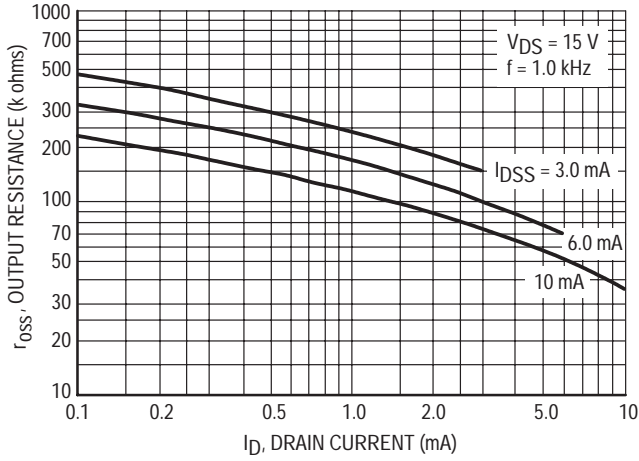


Figure 7. Output Resistance versus Drain Current

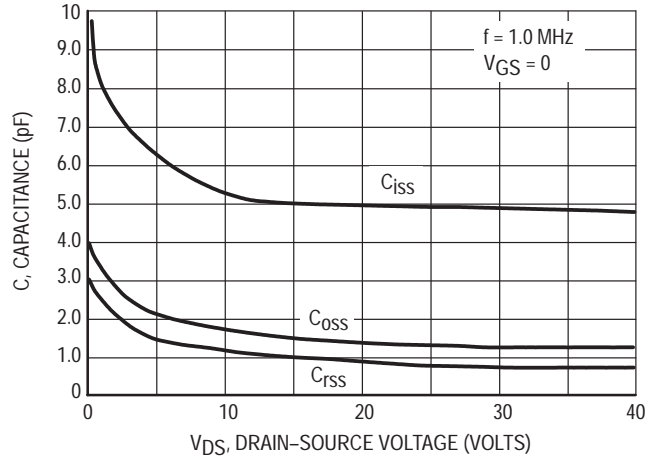


Figure 8. Capacitance versus Drain-Source Voltage

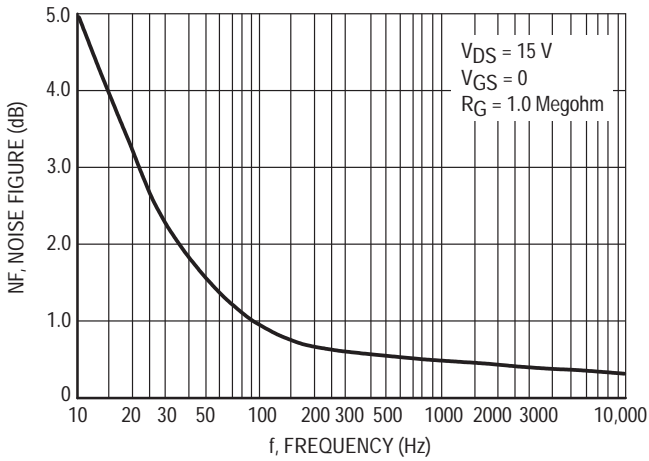


Figure 9. Noise Figure versus Frequency

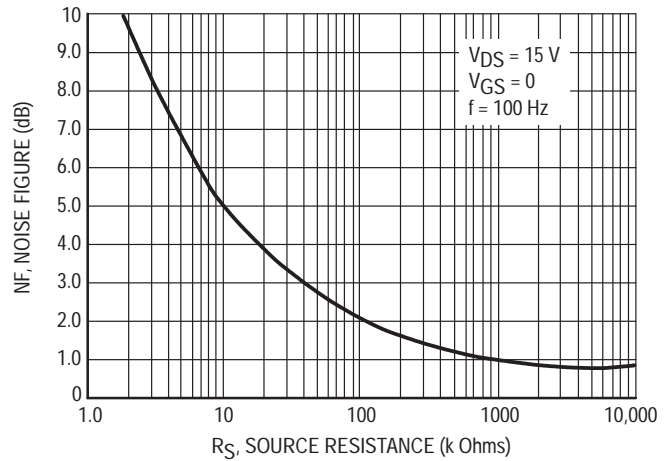
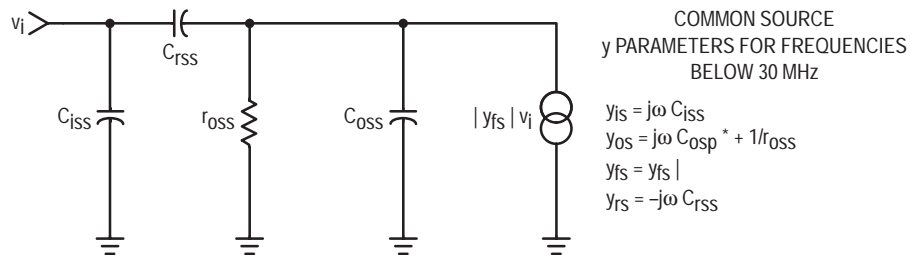


Figure 10. Noise Figure versus Source Resistance



* C_{osp} is C_{oss} in parallel with Series Combination of C_{iss} and C_{rss} .

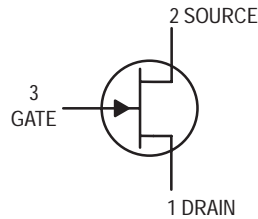
NOTE:

- Graphical data is presented for dc conditions. Tabular data is given for pulsed conditions (Pulse Width = 630 ms, Duty Cycle = 10%).

Figure 11. Equivalent Low Frequency Circuit

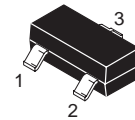
JFET Transistor

N-Channel



MMBF5484LT1

Motorola Preferred Device



CASE 318-08, STYLE 10
SOT-23 (TO-236AB)

MAXIMUM RATINGS

Rating	Symbol	Value	Unit
Drain-Gate Voltage	V_{DG}	25	Vdc
Reverse Gate-Source Voltage	$V_{GS(r)}$	25	Vdc
Forward Gate Current	$I_{G(f)}$	10	mAdc
Continuous Device Dissipation at or Below $T_C = 25^\circ\text{C}$ Linear Derating Factor	P_D	200 2.8	mW mW/°C
Storage Channel Temperature Range	T_{stg}	-65 to +150	°C

THERMAL CHARACTERISTICS

Characteristic	Symbol	Max	Unit
Total Device Dissipation FR-5 Board ⁽¹⁾ $T_A = 25^\circ\text{C}$ Derate above 25°C	P_D	225 1.8	mW mW/°C
Thermal Resistance, Junction to Ambient	$R_{\theta JA}$	556	°C/W
Junction and Storage Temperature	T_J, T_{stg}	-55 to +150	°C

DEVICE MARKING

MMBF5484LT1 = 6B

ELECTRICAL CHARACTERISTICS ($T_A = 25^\circ\text{C}$ unless otherwise noted)

Characteristic	Symbol	Min	Max	Unit
----------------	--------	-----	-----	------

OFF CHARACTERISTICS

Gate-Source Breakdown Voltage ($I_G = -1.0 \mu\text{Adc}, V_{DS} = 0$)	$V_{(BR)GSS}$	-25	—	Vdc
Gate Reverse Current ($V_{GS} = -20 \text{ Vdc}, V_{DS} = 0$) ($V_{GS} = -20 \text{ Vdc}, V_{DS} = 0, T_A = 100^\circ\text{C}$)	I_{GSS}	— —	-1.0 -0.2	nAdc μAdc
Gate Source Cutoff Voltage ($V_{DS} = 15 \text{ Vdc}, I_D = 10 \text{ nAdc}$)	$V_{GS(off)}$	-0.3	-3.0	Vdc

ON CHARACTERISTICS

Zero-Gate-Voltage Drain Current ($V_{DS} = 15 \text{ Vdc}, V_{GS} = 0$)	I_{DSS}	1.0	5.0	mAdc
------------------------------------------------------------------------------	-----------	-----	-----	------

SMALL-SIGNAL CHARACTERISTICS

Forward Transfer Admittance ($V_{DS} = 15 \text{ Vdc}, V_{GS} = 0, f = 1.0 \text{ kHz}$)	$ Y_{fs} $	3000	6000	μhos
Output Admittance ($V_{DS} = 15 \text{ Vdc}, V_{GS} = 0, f = 1.0 \text{ kHz}$)	$ Y_{os} $	—	50	μhos

1. FR-5 = $1.0 \times 0.75 \times 0.062$ in.

Preferred devices are Motorola recommended choices for future use and best overall value.

MMBF5484LT1

ELECTRICAL CHARACTERISTICS ($T_A = 25^\circ\text{C}$ unless otherwise noted) (Continued)

Characteristic	Symbol	Min	Max	Unit
SMALL-SIGNAL CHARACTERISTICS (Continued)				
Input Capacitance ($V_{DS} = 15\text{ Vdc}$, $V_{GS} = 0$, $f = 1.0\text{ MHz}$)	C_{iss}	—	5.0	pF
Reverse Transfer Capacitance ($V_{DS} = 15\text{ Vdc}$, $V_{GS} = 0$, $f = 10\text{ MHz}$)	C_{rss}	—	1.0	pF
Output Capacitance ($V_{DS} = 15\text{ Vdc}$, $V_{GS} = 0$, $f = 1.0\text{ MHz}$)	C_{oss}	—	2.0	pF
FUNCTIONAL CHARACTERISTICS				
Noise Figure ($V_{DS} = 15\text{ Vdc}$, $I_D = 1.0\text{ mAdc}$, $Y_G' = 1.0\text{ mmhos}$) ($R_G = 1.0\text{ k}\Omega$, $f = 100\text{ MHz}$) ($V_{DS} = 15\text{ Vdc}$, $V_{GS} = 0$, $Y_G' = 1.0\text{ }\mu\text{mhos}$) ($R_G = 1.0\text{ M}\Omega$, $f = 1.0\text{ kHz}$)	NF	—	3.0	dB
Common Source Power Gain ($V_{DS} = 15\text{ Vdc}$, $I_D = 1.0\text{ mAdc}$, $f = 100\text{ MHz}$)	G_{ps}	16	25	dB

POWER GAIN

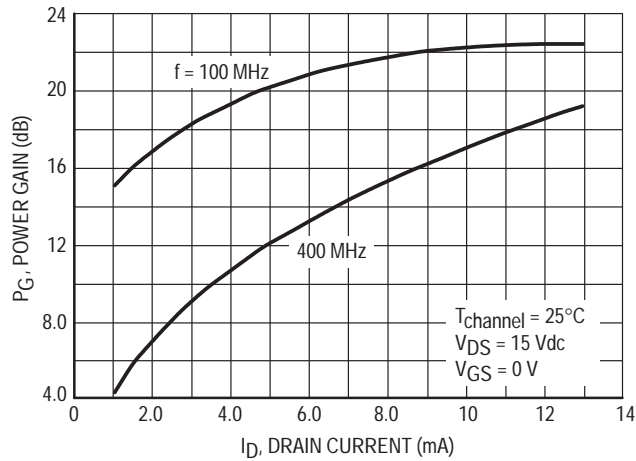
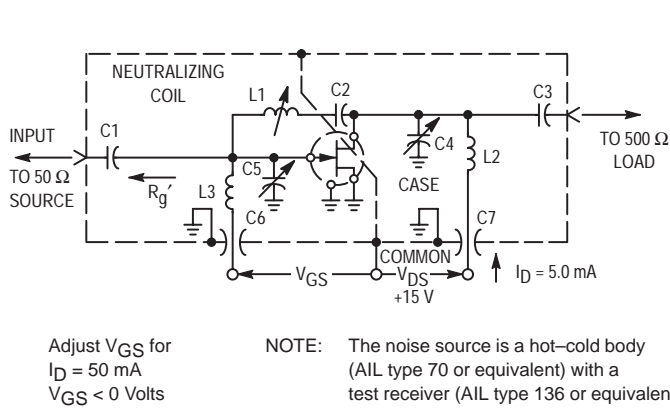


Figure 1. Effects of Drain Current



Reference Designation	VALUE	
	100 MHz	400 MHz
C1	7.0 pF	1.8 pF
C2	1000 pF	17 pF
C3	3.0 pF	1.0 pF
C4	1–12 pF	0.8–8.0 pF
C5	1–12 pF	0.8–8.0 pF
C6	0.0015 μF	0.001 μF
C7	0.0015 μF	0.001 μF
L1	3.0 μH*	0.2 μH**
L2	0.15 μH*	0.03 μH**
L3	0.14 μH*	0.022 μH**

- *L1 17 turns, (approx. — depends upon circuit layout) AWG #28 enameled copper wire, close wound on 9/32" ceramic coil form. Tuning provided by a powdered iron slug.
- L2 4–1/2 turns, AWG #18 enameled copper wire, 5/16" long, 3/8" I.D. (AIR CORE).
- L3 3–1/2 turns, AWG #18 enameled copper wire, 1/4" long, 3/8" I.D. (AIR CORE).

- **L1 6 turns, (approx. — depends upon circuit layout) AWG #24 enameled copper wire, close wound on 7/32" ceramic coil form. Tuning provided by an aluminum slug.
- L2 1 turn, AWG #16 enameled copper wire, 3/8" I.D. (AIR CORE).
- L3 1/2 turn, AWG #16 enameled copper wire, 1/4" I.D. (AIR CORE).

Figure 2. 100 MHz and 400 MHz Neutralized Test Circuit

NOISE FIGURE
(T_{channel} = 25°C)

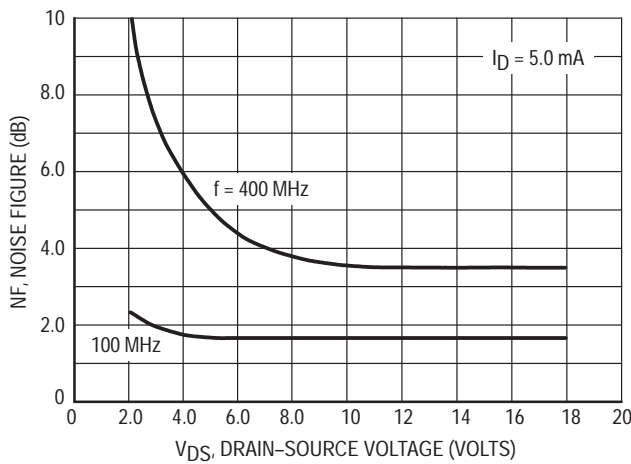


Figure 3. Effects of Drain-Source Voltage

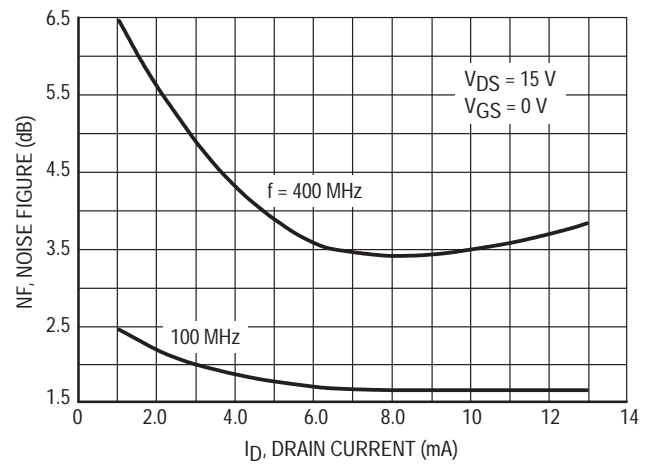


Figure 4. Effects of Drain Current

INTERMODULATION CHARACTERISTICS

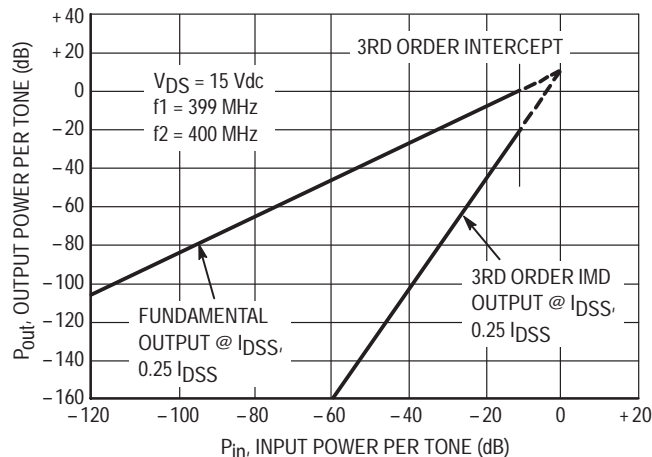


Figure 5. Third Order Intermodulation Distortion

COMMON SOURCE CHARACTERISTICS

ADMITTANCE PARAMETERS

($V_{DS} = 15 \text{ Vdc}$, $T_{channel} = 25^\circ\text{C}$)

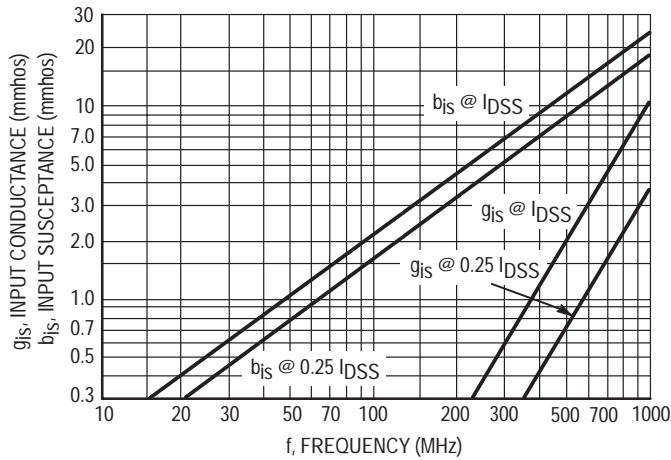


Figure 6. Input Admittance (y_{is})

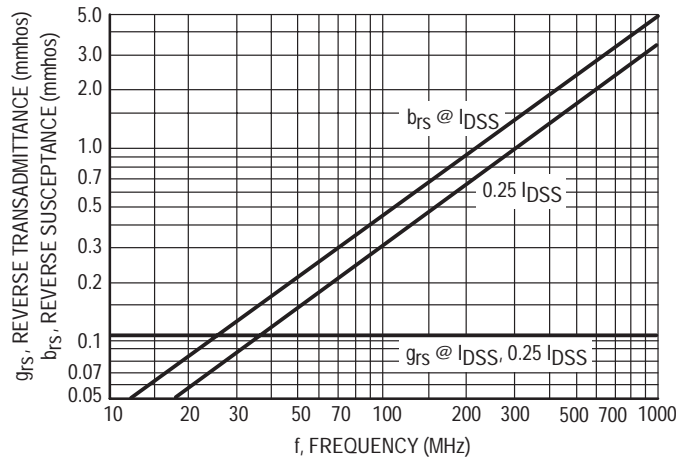


Figure 7. Reverse Transfer Admittance (y_{rs})

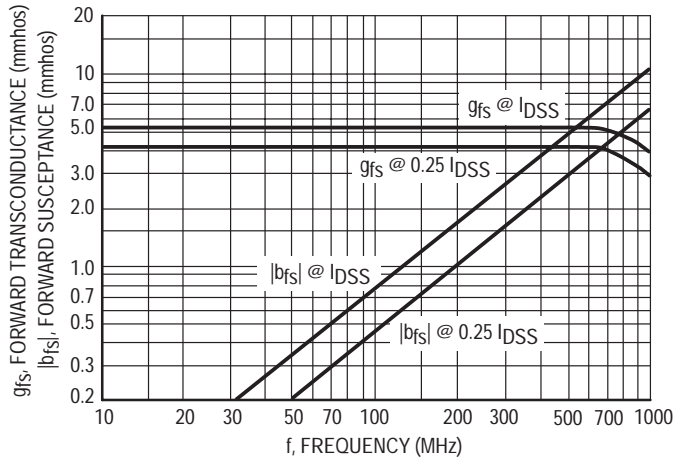


Figure 8. Forward Transadmittance (y_{fs})

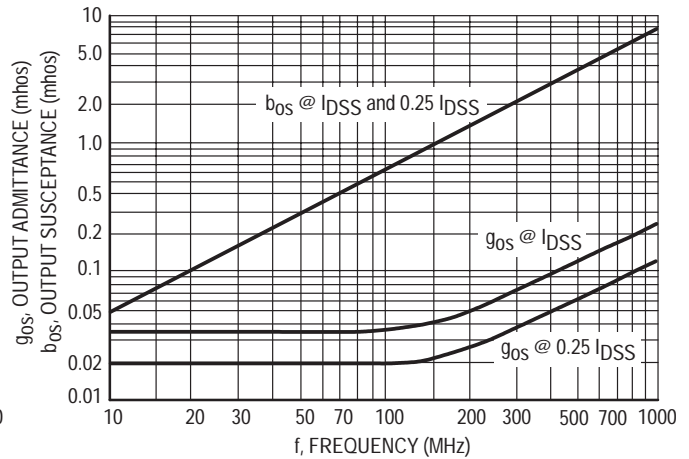


Figure 9. Output Admittance (y_{os})

COMMON SOURCE CHARACTERISTICS
S-PARAMETERS
 ($V_{DS} = 15\text{ Vdc}$, $T_{channel} = 25^\circ\text{C}$, Data Points in MHz)

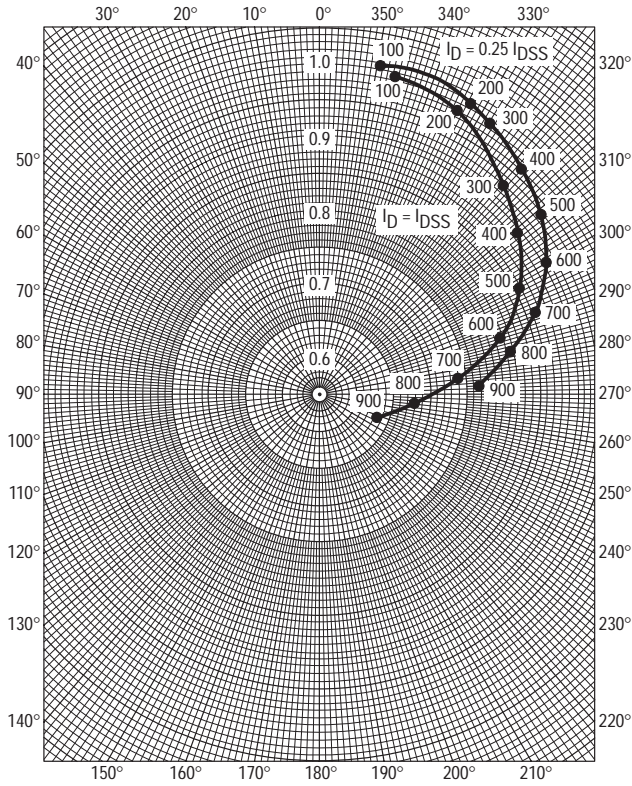


Figure 10. S_{11s}

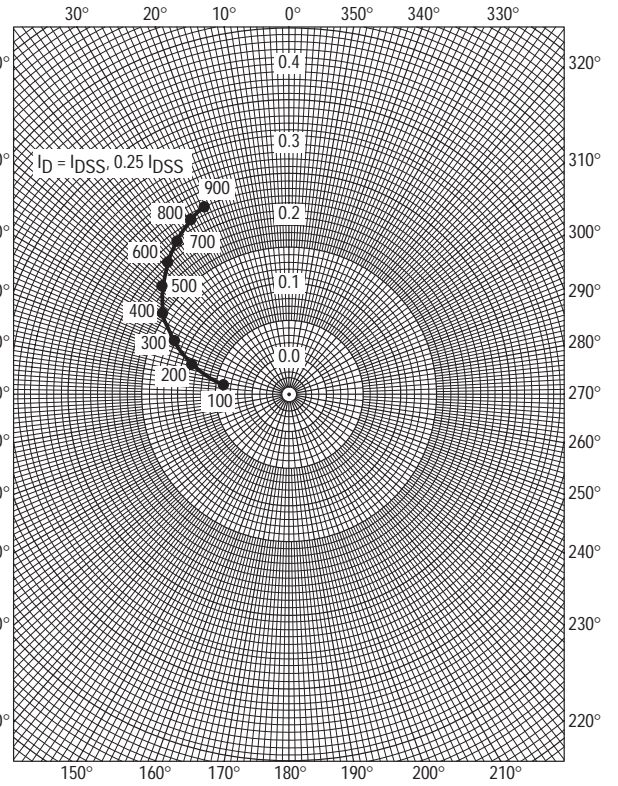


Figure 11. S_{12s}

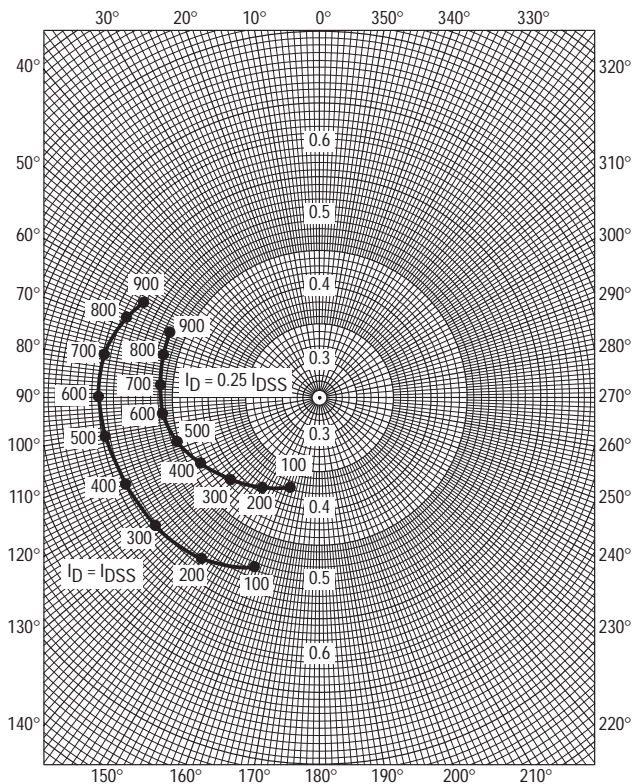


Figure 12. S_{21s}

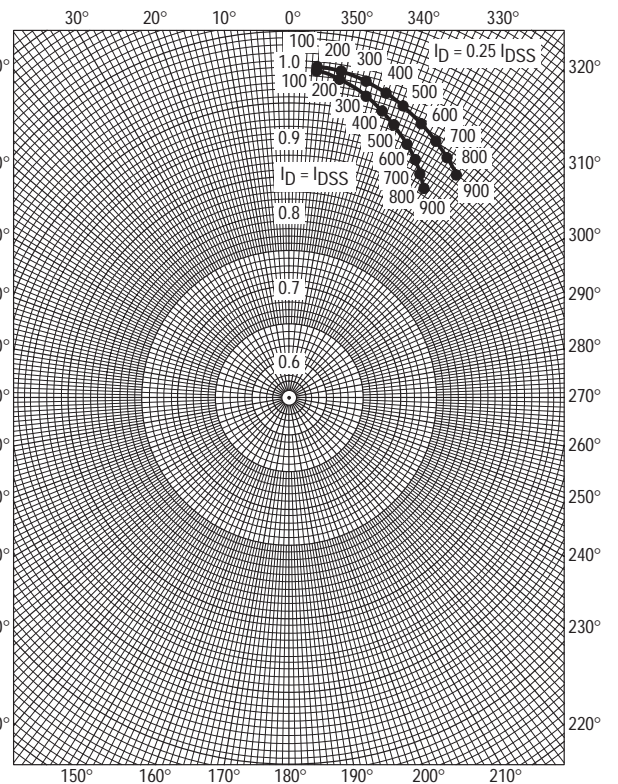


Figure 13. S_{22s}

COMMON GATE CHARACTERISTICS

ADMITTANCE PARAMETERS

(VDG = 15 Vdc, Tchannel = 25°C)

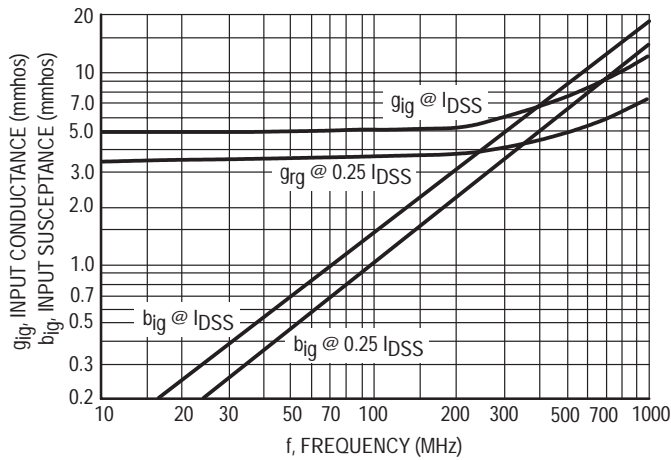


Figure 14. Input Admittance (y_{ig})

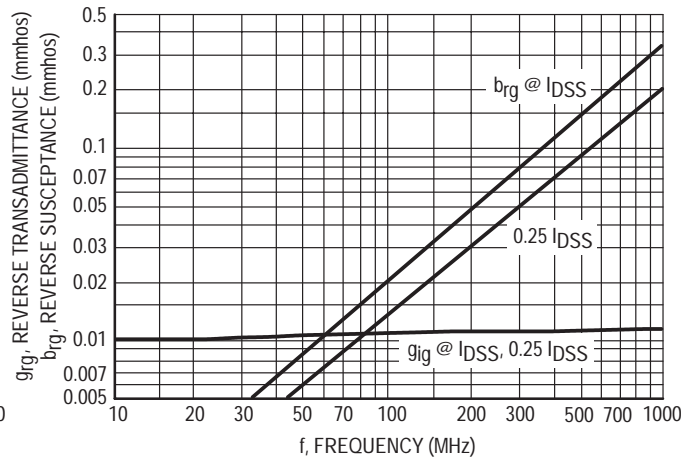


Figure 15. Reverse Transfer Admittance (y_{rg})

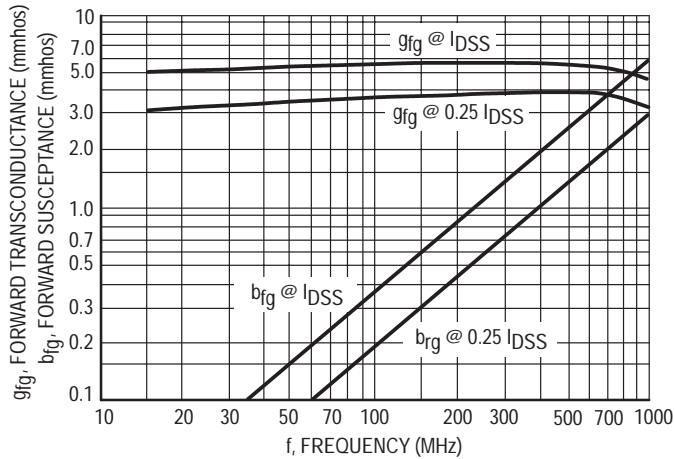


Figure 16. Forward Transfer Admittance (y_{fg})

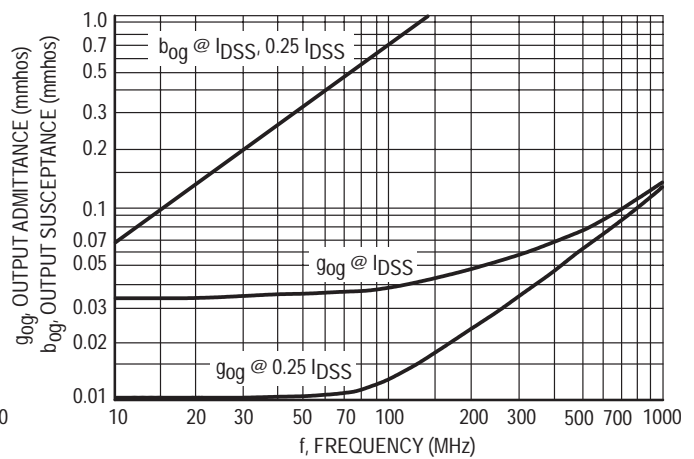


Figure 17. Output Admittance (y_{og})

COMMON GATE CHARACTERISTICS
S-PARAMETERS

($V_{DS} = 15 \text{ Vdc}$, $T_{channel} = 25^\circ\text{C}$, Data Points in MHz)

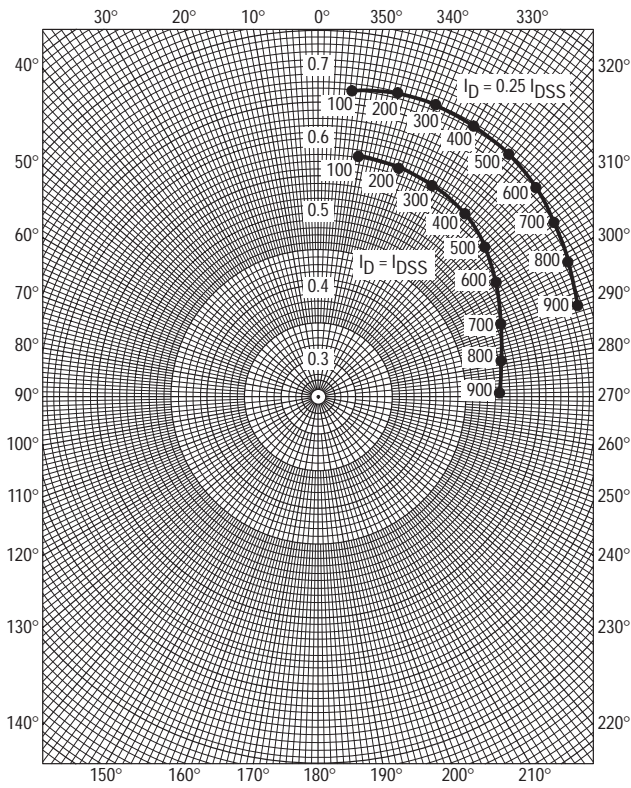


Figure 18. S_{11g}

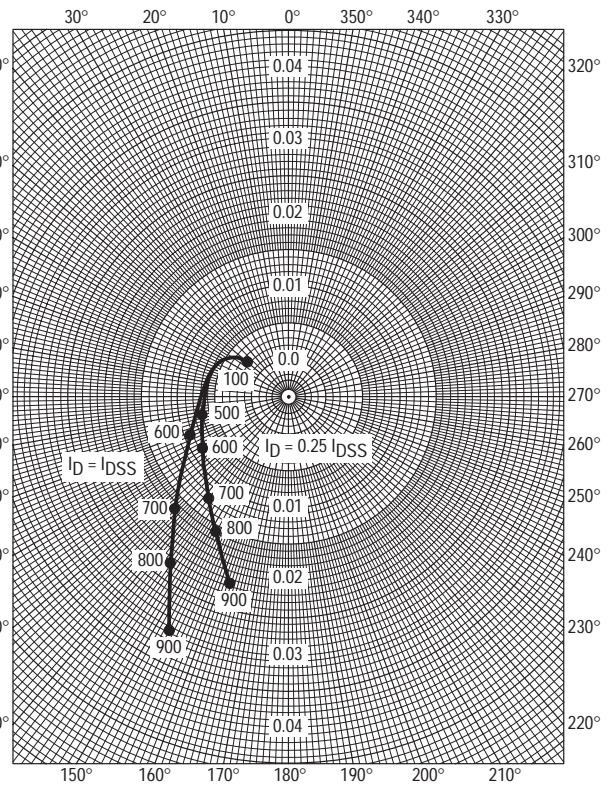


Figure 19. S_{12g}

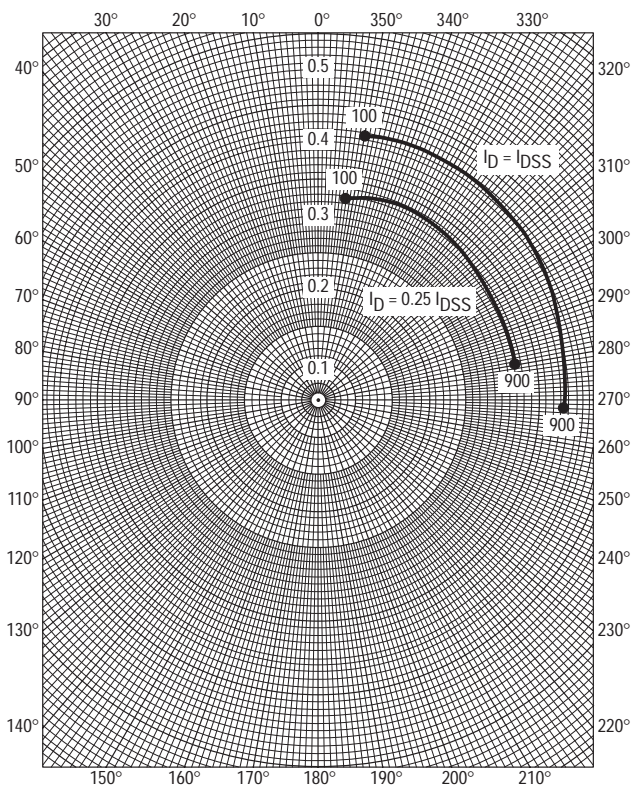


Figure 20. S_{21g}

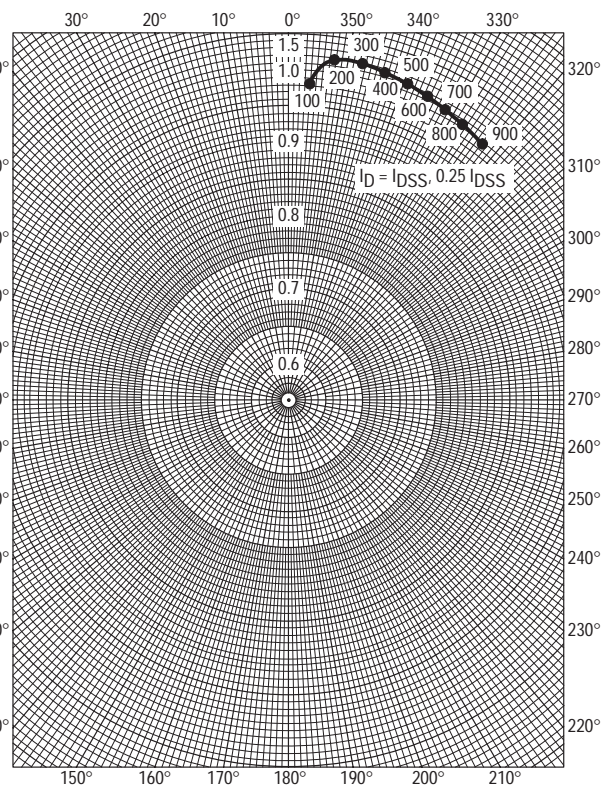


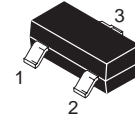
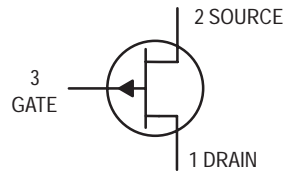
Figure 21. S_{22g}

JFET Chopper

P-Channel — Depletion

MMBFJ175LT1

Motorola Preferred Device



CASE 318-08, STYLE 10
SOT-23 (TO-236AB)

MAXIMUM RATINGS

Rating	Symbol	Value	Unit
Drain-Source Voltage	V_{DS}	25	V
Reverse Gate-Source Voltage	$V_{GS(r)}$	-25	V

THERMAL CHARACTERISTICS

Characteristic	Symbol	Max	Unit
Total Device Dissipation FR-5 Board ⁽¹⁾ $T_A = 25^\circ\text{C}$ Derate above 25°C	P_D	225 1.8	mW mW/ $^\circ\text{C}$
Thermal Resistance Junction to Ambient	$R_{\theta JA}$	556	$^\circ\text{C}/\text{W}$
Junction and Storage Temperature	T_J, T_{stg}	-55 to +150	$^\circ\text{C}$

DEVICE MARKING

MMBFJ175LT1 = 6W

ELECTRICAL CHARACTERISTICS ($T_A = 25^\circ\text{C}$ unless otherwise noted)

Characteristic	Symbol	Min	Max	Unit
----------------	--------	-----	-----	------

OFF CHARACTERISTICS

Gate-Source Breakdown Voltage ($V_{DS} = 0, I_D = 1.0 \mu\text{A}$)	$V_{(BR)GSS}$	30	—	V
Gate Reverse Current ($V_{DS} = 0 \text{ V}, V_{GS} = 20 \text{ V}$)	I_{GSS}	—	1.0	nA
Gate-Source Cutoff Voltage ($V_{DS} = 15, I_D = 10 \text{ nA}$)	$V_{GS(OFF)}$	3.0	6.0	V

ON CHARACTERISTICS

Zero-Gate-Voltage Drain Current ⁽²⁾ ($V_{GS} = 0, V_{DS} = 15 \text{ V}$)	I_{DSS}	7.0	60	mA
Drain Cutoff Current ($V_{DS} = 15 \text{ V}, V_{GS} = 10 \text{ V}$)	$I_{D(off)}$	—	1.0	nA
Drain Source On Resistance ($I_D = 500 \mu\text{A}$)	$r_{DS(on)}$	—	125	Ω
Input Capacitance	$V_{DS} = 0, V_{GS} = 10 \text{ V}$ $f = 1.0 \text{ MHz}$	C_{iss}	—	11 5.5
Reverse Transfer Capacitance		C_{rss}	—	

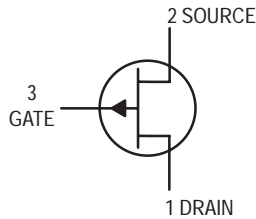
1. FR-5 = $1.0 \times 0.75 \times 0.062 \text{ in.}$

2. Pulse Test: Pulse Width $\leq 300 \mu\text{s}$, Duty Cycle $\leq 2.0\%$.

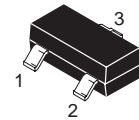
Preferred devices are Motorola recommended choices for future use and best overall value.

JFET Chopper

P-Channel — Depletion



MMBFJ177LT1



CASE 318-08, STYLE 10
SOT-23 (TO-236AB)

MAXIMUM RATINGS

Rating	Symbol	Value	Unit
Drain-Source Voltage	V_{DS}	25	Vdc
Reverse Gate-Source Voltage	$V_{GS(r)}$	-25	Vdc

THERMAL CHARACTERISTICS

Characteristic	Symbol	Max	Unit
Total Device Dissipation FR-5 Board ⁽¹⁾ $T_A = 25^\circ\text{C}$ Derate above 25°C	P_D	225 1.8	mW mW/ $^\circ\text{C}$
Thermal Resistance, Junction to Ambient	$R_{\theta JA}$	556	$^\circ\text{C}/\text{W}$
Junction and Storage Temperature	T_J, T_{stg}	-55 to +150	$^\circ\text{C}$

DEVICE MARKING

MMBFJ177LT1 = 6Y

ELECTRICAL CHARACTERISTICS ($T_A = 25^\circ\text{C}$ unless otherwise noted)

Characteristic	Symbol	Min	Max	Unit
----------------	--------	-----	-----	------

OFF CHARACTERISTICS

Gate-Source Breakdown Voltage ($V_{DS} = 0, I_D = 1.0 \mu\text{Adc}$)	$V_{(BR)GSS}$	30	—	Vdc
Gate Reverse Current ($V_{DS} = 0 \text{ Vdc}, V_{GS} = 20 \text{ Vdc}$)	I_{GSS}	—	1.0	nAdc
Gate Source Cutoff Voltage ($V_{DS} = 15 \text{ Vdc}, I_D = 10 \text{ nAdc}$)	$V_{GS(off)}$	0.8	2.5	Vdc

ON CHARACTERISTICS

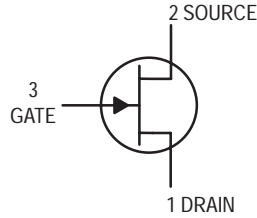
Zero-Gate-Voltage Drain Current ⁽²⁾ ($V_{GS} = 0, V_{DS} = 15 \text{ Vdc}$)	I_{DSS}	1.5	20	mAdc
Drain Cutoff Current ($V_{DS} = 15 \text{ Vdc}, V_{GS} = 10 \text{ Vdc}$)	$I_{D(off)}$	—	1.0	nAdc
Drain Source On Resistance ($I_D = 500 \mu\text{Adc}$)	$r_{DS(on)}$	—	300	Ω
Input Capacitance	$V_{DS} = 0, V_{GS} = 10 \text{ Vdc}$ $f = 1.0 \text{ MHz}$	C_{iss}	—	11
Reverse Transfer Capacitance		C_{rss}	—	5.5

1. FR-5 = $1.0 \times 0.75 \times 0.062 \text{ in.}$

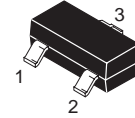
2. Pulse Test: Pulse Width < 300 μs , Duty Cycle $\leq 2\%$.

JFET VHF/UHF Amplifier Transistor

N-Channel



MMBFJ309LT1
MMBFJ310LT1



CASE 318-08, STYLE 10
SOT-23 (TO-236AB)

MAXIMUM RATINGS

Rating	Symbol	Value	Unit
Drain-Source Voltage	V_{DS}	25	Vdc
Gate-Source Voltage	V_{GS}	25	Vdc
Gate Current	I_G	10	mAdc

THERMAL CHARACTERISTICS

Characteristic	Symbol	Max	Unit
Total Device Dissipation FR-5 Board ⁽¹⁾ $T_A = 25^\circ\text{C}$ Derate above 25°C	P_D	225 1.8	mW mW/ $^\circ\text{C}$
Thermal Resistance, Junction to Ambient	$R_{\theta JA}$	556	$^\circ\text{C}/\text{W}$
Junction and Storage Temperature	T_J, T_{stg}	-55 to +150	$^\circ\text{C}$

DEVICE MARKING

MMBFJ309LT1 = 6U; MMBFJ310LT1 = 6T

ELECTRICAL CHARACTERISTICS ($T_A = 25^\circ\text{C}$ unless otherwise noted)

Characteristic	Symbol	Min	Typ	Max	Unit
----------------	--------	-----	-----	-----	------

OFF CHARACTERISTICS

Gate-Source Breakdown Voltage ($I_G = -1.0 \mu\text{Adc}$, $V_{DS} = 0$)	$V_{(BR)GSS}$	-25	—	—	Vdc
Gate Reverse Current ($V_{GS} = -15 \text{ Vdc}$) ($V_{GS} = -15 \text{ Vdc}$, $T_A = 125^\circ\text{C}$)	I_{GSS}	—	—	-1.0 -1.0	nAdc μAdc
Gate Source Cutoff Voltage ($V_{DS} = 10 \text{ Vdc}$, $I_D = 1.0 \text{ nAdc}$)	MMBFJ309 MMBFJ310 $V_{GS(off)}$	-1.0 -2.0	—	-4.0 -6.5	Vdc

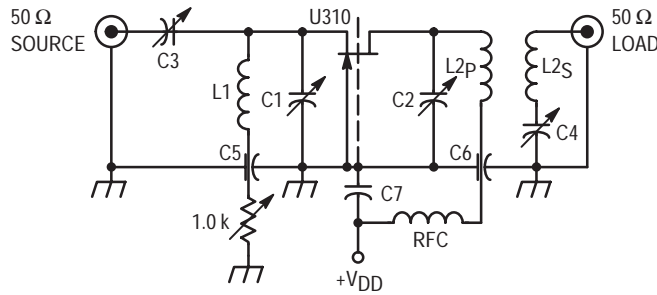
ON CHARACTERISTICS

Zero-Gate-Voltage Drain Current ($V_{DS} = 10 \text{ Vdc}$, $V_{GS} = 0$)	MMBFJ309 MMBFJ310 I_{DSS}	12 24	—	30 60	mAdc
Gate-Source Forward Voltage ($I_G = 1.0 \text{ mAdc}$, $V_{DS} = 0$)	$V_{GS(f)}$	—	—	1.0	Vdc

SMALL-SIGNAL CHARACTERISTICS

Forward Transfer Admittance ($V_{DS} = 10 \text{ Vdc}$, $I_D = 10 \text{ mAdc}$, $f = 1.0 \text{ kHz}$)	$ Y_{fs} $	8.0	—	18	mmhos
Output Admittance ($V_{DS} = 10 \text{ Vdc}$, $I_D = 10 \text{ mAdc}$, $f = 1.0 \text{ kHz}$)	$ y_{os} $	—	—	250	μmhos
Input Capacitance ($V_{GS} = -10 \text{ Vdc}$, $V_{DS} = 0 \text{ Vdc}$, $f = 1.0 \text{ MHz}$)	C_{iss}	—	—	5.0	pF
Reverse Transfer Capacitance ($V_{GS} = -10 \text{ Vdc}$, $V_{DS} = 0 \text{ Vdc}$, $f = 1.0 \text{ MHz}$)	C_{rss}	—	—	2.5	pF
Equivalent Short-Circuit Input Noise Voltage ($V_{DS} = 10 \text{ Vdc}$, $I_D = 10 \text{ mAdc}$, $f = 100 \text{ Hz}$)	e_n	—	10	—	$\text{nV}/\sqrt{\text{Hz}}$

1. FR-5 = $1.0 \times 0.75 \times 0.062 \text{ in.}$



- C1 = C2 = 0.8 – 10 pF, JFD #MVM010W.
- C3 = C4 = 8.35 pF Erie #539-002D.
- C5 = C6 = 5000 pF Erie (2443-000).
- C7 = 1000 pF, Allen Bradley #FA5C.
- RFC = 0.33 μH Miller #9230-30.
- L1 = One Turn #16 Cu, 1/4" I.D. (Air Core).
- L2p = One Turn #16 Cu, 1/4" I.D. (Air Core).
- L2s = One Turn #16 Cu, 1/4" I.D. (Air Core).

Figure 1. 450 MHz Common-Gate Amplifier Test Circuit

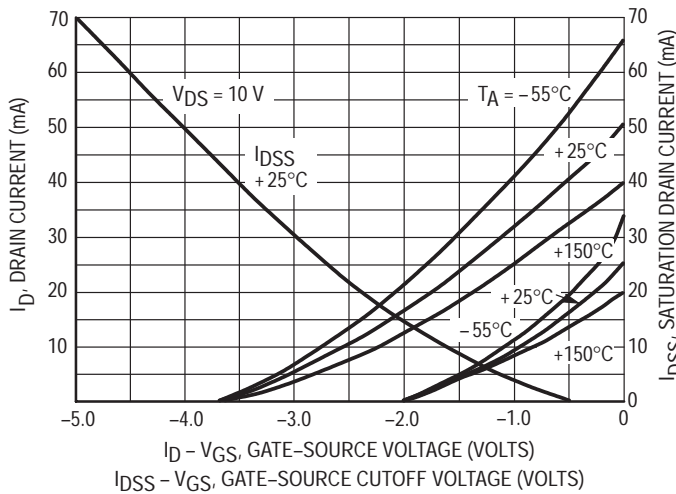


Figure 2. Drain Current and Transfer Characteristics versus Gate-Source Voltage

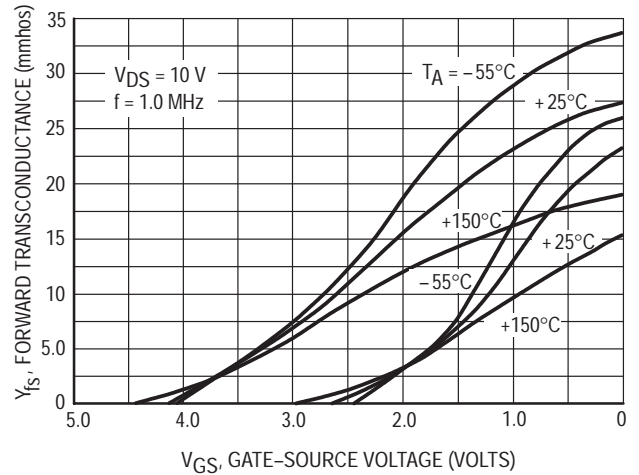


Figure 3. Forward Transconductance versus Gate-Source Voltage

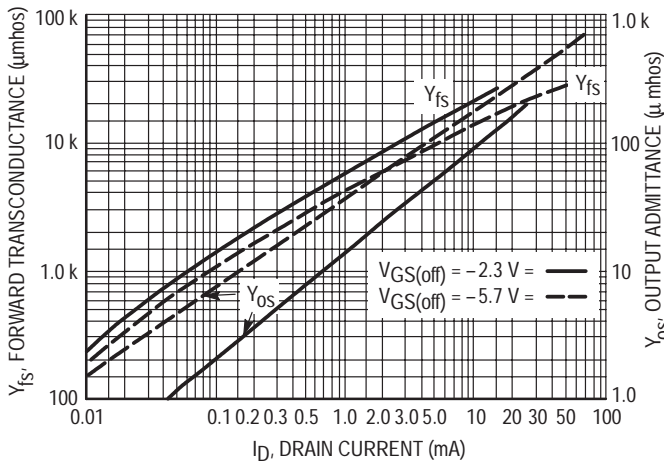


Figure 4. Common-Source Output Admittance and Forward Transconductance versus Drain Current

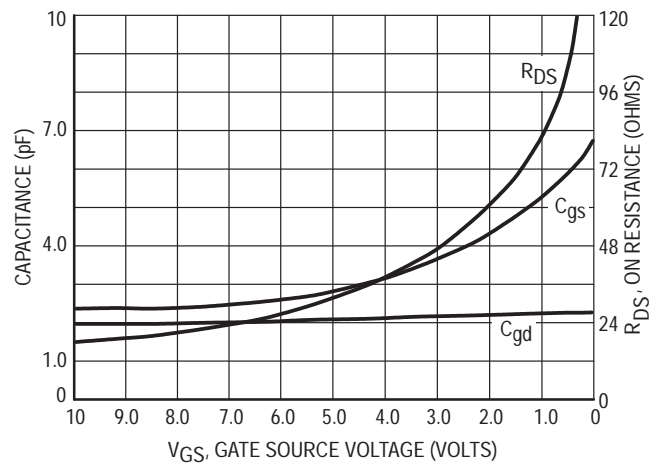


Figure 5. On Resistance and Junction Capacitance versus Gate-Source Voltage

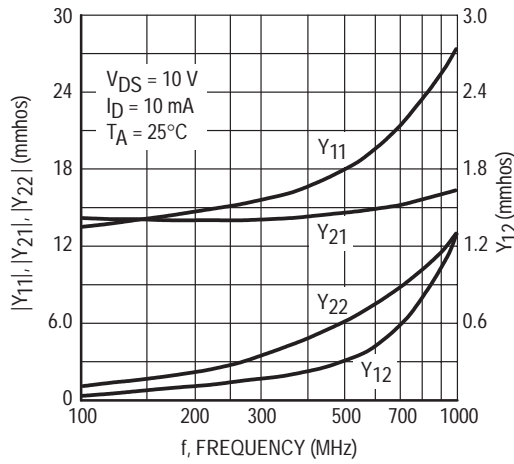


Figure 6. Common-Gate Y Parameter Magnitude versus Frequency

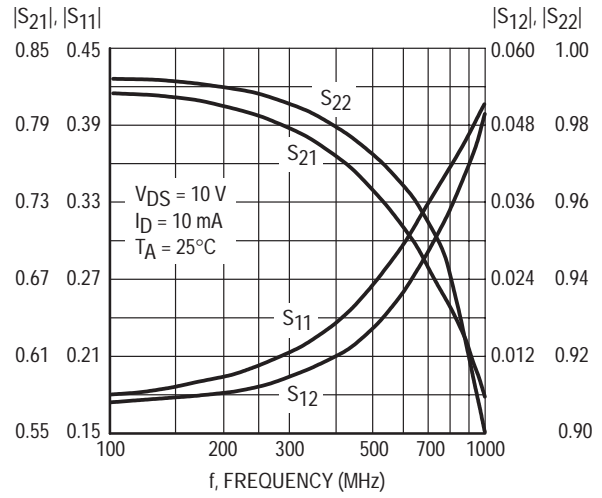


Figure 7. Common-Gate S Parameter Magnitude versus Frequency

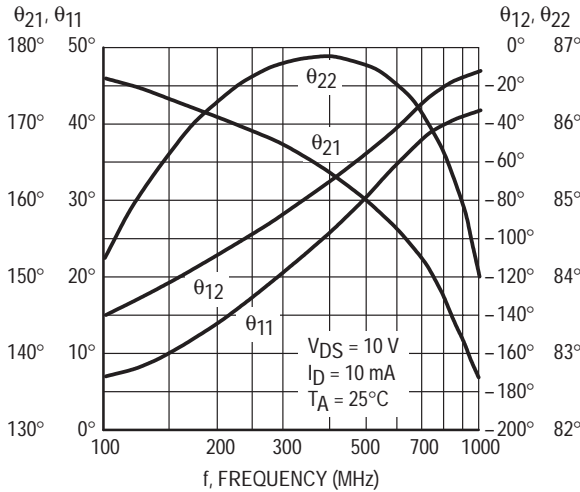


Figure 8. Common-Gate Y Parameter Phase-Angle versus Frequency

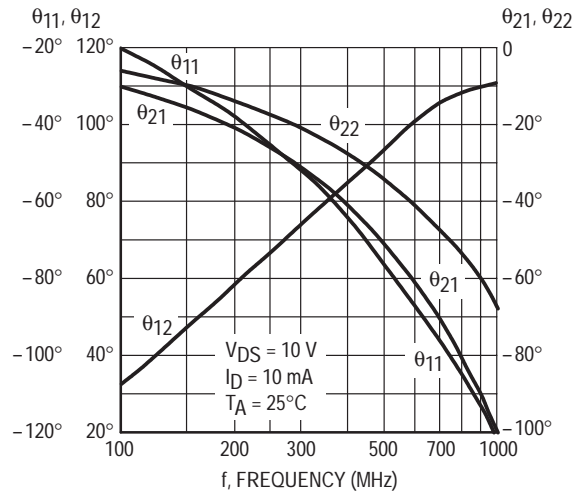


Figure 9. S Parameter Phase-Angle versus Frequency

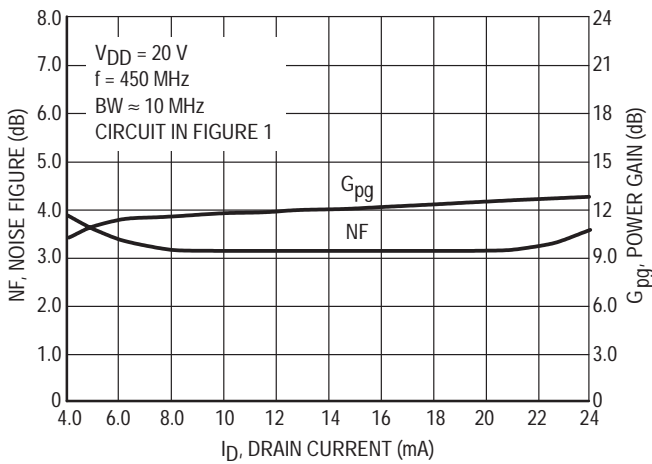


Figure 10. Noise Figure and Power Gain versus Drain Current

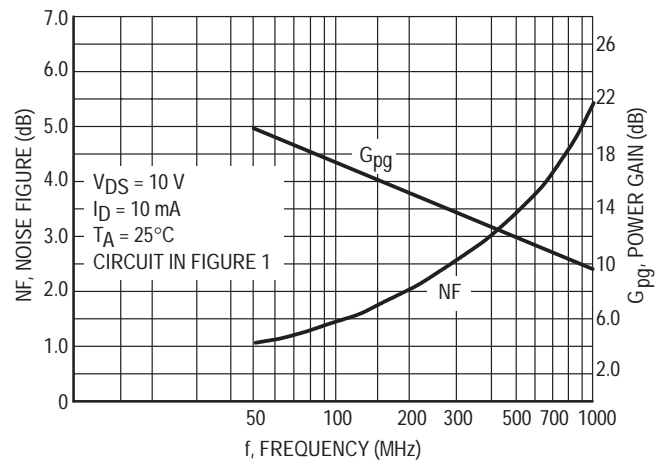
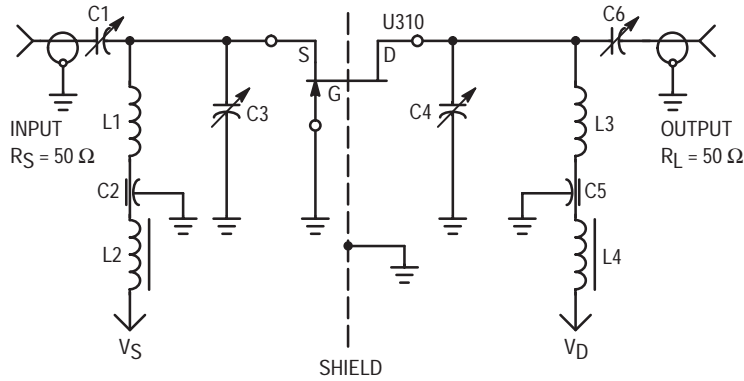


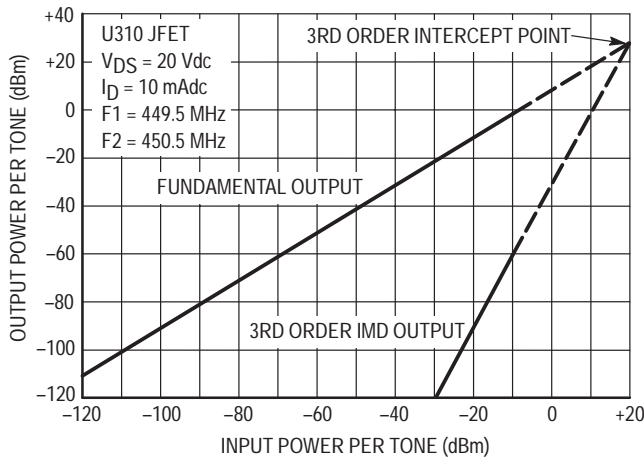
Figure 11. Noise Figure and Power Gain versus Frequency



BW (3 dB) – 36.5 MHz
 I_D – 10 mAdc
 V_{DS} – 20 Vdc
 Device case grounded
 IM test tones – $f_1 = 449.5$ MHz, $f_2 = 450.5$ MHz
 $C_1 = 1\text{--}10$ pF Johanson Air variable trimmer.
 $C_2, C_5 = 100$ pF feed thru button capacitor.
 $C_3, C_4, C_6 = 0.5\text{--}6$ pF Johanson Air variable trimmer.
 $L_1 = 1/8'' \times 1/32'' \times 1\text{--}5/8''$ copper bar.
 $L_2, L_4 =$ Ferroxcube Vk200 choke.
 $L_3 = 1/8'' \times 1/32'' \times 1\text{--}7/8''$ copper bar.

Figure 12. 450 MHz IMD Evaluation Amplifier

Amplifier power gain and IMD products are a function of the load impedance. For the amplifier design shown above with C_4 and C_6 adjusted to reflect a load to the drain resulting in a nominal power gain of 9 dB, the 3rd order intercept point (IP) value is 29 dBm. Adjusting C_4, C_6 to provide larger load values will result in higher gain, smaller bandwidth and lower IP values. For example, a nominal gain of 13 dB can be achieved with an intercept point of 19 dBm.

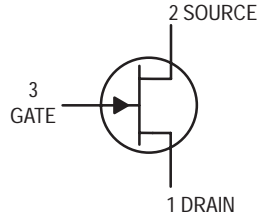


Example of intercept point plot use:
 Assume two in-band signals of -20 dBm at the amplifier input. They will result in a 3rd order IMD signal at the output of -90 dBm. Also, each signal level at the output will be -11 dBm, showing an amplifier gain of 9.0 dB and an intermodulation ratio (IMR) capability of 79 dB. The gain and IMR values apply only for signal levels below comparison.

Figure 13. Two Tone 3rd Order Intercept Point

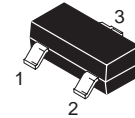
JFET Transistor

N-Channel



MMBFU310LT1

Motorola Preferred Device



CASE 318-08, STYLE 10
SOT-23 (TO-236AB)

MAXIMUM RATINGS

Rating	Symbol	Value	Unit
Drain-Source Voltage	V_{DS}	25	Vdc
Gate-Source Voltage	V_{GS}	25	Vdc
Gate Current	I_G	10	mAdc

THERMAL CHARACTERISTICS

Characteristic	Symbol	Max	Unit
Total Device Dissipation FR-5 Board ⁽¹⁾ $T_A = 25^\circ\text{C}$ Derate above 25°C	P_D	225	mW
		1.8	mW/ $^\circ\text{C}$
Thermal Resistance, Junction to Ambient	$R_{\theta JA}$	556	$^\circ\text{C}/\text{W}$
Junction and Storage Temperature	T_J, T_{stg}	-55 to +150	$^\circ\text{C}$

DEVICE MARKING

MMBFU310LT1 = 6C

ELECTRICAL CHARACTERISTICS ($T_A = 25^\circ\text{C}$ unless otherwise noted)

Characteristic	Symbol	Min	Max	Unit
----------------	--------	-----	-----	------

OFF CHARACTERISTICS

Gate-Source Breakdown Voltage ($I_G = -1.0 \mu\text{Adc}$, $V_{DS} = 0$)	$V_{(BR)GSS}$	-25	—	Vdc
Gate 1 Leakage Current ($V_{GS} = -15 \text{Vdc}$, $V_{DS} = 0$)	I_{G1SS}	—	-150	pA
Gate 2 Leakage Current ($V_{GS} = -15 \text{Vdc}$, $V_{DS} = 0$, $T_A = 125^\circ\text{C}$)	I_{G2SS}	—	-150	nAdc
Gate Source Cutoff Voltage ($V_{DS} = 10 \text{Vdc}$, $I_D = 1.0 \text{nAdc}$)	$V_{GS(off)}$	-2.5	-6.0	Vdc

ON CHARACTERISTICS

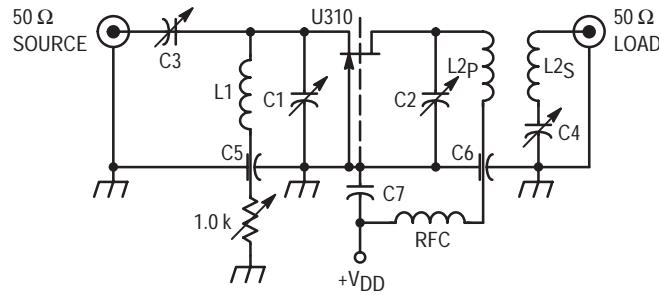
Zero-Gate-Voltage Drain Current ($V_{DS} = 10 \text{Vdc}$, $V_{GS} = 0$)	I_{DSS}	24	60	mAdc
Gate-Source Forward Voltage ($I_G = 10 \text{mAdc}$, $V_{DS} = 0$)	$V_{GS(f)}$	—	1.0	Vdc

SMALL-SIGNAL CHARACTERISTICS

Forward Transfer Admittance ($V_{DS} = 10 \text{Vdc}$, $I_D = 10 \text{mAdc}$, $f = 1.0 \text{kHz}$)	$ Y_{fs} $	10	18	mmhos
Output Admittance ($V_{DS} = 10 \text{Vdc}$, $I_D = 10 \text{mAdc}$, $f = 1.0 \text{kHz}$)	$ y_{os} $	—	250	μmos
Input Capacitance ($V_{GS} = -10 \text{Vdc}$, $V_{DS} = 0 \text{Vdc}$, $f = 1.0 \text{MHz}$)	C_{iss}	—	5.0	pF
Reverse Transfer Capacitance ($V_{GS} = -10 \text{Vdc}$, $V_{DS} = 0 \text{Vdc}$, $f = 1.0 \text{MHz}$)	C_{rss}	—	2.5	pF

1. FR-5 = $1.0 \times 0.75 \times 0.062 \text{ in.}$

Preferred devices are Motorola recommended choices for future use and best overall value.



- C1 = C2 = 0.8 – 10 pF, JFD #MVM010W.
- C3 = C4 = 8.35 pF Erie #539-002D.
- C5 = C6 = 5000 pF Erie (2443-000).
- C7 = 1000 pF, Allen Bradley #FA5C.
- RFC = 0.33 μH Miller #9230-30.
- L1 = One Turn #16 Cu, 1/4" I.D. (Air Core).
- L2p = One Turn #16 Cu, 1/4" I.D. (Air Core).
- L2s = One Turn #16 Cu, 1/4" I.D. (Air Core).

Figure 1. 450 MHz Common-Gate Amplifier Test Circuit

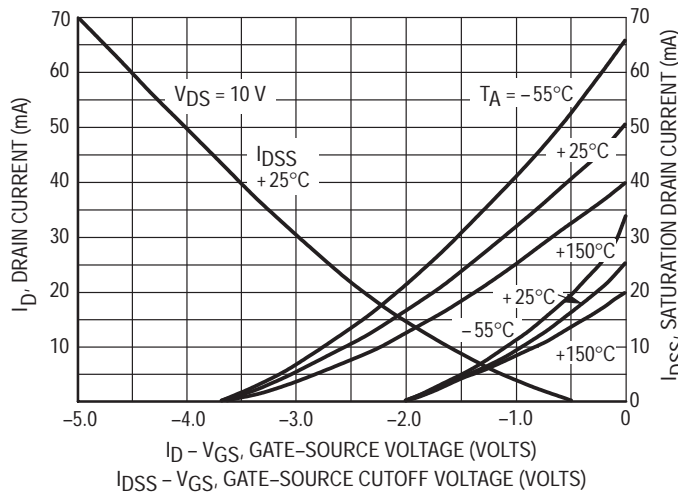


Figure 2. Drain Current and Transfer Characteristics versus Gate-Source Voltage

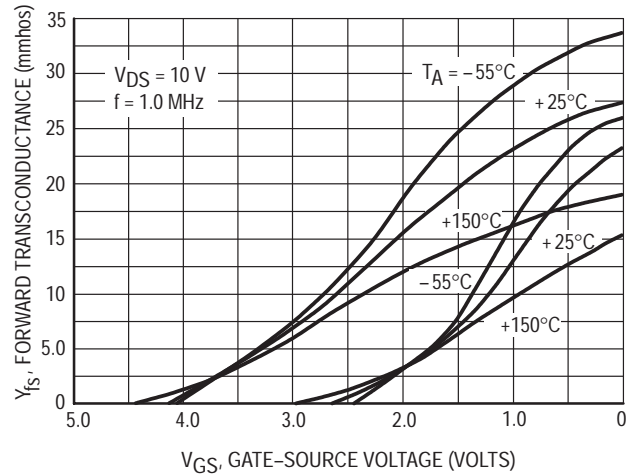


Figure 3. Forward Transconductance versus Gate-Source Voltage

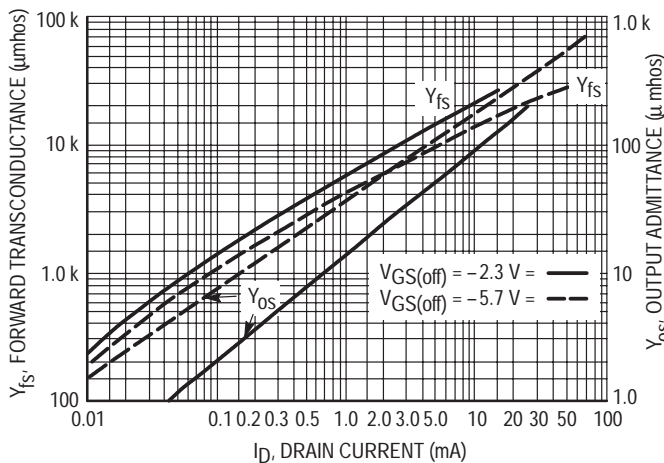


Figure 4. Common-Source Output Admittance and Forward Transconductance versus Drain Current

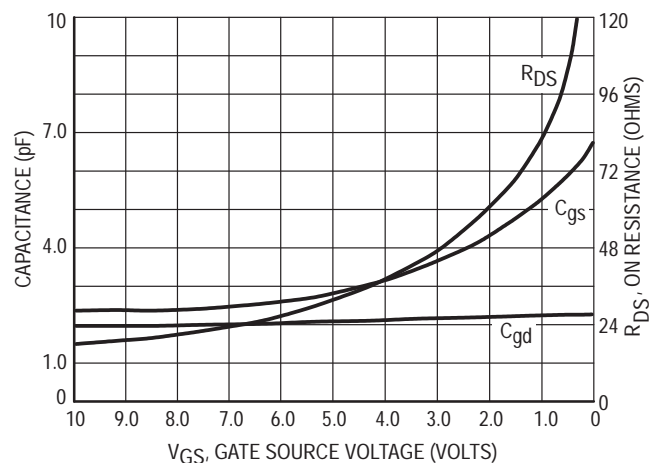


Figure 5. On Resistance and Junction Capacitance versus Gate-Source Voltage

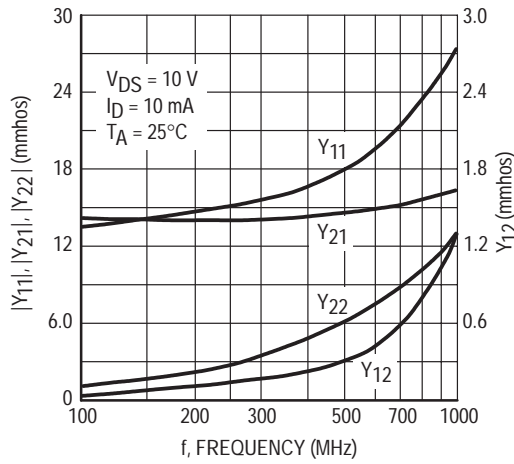


Figure 6. Common-Gate Y Parameter Magnitude versus Frequency

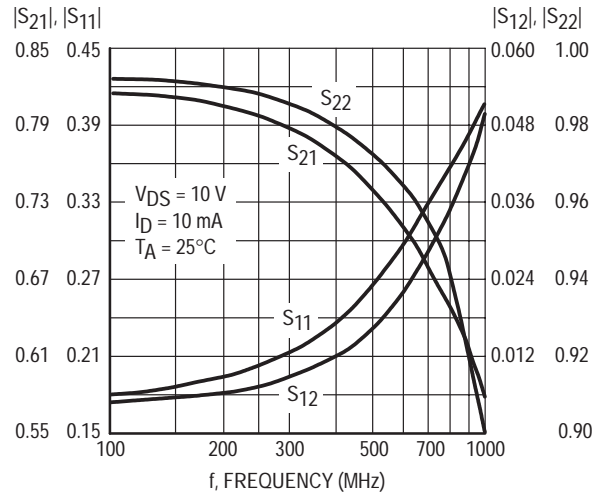


Figure 7. Common-Gate S Parameter Magnitude versus Frequency

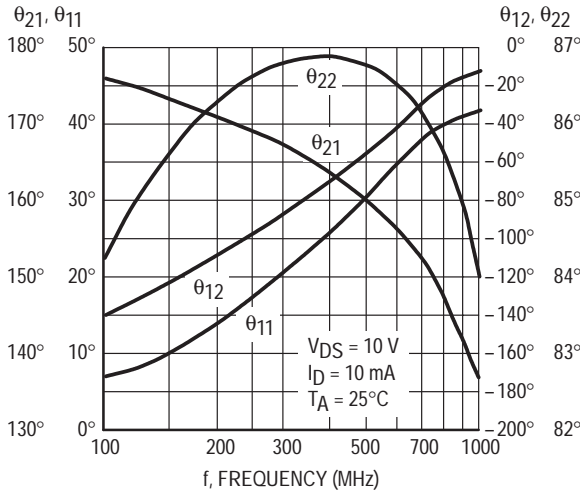


Figure 8. Common-Gate Y Parameter Phase-Angle versus Frequency

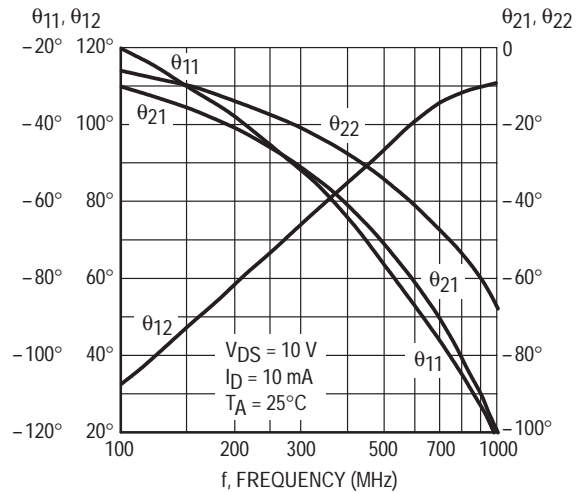


Figure 9. S Parameter Phase-Angle versus Frequency

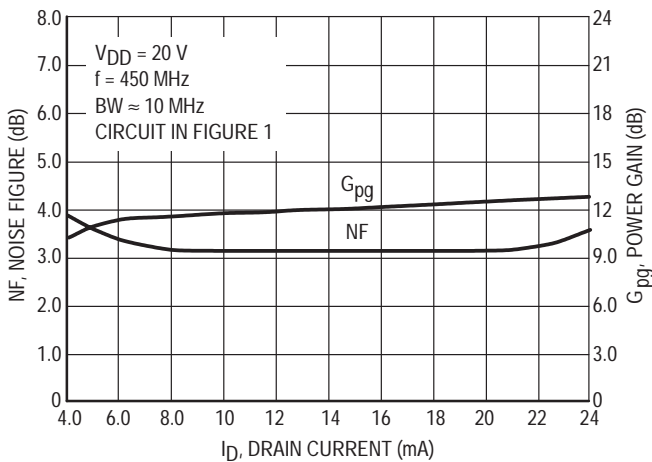


Figure 10. Noise Figure and Power Gain versus Drain Current

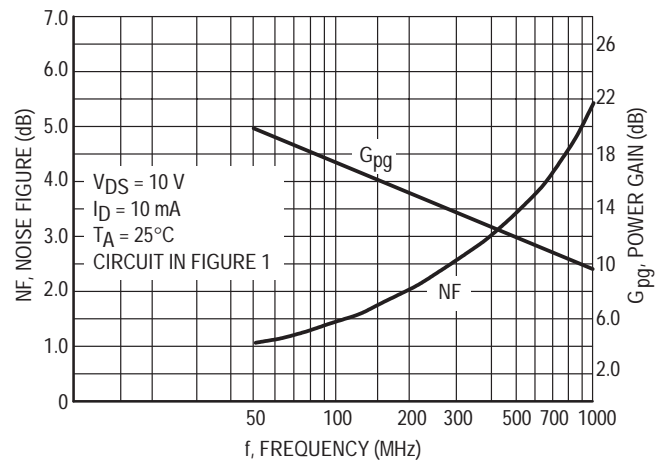
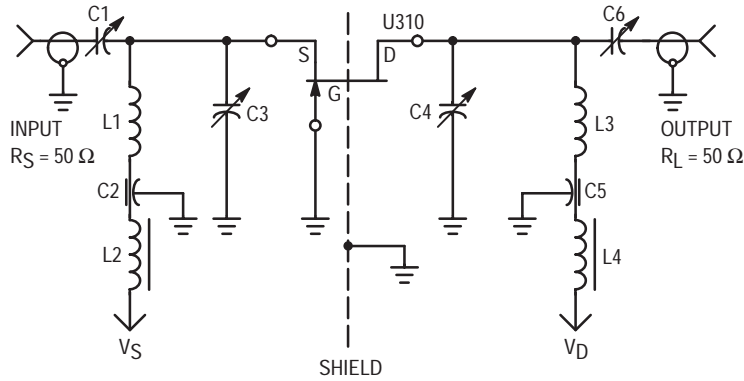


Figure 11. Noise Figure and Power Gain versus Frequency



BW (3 dB) – 36.5 MHz
 I_D – 10 mAdc
 V_{DS} – 20 Vdc
 Device case grounded
 IM test tones – $f_1 = 449.5$ MHz, $f_2 = 450.5$ MHz

$C_1 = 1$ –10 pF Johanson Air variable trimmer.
 $C_2, C_5 = 100$ pF feed thru button capacitor.
 $C_3, C_4, C_6 = 0.5$ –6 pF Johanson Air variable trimmer.

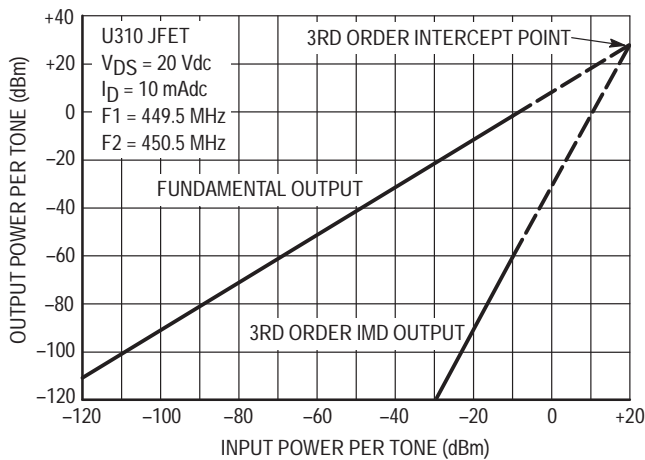
$L_1 = 1/8'' \times 1/32'' \times 1$ – $5/8''$ copper bar.

$L_2, L_4 =$ Ferroxcube Vk200 choke.

$L_3 = 1/8'' \times 1/32'' \times 1$ – $7/8''$ copper bar.

Figure 12. 450 MHz IMD Evaluation Amplifier

Amplifier power gain and IMD products are a function of the load impedance. For the amplifier design shown above with C_4 and C_6 adjusted to reflect a load to the drain resulting in a nominal power gain of 9 dB, the 3rd order intercept point (IP) value is 29 dBm. Adjusting C_4, C_6 to provide larger load values will result in higher gain, smaller bandwidth and lower IP values. For example, a nominal gain of 13 dB can be achieved with an intercept point of 19 dBm.



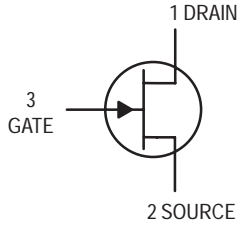
Example of intercept point plot use:

Assume two in-band signals of -20 dBm at the amplifier input. They will result in a 3rd order IMD signal at the output of -90 dBm. Also, each signal level at the output will be -11 dBm, showing an amplifier gain of 9.0 dB and an intermodulation ratio (IMR) capability of 79 dB. The gain and IMR values apply only for signal levels below comparison.

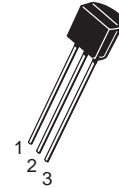
Figure 13. Two Tone 3rd Order Intercept Point

JFET VHF Amplifier

N-Channel — Depletion



MPF102



CASE 29-04, STYLE 5
TO-92 (TO-226AA)

MAXIMUM RATINGS

Rating	Symbol	Value	Unit
Drain-Source Voltage	V_{DS}	25	Vdc
Drain-Gate Voltage	V_{DG}	25	Vdc
Gate-Source Voltage	V_{GS}	-25	Vdc
Gate Current	I_G	10	mAdc
Total Device Dissipation @ $T_A = 25^\circ\text{C}$ Derate above 25°C	P_D	350 2.8	mW mW/°C
Junction Temperature Range	T_J	125	°C
Storage Temperature Range	T_{stg}	-65 to +150	°C

ELECTRICAL CHARACTERISTICS ($T_A = 25^\circ\text{C}$ unless otherwise noted)

Characteristic	Symbol	Min	Max	Unit
----------------	--------	-----	-----	------

OFF CHARACTERISTICS

Gate-Source Breakdown Voltage ($I_G = -10 \mu\text{Adc}$, $V_{DS} = 0$)	$V_{(BR)GSS}$	-25	—	Vdc
Gate Reverse Current ($V_{GS} = -15 \text{ Vdc}$, $V_{DS} = 0$) ($V_{GS} = -15 \text{ Vdc}$, $V_{DS} = 0$, $T_A = 100^\circ\text{C}$)	I_{GSS}	—	-2.0 -2.0	nAdc μAdc
Gate-Source Cutoff Voltage ($V_{DS} = 15 \text{ Vdc}$, $I_D = 2.0 \text{ nAdc}$)	$V_{GS(off)}$	—	-8.0	Vdc
Gate-Source Voltage ($V_{DS} = 15 \text{ Vdc}$, $I_D = 0.2 \text{ mAdc}$)	V_{GS}	-0.5	-7.5	Vdc

ON CHARACTERISTICS

Zero-Gate-Voltage Drain Current ⁽¹⁾ ($V_{DS} = 15 \text{ Vdc}$, $V_{GS} = 0 \text{ Vdc}$)	I_{DSS}	2.0	20	mAdc
------------------------------------------------------------------------------------------------------------	-----------	-----	----	------

SMALL-SIGNAL CHARACTERISTICS

Forward Transfer Admittance ⁽¹⁾ ($V_{DS} = 15 \text{ Vdc}$, $V_{GS} = 0$, $f = 1.0 \text{ kHz}$) ($V_{DS} = 15 \text{ Vdc}$, $V_{GS} = 0$, $f = 100 \text{ MHz}$)	$ y_{fs} $	2000 1600	7500 —	μhos
Input Admittance ($V_{DS} = 15 \text{ Vdc}$, $V_{GS} = 0$, $f = 100 \text{ MHz}$)	$\text{Re}(y_{is})$	—	800	μhos
Output Conductance ($V_{DS} = 15 \text{ Vdc}$, $V_{GS} = 0$, $f = 100 \text{ MHz}$)	$\text{Re}(y_{os})$	—	200	μhos
Input Capacitance ($V_{DS} = 15 \text{ Vdc}$, $V_{GS} = 0$, $f = 1.0 \text{ MHz}$)	C_{iss}	—	7.0	pF
Reverse Transfer Capacitance ($V_{DS} = 15 \text{ Vdc}$, $V_{GS} = 0$, $f = 1.0 \text{ MHz}$)	C_{rss}	—	3.0	pF

1. Pulse Test; Pulse Width $\leq 630 \text{ ms}$, Duty Cycle $\leq 10\%$.

POWER GAIN

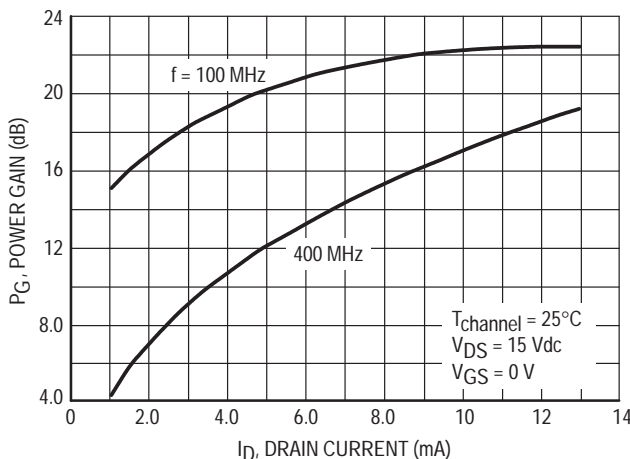
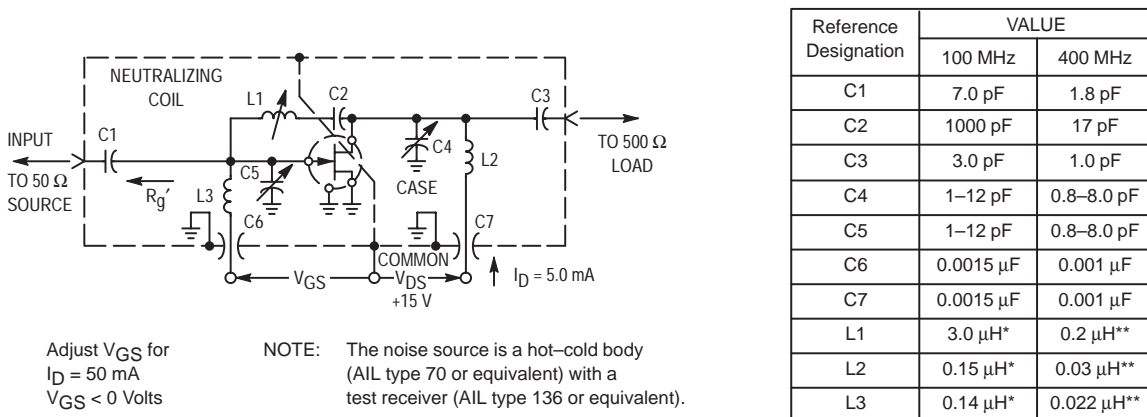


Figure 1. Effects of Drain Current



- *L1 17 turns, (approx. — depends upon circuit layout) AWG #28 enameled copper wire, close wound on 9/32" ceramic coil form. Tuning provided by a powdered iron slug.
- L2 4–1/2 turns, AWG #18 enameled copper wire, 5/16" long, 3/8" I.D. (AIR CORE).
- L3 3–1/2 turns, AWG #18 enameled copper wire, 1/4" long, 3/8" I.D. (AIR CORE).

- **L1 6 turns, (approx. — depends upon circuit layout) AWG #24 enameled copper wire, close wound on 7/32" ceramic coil form. Tuning provided by an aluminum slug.
- L2 1 turn, AWG #16 enameled copper wire, 3/8" I.D. (AIR CORE).
- L3 1/2 turn, AWG #16 enameled copper wire, 1/4" I.D. (AIR CORE).

Figure 2. 100 MHz and 400 MHz Neutralized Test Circuit

NOISE FIGURE

($T_{channel} = 25^{\circ}C$)

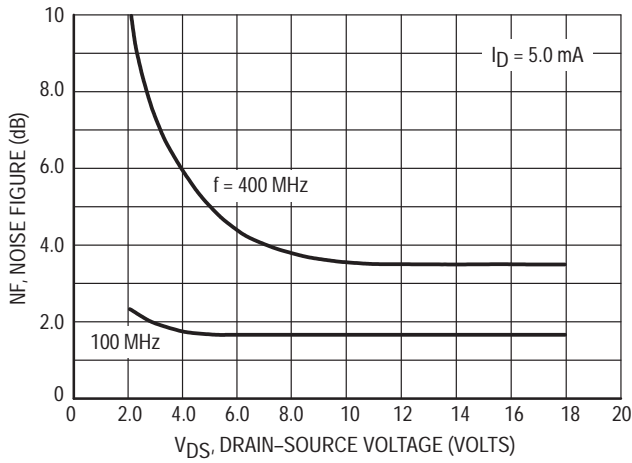


Figure 3. Effects of Drain-Source Voltage

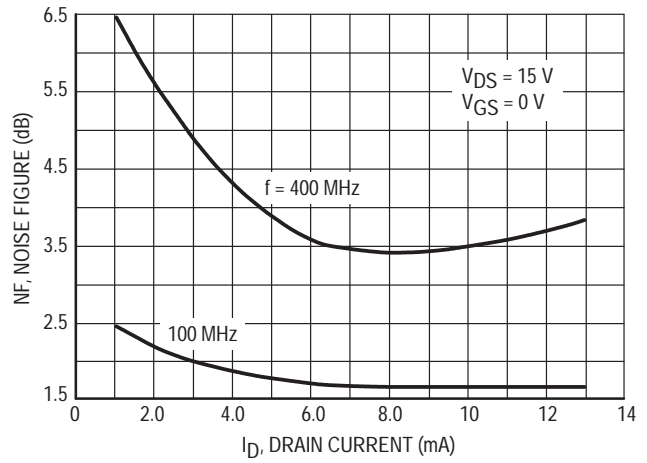


Figure 4. Effects of Drain Current

INTERMODULATION CHARACTERISTICS

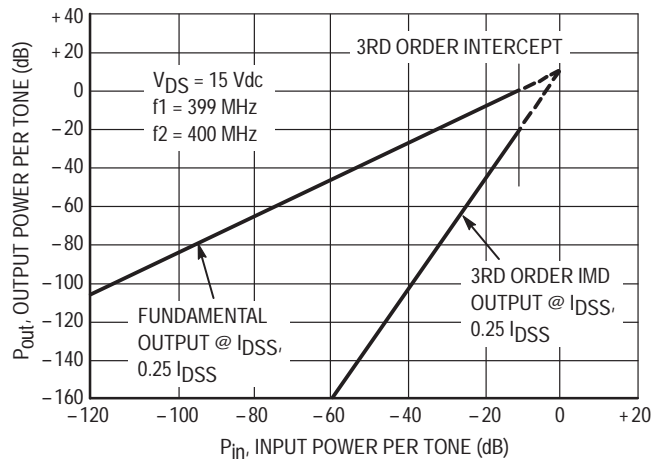


Figure 5. Third Order Intermodulation Distortion

COMMON SOURCE CHARACTERISTICS

ADMITTANCE PARAMETERS

($V_{DS} = 15 \text{ Vdc}$, $T_{channel} = 25^\circ\text{C}$)

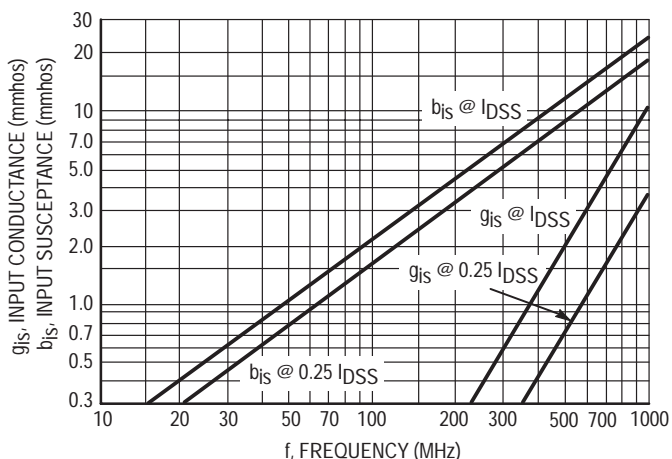


Figure 6. Input Admittance (y_{is})

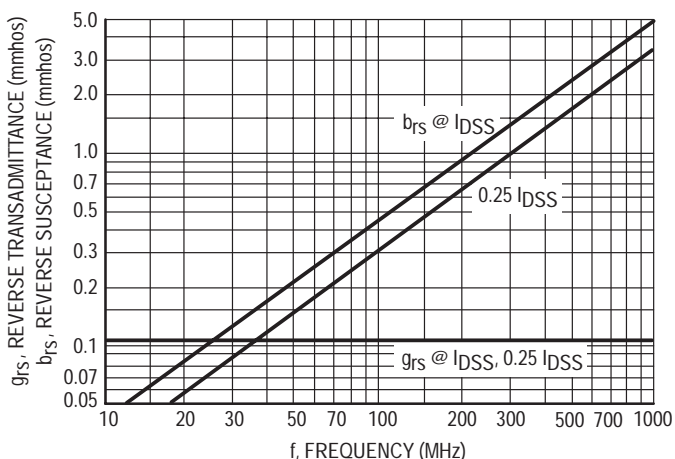


Figure 7. Reverse Transfer Admittance (y_{rs})

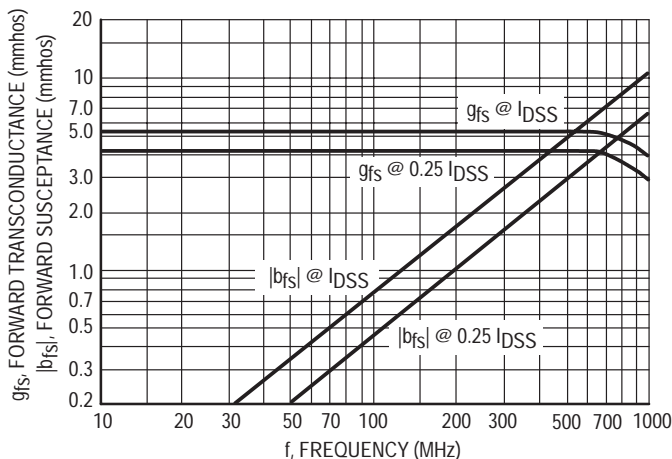


Figure 8. Forward Transadmittance (y_{fs})

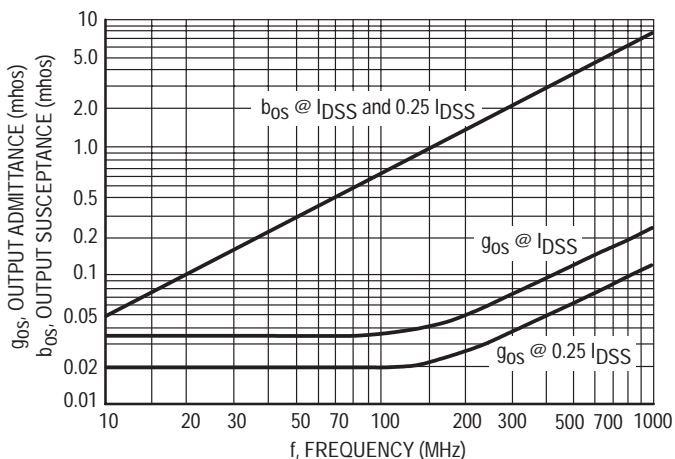


Figure 9. Output Admittance (y_{os})

COMMON SOURCE CHARACTERISTICS
S-PARAMETERS
 ($V_{DS} = 15 \text{ Vdc}$, $T_{\text{channel}} = 25^\circ\text{C}$, Data Points in MHz)

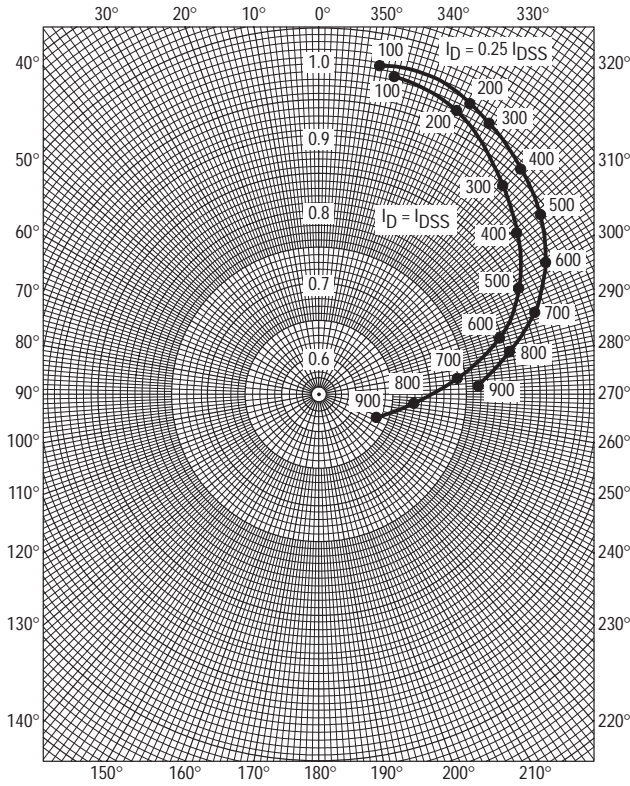


Figure 10. S_{11s}

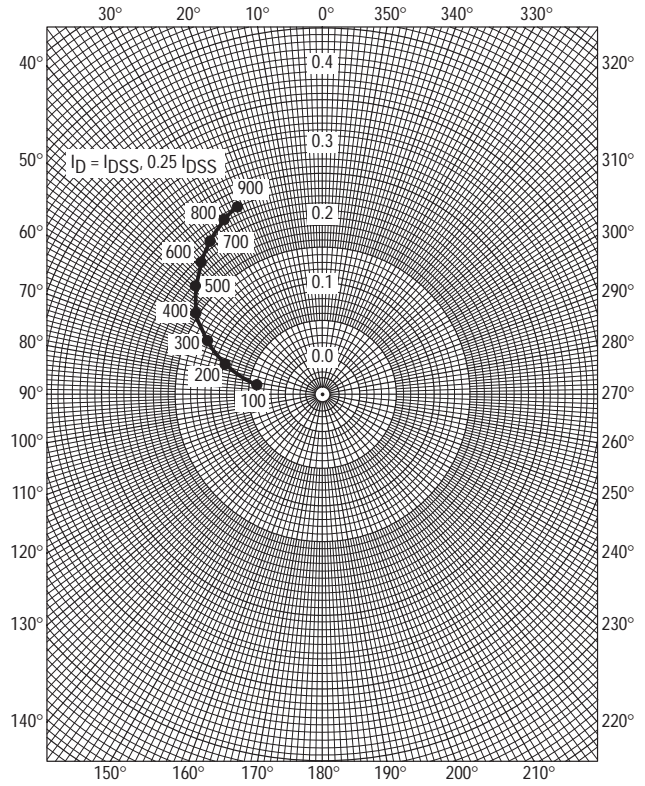


Figure 11. S_{12s}

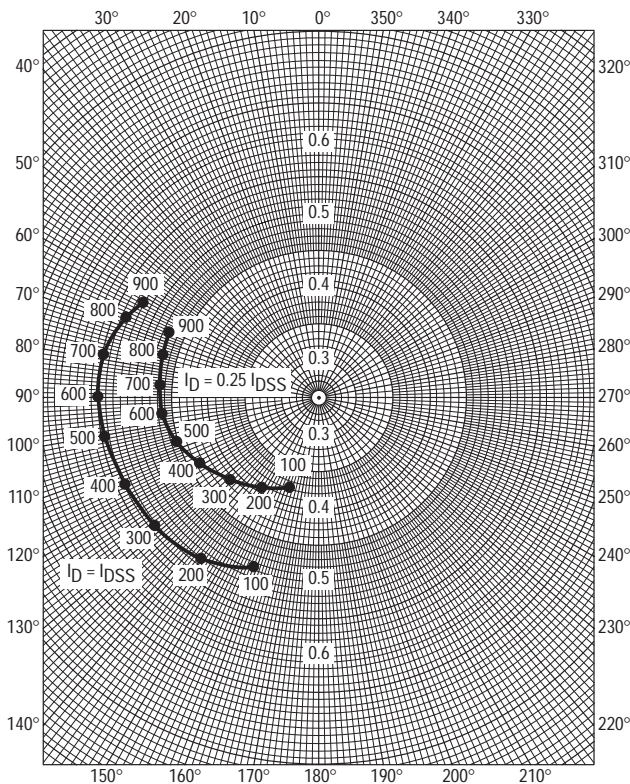


Figure 12. S_{21s}

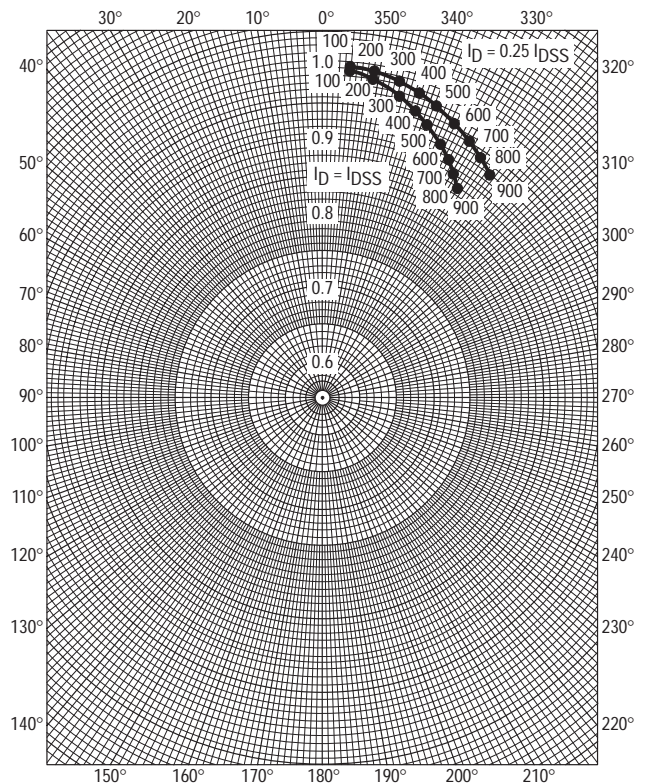


Figure 13. S_{22s}

COMMON GATE CHARACTERISTICS

ADMITTANCE PARAMETERS

($V_{DG} = 15 \text{ Vdc}$, $T_{channel} = 25^\circ\text{C}$)

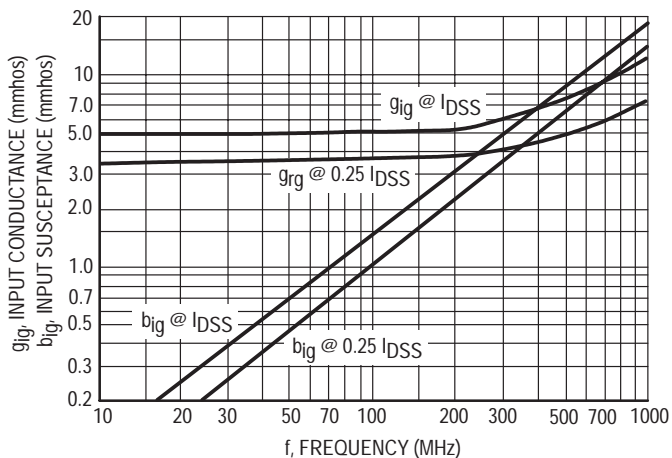


Figure 14. Input Admittance (y_{ig})

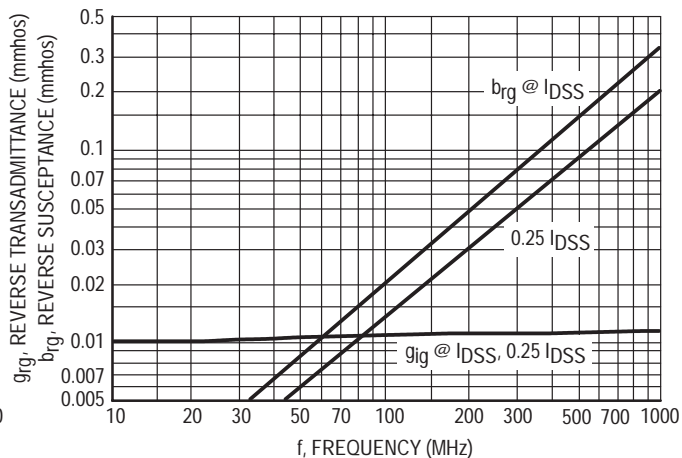


Figure 15. Reverse Transfer Admittance (y_{rg})

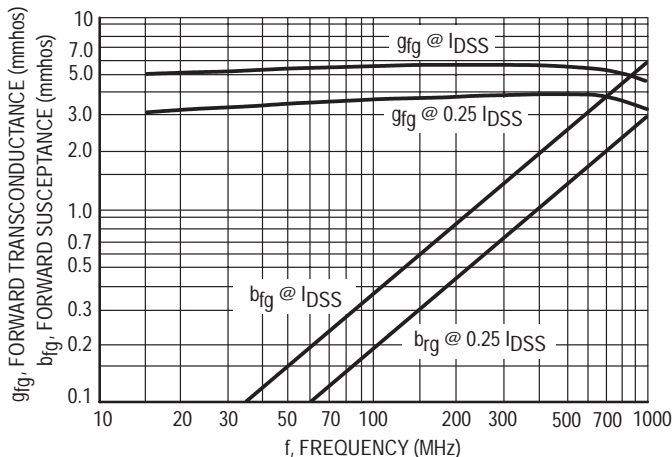


Figure 16. Forward Transfer Admittance (y_{fg})

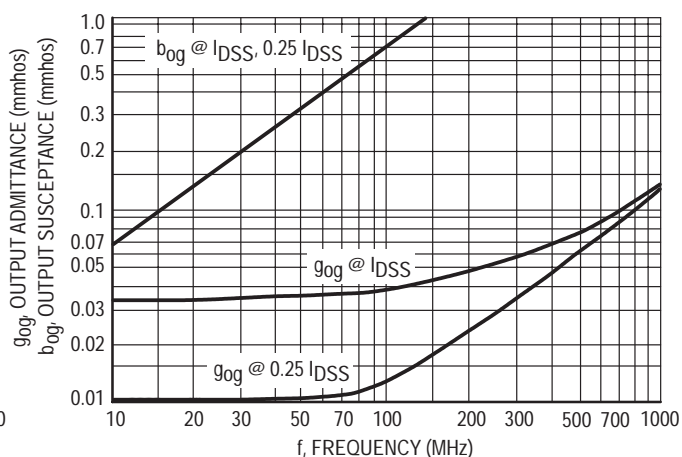


Figure 17. Output Admittance (y_{og})

COMMON GATE CHARACTERISTICS
S-PARAMETERS

($V_{DS} = 15 \text{ Vdc}$, $T_{channel} = 25^\circ\text{C}$, Data Points in MHz)

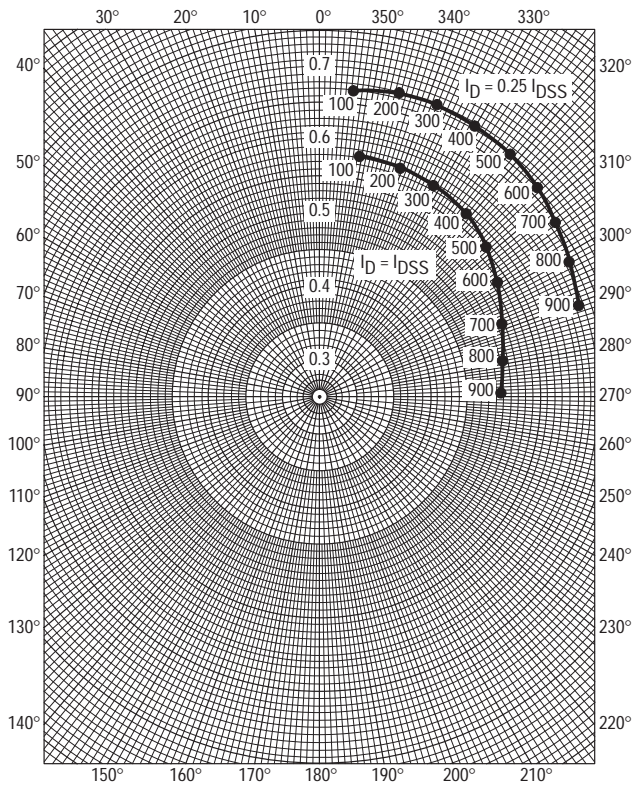


Figure 18. S_{11g}

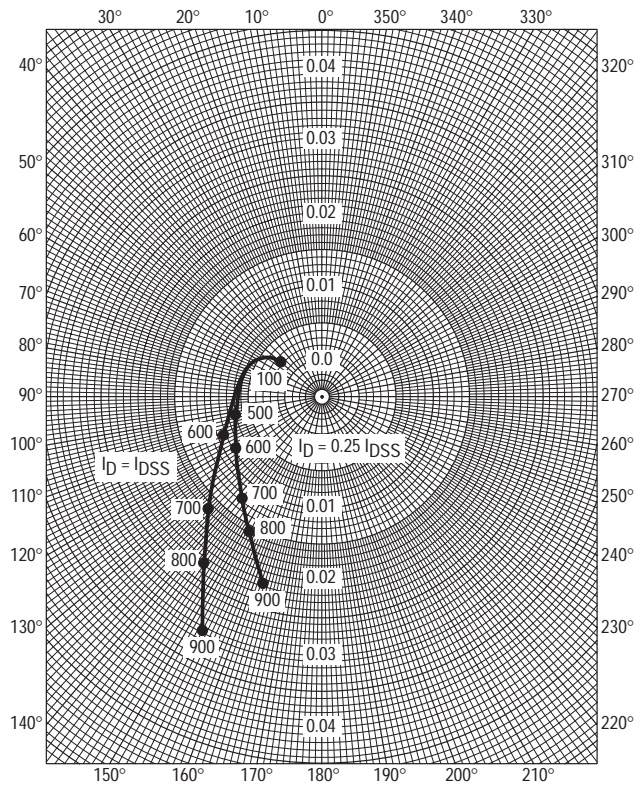


Figure 19. S_{12g}

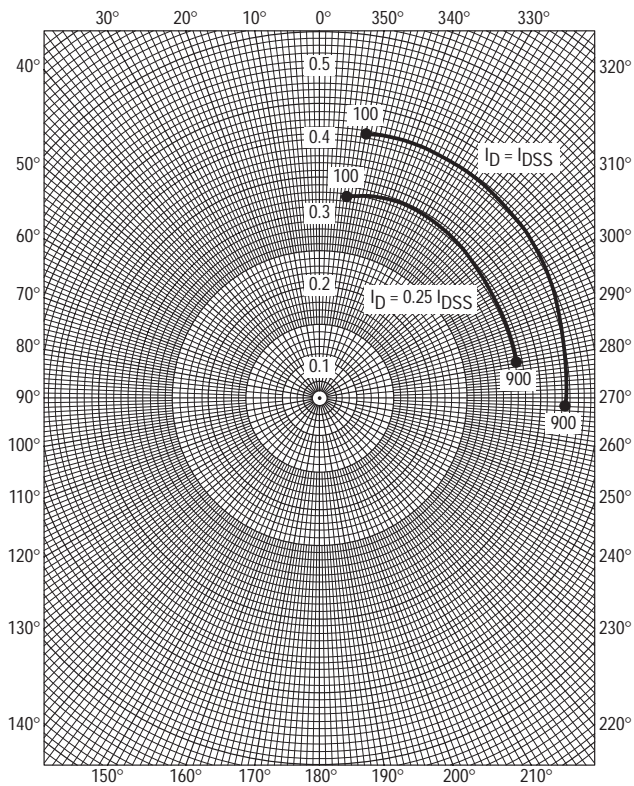


Figure 20. S_{21g}

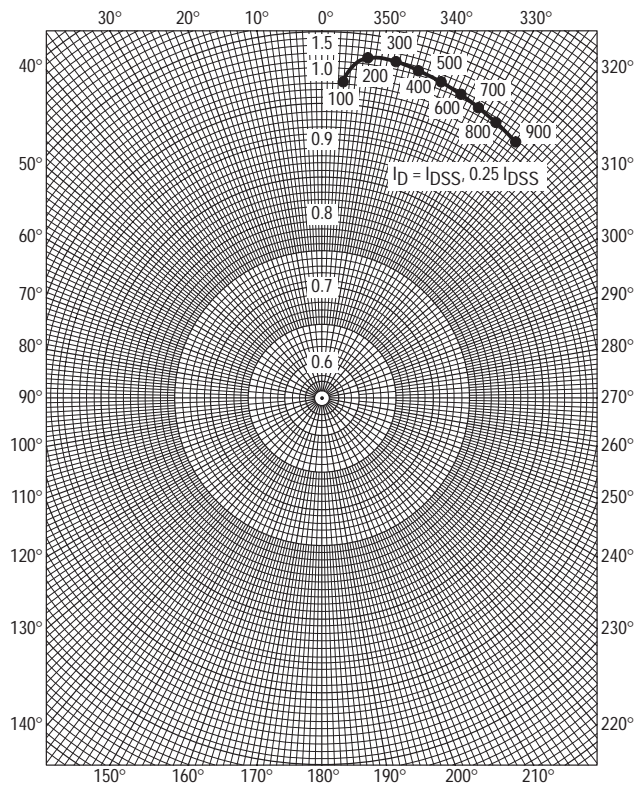
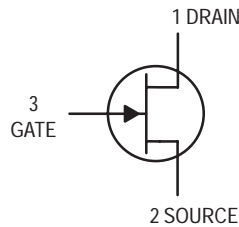


Figure 21. S_{22g}

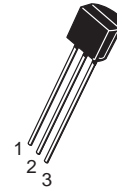
JFETs Switching

N-Channel — Depletion



MPF4392
MPF4393

Motorola Preferred Devices



CASE 29-04, STYLE 5
TO-92 (TO-226AA)

MAXIMUM RATINGS

Rating	Symbol	Value	Unit
Drain-Source Voltage	V_{DS}	30	Vdc
Drain-Gate Voltage	V_{DG}	30	Vdc
Gate-Source Voltage	V_{GS}	30	Vdc
Forward Gate Current	$I_{G(f)}$	50	mAdc
Total Device Dissipation @ $T_A = 25^\circ\text{C}$ Derate above 25°C	P_D	350 2.8	mW mW/ $^\circ\text{C}$
Operating and Storage Channel Temperature Range	T_{channel} , T_{stg}	-65 to +150	$^\circ\text{C}$

ELECTRICAL CHARACTERISTICS ($T_A = 25^\circ\text{C}$ unless otherwise noted)

Characteristic	Symbol	Min	Typ	Max	Unit
----------------	--------	-----	-----	-----	------

OFF CHARACTERISTICS

Gate-Source Breakdown Voltage ($I_G = 1.0 \mu\text{Adc}$, $V_{DS} = 0$)	$V_{(BR)GSS}$	30	—	—	Vdc
Gate Reverse Current ($V_{GS} = 15 \text{ Vdc}$, $V_{DS} = 0$) ($V_{GS} = 15 \text{ Vdc}$, $V_{DS} = 0$, $T_A = 100^\circ\text{C}$)	I_{GSS}	— —	— —	1.0 0.2	nAdc μAdc
Drain-Cutoff Current ($V_{DS} = 15 \text{ Vdc}$, $V_{GS} = 12 \text{ Vdc}$) ($V_{DS} = 15 \text{ Vdc}$, $V_{GS} = 12 \text{ Vdc}$, $T_A = 100^\circ\text{C}$)	$I_{D(off)}$	— —	— —	1.0 0.1	nAdc μAdc
Gate-Source Voltage ($V_{DS} = 15 \text{ Vdc}$, $I_D = 10 \text{ nAdc}$)	V_{GS}	-2.0 -0.5	— —	-5.0 -3.0	Vdc

ON CHARACTERISTICS

Zero-Gate-Voltage Drain Current ⁽¹⁾ ($V_{DS} = 15 \text{ Vdc}$, $V_{GS} = 0$)	I_{DSS}	MPF4392 MPF4393	25 5.0	— —	75 30	mAdc
Drain-Source On-Voltage ($I_D = 6.0 \text{ mAdc}$, $V_{GS} = 0$) ($I_D = 3.0 \text{ mAdc}$, $V_{GS} = 0$)	$V_{DS(on)}$	MPF4392 MPF4393	— —	— —	0.4 0.4	Vdc
Static Drain-Source On Resistance ($I_D = 1.0 \text{ mAdc}$, $V_{GS} = 0$)	$r_{DS(on)}$	MPF4392 MPF4393	— —	— —	60 100	Ω

SMALL-SIGNAL CHARACTERISTICS

Forward Transfer Admittance ($V_{DS} = 15 \text{ Vdc}$, $I_D = 25 \text{ mAdc}$, $f = 1.0 \text{ kHz}$) ($V_{DS} = 15 \text{ Vdc}$, $I_D = 5.0 \text{ mAdc}$, $f = 1.0 \text{ kHz}$)	$ y_{fs} $	MPF4392 MPF4393	— —	17 12	— —	mmhos
----------------------------------------------------------------------------------------------------------------------------------------------------------------------------------------------------	------------	--------------------	--------	----------	--------	-------

1. Pulse Test: Pulse Width $\leq 300 \mu\text{s}$, Duty Cycle $\leq 3.0\%$.

Preferred devices are Motorola recommended choices for future use and best overall value.

MPF4392 MPF4393

ELECTRICAL CHARACTERISTICS (T_A = 25°C unless otherwise noted) (Continued)

Characteristic	Symbol	Min	Typ	Max	Unit
SMALL-SIGNAL CHARACTERISTICS (continued)					
Drain-Source "ON" Resistance (V _{GS} = 0, I _D = 0, f = 1.0 kHz)	r _{ds(on)}	—	—	60	Ω
	MPF4392	—	—	100	
	MPF4393	—	—	—	
Input Capacitance (V _{GS} = 15 Vdc, V _{DS} = 0, f = 1.0 MHz)	C _{iss}	—	6.0	10	pF
Reverse Transfer Capacitance (V _{GS} = 12 Vdc, V _{DS} = 0, f = 1.0 MHz) (V _{DS} = 15 Vdc, I _D = 10 mAdc, f = 1.0 MHz)	C _{rss}	—	2.5	3.5	pF
		—	3.2	—	

SWITCHING CHARACTERISTICS

Rise Time (See Figure 2) (I _{D(on)} = 6.0 mAdc) (I _{D(on)} = 3.0 mAdc)	t _r	—	2.0	5.0	ns
	MPF4392	—	2.5	5.0	
	MPF4393	—	—	—	
Fall Time (See Figure 4) (V _{GS(off)} = 7.0 Vdc) (V _{GS(off)} = 5.0 Vdc)	t _f	—	15	20	ns
	MPF4392	—	29	35	
	MPF4393	—	—	—	
Turn-On Time (See Figures 1 and 2) (I _{D(on)} = 6.0 mAdc) (I _{D(on)} = 3.0 mAdc)	t _{on}	—	4.0	15	ns
	MPF4392	—	6.5	15	
	MPF4393	—	—	—	
Turn-Off Time (See Figures 3 and 4) (V _{GS(off)} = 7.0 Vdc) (V _{GS(off)} = 5.0 Vdc)	t _{off}	—	20	35	ns
	MPF4392	—	37	55	
	MPF4393	—	—	—	

TYPICAL SWITCHING CHARACTERISTICS

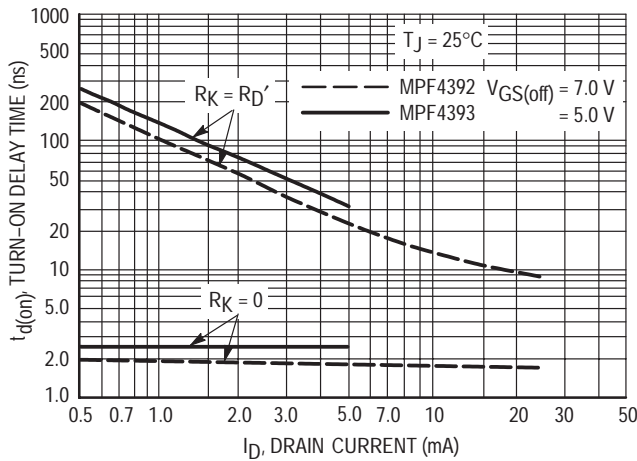


Figure 1. Turn-On Delay Time

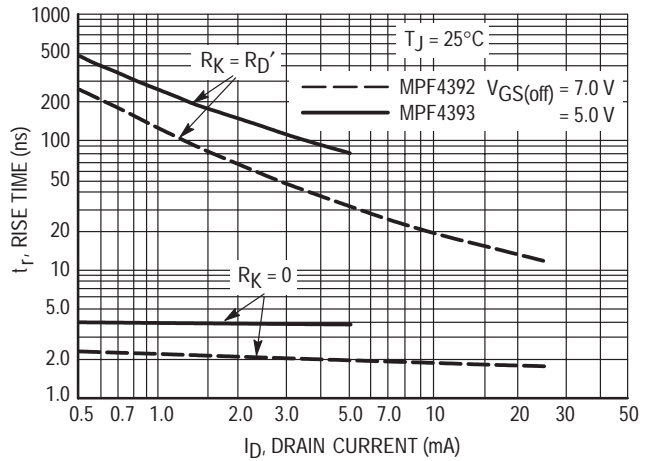


Figure 2. Rise Time

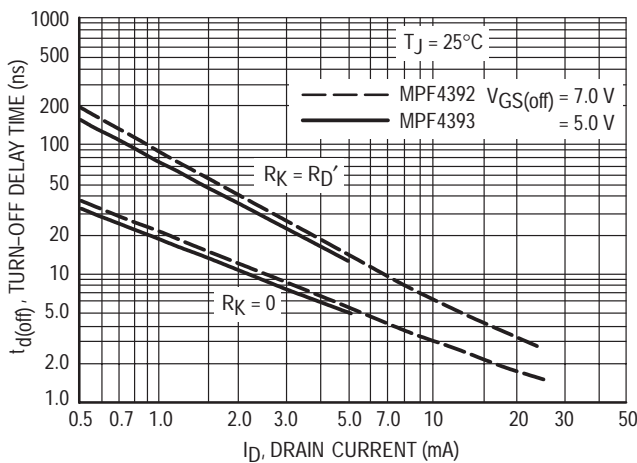


Figure 3. Turn-Off Delay Time

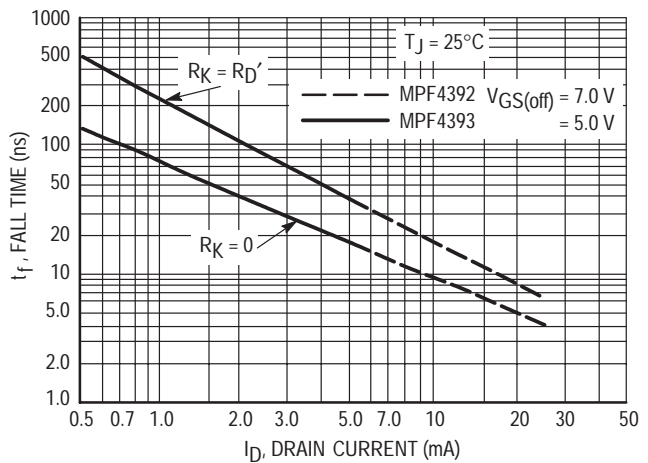


Figure 4. Fall Time

NOTE 1

The switching characteristics shown above were measured using a test circuit similar to Figure 5. At the beginning of the switching interval, the gate voltage is at Gate Supply Voltage ($-V_{GG}$). The Drain-Source Voltage (V_{DS}) is slightly lower than Drain Supply Voltage (V_{DD}) due to the voltage divider. Thus Reverse Transfer Capacitance (C_{rSS}) or Gate-Drain Capacitance (C_{gd}) is charged to $V_{GG} + V_{DS}$.

During the turn-on interval, Gate-Source Capacitance (C_{gs}) discharges through the series combination of R_{GEN} and R_K . C_{gd} must discharge to $V_{DS(on)}$ through R_G and R_K in series with the parallel combination of effective load impedance (R'_D) and Drain-Source Resistance (r_{ds}). During the turn-off, this charge flow is reversed.

Predicting turn-on time is somewhat difficult as the channel resistance r_{ds} is a function of the gate-source voltage. While C_{gs} discharges, V_{GS} approaches zero and r_{ds} decreases. Since C_{gd} discharges through r_{ds} , turn-on time is non-linear. During turn-off, the situation is reversed with r_{ds} increasing as C_{gd} charges.

The above switching curves show two impedance conditions: 1) R_K is equal to R'_D which simulates the switching behavior of cascaded stages where the driving source impedance is normally the load impedance of the previous stage, and 2) $R_K = 0$ (low impedance) the driving source impedance is that of the generator.

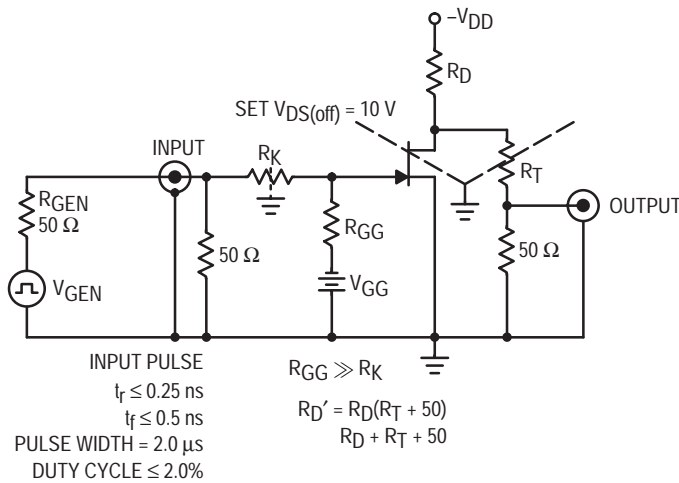


Figure 5. Switching Time Test Circuit

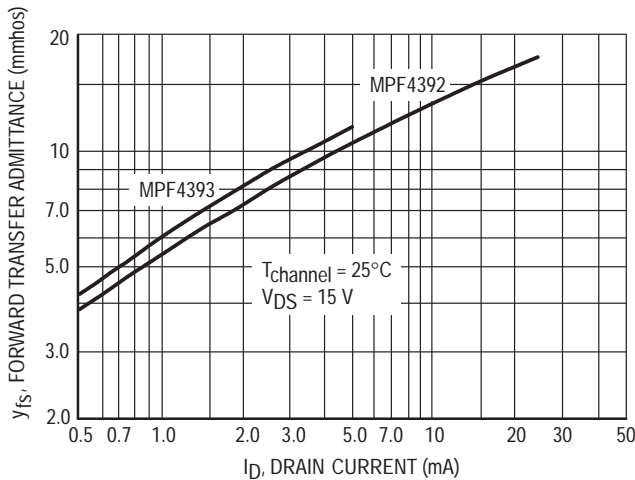


Figure 6. Typical Forward Transfer Admittance

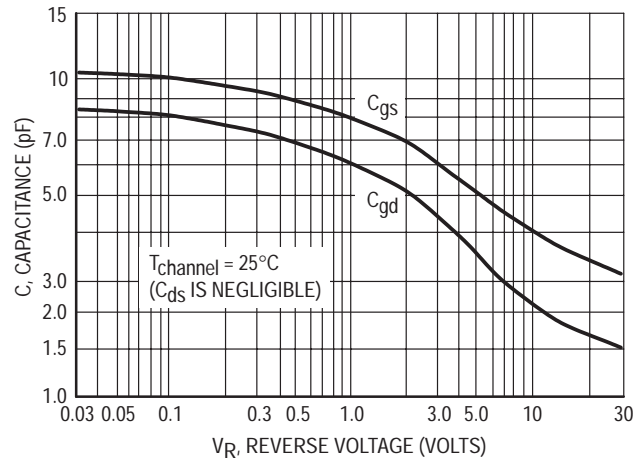


Figure 7. Typical Capacitance

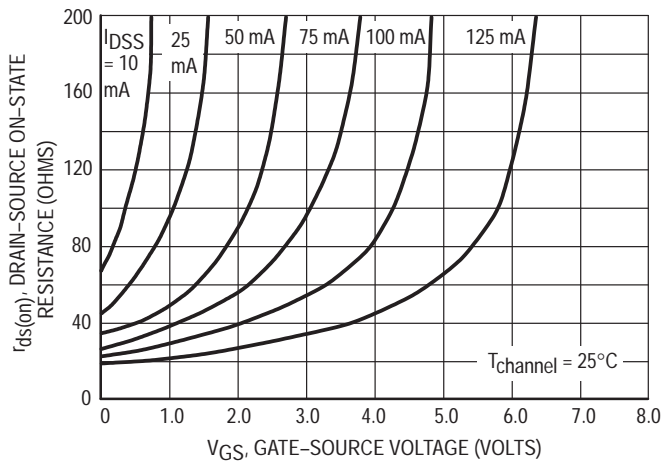


Figure 8. Effect of Gate-Source Voltage On Drain-Source Resistance

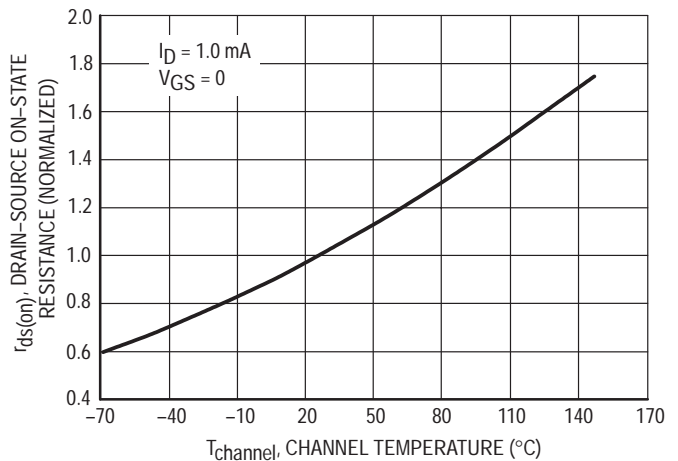


Figure 9. Effect of Temperature On Drain-Source On-State Resistance

MPF4392 MPF4393

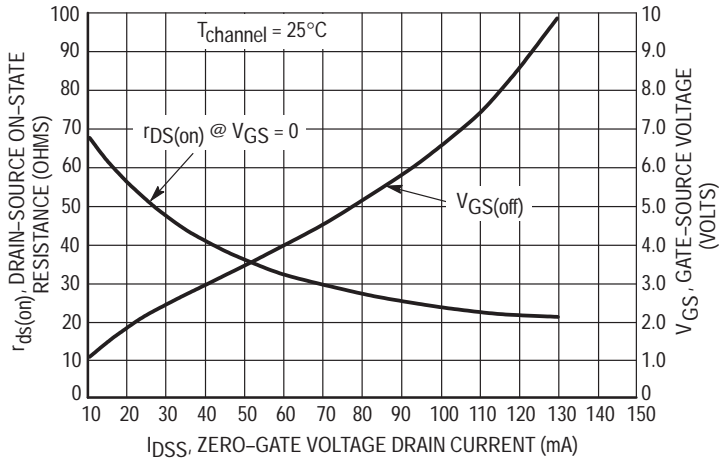


Figure 10. Effect of I_{DSS} On Drain-Source Resistance and Gate-Source Voltage

NOTE 2

The Zero-Gate-Voltage Drain Current (I_{DSS}), is the principle determinant of other J-FET characteristics. Figure 10 shows the relationship of Gate-Source Off Voltage ($V_{GS(off)}$) and Drain-Source On Resistance ($r_{ds(on)}$) to I_{DSS} . Most of the devices will be within $\pm 10\%$ of the values shown in Figure 10. This data will be useful in predicting the characteristic variations for a given part number.

For example:

Unknown

$r_{ds(on)}$ and V_{GS} range for an MPF4392

The electrical characteristics table indicates that an MPF4392 has an I_{DSS} range of 25 to 75 mA. Figure 10 shows $r_{ds(on)} = 52$ Ohms for $I_{DSS} = 25$ mA and 30 Ohms for $I_{DSS} = 75$ mA. The corresponding V_{GS} values are 2.2 volts and 4.8 volts.

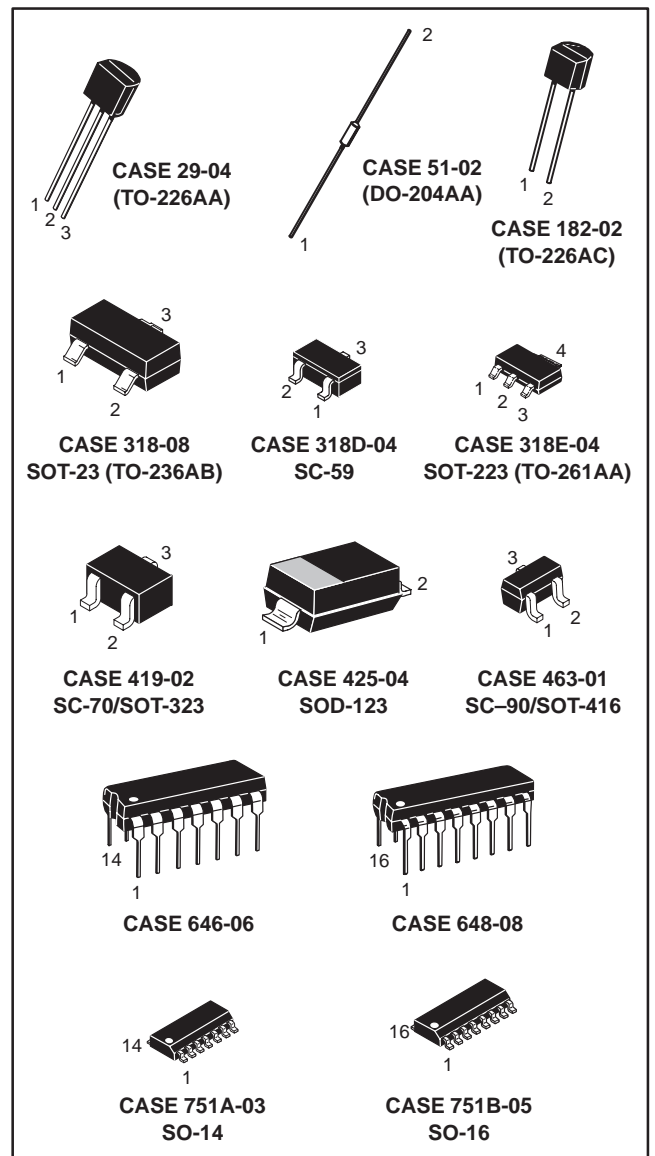
Section 5

Small-Signal Tuning and Switching Diodes

In Brief . . .

Packaging options include plastic DIPs and surface mount packages. Most SOT-23, SC-59, SC-70/SOT-323 and SOT-223 package devices are only available in Tape and Reel.

NOTE: All SOT-23 package devices have had a "T1" suffix added to the device title.



EMBOSSSED TAPE AND REEL

SOT-23, SC-59, SC-70/SOT-323, SOT-223, SO-14 and SO-16 packages are available only in Tape and Reel. Use the appropriate suffix indicated below to order any of the SOT-23, SC-59, SC-70/SOT-323, SOT-223, SO-14 and SO-16 packages. (See Section 6 on Packaging for additional information).

- SOT-23: available in 8 mm Tape and Reel
Use the device title (which already includes the "T1" suffix) to order the 7 inch/3000 unit reel.
Replace the "T1" suffix in the device title with a "T3" suffix to order the 13 inch/10,000 unit reel.
- SC-59: available in 8 mm Tape and Reel
Use the device title (which already includes the "T1" suffix) to order the 7 inch/3000 unit reel.
Replace the "T1" suffix in the device title with a "T3" suffix to order the 13 inch/10,000 unit reel.
- SC-70/
SOT-323: available in 8 mm Tape and Reel
Use the device title (which already includes the "T1" suffix) to order the 7 inch/3000 unit reel.
Replace the "T1" suffix in the device title with a "T3" suffix to order the 13 inch/10,000 unit reel.
- SOT-223: available in 12 mm Tape and Reel
Use the device title (which already includes the "T1" suffix) to order the 7 inch/1000 unit reel.
Replace the "T1" suffix in the device title with a "T3" suffix to order the 13 inch/4000 unit reel.
- SO-14: available in 16 mm Tape and Reel
Add an "R1" suffix to the device title to order the 7 inch/500 unit reel.
Add an "R2" suffix to the device title to order the 13 inch/2500 unit reel.
- SO-16: available in 16 mm Tape and Reel
Add an "R1" suffix to the device title to order the 7 inch/500 unit reel.
Add an "R2" suffix to the device title to order the 13 inch/2500 unit reel.

RADIAL TAPE IN FAN FOLD BOX OR REEL

TO-92 packages are available in both bulk shipments and in Radial Tape in Fan Fold Boxes or Reels. Fan Fold Boxes and Radial Tape Reel are the best methods for capturing devices for automatic insertion in printed circuit boards.

- TO-92: available in Fan Fold Box
Add an "RLR" suffix and the appropriate Style code* to the device title to order the Fan Fold box.
- available in 365 mm Radial Tape Reel
Add an "RLR" suffix and the appropriate Style code* to the device title to order the Radial Tape Reel.

*Refer to Section 6 on Packaging for Style code characters and additional information on ordering requirements.

DEVICE MARKINGS/DATE CODE CHARACTERS

SOT-23, SC-59 and the SC-70/SOT-323 packages have a device marking and a date code etched on the device. The generic example below depicts both the device marking and a representation of the date code that appears on the SC-70/SOT-323, SC-59 and SOT-23 packages.



The "D" represents a smaller alpha digit Date Code. The Date Code indicates the actual month in which the part was manufactured.

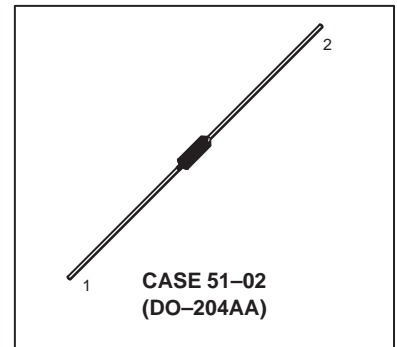
Silicon Tuning Diodes

Designed for electronic tuning and harmonic-generation applications, and provide solid-state reliability to replace mechanical tuning methods.

- Guaranteed High-Frequency Q
- Guaranteed Wide Tuning Range
- Standard 10% Capacitance Tolerance
- Complete Typical Design Curves

1N5148
1N5148A

**6.8–47 pF EPICAP
VOLTAGE-VARIABLE
CAPACITANCE DIODES**



MAXIMUM RATINGS (T_C = 25°C unless otherwise noted)

Rating	Symbol	Value	Unit
Reverse Voltage	V _R	60	Volts
Forward Current	I _F	250	mA _{dc}
RF Power Input ⁽¹⁾	P _{in}	5.0	Watts
Device Dissipation @ T _A = 25°C Derate above 25°C	P _D	400 2.67	mW mW/°C
Device Dissipation @ T _C = 25°C Derate above 25°C	P _C	2.0 13.3	Watts mW/°C
Junction Temperature	T _J	+175	°C
Storage Temperature Range	T _{stg}	-65 to +200	°C

ELECTRICAL CHARACTERISTICS (T_A = 25°C unless otherwise noted)

Characteristic	Symbol	Min	Typ	Max	Unit
Reverse Breakdown Voltage (I _R = 10 μA _{dc})	V _{(BR)R}	60	70	—	V _{dc}
Reverse Voltage Leakage Current (V _R = 55 V _{dc} , T _A = 25°C) (V _R = 55 V _{dc} , T _A = 150°C)	I _R	— —	— —	0.02 20	μA _{dc}
Series Inductance (f = 250 MHz, L ≈ 1/16")	L _S	—	4.0	—	nH
Case Capacitance (f = 1.0 MHz, L ≈ 1/16")	C _C	—	0.17	—	pF
Diode Capacitance Temperature Coefficient (V _R = 4.0 V _{dc} , f = 1.0 MHz)	TC _C	—	200	—	ppm/°C

1. The RF power input rating assumes that an adequate heatsink is provided.

Device	C _T , Diode Capacitance V _R = 4.0 V _{dc} , f = 1.0 MHz pF			Q, Figure of Merit V _R = 4.0 V _{dc} , f = 50 MHz	α V _R = 4.0 V _{dc} , f = 1.0 MHz		TR, Tuning Ratio C ₄ /C ₆₀ f = 1.0 MHz	
	Min	Typ	Max	Min	Min	Typ	Min	Typ
1N5148	42.3	47	51.7	200	0.43	0.45	3.2	3.4
1N5148A	44.7	47	49.3	200	0.43	0.45	3.2	3.4

PARAMETER TEST METHODS

1. **L_S, SERIES INDUCTANCE**

L_S is measured on a shorted package at 250 MHz using an impedance bridge (Boonton Radio Model 250A RX Meter). L = lead length.

2. **C_C, CASE CAPACITANCE**

C_C is measured on an open package at 1.0 MHz using a capacitance bridge (Boonton Electronics Model 75A or equivalent).

3. **C_T, DIODE CAPACITANCE**

(C_T = C_C + C_J). C_T is measured at 1.0 MHz using a capacitance bridge (Boonton Electronics Model 75A or equivalent).

4. **TR, TUNING RATIO**

TR is the ratio of C_T measured at 4.0 Vdc divided by C_T measured at 60 Vdc.

5. **Q, FIGURE OF MERIT**

Q is calculated by taking the G and C readings of an admittance bridge at the specified frequency and substituting in the following equations:

$$Q = \frac{2\pi f C}{G}$$

(Boonton Electronics Model 33AS8).

6. **α, DIODE CAPACITANCE REVERSE VOLTAGE SLOPE**

The diode capacitance, C_T (as measured at V_R = 4.0 Vdc, f = 1.0 MHz) is compared to C_T (as measured at V_R = 60 Vdc, f = 1.0 MHz) by the following equation which defines α.

$$\alpha = \frac{\log C_T(4) - \log C_T(60)}{\log 60 - \log 4}$$

Note that a C_T versus V_R law is assumed as shown in the following equation where C_C is included.

$$C_T = \frac{K}{V_R^\alpha}$$

7. **T_{CC}, DIODE CAPACITANCE TEMPERATURE COEFFICIENT**

T_{CC} is guaranteed by comparing C_T at V_R = 4.0 Vdc, f = 1.0 MHz, T_A = -65°C with C_T at V_R = 4.0 Vdc, f = 1.0 MHz, T_A = +85°C in the following equation which defines T_{CC}:

$$T_{CC} = \left| \frac{C_T(+85^\circ\text{C}) - C_T(-65^\circ\text{C})}{85 + 65} \right| \cdot \frac{10^6}{C_T(25^\circ\text{C})}$$

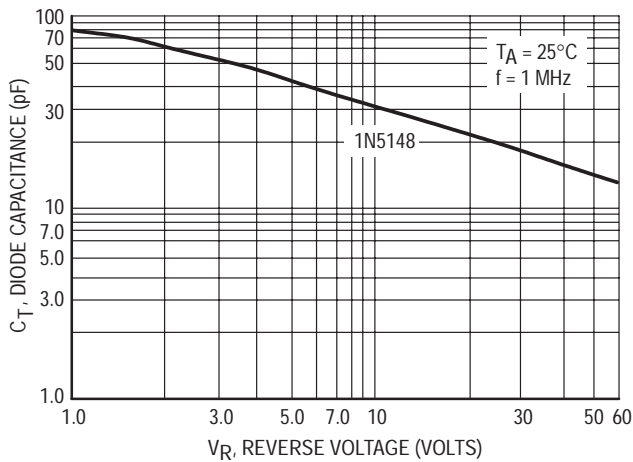


Figure 1. Diode Capacitance versus Reverse Voltage

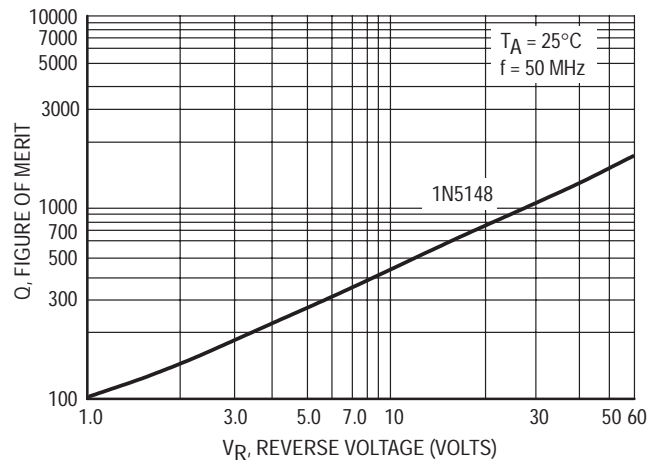


Figure 2. Figure of Merit versus Reverse Voltage

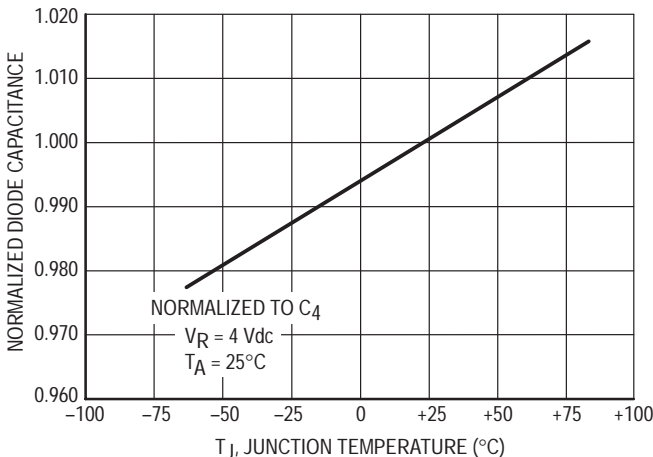


Figure 3. Normalized Diode Capacitance versus Junction Temperature

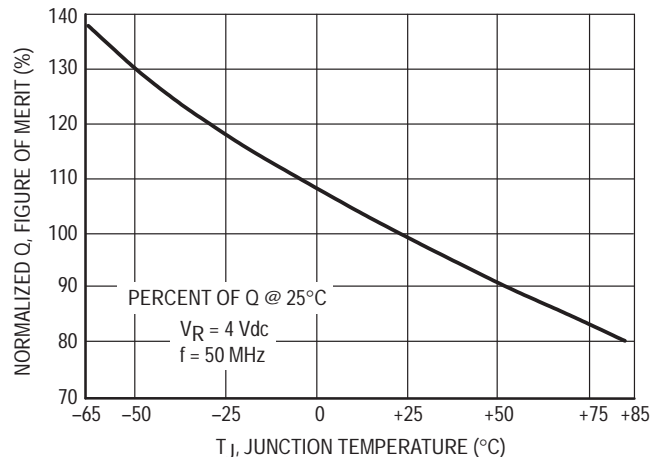


Figure 4. Normalized Figure of Merit versus Junction Temperature

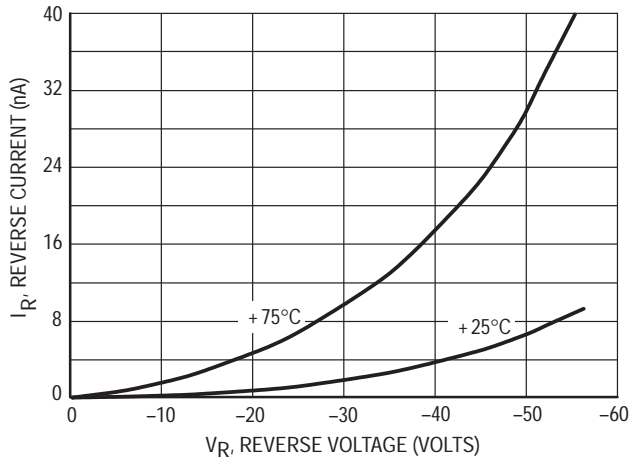


Figure 5. Reverse Current versus Reverse Bias Voltage

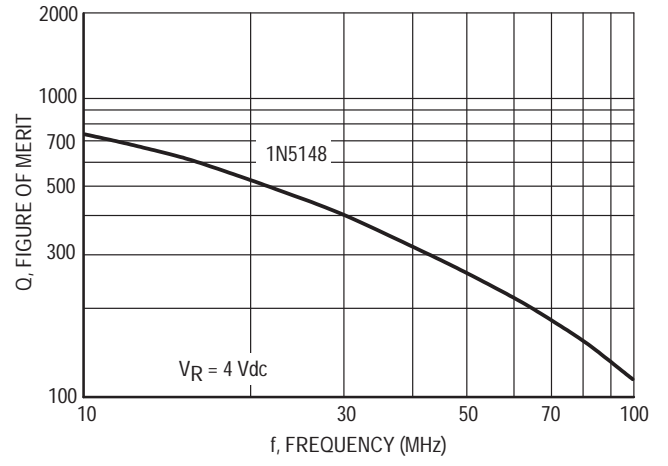


Figure 6. Figure of Merit versus Frequency

Silicon Tuning Diodes

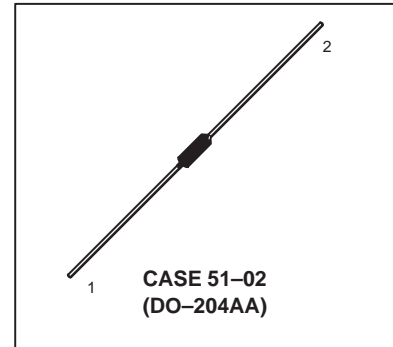
These are epitaxial passivated abrupt junction tuning diodes designed for electronic tuning, FM, AFC and harmonic-generation applications in AM through UHF ranges, providing solid-state reliability to replace mechanical tuning methods.

- Excellent Q Factor at High Frequencies
- Guaranteed Capacitance Change — 2.0 to 30 V
- Capacitance Tolerance — 10% and 5.0%
- Complete Typical Design Curves



1N5446ARL
1N5448ARL
1N5456A

6.8–100 pF
30 VOLTS
VOLTAGE-VARIABLE
CAPACITANCE DIODES



MAXIMUM RATINGS(1)

Rating	Symbol	Value	Unit
Reverse Voltage	V_R	30	Volts
Device Dissipation @ $T_A = 25^\circ\text{C}$ Derate above 25°C	P_D	400 2.67	mW mW/ $^\circ\text{C}$
Operating Junction Temperature Range	T_J	+175	$^\circ\text{C}$
Storage Temperature Range	T_{stg}	-65 to +200	$^\circ\text{C}$

ELECTRICAL CHARACTERISTICS ($T_A = 25^\circ\text{C}$ unless otherwise noted)

Characteristic	Symbol	Min	Typ	Max	Unit
Reverse Breakdown Voltage ($I_R = 10 \mu\text{A dc}$)	$V_{(BR)R}$	30	—	—	Vdc
Reverse Voltage Leakage Current ($V_R = 25 \text{ Vdc}$, $T_A = 25^\circ\text{C}$) ($V_R = 25 \text{ Vdc}$, $T_A = 150^\circ\text{C}$)	I_R	—	—	0.02 20	$\mu\text{A dc}$
Series Inductance ($f = 250 \text{ MHz}$, lead length $\approx 1/16''$)	L_S	—	4.0	—	nH
Case Capacitance ($f = 1.0 \text{ MHz}$, lead length $\approx 1/16''$)	C_C	—	0.17	—	pF
Diode Capacitance Temperature Coefficient (Note 6) ($V_R = 4.0 \text{ Vdc}$, $f = 1.0 \text{ MHz}$)	TC_C	—	300	—	ppm/ $^\circ\text{C}$

Device	C_T , Diode Capacitance $V_R = 4.0 \text{ Vdc}$, $f = 1.0 \text{ MHz}$ pF			TR, Tuning Ratio C_2/C_{30} $f = 1.0 \text{ MHz}$		Q, Figure of Merit $V_R = 4.0 \text{ Vdc}$, $f = 50 \text{ MHz}$
	Min (Nom -10%)	Nom	Max (Nom +10%)	Min	Max	Min
1N5446ARL	16.2	18	19.8	2.6	3.2	350
1N5448ARL	19.8	22	24.2	2.6	3.2	350
1N5456A	90	100	110	2.7	3.3	175

1. Indicates JEDEC Registered Data.

(Replaces 1N5441A/D)

PARAMETER TEST METHODS

1. **L_S, SERIES INDUCTANCE**

L_S is measured on a shorted package at 250 MHz using an impedance bridge (Boonton Radio Model 250A RX Meter or equivalent).

2. **C_C, CASE CAPACITANCE**

C_C is measured on an open package at 1.0 MHz using a capacitance bridge (Boonton Electronics Model 75A or equivalent).

3. **C_T, DIODE CAPACITANCE**

(C_T = C_C + C_J). C_T is measured at 1.0 MHz using a capacitance bridge (Boonton Electronics Model 75A or equivalent).

4. **TR, TUNING RATIO**

TR is the ratio of C_T measured at 2.0 Vdc divided by C_T measured at 30 Vdc.

5. **Q, FIGURE OF MERIT**

Q is calculated by taking the G and C readings of an admittance bridge at the specified frequency and substituting in the following equations:

$$Q = \frac{2\pi fC}{G}$$

(Boonton Electronics Model 33AS8 or equivalent).

7. **T_{CC}, DIODE CAPACITANCE TEMPERATURE COEFFICIENT**

T_{CC} is guaranteed by comparing C_T at V_R = 4.0 Vdc, f = 1.0 MHz, T_A = -65°C with C_T at V_R = 4.0 Vdc, f = 1.0 MHz, T_A = +85°C in the following equation, which defines T_{CC}:

$$TCC = \left| \frac{C_T(+85^\circ C) - C_T(-65^\circ C)}{85 + 65} \right| \cdot \frac{10^6}{C_T(25^\circ C)}$$

Accuracy limited by C_T measurement to ±0.1 pF.

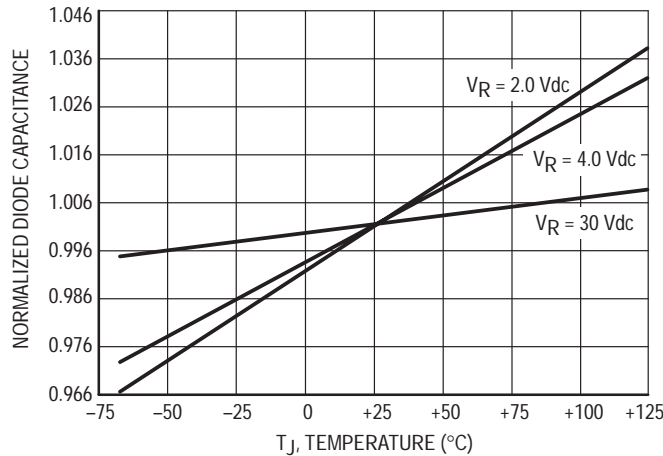


Figure 1. Normalized Diode Capacitance versus Junction Temperature

TYPICAL DEVICE PERFORMANCE

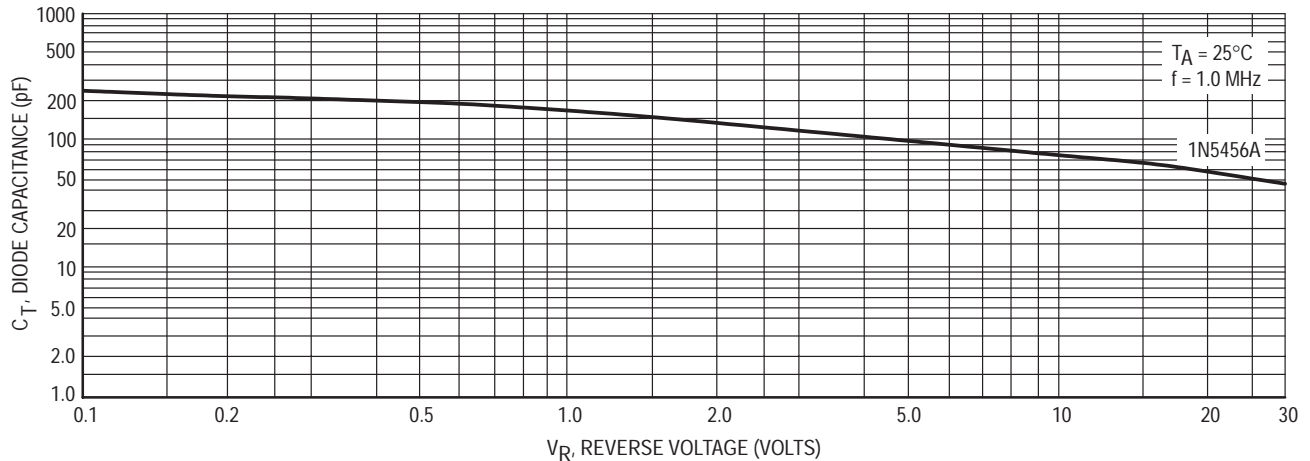


Figure 2. Diode Capacitance versus Reverse Voltage

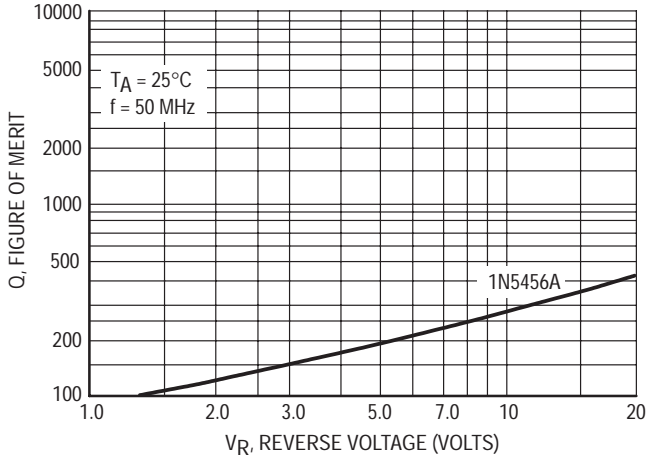


Figure 3. Figure of Merit versus Reverse Voltage

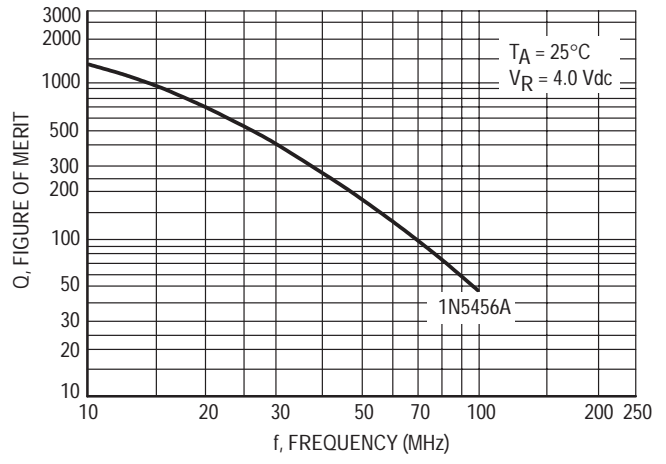


Figure 4. Figure of Merit versus Frequency

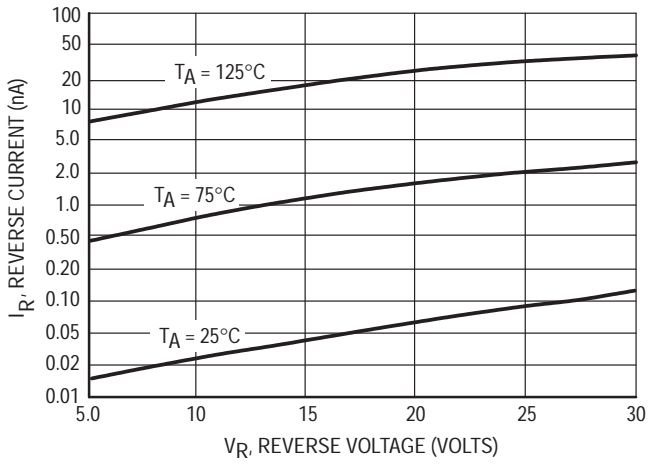


Figure 5. Reverse Current versus Reverse Bias Voltage

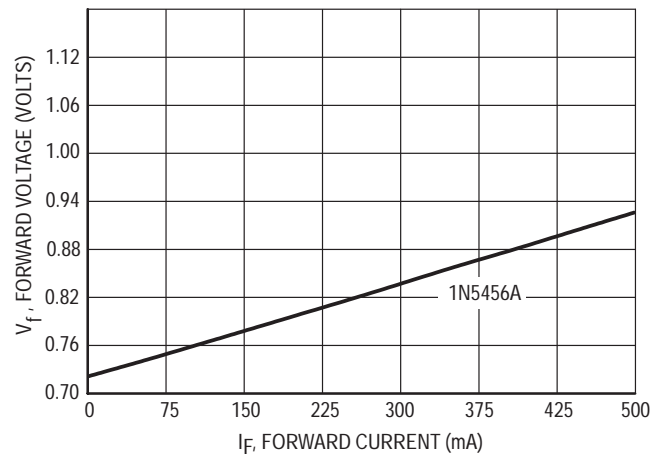


Figure 6. Forward Voltage versus Forward Current

Switching Diode

BAL99LT1

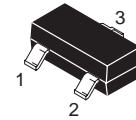


MAXIMUM RATINGS

Rating	Symbol	Value	Unit
Continuous Reverse Voltage	V_R	70	Vdc
Peak Forward Current	I_F	100	mAdc

THERMAL CHARACTERISTICS

Characteristic	Symbol	Max	Unit
Total Device Dissipation FR-5 Board ⁽¹⁾ $T_A = 25^\circ\text{C}$ Derate above 25°C	P_D	225 1.8	mW mW/ $^\circ\text{C}$
Thermal Resistance, Junction to Ambient	$R_{\theta JA}$	556	$^\circ\text{C}/\text{W}$
Total Device Dissipation Alumina Substrate, ⁽²⁾ $T_A = 25^\circ\text{C}$ Derate above 25°C	P_D	300 2.4	mW mW/ $^\circ\text{C}$
Thermal Resistance, Junction to Ambient	$R_{\theta JA}$	417	$^\circ\text{C}/\text{W}$
Junction and Storage Temperature	T_J, T_{stg}	-55 to +150	$^\circ\text{C}$



CASE 318-08, STYLE 18
SOT-23 (TO-236AB)

DEVICE MARKING

BAL99LT1 = JF

ELECTRICAL CHARACTERISTICS ($T_A = 25^\circ\text{C}$ unless otherwise noted)

Characteristic	Symbol	Min	Max	Unit
----------------	--------	-----	-----	------

OFF CHARACTERISTICS

Reverse Voltage Leakage Current ($V_R = 70$ Vdc) ($V_R = 25$ Vdc, $T_J = 150^\circ\text{C}$) ($V_R = 70$ Vdc, $T_J = 150^\circ\text{C}$)	I_R	— — —	2.5 30 50	μAdc
Reverse Breakdown Voltage ($I_R = 100$ μAdc)	$V_{(BR)}$	70	—	Vdc
Forward Voltage ($I_F = 1.0$ mAdc) ($I_F = 10$ mAdc) ($I_F = 50$ mAdc) ($I_F = 150$ mAdc)	V_F	— — — —	715 855 1000 1250	mV
Recovery Current ($I_F = 10$ mAdc, $V_R = 5.0$ Vdc, $R_L = 500$ Ω)	Q_S	—	45	pC
Diode Capacitance ($V_R = 0$, $f = 1.0$ MHz)	C_D	—	1.5	pF
Reverse Recovery Time ($I_F = I_R = 10$ mAdc, $R_L = 100$ Ω , measured at $I_R = 1.0$ mAdc)	t_{rr}	—	6.0	ns
Forward Recovery Voltage ($I_F = 10$ mAdc, $t_f = 20$ ns)	V_{FR}	—	1.75	Vdc

1. FR-5 = $1.0 \times 0.75 \times 0.062$ in.

2. Alumina = $0.4 \times 0.3 \times 0.024$ in. 99.5% alumina.

TYPICAL CHARACTERISTICS

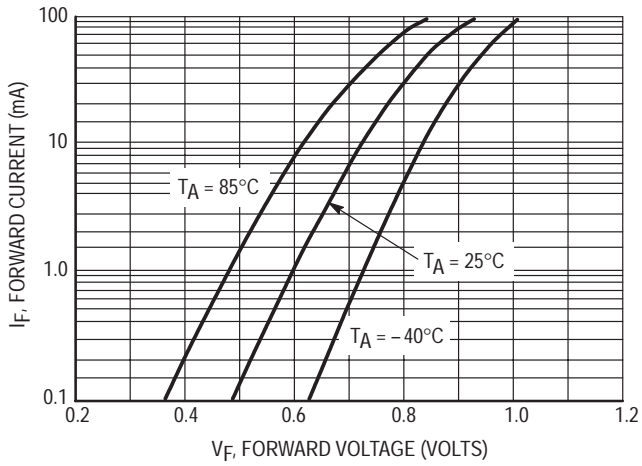


Figure 1. Forward Voltage

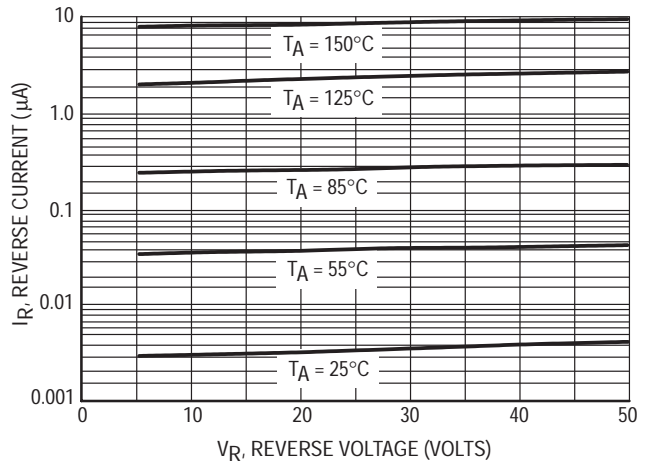


Figure 2. Leakage Current

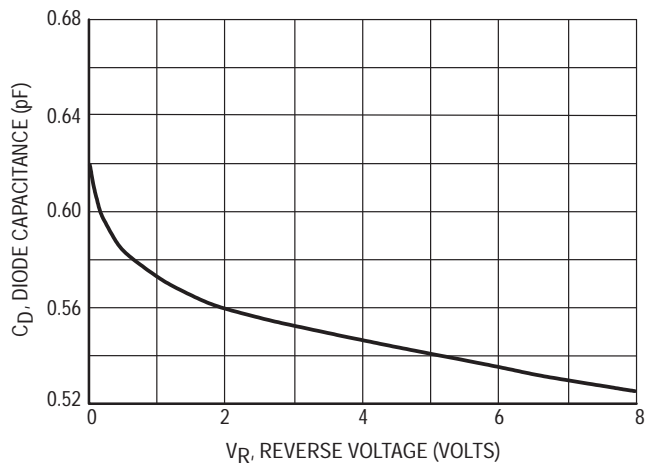


Figure 3. Capacitance

Switching Diode



BAS16LT1

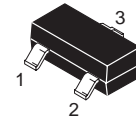
Motorola Preferred Device

MAXIMUM RATINGS

Rating	Symbol	Value	Unit
Continuous Reverse Voltage	V_R	75	Vdc
Peak Forward Current	I_F	200	mAdc
Peak Forward Surge Current	$I_{FM}(\text{surge})$	500	mAdc

THERMAL CHARACTERISTICS

Characteristic	Symbol	Max	Unit
Total Device Dissipation FR-5 Board ⁽¹⁾ $T_A = 25^\circ\text{C}$ Derate above 25°C	P_D	225	mW
		1.8	mW/ $^\circ\text{C}$
Thermal Resistance, Junction to Ambient	$R_{\theta JA}$	556	$^\circ\text{C}/\text{W}$
Total Device Dissipation Alumina Substrate, ⁽²⁾ $T_A = 25^\circ\text{C}$ Derate above 25°C	P_D	300	mW
		2.4	mW/ $^\circ\text{C}$
Thermal Resistance, Junction to Ambient	$R_{\theta JA}$	417	$^\circ\text{C}/\text{W}$
Junction and Storage Temperature	T_J, T_{stg}	-55 to +150	$^\circ\text{C}$



CASE 318-08, STYLE 8
SOT-23 (TO-236AB)

DEVICE MARKING

BAS16LT1 = A6

ELECTRICAL CHARACTERISTICS ($T_A = 25^\circ\text{C}$ unless otherwise noted)

Characteristic	Symbol	Min	Max	Unit
----------------	--------	-----	-----	------

OFF CHARACTERISTICS

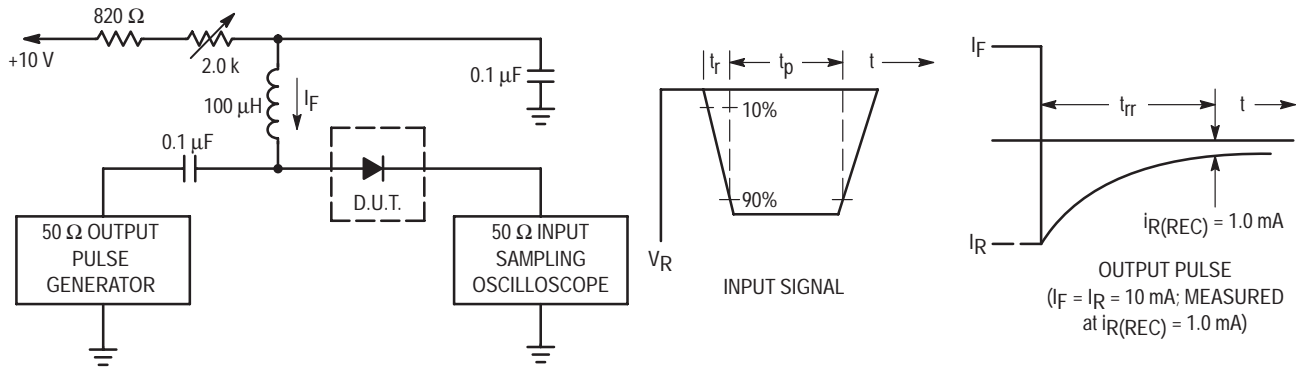
Reverse Voltage Leakage Current ($V_R = 75 \text{ Vdc}$) ($V_R = 75 \text{ Vdc}, T_J = 150^\circ\text{C}$) ($V_R = 25 \text{ Vdc}, T_J = 150^\circ\text{C}$)	I_R	—	1.0 50 30	μAdc
Reverse Breakdown Voltage ($I_{BR} = 100 \mu\text{Adc}$)	$V_{(BR)}$	75	—	Vdc
Forward Voltage ($I_F = 1.0 \text{ mAdc}$) ($I_F = 10 \text{ mAdc}$) ($I_F = 50 \text{ mAdc}$) ($I_F = 150 \text{ mAdc}$)	V_F	—	715 855 1000 1250	mV
Diode Capacitance ($V_R = 0, f = 1.0 \text{ MHz}$)	C_D	—	2.0	pF
Forward Recovery Voltage ($I_F = 10 \text{ mAdc}, t_r = 20 \text{ ns}$)	V_{FR}	—	1.75	Vdc
Reverse Recovery Time ($I_F = I_R = 10 \text{ mAdc}, R_L = 50 \Omega$)	t_{rr}	—	6.0	ns
Stored Charge ($I_F = 10 \text{ mAdc}$ to $V_R = 5.0 \text{ Vdc}, R_L = 500 \Omega$)	Q_S	—	45	pC

1. FR-5 = $1.0 \times 0.75 \times 0.062 \text{ in.}$

2. Alumina = $0.4 \times 0.3 \times 0.024 \text{ in.}$ 99.5% alumina.

Preferred devices are Motorola recommended choices for future use and best overall value.

BAS16LT1



- Notes: 1. A 2.0 kΩ variable resistor adjusted for a Forward Current (I_F) of 10 mA.
 2. Input pulse is adjusted so $I_{R(peak)}$ is equal to 10 mA.
 3. $t_p \gg t_{rr}$

Figure 1. Recovery Time Equivalent Test Circuit

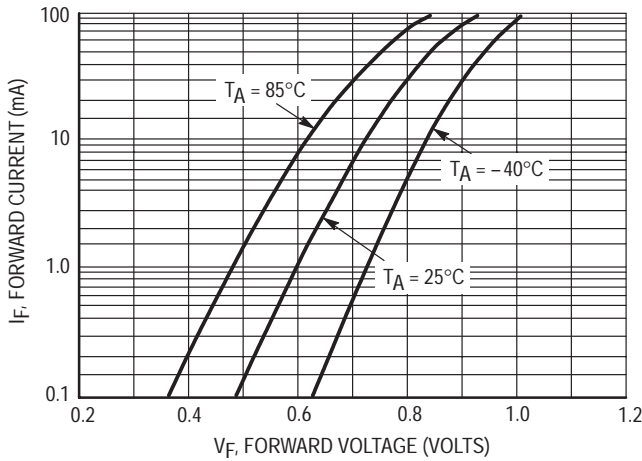


Figure 2. Forward Voltage

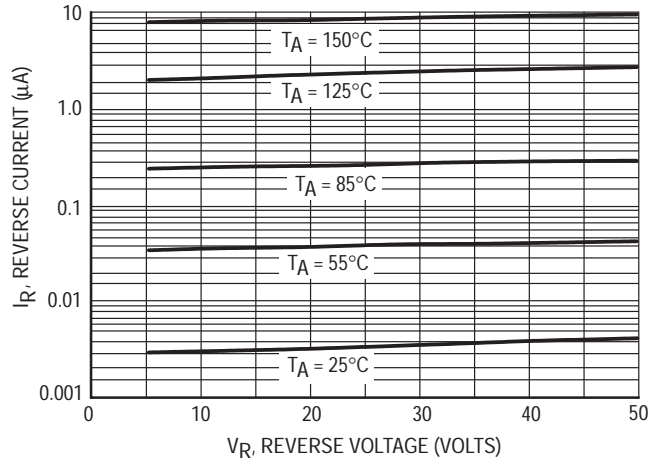


Figure 3. Leakage Current

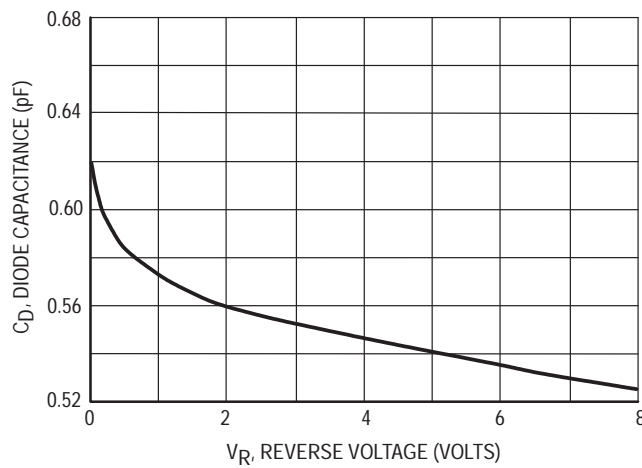
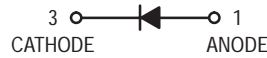


Figure 4. Capacitance

Silicon Switching Diode

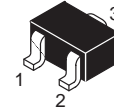
BAS16WT1

Motorola Preferred Device



MAXIMUM RATINGS (T_A = 25°C)

Rating	Symbol	Max	Unit
Continuous Reverse Voltage	V _R	75	V
Recurrent Peak Forward Current	I _R	200	mA
Peak Forward Surge Current Pulse Width = 10 μs	I _{FM(surge)}	500	mA
Total Power Dissipation, One Diode Loaded T _A = 25°C Derate above 25°C Mounted on a Ceramic Substrate (10 x 8 x 0.6 mm)	P _D	200 1.6	mW mW/°C
Operating and Storage Junction Temperature Range	T _J , T _{stg}	-55 to +150	°C



CASE 419-02, STYLE 2
SC-70/SOT-323

THERMAL CHARACTERISTICS

Characteristic	Symbol	Max	Unit
Thermal Resistance, Junction to Ambient One Diode Loaded Mounted on a Ceramic Substrate (10 x 8 x 0.6 mm)	R _{θJA}	0.625	°C/mW

DEVICE MARKING

BAS16WT1 = A6

ELECTRICAL CHARACTERISTICS (T_A = 25°C unless otherwise noted)

Characteristic	Symbol	Min	Max	Unit
Forward Voltage (I _F = 1.0 mA) (I _F = 10 mA) (I _F = 50 mA) (I _F = 150 mA)	V _F	—	715 866 1000 1250	mV
Reverse Current (V _R = 75 V) (V _R = 75 V, T _J = 150°C) (V _R = 25 V, T _J = 150°C)	I _R	—	1.0 50 30	μA
Capacitance (V _R = 0, f = 1.0 MHz)	C _D	—	2.0	pF
Reverse Recovery Time (I _F = I _R = 10 mA, R _L = 50 Ω) (Figure 1)	t _{rr}	—	6.0	ns
Stored Charge (I _F = 10 mA to V _R = 6.0 V, R _L = 500 Ω) (Figure 2)	Q _S	—	45	PC
Forward Recovery Voltage (I _F = 10 mA, t _r = 20 ns) (Figure 3)	V _{FR}	—	1.75	V

Preferred devices are Motorola recommended choices for future use and best overall value.

BAS16WT1

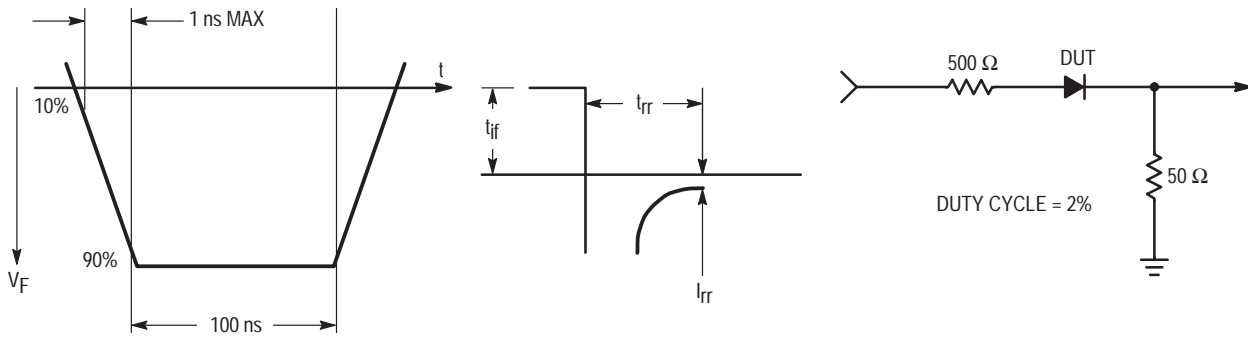


Figure 1. Reverse Recovery Time Equivalent Test Circuit

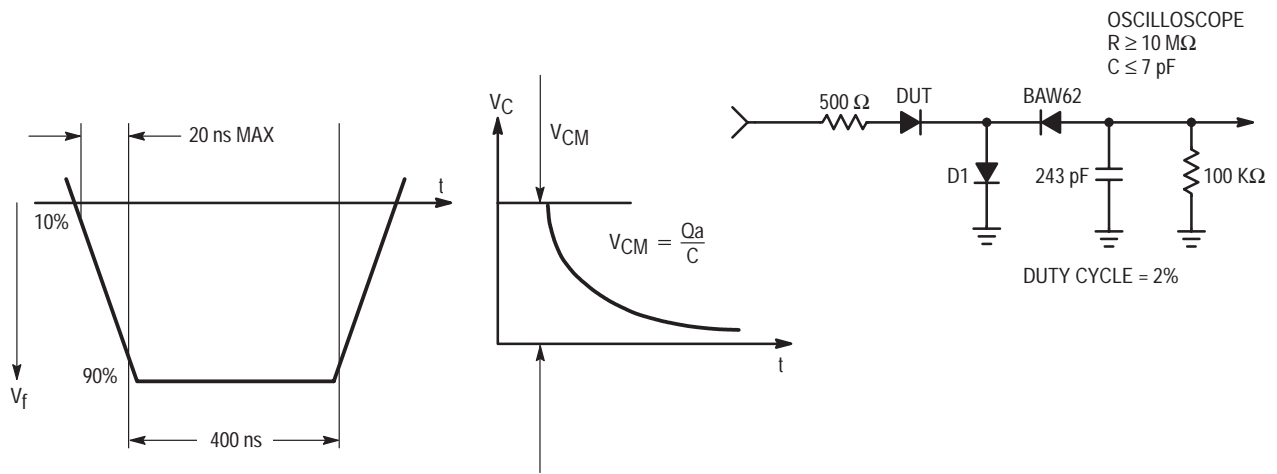


Figure 2. Recovery Charge Equivalent Test Circuit

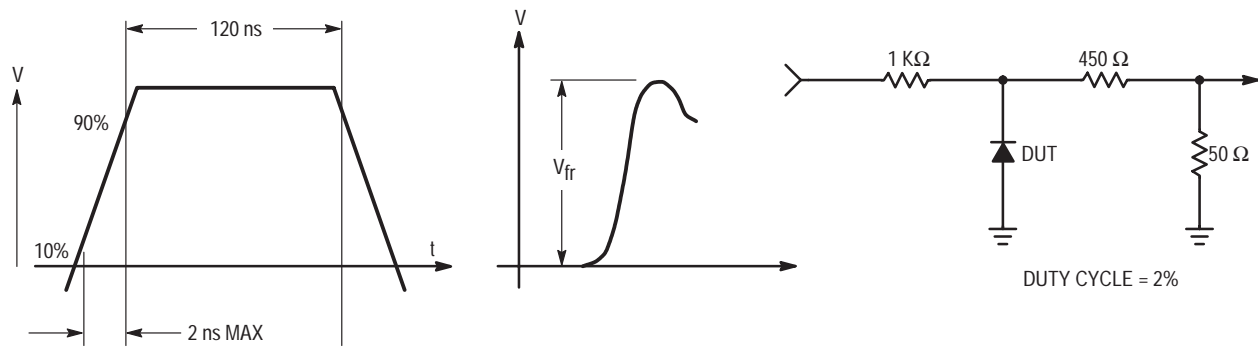


Figure 3. Forward Recovery Voltage Equivalent Test Circuit

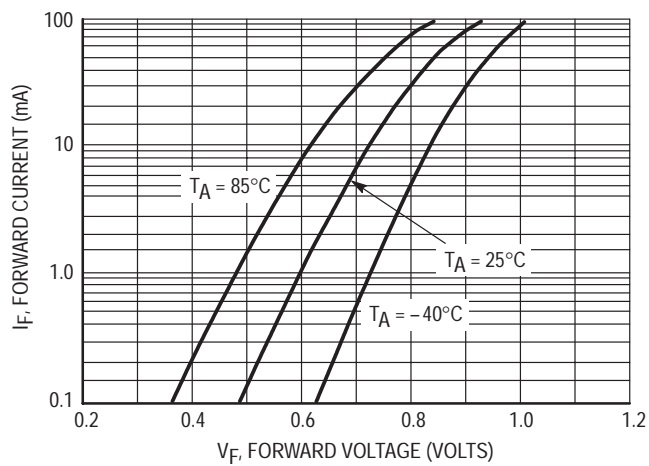


Figure 4. Forward Voltage

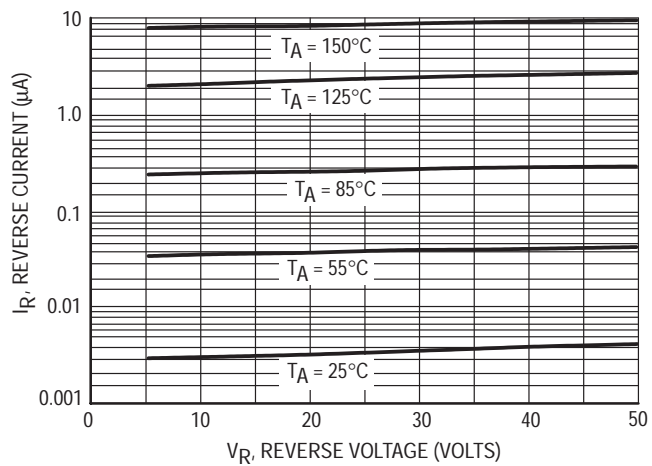


Figure 5. Leakage Current

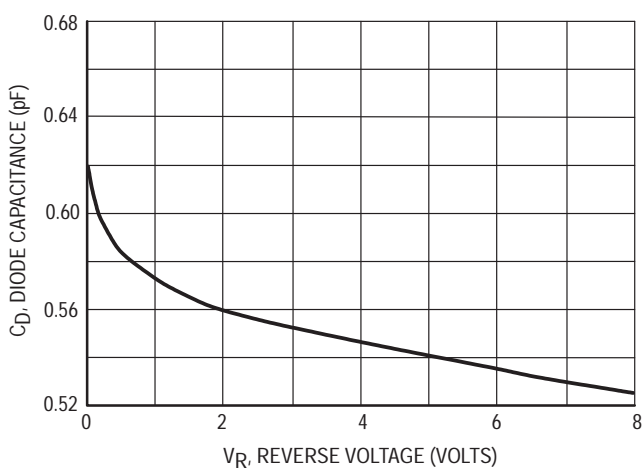


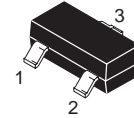
Figure 6. Capacitance

High Voltage Switching Diode



BAS21LT1

Motorola Preferred Device



CASE 318-08, STYLE 8
SOT-23 (TO-236AB)

MAXIMUM RATINGS

Rating	Symbol	Value	Unit
Continuous Reverse Voltage	V_R	250	Vdc
Peak Forward Current	I_F	200	mAdc
Peak Forward Surge Current	$I_{FM}(\text{surge})$	625	mAdc

THERMAL CHARACTERISTICS

Characteristic	Symbol	Max	Unit
Total Device Dissipation FR-5 Board ⁽¹⁾ $T_A = 25^\circ\text{C}$ Derate above 25°C	P_D	225	mW
		1.8	mW/ $^\circ\text{C}$
Thermal Resistance, Junction to Ambient	$R_{\theta JA}$	556	$^\circ\text{C}/\text{W}$
Total Device Dissipation Alumina Substrate, ⁽²⁾ $T_A = 25^\circ\text{C}$ Derate above 25°C	P_D	300	mW
		2.4	mW/ $^\circ\text{C}$
Thermal Resistance, Junction to Ambient	$R_{\theta JA}$	417	$^\circ\text{C}/\text{W}$
Junction and Storage Temperature	T_J, T_{stg}	-55 to +150	$^\circ\text{C}$

DEVICE MARKING

BAS21LT1 = JS

ELECTRICAL CHARACTERISTICS ($T_A = 25^\circ\text{C}$ unless otherwise noted)

Characteristic	Symbol	Min	Max	Unit
----------------	--------	-----	-----	------

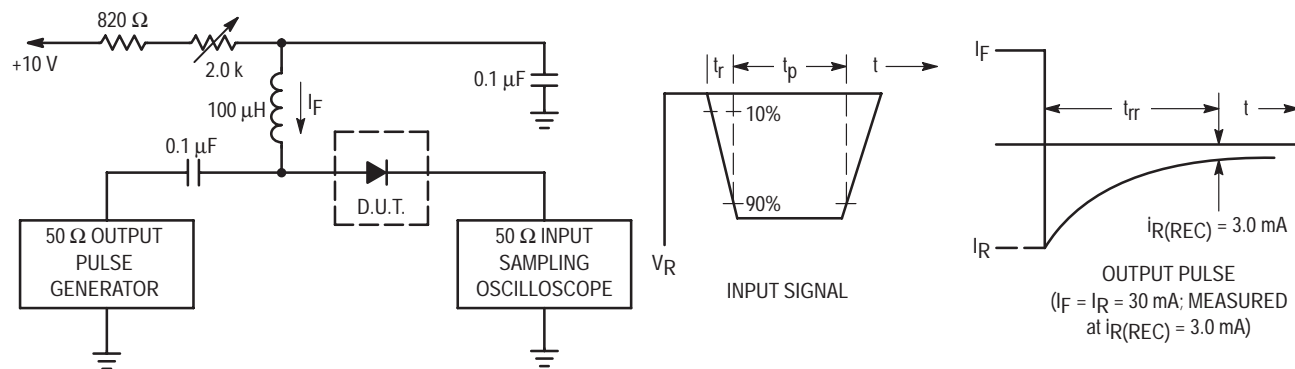
OFF CHARACTERISTICS

Reverse Voltage Leakage Current ($V_R = 200 \text{ Vdc}$) ($V_R = 200 \text{ Vdc}, T_J = 150^\circ\text{C}$)	I_R	—	1.0 100	μAdc
Reverse Breakdown Voltage ($I_{BR} = 100 \mu\text{Adc}$)	$V_{(BR)}$	250	—	Vdc
Forward Voltage ($I_F = 100 \text{ mAdc}$) ($I_F = 200 \text{ mAdc}$)	V_F	—	1000 1250	mV
Diode Capacitance ($V_R = 0, f = 1.0 \text{ MHz}$)	C_D	—	5.0	pF
Reverse Recovery Time ($I_F = I_R = 30 \text{ mAdc}, R_L = 100 \Omega$)	t_{rr}	—	50	ns

1. FR-5 = $1.0 \times 0.75 \times 0.062 \text{ in.}$

2. Alumina = $0.4 \times 0.3 \times 0.024 \text{ in. } 99.5\% \text{ alumina.}$

Preferred devices are Motorola recommended choices for future use and best overall value.

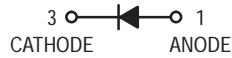


- Notes: 1. A 2.0 kΩ variable resistor adjusted for a Forward Current (I_F) of 30 mA.
 2. Input pulse is adjusted so $I_{R(\text{peak})}$ is equal to 30 mA.
 3. $t_p \gg t_{rr}$

Figure 1. Recovery Time Equivalent Test Circuit

Preliminary Information
Schottky Barrier Diodes

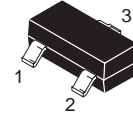
These Schottky barrier diodes are designed for high speed switching applications, circuit protection, and voltage clamping. Extremely low forward voltage reduces conduction loss. Miniature surface mount package is excellent for hand held and portable applications where space is limited.



BAS40LT1

Motorola Preferred Device

**40 VOLTS
SCHOTTKY BARRIER DIODES**



**CASE 318-08, STYLE 8
SOT-23 (TO-236AB)**

MAXIMUM RATINGS ($T_J = 150^\circ\text{C}$ unless otherwise noted)

Rating	Symbol	Value	Unit
Reverse Voltage	V_R	40	Volts
Forward Power Dissipation @ $T_A = 25^\circ\text{C}$ Derate above 25°C	P_F	225 1.8	mW mW/ $^\circ\text{C}$
Operating Junction and Storage Temperature Range	T_J, T_{stg}	-55 to +150	$^\circ\text{C}$

DEVICE MARKING

BAS40LT1 = B1

ELECTRICAL CHARACTERISTICS ($T_A = 25^\circ\text{C}$ unless otherwise noted)

Characteristic	Symbol	Min	Max	Unit
Reverse Breakdown Voltage ($I_R = 10 \mu\text{A}$)	$V_{(BR)R}$	40	—	Volts
Total Capacitance ($V_R = 1.0 \text{ V}, f = 1.0 \text{ MHz}$)	C_T	—	5.0	pF
Reverse Leakage ($V_R = 25 \text{ V}$)	I_R	—	1.0	μAdc
Forward Voltage ($I_F = 0.1 \text{ mAdc}$)	V_F	—	380	mVdc
Forward Voltage ($I_F = 30 \text{ mAdc}$)	V_F	—	500	mVdc
Forward Voltage ($I_F = 100 \text{ mAdc}$)	V_F	—	1.0	Vdc

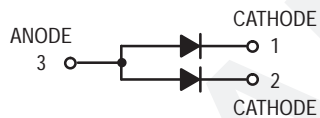
Preferred devices are Motorola recommended choices for future use and best overall value.

Preliminary Information

Common Anode Schottky Barrier Diode

These Schottky barrier diodes are designed for high speed switching applications, circuit protection, and voltage clamping. Extremely low forward voltage reduces conduction loss. Miniature surface mount package is excellent for hand held and portable applications where space is limited.

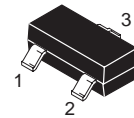
- Extremely Fast Switching Speed
- Low Forward Voltage — 0.50 Volts (Typ) @ $I_F = 10 \text{ mAdc}$



BAS40-04LT1

Motorola Preferred Device

**40 VOLTS
SCHOTTKY BARRIER DIODES**



**CASE 318-08, STYLE 12
SOT-23 (TO-236AB)**

MAXIMUM RATINGS ($T_J = 150^\circ\text{C}$ unless otherwise noted)

Rating	Symbol	Value	Unit
Reverse Voltage	V_R	40	Volts
Forward Power Dissipation @ $T_A = 25^\circ\text{C}$ Derate above 25°C	P_F	225 1.8	mW mW/ $^\circ\text{C}$
Operating Junction and Storage Temperature Range	T_J, T_{stg}	-55 to +150	$^\circ\text{C}$

ELECTRICAL CHARACTERISTICS ($T_A = 25^\circ\text{C}$ unless otherwise noted)

Characteristic	Symbol	Min	Max	Unit
Reverse Breakdown Voltage ($I_R = 10 \mu\text{A}$)	$V_{(BR)R}$	40	—	Volts
Total Capacitance ($V_R = 1.0 \text{ V}, f = 1.0 \text{ MHz}$)	C_T	—	5.0	pF
Reverse Leakage ($V_R = 25 \text{ V}$)	I_R	—	1.0	μAdc
Forward Voltage ($I_F = 0.1 \text{ mAdc}$)	V_F	—	380	mVdc
Forward Voltage ($I_F = 30 \text{ mAdc}$)	V_F	—	500	mVdc
Forward Voltage ($I_F = 100 \text{ mAdc}$)	V_F	—	1.0	Vdc

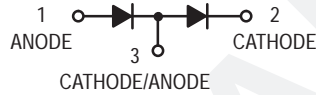
Preferred devices are Motorola recommended choices for future use and best overall value.

Preliminary Information

Dual Series Schottky Barrier Diodes

These Schottky barrier diodes are designed for high speed switching applications, circuit protection, and voltage clamping. Extremely low forward voltage reduces conduction loss. Miniature surface mount package is excellent for hand held and portable applications where space is limited.

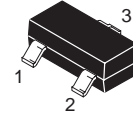
- Extremely Fast Switching Speed
- Low Forward Voltage — 0.50 Volts (Typ) @ $I_F = 10 \text{ mAdc}$



BAS40-06LT1

Motorola Preferred Device

**40 VOLTS
SCHOTTKY BARRIER DIODES**



**CASE 318-08, STYLE 11
SOT-23 (TO-236AB)**

MAXIMUM RATINGS ($T_J = 150^\circ\text{C}$ unless otherwise noted)

Rating	Symbol	Value	Unit
Reverse Voltage	V_R	40	Volts
Forward Power Dissipation @ $T_A = 25^\circ\text{C}$ Derate above 25°C	P_F	225 1.8	mW mW/°C
Operating Junction and Storage Temperature Range	T_J, T_{stg}	-55 to +150	°C

ELECTRICAL CHARACTERISTICS ($T_A = 25^\circ\text{C}$ unless otherwise noted)

Characteristic	Symbol	Min	Max	Unit
Reverse Breakdown Voltage ($I_R = 10 \mu\text{A}$)	$V_{(BR)R}$	40	—	Volts
Total Capacitance ($V_R = 1.0 \text{ V}, f = 1.0 \text{ MHz}$)	C_T	—	5.0	pF
Reverse Leakage ($V_R = 25 \text{ V}$)	I_R	—	1.0	μAdc
Forward Voltage ($I_F = 0.1 \text{ mAdc}$)	V_F	—	380	mVdc
Forward Voltage ($I_F = 30 \text{ mAdc}$)	V_F	—	500	mVdc
Forward Voltage ($I_F = 100 \text{ mAdc}$)	V_F	—	1.0	Vdc

Preferred devices are Motorola recommended choices for future use and best overall value.

Preliminary Information

Schottky Barrier Diodes

These Schottky barrier diodes are designed for high speed switching applications, circuit protection, and voltage clamping. Extremely low forward voltage reduces conduction loss. Miniature surface mount package is excellent for hand held and portable applications where space is limited.

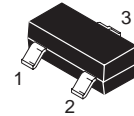
- Extremely Fast Switching Speed
- Low Forward Voltage — 0.75 Volts (Typ) @ $I_F = 10 \text{ mAdc}$



BAS70LT1

Motorola Preferred Device

**70 VOLTS
SCHOTTKY BARRIER DIODES**



**CASE 318-08, STYLE 8
SOT-23 (TO-236AB)**

MAXIMUM RATINGS ($T_J = 150^\circ\text{C}$ unless otherwise noted)

Rating	Symbol	Value	Unit
Reverse Voltage	V_R	70	Volts
Forward Power Dissipation @ $T_A = 25^\circ\text{C}$ Derate above 25°C	P_F	225 1.8	mW mW/ $^\circ\text{C}$
Operating Junction and Storage Temperature Range	T_J, T_{stg}	-55 to +150	$^\circ\text{C}$

DEVICE MARKING

BAS70LT1 = BE

ELECTRICAL CHARACTERISTICS ($T_A = 25^\circ\text{C}$ unless otherwise noted)

Characteristic	Symbol	Min	Max	Unit
Reverse Breakdown Voltage ($I_R = 10 \mu\text{A}$)	$V_{(BR)R}$	70	—	Volts
Total Capacitance ($V_R = 0 \text{ V}, f = 1.0 \text{ MHz}$)	C_T	—	2.0	pF
Reverse Leakage ($V_R = 50 \text{ V}$) ($V_R = 70 \text{ V}$)	I_R	— —	0.1 10	μAdc
Forward Voltage ($I_F = 1.0 \text{ mAdc}$)	V_F	—	410	mVdc
Forward Voltage ($I_F = 10 \text{ mAdc}$)	V_F	—	750	mVdc
Forward Voltage ($I_F = 15 \text{ mAdc}$)	V_F	—	1.0	Vdc

Preferred devices are Motorola recommended choices for future use and best overall value.

Preliminary Information
**Common Anode
Schottky Barrier Diode**

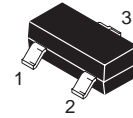
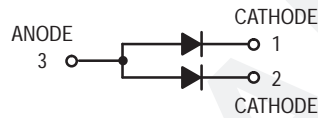
These Schottky barrier diodes are designed for high speed switching applications, circuit protection, and voltage clamping. Extremely low forward voltage reduces conduction loss. Miniature surface mount package is excellent for hand held and portable applications where space is limited.

- Extremely Fast Switching Speed
- Low Forward Voltage — 0.75 Volts (Typ) @ $I_F = 10 \text{ mAdc}$

BAS70-04LT1

Motorola Preferred Device

**70 VOLTS
SCHOTTKY BARRIER DIODES**



**CASE 318-08, STYLE 12
SOT-23 (TO-236AB)**

MAXIMUM RATINGS ($T_J = 150^\circ\text{C}$ unless otherwise noted)

Rating	Symbol	Value	Unit
Reverse Voltage	V_R	70	Volts
Forward Power Dissipation @ $T_A = 25^\circ\text{C}$ Derate above 25°C	P_F	225 1.8	mW mW/ $^\circ\text{C}$
Operating Junction and Storage Temperature Range	T_J, T_{stg}	-55 to +150	$^\circ\text{C}$

ELECTRICAL CHARACTERISTICS ($T_A = 25^\circ\text{C}$ unless otherwise noted)

Characteristic	Symbol	Min	Max	Unit
Reverse Breakdown Voltage ($I_R = 10 \mu\text{A}$)	$V_{(BR)R}$	70	—	Volts
Total Capacitance ($V_R = 0 \text{ V}, f = 1.0 \text{ MHz}$)	C_T	—	2.0	pF
Reverse Leakage ($V_R = 50 \text{ V}$) ($V_R = 70 \text{ V}$)	I_R	— —	0.1 10	μAdc
Forward Voltage ($I_F = 1.0 \text{ mAdc}$)	V_F	—	410	mVdc
Forward Voltage ($I_F = 10 \text{ mAdc}$)	V_F	—	750	mVdc
Forward Voltage ($I_F = 15 \text{ mAdc}$)	V_F	—	1.0	Vdc

Preferred devices are Motorola recommended choices for future use and best overall value.

Switching Diode

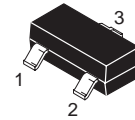
This switching diode has the following features:

- Low Leakage Current Applications
- Medium Speed Switching Times
- Available in 8 mm Tape and Reel
 - Use BAS116LT1 to order the 7 inch/3,000 unit reel
 - Use BAS116LT3 to order the 13 inch/10,000 unit reel



BAS116LT1

Motorola Preferred Device



CASE 318-08, STYLE 8
SOT-23 (TO-236AB)

MAXIMUM RATINGS

Rating	Symbol	Value	Unit
Continuous Reverse Voltage	V_R	75	Vdc
Peak Forward Current	I_F	200	mAdc
Peak Forward Surge Current	$I_{FM}(\text{surge})$	500	mAdc

THERMAL CHARACTERISTICS

Characteristic	Symbol	Max	Unit
Total Device Dissipation FR-5 Board ⁽¹⁾ $T_A = 25^\circ\text{C}$ Derate above 25°C	P_D	225	mW
		1.8	mW/ $^\circ\text{C}$
Thermal Resistance, Junction to Ambient	$R_{\theta JA}$	556	$^\circ\text{C}/\text{W}$
Total Device Dissipation Alumina Substrate ⁽²⁾ $T_A = 25^\circ\text{C}$ Derate above 25°C	P_D	300	mW
		2.4	mW/ $^\circ\text{C}$
Thermal Resistance, Junction to Ambient	$R_{\theta JA}$	417	$^\circ\text{C}/\text{W}$
Junction and Storage Temperature	T_J, T_{stg}	-55 to +150	$^\circ\text{C}$

DEVICE MARKING

BAS116LT1 = JV

ELECTRICAL CHARACTERISTICS ($T_A = 25^\circ\text{C}$ unless otherwise noted)

Characteristic	Symbol	Min	Max	Unit
----------------	--------	-----	-----	------

OFF CHARACTERISTICS

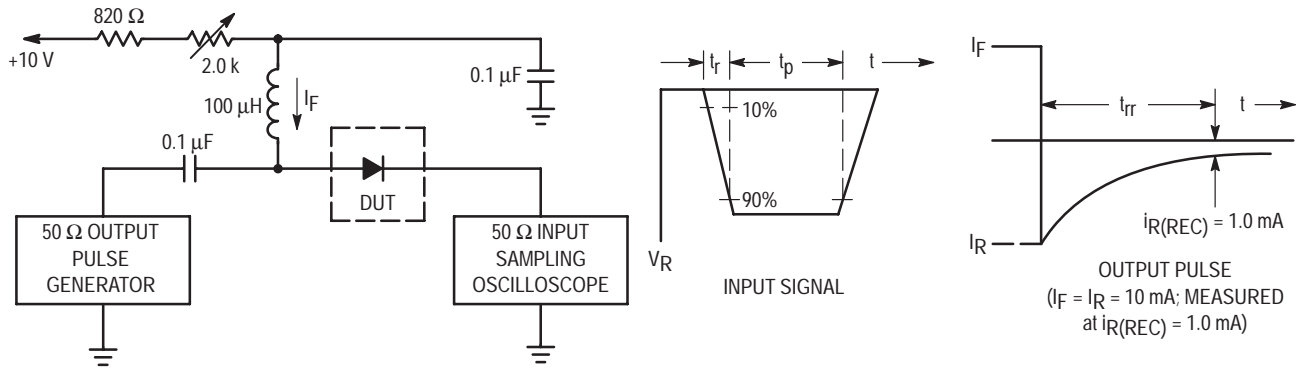
Reverse Breakdown Voltage ($I_{BR} = 100 \mu\text{Adc}$)	$V_{(BR)}$	75	—	Vdc
Reverse Voltage Leakage Current ($V_R = 75 \text{ Vdc}$) ($V_R = 75 \text{ Vdc}, T_J = 150^\circ\text{C}$)	I_R	—	5.0 80	nAdc
Forward Voltage ($I_F = 1.0 \text{ mAdc}$) ($I_F = 10 \text{ mAdc}$) ($I_F = 50 \text{ mAdc}$) ($I_F = 150 \text{ mAdc}$)	V_F	—	900 1000 1100 1250	mV
Diode Capacitance ($V_R = 0 \text{ V}, f = 1.0 \text{ MHz}$)	C_D	—	2.0	pF
Reverse Recovery Time ($I_F = I_R = 10 \text{ mAdc}$) (Figure 1)	t_{rr}	—	3.0	μs

1. FR-5 = $1.0 \times 0.75 \times 0.062 \text{ in.}$

2. Alumina = $0.4 \times 0.3 \times 0.024 \text{ in.}$ 99.5% alumina.

Preferred devices are Motorola recommended choices for future use and best overall value.

BAS116LT1



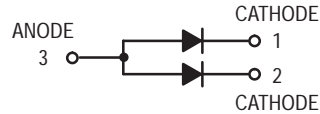
- Notes: 1. A 2.0 kΩ variable resistor adjusted for a Forward Current (I_F) of 10 mA.
- 2. Input pulse is adjusted so $I_{R(peak)}$ is equal to 10 mA.
- 3. $t_p \gg t_{rr}$

Figure 1. Recovery Time Equivalent Test Circuit

Schottky Barrier Diodes

These Schottky barrier diodes are designed for high speed switching applications, circuit protection, and voltage clamping. Extremely low forward voltage reduces conduction loss. Miniature surface mount package is excellent for hand held and portable applications where space is limited.

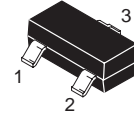
- Extremely Fast Switching Speed
- Low Forward Voltage — 0.35 Volts (Typ) @ $I_F = 10 \text{ mAdc}$



BAT54ALT1

Motorola Preferred Device

**30 VOLTS
SCHOTTKY BARRIER
DETECTOR AND SWITCHING
DIODES**



**CASE 318-08, STYLE 12
SOT-23 (TO-236AB)**

MAXIMUM RATINGS ($T_J = 125^\circ\text{C}$ unless otherwise noted)

Rating	Symbol	Value	Unit
Reverse Voltage	V_R	30	Volts
Forward Power Dissipation @ $T_A = 25^\circ\text{C}$ Derate above 25°C	P_F	225 1.8	mW mW/ $^\circ\text{C}$
Operating Junction Temperature Range	T_J	-55 to +150	$^\circ\text{C}$
Storage Temperature Range	T_{stg}	-55 to +150	$^\circ\text{C}$

DEVICE MARKING

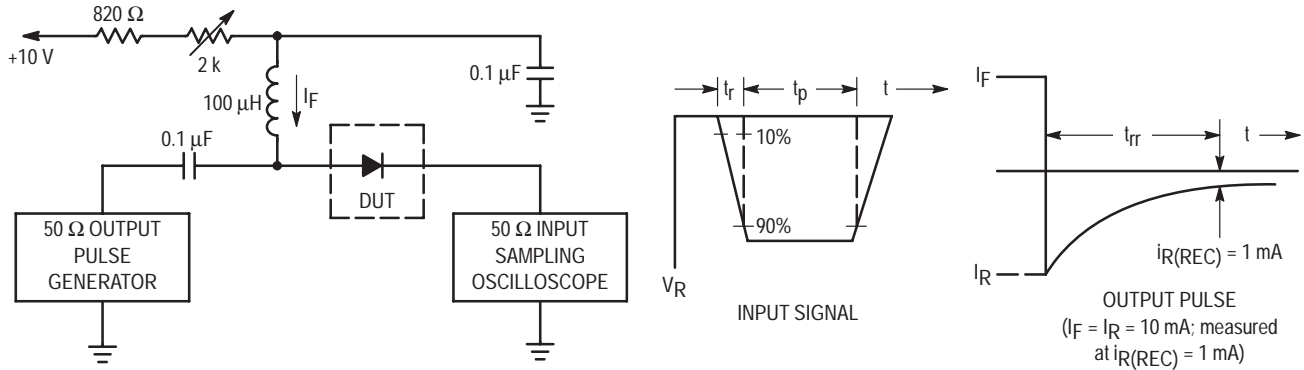
BAT54ALT1 = B6

ELECTRICAL CHARACTERISTICS ($T_A = 25^\circ\text{C}$ unless otherwise noted) (EACH DIODE)

Characteristic	Symbol	Min	Typ	Max	Unit
Reverse Breakdown Voltage ($I_R = 10 \mu\text{A}$)	$V_{(BR)R}$	30	—	—	Volts
Total Capacitance ($V_R = 1.0 \text{ V}$, $f = 1.0 \text{ MHz}$)	C_T	—	7.6	10	pF
Reverse Leakage ($V_R = 25 \text{ V}$)	I_R	—	0.5	2.0	μAdc
Forward Voltage ($I_F = 0.1 \text{ mAdc}$)	V_F	—	0.22	0.24	Vdc
Forward Voltage ($I_F = 30 \text{ mAdc}$)	V_F	—	0.41	0.5	Vdc
Forward Voltage ($I_F = 100 \text{ mAdc}$)	V_F	—	0.52	1.0	Vdc
Reverse Recovery Time ($I_F = I_R = 10 \text{ mAdc}$, $I_{R(REC)} = 1.0 \text{ mAdc}$) Figure 1	t_{rr}	—	—	5.0	ns
Forward Voltage ($I_F = 1.0 \text{ mAdc}$)	V_F	—	0.29	0.32	Vdc
Forward Voltage ($I_F = 10 \text{ mAdc}$)	V_F	—	0.35	0.40	Vdc

Preferred devices are Motorola recommended choices for future use and best overall value.

BAT54ALT1



- Notes: 1. A 2.0 kΩ variable resistor adjusted for a Forward Current (I_F) of 10 mA.
- 2. Input pulse is adjusted so $I_{R(peak)}$ is equal to 10 mA.
- 3. $t_p \gg t_{rr}$

Figure 1. Recovery Time Equivalent Test Circuit

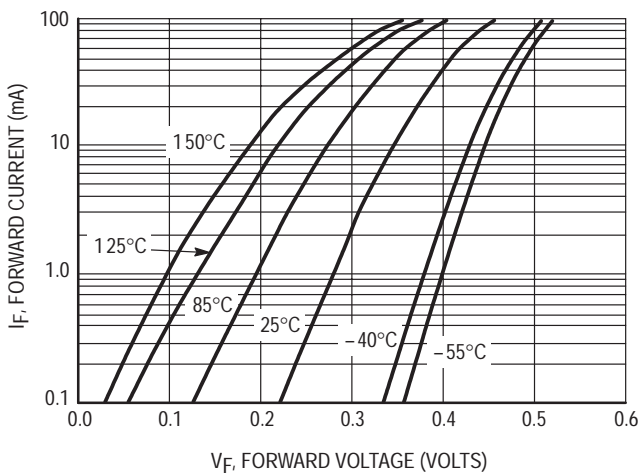


Figure 2. Forward Voltage

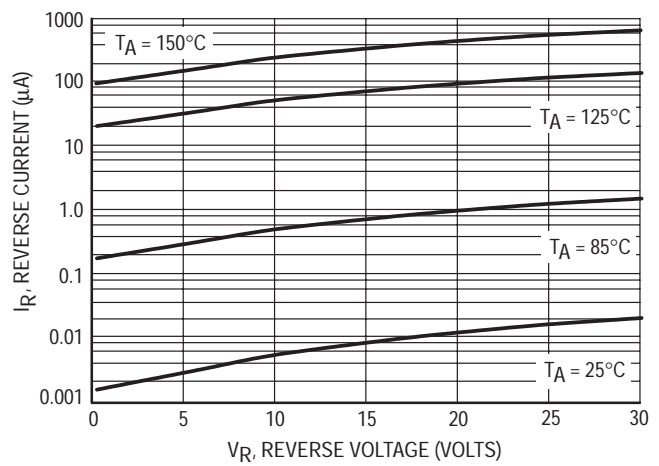


Figure 3. Leakage Current

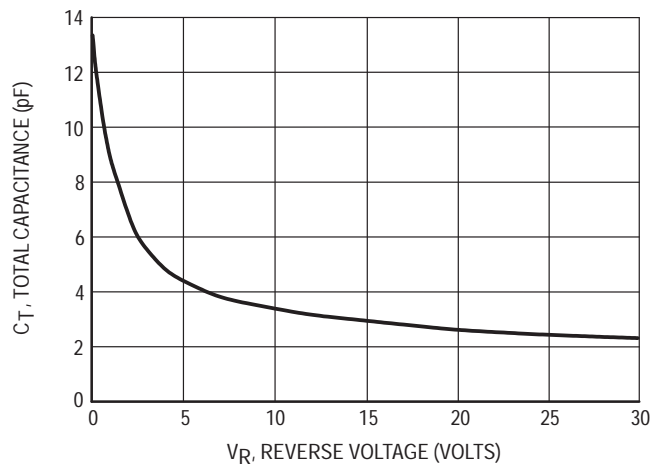


Figure 4. Total Capacitance

Schottky Barrier Diodes

These Schottky barrier diodes are designed for high speed switching applications, circuit protection, and voltage clamping. Extremely low forward voltage reduces conduction loss. Miniature surface mount package is excellent for hand held and portable applications where space is limited.

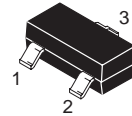
- Extremely Fast Switching Speed
- Low Forward Voltage — 0.35 Volts (Typ) @ $I_F = 10$ mAdc



BAT54LT1

Motorola Preferred Device

**30 VOLTS
SILICON HOT-CARRIER
DETECTOR AND SWITCHING
DIODES**



**CASE 318-08, STYLE 8
SOT-23 (TO-236AB)**

MAXIMUM RATINGS ($T_J = 125^\circ\text{C}$ unless otherwise noted)

Rating	Symbol	Value	Unit
Reverse Voltage	V_R	30	Volts
Forward Power Dissipation @ $T_A = 25^\circ\text{C}$ Derate above 25°C	P_F	200 2.0	mW mW/ $^\circ\text{C}$
Operating Junction Temperature Range	T_J	-55 to +125	$^\circ\text{C}$
Storage Temperature Range	T_{stg}	-55 to +150	$^\circ\text{C}$

DEVICE MARKING

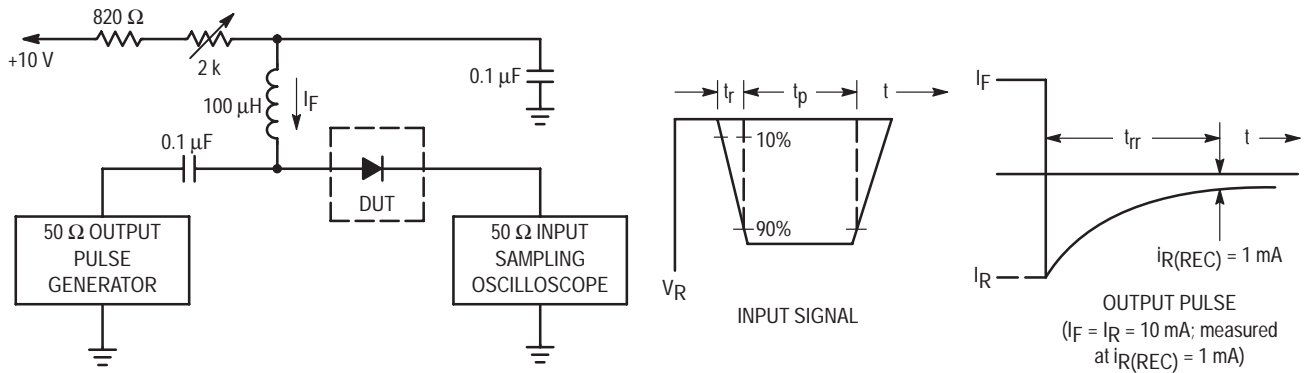
BAT54LT1 = LV3

ELECTRICAL CHARACTERISTICS ($T_A = 25^\circ\text{C}$ unless otherwise noted)

Characteristic	Symbol	Min	Typ	Max	Unit
Reverse Breakdown Voltage ($I_R = 10 \mu\text{A}$)	$V_{(BR)R}$	30	—	—	Volts
Total Capacitance ($V_R = 1.0 \text{ V}$, $f = 1.0 \text{ MHz}$)	C_T	—	7.6	10	pF
Reverse Leakage ($V_R = 25 \text{ V}$)	I_R	—	0.5	2.0	μAdc
Forward Voltage ($I_F = 0.1 \text{ mAdc}$)	V_F	—	0.22	0.24	Vdc
Forward Voltage ($I_F = 30 \text{ mAdc}$)	V_F	—	0.41	0.5	Vdc
Forward Voltage ($I_F = 100 \text{ mAdc}$)	V_F	—	0.52	1.0	Vdc
Reverse Recovery Time ($I_F = I_R = 10 \text{ mAdc}$, $I_{R(REC)} = 1.0 \text{ mAdc}$) Figure 1	t_{rr}	—	—	5.0	ns
Forward Voltage ($I_F = 1.0 \text{ mAdc}$)	V_F	—	0.29	0.32	Vdc
Forward Voltage ($I_F = 10 \text{ mAdc}$)	V_F	—	0.35	0.40	Vdc

Preferred devices are Motorola recommended choices for future use and best overall value.

BAT54LT1



- Notes: 1. A 2.0 kΩ variable resistor adjusted for a Forward Current (I_F) of 10 mA.
 2. Input pulse is adjusted so $I_{R(\text{peak})}$ is equal to 10 mA.
 3. $t_p \gg t_{rr}$

Figure 1. Recovery Time Equivalent Test Circuit

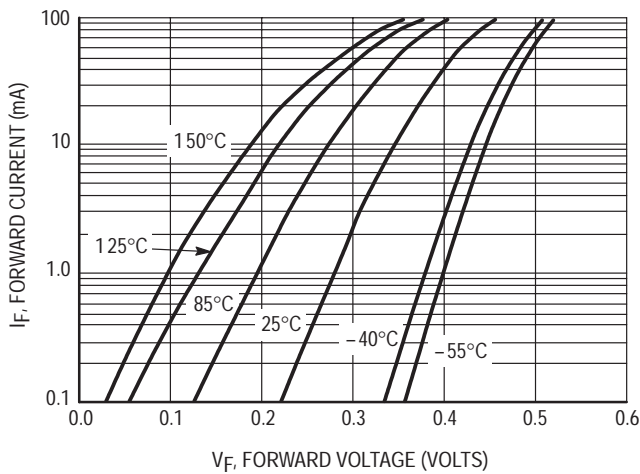


Figure 2. Forward Voltage

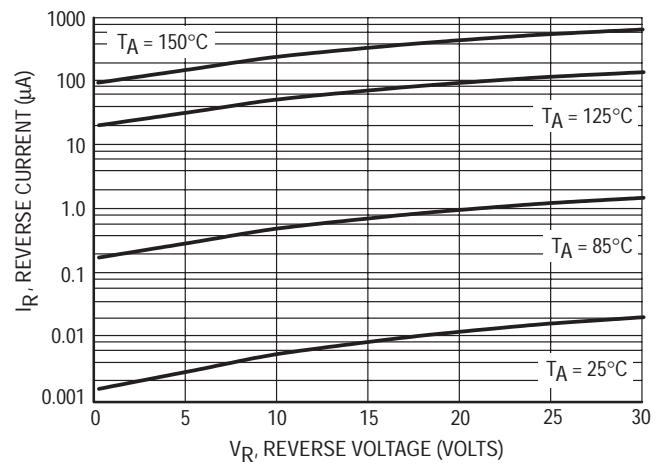


Figure 3. Leakage Current

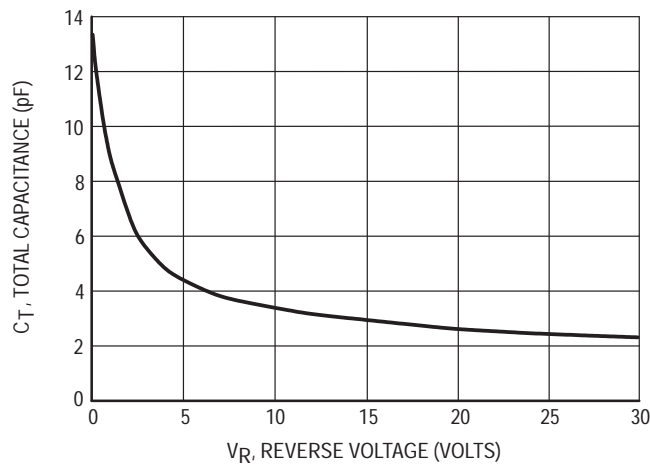
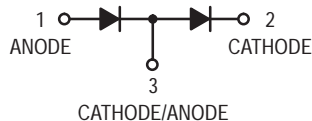


Figure 4. Total Capacitance

Dual Series Schottky Barrier Diodes

These Schottky barrier diodes are designed for high speed switching applications, circuit protection, and voltage clamping. Extremely low forward voltage reduces conduction loss. Miniature surface mount package is excellent for hand held and portable applications where space is limited.

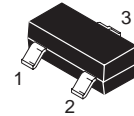
- Extremely Fast Switching Speed
- Low Forward Voltage — 0.35 Volts (Typ) @ $I_F = 10 \text{ mAdc}$



BAT54SLT1

Motorola Preferred Device

**30 VOLTS
DUAL HOT-CARRIER
DETECTOR AND SWITCHING
DIODES**



**CASE 318-08, STYLE 11
SOT-23 (TO-236AB)**

MAXIMUM RATINGS ($T_J = 125^\circ\text{C}$ unless otherwise noted)

Rating	Symbol	Value	Unit
Reverse Voltage	V_R	30	Volts
Forward Power Dissipation @ $T_A = 25^\circ\text{C}$ Derate above 25°C	P_F	225 1.8	mW mW/ $^\circ\text{C}$
Operating Junction Temperature Range	T_J	-55 to +125	$^\circ\text{C}$
Storage Temperature Range	T_{stg}	-55 to +150	$^\circ\text{C}$

DEVICE MARKING

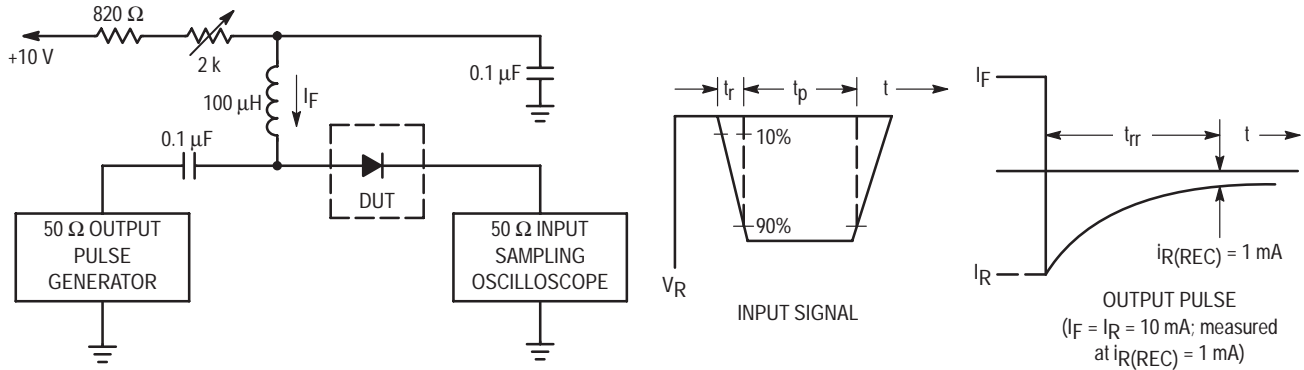
BAT54S = LD3

ELECTRICAL CHARACTERISTICS ($T_A = 25^\circ\text{C}$ unless otherwise noted) (EACH DIODE)

Characteristic	Symbol	Min	Typ	Max	Unit
Reverse Breakdown Voltage ($I_R = 10 \mu\text{A}$)	$V_{(BR)R}$	30	—	—	Volts
Total Capacitance ($V_R = 1.0 \text{ V}$, $f = 1.0 \text{ MHz}$)	C_T	—	7.6	10	pF
Reverse Leakage ($V_R = 25 \text{ V}$)	I_R	—	0.5	2.0	μAdc
Forward Voltage ($I_F = 0.1 \text{ mAdc}$)	V_F	—	0.22	0.24	Vdc
Forward Voltage ($I_F = 30 \text{ mAdc}$)	V_F	—	0.41	0.5	Vdc
Forward Voltage ($I_F = 100 \text{ mAdc}$)	V_F	—	0.52	1.0	Vdc
Reverse Recovery Time ($I_F = I_R = 10 \text{ mAdc}$, $I_{R(REC)} = 1.0 \text{ mAdc}$) Figure 1	t_{rr}	—	—	5.0	ns
Forward Voltage ($I_F = 1.0 \text{ mAdc}$)	V_F	—	0.29	0.32	Vdc
Forward Voltage ($I_F = 10 \text{ mAdc}$)	V_F	—	0.35	0.40	Vdc

Preferred devices are Motorola recommended choices for future use and best overall value.

BAT54SLT1



- Notes: 1. A 2.0 kΩ variable resistor adjusted for a Forward Current (I_F) of 10 mA.
 2. Input pulse is adjusted so $I_{R(\text{peak})}$ is equal to 10 mA.
 3. $t_p \gg t_{rr}$

Figure 1. Recovery Time Equivalent Test Circuit

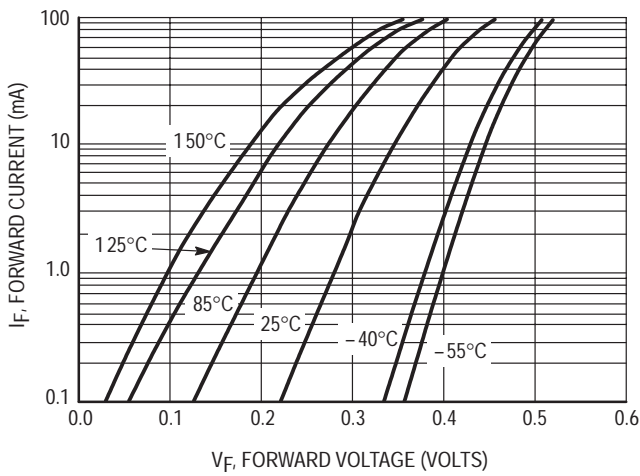


Figure 2. Forward Voltage

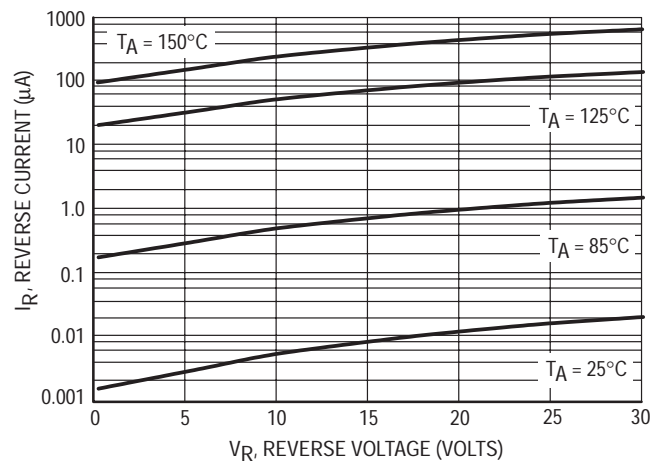


Figure 3. Leakage Current

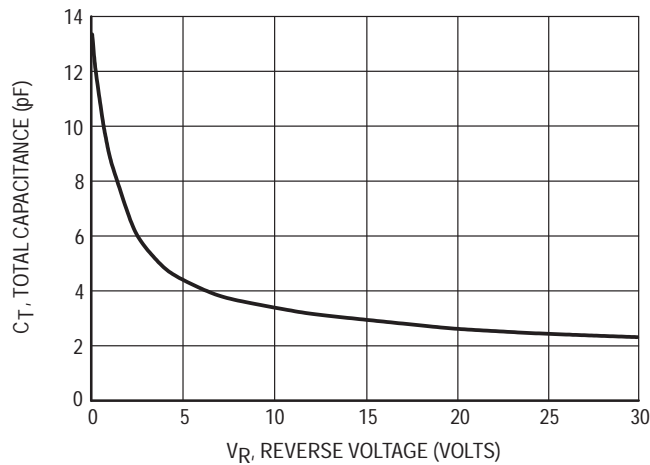
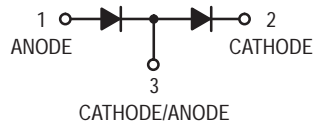


Figure 4. Total Capacitance

Dual Series Schottky Barrier Diodes

These Schottky barrier diodes are designed for high speed switching applications, circuit protection, and voltage clamping. Extremely low forward voltage reduces conduction loss. Miniature surface mount package is excellent for hand held and portable applications where space is limited.

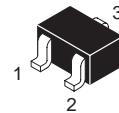
- Extremely Fast Switching Speed
- Low Forward Voltage — 0.35 Volts (Typ) @ $I_F = 10 \text{ mAdc}$



BAT54SWT1

Motorola Preferred Device

**30 VOLT
DUAL SERIES
SCHOTTKY BARRIER
DIODES**



**CASE 419-02, STYLE 9
SOT-323 (SC-70)**

MAXIMUM RATINGS ($T_J = 125^\circ\text{C}$ unless otherwise noted)

Rating	Symbol	Value	Unit
Reverse Voltage	V_R	30	Volts
Forward Power Dissipation @ $T_A = 25^\circ\text{C}$ Derate above 25°C	P_F	200 1.6	mW mW/ $^\circ\text{C}$
Operating Junction Temperature Range	T_J	-55 to +150	$^\circ\text{C}$
Storage Temperature Range	T_{stg}	-55 to +150	$^\circ\text{C}$

DEVICE MARKING

BAT54SWT1 = B8

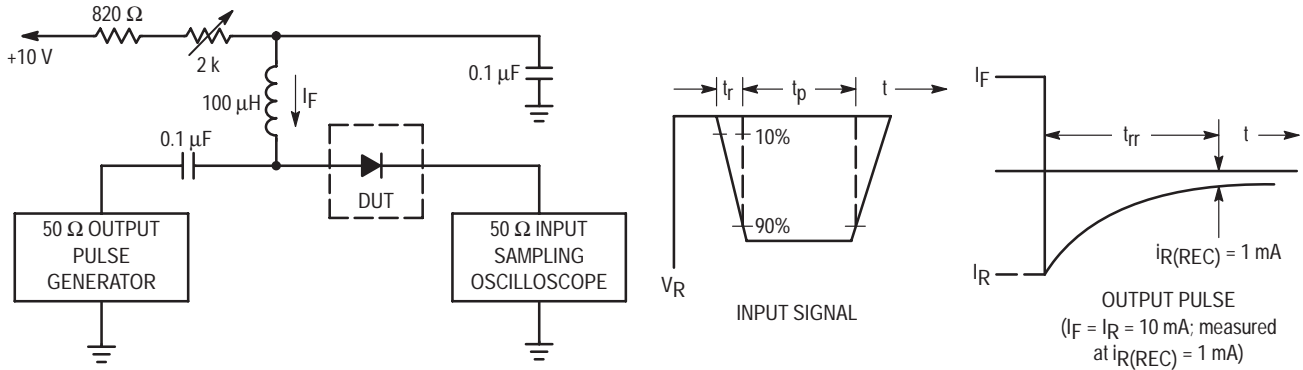
ELECTRICAL CHARACTERISTICS ($T_A = 25^\circ\text{C}$ unless otherwise noted) (EACH DIODE)

Characteristic	Symbol	Min	Typ	Max	Unit
Reverse Breakdown Voltage ($I_R = 10 \mu\text{A}$)	$V_{(BR)R}$	30	—	—	Volts
Total Capacitance ($V_R = 1.0 \text{ V}$, $f = 1.0 \text{ MHz}$)	C_T	—	7.6	10	pF
Reverse Leakage ($V_R = 25 \text{ V}$)	I_R	—	0.5	2.0	μAdc
Forward Voltage ($I_F = 0.1 \text{ mAdc}$)	V_F	—	0.22	0.24	Vdc
Forward Voltage ($I_F = 30 \text{ mAdc}$)	V_F	—	0.41	0.5	Vdc
Forward Voltage ($I_F = 100 \text{ mAdc}$)	V_F	—	0.52	1.0	Vdc
Reverse Recovery Time ($I_F = I_R = 10 \text{ mAdc}$, $I_{R(REC)} = 1.0 \text{ mAdc}$) Figure 1	t_{rr}	—	—	5.0	ns
Forward Voltage ($I_F = 1.0 \text{ mAdc}$)	V_F	—	0.29	0.32	Vdc
Forward Voltage ($I_F = 10 \text{ mAdc}$)	V_F	—	0.35	0.40	Vdc

Preferred devices are Motorola recommended choices for future use and best overall value.

REV 1

BAT54SWT1



- Notes: 1. A 2.0 kΩ variable resistor adjusted for a Forward Current (I_F) of 10 mA.
 2. Input pulse is adjusted so $I_{R(peak)}$ is equal to 10 mA.
 3. $t_p \gg t_{rr}$

Figure 1. Recovery Time Equivalent Test Circuit

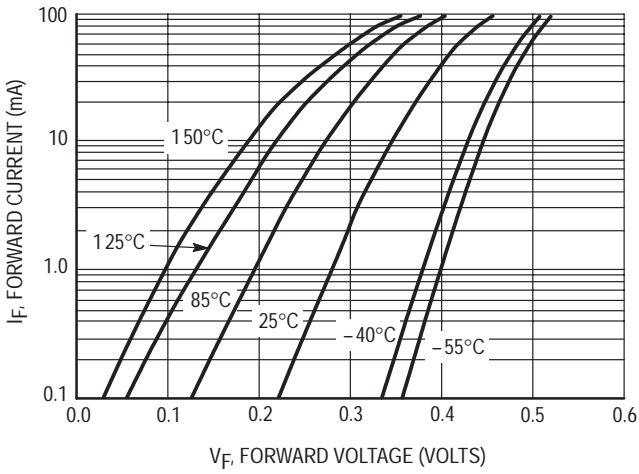


Figure 2. Forward Voltage

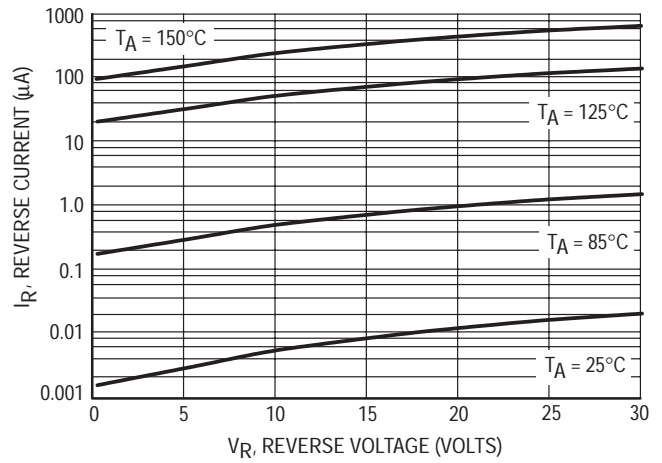


Figure 3. Leakage Current

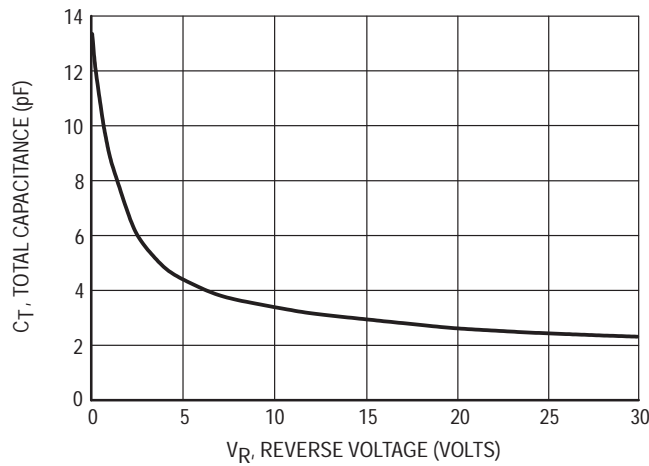


Figure 4. Total Capacitance

Schottky Barrier Diode

These Schottky barrier diodes are designed for high speed switching applications, circuit protection, and voltage clamping. Extremely low forward voltage reduces conduction loss. Miniature surface mount package is excellent for hand held and portable applications where space is limited.

- Extremely Fast Switching Speed
- Low Forward Voltage — 0.35 Volts (Typ) @ $I_F = 10$ mAdc



BAT54T1

Motorola Preferred Device

**30 VOLT
SCHOTTKY BARRIER
DETECTOR AND SWITCHING
DIODE**



**CASE 425-04, STYLE 1
SOD-123**

MAXIMUM RATINGS ($T_J = 125^\circ\text{C}$ unless otherwise noted)

Rating	Symbol	Value	Unit
Reverse Voltage	V_R	30	Volts
Forward Power Dissipation @ $T_A = 25^\circ\text{C}$ Derate above 25°C	P_F	400 3.2	mW mW/ $^\circ\text{C}$
Operating Junction Temperature Range	T_J	-55 to +150	$^\circ\text{C}$
Storage Temperature Range	T_{stg}	-55 to +150	$^\circ\text{C}$

DEVICE MARKING

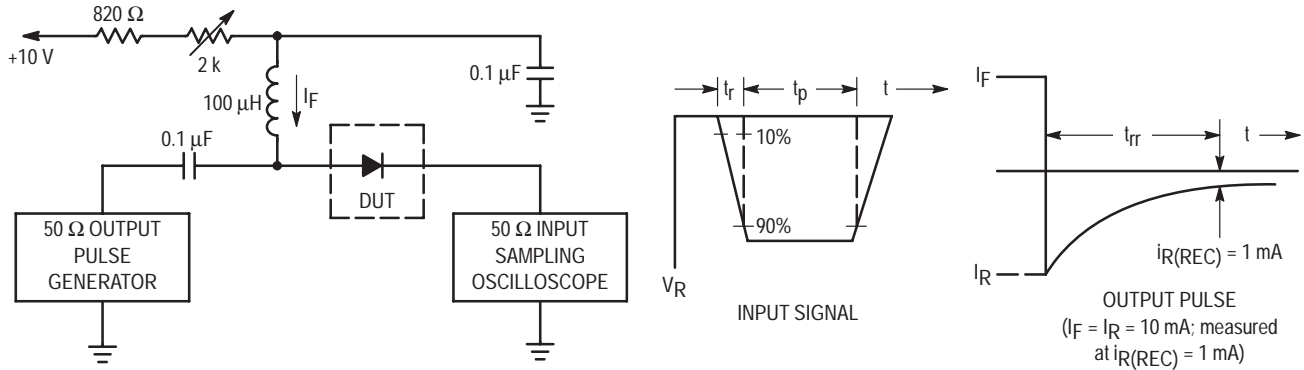
BAT54T1 = BU

ELECTRICAL CHARACTERISTICS ($T_A = 25^\circ\text{C}$ unless otherwise noted)

Characteristic	Symbol	Min	Typ	Max	Unit
Reverse Breakdown Voltage ($I_R = 10 \mu\text{A}$)	$V_{(BR)R}$	30	—	—	Volts
Total Capacitance ($V_R = 1.0$ V, $f = 1.0$ MHz)	C_T	—	7.6	10	pF
Reverse Leakage ($V_R = 25$ V)	I_R	—	0.5	2.0	μAdc
Forward Voltage ($I_F = 0.1$ mAdc)	V_F	—	0.22	0.24	Vdc
Forward Voltage ($I_F = 30$ mAdc)	V_F	—	0.41	0.5	Vdc
Forward Voltage ($I_F = 100$ mAdc)	V_F	—	0.52	1.0	Vdc
Reverse Recovery Time ($I_F = I_R = 10$ mAdc, $I_{R(REC)} = 1.0$ mAdc) Figure 1	t_{rr}	—	—	5.0	ns
Forward Voltage ($I_F = 1.0$ mAdc)	V_F	—	0.29	0.32	Vdc
Forward Voltage ($I_F = 10$ mAdc)	V_F	—	0.35	0.40	Vdc

Preferred devices are Motorola recommended choices for future use and best overall value.

BAT54T1



- Notes: 1. A 2.0 kΩ variable resistor adjusted for a Forward Current (I_F) of 10 mA.
- 2. Input pulse is adjusted so $I_{R(peak)}$ is equal to 10 mA.
- 3. $t_p \gg t_{rr}$

Figure 1. Recovery Time Equivalent Test Circuit

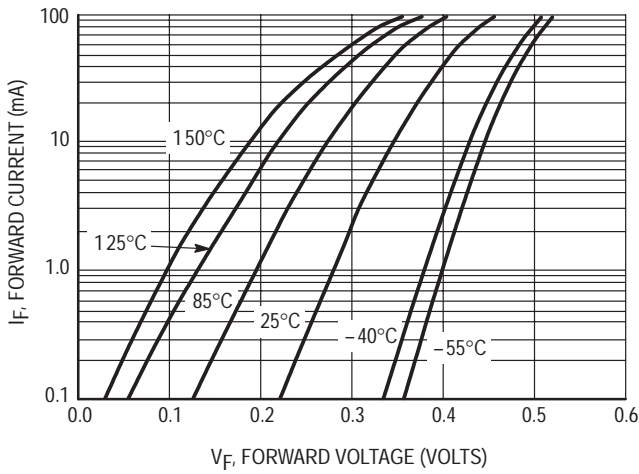


Figure 2. Forward Voltage

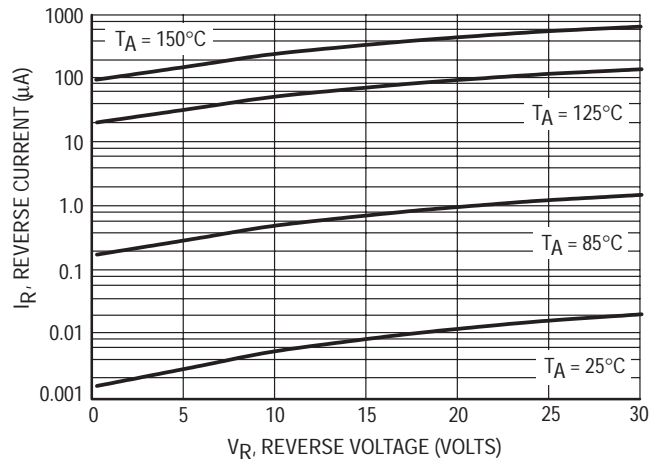


Figure 3. Leakage Current

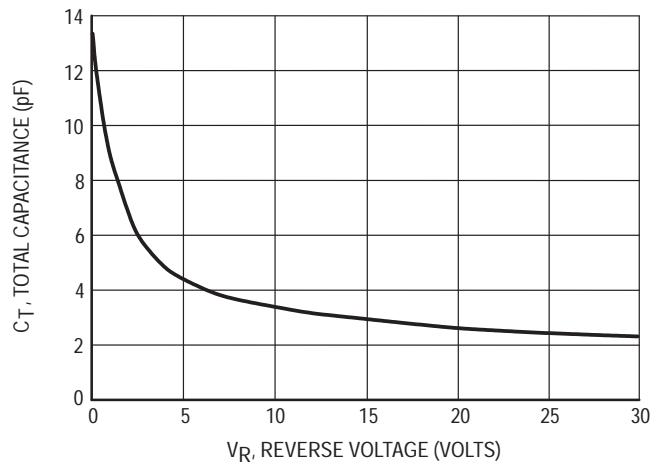


Figure 4. Total Capacitance

Schottky Barrier Diode

These Schottky barrier diodes are designed for high speed switching applications, circuit protection, and voltage clamping. Extremely low forward voltage reduces conduction loss. Miniature surface mount package is excellent for hand held and portable applications where space is limited.

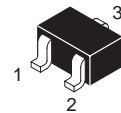
- Extremely Fast Switching Speed
- Extremely Low Forward Voltage — 0.35 Volts (Typ) @ $I_F = 10$ mAdc



BAT54WT1

Motorola Preferred Device

**30 VOLTS
SCHOTTKY BARRIER
DETECTOR AND SWITCHING
DIODE**



**CASE 419-02, STYLE 2
SOT-323 (SC-70)**

MAXIMUM RATINGS ($T_J = 125^\circ\text{C}$ unless otherwise noted)

Rating	Symbol	Value	Unit
Reverse Voltage	V_R	30	Volts
Forward Power Dissipation @ $T_A = 25^\circ\text{C}$ Derate above 25°C	P_F	200 1.6	mW mW/ $^\circ\text{C}$
Operating Junction Temperature Range	T_J	-55 to +150	$^\circ\text{C}$
Storage Temperature Range	T_{stg}	-55 to +150	$^\circ\text{C}$

DEVICE MARKING

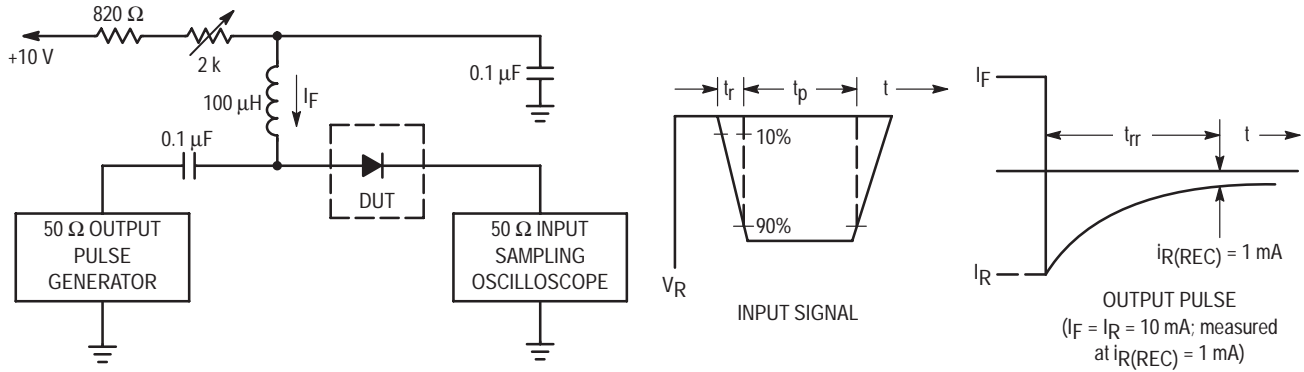
BAT54WT1 = B4

ELECTRICAL CHARACTERISTICS ($T_A = 25^\circ\text{C}$ unless otherwise noted)

Characteristic	Symbol	Min	Typ	Max	Unit
Reverse Breakdown Voltage ($I_R = 10 \mu\text{A}$)	$V_{(BR)R}$	30	—	—	Volts
Total Capacitance ($V_R = 1.0 \text{ V}$, $f = 1.0 \text{ MHz}$)	C_T	—	7.6	10	pF
Reverse Leakage ($V_R = 25 \text{ V}$)	I_R	—	0.5	2.0	μAdc
Forward Voltage ($I_F = 0.1 \text{ mAdc}$)	V_F	—	0.22	0.24	Vdc
Forward Voltage ($I_F = 30 \text{ mAdc}$)	V_F	—	0.41	0.5	Vdc
Forward Voltage ($I_F = 100 \text{ mAdc}$)	V_F	—	0.52	1.0	Vdc
Reverse Recovery Time ($I_F = I_R = 10 \text{ mAdc}$, $I_{R(REC)} = 1.0 \text{ mAdc}$) Figure 1	t_{rr}	—	—	5.0	ns
Forward Voltage ($I_F = 1.0 \text{ mAdc}$)	V_F	—	0.29	0.32	Vdc
Forward Voltage ($I_F = 10 \text{ mAdc}$)	V_F	—	0.35	0.40	Vdc

Preferred devices are Motorola recommended choices for future use and best overall value.

BAT54WT1



- Notes: 1. A 2.0 kΩ variable resistor adjusted for a Forward Current (I_F) of 10 mA.
 2. Input pulse is adjusted so $I_{R(peak)}$ is equal to 10 mA.
 3. $t_p \gg t_{rr}$

Figure 1. Recovery Time Equivalent Test Circuit

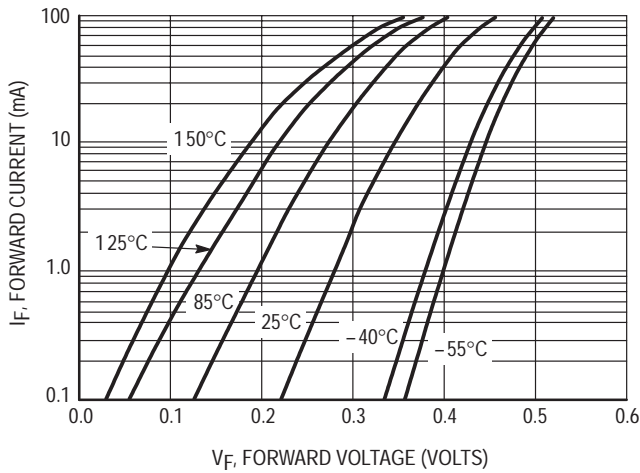


Figure 2. Forward Voltage

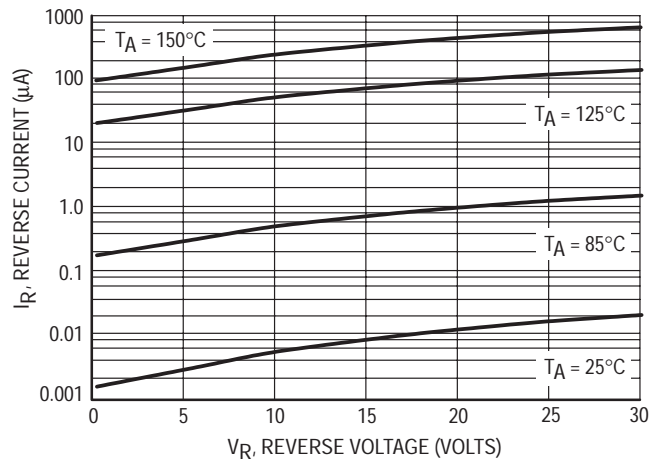


Figure 3. Leakage Current

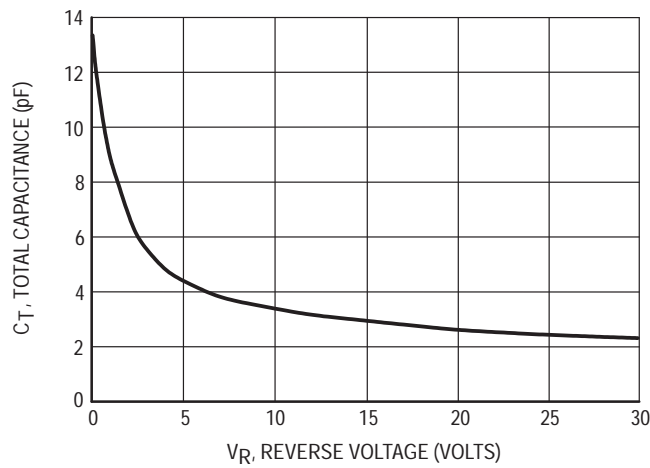
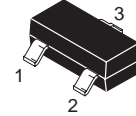
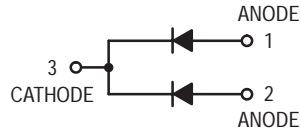


Figure 4. Total Capacitance

Monolithic Dual Switching Diode Common Cathode

BAV70LT1

Motorola Preferred Device



CASE 318-08, STYLE 9
SOT-23 (TO-236AB)

MAXIMUM RATINGS (EACH DIODE)

Rating	Symbol	Value	Unit
Reverse Voltage	V_R	70	Vdc
Forward Current	I_F	200	mAdc
Peak Forward Surge Current	$I_{FM}(\text{surge})$	500	mAdc

THERMAL CHARACTERISTICS

Characteristic	Symbol	Max	Unit
Total Device Dissipation FR-5 Board ⁽¹⁾ $T_A = 25^\circ\text{C}$ Derate above 25°C	P_D	225 1.8	mW mW/ $^\circ\text{C}$
Thermal Resistance, Junction to Ambient	$R_{\theta JA}$	556	$^\circ\text{C}/\text{W}$
Total Device Dissipation Alumina Substrate, ⁽²⁾ $T_A = 25^\circ\text{C}$ Derate above 25°C	P_D	300 2.4	mW mW/ $^\circ\text{C}$
Thermal Resistance, Junction to Ambient	$R_{\theta JA}$	417	$^\circ\text{C}/\text{W}$
Junction and Storage Temperature	T_J, T_{stg}	-55 to +150	$^\circ\text{C}$

DEVICE MARKING

BAV70LT1 = A4

ELECTRICAL CHARACTERISTICS ($T_A = 25^\circ\text{C}$ unless otherwise noted) (EACH DIODE)

Characteristic	Symbol	Min	Max	Unit
----------------	--------	-----	-----	------

OFF CHARACTERISTICS

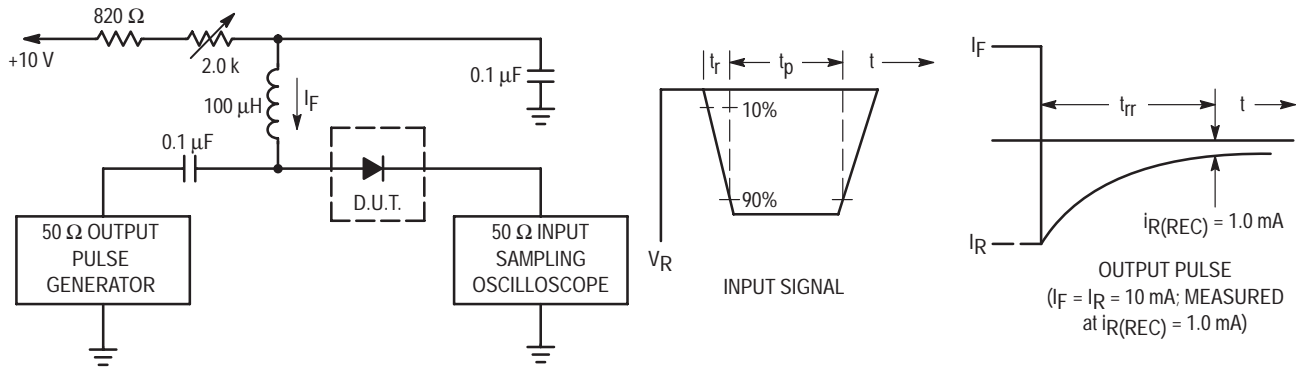
Reverse Breakdown Voltage ($I_{BR} = 100 \mu\text{Adc}$)	$V_{(BR)}$	70	—	Vdc
Reverse Voltage Leakage Current ($V_R = 25 \text{ Vdc}, T_J = 150^\circ\text{C}$) ($V_R = 70 \text{ Vdc}$) ($V_R = 70 \text{ Vdc}, T_J = 150^\circ\text{C}$)	I_R	— — —	60 2.5 100	μAdc
Diode Capacitance ($V_R = 0, f = 1.0 \text{ MHz}$)	C_D	—	1.5	pF
Forward Voltage ($I_F = 1.0 \text{ mAdc}$) ($I_F = 10 \text{ mAdc}$) ($I_F = 50 \text{ mAdc}$) ($I_F = 150 \text{ mAdc}$)	V_F	— — — —	715 855 1000 1250	mVdc
Reverse Recovery Time $R_L = 100 \Omega$ ($I_F = I_R = 10 \text{ mAdc}, V_R = 5.0 \text{ Vdc}, I_{R(REC)} = 1.0 \text{ mAdc}$) (Figure 1)	t_{rr}	—	6.0	ns

1. FR-5 = $1.0 \times 0.75 \times 0.062 \text{ in.}$

2. Alumina = $0.4 \times 0.3 \times 0.024 \text{ in.}$ 99.5% alumina.

Preferred devices are Motorola recommended choices for future use and best overall value.

BAV70LT1



- Notes: 1. A 2.0 kΩ variable resistor adjusted for a Forward Current (I_F) of 10 mA.
- 2. Input pulse is adjusted so $I_{R(peak)}$ is equal to 10 mA.
- 3. $t_p \gg t_{rr}$

Figure 1. Recovery Time Equivalent Test Circuit

Curves Applicable to Each Anode

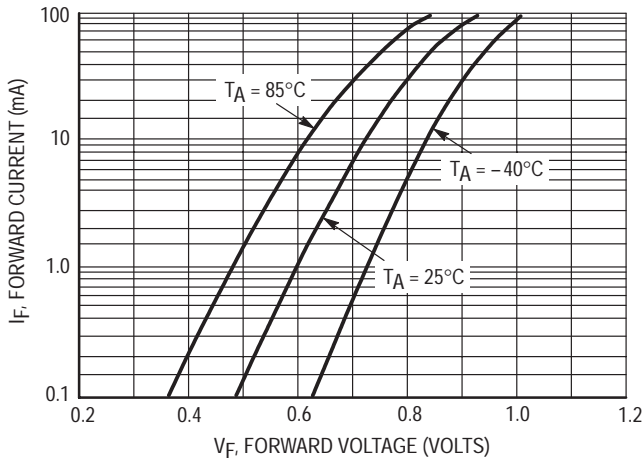


Figure 2. Forward Voltage

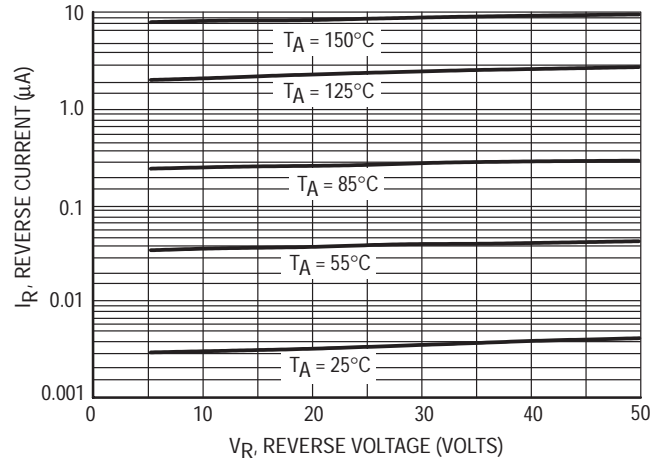


Figure 3. Leakage Current

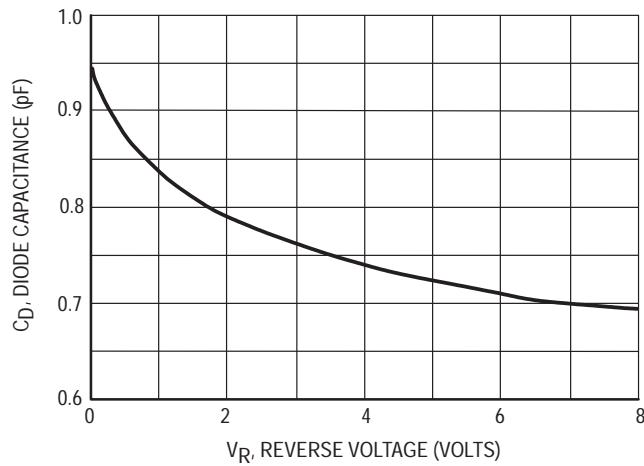
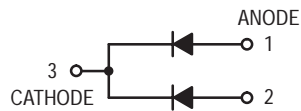


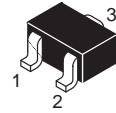
Figure 4. Capacitance

Dual Switching Diode



BAV70WT1

Motorola Preferred Device



CASE 419-02, STYLE 5
SC-70/SOT-323

MAXIMUM RATINGS ($T_A = 25^\circ\text{C}$)

Rating	Symbol	Max	Unit
Reverse Voltage	V_R	70	Vdc
Forward Current	I_F	200	mAdc
Peak Forward Surge Current	$I_{FM}(\text{surge})$	500	mAdc

THERMAL CHARACTERISTICS

Characteristic	Symbol	Max	Unit
Total Device Dissipation FR-5 Board ⁽¹⁾ $T_A = 25^\circ\text{C}$ Derate above 25°C	P_D	200	mW
		1.6	mW/ $^\circ\text{C}$
Thermal Resistance, Junction to Ambient	$R_{\theta JA}$	0.625	$^\circ\text{C}/\text{W}$
Total Device Dissipation Alumina Substrate ⁽²⁾ $T_A = 25^\circ\text{C}$ Derate above 25°C	P_D	300	mW
		2.4	mW/ $^\circ\text{C}$
Thermal Resistance, Junction to Ambient	$R_{\theta JA}$	417	$^\circ\text{C}/\text{W}$
Junction and Storage Temperature	T_J, T_{stg}	-55 to +150	$^\circ\text{C}$

DEVICE MARKING

BAV70WT1 = A4

ELECTRICAL CHARACTERISTICS ($T_A = 25^\circ\text{C}$ unless otherwise noted)

Characteristic	Symbol	Min	Max	Unit
----------------	--------	-----	-----	------

OFF CHARACTERISTICS

Reverse Breakdown Voltage ($I_{BR} = 100 \mu\text{Adc}$)	$V_{(BR)}$	70	—	Vdc
Reverse Voltage Leakage Current ($V_R = 70 \text{ Vdc}$) ($V_R = 50 \text{ Vdc}$)	I_{R1} I_{R2}	—	5.0 100	μAdc nAdc
Diode Capacitance ($V_R = 0, f = 1.0 \text{ MHz}$)	C_D	—	1.5	pF
Forward Voltage ($I_F = 1.0 \text{ mAdc}$) ($I_F = 10 \text{ mAdc}$) ($I_F = 50 \text{ mAdc}$) ($I_F = 150 \text{ mAdc}$)	V_F	—	715 855 1000 1250	mVdc
Reverse Recovery Time ($I_F = I_R = 10 \text{ mAdc}, R_L = 100 \Omega, I_{R(REC)} = 1.0 \text{ mAdc}$) (Figure 1)	t_{rr}	—	6.0	ns
Forward Recovery Voltage ($I_F = 10 \text{ mAdc}, t_r = 20 \text{ ns}$) (Figure 2)	V_{RF}	—	1.75	V

1. FR-5 = $1.0 \times 0.75 \times 0.062 \text{ in.}$

2. Alumina = $0.4 \times 0.3 \times 0.024 \text{ in.}$ 99.5% alumina.

Preferred devices are Motorola recommended choices for future use and best overall value.

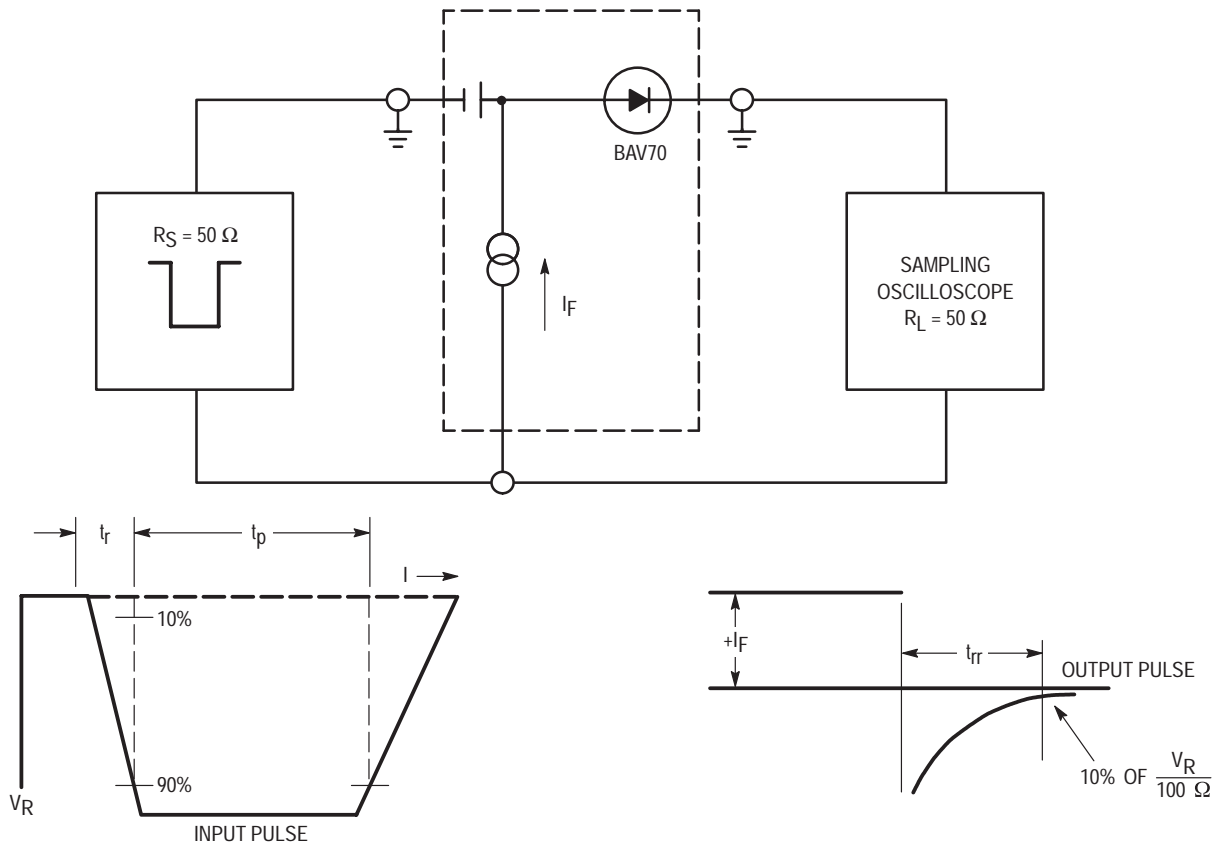


Figure 1. Recovery Time Equivalent Test Circuit

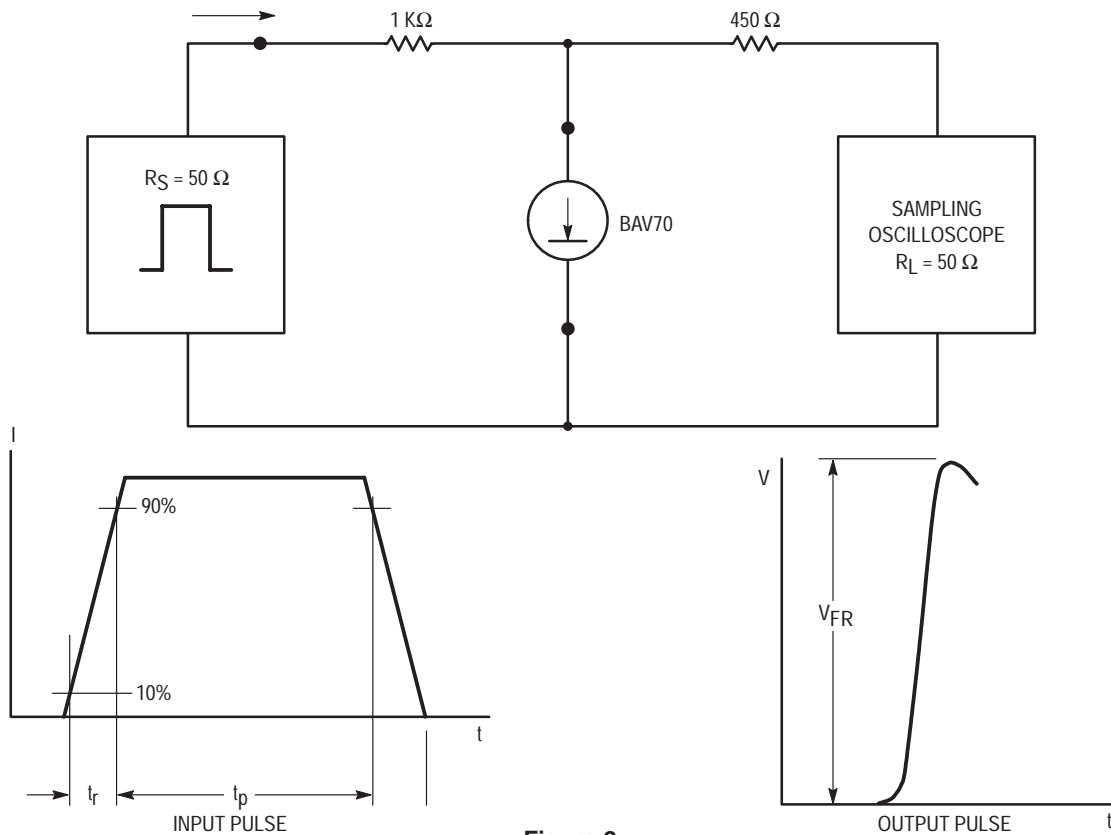


Figure 2.

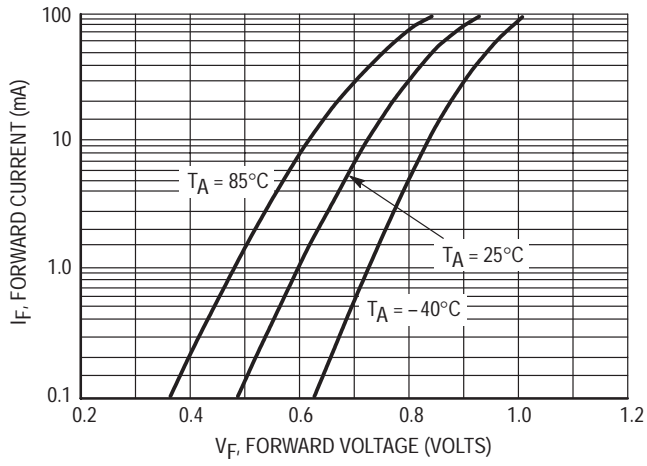


Figure 3. Forward Voltage

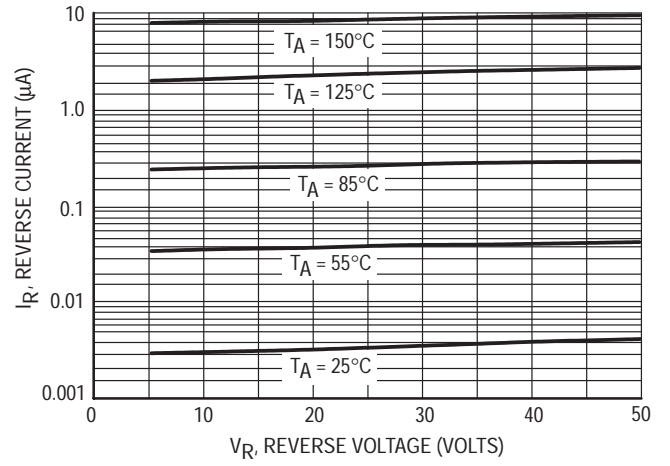


Figure 4. Leakage Current

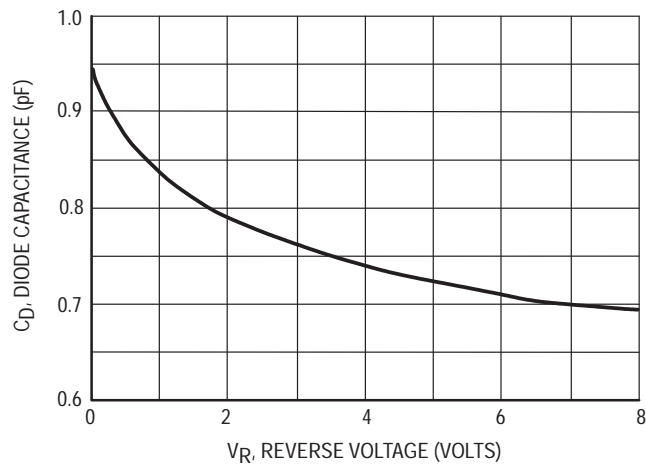
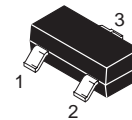
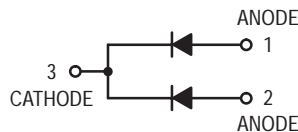


Figure 5. Capacitance

Monolithic Dual Switching Diode

BAV74LT1



CASE 318-08, STYLE 9
SOT-23 (TO-236AB)

MAXIMUM RATINGS (EACH DIODE)

Rating	Symbol	Value	Unit
Reverse Voltage	V_R	50	Vdc
Forward Current	I_F	200	mAdc
Peak Forward Surge Current	$I_{FM}(\text{surge})$	500	mAdc

THERMAL CHARACTERISTICS

Characteristic	Symbol	Max	Unit
Total Device Dissipation FR-5 Board ⁽¹⁾ $T_A = 25^\circ\text{C}$ Derate above 25°C	P_D	225	mW
		1.8	mW/ $^\circ\text{C}$
Thermal Resistance, Junction to Ambient	$R_{\theta JA}$	556	$^\circ\text{C}/\text{W}$
Total Device Dissipation Alumina Substrate, ⁽²⁾ $T_A = 25^\circ\text{C}$ Derate above 25°C	P_D	300	mW
		2.4	mW/ $^\circ\text{C}$
Thermal Resistance, Junction to Ambient	$R_{\theta JA}$	417	$^\circ\text{C}/\text{W}$
Junction and Storage Temperature	T_J, T_{stg}	-55 to +150	$^\circ\text{C}$

DEVICE MARKING

BAV74LT1 = JA

ELECTRICAL CHARACTERISTICS ($T_A = 25^\circ\text{C}$ unless otherwise noted) (EACH DIODE)

Characteristic	Symbol	Min	Max	Unit
----------------	--------	-----	-----	------

OFF CHARACTERISTICS

Reverse Breakdown Voltage ($I_{(BR)} = 5.0 \mu\text{Adc}$)	$V_{(BR)}$	50	—	Vdc
Reverse Voltage Leakage Current ($V_R = 50 \text{ Vdc}, T_J = 125^\circ\text{C}$) ($V_R = 50 \text{ Vdc}$)	I_R	—	100 0.1	μAdc
Diode Capacitance ($V_R = 0, f = 1.0 \text{ MHz}$)	C_D	—	2.0	pF
Forward Voltage ($I_F = 100 \text{ mAdc}$)	V_F	—	1.0	Vdc
Reverse Recovery Time ($I_F = I_R = 10 \text{ mAdc}, I_{R(REC)} = 1.0 \text{ mAdc}$, measured at $I_R = 1.0 \text{ mA}, R_L = 100 \Omega$)	t_{rr}	—	4.0	ns

1. FR-5 = $1.0 \times 0.75 \times 0.062 \text{ in.}$

2. Alumina = $0.4 \times 0.3 \times 0.024 \text{ in. } 99.5\% \text{ alumina.}$

Curves Applicable to Each Anode

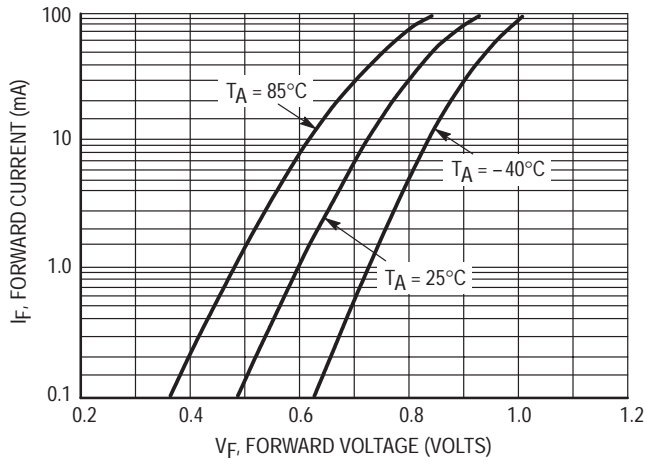


Figure 1. Forward Voltage

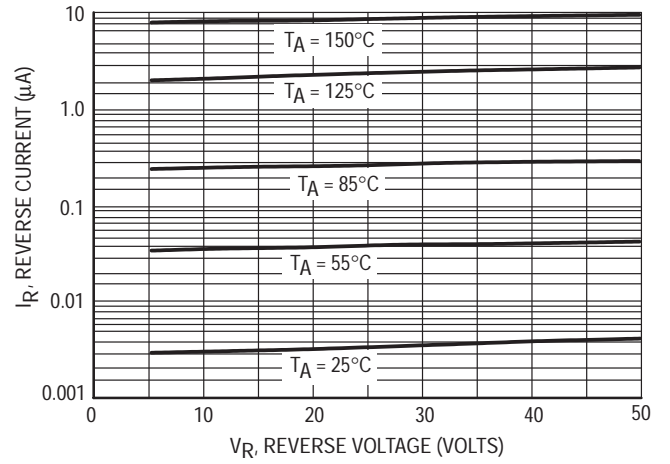


Figure 2. Leakage Current

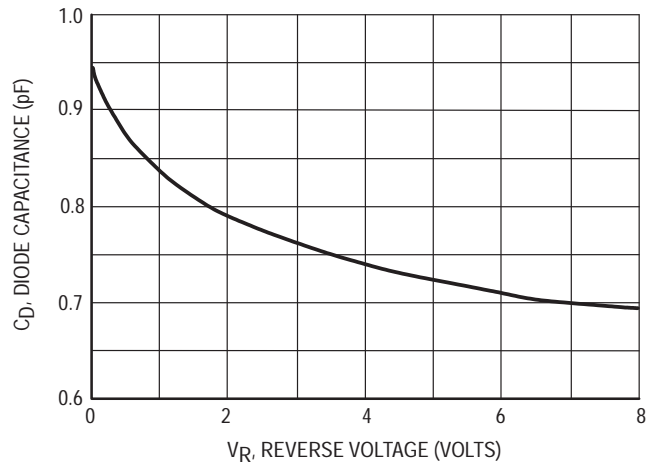
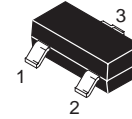


Figure 3. Capacitance

Dual Series Switching Diode

BAV99LT1

Motorola Preferred Device



CASE 318-08, STYLE 11
SOT-23 (TO-236AB)

MAXIMUM RATINGS (EACH DIODE)

Rating	Symbol	Value	Unit
Reverse Voltage	V_R	70	Vdc
Forward Current	I_F	215	mAdc
Peak Forward Surge Current	$I_{FM(surge)}$	500	mAdc
Repetitive Peak Reverse Voltage	V_{RRM}	70	V
Average Rectified Forward Current ⁽¹⁾ (averaged over any 20 ms period)	$I_{F(AV)}$	715	mA
Repetitive Peak Forward Current	I_{FRM}	450	mA
Non-Repetitive Peak Forward Current	I_{FSM}		A
t = 1.0 μ s		2.0	
t = 1.0 ms		1.0	
t = 1.0 S		0.5	

THERMAL CHARACTERISTICS

Characteristic	Symbol	Max	Unit
Total Device Dissipation FR-5 Board, ⁽¹⁾ $T_A = 25^\circ\text{C}$ Derate above 25°C	P_D	225	mW
		1.8	mW/ $^\circ\text{C}$
Thermal Resistance Junction to Ambient	$R_{\theta JA}$	556	$^\circ\text{C}/\text{W}$
Total Device Dissipation Alumina Substrate, ⁽²⁾ $T_A = 25^\circ\text{C}$ Derate above 25°C	P_D	300	mW
		2.4	mW/ $^\circ\text{C}$
Thermal Resistance Junction to Ambient	$R_{\theta JA}$	417	$^\circ\text{C}/\text{W}$
Junction and Storage Temperature	T_J, T_{stg}	-65 to +150	$^\circ\text{C}$

DEVICE MARKING

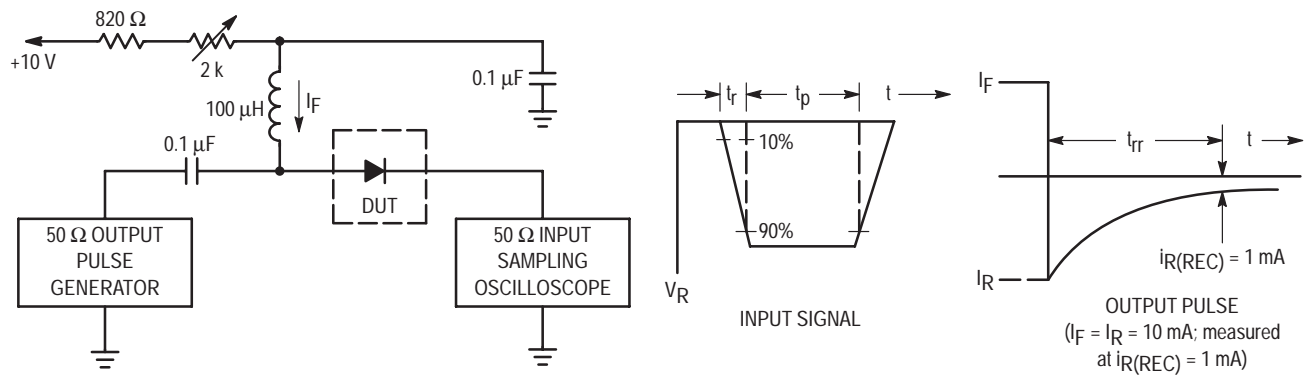
BAV99LT1 = A7

- FR-5 = 1.0 x 0.75 x 0.062 in.
- Alumina = 0.4 x 0.3 x 0.024 in. 99.5% alumina

Preferred devices are Motorola recommended choices for future use and best overall value.

ELECTRICAL CHARACTERISTICS ($T_A = 25^\circ\text{C}$ unless otherwise noted) (Continued) **(EACH DIODE)**

Characteristic	Symbol	Min	Max	Unit
OFF CHARACTERISTICS				
Reverse Breakdown Voltage ($I_{(BR)} = 100 \mu\text{A}$)	$V_{(BR)}$	70	—	Vdc
Reverse Voltage Leakage Current ($V_R = 70 \text{ Vdc}$)	I_R	—	2.5	μA dc
($V_R = 25 \text{ Vdc}, T_J = 150^\circ\text{C}$)		—	30	
($V_R = 70 \text{ Vdc}, T_J = 150^\circ\text{C}$)		—	50	
Diode Capacitance ($V_R = 0, f = 1.0 \text{ MHz}$)	C_D	—	1.5	pF
Forward Voltage ($I_F = 1.0 \text{ mA}$ dc)	V_F	—	715	mVdc
($I_F = 10 \text{ mA}$ dc)		—	855	
($I_F = 50 \text{ mA}$ dc)		—	1000	
($I_F = 150 \text{ mA}$ dc)		—	1250	
Reverse Recovery Time ($I_F = I_R = 10 \text{ mA}$ dc, $i_{R(REC)} = 1.0 \text{ mA}$ dc) (Figure 1) $R_L = 100\Omega$	t_{rr}	—	6.0	ns
Forward Recovery Voltage ($I_F = 10 \text{ mA}, t_r = 20 \text{ ns}$)	V_{FR}	—	1.75	V



- Notes: 1. A 2.0 kΩ variable resistor adjusted for a Forward Current (I_F) of 10 mA.
 2. Input pulse is adjusted so $I_{R(\text{peak})}$ is equal to 10 mA.
 3. $t_p \gg t_{rr}$

Figure 1. Recovery Time Equivalent Test Circuit

CURVES APPLICABLE TO EACH DIODE

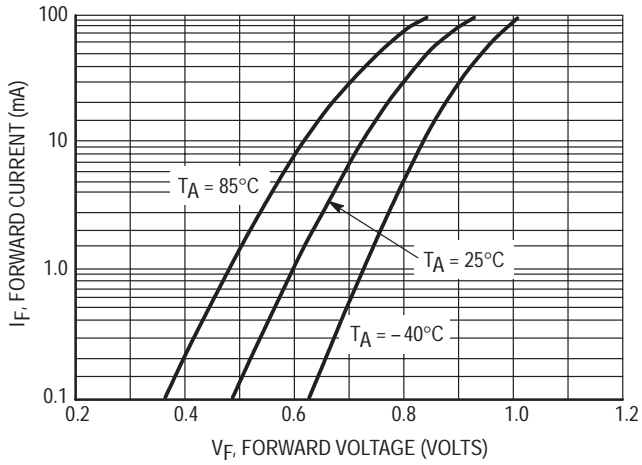


Figure 2. Forward Voltage

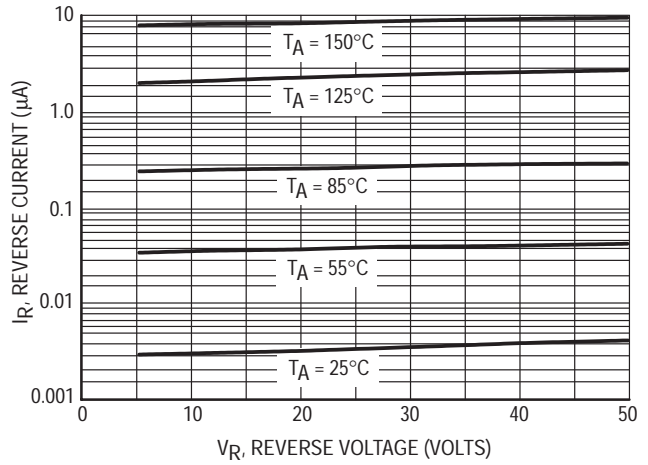


Figure 3. Leakage Current

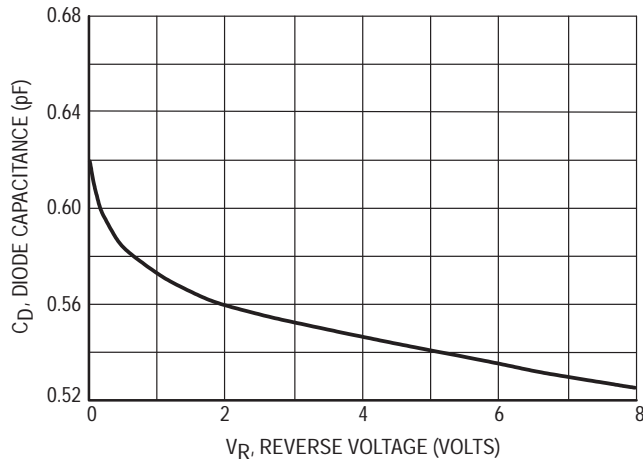


Figure 4. Capacitance

SC-70/SOT-323 Dual Series Switching Diode

The BAV99WT1 is a smaller package, equivalent to the BAV99LT1.

Suggested Applications

- ESD Protection
- Polarity Reversal Protection
- Data Line Protection
- Inductive Load Protection
- Steering Logic

MAXIMUM RATINGS (EACH DIODE)

Rating	Symbol	Value	Unit
Reverse Voltage	V_R	70	Vdc
Forward Current	I_F	215	mAdc
Peak Forward Surge Current	$I_{FM}(\text{surge})$	500	mAdc
Repetitive Peak Reverse Voltage	V_{RRM}	70	V
Average Rectified Forward Current ⁽¹⁾ (averaged over any 20 ms period)	$I_{F(AV)}$	715	mA
Repetitive Peak Forward Current	I_{FRM}	450	mA
Non-Repetitive Peak Forward Current	I_{FSM}		A
t = 1.0 μ s		2.0	
t = 1.0 ms		1.0	
t = 1.0 S		0.5	

DEVICE MARKING

BAV99WT1 = A7
BAV99RWT1 = F7

THERMAL CHARACTERISTICS

Characteristic	Symbol	Max	Unit
Total Device Dissipation FR-5 Board, ⁽¹⁾ $T_A = 25^\circ\text{C}$ Derate above 25°C	P_D	200	mW
		1.6	mW/ $^\circ\text{C}$
Thermal Resistance Junction to Ambient	$R_{\theta JA}$	625	$^\circ\text{C/W}$
Total Device Dissipation Alumina Substrate, ⁽²⁾ $T_A = 25^\circ\text{C}$ Derate above 25°C	P_D	300	mW
		2.4	mW/ $^\circ\text{C}$
Thermal Resistance Junction to Ambient	$R_{\theta JA}$	417	$^\circ\text{C/W}$
Junction and Storage Temperature	T_J, T_{stg}	-65 to +150	$^\circ\text{C}$

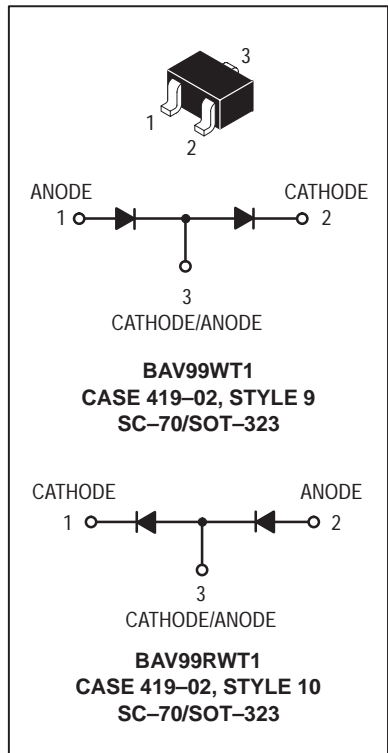
1. FR-5 = $1.0 \times 0.75 \times 0.062$ in.

2. Alumina = $0.4 \times 0.3 \times 0.024$ in. 99.5% alumina.

Preferred devices are Motorola recommended choices for future use and best overall value.

BAV99WT1 BAV99RWT1

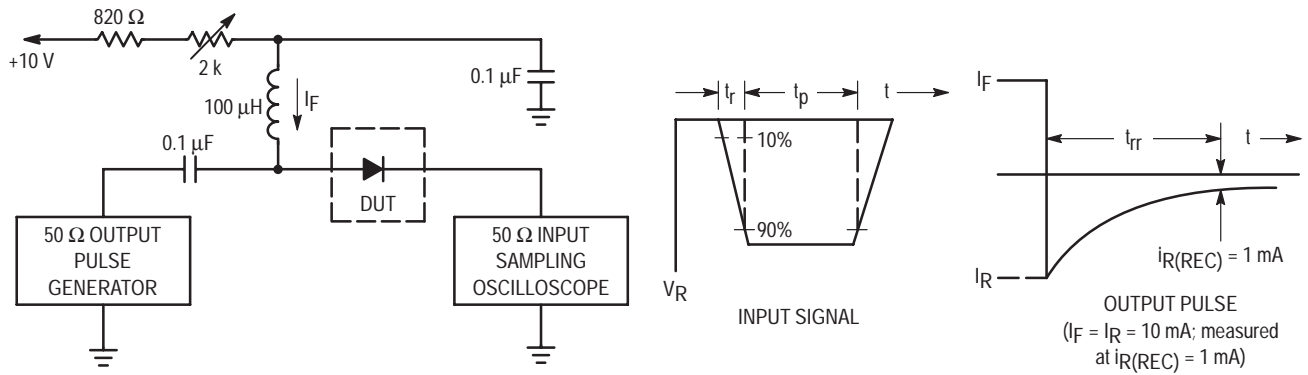
Motorola Preferred Devices



BAV99WT1 BAV99RWT1

ELECTRICAL CHARACTERISTICS ($T_A = 25^\circ\text{C}$ unless otherwise noted) (EACH DIODE)

Characteristic	Symbol	Min	Max	Unit
OFF CHARACTERISTICS				
Reverse Breakdown Voltage ($I_{(BR)} = 100 \mu\text{A}$)	$V_{(BR)}$	70	—	Vdc
Reverse Voltage Leakage Current ($V_R = 70 \text{ Vdc}$)	I_R	—	2.5	μAdc
($V_R = 25 \text{ Vdc}, T_J = 150^\circ\text{C}$)		—	30	
($V_R = 70 \text{ Vdc}, T_J = 150^\circ\text{C}$)		—	50	
Diode Capacitance ($V_R = 0, f = 1.0 \text{ MHz}$)	C_D	—	1.5	pF
Forward Voltage ($I_F = 1.0 \text{ mAdc}$)	V_F	—	715	mVdc
($I_F = 10 \text{ mAdc}$)		—	855	
($I_F = 50 \text{ mAdc}$)		—	1000	
($I_F = 150 \text{ mAdc}$)		—	1250	
Reverse Recovery Time ($I_F = I_R = 10 \text{ mAdc}, i_{R(REC)} = 1.0 \text{ mAdc}$) (Figure 1) $R_L = 100 \Omega$	t_{rr}	—	6.0	ns
Forward Recovery Voltage ($I_F = 10 \text{ mA}, t_r = 20 \text{ ns}$)	V_{FR}	—	1.75	V



- Notes: 1. A 2.0 kΩ variable resistor adjusted for a Forward Current (I_F) of 10 mA.
 2. Input pulse is adjusted so $I_{R(\text{peak})}$ is equal to 10 mA.
 3. $t_p \gg t_{rr}$

Figure 1. Recovery Time Equivalent Test Circuit

CURVES APPLICABLE TO EACH DIODE

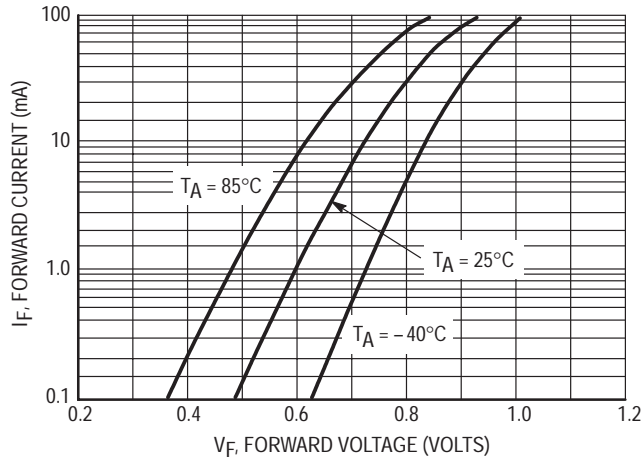


Figure 2. Forward Voltage

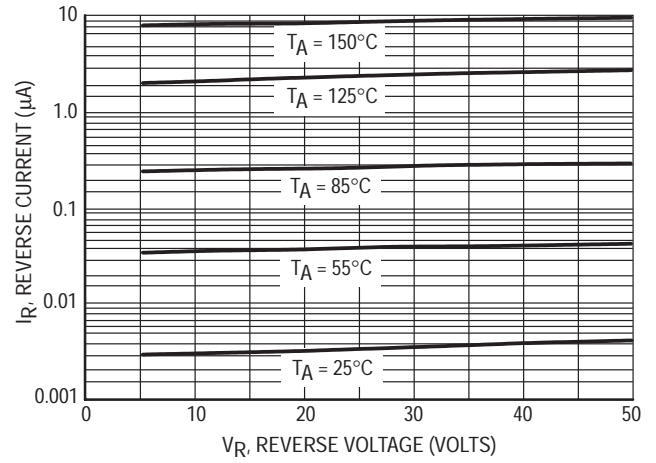


Figure 3. Leakage Current

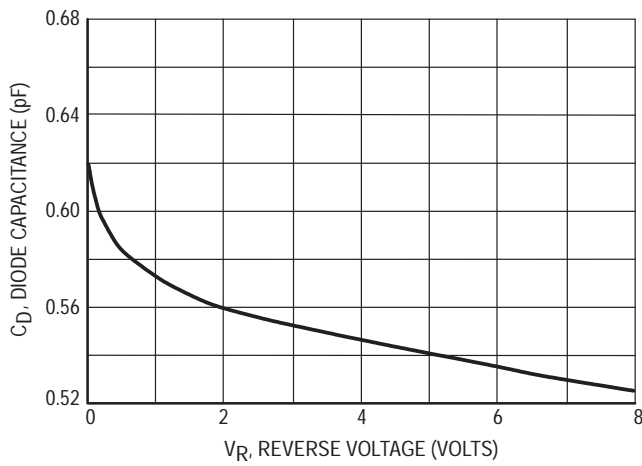


Figure 4. Capacitance

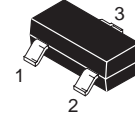
Monolithic Dual Switching Diode

This switching diode has the following features:

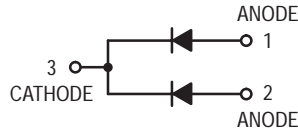
- Low Leakage Current Applications
- Medium Speed Switching Times
- Available in 8 mm Tape and Reel
 - Use BAV170LT1 to order the 7 inch/3,000 unit reel
 - Use BAV170LT3 to order the 13 inch/10,000 unit reel

BAV170LT1

Motorola Preferred Device



CASE 318-08, STYLE 9
SOT-23 (TO-236AB)



MAXIMUM RATINGS

Rating	Symbol	Value	Unit
Reverse Voltage	V_R	70	Vdc
Forward Current	I_F	200	mAdc
Peak Forward Surge Current	$I_{FM}(\text{surge})$	500	mAdc

THERMAL CHARACTERISTICS

Characteristic	Symbol	Max	Unit
Total Device Dissipation FR-5 Board ⁽¹⁾ $T_A = 25^\circ\text{C}$ Derate above 25°C	P_D	225 1.8	mW mW/ $^\circ\text{C}$
Thermal Resistance, Junction to Ambient	$R_{\theta JA}$	556	$^\circ\text{C}/\text{W}$
Total Device Dissipation Alumina Substrate ⁽²⁾ $T_A = 25^\circ\text{C}$ Derate above 25°C	P_D	300 2.4	mW mW/ $^\circ\text{C}$
Thermal Resistance, Junction to Ambient	$R_{\theta JA}$	417	$^\circ\text{C}/\text{W}$
Junction and Storage Temperature	T_J, T_{stg}	-55 to +150	$^\circ\text{C}$

DEVICE MARKING

BAV170LT1 = JX

ELECTRICAL CHARACTERISTICS ($T_A = 25^\circ\text{C}$ unless otherwise noted) (EACH DIODE)

Characteristic	Symbol	Min	Max	Unit
----------------	--------	-----	-----	------

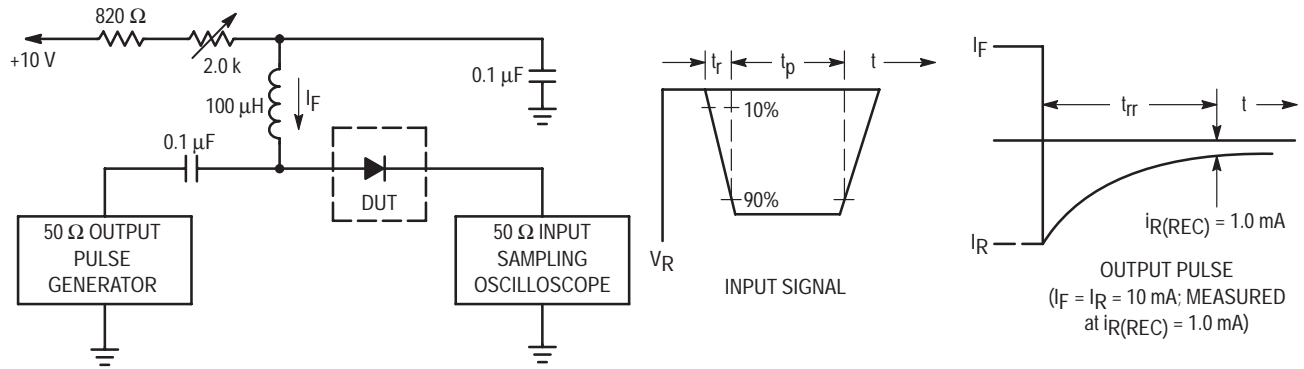
OFF CHARACTERISTICS

Reverse Breakdown Voltage ($I_{BR} = 100 \mu\text{Adc}$)	$V_{(BR)}$	70	—	Vdc	
Reverse Voltage Leakage Current ($V_R = 70 \text{Vdc}$) ($V_R = 70 \text{Vdc}, T_J = 150^\circ\text{C}$)	I_R	—	5.0 80	nAdc	
Diode Capacitance ($V_R = 0 \text{V}, f = 1.0 \text{MHz}$)	C_D	—	2.0	pF	
Forward Voltage ($I_F = 1.0 \text{mAdc}$) ($I_F = 10 \text{mAdc}$) ($I_F = 50 \text{mAdc}$) ($I_F = 150 \text{mAdc}$)	V_F	—	900 1000 1100 1250	mVdc	
Reverse Recovery Time ($I_F = I_R = 10 \text{mAdc}$) (Figure 1)	$R_L = 100 \Omega$	t_{rr}	—	3.0	μs

1. FR-5 = $1.0 \times 0.75 \times 0.062 \text{ in.}$

2. Alumina = $0.4 \times 0.3 \times 0.024 \text{ in. } 99.5\% \text{ alumina.}$

Preferred devices are Motorola recommended choices for future use and best overall value.



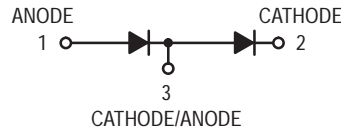
- Notes: 1. A 2.0 kΩ variable resistor adjusted for a Forward Current (I_F) of 10 mA.
 2. Input pulse is adjusted so $I_{R(\text{peak})}$ is equal to 10 mA.
 3. $t_p \gg t_{rr}$

Figure 1. Recovery Time Equivalent Test Circuit

Dual Series Switching Diode

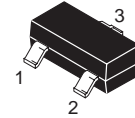
This switching diode has the following features:

- Low Leakage Current Applications
- Medium Speed Switching Times
- Available in 8 mm Tape and Reel
 - Use BAV199LT1 to order the 7 inch/3,000 unit reel
 - Use BAV199LT3 to order the 13 inch/10,000 unit reel



BAV199LT1

Motorola Preferred Device



CASE 318-08, STYLE 11
SOT-23 (TO-236AB)

MAXIMUM RATINGS

Rating	Symbol	Value	Unit
Reverse Voltage	V_R	70	Vdc
Forward Current	I_F	215	mAdc
Peak Forward Surge Current	$I_{FM}(\text{surge})$	500	mAdc
Repetitive Peak Reverse Voltage	V_{RRM}	70	Vdc
Average Rectified Forward Current ⁽¹⁾ (averaged over any 20 ms period)	$I_{F(AV)}$	715	mAdc
Repetitive Peak Forward Current	I_{FRM}	450	mAdc
Non-Repetitive Peak Forward Current	I_{FSM}	2.0 1.0 0.5	Adc
		$t = 1.0 \mu\text{s}$	
		$t = 1.0 \text{ ms}$	
		$t = 1.0 \text{ A}$	

THERMAL CHARACTERISTICS

Characteristic	Symbol	Max	Unit
Total Device Dissipation FR-5 Board ⁽¹⁾ $T_A = 25^\circ\text{C}$ Derate above 25°C	P_D	225 1.8	mW mW/ $^\circ\text{C}$
Thermal Resistance, Junction to Ambient	$R_{\theta JA}$	556	$^\circ\text{C}/\text{W}$
Total Device Dissipation Alumina Substrate ⁽²⁾ $T_A = 25^\circ\text{C}$ Derate above 25°C	P_D	300 2.4	mW mW/ $^\circ\text{C}$
Thermal Resistance, Junction to Ambient	$R_{\theta JA}$	417	$^\circ\text{C}/\text{W}$
Junction and Storage Temperature	T_J, T_{stg}	-65 to +150	$^\circ\text{C}$

DEVICE MARKING

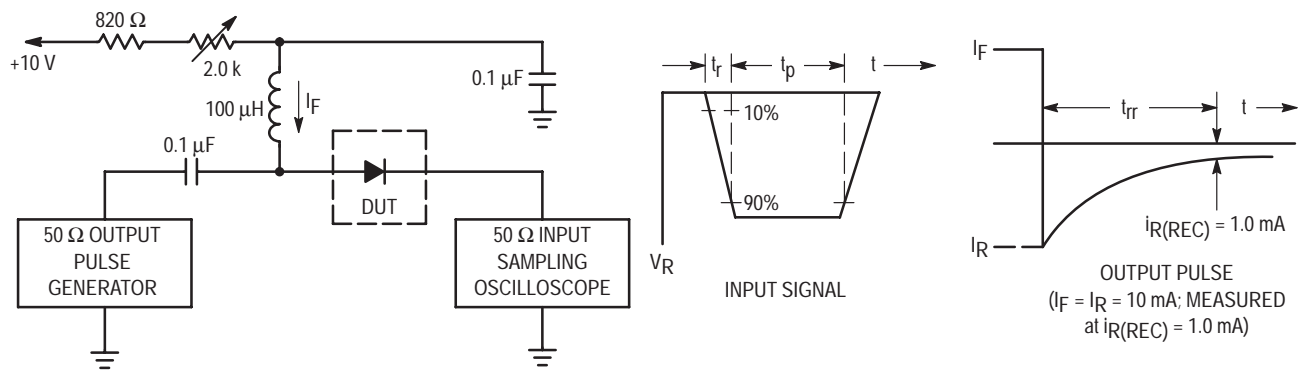
BAV199LT1 = JY

1. FR-5 = $1.0 \times 0.75 \times 0.062$ in.
2. Alumina = $0.4 \times 0.3 \times 0.024$ in. 99.5% alumina.

Preferred devices are Motorola recommended choices for future use and best overall value.

ELECTRICAL CHARACTERISTICS ($T_A = 25^\circ\text{C}$ unless otherwise noted) (EACH DIODE)

Characteristic	Symbol	Min	Max	Unit
OFF CHARACTERISTICS				
Reverse Breakdown Voltage ($I_{(BR)} = 100 \mu\text{A dc}$)	$V_{(BR)}$	70	—	Vdc
Reverse Voltage Leakage Current ($V_R = 70 \text{ Vdc}$) ($V_R = 70 \text{ Vdc}$, $T_J = 150^\circ\text{C}$)	I_R	— —	5.0 80	nA dc
Diode Capacitance ($V_R = 0 \text{ V}$, $f = 1.0 \text{ MHz}$)	C_D	—	2.0	pF
Forward Voltage ($I_F = 1.0 \text{ mA dc}$) ($I_F = 10 \text{ mA dc}$) ($I_F = 50 \text{ mA dc}$) ($I_F = 150 \text{ mA dc}$)	V_F	— — — —	900 1000 1100 1250	mVdc
Reverse Recovery Time ($I_F = I_R = 10 \text{ mA dc}$) (Figure 1)	t_{rr}	—	3.0	μs



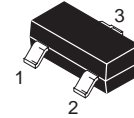
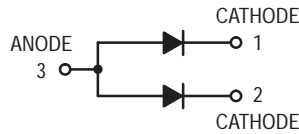
- Notes: 1. A 2.0 kΩ variable resistor adjusted for a Forward Current (I_F) of 10 mA.
 2. Input pulse is adjusted so $I_{R(\text{peak})}$ is equal to 10 mA.
 3. $t_p \gg t_{rr}$

Figure 1. Recovery Time Equivalent Test Circuit

Monolithic Dual Switching Diode Common Anode

BAW56LT1

Motorola Preferred Device



CASE 318-08, STYLE 12
SOT-23 (TO-236AB)

MAXIMUM RATINGS (EACH DIODE)

Rating	Symbol	Value	Unit
Reverse Voltage	V_R	70	Vdc
Forward Current	I_F	200	mAdc
Peak Forward Surge Current	$I_{FM}(\text{surge})$	500	mAdc

THERMAL CHARACTERISTICS

Characteristic	Symbol	Max	Unit
Total Device Dissipation FR-5 Board ⁽¹⁾ $T_A = 25^\circ\text{C}$ Derate above 25°C	P_D	225	mW
		1.8	mW/ $^\circ\text{C}$
Thermal Resistance, Junction to Ambient	$R_{\theta JA}$	556	$^\circ\text{C}/\text{W}$
Total Device Dissipation Alumina Substrate, ⁽²⁾ $T_A = 25^\circ\text{C}$ Derate above 25°C	P_D	300	mW
		2.4	mW/ $^\circ\text{C}$
Thermal Resistance, Junction to Ambient	$R_{\theta JA}$	417	$^\circ\text{C}/\text{W}$
Junction and Storage Temperature	T_J, T_{stg}	-55 to +150	$^\circ\text{C}$

DEVICE MARKING

BAW56LT1 = A1

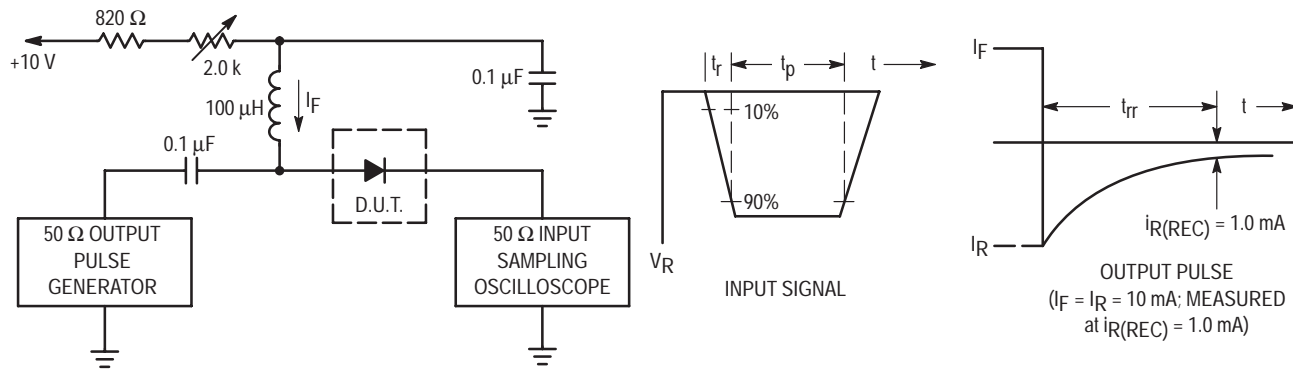
ELECTRICAL CHARACTERISTICS ($T_A = 25^\circ\text{C}$ unless otherwise noted) (EACH DIODE)

Characteristic	Symbol	Min	Max	Unit
Reverse Breakdown Voltage ($I_{(BR)} = 100 \mu\text{Adc}$)	$V_{(BR)}$	70	—	Vdc
Reverse Voltage Leakage Current ($V_R = 25 \text{ Vdc}, T_J = 150^\circ\text{C}$) ($V_R = 70 \text{ Vdc}$) ($V_R = 70 \text{ Vdc}, T_J = 150^\circ\text{C}$)	I_R	—	30 2.5 50	μAdc
Diode Capacitance ($V_R = 0, f = 1.0 \text{ MHz}$)	C_D	—	2.0	pF
Forward Voltage ($I_F = 1.0 \text{ mAdc}$) ($I_F = 10 \text{ mAdc}$) ($I_F = 50 \text{ mAdc}$) ($I_F = 150 \text{ mAdc}$)	V_F	—	715 855 1000 1250	mVdc
Reverse Recovery Time ($I_F = I_R = 10 \text{ mAdc}, I_{R(REC)} = 1.0 \text{ mAdc}$) (Figure 1) $R_L = 100 \Omega$	t_{rr}	—	6.0	ns

1. FR-5 = $1.0 \times 0.75 \times 0.062 \text{ in.}$

2. Alumina = $0.4 \times 0.3 \times 0.024 \text{ in.}$ 99.5% alumina.

Preferred devices are Motorola recommended choices for future use and best overall value.



- Notes: 1. A 2.0 kΩ variable resistor adjusted for a Forward Current (I_F) of 10 mA.
- 2. Input pulse is adjusted so $I_{R(peak)}$ is equal to 10 mA.
- 3. $t_p \gg t_{rr}$

Figure 1. Recovery Time Equivalent Test Circuit

Curves Applicable to Each Cathode

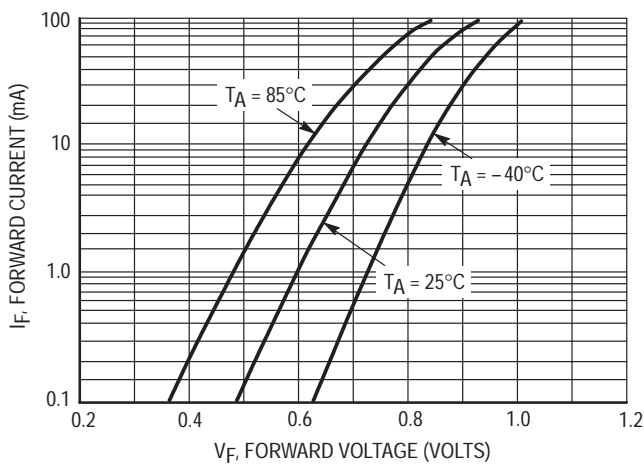


Figure 2. Forward Voltage

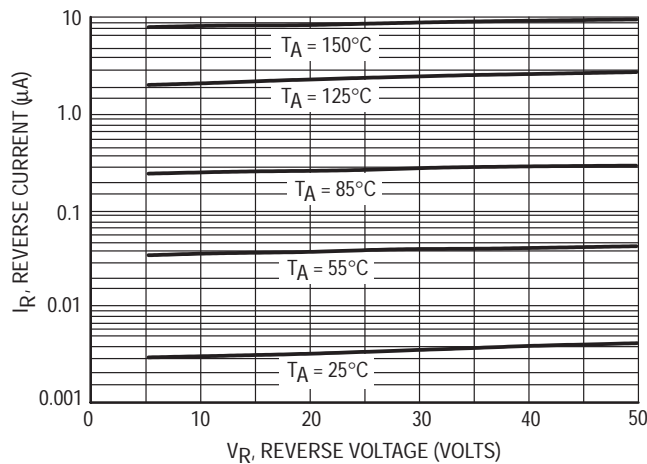


Figure 3. Leakage Current

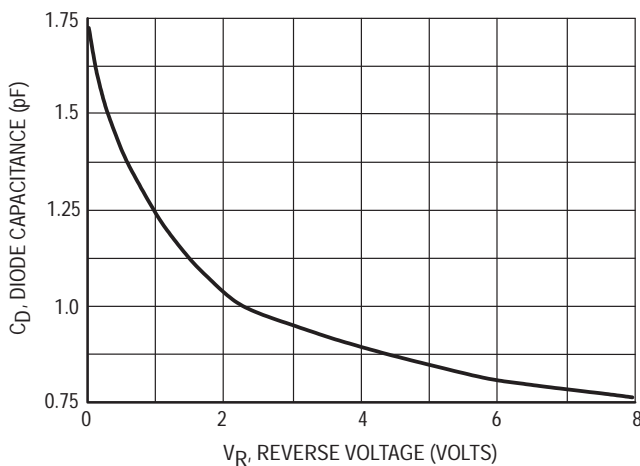
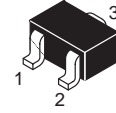
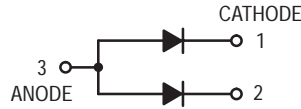


Figure 4. Capacitance

Dual Switching Diode

BAW56WT1

Motorola Preferred Device



CASE 419-02, STYLE 4
SC-70/SOT-323

MAXIMUM RATINGS (T_A = 25°C)

Rating	Symbol	Max	Unit
Reverse Voltage	V _R	70	Vdc
Forward Current	I _F	200	mAdc
Peak Forward Surge Current	I _{FM(surge)}	500	mAdc

THERMAL CHARACTERISTICS

Characteristic	Symbol	Max	Unit
Total Device Dissipation FR-5 Board ⁽¹⁾ T _A = 25°C Derate above 25°C	P _D	200 1.6	mW mW/°C
Thermal Resistance, Junction to Ambient	R _{θJA}	0.625	°C/W
Total Device Dissipation Alumina Substrate ⁽²⁾ T _A = 25°C Derate above 25°C	P _D	300 2.4	mW mW/°C
Thermal Resistance, Junction to Ambient	R _{θJA}	417	°C/W
Junction and Storage Temperature	T _J , T _{stg}	-55 to +150	°C

DEVICE MARKING

BAW56WT1 = A1

ELECTRICAL CHARACTERISTICS (T_A = 25°C unless otherwise noted)

Characteristic	Symbol	Min	Max	Unit
----------------	--------	-----	-----	------

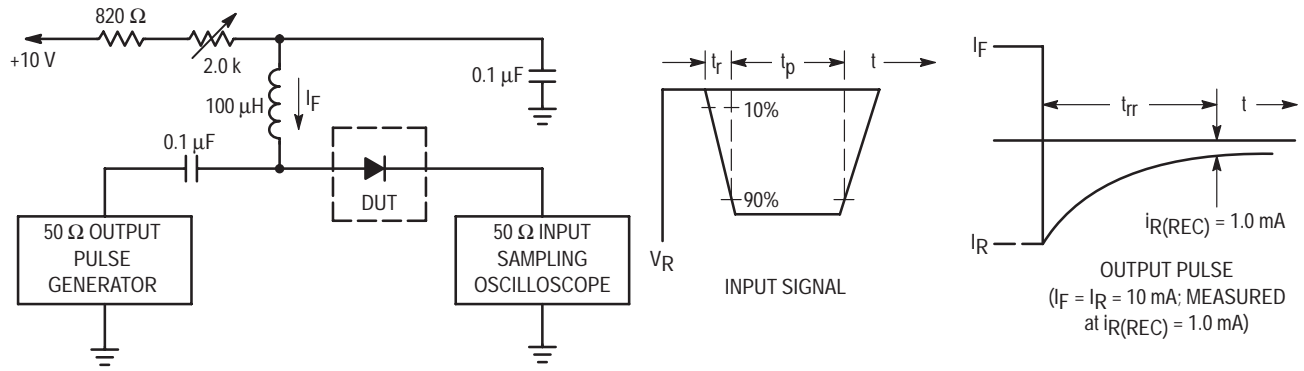
OFF CHARACTERISTICS

Reverse Breakdown Voltage (I _{BR} = 100 μAdc)	V _(BR)	70	—	Vdc
Reverse Voltage Leakage Current (V _R = 25 Vdc, T _J = 150°C) (V _R = 70 Vdc) (V _R = 70 Vdc, T _J = 150°C)	I _R	— — —	30 2.5 50	μAdc
Diode Capacitance (V _R = 0, f = 1.0 MHz)	C _D	—	2.0	pF
Forward Voltage (I _F = 1.0 mAdc) (I _F = 10 mAdc) (I _F = 60 mAdc) (I _F = 150 mAdc)	V _F	— — — —	715 855 1000 1250	mVdc
Reverse Recovery Time (I _F = I _R = 10 mAdc, R _L = 100 Ω, I _{R(REC)} = 1.0 mAdc) (Figure 1)	t _{rr}	—	6.0	ns

1. FR-5 = 1.0 × 0.75 × 0.062 in.

2. Alumina = 0.4 × 0.3 × 0.024 in. 99.5% alumina.

Preferred devices are Motorola recommended choices for future use and best overall value.



- Notes: 1. A 2.0 kΩ variable resistor adjusted for a Forward Current (I_F) of 10 mA.
- 2. Input pulse is adjusted so $I_{R(\text{peak})}$ is equal to 10 mA.
- 3. $t_p \gg t_{rr}$

Figure 1. Recovery Time Equivalent Test Circuit

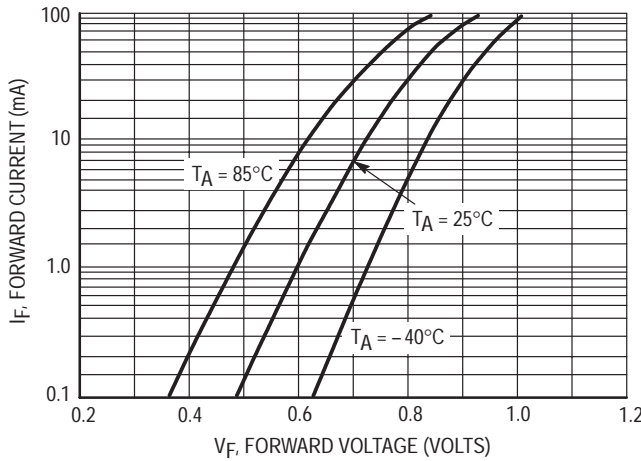


Figure 2. Forward Voltage

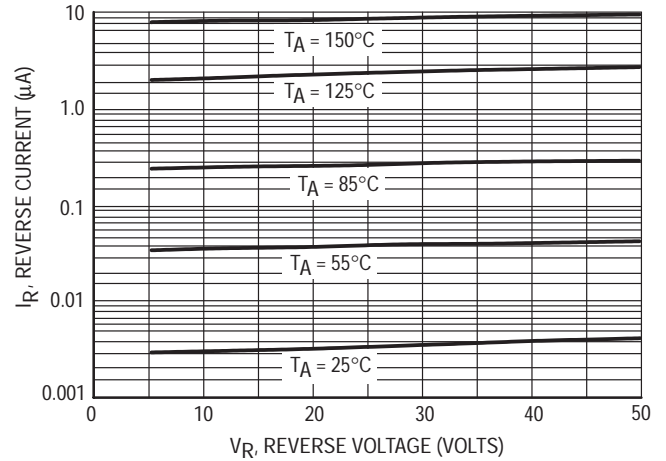


Figure 3. Leakage Current

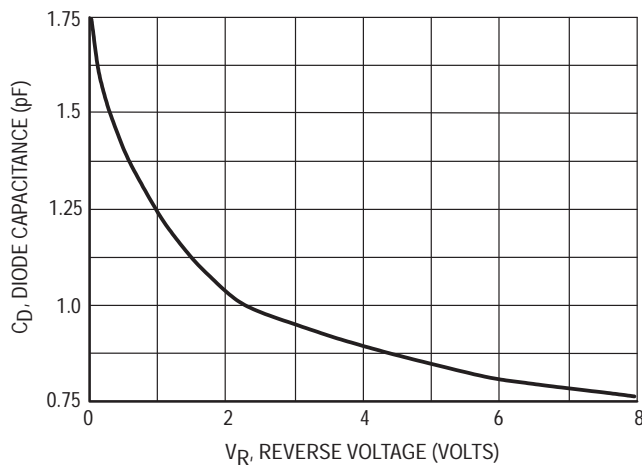


Figure 4. Capacitance

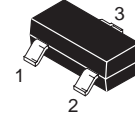
Monolithic Dual Switching Diode

This switching diode has the following features:

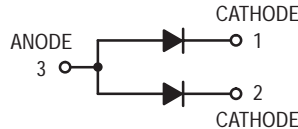
- Low Leakage Current Applications
- Medium Speed Switching Times
- Available in 8 mm Tape and Reel
 - Use BAW156LT1 to order the 7 inch/3,000 unit reel
 - Use BAW156LT3 to order the 13 inch/10,000 unit reel

BAW156LT1

Motorola Preferred Device



CASE 318-08, STYLE 12
SOT-23 (TO-236AB)



MAXIMUM RATINGS

Rating	Symbol	Value	Unit
Reverse Voltage	V_R	70	Vdc
Forward Current	I_F	200	mAdc
Peak Forward Surge Current	$I_{FM}(\text{surge})$	500	mAdc

THERMAL CHARACTERISTICS

Characteristic	Symbol	Max	Unit
Total Device Dissipation FR-5 Board ⁽¹⁾ $T_A = 25^\circ\text{C}$ Derate above 25°C	P_D	225	mW
		1.8	mW/ $^\circ\text{C}$
Thermal Resistance, Junction to Ambient	$R_{\theta JA}$	556	$^\circ\text{C}/\text{W}$
Total Device Dissipation Alumina Substrate ⁽²⁾ $T_A = 25^\circ\text{C}$ Derate above 25°C	P_D	300	mW
		2.4	mW/ $^\circ\text{C}$
Thermal Resistance, Junction to Ambient	$R_{\theta JA}$	417	$^\circ\text{C}/\text{W}$
Junction and Storage Temperature	T_J, T_{stg}	-55 to +150	$^\circ\text{C}$

DEVICE MARKING

BAW156LT1 = JZ

ELECTRICAL CHARACTERISTICS ($T_A = 25^\circ\text{C}$ unless otherwise noted) (EACH DIODE)

Characteristic	Symbol	Min	Max	Unit
----------------	--------	-----	-----	------

OFF CHARACTERISTICS

Reverse Breakdown Voltage ($I_{BR} = 100 \mu\text{Adc}$)	$V_{(BR)}$	70	—	Vdc
Reverse Voltage Leakage Current ($V_R = 70 \text{ Vdc}$) ($V_R = 70 \text{ Vdc}, T_J = 150^\circ\text{C}$)	I_R	—	5.0 80	nAdc
Diode Capacitance ($V_R = 0 \text{ V}, f = 1.0 \text{ MHz}$)	C_D	—	2.0	pF
Forward Voltage ($I_F = 1.0 \text{ mAdc}$) ($I_F = 10 \text{ mAdc}$) ($I_F = 50 \text{ mAdc}$) ($I_F = 150 \text{ mAdc}$)	V_F	—	900 1000 1100 1250	mVdc
Reverse Recovery Time ($I_F = I_R = 10 \text{ mAdc}$) (Figure 1)	t_{rr}	—	3.0	μs

1. FR-5 = $1.0 \times 0.75 \times 0.062 \text{ in.}$

2. Alumina = $0.4 \times 0.3 \times 0.024 \text{ in. } 99.5\% \text{ alumina.}$

Preferred devices are Motorola recommended choices for future use and best overall value.

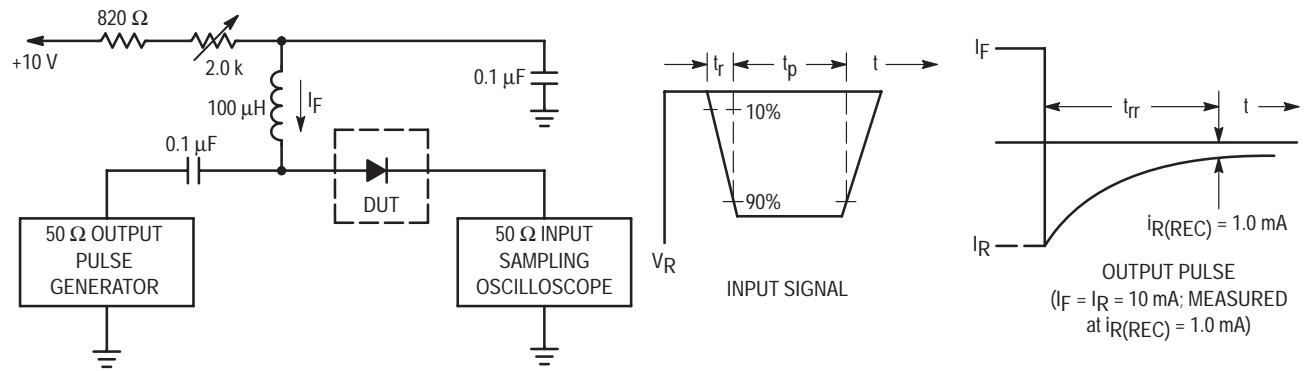


Figure 1. Recovery Time Equivalent Test Circuit

Common Cathode Silicon Dual Switching Diode

This Common Cathode Silicon Epitaxial Planar Dual Diode is designed for use in ultra high speed switching applications. This device is housed in the SOT-416/SC-90 package which is designed for low power surface mount applications, where board space is at a premium.

- Fast t_{rr}
- Low C_D
- Available in 8 mm Tape and Reel

MAXIMUM RATINGS ($T_A = 25^\circ\text{C}$)

Rating	Symbol	Value	Unit
Reverse Voltage	V_R	80	Vdc
Peak Reverse Voltage	V_{RM}	80	Vdc
Forward Current	I_F	100	mAdc
Peak Forward Current	I_{FM}	300	mAdc
Peak Forward Surge Current	$I_{FSM}(1)$	2.0	Adc

DEVICE MARKING

DAN222 = N9

THERMAL CHARACTERISTICS

Rating	Symbol	Max	Unit
Power Dissipation	P_D	150	mW
Junction Temperature	T_J	150	$^\circ\text{C}$
Storage Temperature	T_{stg}	-55 ~ +150	$^\circ\text{C}$

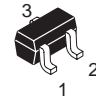
ELECTRICAL CHARACTERISTICS ($T_A = 25^\circ\text{C}$)

Characteristic	Symbol	Condition	Min	Max	Unit
Reverse Voltage Leakage Current	I_R	$V_R = 70\text{ V}$	—	0.1	μAdc
Forward Voltage	V_F	$I_F = 100\text{ mA}$	—	1.2	Vdc
Reverse Breakdown Voltage	V_R	$I_R = 100\ \mu\text{A}$	80	—	Vdc
Diode Capacitance	C_D	$V_R = 6.0\text{ V}, f = 1.0\text{ MHz}$	—	3.5	pF
Reverse Recovery Time	$t_{rr}(2)$	$I_F = 5.0\text{ mA}, V_R = 6.0\text{ V}, R_L = 100\ \Omega, I_{rr} = 0.1 I_R$	—	4.0	ns

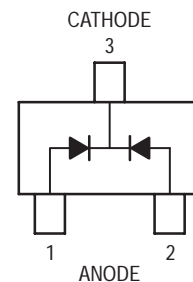
1. $t = 1\ \mu\text{s}$
2. t_{rr} Test Circuit on following page.

DAN222

**SOT-416/SC-90 PACKAGE
COMMON CATHODE
DUAL SWITCHING DIODE
SURFACE MOUNT**



**CASE 463-01, STYLE 4
SOT-416/SC-90**



TYPICAL ELECTRICAL CHARACTERISTICS

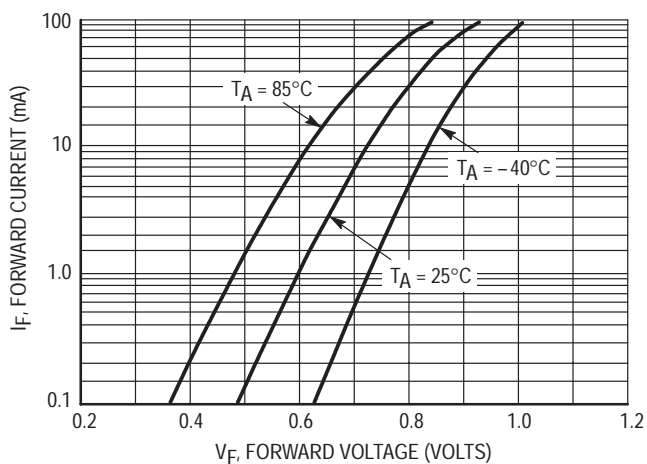


Figure 1. Forward Voltage

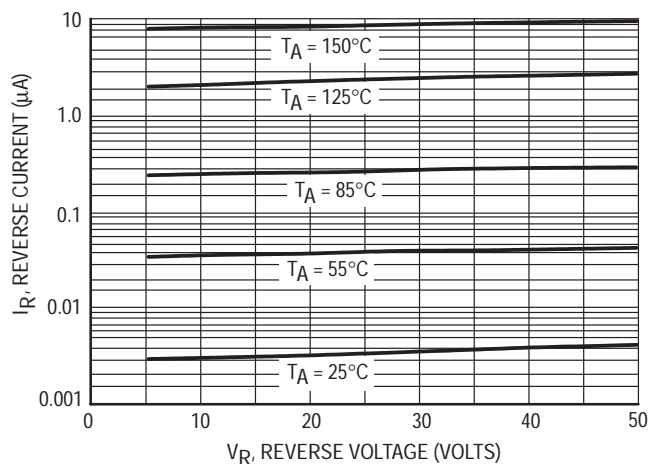


Figure 2. Reverse Current

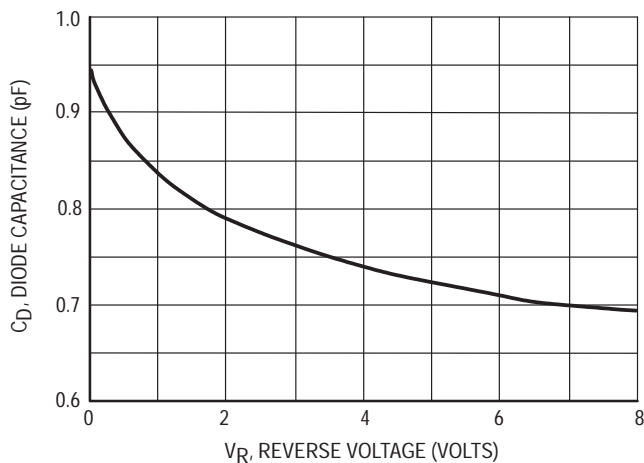
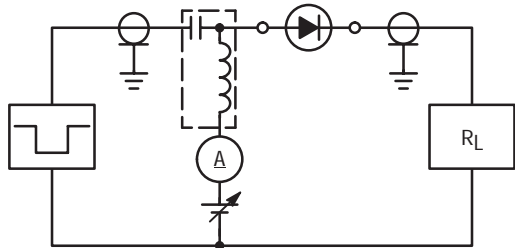
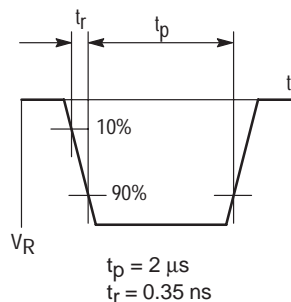


Figure 3. Diode Capacitance

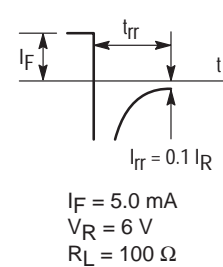
RECOVERY TIME EQUIVALENT TEST CIRCUIT



INPUT PULSE



OUTPUT PULSE



Common Anode Silicon Dual Switching Diode

This Common Anode Silicon Epitaxial Planar Dual Diode is designed for use in ultra high speed switching applications. This device is housed in the SOT-416/SC-90 package which is designed for low power surface mount applications, where board space is at a premium.

- Fast t_{rr}
- Low C_D
- Available in 8 mm Tape and Reel

MAXIMUM RATINGS ($T_A = 25^\circ\text{C}$)

Rating	Symbol	Value	Unit
Reverse Voltage	V_R	80	Vdc
Peak Reverse Voltage	V_{RM}	80	Vdc
Forward Current	I_F	100	mAdc
Peak Forward Current	I_{FM}	300	mAdc
Peak Forward Surge Current	$I_{FSM}(1)$	2.0	Adc

DEVICE MARKING

DAP222 = P9

THERMAL CHARACTERISTICS

Rating	Symbol	Max	Unit
Power Dissipation	P_D	150	mW
Junction Temperature	T_J	150	$^\circ\text{C}$
Storage Temperature	T_{stg}	-55 ~ +150	$^\circ\text{C}$

ELECTRICAL CHARACTERISTICS ($T_A = 25^\circ\text{C}$)

Characteristic	Symbol	Condition	Min	Max	Unit
Reverse Voltage Leakage Current	I_R	$V_R = 70\text{ V}$	—	0.1	μAdc
Forward Voltage	V_F	$I_F = 100\text{ mA}$	—	1.2	Vdc
Reverse Breakdown Voltage	V_R	$I_R = 100\ \mu\text{A}$	80	—	Vdc
Diode Capacitance	C_D	$V_R = 6.0\text{ V}, f = 1.0\text{ MHz}$	—	3.5	pF
Reverse Recovery Time	$t_{rr}(2)$	$I_F = 5.0\text{ mA}, V_R = 6.0\text{ V}, R_L = 100\ \Omega, I_{rr} = 0.1\ I_R$	—	4.0	ns

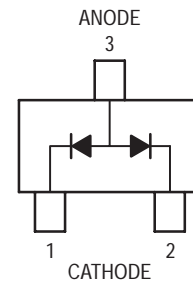
1. $t = 1\ \mu\text{s}$
2. t_{rr} Test Circuit on following page.

DAP222

**SOT-416/SC-90 PACKAGE
COMMON ANODE
DUAL SWITCHING DIODE
SURFACE MOUNT**



**CASE 463-01, STYLE 4
SOT-416/SC-90**



TYPICAL ELECTRICAL CHARACTERISTICS

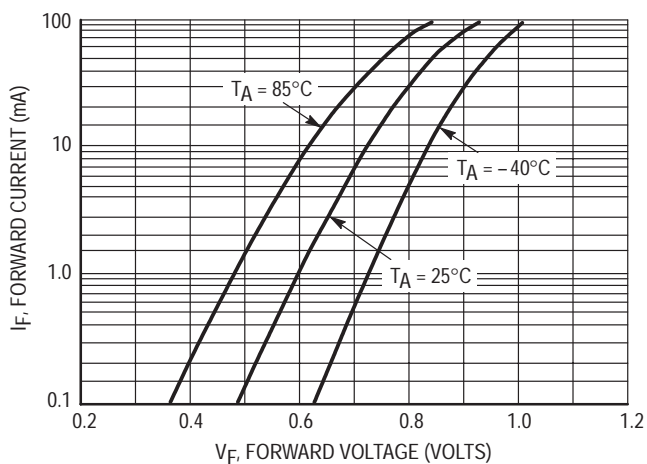


Figure 1. Forward Voltage

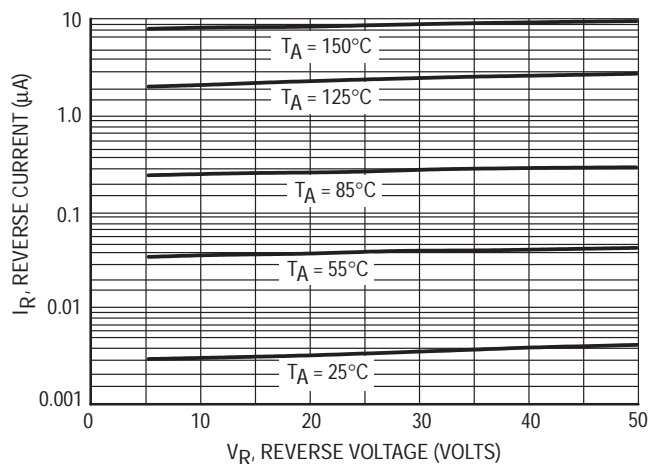


Figure 2. Reverse Current

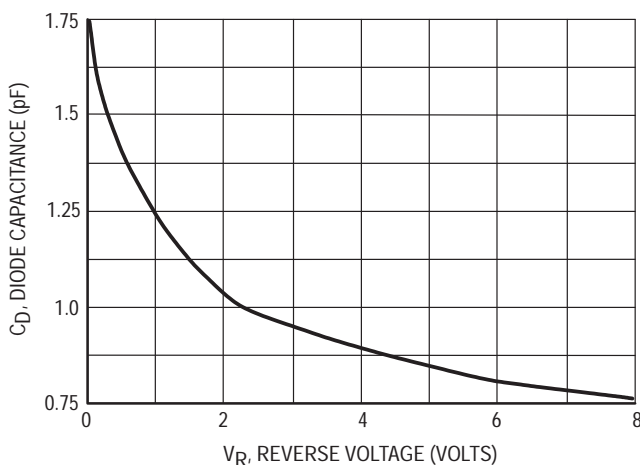
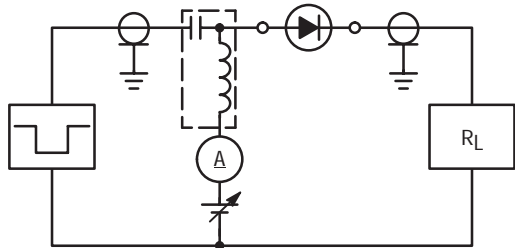
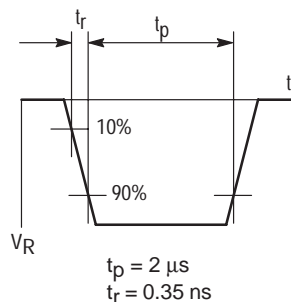


Figure 3. Diode Capacitance

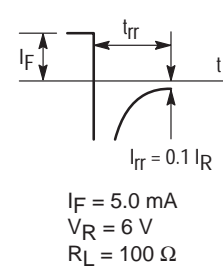
RECOVERY TIME EQUIVALENT TEST CIRCUIT



INPUT PULSE



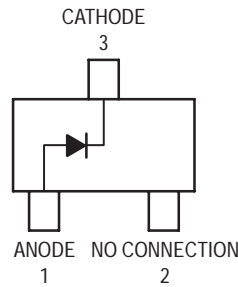
OUTPUT PULSE



Single Silicon Switching Diode

This Silicon Epitaxial Planar Diode is designed for use in ultra high speed switching applications. This device is housed in the SC-70 package which is designed for low power surface mount applications.

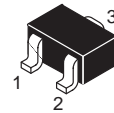
- Fast t_{rr} , < 3.0 ns
- Low C_D , < 2.0 pF
- Available in 8 mm Tape and Reel
Use M1MA141/2KT1 to order the 7 inch/3000 unit reel.
Use M1MA141/2KT3 to order the 13 inch/10,000 unit reel.



M1MA141KT1
M1MA142KT1

Motorola Preferred Devices

SC-70/SOT-323 PACKAGE
SINGLE SILICON
SWITCHING DIODE
40/80 V-100 mA
SURFACE MOUNT



CASE 419-02, STYLE 2
SC-70/SOT-323

MAXIMUM RATINGS ($T_A = 25^\circ\text{C}$)

Rating		Symbol	Value	Unit
Reverse Voltage	M1MA141KT1	V_R	40	Vdc
	M1MA142KT1		80	
Peak Reverse Voltage	M1MA141KT1	V_{RM}	40	Vdc
	M1MA142KT1		80	
Forward Current		I_F	100	mAdc
Peak Forward Current		I_{FM}	225	mAdc
Peak Forward Surge Current		$I_{FSM}^{(1)}$	500	mAdc

THERMAL CHARACTERISTICS

Rating	Symbol	Max	Unit
Power Dissipation	P_D	150	mW
Junction Temperature	T_J	150	$^\circ\text{C}$
Storage Temperature	T_{stg}	-55 ~ +150	$^\circ\text{C}$

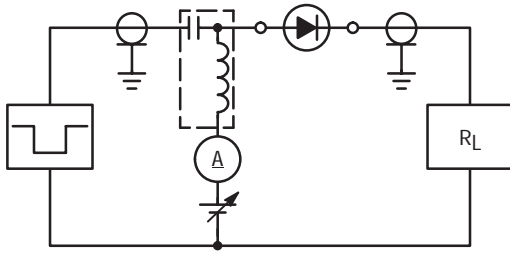
ELECTRICAL CHARACTERISTICS ($T_A = 25^\circ\text{C}$)

Characteristic		Symbol	Condition	Min	Max	Unit
Reverse Voltage Leakage Current	M1MA141KT1	I_R	$V_R = 35\text{ V}$	—	0.1	μAdc
	M1MA142KT1		$V_R = 75\text{ V}$	—	0.1	
Forward Voltage		V_F	$I_F = 100\text{ mA}$	—	1.2	Vdc
Reverse Breakdown Voltage	M1MA141KT1	V_R	$I_R = 100\ \mu\text{A}$	40	—	Vdc
	M1MA142KT1			80	—	
Diode Capacitance		C_D	$V_R = 0, f = 1.0\text{ MHz}$	—	2.0	pF
Reverse Recovery Time		$t_{rr}^{(2)}$	$I_F = 10\text{ mA}, V_R = 6.0\text{ V}, R_L = 100\ \Omega, I_{rr} = 0.1\ I_R$	—	3.0	ns

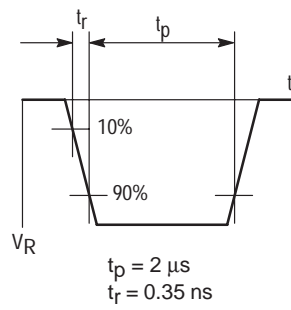
1. $t = 1\text{ SEC}$
2. t_{rr} Test Circuit

Preferred devices are Motorola recommended choices for future use and best overall value.

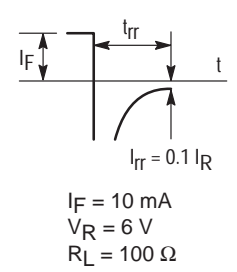
RECOVERY TIME EQUIVALENT TEST CIRCUIT



INPUT PULSE



OUTPUT PULSE



DEVICE MARKING — EXAMPLE

Marking Symbol		
Type No.	141K	142K
Symbol	MH	MI

The "X" represents a smaller alpha digit Date Code. The Date Code indicates the actual month in which the part was manufactured.

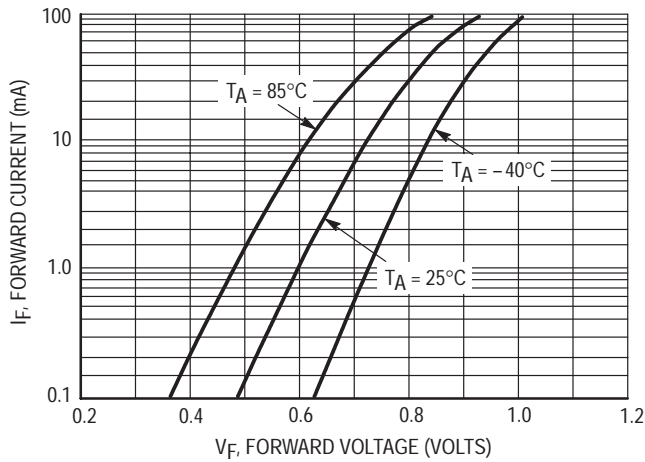


Figure 1. Forward Voltage

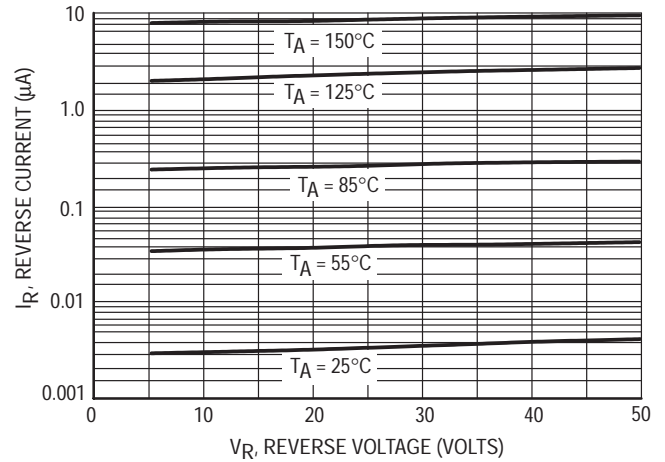


Figure 2. Reverse Current

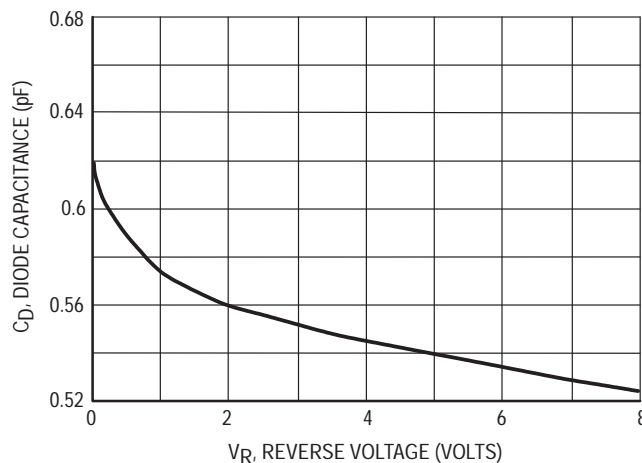
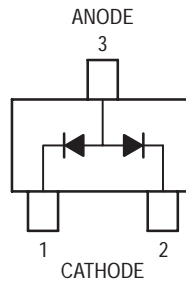


Figure 3. Diode Capacitance

Common Anode Silicon Dual Switching Diode

This Common Anode Silicon Epitaxial Planar Dual Diode is designed for use in ultra high speed switching applications. This device is housed in the SC-70 package which is designed for low power surface mount applications.

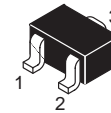
- Fast t_{rr} , < 10 ns
- Low C_D , < 15 pF
- Available in 8 mm Tape and Reel
Use M1MA141/2WAT1 to order the 7 inch/3000 unit reel.
Use M1MA141/2WAT3 to order the 13 inch/10,000 unit reel.



M1MA141WAT1
M1MA142WAT1

Motorola Preferred Devices

SC-70/SOT-323 PACKAGE
COMMON ANODE
DUAL SWITCHING DIODE
40/80 V-100 mA
SURFACE MOUNT



CASE 419-02, STYLE 4
SC-70/SOT-323

MAXIMUM RATINGS ($T_A = 25^\circ\text{C}$)

Rating	Symbol	Value	Unit	
Reverse Voltage	M1MA141WAT1	V_R	40	Vdc
	M1MA142WAT1		80	
Peak Reverse Voltage	M1MA141WAT1	V_{RM}	40	Vdc
	M1MA142WAT1		80	
Forward Current	Single	I_F	100	mAdc
	Dual		150	
Peak Forward Current	Single	I_{FM}	225	mAdc
	Dual		340	
Peak Forward Surge Current	Single	$I_{FSM}^{(1)}$	500	mAdc
	Dual		750	

THERMAL CHARACTERISTICS

Rating	Symbol	Max	Unit
Power Dissipation	P_D	150	mW
Junction Temperature	T_J	150	$^\circ\text{C}$
Storage Temperature	T_{stg}	-55 ~ +150	$^\circ\text{C}$

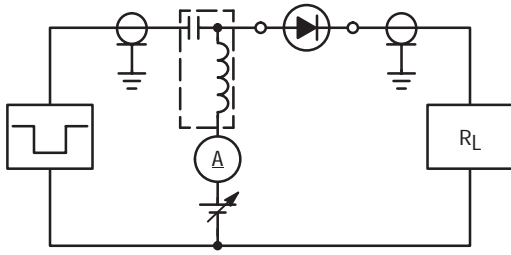
ELECTRICAL CHARACTERISTICS ($T_A = 25^\circ\text{C}$)

Characteristic	Symbol	Condition	Min	Max	Unit	
Reverse Voltage Leakage Current	M1MA141WAT1	I_R	$V_R = 35\text{ V}$	—	0.1	μAdc
	M1MA142WAT1		$V_R = 75\text{ V}$	—	0.1	
Forward Voltage	V_F	$I_F = 100\text{ mA}$	—	1.2	Vdc	
Reverse Breakdown Voltage	M1MA141WAT1	V_R	$I_R = 100\ \mu\text{A}$	40	—	Vdc
	M1MA142WAT1			80	—	
Diode Capacitance	C_D	$V_R = 0, f = 1.0\text{ MHz}$	—	15	pF	
Reverse Recovery Time	$t_{rr}^{(2)}$	$I_F = 10\text{ mA}, V_R = 6.0\text{ V}, R_L = 100\ \Omega, I_{rr} = 0.1\ I_R$	—	10	ns	

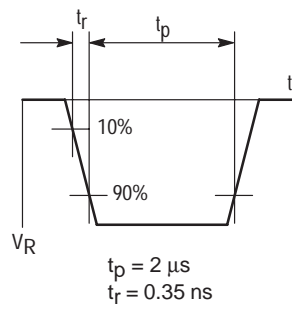
1. $t = 1\text{ SEC}$
2. t_{rr} Test Circuit

Preferred devices are Motorola recommended choices for future use and best overall value.

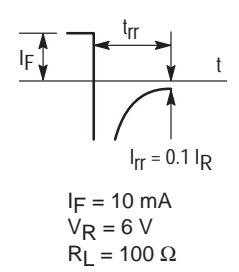
RECOVERY TIME EQUIVALENT TEST CIRCUIT



INPUT PULSE



OUTPUT PULSE



DEVICE MARKING — EXAMPLE

Marking Symbol		
Type No.	141WA	142WA
Symbol	MN	MO

The "X" represents a smaller alpha digit Date Code. The Date Code indicates the actual month in which the part was manufactured.

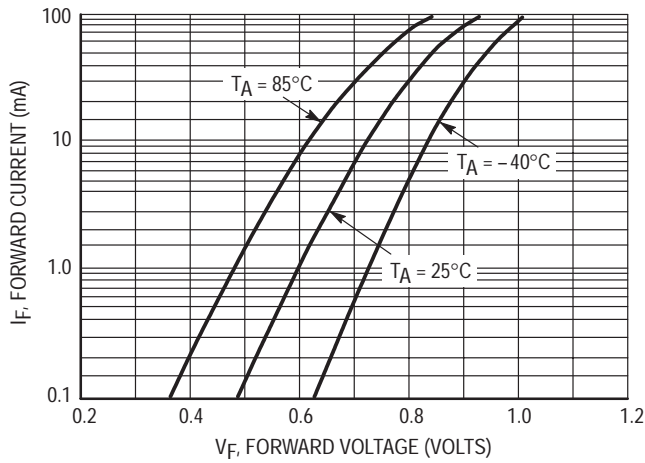


Figure 1. Forward Voltage

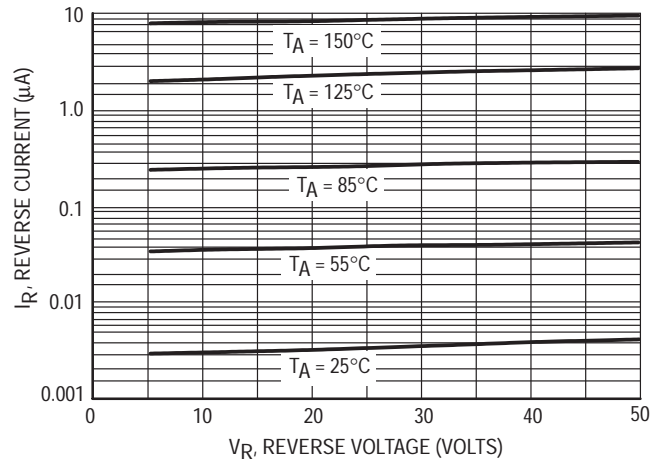


Figure 2. Reverse Current

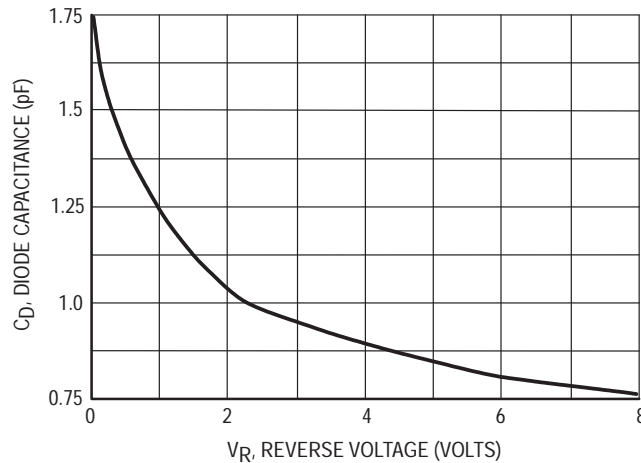
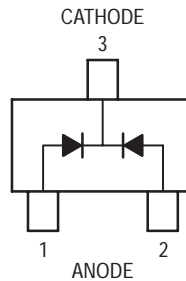


Figure 3. Diode Capacitance

Common Cathode Silicon Dual Switching Diode

This Common Cathode Silicon Epitaxial Planar Dual Diode is designed for use in ultra high speed switching applications. This device is housed in the SC-70 package which is designed for low power surface mount applications.

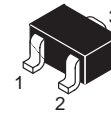
- Fast t_{rr} , < 3.0 ns
- Low C_D , < 2.0 pF
- Available in 8 mm Tape and Reel
 - Use M1MA141/2WKT1 to order the 7 inch/3000 unit reel.
 - Use M1MA141/2WKT3 to order the 13 inch/10,000 unit reel.



M1MA141WKT1
M1MA142WKT1

Motorola Preferred Devices

SC-70/SOT-323 PACKAGE
COMMON CATHODE
DUAL SWITCHING DIODE
40/80 V-100 mA
SURFACE MOUNT



CASE 419-02, STYLE 5
SC-70/SOT-323

MAXIMUM RATINGS ($T_A = 25^\circ\text{C}$)

Rating	Symbol	Value	Unit
Reverse Voltage	M1MA141WKT1	40	Vdc
	M1MA142WKT1	80	
Peak Reverse Voltage	M1MA141WKT1	40	Vdc
	M1MA142WKT1	80	
Forward Current	Single	100	mAdc
	Dual	150	
Peak Forward Current	Single	225	mAdc
	Dual	340	
Peak Forward Surge Current	Single	500	mAdc
	Dual	750	

THERMAL CHARACTERISTICS

Rating	Symbol	Max	Unit
Power Dissipation	P_D	150	mW
Junction Temperature	T_J	150	$^\circ\text{C}$
Storage Temperature	T_{stg}	-55 ~ +150	$^\circ\text{C}$

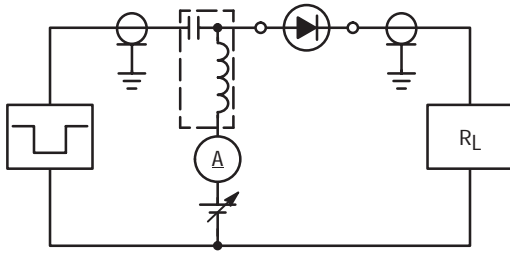
ELECTRICAL CHARACTERISTICS ($T_A = 25^\circ\text{C}$)

Characteristic	Symbol	Condition	Min	Max	Unit
Reverse Voltage Leakage Current	M1MA141WKT1	$V_R = 35\text{ V}$	—	0.1	μAdc
	M1MA142WKT1				
Forward Voltage	V_F	$I_F = 100\text{ mA}$	—	1.2	Vdc
Reverse Breakdown Voltage	M1MA141WKT1	$I_R = 100\ \mu\text{A}$	40	—	Vdc
	M1MA142WKT1		80	—	
Diode Capacitance	C_D	$V_R = 0, f = 1.0\text{ MHz}$	—	2.0	pF
Reverse Recovery Time	$t_{rr}^{(2)}$	$I_F = 10\text{ mA}, V_R = 6.0\text{ V}, R_L = 100\ \Omega, I_{rr} = 0.1 I_R$	—	3.0	ns

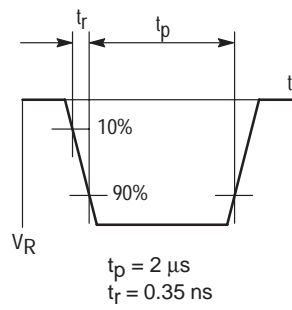
1. $t = 1\text{ SEC}$
2. t_{rr} Test Circuit

Preferred devices are Motorola recommended choices for future use and best overall value.

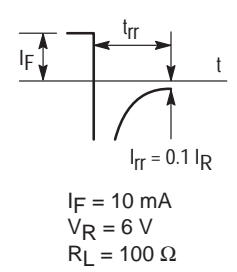
RECOVERY TIME EQUIVALENT TEST CIRCUIT



INPUT PULSE



OUTPUT PULSE



DEVICE MARKING — EXAMPLE

Marking Symbol		
Type No.	141WK	142WK
Symbol	MT	MU

The "X" represents a smaller alpha digit Date Code. The Date Code indicates the actual month in which the part was manufactured.

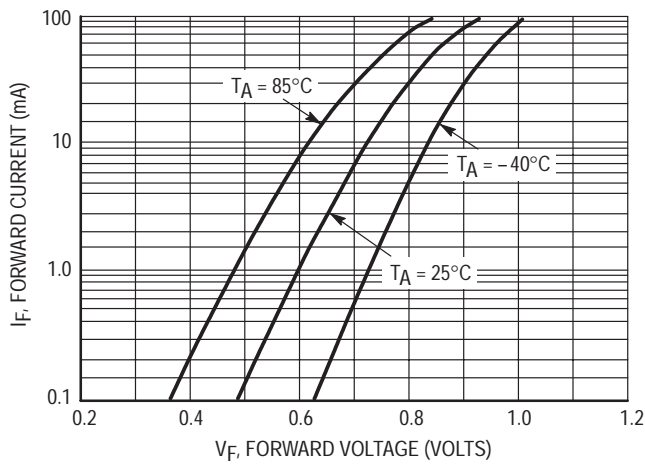


Figure 1. Forward Voltage

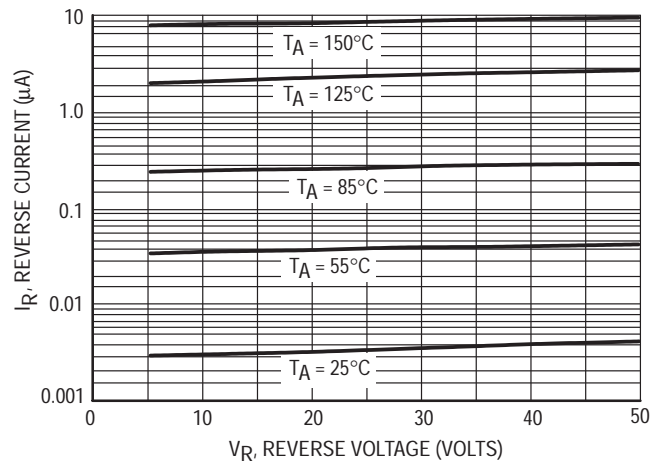


Figure 2. Reverse Current

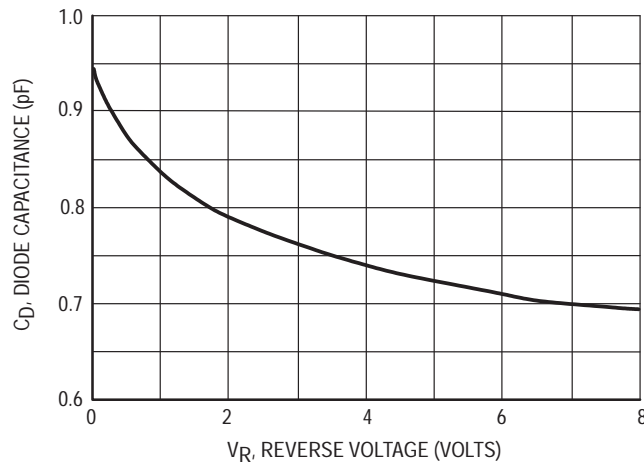
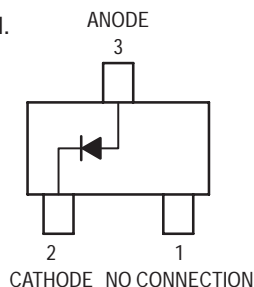


Figure 3. Diode Capacitance

Single Silicon Switching Diodes

These Silicon Epitaxial Planar Diodes are designed for use in ultra high speed switching applications. These devices are housed in the SC-59 package which is designed for low power surface mount applications.

- Fast t_{rr} , < 3.0 ns
- Low C_D , < 2.0 pF
- Available in 8 mm Tape and Reel
Use M1MA151/2AT1 to order the 7 inch/3000 unit reel.
Use M1MA151/2AT3 to order the 13 inch/10,000 unit reel.



M1MA151AT1
M1MA152AT1

Motorola Preferred Devices

SC-59 PACKAGE
SINGLE SILICON
SWITCHING DIODES
40/80 V-100 mA
SURFACE MOUNT



CASE 318D-03, STYLE 4
SC-59

MAXIMUM RATINGS ($T_A = 25^\circ\text{C}$)

Rating		Symbol	Value	Unit
Reverse Voltage	M1MA151AT1	V_R	40	Vdc
	M1MA152AT1		80	
Peak Reverse Voltage	M1MA151AT1	V_{RM}	40	Vdc
	M1MA152AT1		80	
Forward Current		I_F	100	mAdc
Peak Forward Current		I_{FM}	225	mAdc
Peak Forward Surge Current		$I_{FSM}^{(1)}$	500	mAdc

THERMAL CHARACTERISTICS

Rating	Symbol	Max	Unit
Power Dissipation	P_D	200	mW
Junction Temperature	T_J	150	$^\circ\text{C}$
Storage Temperature	T_{stg}	-55 to +150	$^\circ\text{C}$

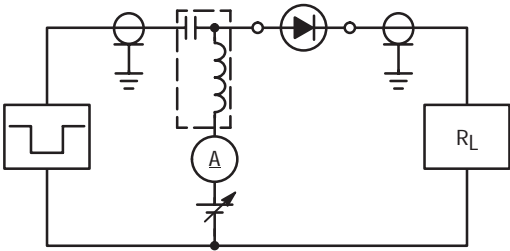
ELECTRICAL CHARACTERISTICS ($T_A = 25^\circ\text{C}$)

Characteristic		Symbol	Condition	Min	Max	Unit
Reverse Voltage Leakage Current	M1MA151AT1	I_R	$V_R = 35\text{ V}$	—	0.1	μAdc
	M1MA152AT1		$V_R = 75\text{ V}$	—	0.1	
Forward Voltage		V_F	$I_F = 100\text{ mA}$	—	1.2	Vdc
Reverse Breakdown Voltage	M1MA151AT1	V_R	$I_R = 100\ \mu\text{A}$	40	—	Vdc
	M1MA152AT1			80	—	
Diode Capacitance		C_D	$V_R = 0, f = 1.0\text{ MHz}$	—	2.0	pF
Reverse Recovery Time		$t_{rr}^{(2)}$	$I_F = 10\text{ mA}, V_R = 6.0\text{ V}, R_L = 100\ \Omega, I_{rr} = 0.1\ I_R$	—	3.0	ns

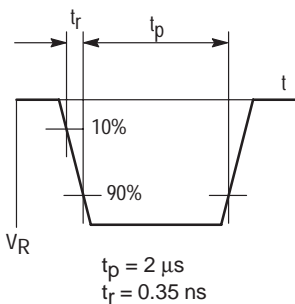
1. $t = 1\text{ SEC}$
2. t_{rr} Test Circuit

Preferred devices are Motorola recommended choices for future use and best overall value.

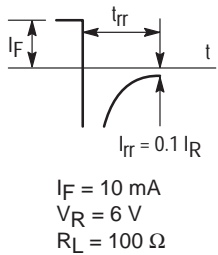
RECOVERY TIME EQUIVALENT TEST CIRCUIT



INPUT PULSE



OUTPUT PULSE



DEVICE MARKING

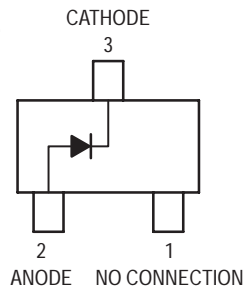
Marking Symbol		
Type No.	151A	152A
Symbol	MA	MB

The "X" represents a smaller alpha digit Date Code. The Date Code indicates the actual month in which the part was manufactured.

Single Silicon Switching Diodes

These Silicon Epitaxial Planar Diodes are designed for use in ultra high speed switching applications. These devices are housed in the SC-59 package which is designed for low power surface mount applications.

- Fast t_{rr} , < 3.0 ns
- Low C_D , < 2.0 pF
- Available in 8 mm Tape and Reel
Use M1MA151/2KT1 to order the 7 inch/3000 unit reel.
Use M1MA151/2KT3 to order the 13 inch/10,000 unit reel.



M1MA151KT1
M1MA152KT1

Motorola Preferred Devices

SC-59 PACKAGE
SINGLE SILICON
SWITCHING DIODES
40/80 V-100 mA
SURFACE MOUNT



CASE 318D-03, STYLE 2
SC-59

MAXIMUM RATINGS ($T_A = 25^\circ\text{C}$)

Rating		Symbol	Value	Unit
Reverse Voltage	M1MA151KT1	V_R	40	Vdc
	M1MA152KT1		80	
Peak Reverse Voltage	M1MA151KT1	V_{RM}	40	Vdc
	M1MA152KT1		80	
Forward Current		I_F	100	mAdc
Peak Forward Current		I_{FM}	225	mAdc
Peak Forward Surge Current		$I_{FSM}^{(1)}$	500	mAdc

THERMAL CHARACTERISTICS

Rating	Symbol	Max	Unit
Power Dissipation	P_D	200	mW
Junction Temperature	T_J	150	$^\circ\text{C}$
Storage Temperature	T_{stg}	-55 to +150	$^\circ\text{C}$

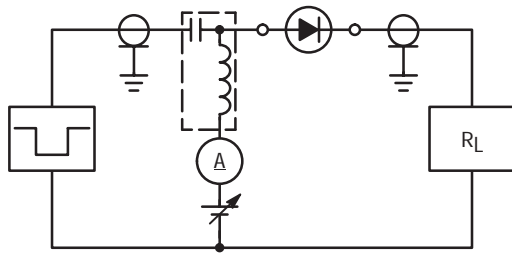
ELECTRICAL CHARACTERISTICS ($T_A = 25^\circ\text{C}$)

Characteristic		Symbol	Condition	Min	Max	Unit
Reverse Voltage Leakage Current	M1MA151KT1	I_R	$V_R = 35\text{ V}$	—	0.1	μAdc
	M1MA152KT1		$V_R = 75\text{ V}$	—	0.1	
Forward Voltage		V_F	$I_F = 100\text{ mA}$	—	1.2	Vdc
Reverse Breakdown Voltage	M1MA151KT1	V_R	$I_R = 100\ \mu\text{A}$	40	—	Vdc
	M1MA152KT1			80	—	
Diode Capacitance		C_D	$V_R = 0, f = 1.0\text{ MHz}$	—	2.0	pF
Reverse Recovery Time		$t_{rr}^{(2)}$	$I_F = 10\text{ mA}, V_R = 6.0\text{ V}, R_L = 100\ \Omega, I_{rr} = 0.1\ I_R$	—	3.0	ns

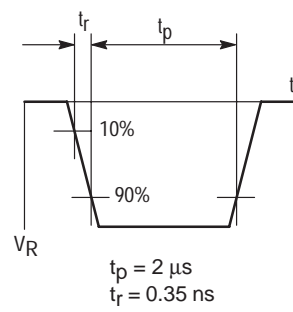
1. $t = 1\text{ SEC}$
2. t_{rr} Test Circuit

Preferred devices are Motorola recommended choices for future use and best overall value.

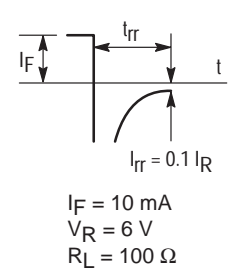
RECOVERY TIME EQUIVALENT TEST CIRCUIT



INPUT PULSE



OUTPUT PULSE



DEVICE MARKING — EXAMPLE

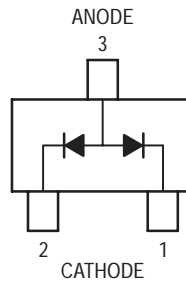
Marking Symbol		
Type No.	151K	152K
Symbol	MH	MI

The "X" represents a smaller alpha digit Date Code. The Date Code indicates the actual month in which the part was manufactured.

Common Anode Silicon Dual Switching Diodes

These Common Anode Silicon Epitaxial Planar Dual Diodes are designed for use in ultra high speed switching applications. These devices are housed in the SC-59 package which is designed for low power surface mount applications.

- Fast t_{rr} , < 10 ns
- Low C_D , < 15 pF
- Available in 8 mm Tape and Reel
Use M1MA151/2WAT1 to order the 7 inch/3000 unit reel.
Use M1MA151/2WAT3 to order the 13 inch/10,000 unit reel.



M1MA151WAT1
M1MA152WAT1

Motorola Preferred Devices

SC-59 PACKAGE
COMMON ANODE
DUAL SWITCHING DIODES
40/80 V-100 mA
SURFACE MOUNT



CASE 318D-03, STYLE 5
SC-59

MAXIMUM RATINGS ($T_A = 25^\circ\text{C}$)

Rating	Symbol	Value	Unit	
Reverse Voltage	M1MA151WAT1	V_R	40	Vdc
	M1MA152WAT1		80	
Peak Reverse Voltage	M1MA151WAT1	V_{RM}	40	Vdc
	M1MA152WAT1		80	
Forward Current	Single	I_F	100	mAdc
	Dual		150	
Peak Forward Current	Single	I_{FM}	225	mAdc
	Dual		340	
Peak Forward Surge Current	Single	$I_{FSM}^{(1)}$	500	mAdc
	Dual		750	

THERMAL CHARACTERISTICS

Rating	Symbol	Max	Unit
Power Dissipation	P_D	200	mW
Junction Temperature	T_J	150	$^\circ\text{C}$
Storage Temperature	T_{stg}	-55 to +150	$^\circ\text{C}$

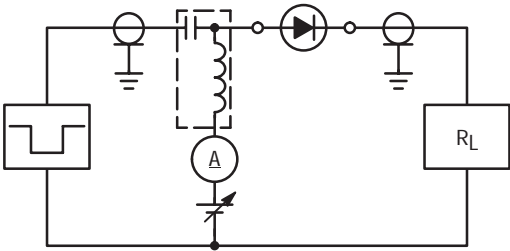
ELECTRICAL CHARACTERISTICS ($T_A = 25^\circ\text{C}$)

Characteristic	Symbol	Condition	Min	Max	Unit	
Reverse Voltage Leakage Current	M1MA151WAT1	I_R	$V_R = 35\text{ V}$	—	0.1	μAdc
	M1MA152WAT1		$V_R = 75\text{ V}$	—	0.1	
Forward Voltage	V_F	$I_F = 100\text{ mA}$	—	1.2	Vdc	
Reverse Breakdown Voltage	M1MA151WAT1	V_R	$I_R = 100\ \mu\text{A}$	40	—	Vdc
	M1MA152WAT1			80	—	
Diode Capacitance	C_D	$V_R = 0, f = 1.0\text{ MHz}$	—	15	pF	
Reverse Recovery Time	$t_{rr}^{(2)}$	$I_F = 10\text{ mA}, V_R = 6.0\text{ V}, R_L = 100\ \Omega, I_{rr} = 0.1 I_R$	—	10	ns	

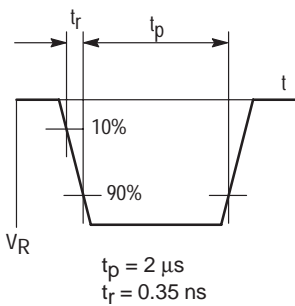
1. $t = 1\text{ SEC}$
2. t_{rr} Test Circuit

Preferred devices are Motorola recommended choices for future use and best overall value.

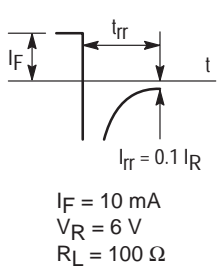
RECOVERY TIME EQUIVALENT TEST CIRCUIT



INPUT PULSE



OUTPUT PULSE



DEVICE MARKING — EXAMPLE

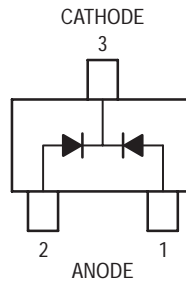
Marking Symbol		
Type No.	151WA	152WA
Symbol	MN	MO

The "X" represents a smaller alpha digit Date Code. The Date Code indicates the actual month in which the part was manufactured.

Common Cathode Silicon Dual Switching Diodes

These Common Cathode Silicon Epitaxial Planar Dual Diodes are designed for use in ultra high speed switching applications. These devices are housed in the SC-59 package which is designed for low power surface mount applications.

- Fast t_{rr} , < 3.0 ns
- Low C_D , < 2.0 pF
- Available in 8 mm Tape and Reel
 - Use M1MA151/2WKT1 to order the 7 inch/3000 unit reel.
 - Use M1MA151/2WKT3 to order the 13 inch/10,000 unit reel.



M1MA151WKT1
M1MA152WKT1

Motorola Preferred Devices

SC-59 PACKAGE
COMMON CATHODE
DUAL SWITCHING DIODES
40/80 V-100 mA
SURFACE MOUNT



CASE 318D-03, STYLE 3
SC-59

MAXIMUM RATINGS ($T_A = 25^\circ\text{C}$)

Rating	Symbol	Value	Unit	
Reverse Voltage	M1MA151WKT1	V_R	40	Vdc
	M1MA152WKT1		80	
Peak Reverse Voltage	M1MA151WKT1	V_{RM}	40	Vdc
	M1MA152WKT1		80	
Forward Current	Single	I_F	100	mAdc
	Dual		150	
Peak Forward Current	Single	I_{FM}	225	mAdc
	Dual		340	
Peak Forward Surge Current	Single	$I_{FSM}^{(1)}$	500	mAdc
	Dual		750	

THERMAL CHARACTERISTICS

Rating	Symbol	Max	Unit
Power Dissipation	P_D	200	mW
Junction Temperature	T_J	150	$^\circ\text{C}$
Storage Temperature	T_{stg}	-55 to +150	$^\circ\text{C}$

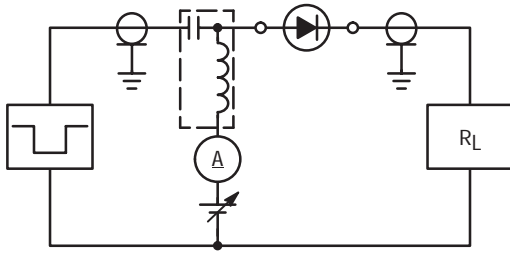
ELECTRICAL CHARACTERISTICS ($T_A = 25^\circ\text{C}$)

Characteristic	Symbol	Condition	Min	Max	Unit	
Reverse Voltage Leakage Current	M1MA151WKT1	I_R	$V_R = 35\text{ V}$	—	0.1	μA
	M1MA152WKT1		$V_R = 75\text{ V}$	—	0.1	
Forward Voltage	V_F	$I_F = 100\text{ mA}$	—	1.2	Vdc	
Reverse Breakdown Voltage	M1MA151WKT1	V_R	$I_R = 100\ \mu\text{A}$	40	—	Vdc
	M1MA152WKT1			80	—	
Diode Capacitance	C_D	$V_R = 0, f = 1.0\text{ MHz}$	—	2.0	pF	
Reverse Recovery Time	$t_{rr}^{(2)}$	$I_F = 10\text{ mA}, V_R = 6.0\text{ V}, R_L = 100\ \Omega, I_{rr} = 0.1 I_R$	—	3.0	ns	

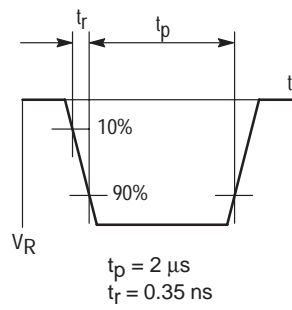
1. $t = 1\text{ SEC}$
2. t_{rr} Test Circuit

Preferred devices are Motorola recommended choices for future use and best overall value.

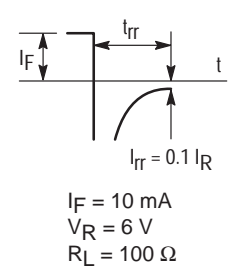
RECOVERY TIME EQUIVALENT TEST CIRCUIT



INPUT PULSE



OUTPUT PULSE



DEVICE MARKING — EXAMPLE

Marking Symbol		
Type No.	151WK	152WK
Symbol	MT	MU

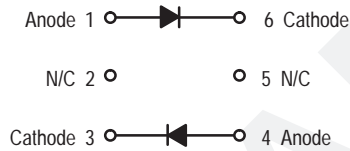
The "X" represents a smaller alpha digit Date Code. The Date Code indicates the actual month in which the part was manufactured.

Preliminary Information

Dual Schottky Barrier Diodes

These Schottky barrier diodes are designed for high speed switching applications, circuit protection, and voltage clamping. Extremely low forward voltage reduces conduction loss. Miniature surface mount package is excellent for hand held and portable applications where space is limited.

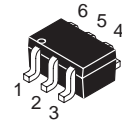
- Extremely Fast Switching Speed
- Low Forward Voltage — 0.35 V @ $I_F = 10 \text{ mAdc}$



MBD54DWT1

Motorola Preferred Device

**30 VOLTS
DUAL HOT-CARRIER
DETECTOR AND SWITCHING
DIODES**



**CASE 419B-01, STYLE 6
SOT-363**

MAXIMUM RATINGS ($T_J = 125^\circ\text{C}$ unless otherwise noted)

Rating	Symbol	Value	Unit
Reverse Voltage	V_R	30	Volts
Forward Power Dissipation @ $T_A = 25^\circ\text{C}$ Derate above 25°C	P_F	150 1.2	mW mW/ $^\circ\text{C}$
Operating Junction Temperature Range	T_J	-55 to +150	$^\circ\text{C}$
Storage Temperature Range	T_{stg}	-55 to +150	$^\circ\text{C}$

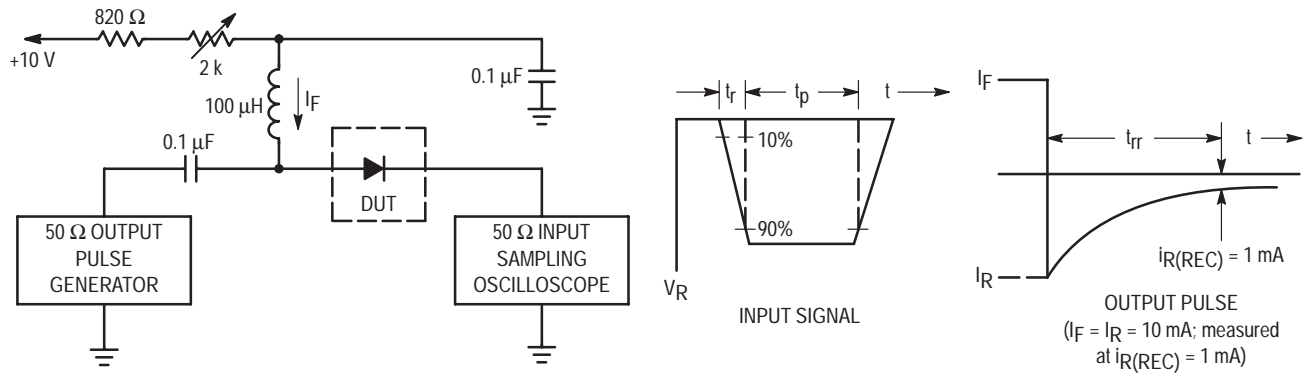
DEVICE MARKING

MBD54DWT1 = BL

ELECTRICAL CHARACTERISTICS ($T_A = 25^\circ\text{C}$ unless otherwise noted) (EACH DIODE)

Characteristic	Symbol	Min	Typ	Max	Unit
Reverse Breakdown Voltage ($I_R = 10 \mu\text{A}$)	$V_{(BR)R}$	30	—	—	Volts
Total Capacitance ($V_R = 1.0 \text{ V}$, $f = 1.0 \text{ MHz}$)	C_T	—	7.6	10	pF
Reverse Leakage ($V_R = 25 \text{ V}$)	I_R	—	0.5	2.0	μAdc
Forward Voltage ($I_F = 0.1 \text{ mAdc}$)	V_F	—	0.22	0.24	Vdc
Forward Voltage ($I_F = 30 \text{ mAdc}$)	V_F	—	0.41	0.5	Vdc
Forward Voltage ($I_F = 100 \text{ mAdc}$)	V_F	—	0.52	1.0	Vdc
Reverse Recovery Time ($I_F = I_R = 10 \text{ mAdc}$, $I_{R(REC)} = 1.0 \text{ mAdc}$) Figure 1	t_{rr}	—	—	5.0	ns
Forward Voltage ($I_F = 1.0 \text{ mAdc}$)	V_F	—	0.29	0.32	Vdc
Forward Voltage ($I_F = 10 \text{ mAdc}$)	V_F	—	0.35	0.40	Vdc

Preferred devices are Motorola recommended choices for future use and best overall value.



- Notes: 1. A 2.0 kΩ variable resistor adjusted for a Forward Current (I_F) of 10 mA.
 2. Input pulse is adjusted so $I_{R(\text{peak})}$ is equal to 10 mA.
 3. $t_p \gg t_{rr}$

Figure 1. Recovery Time Equivalent Test Circuit

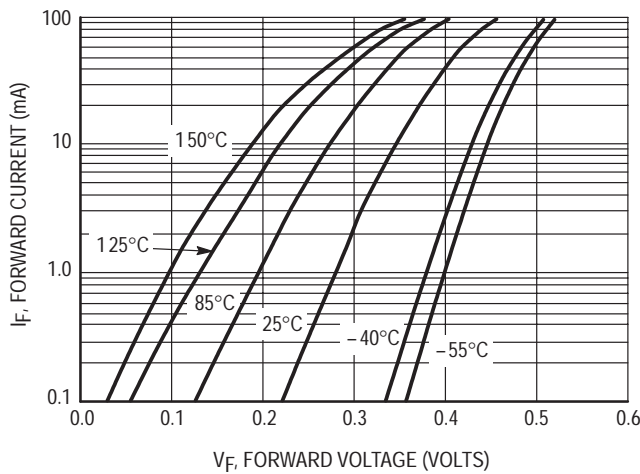


Figure 2. Forward Voltage

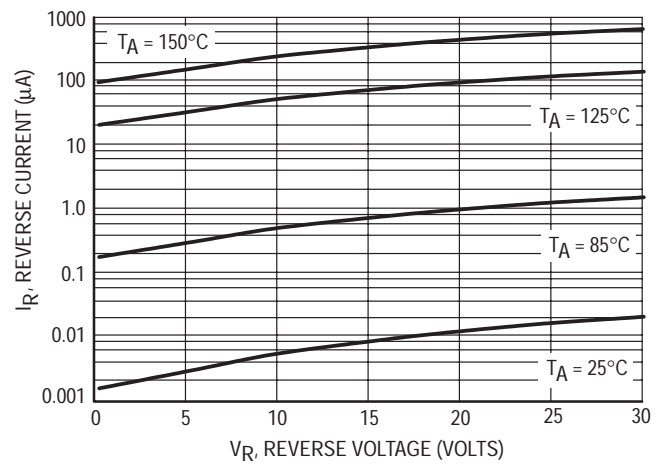


Figure 3. Leakage Current

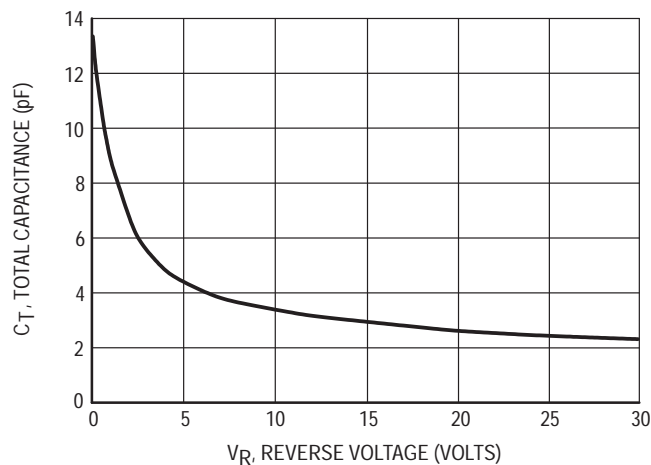


Figure 4. Total Capacitance

Schottky Barrier Diodes

Designed primarily for UHF mixer applications but suitable also for use in detector and ultra-fast switching circuits. Supplied in an inexpensive plastic package for low-cost, high-volume consumer requirements. Also available in Surface Mount package.

- Low Noise Figure — 6.0 dB Typ @ 1.0 GHz
- Very Low Capacitance — Less Than 1.0 pF @ Zero Volts
- High Forward Conductance — 0.5 Volts (Typ) @ $I_F = 10$ mA



MAXIMUM RATINGS

Rating	Symbol	MBD101	MMBD101LT1	Unit
		Value		
Reverse Voltage	V_R	7.0		Volts
Forward Power Dissipation @ $T_A = 25^\circ\text{C}$ Derate above 25°C	P_F	280 2.2	225 1.8	mW mW/ $^\circ\text{C}$
Junction Temperature	T_J	+150		$^\circ\text{C}$
Storage Temperature Range	T_{stg}	-55 to +150		$^\circ\text{C}$

DEVICE MARKING

MMBD101LT1 = 4M

ELECTRICAL CHARACTERISTICS ($T_A = 25^\circ\text{C}$ unless otherwise noted)

Characteristic	Symbol	Min	Typ	Max	Unit
Reverse Breakdown Voltage ($I_R = 10 \mu\text{A dc}$)	$V_{(BR)R}$	7.0	10	—	Volts
Diode Capacitance ($V_R = 0$, $f = 1.0$ MHz, Note 1)	C_T	—	0.88	1.0	pF
Forward Voltage ⁽¹⁾ ($I_F = 10$ mA dc)	V_F	—	0.5	0.6	Volts
Reverse Leakage ($V_R = 3.0$ V dc)	I_R	—	0.02	0.25	$\mu\text{A dc}$

NOTE: MMBD101LT1 is also available in bulk packaging. Use MMBD101L as the device title to order this device in bulk.

Preferred devices are Motorola recommended choices for future use and best overall value.

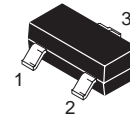
MBD101 MMBD101LT1

Motorola Preferred Devices

SILICON SCHOTTKY BARRIER DIODES



CASE 182-02, STYLE 1
(TO-226AC)



CASE 318-08, STYLE 8
SOT-23 (TO-236AB)

TYPICAL CHARACTERISTICS

($T_A = 25^\circ\text{C}$ unless noted)

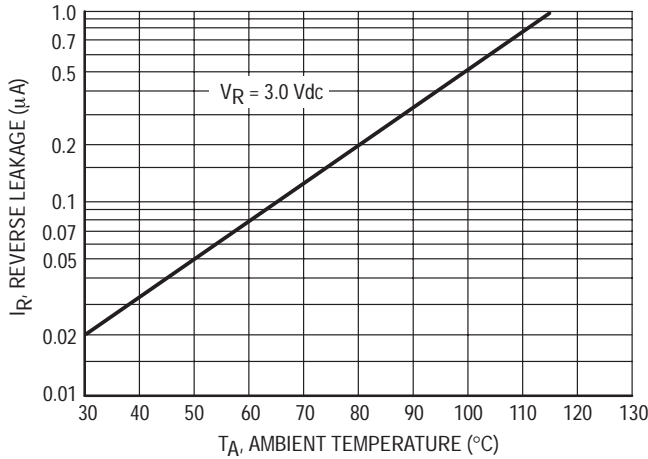


Figure 1. Reverse Leakage

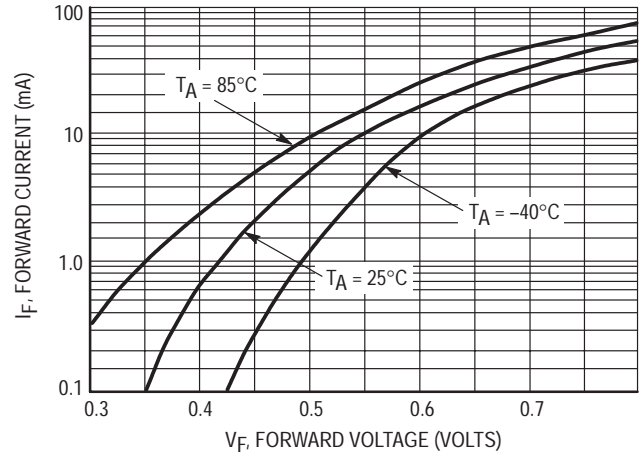


Figure 2. Forward Voltage

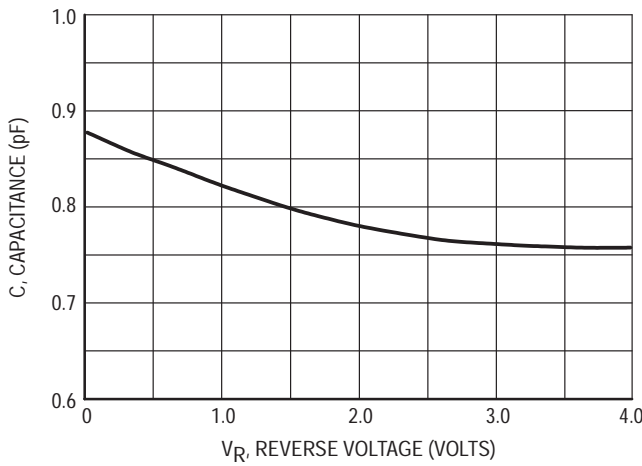


Figure 3. Capacitance

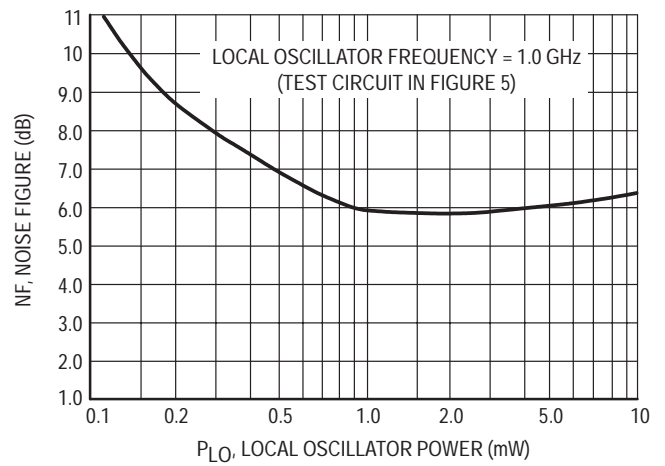


Figure 4. Noise Figure

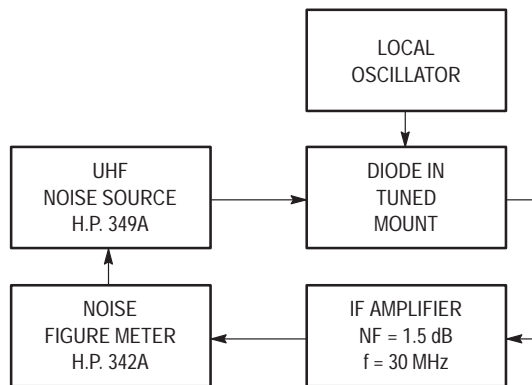


Figure 5. Noise Figure Test Circuit

NOTES ON TESTING AND SPECIFICATIONS

- Note 1 — C_C and C_T are measured using a capacitance bridge (Boonton Electronics Model 75A or equivalent).
- Note 2 — Noise figure measured with diode under test in tuned diode mount using UHF noise source and local oscillator (LO) frequency of 1.0 GHz. The LO power is adjusted for 1.0 mW. IF amplifier NF = 1.5 dB, $f = 30$ MHz, see Figure 5.
- Note 3 — L_S is measured on a package having a short instead of a die, using an impedance bridge (Boonton Radio Model 250A RX Meter).

Dual Schottky Barrier Diodes

Application circuit designs are moving toward the consolidation of device count and into smaller packages. The new SOT-363 package is a solution which simplifies circuit design, reduces device count, and reduces board space by putting two discrete devices in one small six-leaded package. The SOT-363 is ideal for low-power surface mount applications where board space is at a premium, such as portable products.

Surface Mount Comparisons:

	SOT-363	SOT-23
Area (mm ²)	4.6	7.6
Max Package P _D (mW)	120	225
Device Count	2	1

Space Savings:

Package	1 × SOT-23	2 × SOT-23
SOT-363	40%	70%

The MBD110DW, MBD330DW, and MBD770DW devices are spin-offs of our popular MMBD101LT1, MMBD301LT1, and MMBD701LT1 SOT-23 devices. They are designed for high-efficiency UHF and VHF detector applications. Readily available to many other fast switching RF and digital applications.

- Extremely Low Minority Carrier Lifetime
- Very Low Capacitance
- Low Reverse Leakage

MAXIMUM RATINGS

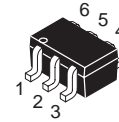
Rating		Symbol	Value	Unit
Reverse Voltage	MBD110DWT1 MBD330DWT1 MBD770DWT1	V _R	7.0 30 70	Vdc
Forward Power Dissipation T _A = 25°C		P _F	120	mW
Junction Temperature		T _J	-55 to +125	°C
Storage Temperature Range		T _{stg}	-55 to +150	°C

DEVICE MARKING

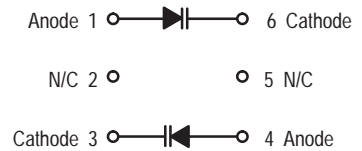
MBD110DWT1 = M4
MBD330DWT1 = T4
MBD770DWT1 = H5

MBD110DWT1
MBD330DWT1
MBD770DWT1

Motorola Preferred Devices



CASE 419B-01, STYLE 6
SOT-363



Preferred devices are Motorola recommended choices for future use and best overall value.

ELECTRICAL CHARACTERISTICS ($T_A = 25^\circ\text{C}$ unless otherwise noted)

Characteristic		Symbol	Min	Typ	Max	Unit
Reverse Breakdown Voltage ($I_R = 10 \mu\text{A}$)	MBD110DWT1 MBD330DWT1 MBD770DWT1	$V_{(BR)R}$	7.0 30 70	10 — —	— — —	Volts
Diode Capacitance ($V_R = 0$, $f = 1.0 \text{ MHz}$, Note 1)	MBD110DWT1	C_T	—	0.88	1.0	pF
Total Capacitance ($V_R = 15 \text{ Volts}$, $f = 1.0 \text{ MHz}$) ($V_R = 20 \text{ Volts}$, $f = 1.0 \text{ MHz}$)	MBD330DWT1 MBD770DWT1	C_T	— —	0.9 0.5	1.5 1.0	pF
Reverse Leakage ($V_R = 3.0 \text{ V}$) ($V_R = 25 \text{ V}$) ($V_R = 35 \text{ V}$)	MBD110DWT1 MBD330DWT1 MBD770DWT1	I_R	— — —	0.02 13 9.0	0.25 200 200	μA nAdc nAdc
Noise Figure ($f = 1.0 \text{ GHz}$, Note 2)	MBD110DWT1	NF	—	6.0	—	dB
Forward Voltage ($I_F = 10 \text{ mA}$) ($I_F = 1.0 \text{ mAdc}$) ($I_F = 10 \text{ mA}$) ($I_F = 1.0 \text{ mAdc}$) ($I_F = 10 \text{ mA}$)	MBD110DWT1 MBD330DWT1 — MBD770DWT1 —	V_F	— — — — —	0.5 0.38 0.52 0.42 0.7	0.6 0.45 0.6 0.5 1.0	Vdc

TYPICAL CHARACTERISTICS
MBD110DWT1

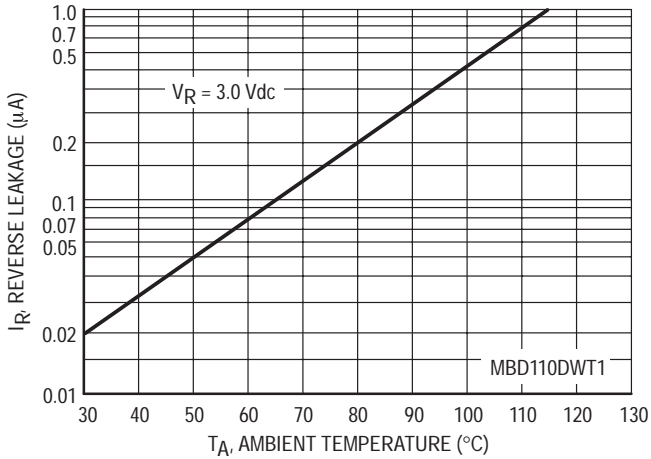


Figure 1. Reverse Leakage

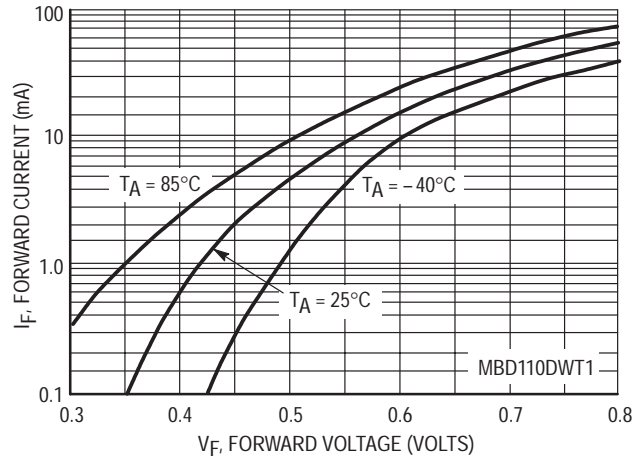


Figure 2. Forward Voltage

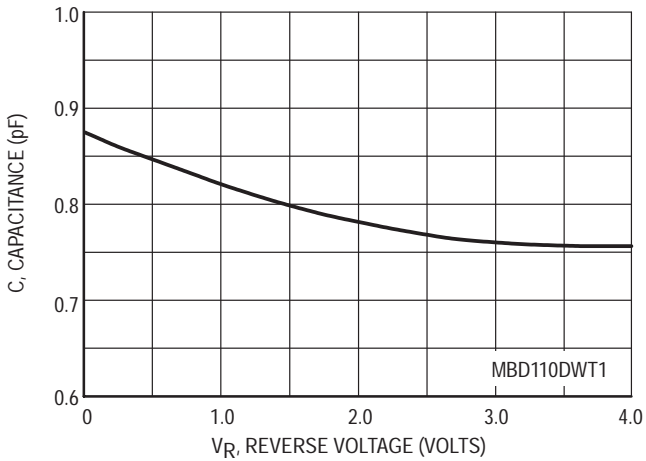


Figure 3. Capacitance

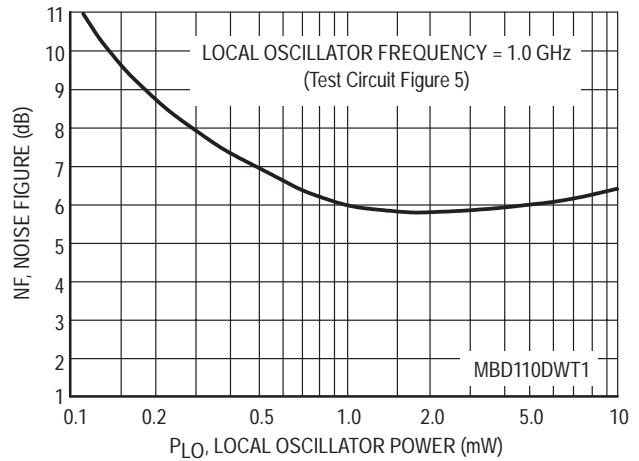


Figure 4. Noise Figure

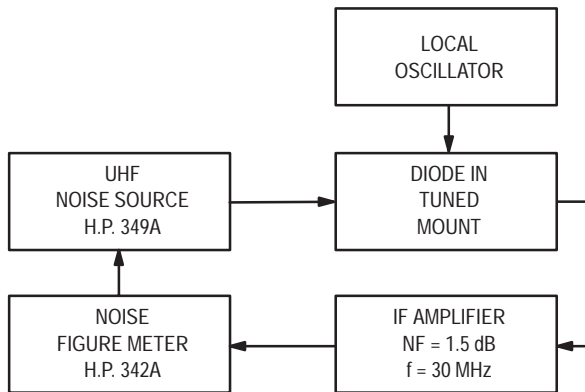


Figure 5. Noise Figure Test Circuit

NOTES ON TESTING AND SPECIFICATIONS

- Note 1 – C_C and C_T are measured using a capacitance bridge (Boonton Electronics Model 75A or equivalent).
- Note 2 – Noise figure measured with diode under test in tuned diode mount using UHF noise source and local oscillator (LO) frequency of 1.0 GHz. The LO power is adjusted for 1.0 mW. IF amplifier NF = 1.5 dB, $f = 30$ MHz, see Figure 5.
- Note 3 – L_S is measured on a package having a short instead of a die, using an impedance bridge (Boonton Radio Model 250A RX Meter).

TYPICAL CHARACTERISTICS
MBD330DWT1

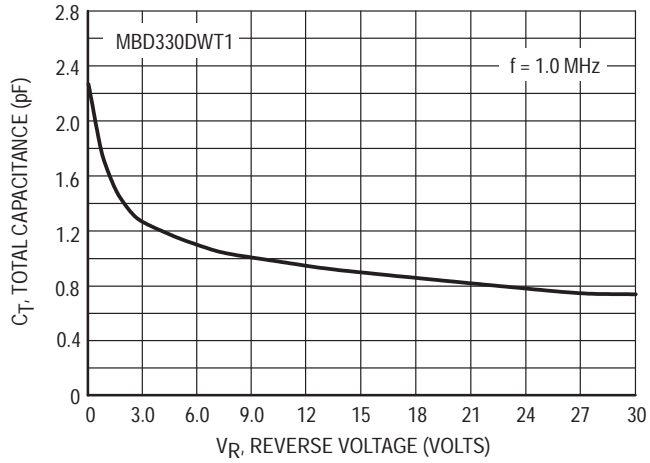


Figure 6. Total Capacitance

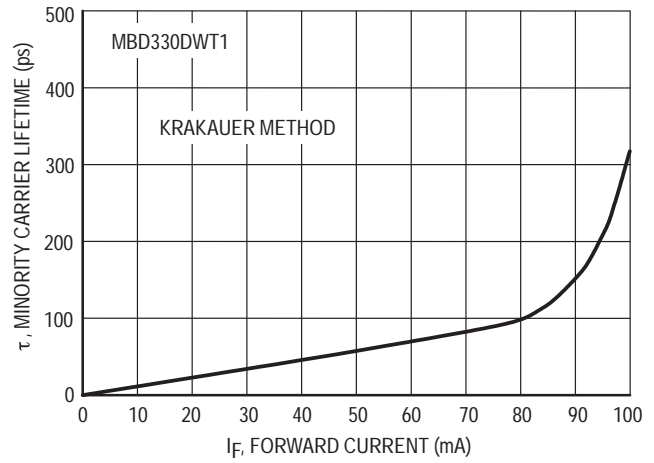


Figure 7. Minority Carrier Lifetime

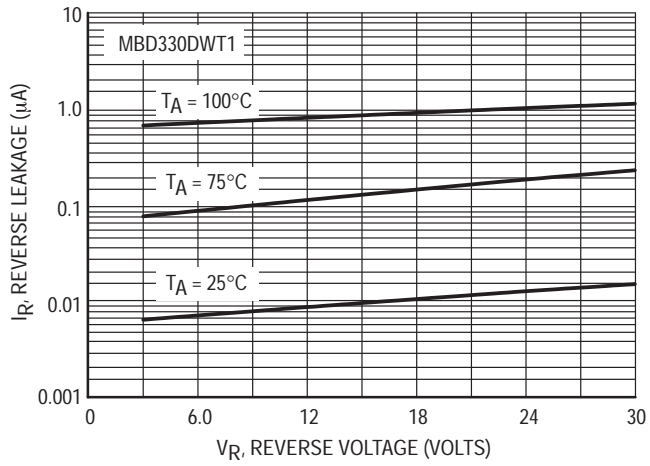


Figure 8. Reverse Leakage

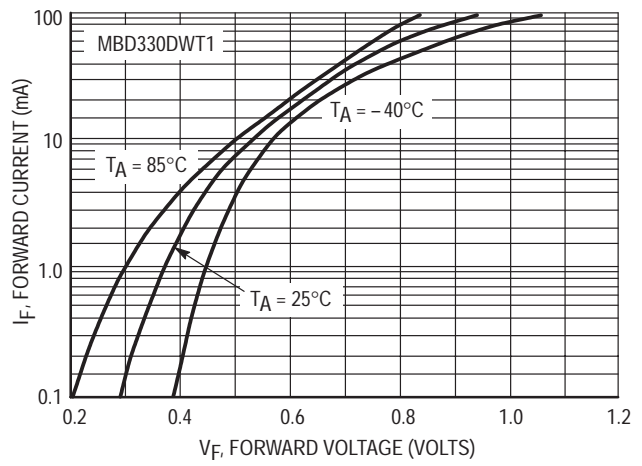


Figure 9. Forward Voltage

TYPICAL CHARACTERISTICS
MBD770DWT1

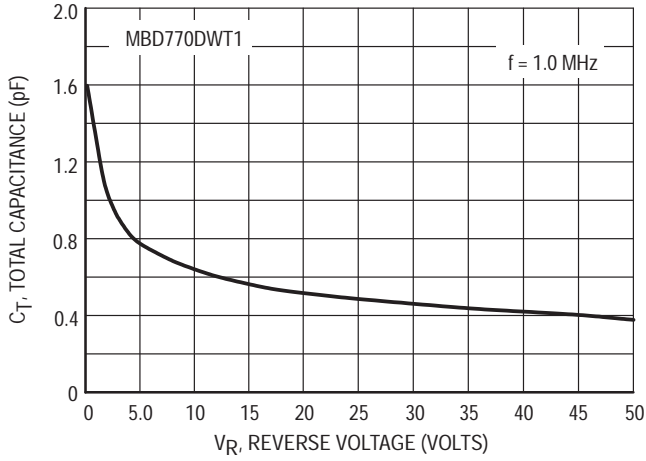


Figure 10. Total Capacitance

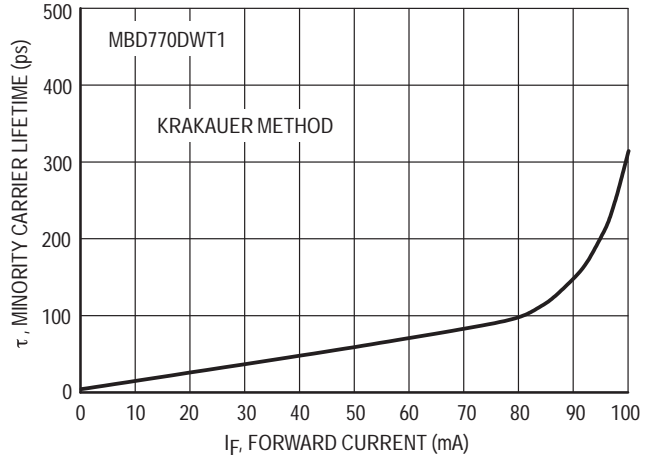


Figure 11. Minority Carrier Lifetime

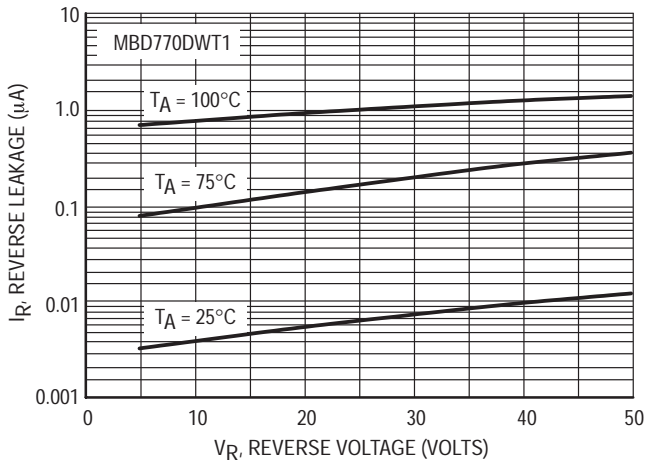


Figure 12. Reverse Leakage

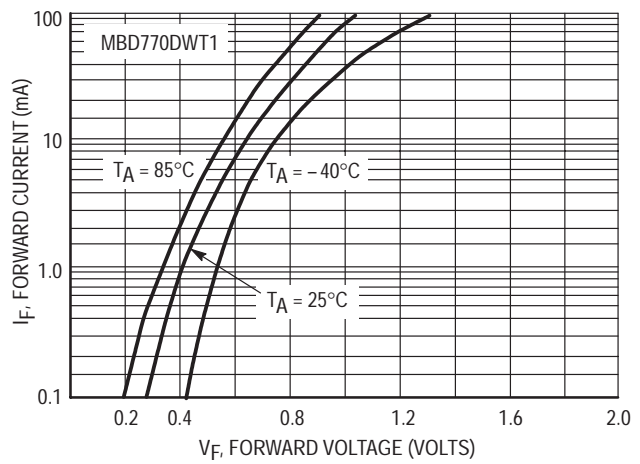


Figure 13. Forward Voltage

Silicon Hot-Carrier Diodes

Schottky Barrier Diodes

These devices are designed primarily for high-efficiency UHF and VHF detector applications. They are readily adaptable to many other fast switching RF and digital applications. They are supplied in an inexpensive plastic package for low-cost, high-volume consumer and industrial/commercial requirements. They are also available in a Surface Mount package.

- Extremely Low Minority Carrier Lifetime – 15 ps (Typ)
- Very Low Capacitance – 1.5 pF (Max) @ $V_R = 15\text{ V}$
- Low Reverse Leakage – $I_R = 13\text{ nAdc}$ (Typ) MBD301, MMBD301

MAXIMUM RATINGS ($T_J = 125^\circ\text{C}$ unless otherwise noted)

		MBD301	MMBD301LT1	
Rating	Symbol	Value		Unit
Reverse Voltage	V_R	30		Volts
Forward Power Dissipation @ $T_A = 25^\circ\text{C}$ Derate above 25°C	P_F	280	200	mW
		2.8	2.0	mW/ $^\circ\text{C}$
Operating Junction Temperature Range	T_J	-55 to +125		$^\circ\text{C}$
Storage Temperature Range	T_{stg}	-55 to +150		$^\circ\text{C}$

DEVICE MARKING

MMBD301LT1 = 4T

ELECTRICAL CHARACTERISTICS ($T_A = 25^\circ\text{C}$ unless otherwise noted)

Characteristic	Symbol	Min	Typ	Max	Unit
Reverse Breakdown Voltage ($I_R = 10\ \mu\text{A}$)	$V_{(BR)R}$	30	—	—	Volts
Total Capacitance ($V_R = 15\text{ V}$, $f = 1.0\text{ MHz}$) Figure 1	C_T	—	0.9	1.5	pF
Reverse Leakage ($V_R = 25\text{ V}$) Figure 3	I_R	—	13	200	nAdc
Forward Voltage ($I_F = 1.0\text{ mAdc}$) Figure 4	V_F	—	0.38	0.45	Vdc
Forward Voltage ($I_F = 10\text{ mAdc}$) Figure 4	V_F	—	0.52	0.6	Vdc

NOTE: MMBD301LT1 is also available in bulk packaging. Use MMBD301L as the device title to order this device in bulk.

Preferred devices are Motorola recommended choices for future use and best overall value.

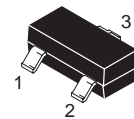
MBD301 MMBD301LT1

Motorola Preferred Devices

**30 VOLTS
SILICON HOT-CARRIER
DETECTOR AND SWITCHING
DIODES**



**CASE 182-02, STYLE 1
(TO-226AC)**



**CASE 318-08, STYLE 8
SOT-23 (TO-236AB)**



TYPICAL ELECTRICAL CHARACTERISTICS

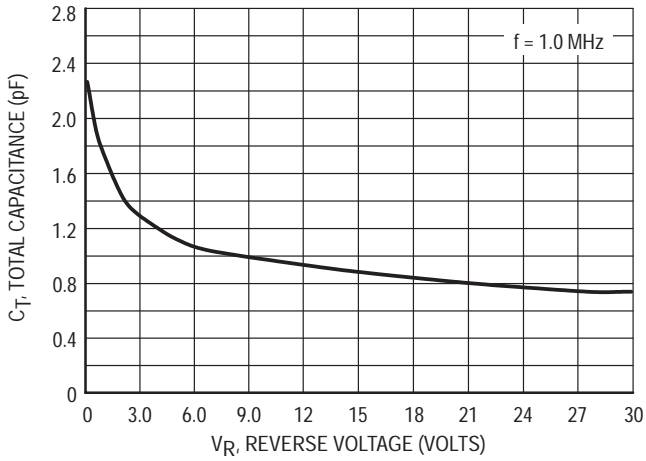


Figure 1. Total Capacitance

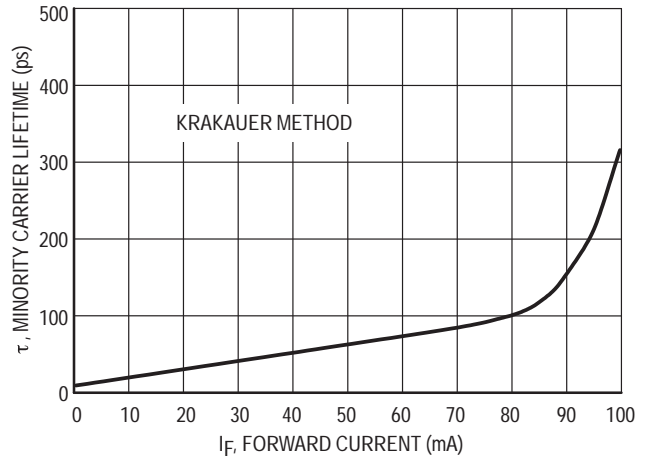


Figure 2. Minority Carrier Lifetime

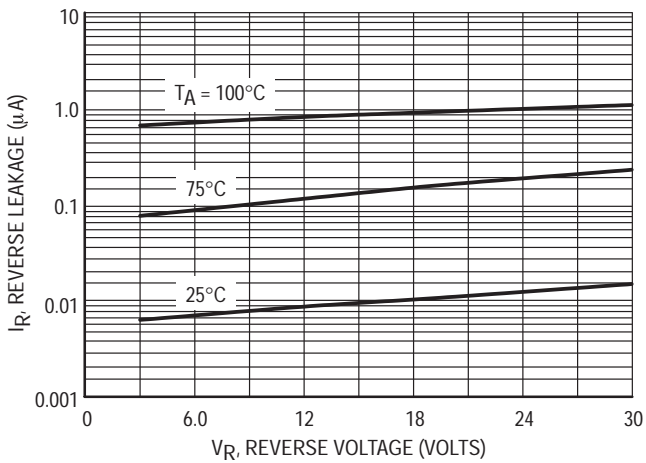


Figure 3. Reverse Leakage

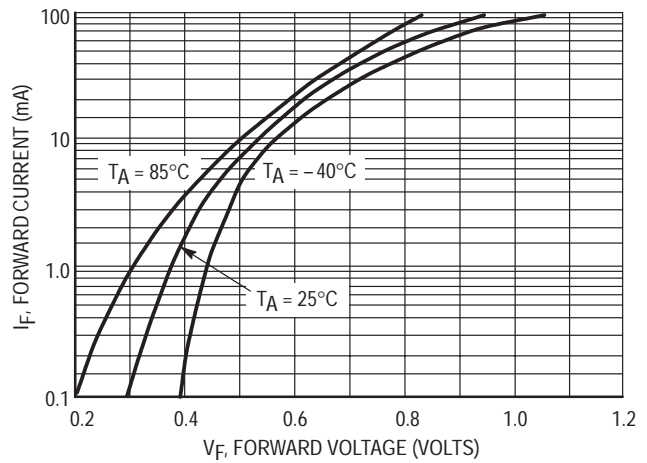


Figure 4. Forward Voltage

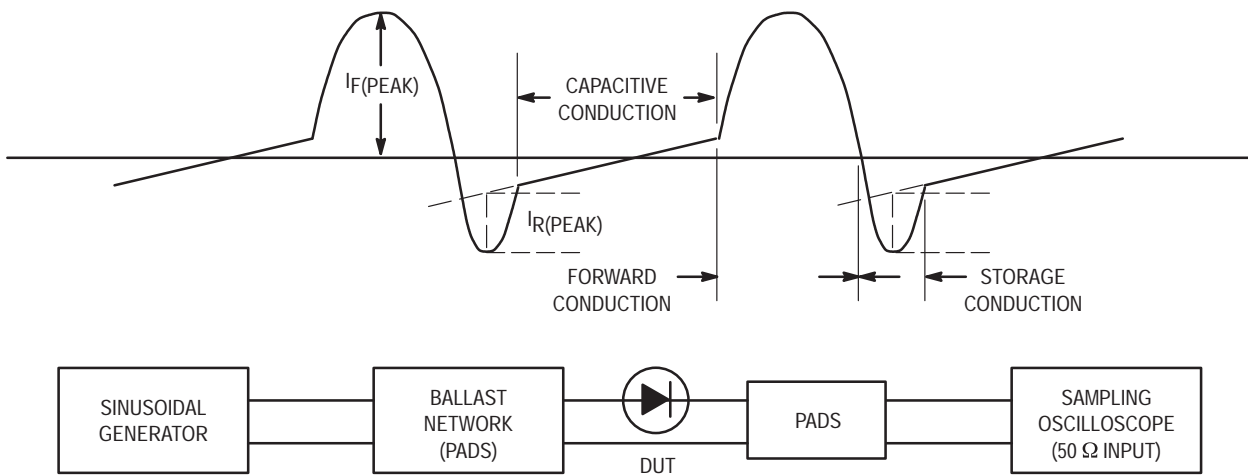


Figure 5. Krauer Method of Measuring Lifetime

Silicon Hot-Carrier Diodes

Schottky Barrier Diodes

These devices are designed primarily for high-efficiency UHF and VHF detector applications. They are readily adaptable to many other fast switching RF and digital applications. They are supplied in an inexpensive plastic package for low-cost, high-volume consumer and industrial/commercial requirements. They are also available in a Surface Mount package.

- Extremely Low Minority Carrier Lifetime – 15 ps (Typ)
- Very Low Capacitance – 1.0 pF @ $V_R = 20$ V
- High Reverse Voltage – to 70 Volts
- Low Reverse Leakage – 200 nA (Max)

MAXIMUM RATINGS ($T_J = 125^\circ\text{C}$ unless otherwise noted)

Rating	Symbol	MBD701	MMBD701LT1	Unit
		Value		
Reverse Voltage	V_R	70		Volts
Forward Power Dissipation @ $T_A = 25^\circ\text{C}$ Derate above 25°C	P_F	280	200	mW
		2.8	2.0	mW/ $^\circ\text{C}$
Operating Junction Temperature Range	T_J	-55 to +125		$^\circ\text{C}$
Storage Temperature Range	T_{stg}	-55 to +150		$^\circ\text{C}$

DEVICE MARKING

MMBD701LT1 = 5H

ELECTRICAL CHARACTERISTICS ($T_A = 25^\circ\text{C}$ unless otherwise noted)

Characteristic	Symbol	Min	Typ	Max	Unit
Reverse Breakdown Voltage ($I_R = 10 \mu\text{A}$)	$V_{(BR)R}$	70	—	—	Volts
Total Capacitance ($V_R = 20$ V, $f = 1.0$ MHz) Figure 1	C_T	—	0.5	1.0	pF
Reverse Leakage ($V_R = 35$ V) Figure 3	I_R	—	9.0	200	nA _{dc}
Forward Voltage ($I_F = 1.0$ mA _{dc}) Figure 4	V_F	—	0.42	0.5	V _{dc}
Forward Voltage ($I_F = 10$ mA _{dc}) Figure 4	V_F	—	0.7	1.0	V _{dc}

NOTE: MMBD701LT1 is also available in bulk packaging. Use MMBD701L as the device title to order this device in bulk.

Preferred devices are Motorola recommended choices for future use and best overall value.

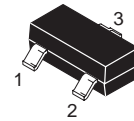
MBD701 MMBD701LT1

Motorola Preferred Devices

**70 VOLTS
HIGH-VOLTAGE
SILICON HOT-CARRIER
DETECTOR AND SWITCHING
DIODES**



**CASE 182-02, STYLE 1
(TO-226AC)**



**CASE 318-08, STYLE 8
SOT-23 (TO-236AB)**



TYPICAL ELECTRICAL CHARACTERISTICS

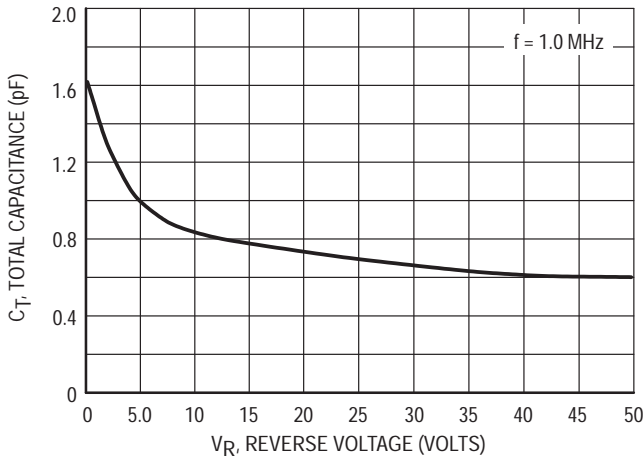


Figure 1. Total Capacitance

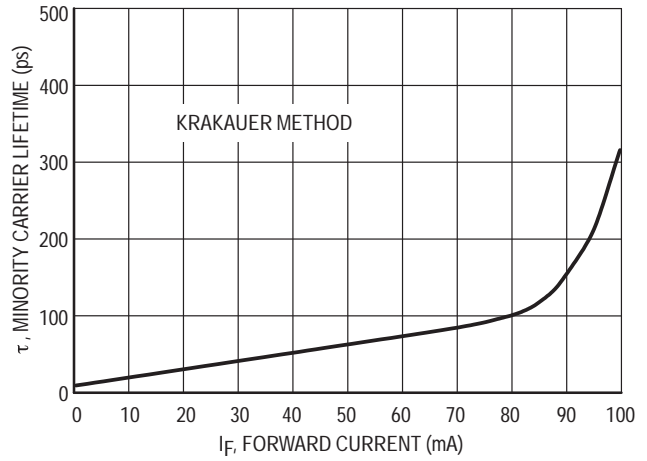


Figure 2. Minority Carrier Lifetime

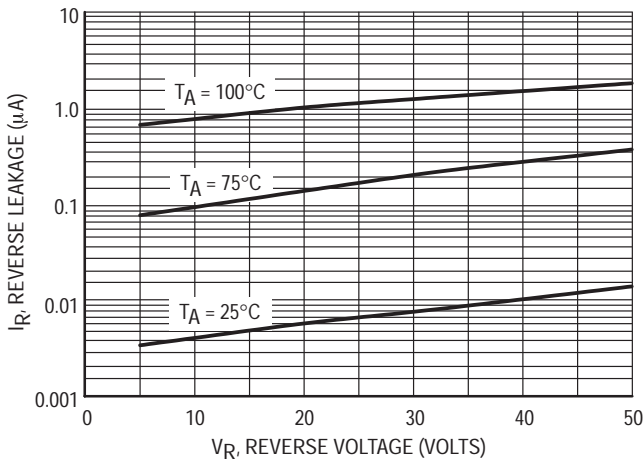


Figure 3. Reverse Leakage

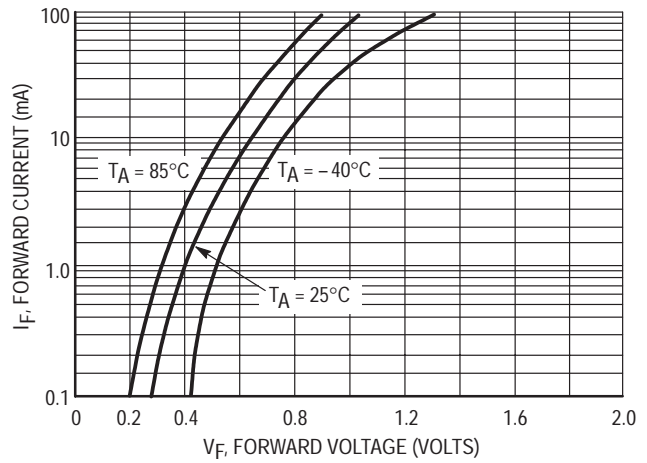


Figure 4. Forward Voltage

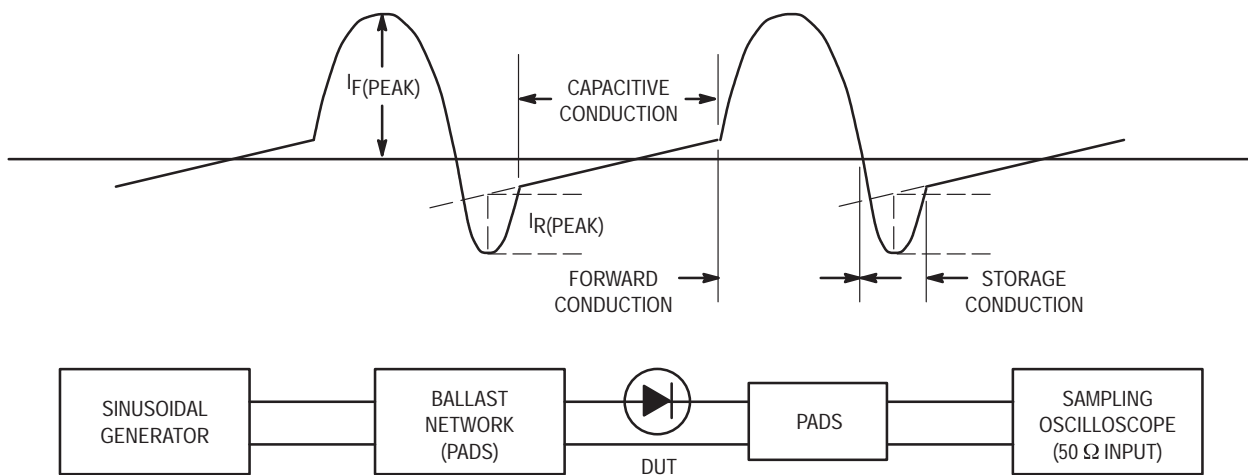
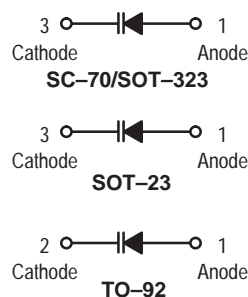


Figure 5. Krakauer Method of Measuring Lifetime

Silicon Epicap Diodes

Designed for general frequency control and tuning applications; providing solid-state reliability in replacement of mechanical tuning methods.

- High Q with Guaranteed Minimum Values at VHF Frequencies
- Controlled and Uniform Tuning Ratio
- Available in Surface Mount Package



MAXIMUM RATINGS

Rating	Symbol	MBV109T1	MMBV109LT1	MV209	Unit
Reverse Voltage	V_R	30			Vdc
Forward Current	I_F	200			mAdc
Forward Power Dissipation @ $T_A = 25^\circ\text{C}$ Derate above 25°C	P_D	280 2.8	200 2.0	200 1.6	mW mW/ $^\circ\text{C}$
Junction Temperature	T_J	+125			$^\circ\text{C}$
Storage Temperature Range	T_{stg}	-55 to +150			$^\circ\text{C}$

DEVICE MARKING

MBV109T1 = J4A, MMBV109LT1 = M4A, MV209 = MV209

ELECTRICAL CHARACTERISTICS ($T_A = 25^\circ\text{C}$ unless otherwise noted.)

Characteristic	Symbol	Min	Typ	Max	Unit
Reverse Breakdown Voltage ($I_R = 10 \mu\text{Adc}$)	$V_{(BR)R}$	30	—	—	Vdc
Reverse Voltage Leakage Current ($V_R = 25 \text{Vdc}$)	I_R	—	—	0.1	μAdc
Diode Capacitance Temperature Coefficient ($V_R = 3.0 \text{Vdc}$, $f = 1.0 \text{MHz}$)	TC_C	—	300	—	ppm/ $^\circ\text{C}$

Device	C_t , Diode Capacitance $V_R = 3.0 \text{Vdc}$, $f = 1.0 \text{MHz}$ pF			Q , Figure of Merit $V_R = 3.0 \text{Vdc}$ $f = 50 \text{MHz}$	C_R , Capacitance Ratio C_3/C_{25} $f = 1.0 \text{MHz}$ (Note 1)	
	Min	Nom	Max	Min	Min	Max
MBV109T1, MMBV109LT1, MV209	26	29	32	200	5.0	6.5

1. C_R is the ratio of C_t measured at 3 Vdc divided by C_t measured at 25 Vdc.

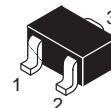
MMBV109LT1 is also available in bulk packaging. Use **MMBV109L** as the device title to order this device in bulk.

Preferred devices are Motorola recommended choices for future use and best overall value.

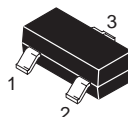
MBV109T1
MMBV109LT1*
MV209*

* Motorola Preferred Devices

26–32 pF
VOLTAGE VARIABLE
CAPACITANCE DIODES



CASE 419-02, STYLE 3
SC-70/SOT-323



CASE 318-08, STYLE 6
SOT-23 (TO-236AB)



CASE 182-02, STYLE 1
TO-92 (TO-226AC)

(Replaces MMBV109LT1/D)

MBV109T1 MMBV109LT1 MV209

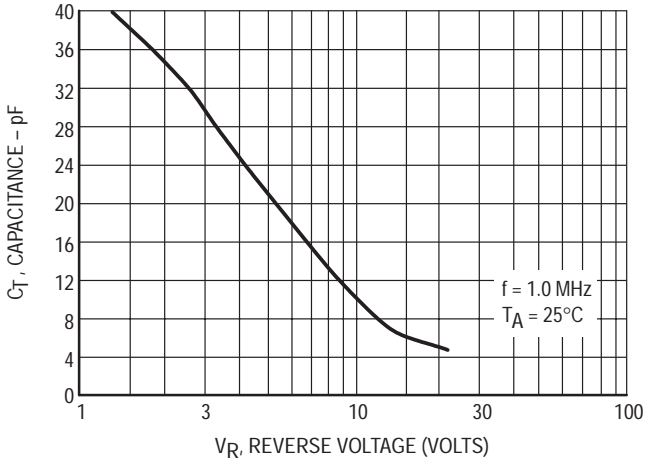


Figure 1. DIODE CAPACITANCE

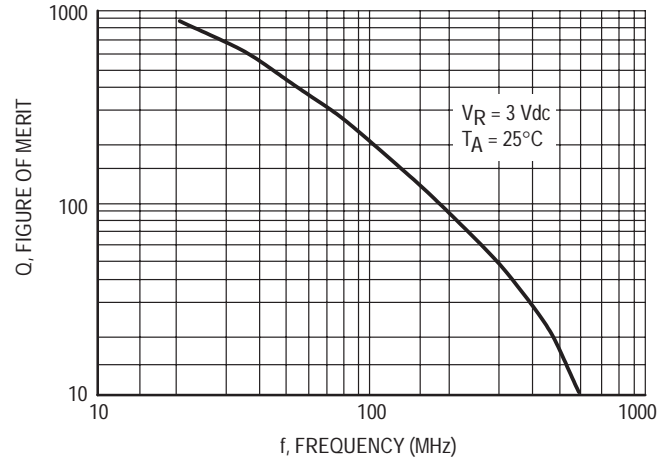


Figure 2. FIGURE OF MERIT

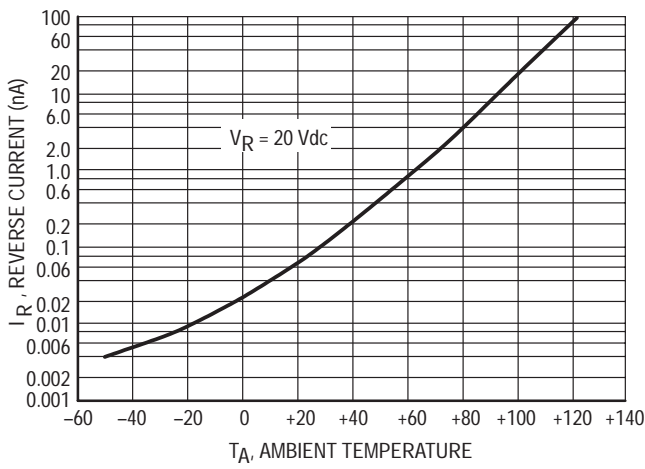


Figure 3. LEAKAGE CURRENT

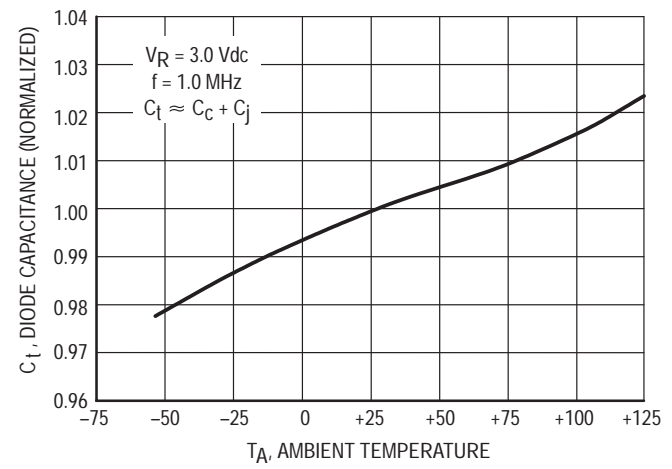


Figure 4. DIODE CAPACITANCE

NOTES ON TESTING AND SPECIFICATIONS

1. C_R is the ratio of C_t measured at 3.0 Vdc divided by C_t measured at 25 Vdc.

Monolithic Diode Arrays

Surface Mount Diode Arrays

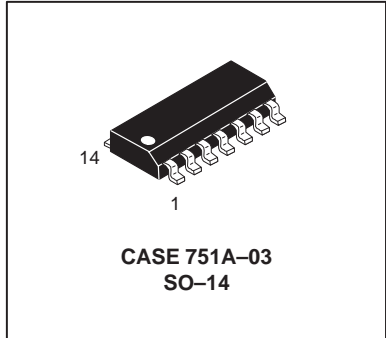
These diode arrays are multiple diode junctions fabricated by a planar process and mounted in integrated circuit packages for use in high-current, fast-switching core-driver applications. These arrays offer many of the advantages of integrated circuits such as high-density packaging and improved reliability. These advantages result from such factors as fewer glass-to-metal seals.

- Designed for Use in Computers and Peripheral Equipment
- Applications Include:
 - Magnetic Cores
 - Thin-Film Memories
 - Plated-Wire Memories
 - Decoding or Encoding Applications

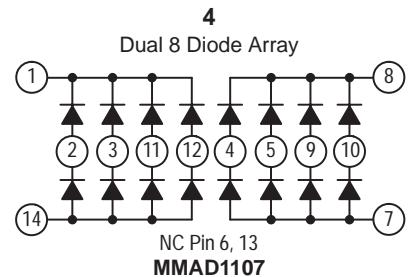
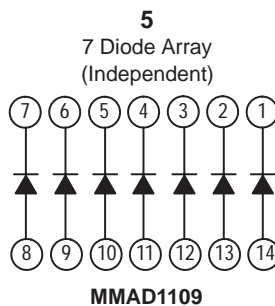
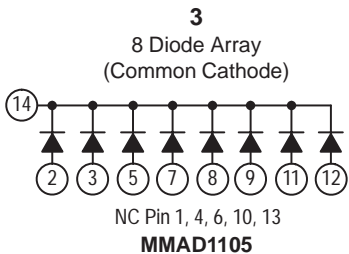
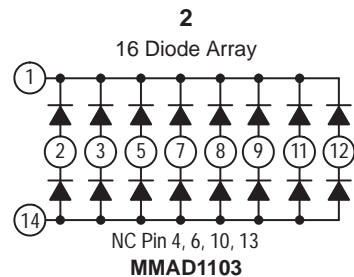
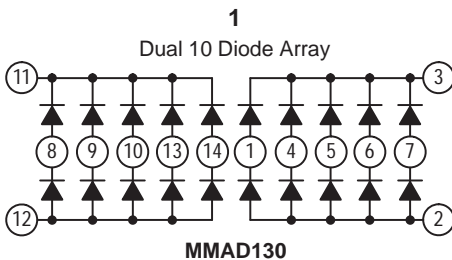
MAXIMUM RATINGS

Rating	Symbol	Value	Unit
Peak Reverse Voltage	V_{RM}	50	Vdc
Steady-State Reverse Voltage	V_R	50	Vdc
Peak Forward Current 25°C	I_{FM}	500	mAdc
Continuous Forward Current	I_F	400	mAdc
Power Dissipation Derating Factor	P_D	500 4.0	mW mW/°C
Operating Temperature	T_A	-65 to +150	°C
Storage Temperature Range	T_{stg}	-65 to +150	°C

MMAD130
MMAD1103
MMAD1105
MMAD1107
MMAD1109



SO-14 PIN DIAGRAM



Device	Description	Diagram
MMAD130	Dual 10 Diode Array	1
MMAD1103	16 Diode Array	2
MMAD1105	8 Diode Array Common Cathode	3
MMAD1107	Dual 8 Diode Array	4
MMAD1109	7 Diode Array	5

ELECTRICAL CHARACTERISTICS (@ 25°C Free-Air Temperature)

Characteristic	Symbol	Limit		Unit
		Min	Max	
Reverse Breakdown Voltage ⁽¹⁾ ($I_R = 10 \mu\text{A}_{dc}$)	$V_{(BR)}$	50	—	Vdc
Static Reverse Current ($V_R = 40 \text{ Vdc}$)	I_R	—	0.1	μA_{dc}
Static Forward Voltage ($I_F = 100 \text{ mA}_{dc}$) ($I_F = 500 \text{ mA}_{dc}$) ⁽²⁾	V_F	—	1.2 1.6	Vdc
Peak Forward Voltage ⁽³⁾ ($I_F = 500 \text{ mA}_{dc}$)	V_{FM}	—	5.0	Vdc

SWITCHING CHARACTERISTICS (@ 25°C Free-Air Temperature)

Characteristic	Symbol	Typical Value	Unit
Forward Recovery Time ($I_F = 500 \text{ mA}_{dc}$)	t_{fr}	20	ns
Reverse Recovery Time ($I_F = 200 \text{ mA}$, $I_{RM} = 200 \text{ mA}$, $R_L = 100 \Omega$, $i_{rr} = 20 \text{ mA}$)	t_{rr}	8.0	ns

NOTES:

1. This parameter must be measured using pulse techniques. $PW = 100 \mu\text{s}$, duty cycle $\leq 20\%$.
2. This parameter is measured using pulse techniques. $PW = 300 \mu\text{s}$, duty cycle $\leq 2.0\%$. Read time is $90 \mu\text{s}$ from the leading edge of the pulse.
3. The initial instantaneous value is measured using pulse techniques. $PW = 150 \text{ ns}$, duty cycle $\leq 2.0\%$, pulse rise time $\leq 10 \text{ ns}$. The total capacitance shunting the diode is 19 pF maximum and the equipment bandwidth is 80 MHz .

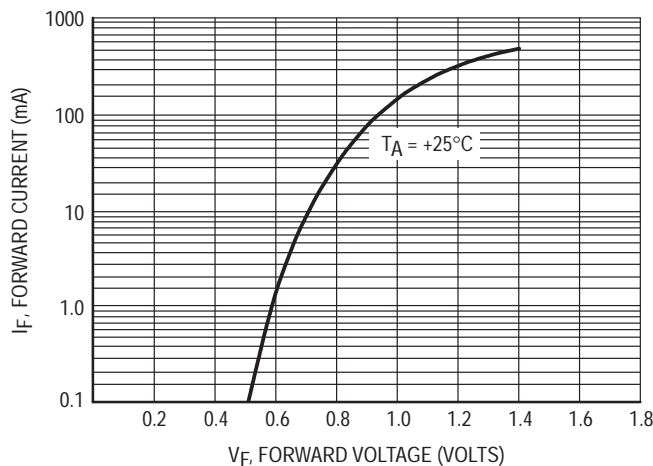


Figure 1. Typical Characteristics Static Forward Voltage

TEST PROCEDURE FOR MULTIPLE DIODES

1.0. REVERSE BIAS TESTING

1.1. LEAKAGE

Regardless of device configuration type, when testing any reverse bias condition, the forcing power supply must be applied only to the uncommon terminal of the pair. As in Figure 1, this would be pins 1 and 14. This can be referred as the high side of the test circuit. The low side of the test circuit must be connected to the common terminal of the pair which in most testers is where the current measurement is taken. This method is used to eliminate the possibility of degrading the diode in that pair which is not under test. Diode arrays with multiple pairs such as the MMAD1103, also have leakage paths in the die between common terminals of the pairs. To isolate the device under test so that the leakage from the other pairs in the package do not affect the test result, the leakage current from the common terminals of the pairs not under test must be shunted to measurement common. Figure 1 shows the test configuration for both of these cases.

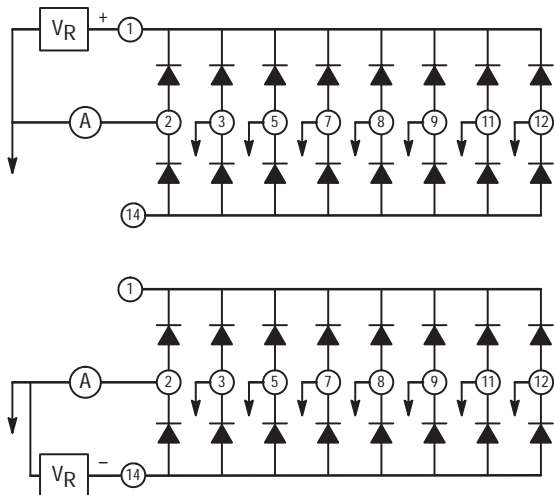


Figure 1

1.2. BREAKDOWN

It is not recommended to test breakdown on these devices due to the possibility of degrading the device. Breakdown may be checked on a curve tracer but extreme caution should be used.

2.0. FORWARD BIAS TESTING

Diode arrays are designed with the pairs in parallel; therefore, care must be taken to prevent the other diodes in the array from affecting the measured value of the diode under test. Figure 2 illustrates the proper technique to measure only the correct value of the diode under test.

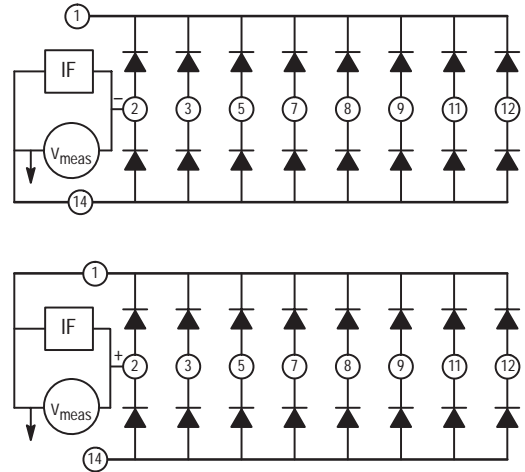


Figure 2

2.1. KELVIN CONNECTION

To achieve the best possible accuracy when testing bias currents over 10 mA, Kelvin connection to the leads of the device under test is mandatory. True Kelvin connection dictates that two test connections are made directly to the leads of the device. One is for power which is the bias supply, and the other is for sense which is for the measurement circuit. Kelvin connections are used to eliminate the effects of the connection resistance between the lead of the device and the contacts of the test handler and/or hand fixture. Figure 3 is an example of Kelvin connection.

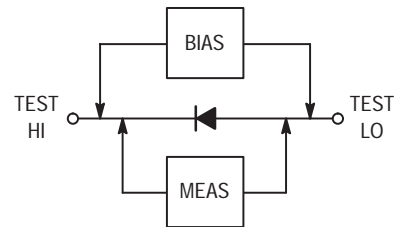


Figure 3

2.2. PULSE TESTING

When testing bias currents over 10 mA, pulse testing should be used to minimize thermal drift of the measured value. The pulse width of a pulse test is approximately 300 μs to 380 μs.

3.0. TESTING PROTOCOL

3.1. TEST TYPES

When testing in sequence all of the electrical characteristics, all reverse bias conditions should be tested before the forward bias conditions are tested.

3.2. BIASING MAGNITUDES

Tests of the same test type should be grouped together with the bias conditions in ascending order. For example:

- $V_F @ 10 \text{ mA} < 0.6 \text{ V}$
- $V_F @ 50 \text{ mA} < 0.8 \text{ V}$
- $V_F @ 100 \text{ mA} < 1 \text{ V}$
- $V_F @ 500 \text{ mA} < 1.5 \text{ V}$

Monolithic Diode Array

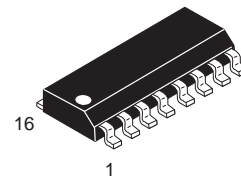
Surface Mount Isolated 8-Diode Array

This diode array is a multiple diode junction fabricated by a planar process and mounted in integrated circuit packages for use in high-current, fast-switching core-driver applications. This array offers the advantages of an integrated circuit with high-density packaging and improved reliability. This advantage results from such factors as fewer connections, more uniform device parameters, smaller size, less weight and fewer glass-to-metal seals.

- Designed for use in Computers and Peripheral Equipment
- Applications Include:
 - Magnetic Cores
 - Thin-Film Memories
 - Plated-Wire Memories
 - Decoding or Encoding

MMAD1108

Motorola Preferred Device

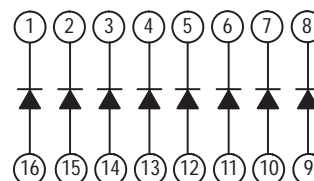


CASE 751B-05
SO-16

MAXIMUM RATINGS

Rating	Symbol	Value	Unit
Peak Reverse Voltage	V_{RM}	50	Vdc
Steady-State Reverse Voltage	V_R	50	Vdc
Peak Forward Current 25°C	I_{FM}	500	mAdc
Continuous Forward Current	I_F	400	mAdc
Power Dissipation Derating Factor	P_D	500 4.0	mW mW/°C
Operating Temperature	T_A	-65 to +150	°C
Storage Temperature Range	T_{stg}	-65 to +150	°C

PIN CONNECTION DIAGRAM



ELECTRICAL CHARACTERISTICS (@ 25°C Free-Air Temperature)

Characteristic	Symbol	Limit		Unit
		Min	Max	
Reverse Breakdown Voltage ⁽¹⁾ ($I_R = 10 \mu\text{Adc}$)	$V_{(BR)}$	50	—	Vdc
Static Reverse Current ($V_R = 40 \text{ Vdc}$)	I_R	—	0.1	μAdc
Static Forward Voltage ($I_F = 100 \text{ mAdc}$) ($I_F = 500 \text{ mAdc}$) ⁽²⁾	V_F	— —	1.2 1.6	Vdc
Peak Forward Voltage ⁽³⁾ ($I_F = 500 \text{ mAdc}$)	V_{FM}	—	5.0	Vdc

NOTES:

1. This parameter must be measured using pulse techniques. $PW = 100 \mu\text{s}$, duty cycle $\leq 20\%$.
2. This parameter is measured using pulse techniques. $PW = 300 \mu\text{s}$, duty cycle $\leq 2.0\%$. Read time is $90 \mu\text{s}$ from the leading edge of the pulse.
3. The initial instantaneous value is measured using pulse techniques. $PW = 150 \text{ ns}$, duty cycle $\leq 2.0\%$, pulse rise time $\leq 10 \text{ ns}$. The total capacitance shunting the diode is 19 pF maximum and the equipment bandwidth is 80 MHz .

Preferred devices are Motorola recommended choices for future use and best overall value.

ELECTRICAL CHARACTERISTICS (@ 25°C Free-Air Temperature) (Continued)

Characteristic	Symbol	Typical Value	Unit
SWITCHING CHARACTERISTICS (@ 25°C Free-Air Temperature)			
Forward Recovery Time ($I_F = 500 \text{ mA}_{dc}$)	t_{fr}	20	ns
Reverse Recovery Time ($I_F = 200 \text{ mA}$, $I_{RM} = 200 \text{ mA}$, $R_L = 100 \Omega$, $i_{rr} = 20 \text{ mA}$)	t_{rr}	8.0	ns

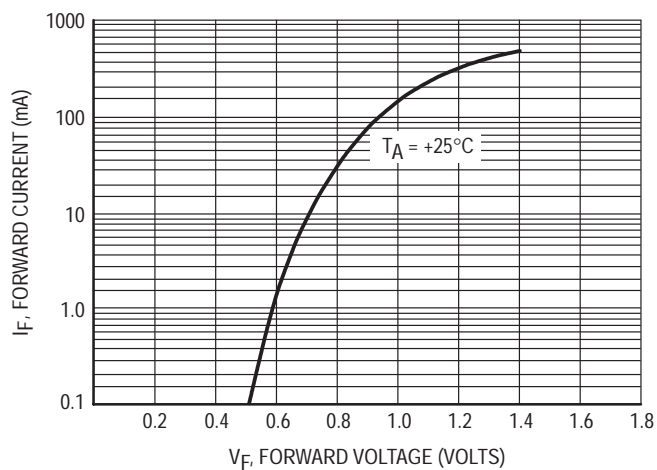


Figure 1. Typical Characteristics Static Forward Voltage

TEST PROCEDURE FOR MULTIPLE DIODES

1.0. REVERSE BIAS TESTING

1.1. LEAKAGE

Regardless of device configuration type, when testing any reverse bias condition, the forcing power supply must be applied only to the uncommon terminal of the pair. As in Figure 1, this would be pins 1 and 14. This can be referred as the high side of the test circuit. The low side of the test circuit must be connected to the common terminal of the pair which in most testers is where the current measurement is taken. This method is used to eliminate the possibility of degrading the diode in that pair which is not under test. Diode arrays with multiple pairs such as the MMAD1103, also have leakage paths in the die between common terminals of the pairs. To isolate the device under test so that the leakage from the other pairs in the package do not affect the test result, the leakage current from the common terminals of the pairs not under test must be shunted to measurement common. Figure 1 shows the test configuration for both of these cases.

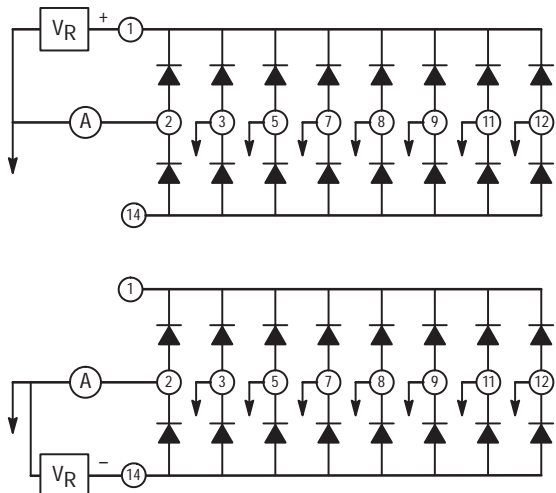


Figure 1

1.2. BREAKDOWN

It is not recommended to test breakdown on these devices due to the possibility of degrading the device. Breakdown may be checked on a curve tracer but extreme caution should be used.

2.0. FORWARD BIAS TESTING

Diode arrays are designed with the pairs in parallel; therefore, care must be taken to prevent the other diodes in the array from affecting the measured value of the diode under test. Figure 2 illustrates the proper technique to measure only the correct value of the diode under test.

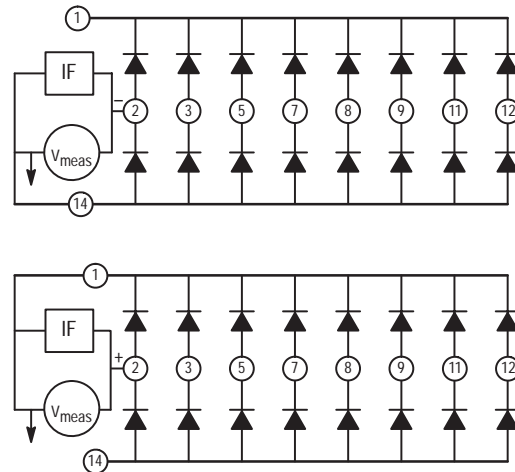


Figure 2

2.1. KELVIN CONNECTION

To achieve the best possible accuracy when testing bias currents over 10 mA, Kelvin connection to the leads of the device under test is mandatory. True Kelvin connection dictates that two test connections are made directly to the leads of the device. One is for power which is the bias supply, and the other is for sense which is for the measurement circuit. Kelvin connections are used to eliminate the effects of the connection resistance between the lead of the device and the contacts of the test handler and/or hand fixture. Figure 3 is an example of Kelvin connection.

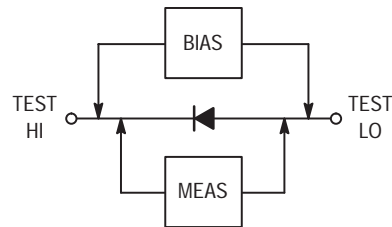


Figure 3

2.2. PULSE TESTING

When testing bias currents over 10 mA, pulse testing should be used to minimize thermal drift of the measured value. The pulse width of a pulse test is approximately 300 μs to 380 μs.

3.0. TESTING PROTOCOL

3.1. TEST TYPES

When testing in sequence all of the electrical characteristics, all reverse bias conditions should be tested before the forward bias conditions are tested.

3.2. BIASING MAGNITUDES

Tests of the same test type should be grouped together with the bias conditions in ascending order. For example:

- $V_F @ 10 \text{ mA} < 0.6 \text{ V}$
- $V_F @ 50 \text{ mA} < 0.8 \text{ V}$
- $V_F @ 100 \text{ mA} < 1 \text{ V}$
- $V_F @ 500 \text{ mA} < 1.5 \text{ V}$

Dual Hot Carrier Mixer Diodes

These devices are designed primarily for UHF mixer applications but are suitable also for use in detector and ultra-fast switching circuits.

- Very Low Capacitance — Less Than 1.0 pF @ Zero Volts
- Low Forward Voltage — 0.5 Volts (Typ) @ $I_F = 10$ mA

MMBD352LT1
MMBD353LT1
MMBD354LT1
MMBD355LT1

MAXIMUM RATINGS (EACH DIODE)

Rating	Symbol	Value	Unit
Continuous Reverse Voltage	V_R	7.0	V_{CC}

THERMAL CHARACTERISTICS

Characteristic	Symbol	Max	Unit
Total Device Dissipation FR-5 Board ⁽¹⁾ $T_A = 25^\circ\text{C}$ Derate above 25°C	P_D	225	mW
		1.8	$\text{mW}/^\circ\text{C}$
Thermal Resistance, Junction to Ambient	$R_{\theta JA}$	556	$^\circ\text{C}/\text{W}$
Total Device Dissipation Alumina Substrate ⁽²⁾ $T_A = 25^\circ\text{C}$ Derate above 25°C	P_D	300	mW
		2.4	$\text{mW}/^\circ\text{C}$
Thermal Resistance, Junction to Ambient	$R_{\theta JA}$	417	$^\circ\text{C}/\text{W}$
Junction and Storage Temperature	T_J, T_{stg}	-55 to +150	$^\circ\text{C}$

DEVICE MARKING

MMBD352LT1 = M5G; MMBD353LT1 = M4F; MMBD354LT1 = M6H; MMBD355LT1 = MJ1

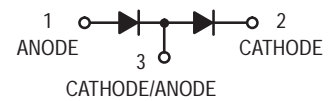
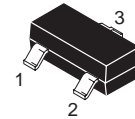
ELECTRICAL CHARACTERISTICS ($T_A = 25^\circ\text{C}$ unless otherwise noted) (EACH DIODE)

Characteristic	Symbol	Min	Max	Unit
----------------	--------	-----	-----	------

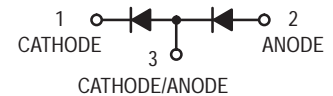
OFF CHARACTERISTICS

Forward Voltage ($I_F = 10$ mA dc)	V_F	—	0.60	V
Reverse Voltage Leakage Current ($V_R = 3.0$ V) ($V_R = 7.0$ V)	I_R	—	0.25 10	μA
Capacitance ($V_R = 0$ V, $f = 1.0$ MHz)	C	—	1.0	pF

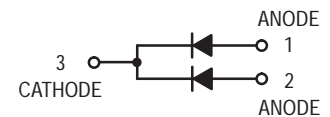
1. FR-5 = $1.0 \times 0.75 \times 0.062$ in.
2. Alumina = $0.4 \times 0.3 \times 0.024$ in. 99.5% alumina.



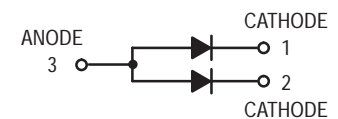
MMBD352LT1
CASE 318-08, STYLE 11
SOT-23 (TO-236AB)



MMBD353LT1
CASE 318-08, STYLE 19
SOT-23 (TO-236AB)



MMBD354LT1
CASE 318-08, STYLE 9
SOT-23 (TO-236AB)



MMBD355LT1
CASE 318-08, STYLE 12
SOT-23 (TO-236AB)

TYPICAL CHARACTERISTICS

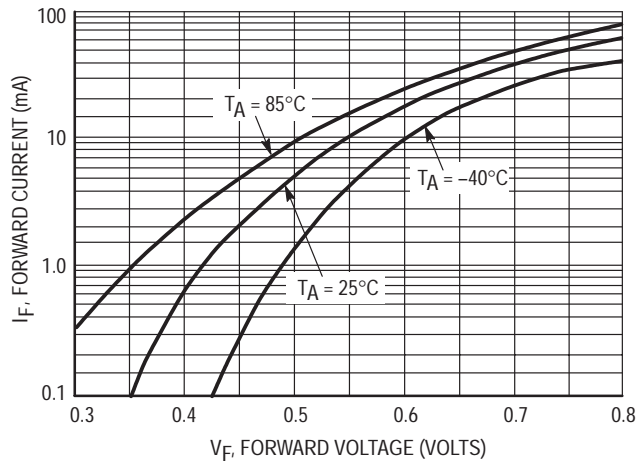


Figure 1. Forward Voltage

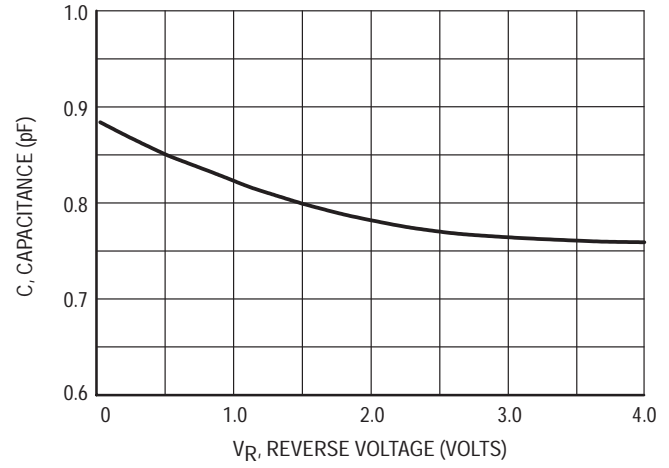


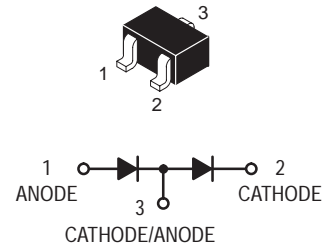
Figure 2. Capacitance

Dual Schottky Barrier Diode

MMBD352WT1

These devices are designed primarily for UHF mixer applications but are suitable also for use in detector and ultra-fast switching circuits.

- Very Low Capacitance — Less Than 1.0 pF @ Zero Volts
- Low Forward Voltage — 0.5 Volts (Typ) @ $I_F = 10$ mA



MMBD352WT1
CASE 419-02, STYLE 9
SOT-323 (SC-70)

MAXIMUM RATINGS

Rating	Symbol	Value	Unit
Continuous Reverse Voltage	V_R	7.0	V_{CC}

THERMAL CHARACTERISTICS

Characteristic	Symbol	Max	Unit
Total Device Dissipation FR-5 Board ⁽¹⁾ $T_A = 25^\circ\text{C}$ Derate above 25°C	P_D	200	mW
		1.6	mW/ $^\circ\text{C}$
Thermal Resistance, Junction to Ambient	$R_{\theta JA}$	625	$^\circ\text{C}/\text{W}$
Total Device Dissipation Alumina Substrate ⁽²⁾ $T_A = 25^\circ\text{C}$ Derate above 25°C	P_D	300	mW
		2.4	mW/ $^\circ\text{C}$
Thermal Resistance, Junction to Ambient	$R_{\theta JA}$	417	$^\circ\text{C}/\text{W}$
Junction and Storage Temperature	T_J, T_{stg}	-55 to +150	$^\circ\text{C}$

DEVICE MARKING

MMBD352WT1 = M5

ELECTRICAL CHARACTERISTICS ($T_A = 25^\circ\text{C}$ unless otherwise noted)

Characteristic	Symbol	Min	Max	Unit
----------------	--------	-----	-----	------

OFF CHARACTERISTICS

Forward Voltage ($I_F = 10$ mA)	V_F	—	0.60	V
Reverse Voltage Leakage Current ($V_R = 3.0$ V) ($V_R = 7.0$ V)	I_R	—	0.25 10	μA
Capacitance ($V_R = 0$ V, $f = 1.0$ MHz)	C	—	1.0	pF

1. FR-5 = $1.0 \times 0.75 \times 0.062$ in.

2. Alumina = $0.4 \times 0.3 \times 0.024$ in. 99.5% alumina.

TYPICAL CHARACTERISTICS

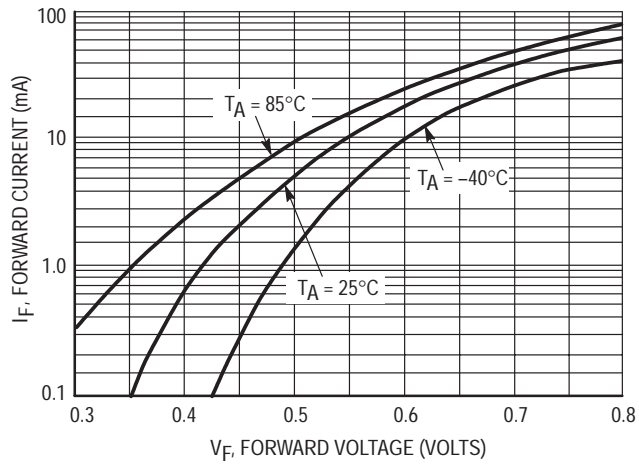


Figure 1. Forward Voltage

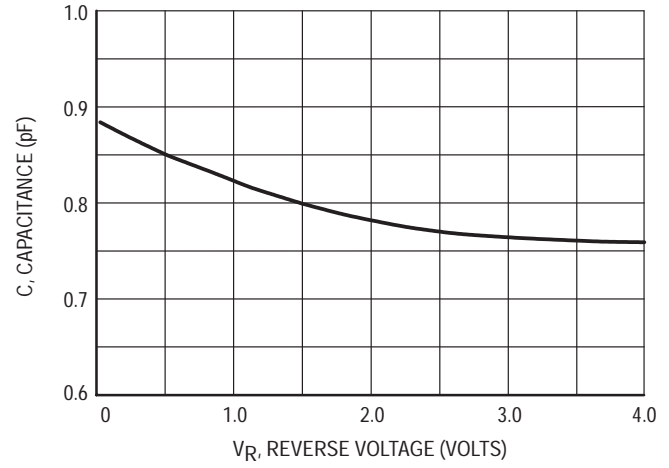


Figure 2. Capacitance

Dual Hot-Carrier Diodes Schottky Barrier Diodes

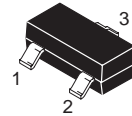
These devices are designed primarily for high-efficiency UHF and VHF detector applications. They are readily adaptable to many other fast switching RF and digital applications. They are supplied in an inexpensive plastic package for low-cost, high-volume consumer and industrial/commercial requirements.

- Extremely Low Minority Carrier Lifetime
- Very Low Capacitance
- Low Reverse Leakage

MMBD452LT1

Motorola Preferred Devices

**30 VOLTS
DUAL HOT-CARRIER
DETECTOR AND SWITCHING
DIODES**



**CASE 318-08, STYLE 11
SOT-23 (TO-236AB)**

MAXIMUM RATINGS ($T_J = 125^\circ\text{C}$ unless otherwise noted)

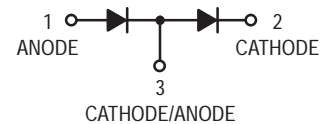
Rating	Symbol	Value	Unit
Reverse Voltage	V_R	30	Volts
Forward Power Dissipation @ $T_A = 25^\circ\text{C}$ Derate above 25°C	P_F	225 1.8	mW mW/ $^\circ\text{C}$
Operating Junction Temperature Range	T_J	-55 to +125	$^\circ\text{C}$
Storage Temperature Range	T_{stg}	-55 to +150	$^\circ\text{C}$

DEVICE MARKING

MMBD452LT1 = 5N

ELECTRICAL CHARACTERISTICS ($T_A = 25^\circ\text{C}$ unless otherwise noted) (EACH DIODE)

Characteristic	Symbol	Min	Typ	Max	Unit
Reverse Breakdown Voltage ($I_R = 10 \mu\text{A}$)	$V_{(BR)R}$	30	—	—	Volts
Total Capacitance ($V_R = 15 \text{ V}$, $f = 1.0 \text{ MHz}$) Figure 1	C_T	—	0.9	1.5	pF
Reverse Leakage ($V_R = 25 \text{ V}$) Figure 3	I_R	—	13	200	nAdc
Forward Voltage ($I_F = 1.0 \text{ mAdc}$) Figure 4	V_F	—	0.38	0.45	Vdc
Forward Voltage ($I_F = 10 \text{ mAdc}$) Figure 4	V_F	—	0.52	0.6	Vdc



Preferred devices are Motorola recommended choices for future use and best overall value.

TYPICAL ELECTRICAL CHARACTERISTICS

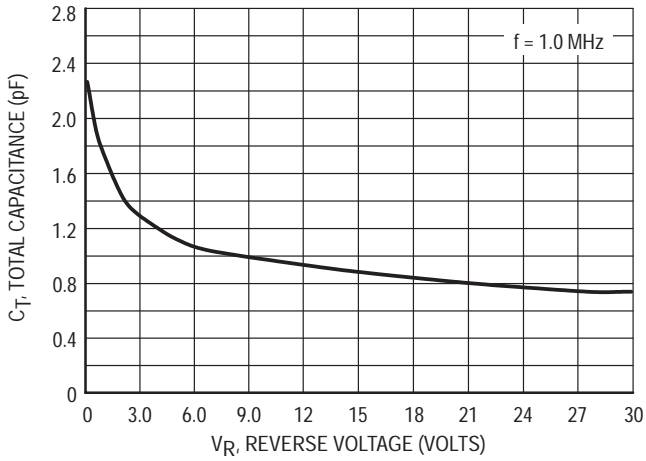


Figure 1. Total Capacitance

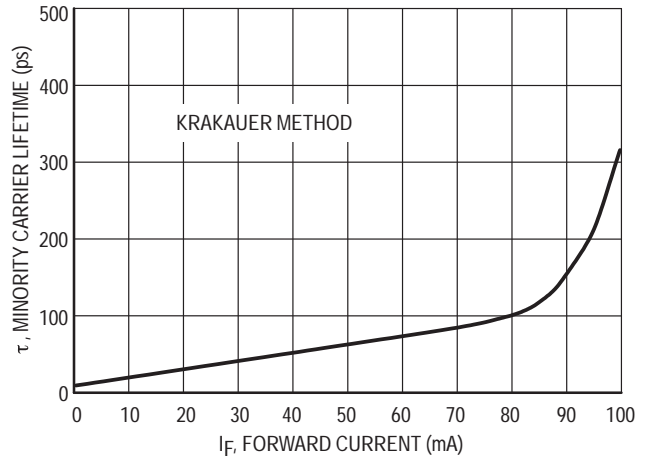


Figure 2. Minority Carrier Lifetime

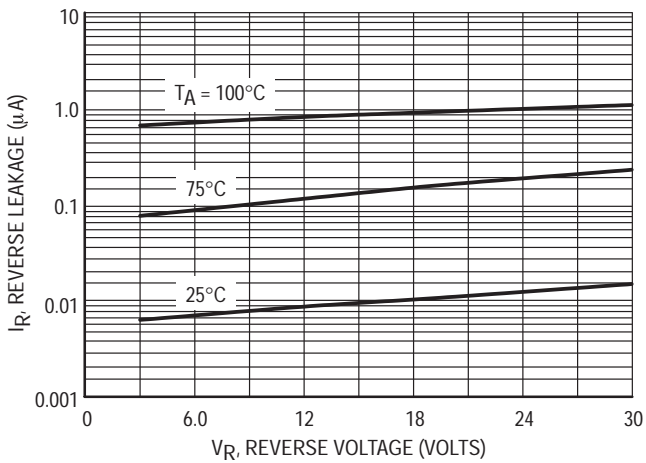


Figure 3. Reverse Leakage

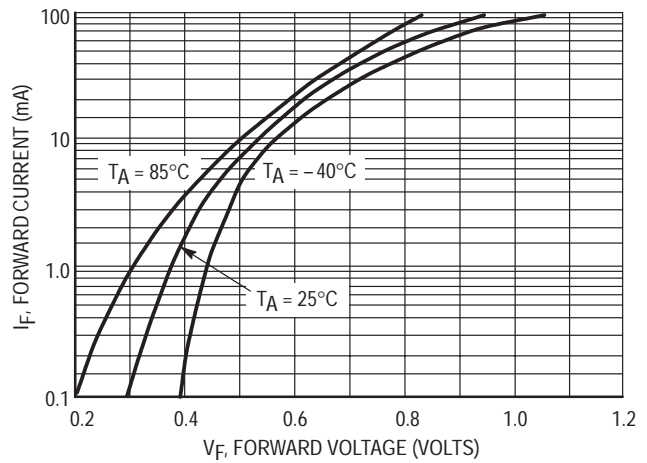


Figure 4. Forward Voltage

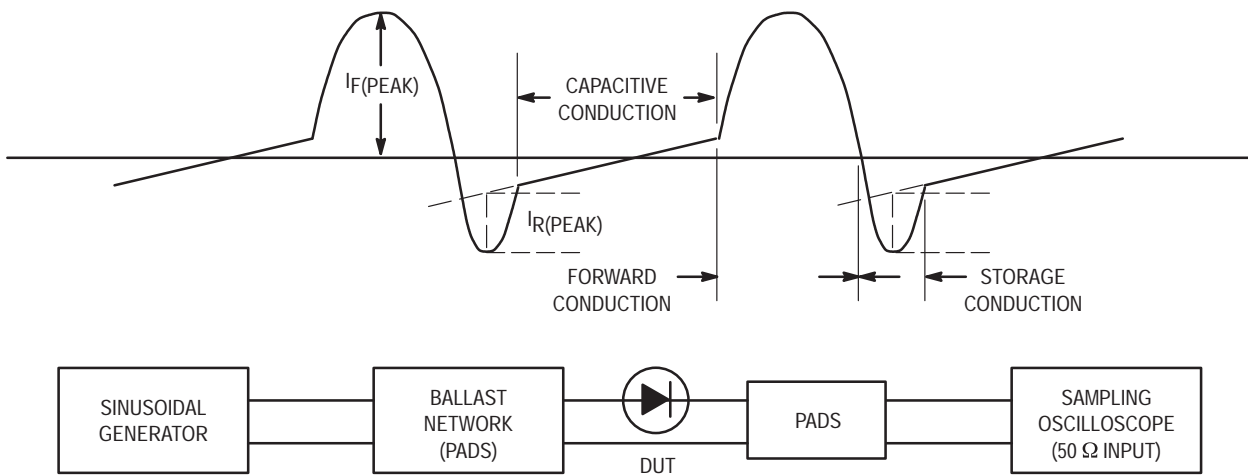
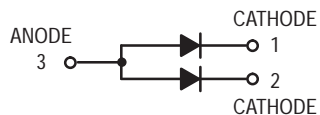


Figure 5. Krakauer Method of Measuring Lifetime

Common Anode Schottky Barrier Diodes

These Schottky barrier diodes are designed for high speed switching applications, circuit protection, and voltage clamping. Extremely low forward voltage reduces conduction loss. Miniature surface mount package is excellent for hand held and portable applications where space is limited.

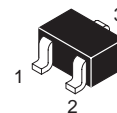
- Extremely Fast Switching Speed
- Extremely Low Forward Voltage — 0.28 Volts (Typ) @ $I_F = 1 \text{ mAdc}$



MMBD717LT1

Motorola Preferred Device

**20 VOLT
SCHOTTKY BARRIER
DETECTOR AND SWITCHING
DIODES**



**CASE 419-02, STYLE 2
SOT-323 (SC-70)**

MAXIMUM RATINGS ($T_J = 125^\circ\text{C}$ unless otherwise noted)

Rating	Symbol	Value	Unit
Reverse Voltage	V_R	20	Volts
Forward Power Dissipation @ $T_A = 25^\circ\text{C}$ Derate above 25°C	P_F	200 1.6	mW mW/ $^\circ\text{C}$
Operating Junction Temperature Range	T_J	-55 to +150	$^\circ\text{C}$
Storage Temperature Range	T_{stg}	-55 to +150	$^\circ\text{C}$

DEVICE MARKING

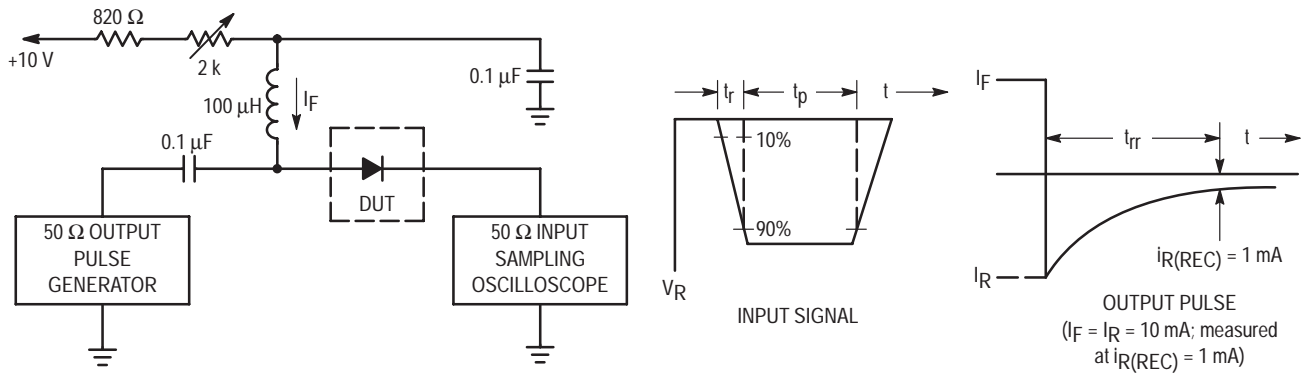
MMBD717LT1 = B3

ELECTRICAL CHARACTERISTICS ($T_A = 25^\circ\text{C}$ unless otherwise noted)

Characteristic	Symbol	Min	Typ	Max	Unit
Reverse Breakdown Voltage ($I_R = 10 \mu\text{A}$)	$V_{(\text{BR})R}$	20	—	—	Volts
Total Capacitance ($V_R = 1.0 \text{ V}$, $f = 1.0 \text{ MHz}$)	C_T	—	2.0	2.5	pF
Reverse Leakage ($V_R = 10 \text{ V}$)	I_R	—	0.05	1.0	μAdc
Forward Voltage ($I_F = 1.0 \text{ mAdc}$)	V_F	—	0.28	0.37	Vdc

Preferred devices are Motorola recommended choices for future use and best overall value.

MMBD717LT1



- Notes: 1. A 2.0 kΩ variable resistor adjusted for a Forward Current (I_F) of 10 mA.
 2. Input pulse is adjusted so $I_{R(\text{peak})}$ is equal to 10 mA.
 3. $t_p \gg t_{rr}$

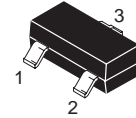
Figure 1. Recovery Time Equivalent Test Circuit

High-Speed Switching Diode



MMBD914LT1

Motorola Preferred Device



CASE 318-08, STYLE 8
SOT-23 (TO-236AB)

MAXIMUM RATINGS

Rating	Symbol	Value	Unit
Reverse Voltage	V_R	100	Vdc
Forward Current	I_F	200	mAdc
Peak Forward Surge Current	$I_{FM}(\text{surge})$	500	mAdc

THERMAL CHARACTERISTICS

Characteristic	Symbol	Max	Unit
Total Device Dissipation FR-5 Board ⁽¹⁾ $T_A = 25^\circ\text{C}$ Derate above 25°C	P_D	225	mW
Thermal Resistance, Junction to Ambient	$R_{\theta JA}$	556	$^\circ\text{C}/\text{W}$
Total Device Dissipation Alumina Substrate, ⁽²⁾ $T_A = 25^\circ\text{C}$ Derate above 25°C	P_D	300	mW
Thermal Resistance, Junction to Ambient	$R_{\theta JA}$	417	$^\circ\text{C}/\text{W}$
Junction and Storage Temperature	T_J, T_{stg}	-55 to +150	$^\circ\text{C}$

DEVICE MARKING

MMBD914LT1 = 5D

ELECTRICAL CHARACTERISTICS ($T_A = 25^\circ\text{C}$ unless otherwise noted)

Characteristic	Symbol	Min	Max	Unit
----------------	--------	-----	-----	------

OFF CHARACTERISTICS

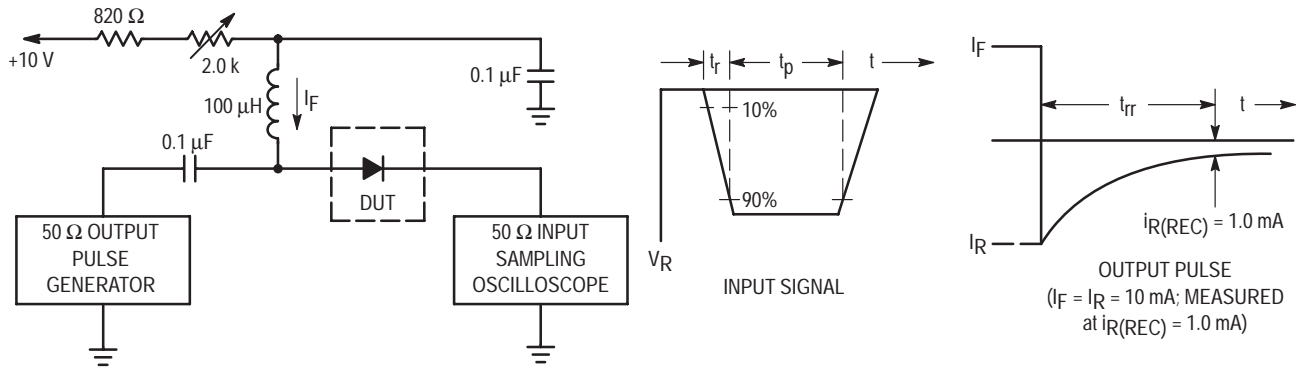
Reverse Breakdown Voltage ($I_R = 100 \mu\text{Adc}$)	$V_{(BR)}$	100	—	Vdc
Reverse Voltage Leakage Current ($V_R = 20 \text{Vdc}$) ($V_R = 75 \text{Vdc}$)	I_R	—	25 5.0	nAdc μAdc
Diode Capacitance ($V_R = 0, f = 1.0 \text{MHz}$)	C_T	—	4.0	pF
Forward Voltage ($I_F = 10 \text{mAdc}$)	V_F	—	1.0	Vdc
Reverse Recovery Time ($I_F = I_R = 10 \text{mAdc}$) (Figure 1)	t_{rr}	—	4.0	ns

1. FR-5 = $1.0 \times 0.75 \times 0.062$ in.

2. Alumina = $0.4 \times 0.3 \times 0.024$ in. 99.5% alumina.

Preferred devices are Motorola recommended choices for future use and best overall value.

MMBD914LT1



- Notes: 1. A 2.0 kΩ variable resistor adjusted for a Forward Current (I_F) of 10 mA.
 2. Input pulse is adjusted so $I_{R(peak)}$ is equal to 10 mA.
 3. $t_p \gg t_{rr}$

Figure 1. Recovery Time Equivalent Test Circuit

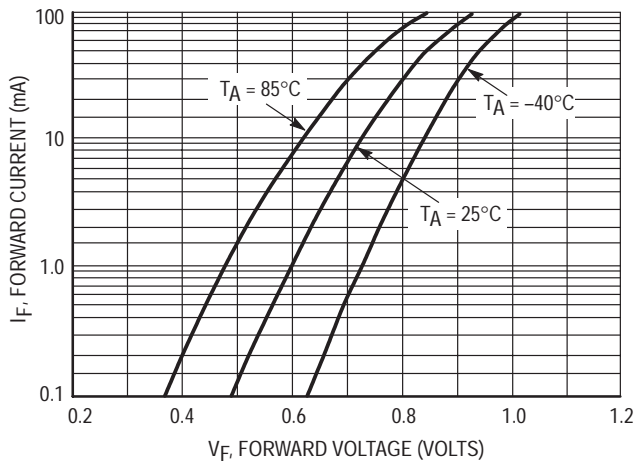


Figure 2. Forward Voltage

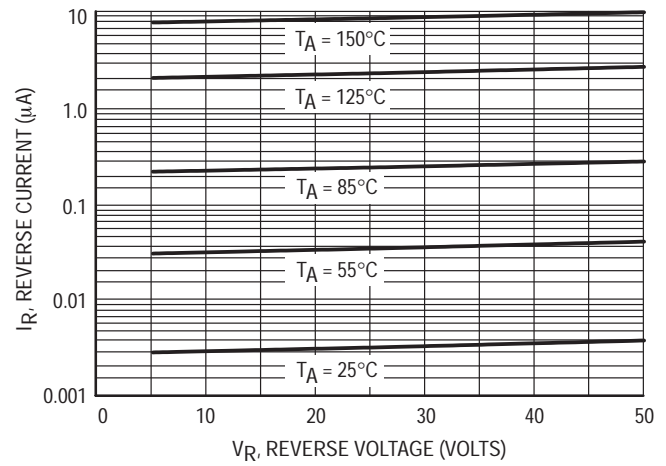


Figure 3. Leakage Current

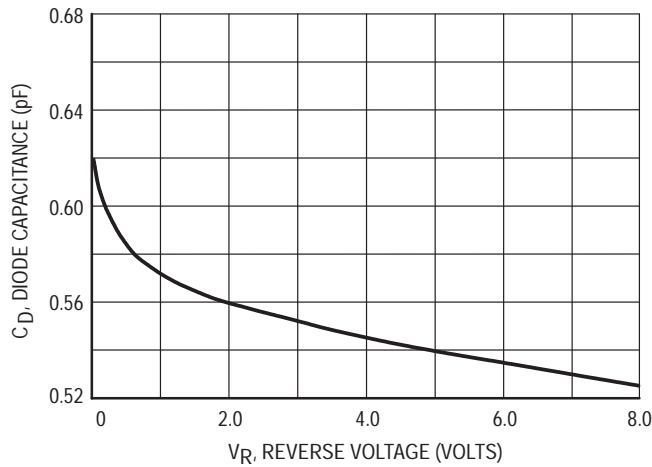


Figure 4. Capacitance



Switching Diode

Part of the GreenLine™ Portfolio of devices with energy-conserving traits.

This switching diode has the following features:

- Very Low Leakage (≤ 500 pA) promotes extended battery life by decreasing energy waste
- Offered in four Surface Mount package types
- Available in 8 mm Tape and Reel in quantities of 3,000

Applications

- ESD Protection
- Reverse Polarity Protection
- Steering Logic
- Medium-Speed Switching

MAXIMUM RATINGS

Rating	Symbol	Value	Unit
Continuous Reverse Voltage	V_R	30	Vdc
Peak Forward Current	I_F	200	mAdc
Peak Forward Surge Current	I_{FM} (surge)	500	mA

DEVICE MARKING

MMBD1000LT1 = AY
MMBD2000T1 = DH
MMBD3000T1 = XP
MMSD1000T1 = 4K

THERMAL CHARACTERISTICS

Characteristic	Symbol	Max	Unit
Total Device Dissipation FR-4 Board (1) $T_A = 25^\circ\text{C}$	P_D	225	mW
MMBD1000LT1, MMBD3000T1, MMSD1000T1			
MMBD2000T1			
Derate above 25°C	P_D	1.8	mW/ $^\circ\text{C}$
MMBD1000LT1, MMBD3000T1, MMSD1000T1			
MMBD2000T1			
Thermal Resistance Junction to Ambient MMBD1000LT1, MMBD3000T1, MMSD1000T1 MMBD2000T1	$R_{\theta JA}$	556	$^\circ\text{C/W}$
Junction and Storage Temperature	T_J, T_{stg}	-55 to +150	$^\circ\text{C}$

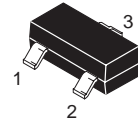
(1) Device mounted on a FR-4 glass epoxy printed circuit board using the minimum recommended footprint.

Preferred devices are Motorola recommended choices for future use and best overall value.

MMBD1000LT1
MMBD2000T1
MMBD3000T1
MMSD1000T1

Motorola Preferred Devices

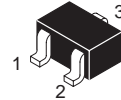
MMBD1000LT1



CASE 318-08, STYLE 8
SOT-23 (TO-236AB)



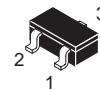
MMBD2000T1



CASE 419-02, STYLE 2
SC-70/SOT-323



MMBD3000T1



CASE 318D-04, STYLE 2
SC-59



MMSD1000T1



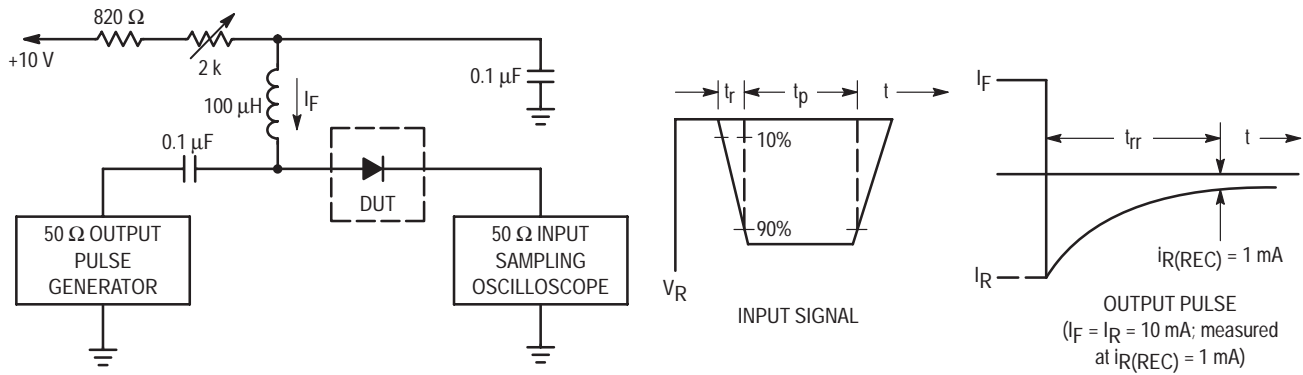
CASE 425-04, STYLE 1
SOD-123



MMBD1000LT1 MMBD2000T1 MMBD3000T1 MMSD1000T1

ELECTRICAL CHARACTERISTICS ($T_A = 25^\circ\text{C}$ unless otherwise noted)

Characteristic	Symbol	Min	Max	Unit
OFF CHARACTERISTICS				
Reverse Breakdown Voltage ($I_{BR} = 100 \mu\text{A}$)	$V_{(BR)}$	30	—	V
Reverse Voltage Leakage Current ($V_R = 75 \text{ V}$)	I_R	—	500	pA
Forward Voltage ($I_F = 1.0 \text{ mA}$) ($I_F = 10 \text{ mA}$)	V_F	— —	850 950	mV
Diode Capacitance ($V_R = 0 \text{ V}$, $f = 1.0 \text{ MHz}$)	C_D	—	2.0	pF
Reverse Recovery Time ($I_F = I_R = 10 \text{ mA}$) (Figure 1)	t_{rr}	—	3.0	μs



- Notes: 1. A 2.0 kΩ variable resistor adjusted for a Forward Current (I_F) of 10 mA.
 2. Input pulse is adjusted so $I_{R(\text{peak})}$ is equal to 10 mA.
 3. $t_p \gg t_{rr}$

Figure 1. Recovery Time Equivalent Test Circuit



Switching Diode

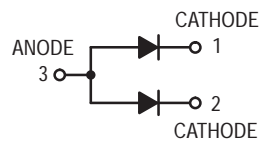
Part of the GreenLine™ Portfolio of devices with energy-conserving traits.

This switching diode has the following features:

- Very Low Leakage (≤ 500 pA) promotes extended battery life by decreasing energy waste. Guaranteed leakage limit is for each diode in the pair contingent upon the other diode being in a non-forward-biased condition.
- Offered in four Surface Mount package types
- Available in 8 mm Tape and Reel in quantities of 3,000

Applications

- ESD Protection
- Reverse Polarity Protection
- Steering Logic
- Medium-Speed Switching



MAXIMUM RATINGS

Rating	Symbol	Value	Unit
Continuous Reverse Voltage	V_R	30	Vdc
Peak Forward Current	I_F	200	mAdc
Peak Forward Surge Current	I_{FM} (surge)	500	mA

DEVICE MARKING

MMBD1005LT1 = A3
MMBD2005T1 = DI
MMBD3005T1 = XQ

THERMAL CHARACTERISTICS

Characteristic	Symbol	Max	Unit
Total Device Dissipation FR-4 Board (1) $T_A = 25^\circ\text{C}$	P_D	225	mW
MMBD1005LT1, MMBD3005T1		150	
MMBD2005T1		150	
Derate above 25°C		1.8	mW/ $^\circ\text{C}$
MMBD1005LT1, MMBD3005T1		1.2	
Thermal Resistance Junction to Ambient	$R_{\theta JA}$	556	$^\circ\text{C/W}$
MMBD1005LT1, MMBD3005T1		833	
MMBD2005T1		833	
Junction and Storage Temperature	T_J, T_{stg}	-55 to +150	$^\circ\text{C}$

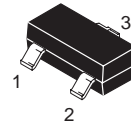
(1) Device mounted on a FR-4 glass epoxy printed circuit board using the minimum recommended footprint.

Preferred devices are Motorola recommended choices for future use and best overall value.

MMBD1005LT1 MMBD2005T1 MMBD3005T1

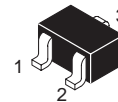
Motorola Preferred Devices

MMBD1005LT1



CASE 318-08, STYLE 12
SOT-23 (TO-236AB)

MMBD2005T1



CASE 419-02, STYLE 4
SC-70/SOT-323

MMBD3005T1



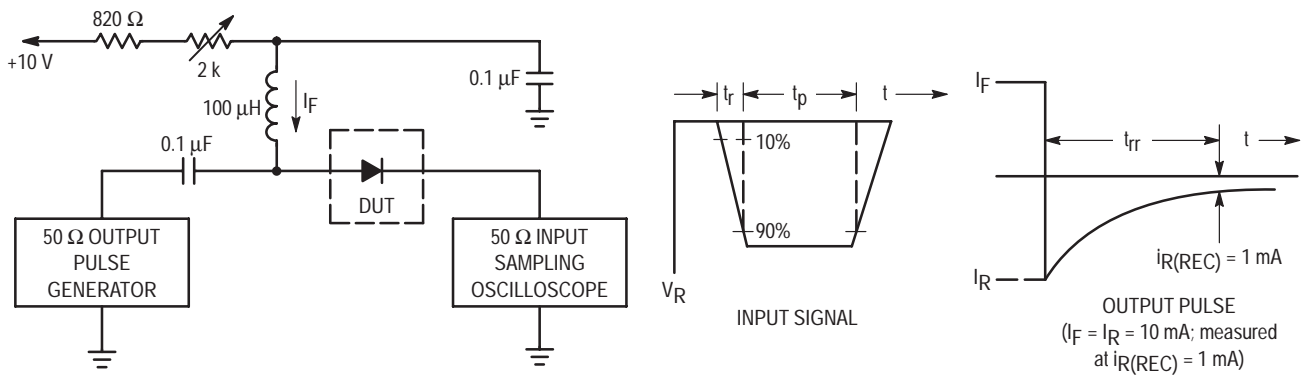
CASE 318D-04, STYLE 5
SC-59

MMBD1005LT1 MMBD2005T1 MMBD3005T1

ELECTRICAL CHARACTERISTICS ($T_A = 25^\circ\text{C}$ unless otherwise noted)

Characteristic	Symbol	Min	Max	Unit
OFF CHARACTERISTICS				
Reverse Breakdown Voltage ($I_{BR} = 100 \mu\text{A}$)	$V_{(BR)}$	30	—	V
Reverse Voltage Leakage Current ($V_R = 75 \text{V}$) ⁽²⁾	I_R	—	500	pA
Forward Voltage ($I_F = 1.0 \text{mA}$) ($I_F = 10 \text{mA}$)	V_F	— —	850 950	mV
Diode Capacitance ($V_R = 0 \text{V}$, $f = 1.0 \text{MHz}$)	C_D	—	2.0	pF
Reverse Recovery Time ($I_F = I_R = 10 \text{mA}$) (Figure 1)	t_{rr}	—	3.0	μs

(2) Guaranteed leakage limit is for each diode in the pair contingent upon the other diode being in a non-forward-biased condition.



- Notes: 1. A 2.0 k Ω variable resistor adjusted for a Forward Current (I_F) of 10 mA.
 2. Input pulse is adjusted so $I_{R(\text{peak})}$ is equal to 10 mA.
 3. $t_p \gg t_{rr}$

Figure 1. Recovery Time Equivalent Test Circuit



Switching Diode

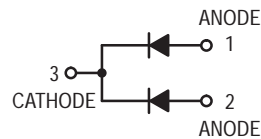
Part of the GreenLine™ Portfolio of devices with energy-conserving traits.

This switching diode has the following features:

- Very Low Leakage (≤ 500 pA) promotes extended battery life by decreasing energy waste. Guaranteed leakage limit is for each diode in the pair contingent upon the other diode being in a non-forward-biased condition.
- Offered in four Surface Mount package types
- Available in 8 mm Tape and Reel in quantities of 3,000

Applications

- ESD Protection
- Reverse Polarity Protection
- Steering Logic
- Medium-Speed Switching



MAXIMUM RATINGS

Rating	Symbol	Value	Unit
Continuous Reverse Voltage	V_R	30	Vdc
Peak Forward Current	I_F	200	mAdc
Peak Forward Surge Current	I_{FM} (surge)	500	mA

DEVICE MARKING

MMBD1010LT1 = A5
MMBD2010T1 = DP
MMBD3010T1 = XS

THERMAL CHARACTERISTICS

Characteristic	Symbol	Max	Unit
Total Device Dissipation FR-4 Board (1) $T_A = 25^\circ\text{C}$	P_D	225	mW
		150	
Derate above 25°C		1.8	mW/°C
		1.2	
Thermal Resistance Junction to Ambient	$R_{\theta JA}$	556	°C/W
		833	
Junction and Storage Temperature	T_J, T_{stg}	-55 to +150	°C

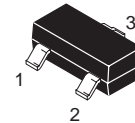
(1) Device mounted on a FR-4 glass epoxy printed circuit board using the minimum recommended footprint.

Preferred devices are Motorola recommended choices for future use and best overall value.

MMBD1010LT1 MMBD2010T1 MMBD3010T1

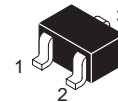
Motorola Preferred Devices

MMBD1010LT1



CASE 318-08, STYLE 9
SOT-23 (TO-236AB)

MMBD2010T1



CASE 419-02, STYLE 5
SC-70/SOT-323

MMBD3010T1



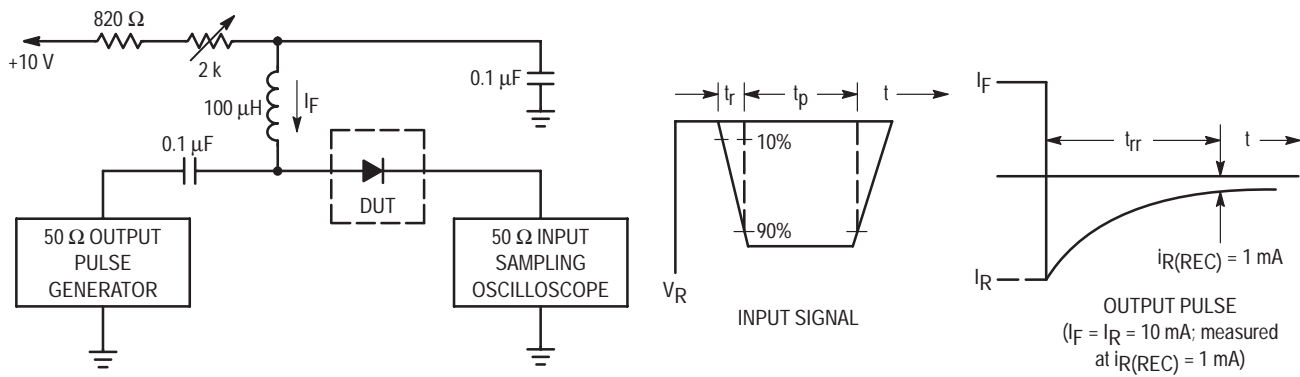
CASE 318D-04, STYLE 3
SC-59

MMBD1010LT1 MMBD2010T1 MMBD3010T1

ELECTRICAL CHARACTERISTICS ($T_A = 25^\circ\text{C}$ unless otherwise noted)

Characteristic	Symbol	Min	Max	Unit
OFF CHARACTERISTICS				
Reverse Breakdown Voltage ($I_{BR} = 100 \mu\text{A}$)	$V_{(BR)}$	30	—	V
Reverse Voltage Leakage Current ($V_R = 75 \text{V}$) ⁽²⁾	I_R	—	500	pA
Forward Voltage ($I_F = 1.0 \text{mA}$) ($I_F = 10 \text{mA}$)	V_F	— —	850 950	mV
Diode Capacitance ($V_R = 0 \text{V}$, $f = 1.0 \text{MHz}$)	C_D	—	2.0	pF
Reverse Recovery Time ($I_F = I_R = 10 \text{mA}$) (Figure 1)	t_{rr}	—	3.0	μs

(2) Guaranteed leakage limit is for each diode in the pair contingent upon the other diode being in a non-forward-biased condition.

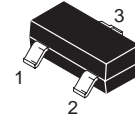
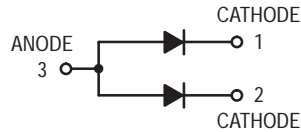


- Notes: 1. A 2.0 kΩ variable resistor adjusted for a Forward Current (I_F) of 10 mA.
 2. Input pulse is adjusted so $I_{R(\text{peak})}$ is equal to 10 mA.
 3. $t_p \gg t_{rr}$

Figure 1. Recovery Time Equivalent Test Circuit

Monolithic Dual Switching Diodes

MMBD2835LT1
MMBD2836LT1



CASE 318-08, STYLE 12
SOT-23 (TO-236AB)

MAXIMUM RATINGS (EACH DIODE)

Rating	Symbol	Value	Unit
Reverse Voltage	MMBD2835LT1 MMBD2836LT1	35 75	Vdc
Forward Current	I _F	100	mAdc

THERMAL CHARACTERISTICS

Characteristic	Symbol	Max	Unit
Total Device Dissipation FR-5 Board ⁽¹⁾ T _A = 25°C Derate above 25°C	P _D	225 1.8	mW mW/°C
Thermal Resistance, Junction to Ambient	R _{θJA}	556	°C/W
Total Device Dissipation Alumina Substrate, ⁽²⁾ T _A = 25°C Derate above 25°C	P _D	300 2.4	mW mW/°C
Thermal Resistance, Junction to Ambient	R _{θJA}	417	°C/W
Junction and Storage Temperature	T _J , T _{stg}	-55 to +150	°C

DEVICE MARKING

MMBD2835LT1 = A3X; MMBD2836LT1 = A2X

ELECTRICAL CHARACTERISTICS (T_A = 25°C unless otherwise noted) (EACH DIODE)

Characteristic	Symbol	Min	Max	Unit
----------------	--------	-----	-----	------

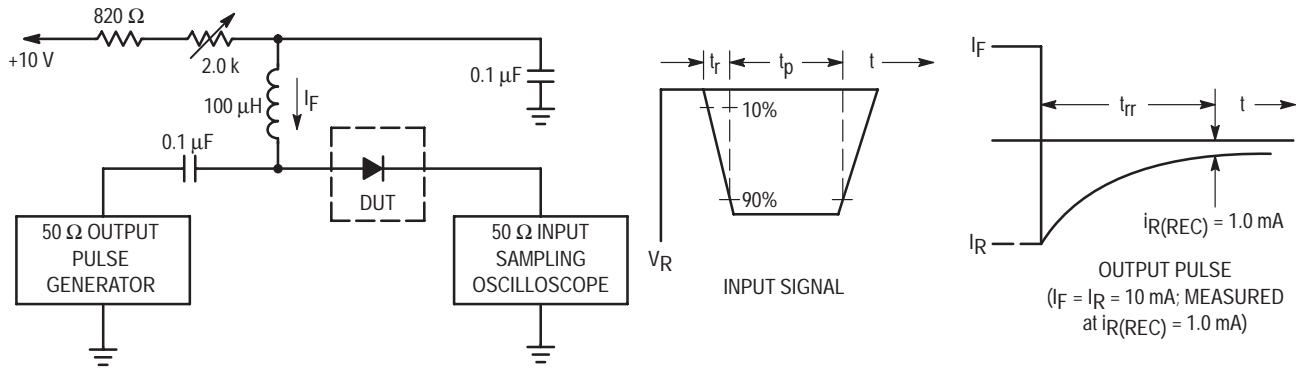
OFF CHARACTERISTICS

Reverse Breakdown Voltage (I _R = 100 μAdc)	MMBD2835LT1 MMBD2836LT1	V _(BR)	35 75	— —	Vdc
Reverse Voltage Leakage Current (V _R = 30 Vdc) (V _R = 50 Vdc)	MMBD2835LT1 MMBD2836LT1	I _R	— —	100 100	nAdc
Diode Capacitance (V _R = 0 V, f = 1.0 MHz)		C _T	—	4.0	pF
Forward Voltage (I _F = 10 mAdc) (I _F = 50 mAdc) (I _F = 100 mAdc)		V _F	— — —	1.0 1.0 1.2	Vdc
Reverse Recovery Time (I _F = I _R = 10 mAdc, I _{R(REC)} = 1.0 mAdc) (Figure 1)		t _{rr}	—	4.0	ns

1. FR-5 = 1.0 × 0.75 × 0.062 in.

2. Alumina = 0.4 × 0.3 × 0.024 in. 99.5% alumina.

MMBD2835LT1 MMBD2836LT1



- Notes: 1. A 2.0 kΩ variable resistor adjusted for a Forward Current (I_F) of 10 mA.
 2. Input pulse is adjusted so $I_{R(peak)}$ is equal to 10 mA.
 3. $t_p \gg t_{rr}$

Figure 1. Recovery Time Equivalent Test Circuit

CURVES APPLICABLE TO EACH CATHODE

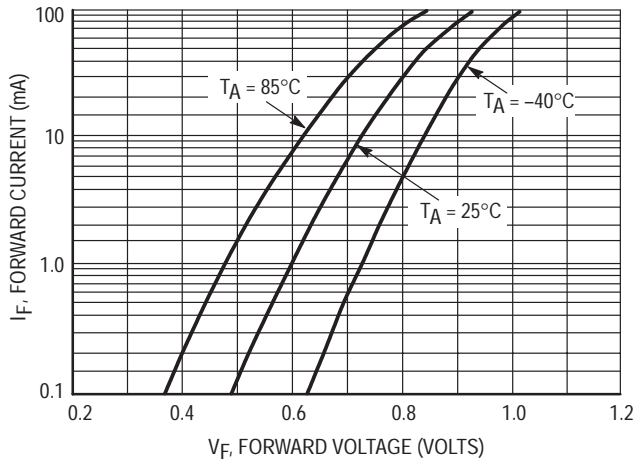


Figure 2. Forward Voltage

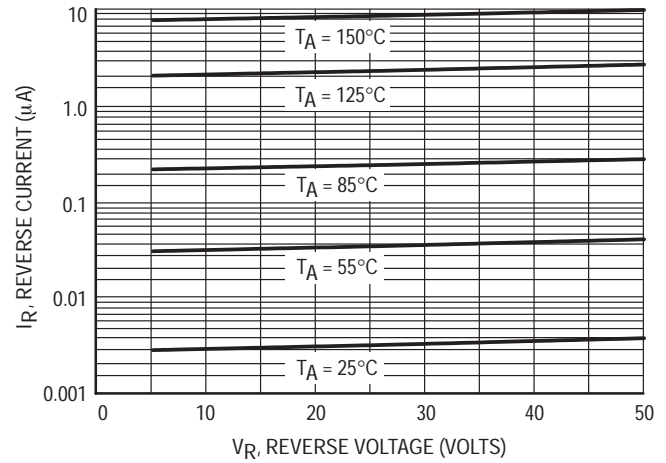


Figure 3. Leakage Current

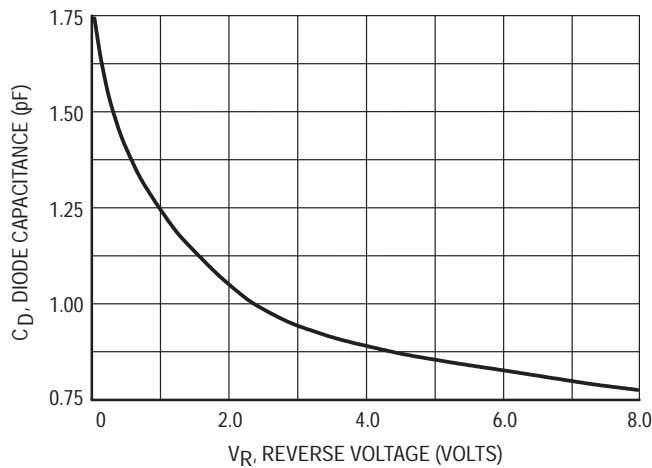
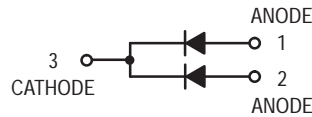


Figure 4. Capacitance

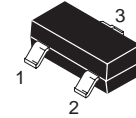
Monolithic Dual Switching Diodes

MMBD2837LT1
MMBD2838LT1



MAXIMUM RATINGS (EACH DIODE)

Rating	Symbol	Value	Unit
Peak Reverse Voltage	V_{RM}	75	Vdc
D.C. Reverse Voltage	V_R	30 50	Vdc
Peak Forward Current	I_{FM}	450 300	mAdc
Average Rectified Current	I_O	150 100	mAdc



CASE 318-08, STYLE 9
SOT-23 (TO-236AB)

THERMAL CHARACTERISTICS

Characteristic	Symbol	Max	Unit
Total Device Dissipation FR-5 Board ⁽¹⁾ $T_A = 25^\circ\text{C}$ Derate above 25°C	P_D	225 1.8	mW mW/ $^\circ\text{C}$
Thermal Resistance, Junction to Ambient	$R_{\theta JA}$	556	$^\circ\text{C}/\text{W}$
Total Device Dissipation Alumina Substrate, ⁽²⁾ $T_A = 25^\circ\text{C}$ Derate above 25°C	P_D	300 2.4	mW mW/ $^\circ\text{C}$
Thermal Resistance, Junction to Ambient	$R_{\theta JA}$	417	$^\circ\text{C}/\text{W}$
Junction and Storage Temperature	T_J, T_{stg}	-55 to +150	$^\circ\text{C}$

DEVICE MARKING

MMBD2837LT1 = A5; MMBD2838LT1 = MA6

ELECTRICAL CHARACTERISTICS ($T_A = 25^\circ\text{C}$ unless otherwise noted) (EACH DIODE)

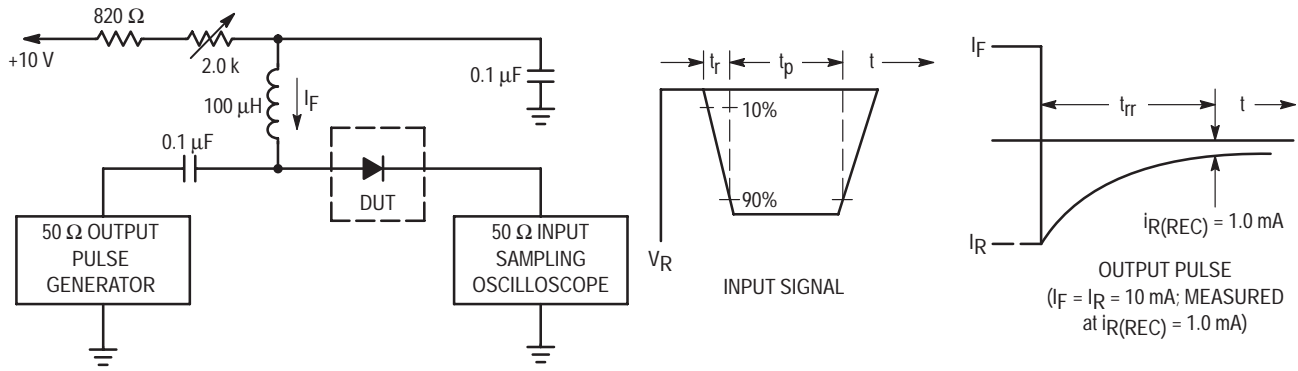
Characteristic	Symbol	Min	Max	Unit
----------------	--------	-----	-----	------

OFF CHARACTERISTICS

Reverse Breakdown Voltage ($I_{(BR)} = 100 \mu\text{Adc}$)	MMBD2837LT1 MMBD2838LT1	$V_{(BR)}$	35 75	— —	Vdc
Reverse Voltage Leakage Current ($V_R = 30 \text{ Vdc}$) ($V_R = 50 \text{ Vdc}$)	MMBD2837LT1 MMBD2838LT1	I_R	— —	0.1 0.1	μAdc
Diode Capacitance ($V_R = 0 \text{ V}$, $f = 1.0 \text{ MHz}$)		C_T	—	4.0	pF
Forward Voltage ($I_F = 10 \text{ mAdc}$) ($I_F = 50 \text{ mAdc}$) ($I_F = 100 \text{ mAdc}$)		V_F	— — —	1.0 1.0 1.2	Vdc
Reverse Recovery Time ($I_F = I_R = 10 \text{ mAdc}$, $I_{R(REC)} = 1.0 \text{ mAdc}$) (Figure 1)		t_{rr}	—	4.0	ns

1. FR-5 = $1.0 \times 0.75 \times 0.062 \text{ in.}$

2. Alumina = $0.4 \times 0.3 \times 0.024 \text{ in.}$ 99.5% alumina.



- Notes: 1. A 2.0 kΩ variable resistor adjusted for a Forward Current (I_F) of 10 mA.
- 2. Input pulse is adjusted so $I_{R(peak)}$ is equal to 10 mA.
- 3. $t_p \gg t_{rr}$

Figure 1. Recovery Time Equivalent Test Circuit

CURVES APPLICABLE TO EACH CATHODE

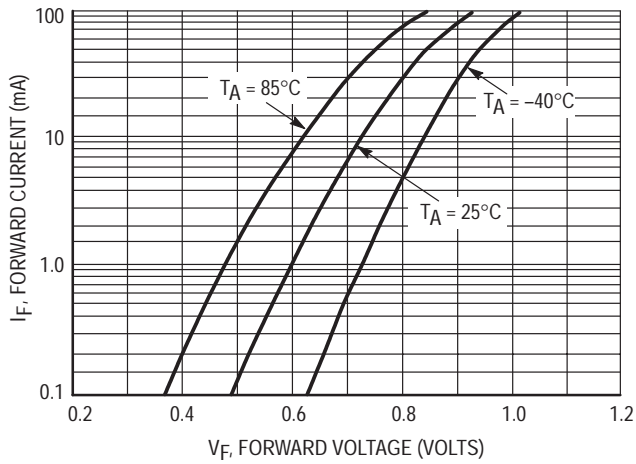


Figure 2. Forward Voltage

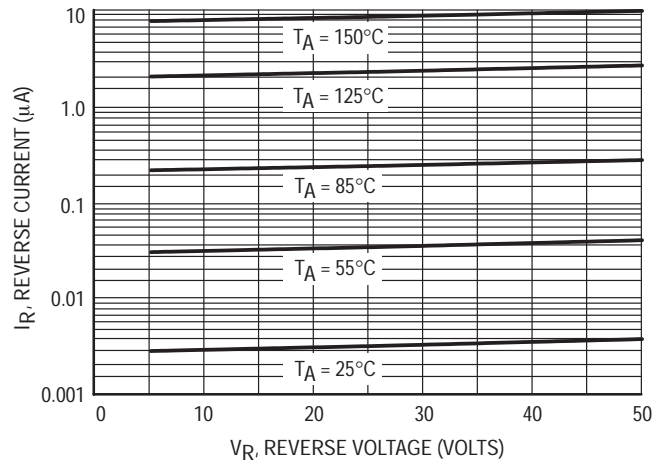


Figure 3. Leakage Current

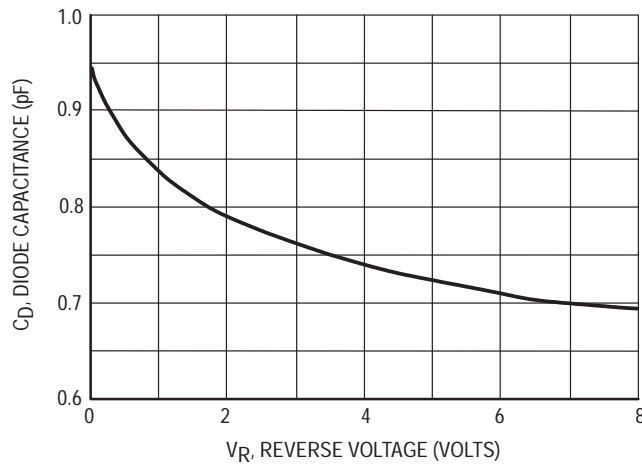
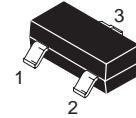


Figure 4. Capacitance

Switching Diode

MMBD6050LT1



CASE 318-08, STYLE 8
SOT-23 (TO-236AB)

MAXIMUM RATINGS

Rating	Symbol	Value	Unit
Reverse Voltage	V_R	70	Vdc
Forward Current	I_F	200	mAdc
Peak Forward Surge Current	$I_{FM(surge)}$	500	mAdc

THERMAL CHARACTERISTICS

Characteristic	Symbol	Max	Unit
Total Device Dissipation FR-5 Board ⁽¹⁾ $T_A = 25^\circ\text{C}$ Derate above 25°C	P_D	225 1.8	mW mW/ $^\circ\text{C}$
Thermal Resistance, Junction to Ambient	$R_{\theta JA}$	556	$^\circ\text{C/W}$
Total Device Dissipation Alumina Substrate, ⁽²⁾ $T_A = 25^\circ\text{C}$ Derate above 25°C	P_D	300 2.4	mW mW/ $^\circ\text{C}$
Thermal Resistance, Junction to Ambient	$R_{\theta JA}$	417	$^\circ\text{C/W}$
Junction and Storage Temperature	T_J, T_{stg}	-55 to +150	$^\circ\text{C}$

DEVICE MARKING

MMBD6050LT1 = 5A

ELECTRICAL CHARACTERISTICS ($T_A = 25^\circ\text{C}$ unless otherwise noted)

Characteristic	Symbol	Min	Max	Unit
----------------	--------	-----	-----	------

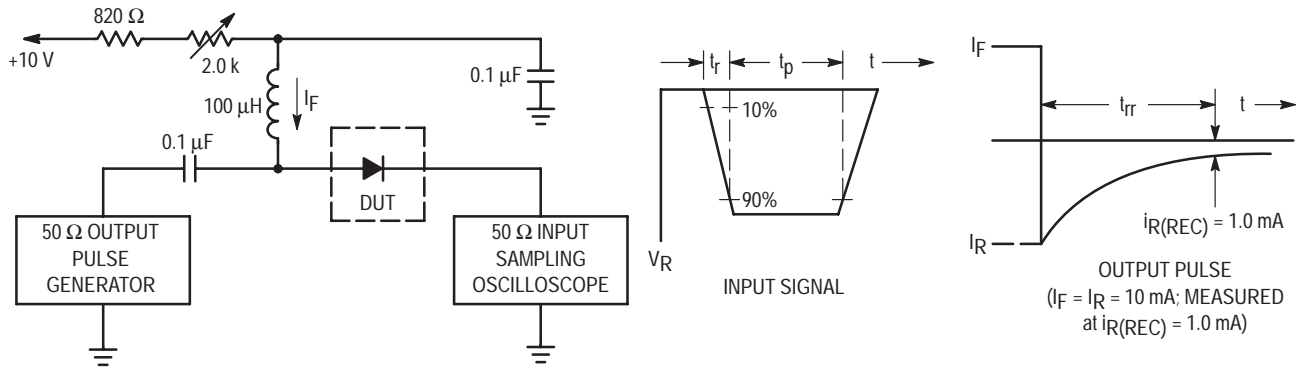
OFF CHARACTERISTICS

Reverse Breakdown Voltage ($I_{(BR)} = 100 \mu\text{Adc}$)	$V_{(BR)}$	70	—	Vdc
Reverse Voltage Leakage Current ($V_R = 50 \text{ Vdc}$)	I_R	—	0.1	μAdc
Forward Voltage ($I_F = 1.0 \text{ mAdc}$) ($I_F = 100 \text{ mAdc}$)	V_F	0.55 0.85	0.7 1.1	Vdc
Reverse Recovery Time ($I_F = I_R = 10 \text{ mAdc}$, $I_{R(REC)} = 1.0 \text{ mAdc}$) (Figure 1)	t_{rr}	—	4.0	ns
Capacitance ($V_R = 0 \text{ V}$)	C	—	2.5	pF

1. FR-5 = $1.0 \times 0.75 \times 0.062 \text{ in.}$

2. Alumina = $0.4 \times 0.3 \times 0.024 \text{ in. 99.5\% alumina.}$

MMBD6050LT1



- Notes: 1. A 2.0 kΩ variable resistor adjusted for a Forward Current (I_F) of 10 mA.
 2. Input pulse is adjusted so $I_{R(\text{peak})}$ is equal to 10 mA.
 3. $t_p \gg t_{rr}$

Figure 1. Recovery Time Equivalent Test Circuit

TYPICAL CHARACTERISTICS

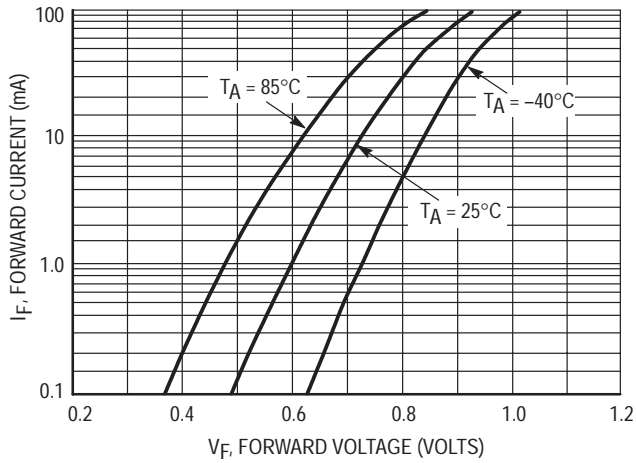


Figure 2. Forward Voltage

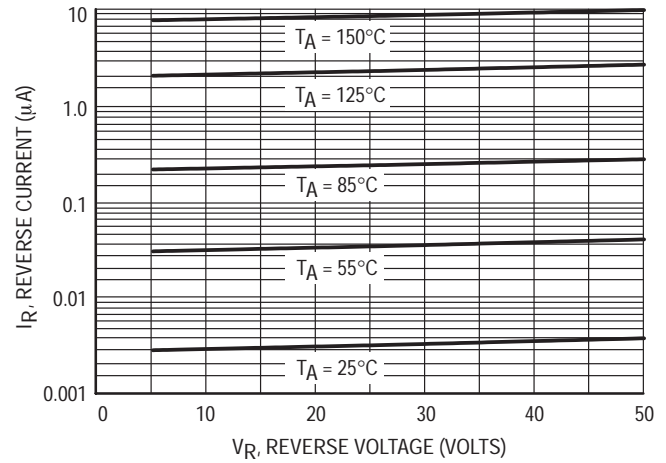


Figure 3. Leakage Current

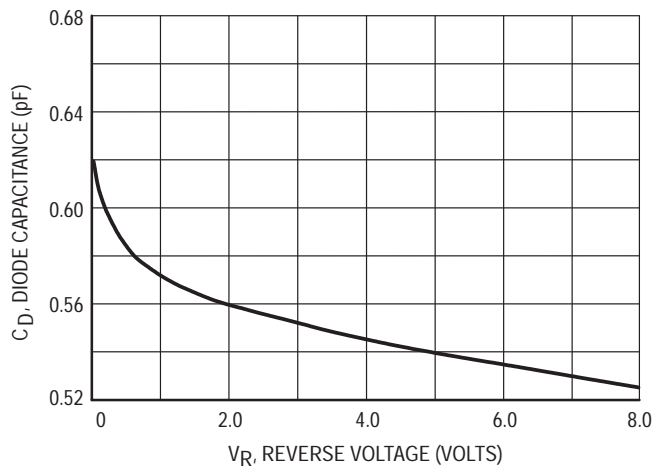
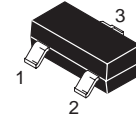
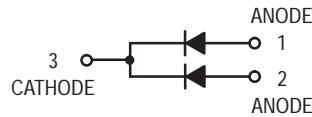


Figure 4. Capacitance

Monolithic Dual Switching Diode

MMBD6100LT1



CASE 318-08, STYLE 9
SOT-23 (TO-236AB)

MAXIMUM RATINGS (EACH DIODE)

Rating	Symbol	Value	Unit
Reverse Voltage	V_R	70	Vdc
Forward Current	I_F	200	mAdc
Peak Forward Surge Current	$I_{FM}(\text{surge})$	500	mAdc

THERMAL CHARACTERISTICS

Characteristic	Symbol	Max	Unit
Total Device Dissipation FR-5 Board ⁽¹⁾ $T_A = 25^\circ\text{C}$ Derate above 25°C	P_D	225 1.8	mW mW/ $^\circ\text{C}$
Thermal Resistance, Junction to Ambient	$R_{\theta JA}$	556	$^\circ\text{C}/\text{W}$
Total Device Dissipation Alumina Substrate, ⁽²⁾ $T_A = 25^\circ\text{C}$ Derate above 25°C	P_D	300 2.4	mW mW/ $^\circ\text{C}$
Thermal Resistance, Junction to Ambient	$R_{\theta JA}$	417	$^\circ\text{C}/\text{W}$
Junction and Storage Temperature	T_J, T_{stg}	-55 to +150	$^\circ\text{C}$

DEVICE MARKING

MMBD6100LT1 = 5BM

ELECTRICAL CHARACTERISTICS ($T_A = 25^\circ\text{C}$ unless otherwise noted) (EACH DIODE)

Characteristic	Symbol	Min	Max	Unit
----------------	--------	-----	-----	------

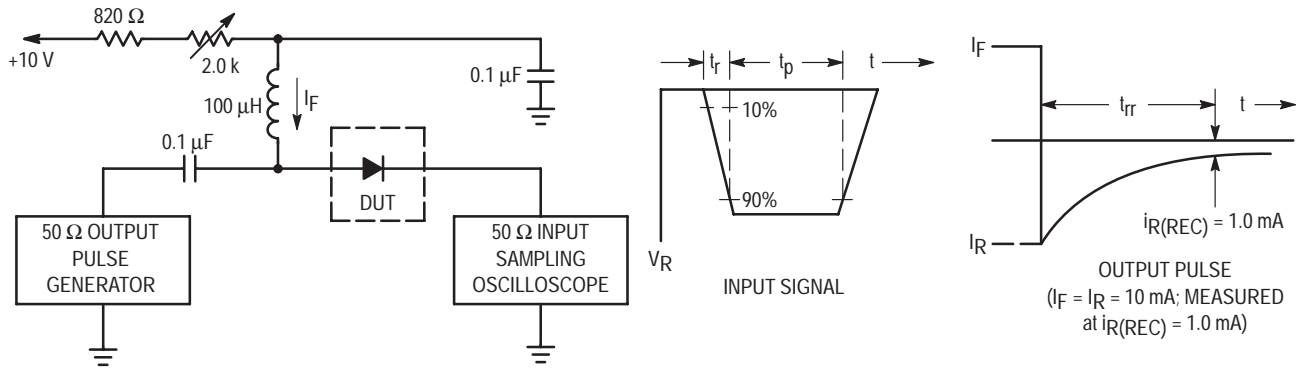
OFF CHARACTERISTICS

Reverse Breakdown Voltage ($I_{BR} = 100 \mu\text{Adc}$)	$V_{(BR)}$	70	—	Vdc
Reverse Voltage Leakage Current ($V_R = 50 \text{Vdc}$)	I_R	—	0.1	μAdc
Forward Voltage ($I_F = 1.0 \text{mAdc}$) ($I_F = 100 \text{mAdc}$)	V_F	0.55 0.85	0.7 1.1	Vdc
Reverse Recovery Time ($I_F = I_R = 10 \text{mAdc}$, $I_{R(REC)} = 1.0 \text{mAdc}$) (Figure 1)	t_{rr}	—	4.0	ns
Capacitance ($V_R = 0 \text{V}$)	C	—	2.5	pF

1. FR-5 = $1.0 \times 0.75 \times 0.062 \text{ in.}$

2. Alumina = $0.4 \times 0.3 \times 0.024 \text{ in.}$ 99.5% alumina.

MMBD6100LT1



- Notes: 1. A 2.0 kΩ variable resistor adjusted for a Forward Current (I_F) of 10 mA.
 2. Input pulse is adjusted so $I_{R(peak)}$ is equal to 10 mA.
 3. $t_p \gg t_{rr}$

Figure 1. Recovery Time Equivalent Test Circuit

CURVES APPLICABLE TO EACH CATHODE

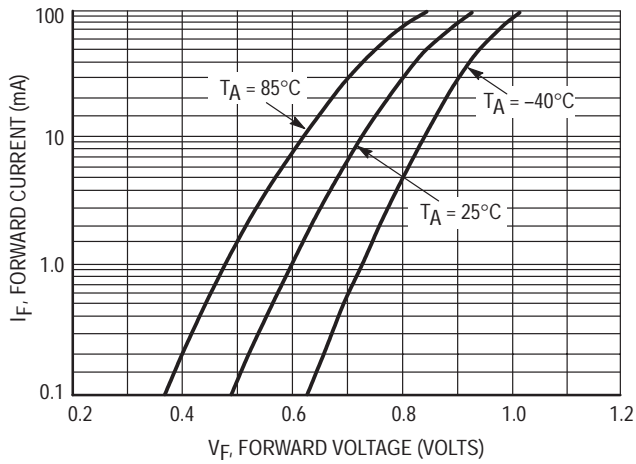


Figure 2. Forward Voltage

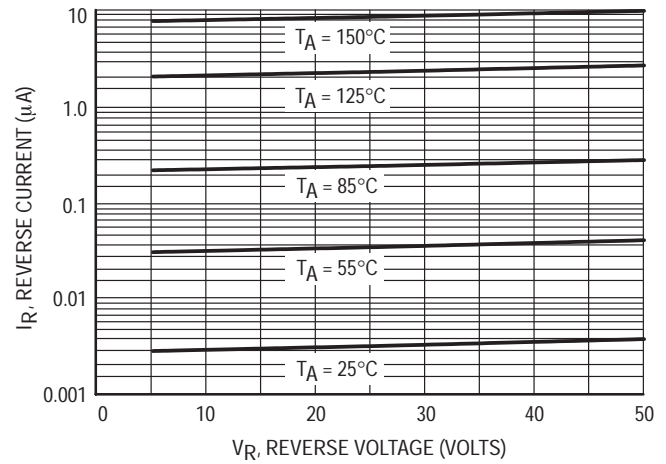


Figure 3. Leakage Current

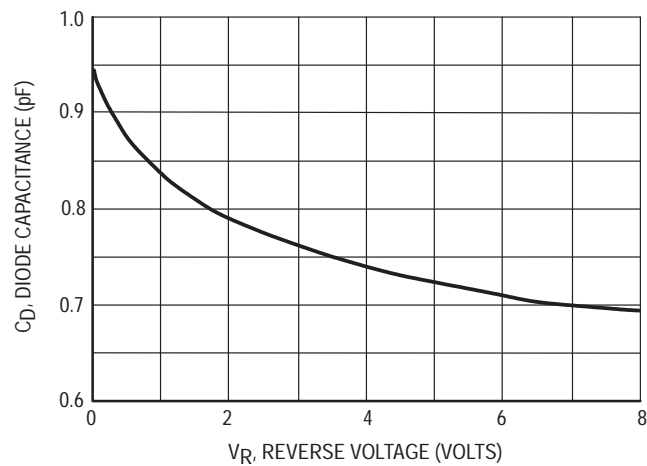
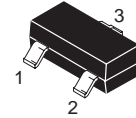
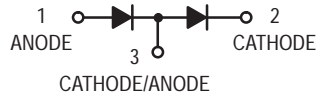


Figure 4. Capacitance

Dual Switching Diode

MMBD7000LT1

Motorola Preferred Device



CASE 318-08, STYLE 11
SOT-23 (TO-236AB)

MAXIMUM RATINGS (EACH DIODE)

Rating	Symbol	Value	Unit
Reverse Voltage	V_R	100	Vdc
Forward Current	I_F	200	mAdc
Peak Forward Surge Current	$I_{FM}(\text{surge})$	500	mAdc

THERMAL CHARACTERISTICS

Characteristic	Symbol	Max	Unit
Total Device Dissipation FR-5 Board ⁽¹⁾ $T_A = 25^\circ\text{C}$ Derate above 25°C	P_D	225 1.8	mW mW/ $^\circ\text{C}$
Thermal Resistance, Junction to Ambient	$R_{\theta JA}$	556	$^\circ\text{C}/\text{W}$
Total Device Dissipation Alumina Substrate, ⁽²⁾ $T_A = 25^\circ\text{C}$ Derate above 25°C	P_D	300 2.4	mW mW/ $^\circ\text{C}$
Thermal Resistance, Junction to Ambient	$R_{\theta JA}$	417	$^\circ\text{C}/\text{W}$
Junction and Storage Temperature	T_J, T_{stg}	-55 to +150	$^\circ\text{C}$

DEVICE MARKING

MMBD7000LT1 = M5C

ELECTRICAL CHARACTERISTICS ($T_A = 25^\circ\text{C}$ unless otherwise noted) (EACH DIODE)

Characteristic	Symbol	Min	Max	Unit
----------------	--------	-----	-----	------

OFF CHARACTERISTICS

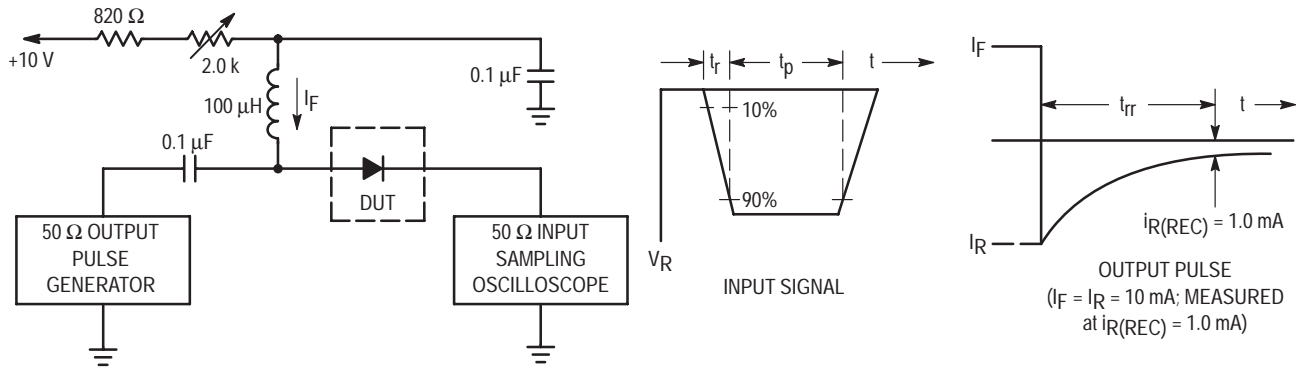
Reverse Breakdown Voltage ($I_{(BR)} = 100 \mu\text{Adc}$)	$V_{(BR)}$	100	—	Vdc
Reverse Voltage Leakage Current ($V_R = 50 \text{ Vdc}$) ($V_R = 100 \text{ Vdc}$) ($V_R = 50 \text{ Vdc}, 125^\circ\text{C}$)	I_R I_{R2} I_{R3}	— — —	1.0 3.0 100	μAdc
Forward Voltage ($I_F = 1.0 \text{ mAdc}$) ($I_F = 10 \text{ mAdc}$) ($I_F = 100 \text{ mAdc}$)	V_F	0.55 0.67 0.75	0.7 0.82 1.1	Vdc
Reverse Recovery Time ($I_F = I_R = 10 \text{ mAdc}$) (Figure 1)	t_{rr}	—	4.0	ns
Capacitance ($V_R = 0 \text{ V}$)	C	—	1.5	pF

1. FR-5 = $1.0 \times 0.75 \times 0.062 \text{ in.}$

2. Alumina = $0.4 \times 0.3 \times 0.024 \text{ in.}$ 99.5% alumina.

Preferred devices are Motorola recommended choices for future use and best overall value.

MMBD7000LT1



- Notes: 1. A 2.0 kΩ variable resistor adjusted for a Forward Current (I_F) of 10 mA.
 2. Input pulse is adjusted so $I_{R(peak)}$ is equal to 10 mA.
 3. $t_p \gg t_{rr}$

Figure 1. Recovery Time Equivalent Test Circuit

CURVES APPLICABLE TO EACH DIODE

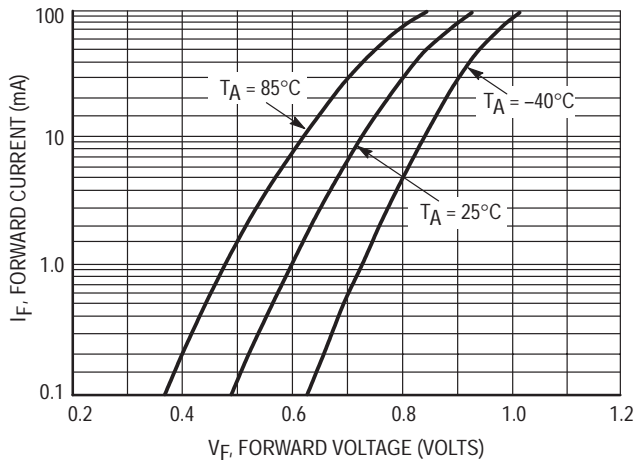


Figure 2. Forward Voltage

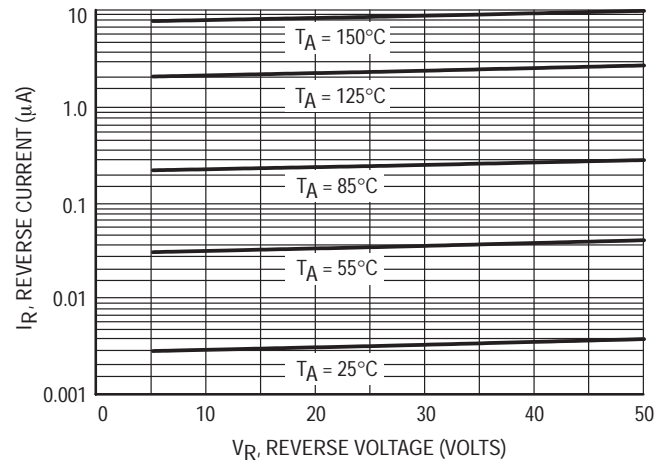


Figure 3. Leakage Current

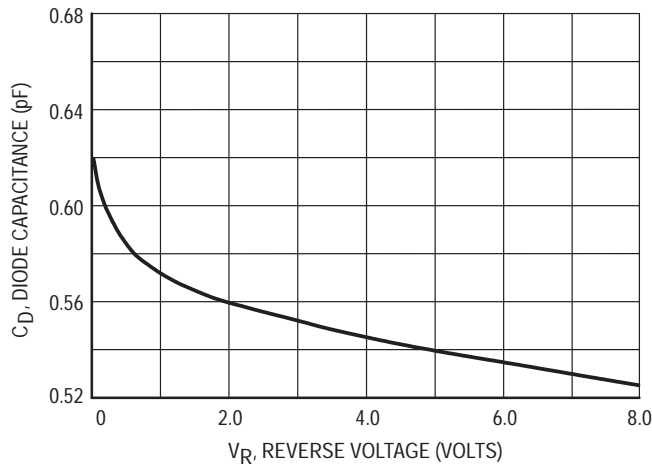


Figure 4. Capacitance

Silicon Tuning Diode

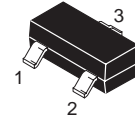
This device is designed in the Surface Mount package for general frequency control and tuning applications. It provides solid-state reliability in replacement of mechanical tuning methods.

- Controlled and Uniform Tuning Ratio

MMBV105GLT1

Motorola Preferred Device

**30 VOLT
VOLTAGE VARIABLE
CAPACITANCE DIODE**



CASE 318-08, STYLE 8
SOT-23 (TO-236AB)



MAXIMUM RATINGS

Rating	Symbol	Value	Unit
Reverse Voltage	V_R	30	Vdc
Forward Current	I_F	200	mAdc
Device Dissipation @ $T_A = 25^\circ\text{C}$ Derate above 25°C	P_D	225 1.8	mW mW/ $^\circ\text{C}$
Junction Temperature	T_J	+125	$^\circ\text{C}$
Storage Temperature Range	T_{stg}	-55 to +150	$^\circ\text{C}$

DEVICE MARKING

MMBV105GLT1 = M4E

ELECTRICAL CHARACTERISTICS ($T_A = 25^\circ\text{C}$ unless otherwise noted)

Characteristic	Symbol	Min	Max	Unit
Reverse Breakdown Voltage ($I_R = 10 \mu\text{Adc}$)	$V_{(BR)R}$	30	—	Vdc
Reverse Voltage Leakage Current ($V_R = 28 \text{Vdc}$)	I_R	—	50	nAdc

Device Type	C_T $V_R = 25 \text{Vdc}$, $f = 1.0 \text{MHz}$ pF		Q $V_R = 3.0 \text{Vdc}$ $f = 50 \text{MHz}$	C_R C_3/C_{25} $f = 1.0 \text{MHz}$	
	Min	Max	Typ	Min	Max
MMBV105GLT1	1.5	2.8	250	4.0	6.5

Preferred devices are Motorola recommended choices for future use and best overall value.

TYPICAL CHARACTERISTICS

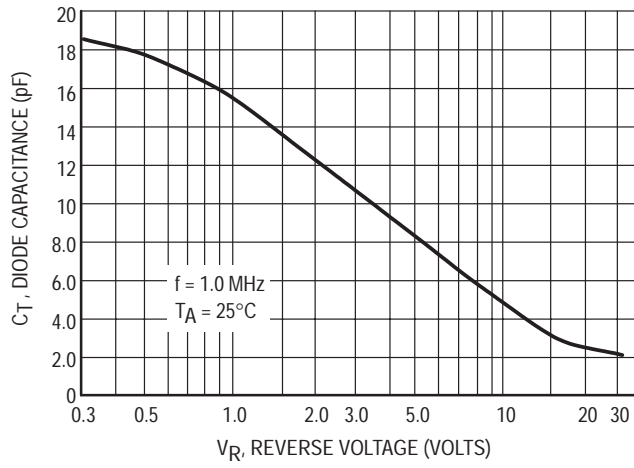


Figure 1. Diode Capacitance

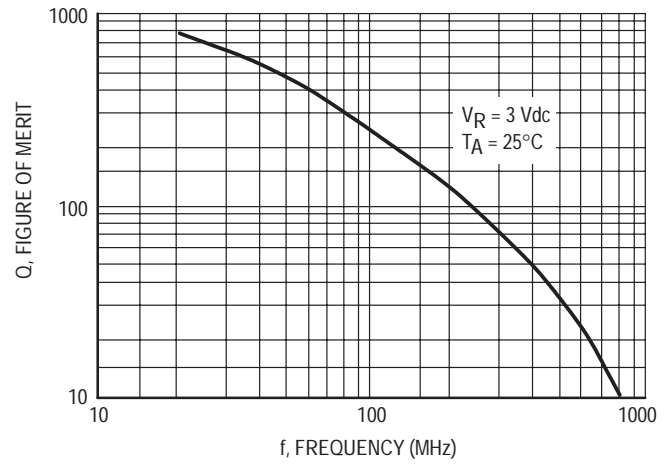


Figure 2. Figure of Merit

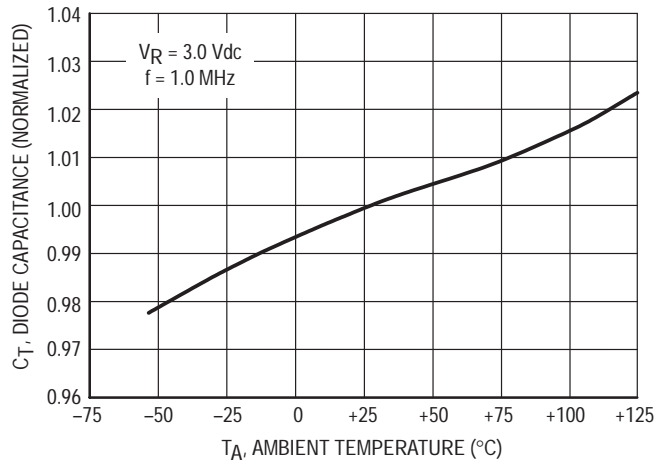


Figure 3. Diode Capacitance

Silicon Tuning Diodes

These devices are designed for general frequency control and tuning applications. They provide solid-state reliability in replacement of mechanical tuning methods.

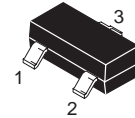
- High Q with Guaranteed Minimum Values at VHF Frequencies
- Controlled and Uniform Tuning Ratio
- Available in Surface Mount Package



MMBV409LT1 MV409

Motorola Preferred Devices

VOLTAGE VARIABLE CAPACITANCE DIODES



CASE 318-08, STYLE 8
SOT-23 (TO-236AB)



CASE 182-02, STYLE 1
TO-92 (TO-226AC)

MAXIMUM RATINGS

Rating	Symbol	MBV409	MMBV409LT1	Unit
Reverse Voltage	V_R	20		Vdc
Forward Current	I_F	200		mAdc
Forward Power Dissipation @ $T_A = 25^\circ\text{C}$ Derate above 25°C	P_D	280 2.8	225 1.8	mW mW/ $^\circ\text{C}$
Junction Temperature	T_J	+125		$^\circ\text{C}$
Storage Temperature Range	T_{stg}	-55 to +150		$^\circ\text{C}$

DEVICE MARKING

MMBV409LT1 = X5, MV409 = MV409

ELECTRICAL CHARACTERISTICS ($T_A = 25^\circ\text{C}$ unless otherwise noted)

Characteristic	Symbol	Min	Typ	Max	Unit
Reverse Breakdown Voltage ($I_R = 10 \mu\text{Adc}$)	$V_{(BR)R}$	20	—	—	Vdc
Reverse Voltage Leakage Current ($V_R = 15 \text{Vdc}$)	I_R	—	—	0.1	μAdc
Diode Capacitance Temperature Coefficient ($V_R = 3.0 \text{Vdc}$, $f = 1.0 \text{MHz}$)	TC_C	—	300	—	ppm/ $^\circ\text{C}$

Device	C_t , Diode Capacitance $V_R = 3.0 \text{Vdc}$, $f = 1.0 \text{MHz}$ pF			Q , Figure of Merit $V_R = 3.0 \text{Vdc}$ $f = 50 \text{MHz}$	C_R , Capacitance Ratio C_3/C_8 $f = 1.0 \text{MHz}$ (1)	
	Min	Nom	Max	Min	Min	Max
MMBV409LT1, MV409	26	29	32	200	1.5	1.9

1. C_R is the ratio of C_t measured at 3 Vdc divided by C_t measured at 8 Vdc.

Preferred devices are Motorola recommended choices for future use and best overall value.

TYPICAL CHARACTERISTICS

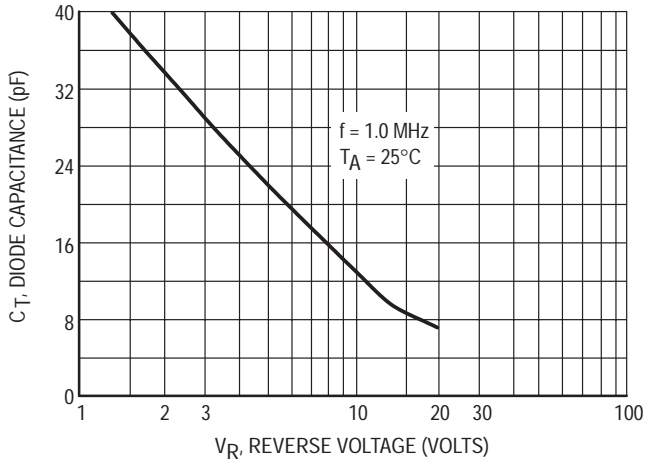


Figure 1. Diode Capacitance

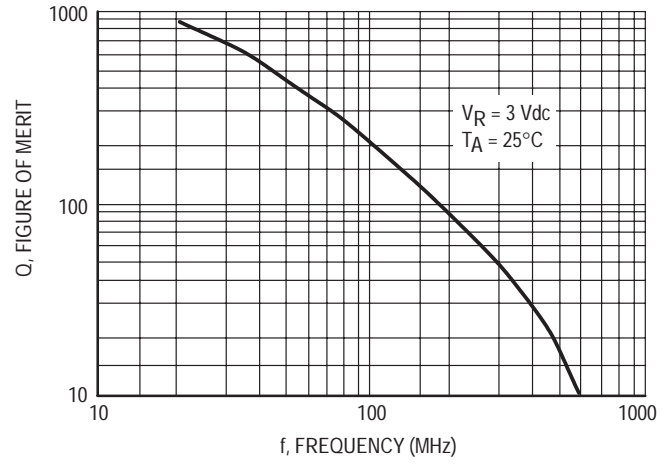


Figure 2. Figure of Merit

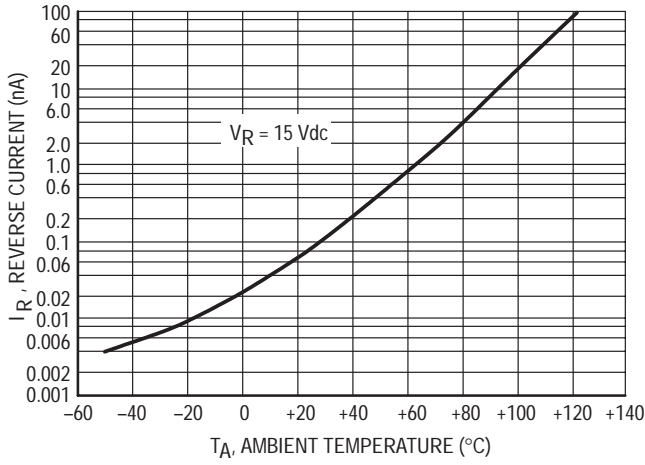


Figure 3. Leakage Current

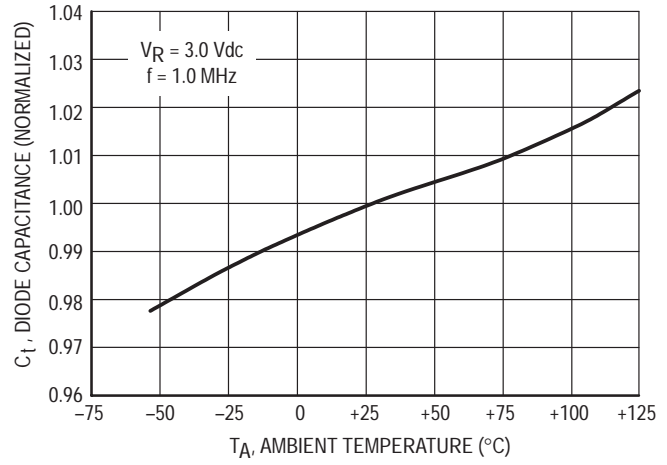
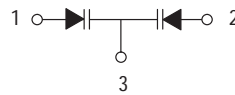


Figure 4. Diode Capacitance

Silicon Tuning Diode

This device is designed for FM tuning, general frequency control and tuning, or any top-of-the-line application requiring back-to-back diode configuration for minimum signal distortion and detuning. This device is supplied in the SOT-23 plastic package for high volume, pick and place assembly requirements.

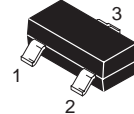
- High Figure of Merit — $Q = 150$ (Typ) @ $V_R = 2.0$ Vdc, $f = 100$ MHz
- Guaranteed Capacitance Range
- Dual Diodes – Save Space and Reduce Cost
- Surface Mount Package
- Available in 8 mm Tape and Reel
- Monolithic Chip Provides Improved Matching – Guaranteed $\pm 1.0\%$ (Max) Over Specified Tuning Range



MMBV432LT1

Motorola Preferred Device

**DUAL
VOLTAGE VARIABLE
CAPACITANCE DIODE**



**CASE 318-08, STYLE 9
SOT-23 (TO-236AB)**

MAXIMUM RATINGS (Each Diode)

Rating	Symbol	Value	Unit
Reverse Voltage	V_R	14	Vdc
Forward Current	I_F	200	mAdc
Total Power Dissipation @ $T_A = 25^\circ\text{C}$ Derate above 25°C	P_D	225 1.8	mW mW/ $^\circ\text{C}$
Junction Temperature	T_J	+125	$^\circ\text{C}$
Storage Temperature Range	T_{stg}	-55 to +125	$^\circ\text{C}$

DEVICE MARKING

MMBV432LT1 = M4B

ELECTRICAL CHARACTERISTICS ($T_A = 25^\circ\text{C}$ unless otherwise noted) (EACH DIODE)

Characteristic	Symbol	Min	Typ	Max	Unit
Reverse Breakdown Voltage ($I_R = 10 \mu\text{Adc}$)	$V_{(BR)R}$	14	—	—	Vdc
Reverse Voltage Leakage Current ($V_R = 9.0$ Vdc)	I_R	—	—	100	nAdc
Diode Capacitance ($V_R = 2.0$ Vdc, $f = 1.0$ MHz)	C_T	43	—	48.1	pF
Capacitance Ratio C_2/C_8 ($f = 1.0$ MHz)	C_R	1.5	—	2.0	—
Figure of Merit ($V_R = 2.0$ Vdc, $f = 100$ MHz)	Q	100	150	—	—

Preferred devices are Motorola recommended choices for future use and best overall value.

TYPICAL CHARACTERISTICS (Each Diode)

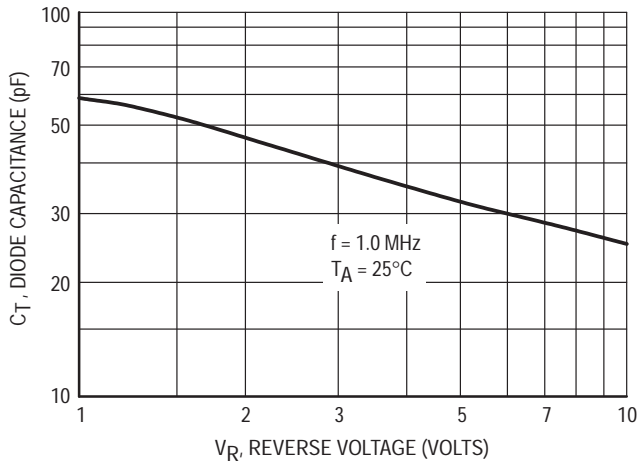


Figure 1. Diode Capacitance

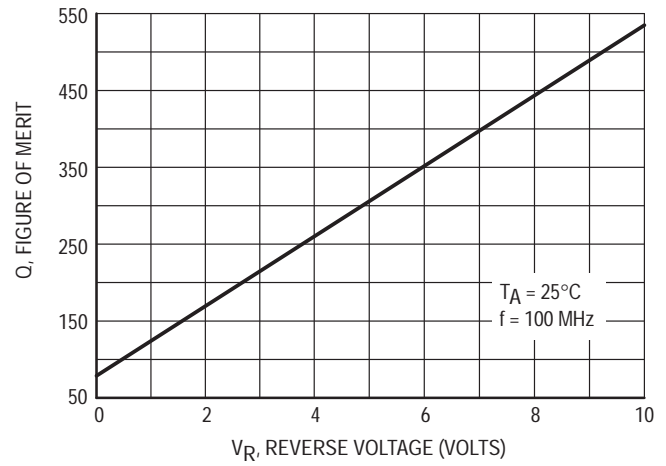


Figure 2. Figure of Merit versus Voltage

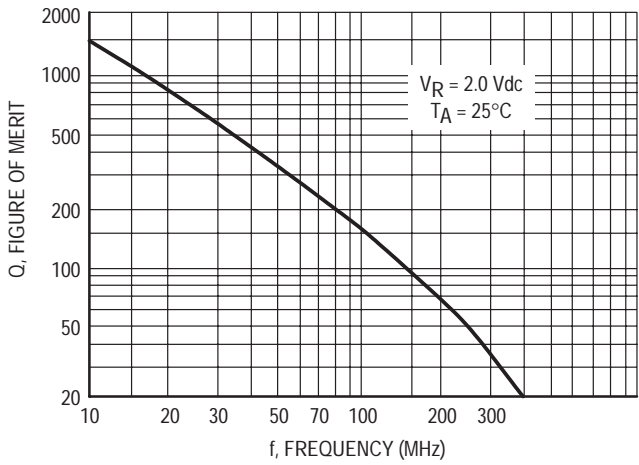


Figure 3. Figure of Merit versus Frequency

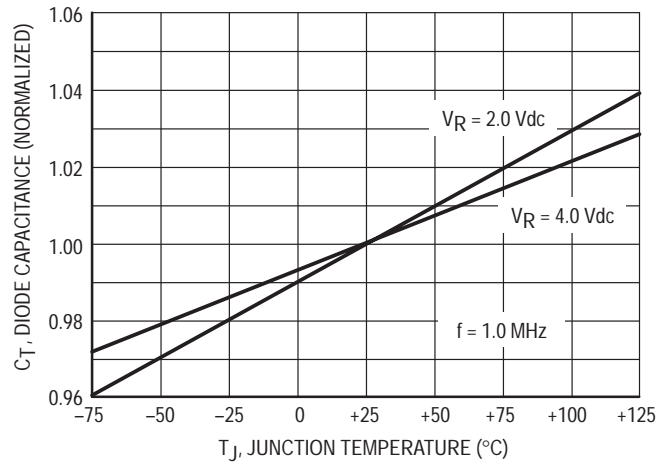


Figure 4. Diode Capacitance versus Temperature

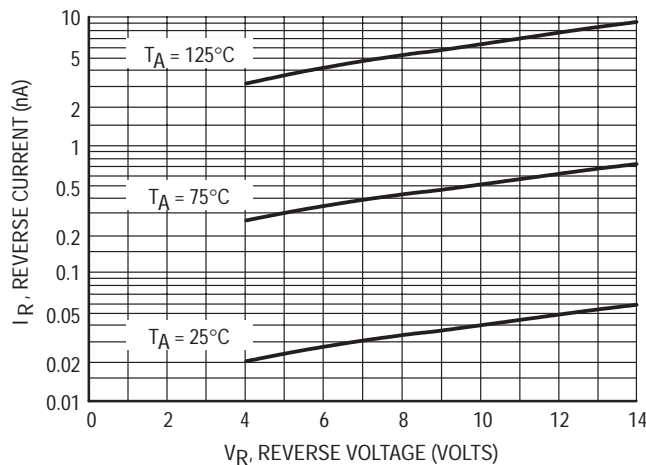
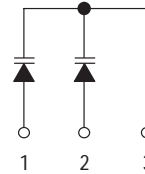


Figure 5. Reverse Current versus Reverse Voltage

Silicon Tuning Diode

This device is designed for FM tuning, general frequency control and tuning, or any top-of-the-line application requiring back-to-back diode configuration for minimum signal distortion and detuning. This device is supplied in the SOT-23 plastic package for high volume, pick and place assembly requirements.

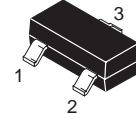
- High Figure of Merit — $Q = 450$ (Typ) @ $V_R = 3.0$ Vdc, $f = 50$ MHz
- Guaranteed Capacitance Range
- Dual Diodes – Save Space and Reduce Cost
- Surface Mount Package
- Available in 8 mm Tape and Reel
- Monolithic Chip Provides Improved Matching
- Hyper Abrupt Junction Process Provides High Tuning Ratio



MMBV609LT1

Motorola Preferred Device

**DUAL
VOLTAGE VARIABLE
CAPACITANCE DIODE**



**CASE 318-08, STYLE 9
SOT-23 (TO-236AB)**

MAXIMUM RATINGS (Each Diode)

Rating	Symbol	Value	Unit
Reverse Voltage	V_R	20	Vdc
Forward Current	I_F	100	mAdc
Total Power Dissipation @ $T_A = 25^\circ\text{C}$ Derate above 25°C	P_D	225 1.8	mW mW/ $^\circ\text{C}$
Junction Temperature	T_J	+125	$^\circ\text{C}$
Storage Temperature Range	T_{stg}	-55 to +125	$^\circ\text{C}$

DEVICE MARKING

MMBV609LT1 = 5L

ELECTRICAL CHARACTERISTICS ($T_A = 25^\circ\text{C}$ unless otherwise noted) (EACH DIODE)

Characteristic	Symbol	Min	Typ	Max	Unit
Reverse Breakdown Voltage ($I_R = 10 \mu\text{Adc}$)	$V_{(BR)R}$	20	—	—	Vdc
Reverse Voltage Leakage Current ($V_R = 15$ Vdc)	I_R	—	—	10	nAdc
Diode Capacitance ($V_R = 3.0$ Vdc, $f = 1.0$ MHz)	C_T	26	—	32	pF
Capacitance Ratio C3/C8 ($f = 1.0$ MHz)	C_R	1.8	—	2.4	—
Figure of Merit ($V_R = 3.0$ Vdc, $f = 50$ MHz)	Q	250	450	—	—

Preferred devices are Motorola recommended choices for future use and best overall value.

TYPICAL CHARACTERISTICS

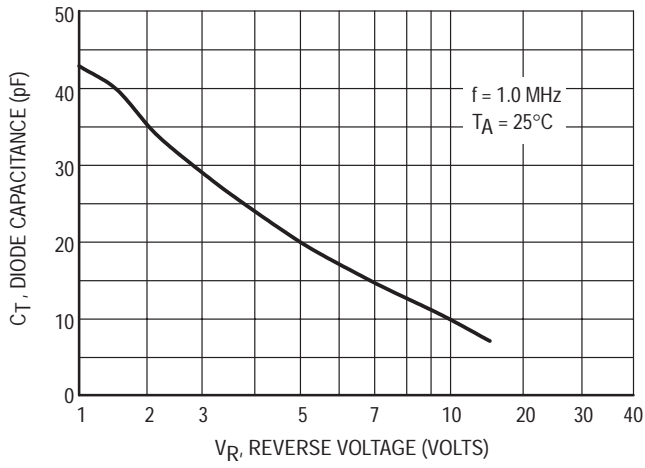


Figure 1. Diode Capacitance

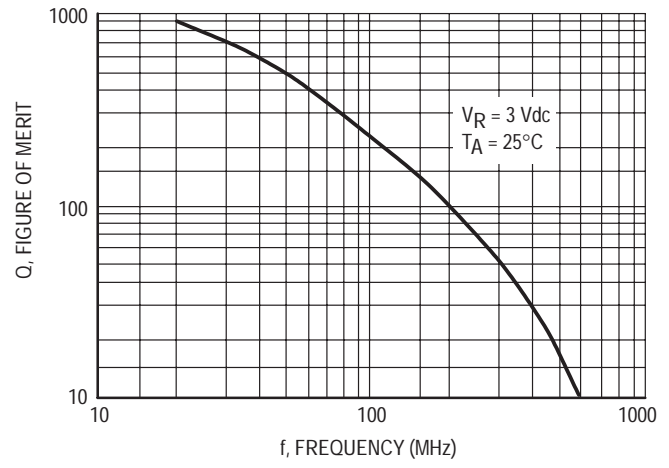


Figure 2. Figure of Merit

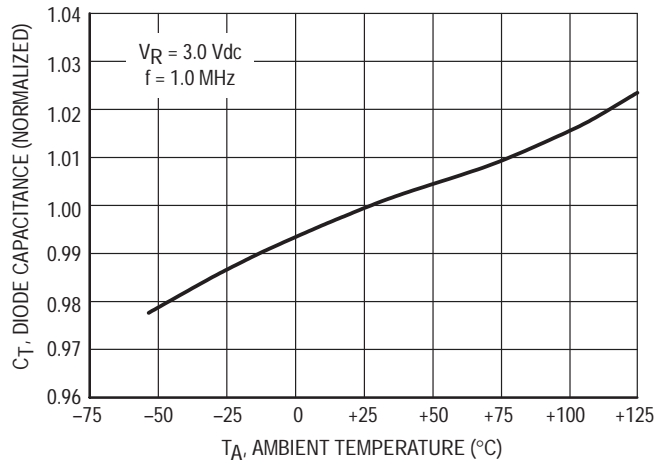


Figure 3. Diode Capacitance

Silicon Tuning Diode

This device is designed for 900 MHz frequency control and tuning applications. It provides solid-state reliability in replacement of mechanical tuning methods.

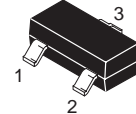
- Controlled and Uniform Tuning Ratio
- Available in Surface Mount Package
- Available in 8 mm Tape and Reel



MMBV809LT1

Motorola Preferred Device

4.5–6.1 pF
VOLTAGE VARIABLE
CAPACITANCE DIODE



CASE 318–08, STYLE 8
SOT–23 (TO–236AB)

MAXIMUM RATINGS

Rating	Symbol	Value	Unit
Reverse Voltage	V_R	20	Vdc
Forward Current	I_F	20	mAdc
Total Power Dissipation ⁽¹⁾ @ $T_A = 25^\circ\text{C}$ Derate above 25°C	P_D	225 1.8	mW mW/ $^\circ\text{C}$
Junction Temperature	T_J	+125	$^\circ\text{C}$
Storage Temperature Range	T_{stg}	–55 to +125	$^\circ\text{C}$

1. FR5 Board 1.0 x 0.75 x 0.62 in.

DEVICE MARKING

MMBV809LT1 = 5K

ELECTRICAL CHARACTERISTICS ($T_A = 25^\circ\text{C}$ unless otherwise noted)

Characteristic – All Types	Symbol	Min	Typ	Max	Unit
Reverse Breakdown Voltage ($I_R = 10 \mu\text{Adc}$)	$V_{(BR)R}$	20	—	—	Vdc
Reverse Voltage Leakage Current ($V_R = 15 \text{Vdc}$)	I_R	—	—	50	nAdc

Device	C_t , Diode Capacitance $V_R = 2.0 \text{Vdc}$, $f = 1.0 \text{MHz}$ pF			Q , Figure of Merit $V_R = 3.0 \text{Vdc}$ $f = 500 \text{MHz}$	C_R , Capacitance Ratio C_2/C_8 $f = 1.0 \text{MHz}$ (2)	
	Min	Typ	Max	Typ	Min	Max
MMBV809LT1	4.5	5.3	6.1	75	1.8	2.6

2. C_R is the ratio of C_t measured at 2.0 Vdc divided by C_t measured at 8.0 Vdc.

Preferred devices are Motorola recommended choices for future use and best overall value.

TYPICAL CHARACTERISTICS

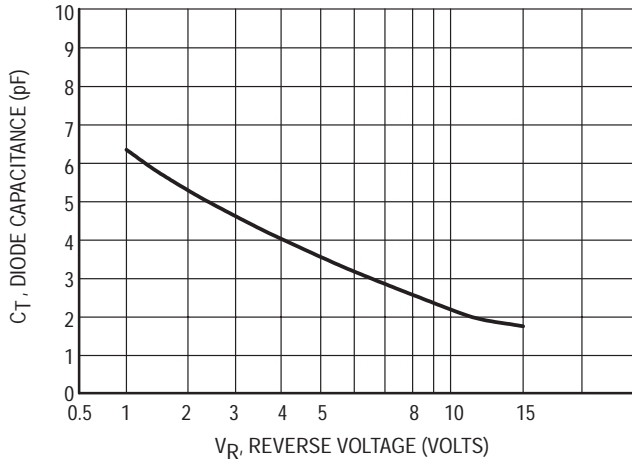


Figure 1. Diode Capacitance

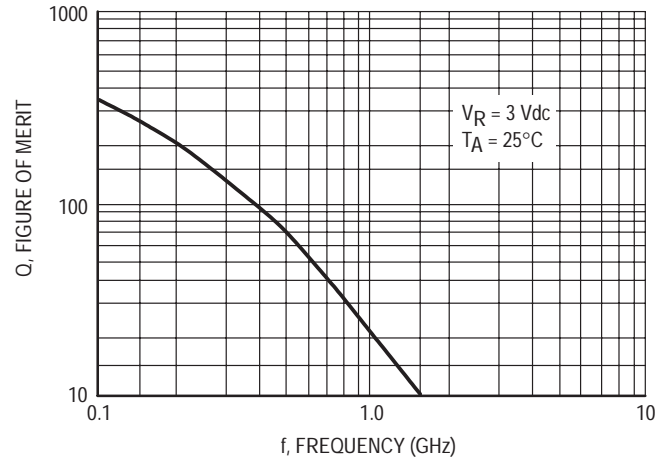


Figure 2. Figure of Merit

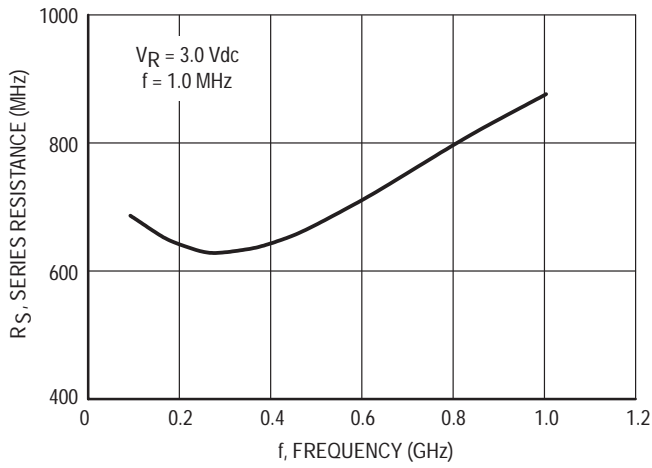


Figure 3. Series Resistance

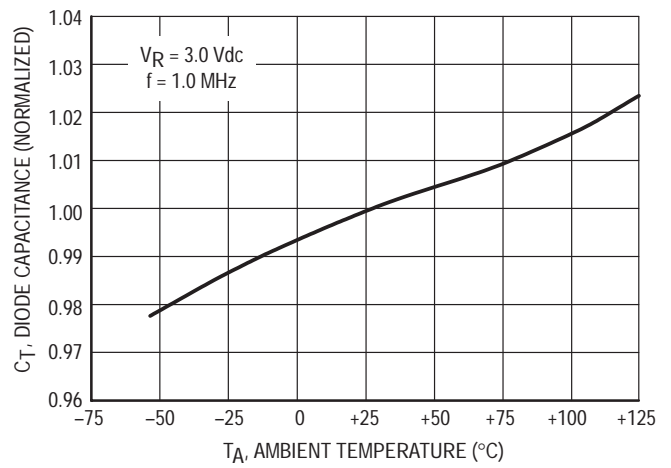
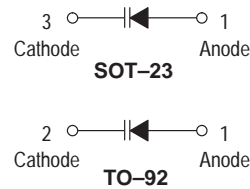


Figure 4. Diode Capacitance

Silicon Tuning Diodes

These devices are designed in the popular PLASTIC PACKAGE for high volume requirements of FM Radio and TV tuning and AFC, general frequency control and tuning applications. They provide solid-state reliability in replacement of mechanical tuning methods. Also available in Surface Mount Package up to 33pF.

- High Q
- Controlled and Uniform Tuning Ratio
- Standard Capacitance Tolerance — 10%
- Complete Typical Design Curves



MMBV2101LT1
MMBV2103LT1
MMBV2105LT1
MMBV2107LT1
MMBV2108LT1
MMBV2109LT1
MV2101 MV2104
MV2105 MV2108
MV2109 MV2111
MV2115

6.8–100 pF
30 VOLTS
VOLTAGE VARIABLE
CAPACITANCE DIODES

MAXIMUM RATINGS

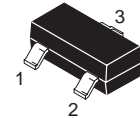
Rating	Symbol	MV21xx	MMBV21xxLT1	Unit
Reverse Voltage	V_R	30		Vdc
Forward Current	I_F	200		mAdc
Forward Power Dissipation @ $T_A = 25^\circ\text{C}$ Derate above 25°C	P_D	280 2.8	225 1.8	mW mW/ $^\circ\text{C}$
Junction Temperature	T_J	+150		$^\circ\text{C}$
Storage Temperature Range	T_{stg}	-55 to +150		$^\circ\text{C}$

DEVICE MARKING

MMBV2101LT1 = M4G	MMBV2107LT1 = 4W
MMBV2103LT1 = 4H	MMBV2108LT1 = 4X
MMBV2105LT1 = 4U	MMBV2109LT1 = 4J

ELECTRICAL CHARACTERISTICS ($T_A = 25^\circ\text{C}$ unless otherwise noted)

Characteristic	Symbol	Min	Typ	Max	Unit
Reverse Breakdown Voltage ($I_R = 10 \mu\text{Adc}$)	$V_{(BR)R}$	30	—	—	Vdc
Reverse Voltage Leakage Current ($V_R = 25 \text{ Vdc}$, $T_A = 25^\circ\text{C}$)	I_R	—	—	0.1	μAdc
Diode Capacitance Temperature Coefficient ($V_R = 4.0 \text{ Vdc}$, $f = 1.0 \text{ MHz}$)	TC_C	—	280	—	ppm/ $^\circ\text{C}$



CASE 318-08, STYLE 8
SOT-23 (TO-236AB)



CASE 182-02, STYLE 1
TO-92 (TO-226AC)

Device	C _T , Diode Capacitance V _R = 4.0 Vdc, f = 1.0 MHz pF			Q, Figure of Merit V _R = 4.0 Vdc, f = 50 MHz	TR, Tuning Ratio C ₂ /C ₃₀ f = 1.0 MHz		
	Min	Nom	Max	Typ	Min	Typ	Max
MMBV2101LT1/MV2101	6.1	6.8	7.5	450	2.5	2.7	3.2
MMBV2103LT1	9.0	10	11	400	2.5	2.9	3.2
MV2104	10.8	12	13.2	400	2.5	2.9	3.2
MMBV2105LT1/MV2105	13.5	15	16.5	400	2.5	2.9	3.2
MMBV2107LT1	19.8	22	24.2	350	2.5	2.9	3.2
MMBV2108LT1/MV2108	24.3	27	29.7	300	2.5	3.0	3.2
MMBV2109LT1/MV2109	29.7	33	36.3	200	2.5	3.0	3.2
MV2111	42.3	47	51.7	150	2.5	3.0	3.2
MV2115	90	100	110	100	2.6	3.0	3.3

MMBV2101LT1, MMBV2103LT1, MMBV2105LT1, MMBV2107LT1 thru MMBV2109LT1, are also available in bulk. Use the device title and drop the "T1" suffix when ordering any of these devices in bulk.

PARAMETER TEST METHODS

1. C_T, DIODE CAPACITANCE

(C_T = C_C + C_J). C_T is measured at 1.0 MHz using a capacitance bridge (Boonton Electronics Model 75A or equivalent).

2. TR, TUNING RATIO

TR is the ratio of C_T measured at 2.0 Vdc divided by C_T measured at 30 Vdc.

3. Q, FIGURE OF MERIT

Q is calculated by taking the G and C readings of an admittance bridge at the specified frequency and substituting in the following equations:

$$Q = \frac{2\pi fC}{G}$$

(Boonton Electronics Model 33AS8 or equivalent). Use Lead Length ≈ 1/16".

4. TCC, DIODE CAPACITANCE TEMPERATURE COEFFICIENT

TCC is guaranteed by comparing C_T at V_R = 4.0 Vdc, f = 1.0 MHz, T_A = -65°C with C_T at V_R = 4.0 Vdc, f = 1.0 MHz, T_A = +85°C in the following equation, which defines TCC:

$$TCC = \left| \frac{C_T(+85^\circ\text{C}) - C_T(-65^\circ\text{C})}{85 + 65} \right| \cdot \frac{10^6}{C_T(25^\circ\text{C})}$$

Accuracy limited by measurement of C_T to ±0.1 pF.

TYPICAL DEVICE CHARACTERISTICS

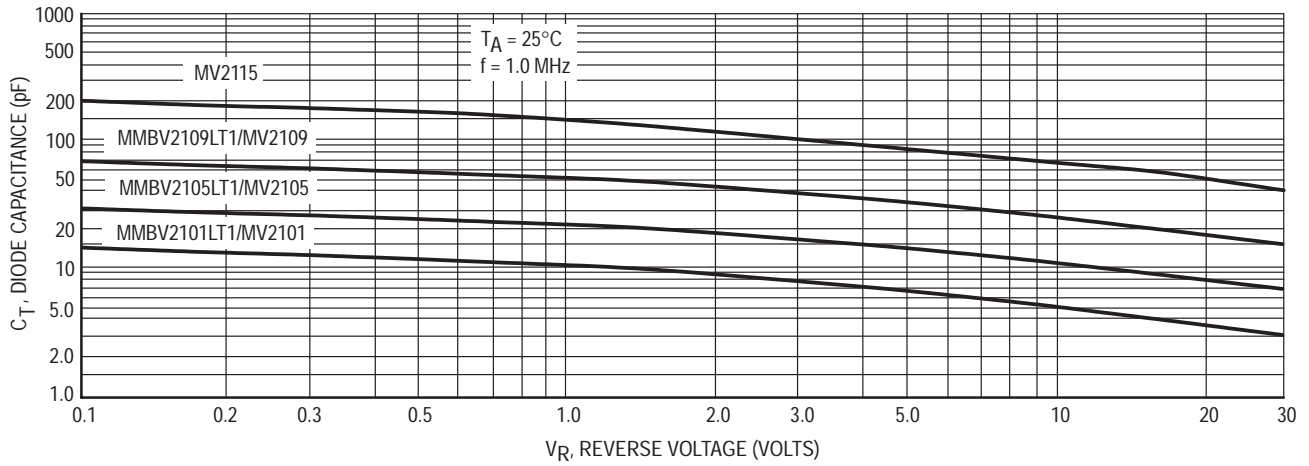


Figure 1. Diode Capacitance versus Reverse Voltage

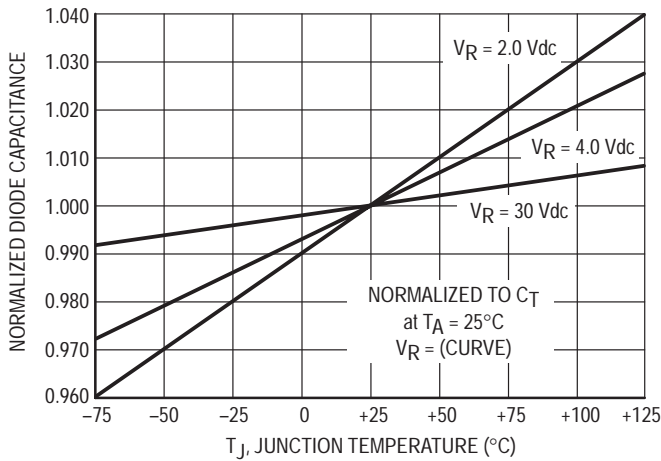


Figure 2. Normalized Diode Capacitance versus Junction Temperature

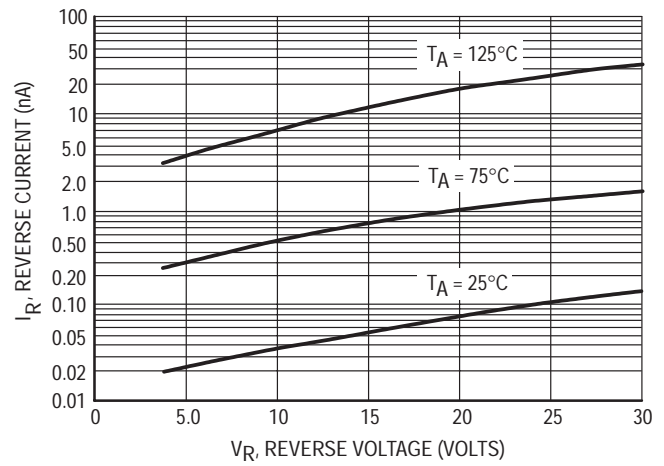


Figure 3. Reverse Current versus Reverse Bias Voltage

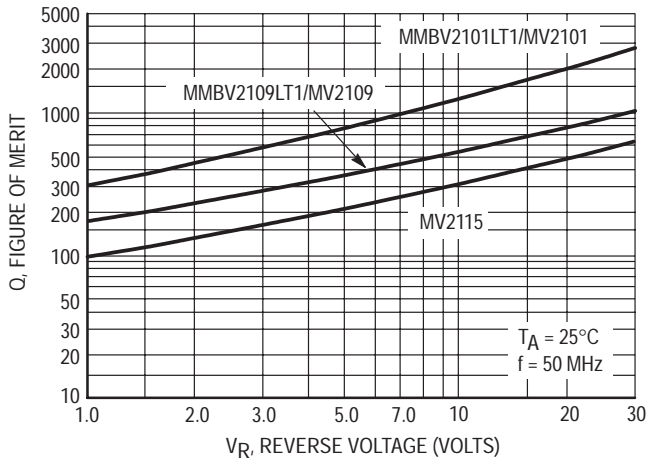


Figure 4. Figure of Merit versus Reverse Voltage

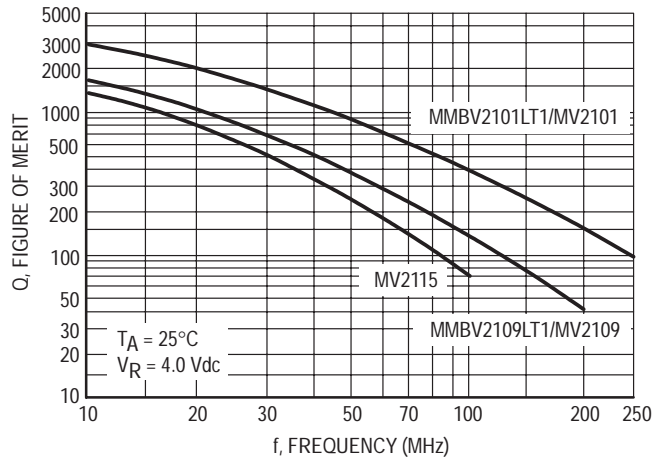


Figure 5. Figure of Merit versus Frequency

Silicon Tuning Diode

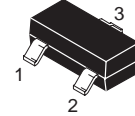
This device is designed in the Surface Mount package for general frequency control and tuning applications. It provides solid-state reliability in replacement of mechanical tuning methods.

- High Q with Guaranteed Minimum Values at VHF Frequencies
- Controlled and Uniform Tuning Ratio

MMBV3102LT1

Motorola Preferred Device

22 pF (Nominal)
30 VOLTS
VOLTAGE VARIABLE
CAPACITANCE DIODE



CASE 318-08, STYLE 8
SOT-23 (TO-236AB)



MAXIMUM RATINGS

Rating	Symbol	Value	Unit
Reverse Voltage	V_R	30	Vdc
Forward Current	I_F	200	mAdc
Device Dissipation @ $T_A = 25^\circ\text{C}$ Derate above 25°C	P_D	225 1.8	mW mW/ $^\circ\text{C}$
Junction Temperature	T_J	+125	$^\circ\text{C}$
Storage Temperature Range	T_{stg}	-55 to +150	$^\circ\text{C}$

DEVICE MARKING

MMBV3102LT1 = M4C

ELECTRICAL CHARACTERISTICS ($T_A = 25^\circ\text{C}$ unless otherwise noted)

Characteristic	Symbol	Min	Typ	Max	Unit
Reverse Breakdown Voltage ($I_R = 10 \mu\text{Adc}$)	$V_{(BR)R}$	30	—	—	Vdc
Reverse Voltage Leakage Current ($V_R = 25 \text{ Vdc}$, $T_A = 25^\circ\text{C}$)	I_R	—	—	0.1	μAdc
Diode Capacitance Temperature Coefficient ($V_R = 4.0 \text{ Vdc}$, $f = 1.0 \text{ MHz}$)	TC_C	—	300	—	ppm/ $^\circ\text{C}$

Device	C_t , Diode Capacitance $V_R = 3.0 \text{ Vdc}$, $f = 1.0 \text{ MHz}$ pF			Q , Figure of Merit $V_R = 3.0 \text{ Vdc}$ $f = 50 \text{ MHz}$	C_R , Capacitance Ratio C_3/C_{25} $f = 1.0 \text{ MHz}$	
	Min	Nom	Max	Min	Min	Typ
MMBV3102LT1	20	22	25	200	4.5	4.8

Preferred devices are Motorola recommended choices for future use and best overall value.

TYPICAL CHARACTERISTICS

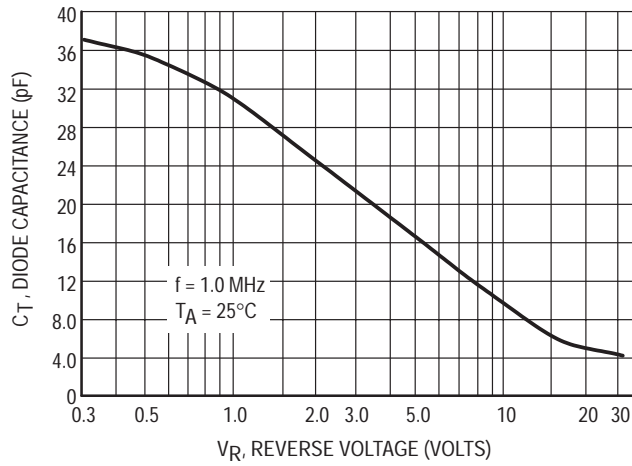


Figure 1. Diode Capacitance

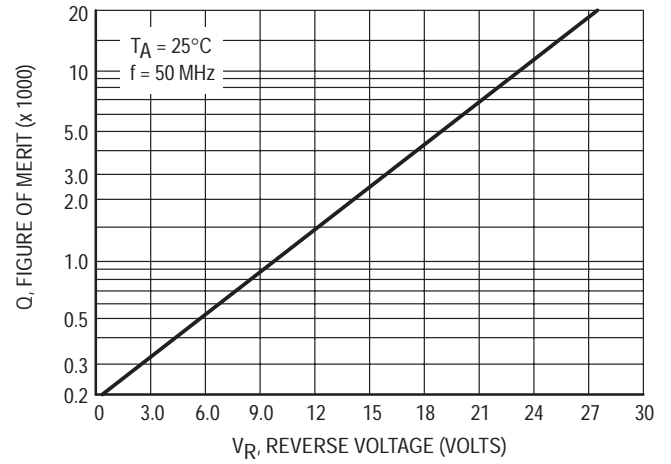


Figure 2. Figure of Merit

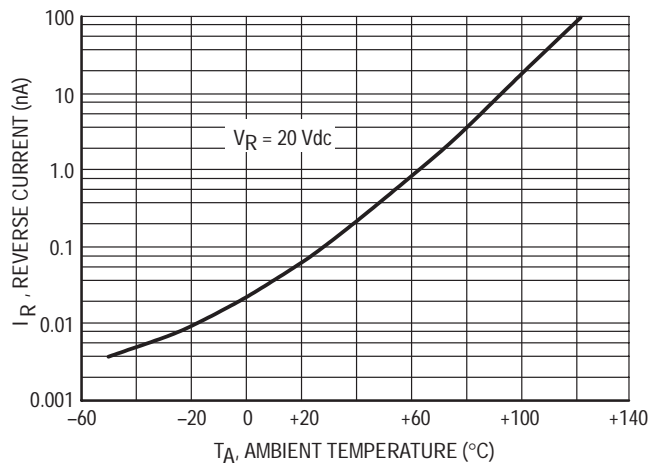


Figure 3. Leakage Current

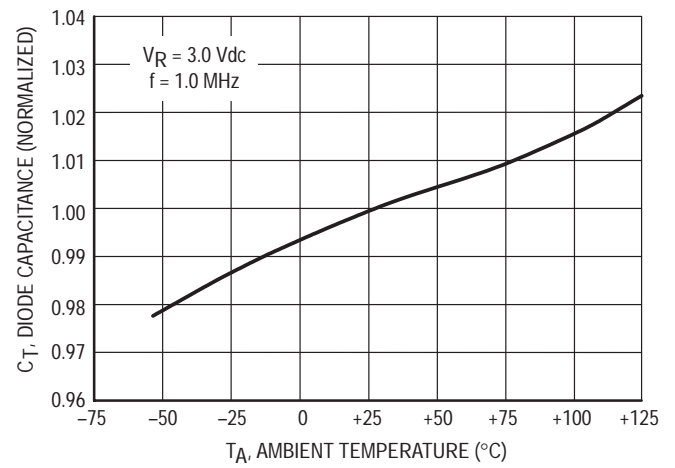


Figure 4. Diode Capacitance

NOTES ON TESTING AND SPECIFICATIONS

1. C_R is the ratio of C_T measured at 3.0 Vdc divided by C_T measured at 25 Vdc.

Silicon Pin Diode

This device is designed primarily for VHF band switching applications but is also suitable for use in general-purpose switching circuits. Supplied in a Surface Mount package.

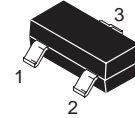
- Rugged PIN Structure Coupled with Wirebond Construction for Optimum Reliability
- Low Capacitance — 0.7 pF Typ at $V_R = 20$ Vdc
- Very Low Series Resistance at 100 MHz — 0.34 Ohms (Typ) @ $I_F = 10$ mAdc



MMBV3401LT1

Motorola Preferred Device

**SILICON PIN
SWITCHING DIODE**



**CASE 318-08, STYLE 8
SOT-23 (TO-236AB)**

MAXIMUM RATINGS

Rating	Symbol	Value	Unit
Reverse Voltage	V_R	20	Vdc
Forward Power Dissipation @ $T_A = 25^\circ\text{C}$ Derate above 25°C	P_D	200 2.0	mW mW/ $^\circ\text{C}$
Junction Temperature	T_J	+125	$^\circ\text{C}$
Storage Temperature Range	T_{stg}	-55 to +150	$^\circ\text{C}$

DEVICE MARKING

MMBV3401LT1 = 4D

ELECTRICAL CHARACTERISTICS ($T_A = 25^\circ\text{C}$ unless otherwise noted)

Characteristic	Symbol	Min	Typ	Max	Unit
Reverse Breakdown Voltage ($I_R = 10 \mu\text{Adc}$)	$V_{(BR)R}$	35	—	—	Vdc
Diode Capacitance ($V_R = 20$ Vdc)	C_T	—	—	1.0	pF
Series Resistance (Figure 5) ($I_F = 10$ mAdc, $f = 100$ MHz)	R_S	—	—	0.7	Ω
Reverse Leakage Current ($V_R = 25$ Vdc)	I_R	—	—	0.1	μAdc

Preferred devices are Motorola recommended choices for future use and best overall value.

TYPICAL CHARACTERISTICS

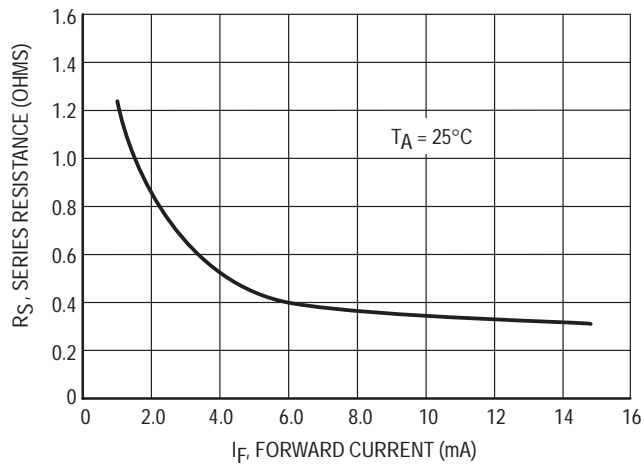


Figure 1. Series Resistance

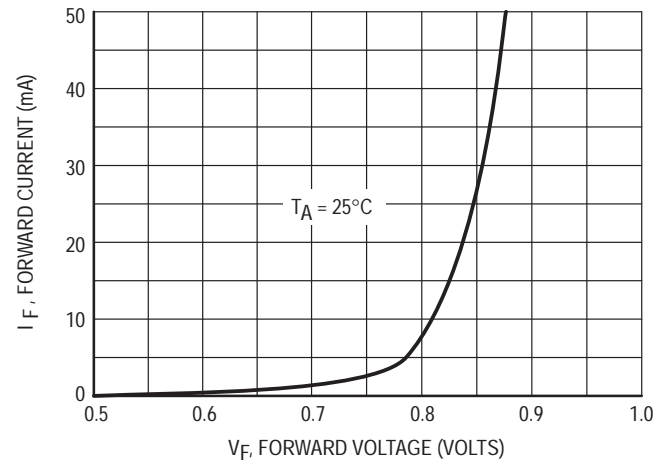


Figure 2. Forward Voltage

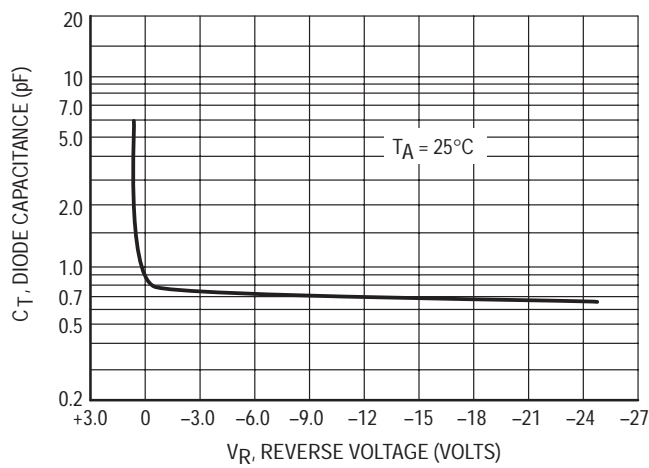


Figure 3. Diode Capacitance

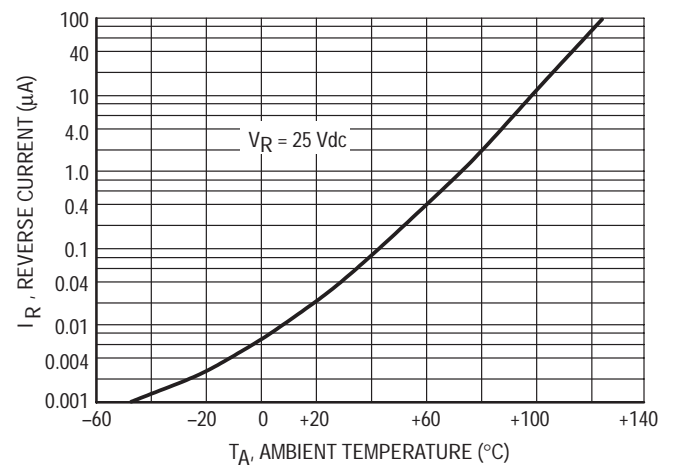
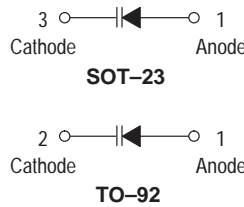


Figure 4. Leakage Current

High Voltage Silicon Pin Diodes

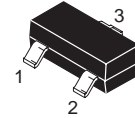
These devices are designed primarily for VHF band switching applications but are also suitable for use in general-purpose switching circuits. They are supplied in a cost-effective plastic package for economical, high-volume consumer and industrial requirements. They are also available in surface mount.

- Long Reverse Recovery Time
 $t_{rr} = 300 \text{ ns (Typ)}$
- Rugged PIN Structure Coupled with Wirebond Construction for Optimum Reliability
- Low Series Resistance @ 100 MHz —
 $R_S = 0.7 \text{ Ohms (Typ) @ } I_F = 10 \text{ mAdc}$
- Reverse Breakdown Voltage = 200 V (Min)



MMBV3700LT1
MPN3700

SILICON PIN
SWITCHING DIODES



CASE 318-08, STYLE 8
SOT-23 (TO-236AB)



CASE 182-02, STYLE 1
TO-92 (TO-226AC)

MAXIMUM RATINGS

Rating	Symbol	MPN3700	MMBV3700LT1	Unit
Reverse Voltage	V_R	200		Vdc
Total Power Dissipation @ $T_A = 25^\circ\text{C}$ Derate above 25°C	P_D	280 2.8	200 2.0	mW mW/ $^\circ\text{C}$
Junction Temperature	T_J	+125		$^\circ\text{C}$
Storage Temperature Range	T_{stg}	-55 to +150		$^\circ\text{C}$

DEVICE MARKING

MMBV3700LT1 = 4R

ELECTRICAL CHARACTERISTICS ($T_A = 25^\circ\text{C}$ unless otherwise noted)

Characteristic	Symbol	Min	Typ	Max	Unit
Reverse Breakdown Voltage ($I_R = 10 \mu\text{Adc}$)	$V_{(BR)R}$	200	—	—	Vdc
Diode Capacitance ($V_R = 20 \text{ Vdc}$, $f = 1.0 \text{ MHz}$)	C_T	—	—	1.0	pF
Series Resistance (Figure 5) ($I_F = 10 \text{ mAdc}$)	R_S	—	0.7	1.0	Ω
Reverse Leakage Current ($V_R = 150 \text{ Vdc}$)	I_R	—	—	0.1	μAdc
Reverse Recovery Time ($I_F = I_R = 10 \text{ mAdc}$)	t_{rr}	—	300	—	ns

TYPICAL CHARACTERISTICS

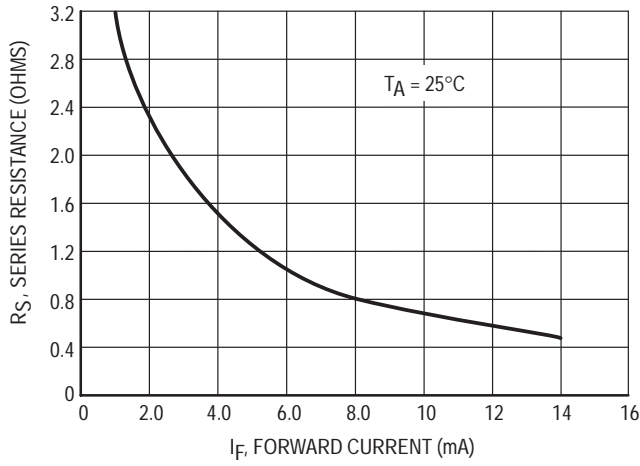


Figure 1. Series Resistance

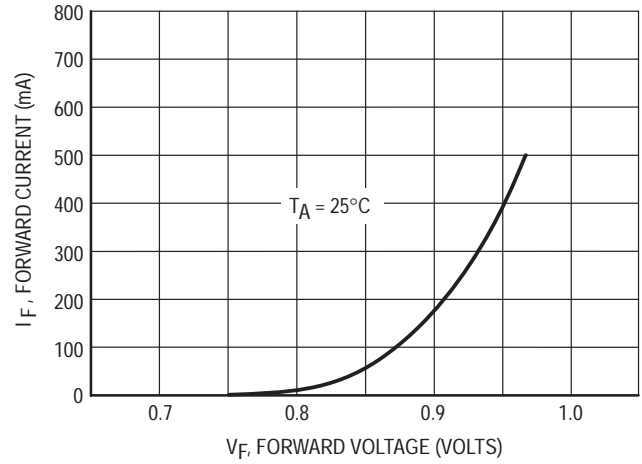


Figure 2. Forward Voltage

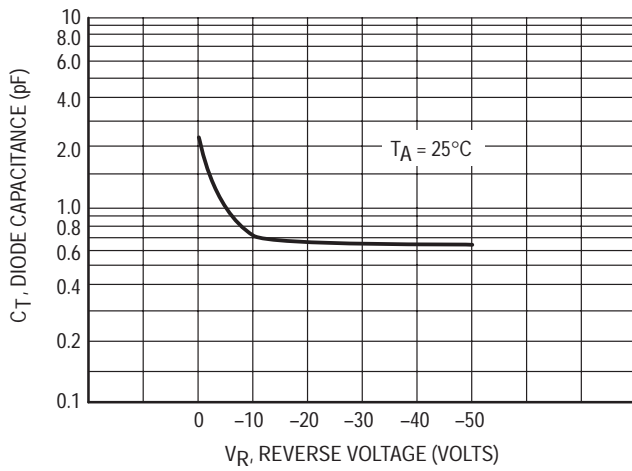


Figure 3. Diode Capacitance

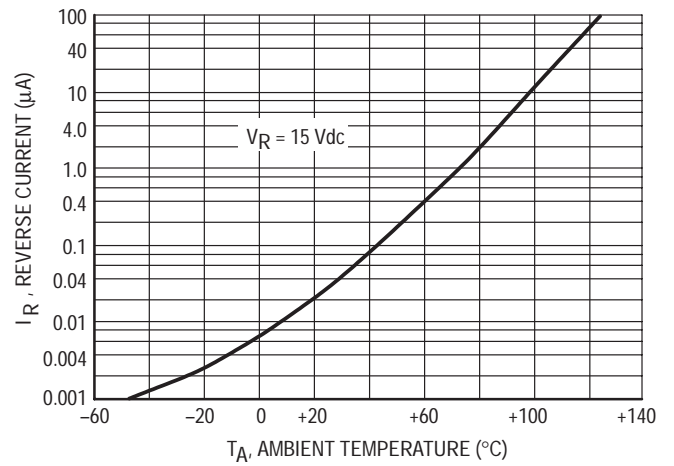


Figure 4. Leakage Current

SOD-123 Schottky Barrier Diodes

The MMSD301T1, and MMSD701T1 devices are spin-offs of our popular MMBD301LT1, and MMBD701LT1 SOT-23 devices. They are designed for high-efficiency UHF and VHF detector applications. Readily available to many other fast switching RF and digital applications.

- Extremely Low Minority Carrier Lifetime
- Very Low Capacitance
- Low Reverse Leakage



MMSD301T1
MMSD701T1

Motorola Preferred Devices



CASE 425-04, STYLE 1
SOD-123

MAXIMUM RATINGS

Rating	Symbol	Value	Unit	
Reverse Voltage	MMSD301T1 MMSD701T1	V_R	30 70	Vdc
Forward Power Dissipation $T_A = 25^\circ\text{C}$	P_F	225	mW	
Junction Temperature	T_J	-55 to +125	$^\circ\text{C}$	
Storage Temperature Range	T_{stg}	-55 to +150	$^\circ\text{C}$	

DEVICE MARKING

MMSD301T1 = XT, MMSD701T1 = XH

ELECTRICAL CHARACTERISTICS ($T_A = 25^\circ\text{C}$ unless otherwise noted)

Characteristic	Symbol	Min	Typ	Max	Unit
Reverse Breakdown Voltage ($I_R = 10 \mu\text{A}$)	$V_{(BR)R}$	30 70	— —	— —	Volts
Diode Capacitance ($V_R = 0$, $f = 1.0 \text{ MHz}$, Note 1)	C_T	— —	0.9 0.5	1.5 1.0	pF
Total Capacitance ($V_R = 15 \text{ Volts}$, $f = 1.0 \text{ MHz}$) ($V_R = 20 \text{ Volts}$, $f = 1.0 \text{ MHz}$)	C_T	— —	0.9 0.5	1.5 1.0	pF
Reverse Leakage ($V_R = 25 \text{ V}$) ($V_R = 35 \text{ V}$)	I_R	— —	13 9.0	200 200	nAdc nAdc
Forward Voltage ($I_F = 1.0 \text{ mAdc}$) ($I_F = 10 \text{ mA}$) ($I_F = 1.0 \text{ mAdc}$) ($I_F = 10 \text{ mA}$)	V_F	— — — —	0.38 0.52 0.42 0.7	0.45 0.6 0.5 1.0	Vdc

Preferred devices are Motorola recommended choices for future use and best overall value.

(Replaces MMSD101T1/D)

TYPICAL CHARACTERISTICS
MMSD301T1

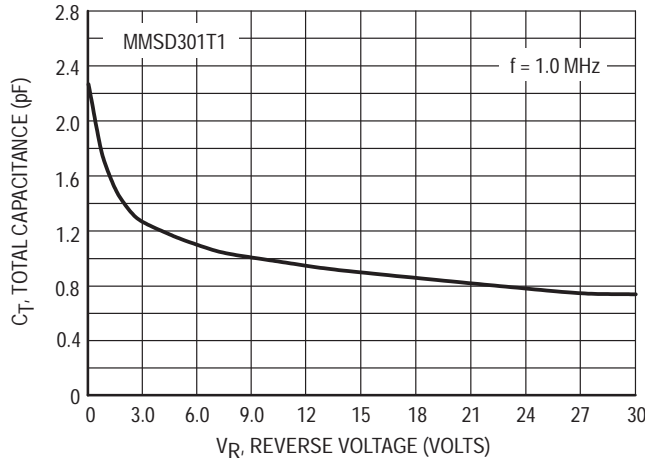


Figure 1. Total Capacitance

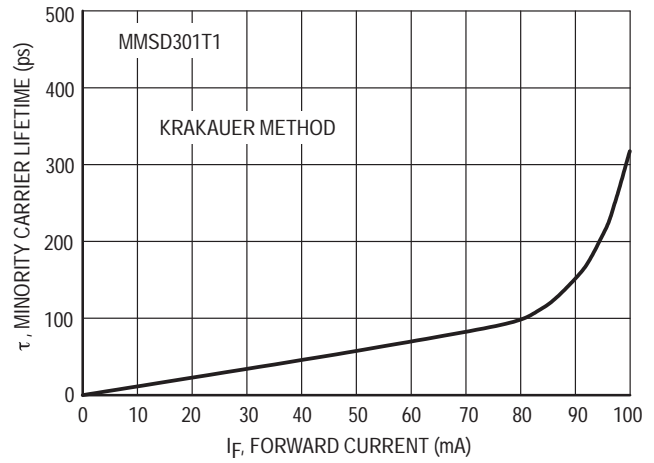


Figure 2. Minority Carrier Lifetime

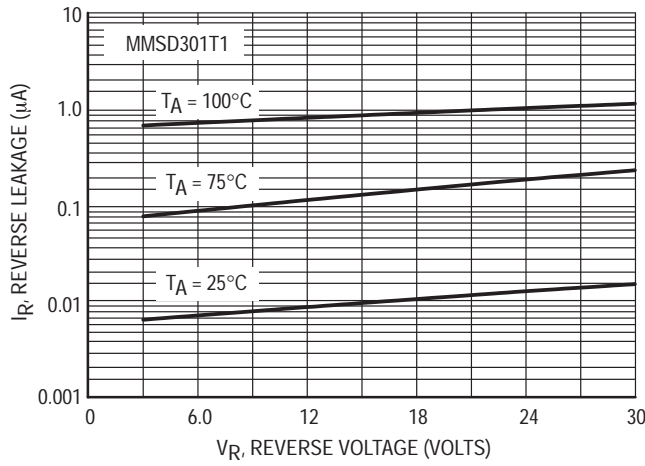


Figure 3. Reverse Leakage

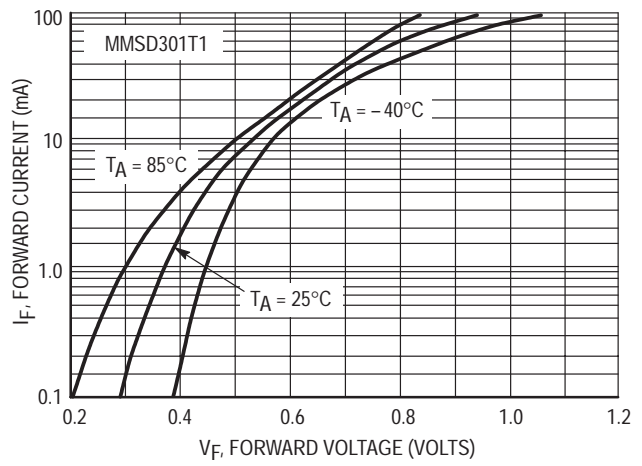


Figure 4. Forward Voltage

TYPICAL CHARACTERISTICS
MMSD701T1

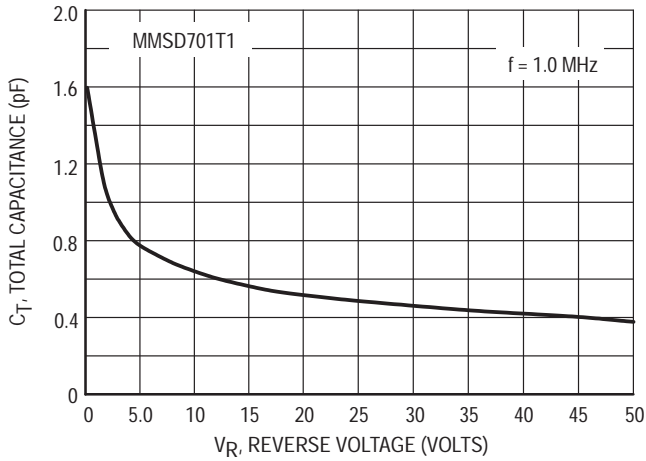


Figure 5. Total Capacitance

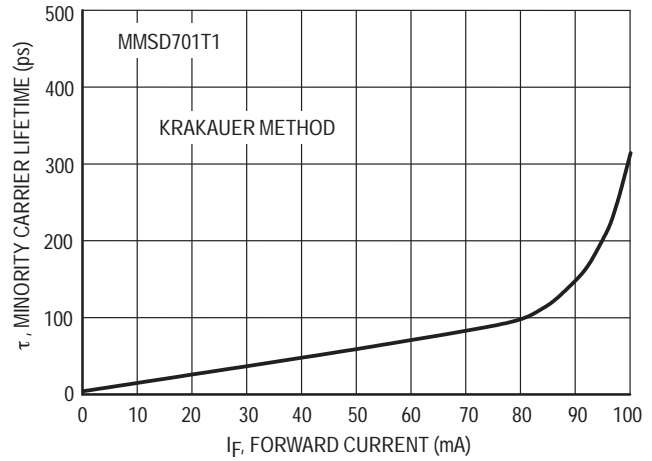


Figure 6. Minority Carrier Lifetime

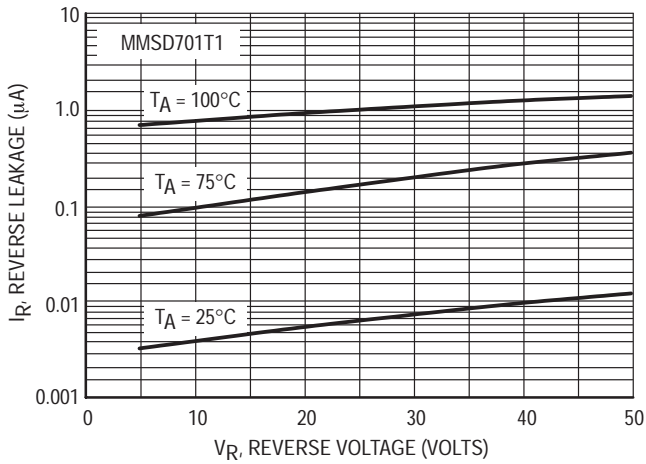


Figure 7. Reverse Leakage

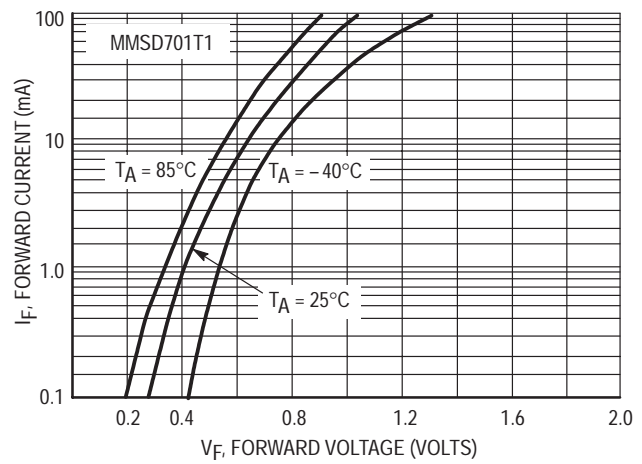
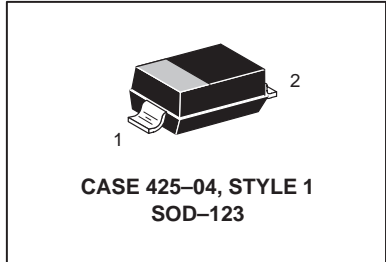


Figure 8. Forward Voltage

Switching Diode

The switching diode has the following features:

- SOD-123 Surface Mount Package
- High Breakdown Voltage
- Fast Speed Switching Time



MAXIMUM RATINGS

Rating	Symbol	Value	Unit
Continuous Reverse Voltage	V_R	100	Vdc
Peak Forward Current	I_F	200	mAdc
Peak Forward Surge Current	$I_{FM}(\text{surge})$	500	mAdc

DEVICE MARKING

MMSD914T1 = 5D

THERMAL CHARACTERISTICS

Characteristic	Symbol	Max	Unit
Total Device Dissipation FR-5 Board ⁽¹⁾ $T_A = 25^\circ\text{C}$ Derate above 25°C	P_D	225 1.8	mW mW/ $^\circ\text{C}$
Thermal Resistance Junction to Ambient	$R_{\theta JA}$	556	$^\circ\text{C}/\text{W}$
Total Device Dissipation Alumina Substrate ⁽²⁾ $T_A = 25^\circ\text{C}$ Derate above 25°C	P_D	300 2.4	mW mW/ $^\circ\text{C}$
Thermal Resistance Junction to Ambient	$R_{\theta JA}$	417	$^\circ\text{C}/\text{W}$
Junction and Storage Temperature	T_J, T_{stg}	-55 to +150	$^\circ\text{C}$

ELECTRICAL CHARACTERISTICS ($T_A = 25^\circ\text{C}$ unless otherwise noted)

Characteristic	Symbol	Min	Max	Unit
----------------	--------	-----	-----	------

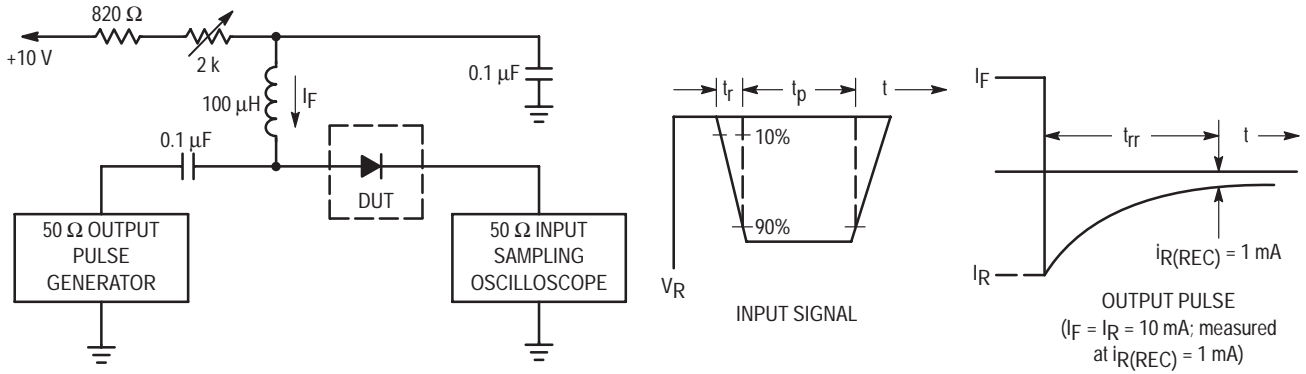
OFF CHARACTERISTICS

Reverse Breakdown Voltage ($I_{BR} = 100 \mu\text{Adc}$)	$V_{(BR)}$	100	—	Vdc
Reverse Voltage Leakage Current ($V_R = 20 \text{ Vdc}$) ($V_R = 75 \text{ Vdc}$)	I_R	— —	25 5.0	nAdc μAdc
Forward Voltage ($I_F = 10 \text{ mAdc}$)	V_F	—	1000	mVdc
Diode Capacitance ($V_R = 0 \text{ Vdc}$, $f = 1.0 \text{ MHz}$)	C_D	—	4.0	pF
Reverse Recovery Time ($I_F = I_R = 10 \text{ mAdc}$) (Figure 1)	t_{rr}	—	4.0	ns

1. FR-5 = 1.0 x 0.75 x 0.062 in.
2. Alumina = 0.4 x 0.3 x 0.024 in. 99.5% alumina

Preferred devices are Motorola recommended choices for future use and best overall value.

MMSD914T1



- Notes: 1. A 2.0 kΩ variable resistor adjusted for a Forward Current (I_F) of 10 mA.
 2. Input pulse is adjusted so $I_{R(\text{peak})}$ is equal to 10 mA.
 3. $t_p \gg t_{rr}$

Figure 1. Recovery Time Equivalent Test Circuit

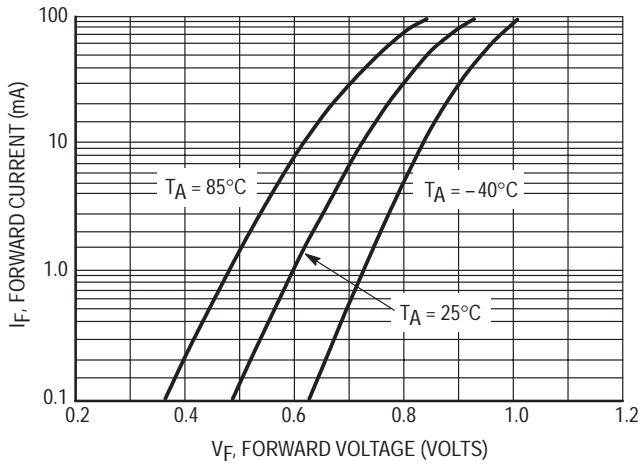


Figure 2. Forward Voltage

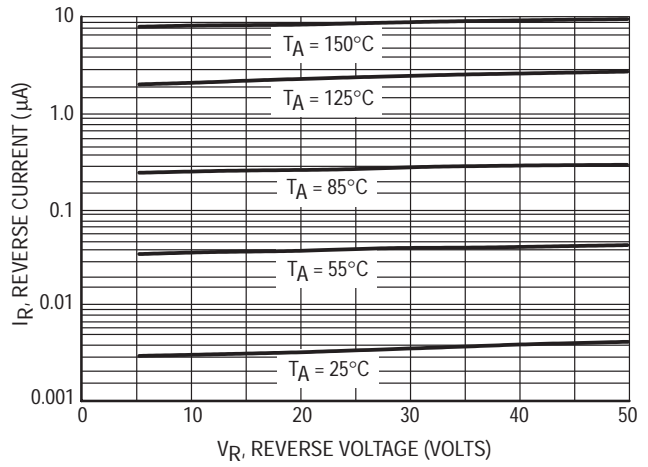


Figure 3. Leakage Current

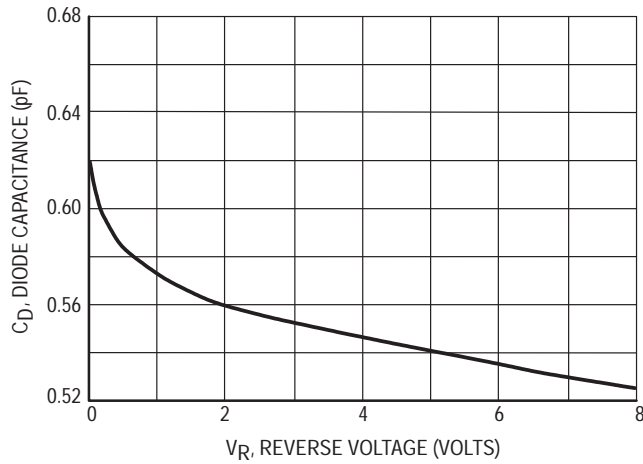


Figure 4. Capacitance

Silicon Pin Diode

This device is designed primarily for VHF band switching applications but is also suitable for use in general-purpose switching circuits. It is supplied in a cost-effective TO-92 type plastic package for economical, high-volume consumer and industrial requirements.

- Rugged PIN Structure Coupled with Wirebond Construction for Optimum Reliability
- Low Series Resistance @ 100 MHz —
 $R_S = 0.7 \text{ Ohms (Typ) @ } I_F = 10 \text{ mAdc}$
- Sturdy TO-92 Style Package for Handling Ease



MPN3404

**SILICON PIN
SWITCHING DIODE**



**CASE 182-02, STYLE 1
TO-92 (TO-226AC)**

MAXIMUM RATINGS

Rating	Symbol	Value	Unit
Reverse Voltage	V_R	20	Vdc
Forward Power Dissipation @ $T_A = 25^\circ\text{C}$ Derate above 25°C	P_D	400 4.0	mW mW/ $^\circ\text{C}$
Junction Temperature	T_J	+125	$^\circ\text{C}$
Storage Temperature Range	T_{stg}	-55 to +150	$^\circ\text{C}$

ELECTRICAL CHARACTERISTICS ($T_A = 25^\circ\text{C}$ unless otherwise noted)

Characteristic	Symbol	Min	Typ	Max	Unit
Reverse Breakdown Voltage ($I_R = 10 \mu\text{Adc}$)	$V_{(BR)R}$	20	—	—	Vdc
Diode Capacitance ($V_R = 15 \text{ Vdc}$, $f = 1.0 \text{ MHz}$)	C_T	—	1.3	2.0	pF
Series Resistance (Figure 5) ($I_F = 10 \text{ mAdc}$)	R_S	—	0.7	0.85	Ω
Reverse Leakage Current ($V_R = 15 \text{ Vdc}$)	I_R	—	—	0.1	μAdc

TYPICAL CHARACTERISTICS

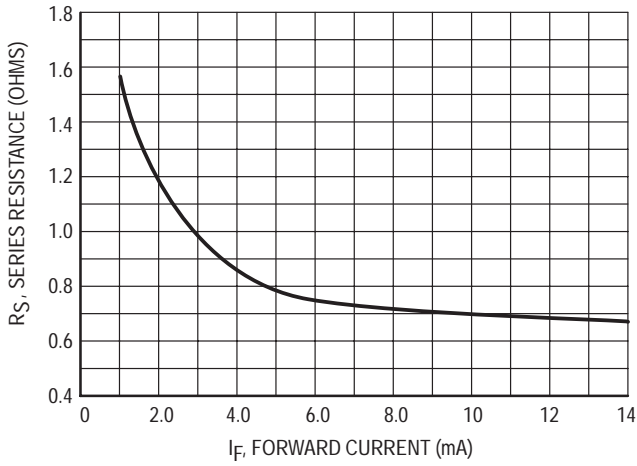


Figure 1. Series Resistance

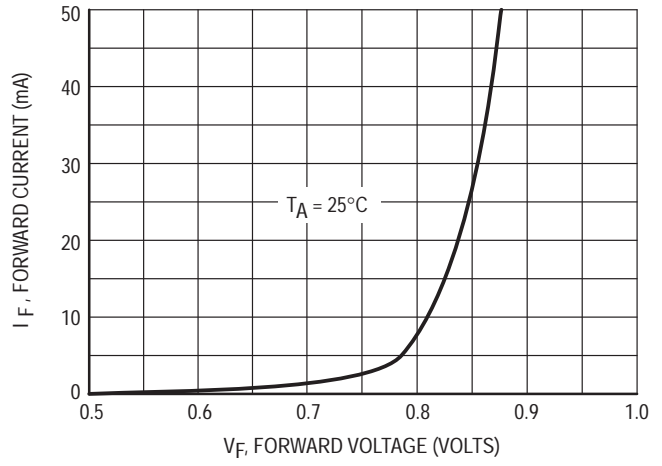


Figure 2. Forward Voltage

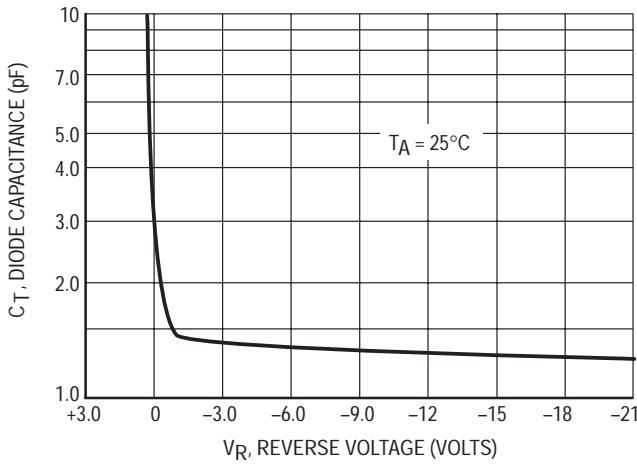


Figure 3. Diode Capacitance

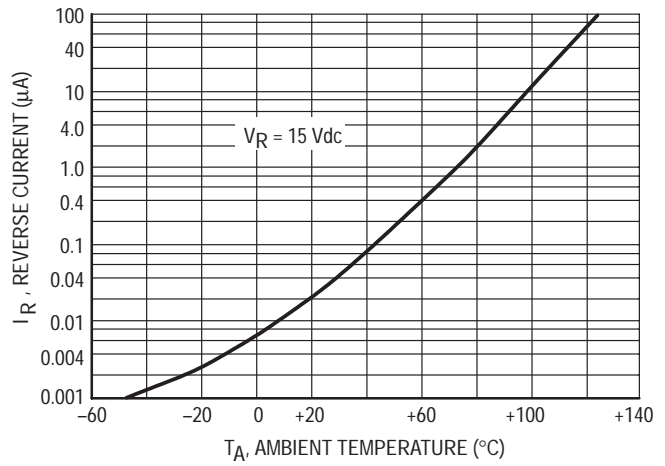
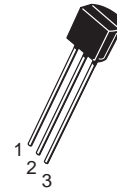
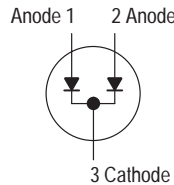


Figure 4. Leakage Current

Dual Switching Diode Common Cathode

MSD6100



CASE 29-04, STYLE 3
TO-92 (TO-226AA)

MAXIMUM RATINGS (EACH DIODE)

Rating	Symbol	Value	Unit
Reverse Voltage	V_R	100	Vdc
Recurrent Peak Forward Current	I_F	200	mAdc
Peak Forward Surge Current (Pulse Width = 10 μ sec)	$I_{FM}(\text{surge})$	500	mAdc
Power Dissipation @ $T_A = 25^\circ\text{C}$ Derate above 25°C	$P_D^{(1)}$	625 5.0	mW mW/ $^\circ\text{C}$
Operating and Storage Junction Temperature Range	$T_J, T_{stg}^{(1)}$	-55 to +135	$^\circ\text{C}$

ELECTRICAL CHARACTERISTICS ($T_A = 25^\circ\text{C}$ unless otherwise noted) (EACH DIODE)

Characteristic	Symbol	Min	Max	Unit
Breakdown Voltage ($I_{(BR)} = 100 \mu\text{Adc}$)	$V_{(BR)}$	100	—	Vdc
Reverse Current ($V_R = 100 \text{Vdc}$) ($V_R = 50 \text{Vdc}$) ($V_R = 50 \text{Vdc}, T_A = 125^\circ\text{C}$)	I_R	—	5.0 0.1 50	μAdc
Forward Voltage ($I_F = 1.0 \text{mAdc}$) ($I_F = 10 \text{mAdc}$) ($I_F = 100 \text{mAdc}$)	V_F	0.55 0.67 0.75	0.7 0.82 1.1	Vdc
Capacitance ($V_R = 0$)	C	—	1.5	pF
Reverse Recovery Time ($I_F = I_R = 10 \text{mAdc}, V_R = 5.0 \text{Vdc}, i_{rr} = 1.0 \text{mAdc}$)	t_{rr}	—	4.0	ns

1. Continuous package improvements have enhanced these guaranteed Maximum Ratings as follows: $P_D = 1.0 \text{ W}$ @ $T_C = 25^\circ\text{C}$, Derate above 25°C — $8.0 \text{ mW}/^\circ\text{C}$, $T_J = -65$ to $+150^\circ\text{C}$, $\theta_{JC} = 125^\circ\text{C}/\text{W}$.

TYPICAL CHARACTERISTICS

Curves Applicable to Each Anode

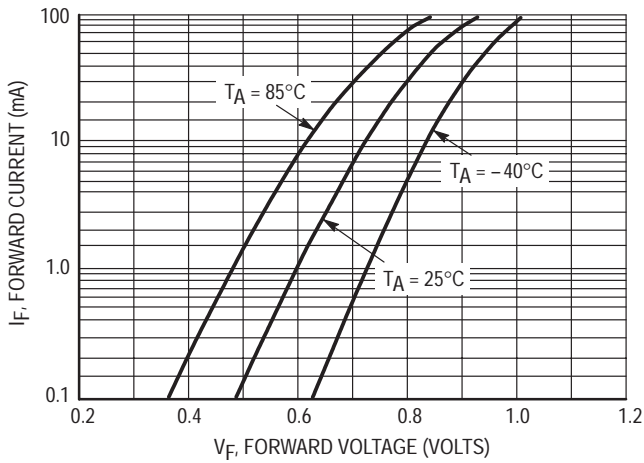


Figure 1. Forward Voltage

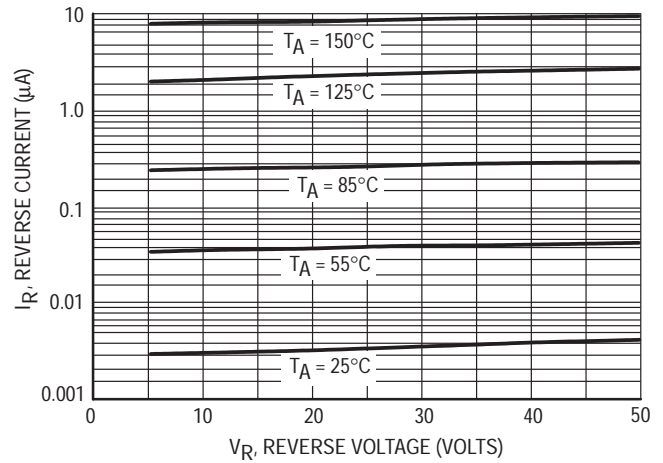


Figure 2. Leakage Current

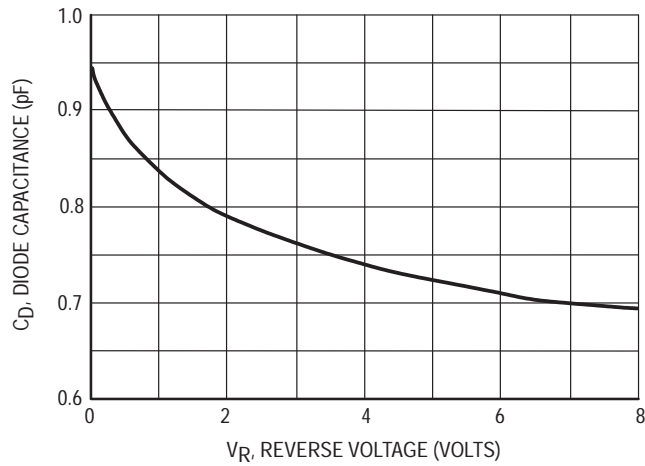
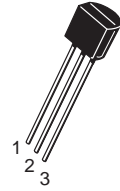
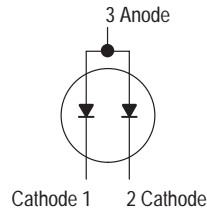


Figure 3. Capacitance

Dual Diode Common Anode

MSD6150



CASE 29-04, STYLE 4
TO-92 (TO-226AA)

MAXIMUM RATINGS (EACH DIODE)

Rating	Symbol	Value	Unit
Reverse Voltage	V_R	70	Vdc
Peak Forward Recurrent Current	I_F	200	mAdc
Peak Forward Surge Current (Pulse Width = 10 μ sec)	$I_{FM}(\text{surge})$	500	mAdc
Total Device Dissipation @ $T_A = 25^\circ\text{C}$ Derate above 25°C	$P_D^{(1)}$	625 5.0	mW mW/ $^\circ\text{C}$
Operating and Storage Junction Temperature Range	$T_J, T_{stg}^{(1)}$	-55 to +135	$^\circ\text{C}$

ELECTRICAL CHARACTERISTICS ($T_A = 25^\circ\text{C}$ unless otherwise noted) (EACH DIODE)

Characteristic	Symbol	Min	Typ	Max	Unit
Breakdown Voltage ($I_{(BR)} = 100 \mu\text{Adc}$)	$V_{(BR)}$	70	—	—	Vdc
Reverse Current ($V_R = 50 \text{Vdc}$)	I_R	—	—	0.1	μAdc
Forward Voltage ($I_F = 10 \text{mAdc}$)	V_F	—	0.80	1.0	Vdc
Capacitance ($V_R = 0$)	C	—	5.0	8.0	pF
Reverse Recovery Time ($I_F = I_R = 10 \text{mAdc}, V_R = 5.0 \text{Vdc}, i_{rr} = 1.0 \text{mAdc}$)	t_{rr}	—	—	100	ns

1. Continuous package improvements have enhanced these guaranteed Maximum Ratings as follows: $P_D = 1.0 \text{ W}$ @ $T_C = 25^\circ\text{C}$, Derate above $8.0 \text{ mW}/^\circ\text{C}$, $P_D = 10 \text{ W}$ @ $T_C = 25^\circ\text{C}$, Derate above $80 \text{ mW}/^\circ\text{C}$, $T_J, T_{stg} = -55$ to $+150^\circ\text{C}$, $\theta_{JC} = 12.5^\circ\text{C}/\text{W}$, $\theta_{JA} = 125^\circ\text{C}$.

TYPICAL CHARACTERISTICS

Curves Applicable to Each Cathode

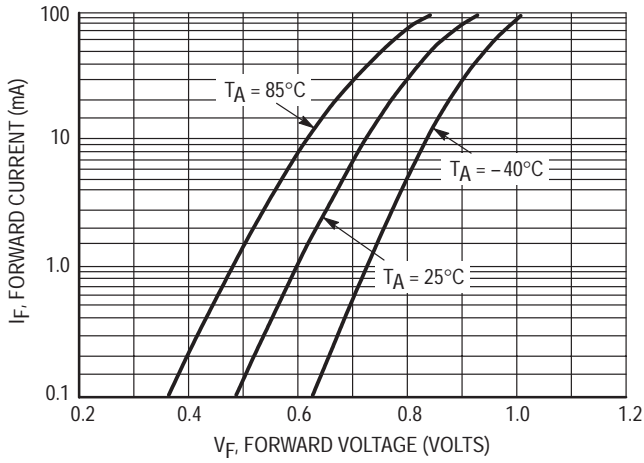


Figure 1. Forward Voltage

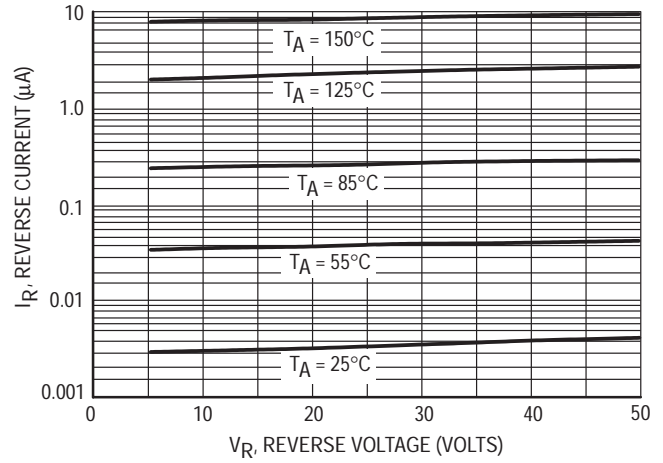


Figure 2. Leakage Current

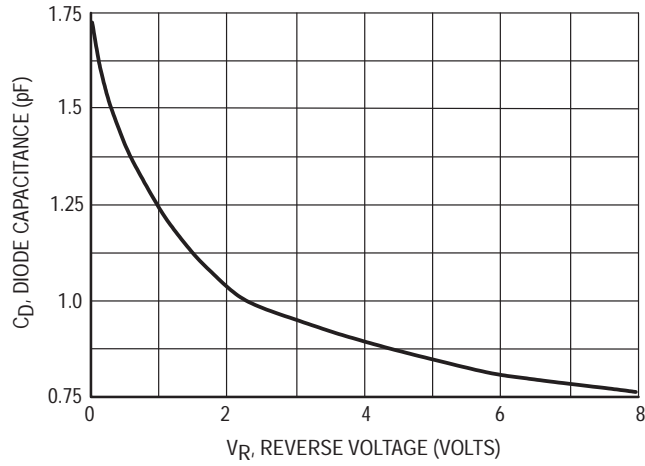
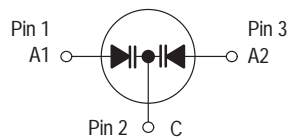


Figure 3. Capacitance

Silicon Tuning Diode

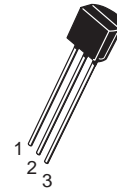
This device is designed for FM tuning, general frequency control and tuning, or any top-of-the-line application requiring back-to-back diode configurations for minimum signal distortion and detuning.

- High Figure of Merit — $Q = 140$ (Typ) @ $V_R = 3.0$ Vdc, $f = 100$ MHz
- Guaranteed Capacitance Range
37–42 pF @ $V_R = 3.0$ Vdc (MV104)
- Dual Diodes – Save Space and Reduce Cost
- Monolithic Chip Provides Near Perfect Matching – Guaranteed $\pm 1.0\%$ (Max) Over Specified Tuning Range



MV104

**DUAL
VOLTAGE VARIABLE
CAPACITANCE DIODE**



**CASE 29-04, STYLE 15
TO-92 (TO-226AA)**

MAXIMUM RATINGS (EACH DIODE)

Rating	Symbol	Value	Unit
Reverse Voltage	V_R	32	Vdc
Forward Current	I_F	200	mAdc
Total Power Dissipation @ $T_A = 25^\circ\text{C}$ Derate above 25°C	P_D	280 2.8	mW mW/ $^\circ\text{C}$
Junction Temperature	T_J	+125	$^\circ\text{C}$
Storage Temperature Range	T_{stg}	-55 to +150	$^\circ\text{C}$

ELECTRICAL CHARACTERISTICS ($T_A = 25^\circ\text{C}$ unless otherwise noted) (EACH DIODE)

Characteristic	Symbol	Min	Typ	Max	Unit
Reverse Breakdown Voltage ($I_R = 10 \mu\text{Adc}$)	$V_{(BR)R}$	32	—	—	Vdc
Reverse Voltage Leakage Current $T_A = 25^\circ\text{C}$ ($V_R = 30$ Vdc) $T_A = 60^\circ\text{C}$	I_R	— —	— —	50 500	nAdc
Diode Capacitance Temperature Coefficient ($V_R = 4.0$ Vdc, $f = 1.0$ MHz)	TC_C	—	280	—	ppm/ $^\circ\text{C}$

Device	C_T , Diode Capacitance $V_R = 3.0$ Vdc, $f = 1.0$ MHz pF		Q, Figure of Merit $V_R = 3.0$ Vdc $f = 100$ MHz		C_R , Capacitance Ratio C_3/C_{30} $f = 1.0$ MHz	
	Min	Max	Min	Typ	Min	Max
MV104	37	42	100	140	2.5	2.8

TYPICAL CHARACTERISTICS (Each Diode)

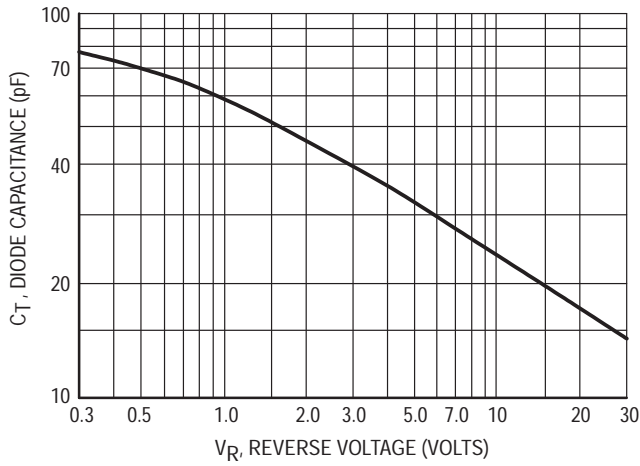


Figure 1. Diode Capacitance (Each Diode)

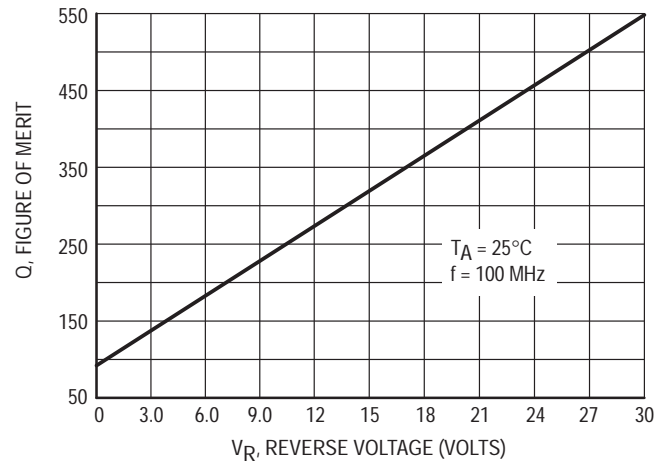


Figure 2. Figure of Merit versus Voltage

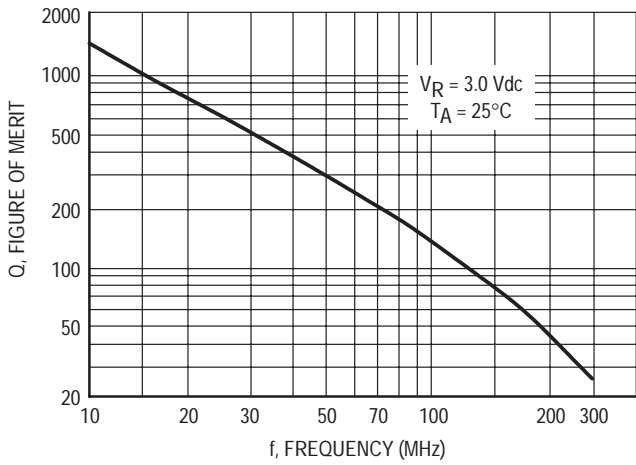


Figure 3. Figure of Merit versus Frequency

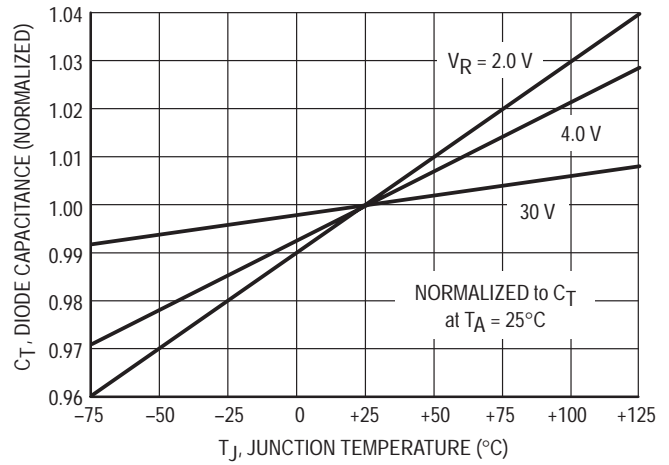


Figure 4. Diode Capacitance versus Temperature

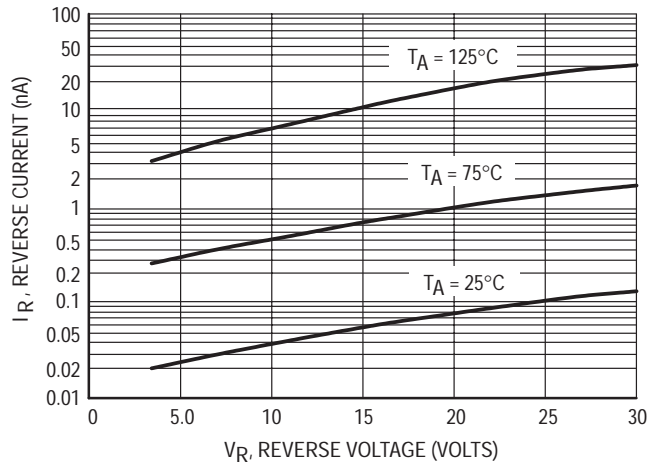


Figure 5. Reverse Current versus Reverse Voltage

Silicon Hyper-Abrupt Tuning Diodes

These devices are designed with high capacitance and a capacitance change of greater than TEN TIMES for a bias change from 2.0 to 10 volts. They provide tuning over broad frequency ranges; tune AM radio broadcast band, general AFC and tuning applications in lower RF frequencies.

- High Capacitance: 120–250 pF
- Large Capacitance Change with Small Bias Change
- Guaranteed High Q
- Available in Standard Axial Glass Packages

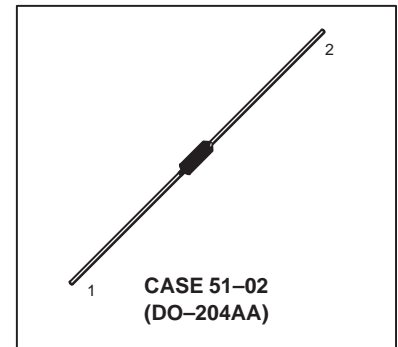
MV1403
MV1404
MV1405

120–250 pF
12 VOLTS
HIGH TUNING RATIO
VOLTAGE-VARIABLE
CAPACITANCE DIODES



MAXIMUM RATINGS

Rating	Symbol	Value	Unit
Reverse Voltage	V_R	12	Vdc
Forward Current	I_F	250	mAdc
Device Dissipation @ $T_A = 25^\circ\text{C}$ Derate above 25°C	P_D	400 2.67	mW mW/°C
Junction Temperature	T_J	+125	°C
Storage Temperature Range	T_{stg}	-65 to +200	°C



ELECTRICAL CHARACTERISTICS ($T_A = 25^\circ\text{C}$ unless otherwise noted)

Characteristic	Symbol	Min	Typ	Max	Unit
Reverse Breakdown Voltage ($I_R = 10 \mu\text{Adc}$)	$V_{(BR)R}$	12	—	—	Vdc
Reverse Voltage Leakage Current ($V_R = 10 \text{Vdc}$, $T_A = 25^\circ\text{C}$)	I_R	—	—	0.1	μAdc
Series Inductance ($f = 250 \text{MHz}$, Lead Length $\approx 1/16''$)	L_S	—	5.0	—	nH
Case Capacitance ($f = 1.0 \text{MHz}$, Lead Length $\approx 1/16''$)	C_C	—	0.25	—	pF

Device	C_T , Diode Capacitance			Q , Figure of Merit	TR, Tuning Ratio	
	$V_R = 2.0 \text{Vdc}$, $f = 1.0 \text{MHz}$ pF			$V_R = 2.0 \text{Vdc}$, $f = 1.0 \text{MHz}$	C_1/C_{10} $f = 1.0 \text{MHz}$	C_2/C_{10} $f = 1.0 \text{MHz}$
	Min	Nom	Max	Min	Min	Min
MV1403	140	175	210	200	—	10
MV1404	96	120	144	200	—	10
MV1405	200	250	300	200	—	10

TYPICAL CHARACTERISTICS

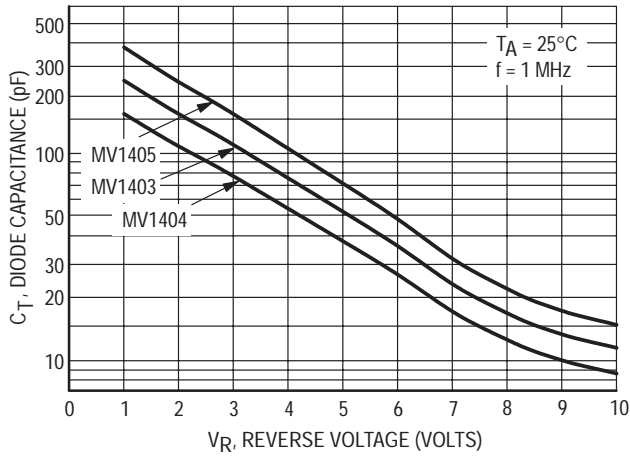


Figure 1. Diode Capacitance versus Reverse Voltage

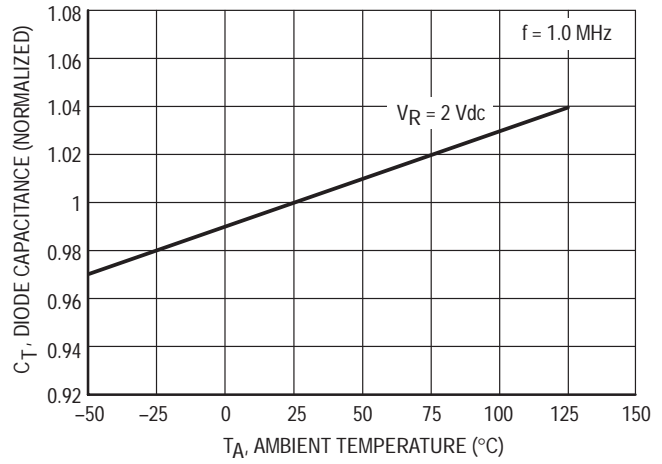


Figure 2. Diode Capacitance versus Ambient Temperature

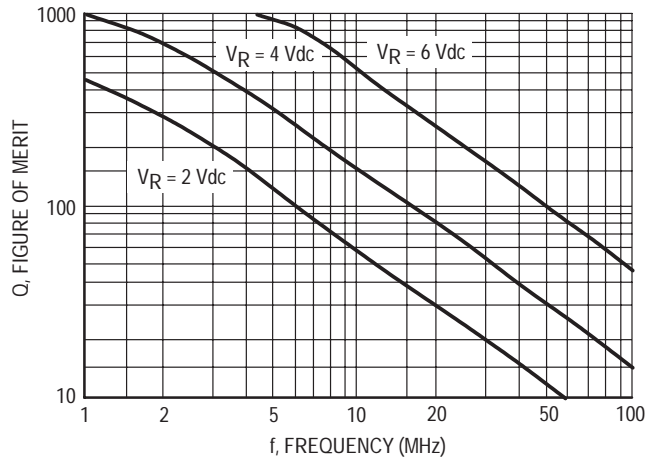


Figure 3. Figure of Merit versus Frequency

Silicon Tuning Diodes

These epitaxial passivated tuning diodes are designed for AFC applications in radio, TV, and general electronic-tuning.

- Maximum Working Voltage of 20 V
- Excellent Q Factor at High Frequencies
- Solid-State Reliability to Replace Mechanical Tuning Methods

**MV1626 thru
MV1650**

**6.8–100 pF
20 VOLTS
VOLTAGE-VARIABLE
CAPACITANCE DIODES**



MAXIMUM RATINGS

Rating	Symbol	Value	Unit
Reverse Voltage	V_R	20	Vdc
Forward Current	I_F	250	mAdc
Device Dissipation @ $T_A = 25^\circ\text{C}$ Derate above 25°C	P_D	400 2.67	mW mW/ $^\circ\text{C}$
Junction Temperature	T_J	+175	$^\circ\text{C}$
Storage Temperature Range	T_{stg}	-65 to +200	$^\circ\text{C}$

ELECTRICAL CHARACTERISTICS ($T_A = 25^\circ\text{C}$ unless otherwise noted)

Characteristic	Symbol	Min	Typ	Max	Unit
Reverse Breakdown Voltage ($I_R = 10 \mu\text{Adc}$)	$V_{(BR)R}$	20	—	—	Vdc
Reverse Voltage Leakage Current ($V_R = 15 \text{Vdc}$, $T_A = 25^\circ\text{C}$)	I_R	—	—	0.10	μAdc
Series Inductance ($f = 250 \text{MHz}$, Lead Length $\approx 1/16''$)	L_S	—	4.0	—	nH
Case Capacitance ($f = 1.0 \text{MHz}$, Lead Length $\approx 1/16''$)	C_C	—	0.17	—	pF

Device	C_T , Diode Capacitance $V_R = 4.0 \text{Vdc}$, $f = 1.0 \text{MHz}$ pF			Q , Figure of Merit $V_R = 4.0 \text{Vdc}$, $f = 50 \text{MHz}$	TR, Tuning Ratio C_2/C_{20} $f = 1.0 \text{MHz}$	
	Min	Nom	Max	Typ	Min	Max
MV1626	10.8	12.0	13.2	300	2.0	3.2
MV1628	13.5	15.0	16.5	250	2.0	3.2
MV1630	16.2	18.0	19.8	250	2.0	3.2
MV1634	19.8	22.0	24.2	250	2.0	3.2
MV1638	29.7	33.0	36.3	200	2.0	3.2
MV1648	73.8	82.0	90.2	150	2.0	3.2
MV1650	90.0	100.0	110.0	150	2.0	3.2

Silicon Tuning Diode

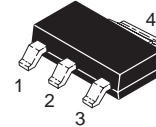
This silicon tuning diode is designed for use in high capacitance, high-tuning ratio applications. The device is housed in the SOT-223 package which is designed for medium power surface mount applications.

- Guaranteed Capacitance Range
- The SOT-223 Package can be soldered using wave or reflow.
- SOT-223 package ensures level mounting, resulting in improved thermal conduction, and allows visual inspection of soldered joints. The formed leads absorb thermal stress during soldering eliminating the possibility of damage to the die.

MV7005T1

Motorola Preferred Device

**SOT-223 PACKAGE
HIGH CAPACITANCE
VOLTAGE VARIABLE DIODE
SURFACE MOUNT**



**CASE 318E-04, STYLE 2
SOT-223 (TO-261AA)**



MAXIMUM RATINGS

Rating	Symbol	Value	Unit
Reverse Voltage	V_R	15	Vdc
Forward Current	I_F	50	mAdc
Total Power Dissipation @ $T_A = 25^\circ\text{C}^{(1)}$ Derate above 25°C	P_D	800 6.4	mW mW/ $^\circ\text{C}$
Junction Temperature	T_J	+125	$^\circ\text{C}$
Storage Temperature Range	T_{stg}	-55 to +125	$^\circ\text{C}$

1. FR-4 board, 0.0625 in², 2 oz. copper.

DEVICE MARKING

MV7005T1 = V7005

ELECTRICAL CHARACTERISTICS ($T_A = 25^\circ\text{C}$ unless otherwise noted)

Characteristic	Symbol	Min	Max	Unit
Reverse Breakdown Voltage ($I_R = 10 \mu\text{Adc}$)	$V_{(BR)R}$	15	—	Vdc
Reverse Voltage Leakage Current ($V_R = 9.0 \text{ Vdc}$)	I_R	—	100	nAdc
Diode Capacitance ($V_R = 1.0 \text{ Vdc}$, $f = 1.0 \text{ MHz}$)	C_T	400	520	pF
Capacitance Ratio C1/C9 ($f = 1.0 \text{ MHz}$)	C_R	12	—	—
Figure of Merit ($V_R = 1.0 \text{ Vdc}$, $f = 1.0 \text{ MHz}$)	Q	150	—	—

Preferred devices are Motorola recommended choices for future use and best overall value.

TYPICAL CHARACTERISTICS

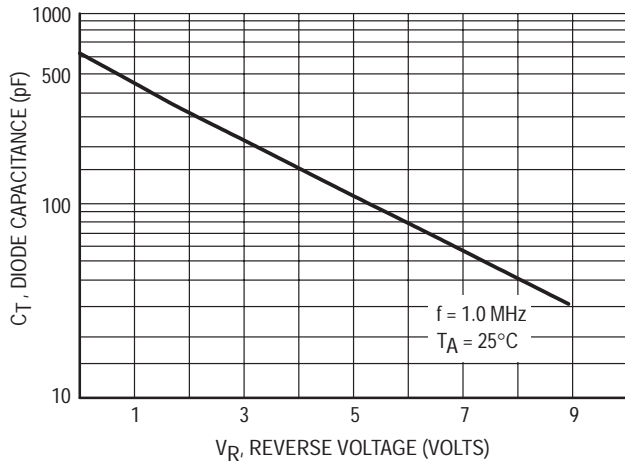


Figure 1. Diode Capacitance versus Reverse Voltage

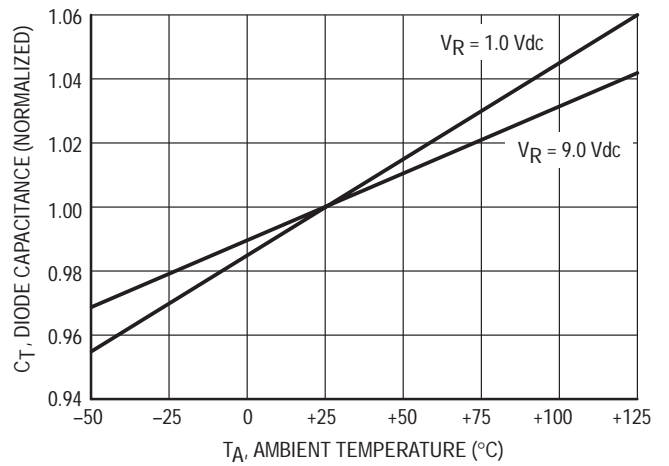


Figure 2. Diode Capacitance versus Ambient Temperature

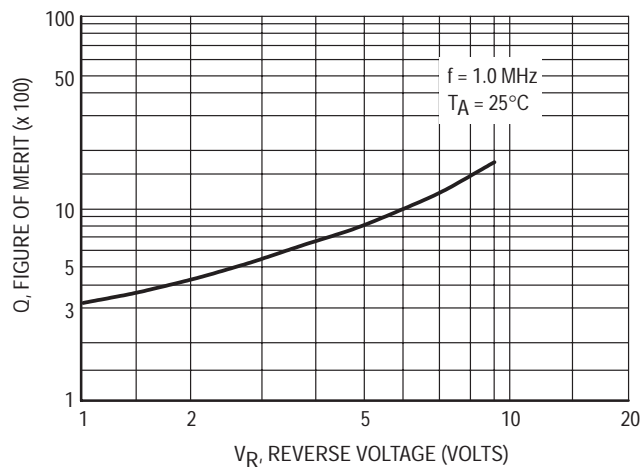


Figure 3. Figure of Merit

Silicon Hyper-Abrupt Tuning Diode

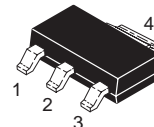
This silicon tuning diode is designed for high capacitance and a tuning ratio of greater than 10 times over a bias range of 2.0 to 10 volts. It provides tuning over a broad frequency range from the AM broadcast band to 100 MHz. The device is housed in the SOT-223 package which is designed for medium power surface mount applications.

- High Capacitance
- Large Capacitance Change with Small Bias Change
- Guaranteed High Q
- The SOT-223 Package can be soldered using wave or reflow.
- SOT-223 package ensures level mounting which results in improved thermal conduction and allows visual inspection of soldered joints. The formed leads absorb thermal stress during soldering, eliminating the possibility of damage to the die.

MV7404T1

Motorola Preferred Device

**SOT-223 PACKAGE
HIGH TUNING RATIO
VOLTAGE VARIABLE
SURFACE MOUNT
DIODE**



**CASE 318E-04, STYLE 2
SOT-223 (TO-261AA)**



MAXIMUM RATINGS (T_C = 25°C unless otherwise noted)

Rating	Symbol	Value	Unit
Reverse Voltage	V _R	12	Vdc
Forward Current	I _F	250	mAdc
Total Power Dissipation @ T _A = 25°C(1) Derate above 25°C	P _D	800 6.4	mW mW/°C
Operating and Storage Temperature Range	T _J , T _{stg}	-55 to +125	°C
Lead Temperature for Soldering Purposes, 1/6" from case Time in Solder Bath	T _L	260 10	°C Sec

1. FR-4 board, 0.0625 in², 2 oz. copper.

DEVICE MARKING

MV7404T1 = V7404

ELECTRICAL CHARACTERISTICS (T_A = 25°C unless otherwise noted)

Characteristic	Symbol	Min	Typ	Max	Unit
Reverse Breakdown Voltage (I _R = 10 μAdc)	V _{(BR)R}	12	—	—	Vdc
Reverse Voltage Leakage Current (V _R = 10 Vdc, f = 1.0 MHz)	I _R	—	—	100	nAdc
Diode Capacitance (V _R = 2.0 Vdc, f = 1.0 MHz)	C _T	96	120	144	pF
Figure of Merit (V _R = 2.0 Vdc, f = 1.0 MHz)	Q	200	—	—	—
Tuning Ratio C2/C10 (f = 1.0 MHz)	T _R	10	—	—	—

Preferred devices are Motorola recommended choices for future use and best overall value.

TYPICAL CHARACTERISTICS

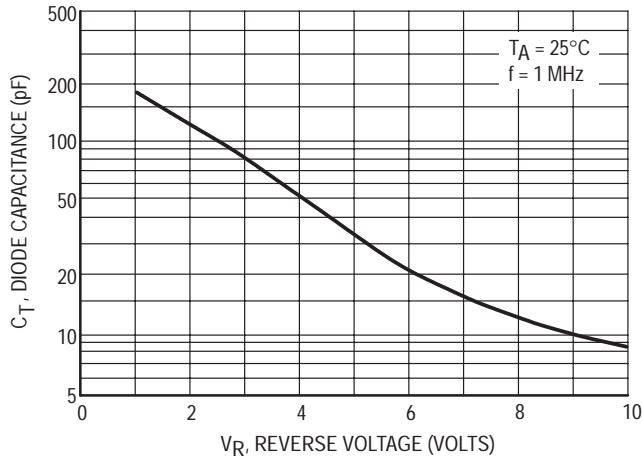


Figure 1. Diode Capacitance versus Reverse Voltage

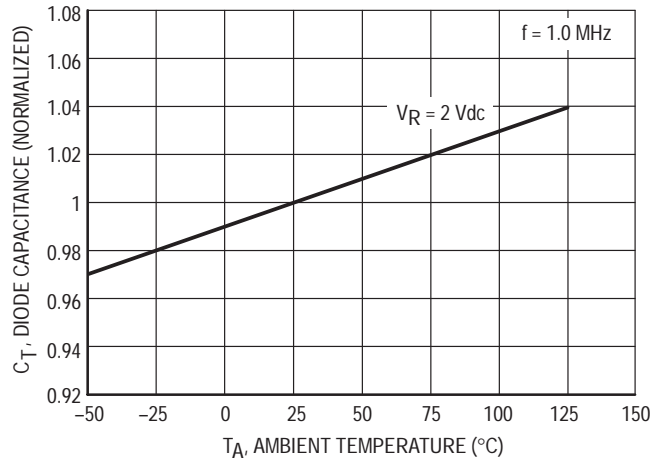


Figure 2. Diode Capacitance versus Ambient Temperature

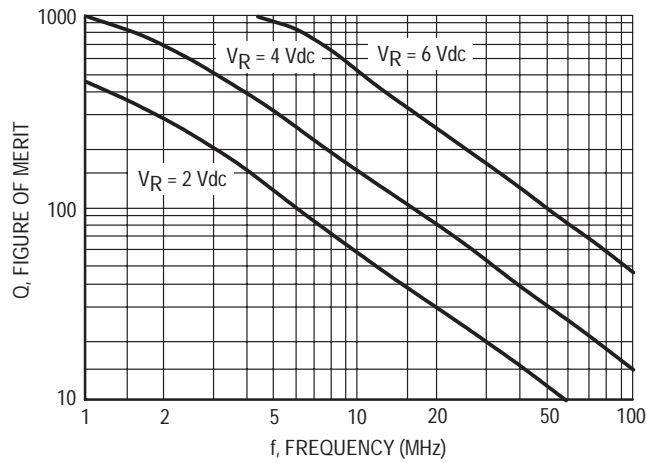


Figure 3. Figure of Merit versus Frequency

Section 6

Tape and Reel Specifications and Packaging Specifications

Tape and Reel Specifications and Packaging Specifications

Embossed Tape and Reel is used to facilitate automatic pick and place equipment feed requirements. The tape is used as the shipping container for various products and requires a minimum of handling. The antistatic/conductive tape provides a secure cavity for the product when sealed with the "peel-back" cover tape.

- Two Reel Sizes Available (7" and 13")
- Used for Automatic Pick and Place Feed Systems
- Minimizes Product Handling
- EIA 481, -1, -2
- SOD-123, SC-59, SC-70/SOT-323, SC-70ML/SOT-363, SOT-23, TSOP-6, in 8 mm Tape
- SOT-223 in 12 mm Tape
- SO-14, SO-16 in 16 mm Tape

Use the standard device title and add the required suffix as listed in the option table on the following page. Note that the individual reels have a finite number of devices depending on the type of product contained in the tape. Also note the minimum lot size is one full reel for each line item, and orders are required to be in increments of the single reel quantity.



EMBOSSED TAPE AND REEL ORDERING INFORMATION

Package	Tape Width (mm)	Pitch (mm (inch))	Reel Size (mm (inch))	Devices Per Reel and Minimum Order Quantity	Device Suffix
SC-59	8	4.0 ± 0.1 (.157 ± .004)	178 (7)	3,000	T1
SC-70/SOT-323	8	4.0 ± 0.1 (.157 ± .004)	178 (7)	3,000	T1
	8		330 (13)	10,000	T3
SO-14	16	8.0 ± 0.1 (.315 ± .004)	178 (7)	500	R1
	16		330 (13)	2,500	R2
SO-16	16	8.0 ± 0.1 (.315 ± .004)	178 (7)	500	R1
	16		330 (13)	2,500	R2
SOD-123	8	4.0 ± 0.1 (.157 ± .004)	178 (7)	3,000	T1
	8		330 (13)	10,000	T3
SOT-23	8	4.0 ± 0.1 (.157 ± .004)	178 (7)	3,000	T1
	8		330 (13)	10,000	T3
SOT-223	12	8.0 ± 0.1 (.315 ± .004)	178 (7)	1,000	T1
	12		330 (13)	4,000	T3
SC-70ML/SOT-363	8	4.0 ± 0.1 (.157 ± .004)	178 (7)	3,000	T1
	8		178 (7)	3,000	T2
TSOP-6	8	4.0 ± 0.1 (.157 ± .004)	178 (7)	3,000	T1

EMBOSSED TAPE AND REEL DATA FOR DISCRETES

CARRIER TAPE SPECIFICATIONS



For Machine Reference Only
Including Draft and RADII
Concentric Around B_0



DIMENSIONS

Tape Size	B_1 Max	D	D_1	E	F	K	P_0	P_2	R Min	T Max	W Max	
8 mm	4.55 mm (.179")	1.5 ± 0.1 mm -0.0	1.0 Min (.039")	1.75 ± 0.1 mm (.069 ± .004")	3.5 ± 0.05 mm (.138 ± .002")	2.4 mm Max (.094")	4.0 ± 0.1 mm (.157 ± .004")	2.0 ± 0.1 mm (.079 ± .002")	25 mm (.98")	0.6 mm (.024")	8.3 mm (.327")	
12 mm	8.2 mm (.323")	(0.059 ± .004" -0.0)	1.5 mm Min (.060")		5.5 ± 0.05 mm (.217 ± .002")	6.4 mm Max (.252")				30 mm (1.18")	12 ± .30 mm (.470 ± .012")	
16 mm	12.1 mm (.476")				7.5 ± 0.10 mm (.295 ± .004")	7.9 mm Max (.311")						16.3 mm (.642")
24 mm	20.1 mm (.791")				11.5 ± 0.1 mm (.453 ± .004")	11.9 mm Max (.468")						

Metric dimensions govern — English are in parentheses for reference only.

NOTE 1: A_0 , B_0 , and K_0 are determined by component size. The clearance between the components and the cavity must be within .05 mm min. to .50 mm max., the component cannot rotate more than 10° within the determined cavity.

NOTE 2: If B_1 exceeds 4.2 mm (.165) for 8 mm embossed tape, the tape may not feed through all tape feeders.

NOTE 3: Pitch information is contained in the Embossed Tape and Reel Ordering Information on pg. 5.12-3.

EMBOSSED TAPE AND REEL DATA FOR DISCRETES



Size	A Max	G	T Max
8 mm	330 mm (12.992")	8.4 mm + 1.5 mm, -0.0 (.33" + .059", -0.00)	14.4 mm (.56")
12 mm	330 mm (12.992")	12.4 mm + 2.0 mm, -0.0 (.49" + .079", -0.00)	18.4 mm (.72")
16 mm	360 mm (14.173")	16.4 mm + 2.0 mm, -0.0 (.646" + .078", -0.00)	22.4 mm (.882")
24 mm	360 mm (14.173")	24.4 mm + 2.0 mm, -0.0 (.961" + .070", -0.00)	30.4 mm (1.197")

Reel Dimensions

Metric Dimensions Govern — English are in parentheses for reference only

TO-92 EIA, IEC, EIAJ

Radial Tape in Fan Fold Box or On Reel

Radial tape in fan fold box or on reel of the reliable TO-92 package are the best methods of capturing devices for automatic insertion in printed circuit boards. These methods of taping are compatible with various equipment for active and passive component insertion.

- Available in Fan Fold Box
- Available on 365 mm Reels
- Accommodates All Standard Inserters
- Allows Flexible Circuit Board Layout
- 2.5 mm Pin Spacing for Soldering
- EIA-468, IEC 286-2, EIAJ RC1008B

Ordering Notes:

When ordering radial tape in fan fold box or on reel, specify the style per Figures 3 through 8. Add the suffix "RLR" and "Style" to the device title, i.e. MPS3904RLRA. This will be a standard MPS3904 radial taped and supplied on a reel per Figure 9.

Fan Fold Box Information — Order in increments of 2000.

Reel Information — Order in increments of 2000.



US/European Suffix Conversions

US	EUROPE
RLRA	RL
RLRE	RL1
RLRM	ZL1

TO-92 EIA RADIAL TAPE IN FAN FOLD BOX OR ON REEL



Figure 1. Device Positioning on Tape

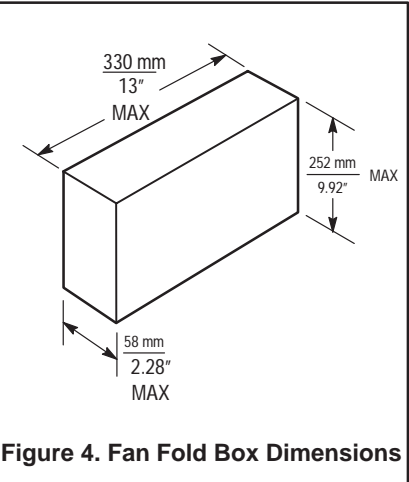
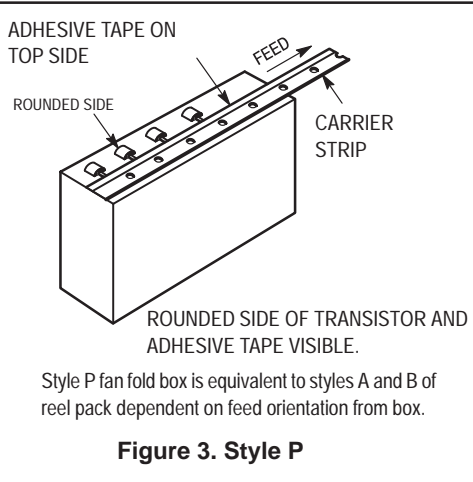
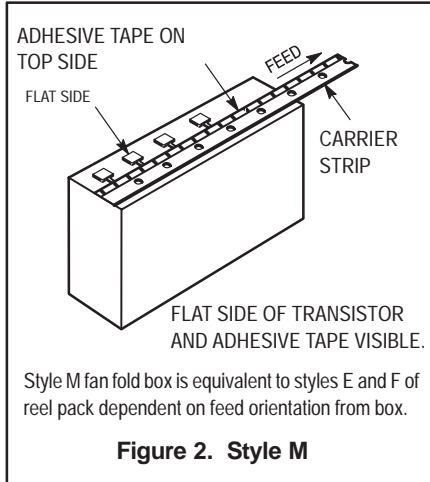
Symbol	Item	Specification			
		Inches		Millimeter	
		Min	Max	Min	Max
D	Tape Feedhole Diameter	0.1496	0.1653	3.8	4.2
D2	Component Lead Thickness Dimension	0.015	0.020	0.38	0.51
F1, F2	Component Lead Pitch	0.0945	0.110	2.4	2.8
H	Bottom of Component to Seating Plane	.059	.156	1.5	4.0
H1	Feedhole Location	0.3346	0.3741	8.5	9.5
H2A	Deflection Left or Right	0	0.039	0	1.0
H2B	Deflection Front or Rear	0	0.051	0	1.0
H4	Feedhole to Bottom of Component	0.7086	0.768	18	19.5
H5	Feedhole to Seating Plane	0.610	0.649	15.5	16.5
L	Defective Unit Clipped Dimension	0.3346	0.433	8.5	11
L1	Lead Wire Enclosure	0.09842	—	2.5	—
P	Feedhole Pitch	0.4921	0.5079	12.5	12.9
P1	Feedhole Center to Center Lead	0.2342	0.2658	5.95	6.75
P2	First Lead Spacing Dimension	0.1397	0.1556	3.55	3.95
T	Adhesive Tape Thickness	0.06	0.08	0.15	0.20
T1	Overall Taped Package Thickness	—	0.0567	—	1.44
T2	Carrier Strip Thickness	0.014	0.027	0.35	0.65
W	Carrier Strip Width	0.6889	0.7481	17.5	19
W1	Adhesive Tape Width	0.2165	0.2841	5.5	6.3
W2	Adhesive Tape Position	.0059	0.01968	.15	0.5

NOTES:

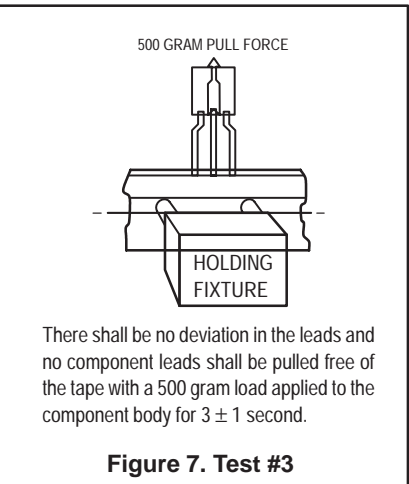
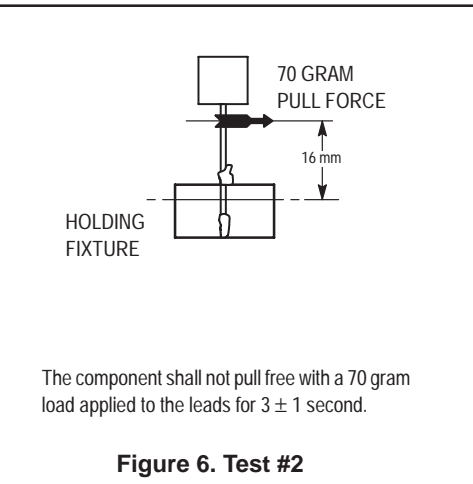
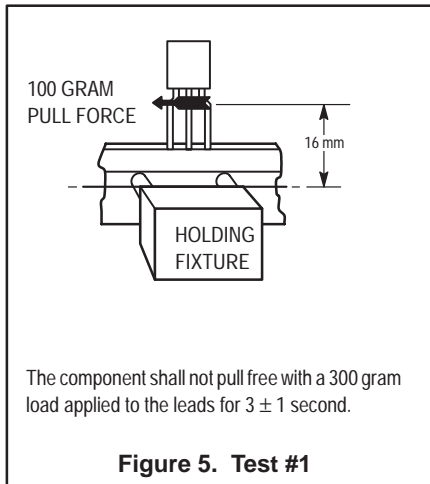
1. Maximum alignment deviation between leads not to be greater than 0.2 mm.
2. Defective components shall be clipped from the carrier tape such that the remaining protrusion (L) does not exceed a maximum of 11 mm.
3. Component lead to tape adhesion must meet the pull test requirements established in Figures 5, 6 and 7.
4. Maximum non-cumulative variation between tape feed holes shall not exceed 1 mm in 20 pitches.
5. Holddown tape not to extend beyond the edge(s) of carrier tape and there shall be no exposure of adhesive.
6. No more than 1 consecutive missing component is permitted.
7. A tape trailer and leader, having at least three feed holes is required before the first and after the last component.
8. Splices will not interfere with the sprocket feed holes.

TO-92 EIA RADIAL TAPE IN FAN FOLD BOX OR ON REEL

FAN FOLD BOX STYLES

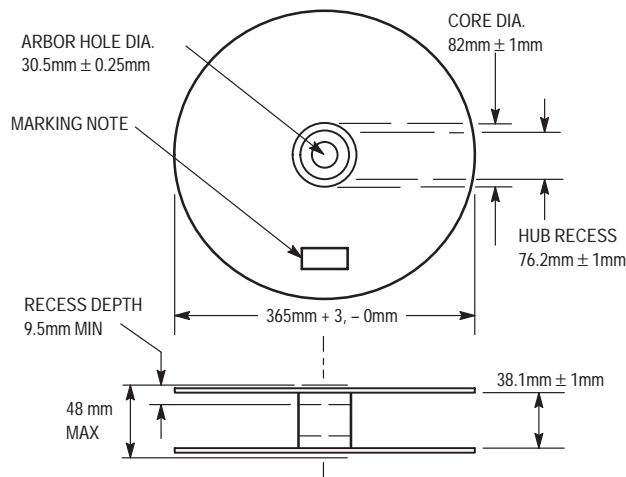


ADHESION PULL TESTS



TO-92 EIA RADIAL TAPE IN FAN FOLD BOX OR ON REEL

REEL STYLES



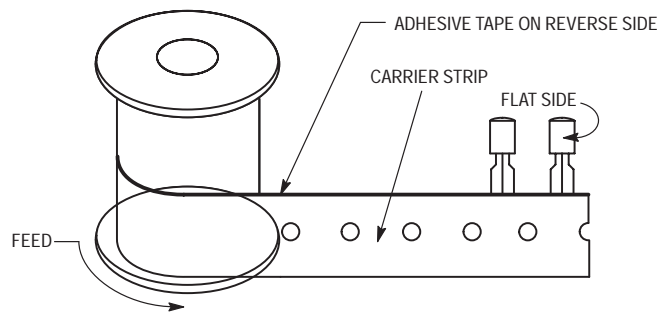
Material used must not cause deterioration of components or degrade lead solderability

Figure 8. Reel Specifications



Rounded side of transistor and adhesive tape visible.

Figure 9. Style A



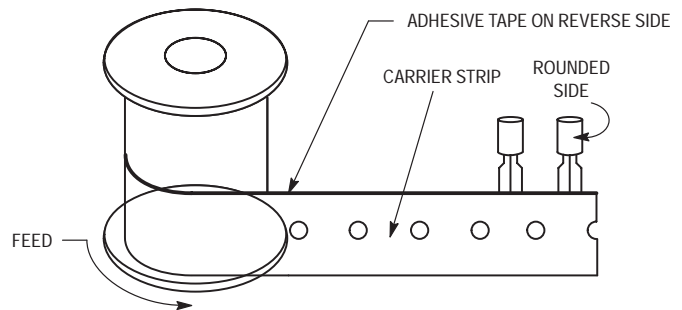
Flat side of transistor and carrier strip visible (adhesive tape on reverse side).

Figure 10. Style B



Flat side of transistor and adhesive tape visible.

Figure 11. Style E



Rounded side of transistor and carrier strip visible (adhesive tape on reverse side).

Figure 12. Style F

Section 7

Surface Mount Information

In Brief . . .

Surface Mount Technology is now being utilized to offer answers to many problems that have been created in the use of insertion technology.

Limitations have been reached with insertion packages and PC board technology. Surface Mount Technology offers the opportunity to continue to advance the state-of-the-art designs that cannot be accomplished with insertion technology.

Surface Mount Packages allow more optimum device performance with the smaller Surface Mount Configuration. Internal lead lengths, parasitic capacitance and inductance that placed limitations on chip performance have been reduced.

The lower profile of Surface Mount Packages allows more boards to be utilized in a given amount of space. They are stacked closer together and utilize less total volume than insertion populated PC boards.

Printed circuit costs are lowered with the reduction of the number of board layers required. The elimination or reduction of the number of plated through holes in the board contribute significantly to lower PC board prices.

Surface Mount assembly does not require the preparation of components that is common on insertion technology lines. Surface Mount components are sent directly to the assembly line, eliminating an intermediate step.

Automatic placement equipment is available that can place Surface Mount components at the rate of a few thousand per hour to hundreds of thousands of components per hour.

Surface Mount Technology is cost effective, allowing the manufacturer the opportunity to produce smaller units and offer increased functions with the same size product.

INFORMATION FOR USING SURFACE MOUNT PACKAGES

RECOMMENDED FOOTPRINTS FOR SURFACE MOUNTED APPLICATIONS

Surface mount board layout is a critical portion of the total design. The footprint for the semiconductor packages must be the correct size to ensure proper solder connection inter-

face between the board and the package. With the correct pad geometry, the packages will self align when subjected to a solder reflow process.

POWER DISSIPATION FOR A SURFACE MOUNT DEVICE

The power dissipation for a surface mount device is a function of the drain/collector pad size. These can vary from the minimum pad size for soldering to a pad size given for maximum power dissipation. Power dissipation for a surface mount device is determined by $T_{J(max)}$, the maximum rated junction temperature of the die, $R_{\theta JA}$, the thermal resistance from the device junction to ambient, and the operating temperature, T_A . Using the values provided on the data sheet, P_D can be calculated as follows:

$$P_D = \frac{T_{J(max)} - T_A}{R_{\theta JA}}$$

The values for the equation are found in the maximum ratings table on the data sheet. Substituting these values into the equation for an ambient temperature T_A of 25°C, one can calculate the power dissipation of the device. For example, for a SOT-223 device, P_D is calculated as follows.

$$P_D = \frac{150^\circ\text{C} - 25^\circ\text{C}}{156^\circ\text{C/W}} = 800 \text{ milliwatts}$$

The 156°C/W for the SOT-223 package assumes the use of the recommended footprint on a glass epoxy printed circuit board to achieve a power dissipation of 800 milliwatts. There are other alternatives to achieving higher power dissipation from the surface mount packages. One is to increase the area of the drain/collector pad. By increasing the area of the drain/collector pad, the power dissipation can be increased.

Although the power dissipation can almost be doubled with this method, area is taken up on the printed circuit board which can defeat the purpose of using surface mount technology. For example, a graph of $R_{\theta JA}$ versus drain pad area is shown in Figure 1.

Another alternative would be to use a ceramic substrate or an aluminum core board such as Thermal Clad™. Using a board material such as Thermal Clad, an aluminum core board, the power dissipation can be doubled using the same footprint.

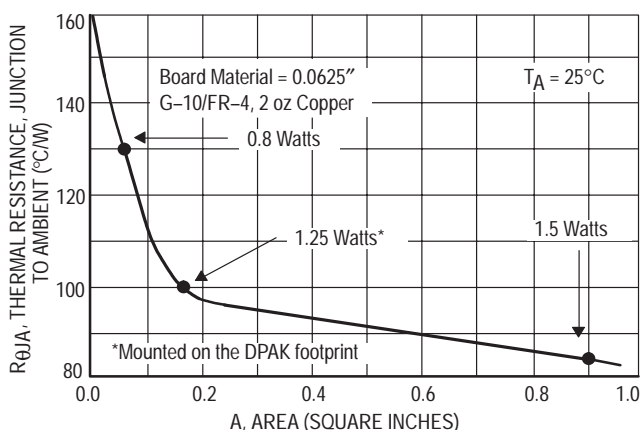


Figure 1. Thermal Resistance versus Drain Pad Area for the SOT-223 Package (Typical)

SOLDER STENCIL GUIDELINES

Prior to placing surface mount components onto a printed circuit board, solder paste must be applied to the pads. Solder stencils are used to screen the optimum amount. These stencils are typically 0.008 inches thick and may be made of brass or stainless steel. For packages such as the

SOT-23, SC-59, SC-70/SOT-323, SC-90/SOT-416, SOD-123, SOT-223, SOT-363, SO-14, SO-16, and TSOP-6 packages, the stencil opening should be the same as the pad size or a 1:1 registration.

SOLDERING PRECAUTIONS

The melting temperature of solder is higher than the rated temperature of the device. When the entire device is heated to a high temperature, failure to complete soldering within a short time could result in device failure. Therefore, the following items should always be observed in order to minimize the thermal stress to which the devices are subjected.

- Always preheat the device.
- The delta temperature between the preheat and soldering should be 100°C or less.*
- When preheating and soldering, the temperature of the leads and the case must not exceed the maximum temperature ratings as shown on the data sheet. When using infrared heating with the reflow soldering method, the difference should be a maximum of 10°C.

- The soldering temperature and time should not exceed 260°C for more than 10 seconds.
- When shifting from preheating to soldering, the maximum temperature gradient shall be 5°C or less.
- After soldering has been completed, the device should be allowed to cool naturally for at least three minutes. Gradual cooling should be used since the use of forced cooling will increase the temperature gradient and will result in latent failure due to mechanical stress.
- Mechanical stress or shock should not be applied during cooling.

* Soldering a device without preheating can cause excessive thermal shock and stress which can result in damage to the device.

TYPICAL SOLDER HEATING PROFILE

For any given circuit board, there will be a group of control settings that will give the desired heat pattern. The operator must set temperatures for several heating zones and a figure for belt speed. Taken together, these control settings make up a heating "profile" for that particular circuit board. On machines controlled by a computer, the computer remembers these profiles from one operating session to the next. Figure 2 shows a typical heating profile for use when soldering a surface mount device to a printed circuit board. This profile will vary among soldering systems, but it is a good starting point. Factors that can affect the profile include the type of soldering system in use, density and types of components on the board, type of solder used, and the type of board or substrate material being used. This profile shows temperature versus time. The line on the graph shows the

actual temperature that might be experienced on the surface of a test board at or near a central solder joint. The two profiles are based on a high density and a low density board. The Vitronics SMD310 convection/infrared reflow soldering system was used to generate this profile. The type of solder used was 62/36/2 Tin Lead Silver with a melting point between 177–189°C. When this type of furnace is used for solder reflow work, the circuit boards and solder joints tend to heat first. The components on the board are then heated by conduction. The circuit board, because it has a large surface area, absorbs the thermal energy more efficiently, then distributes this energy to the components. Because of this effect, the main body of a component may be up to 30 degrees cooler than the adjacent solder joints.

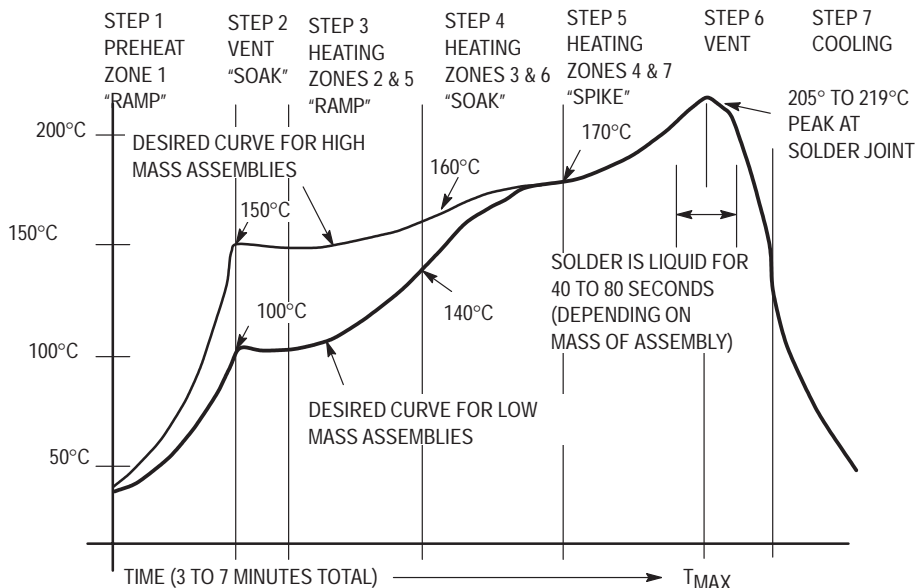
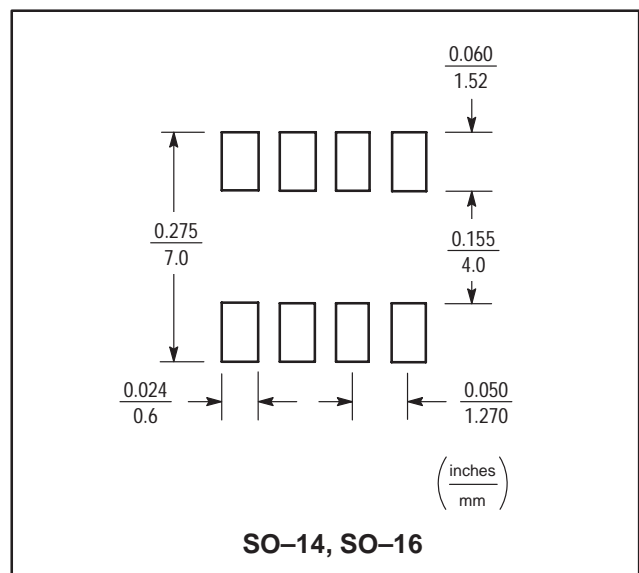
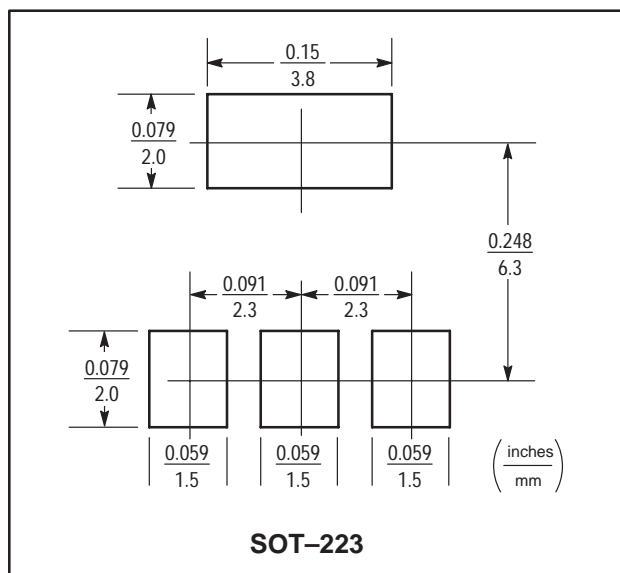
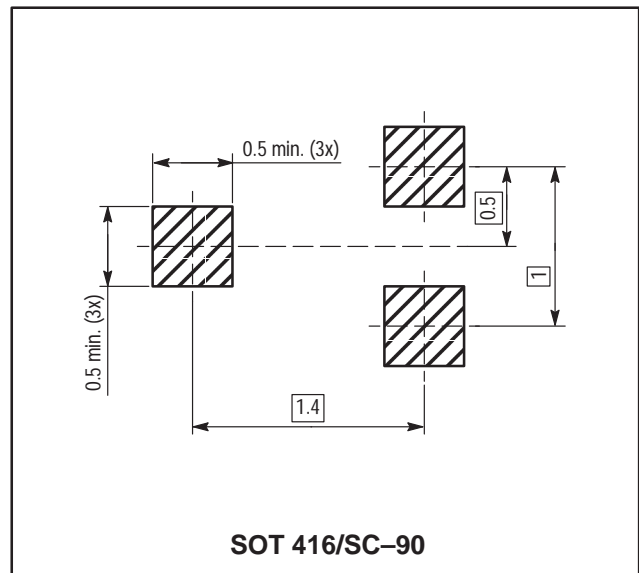
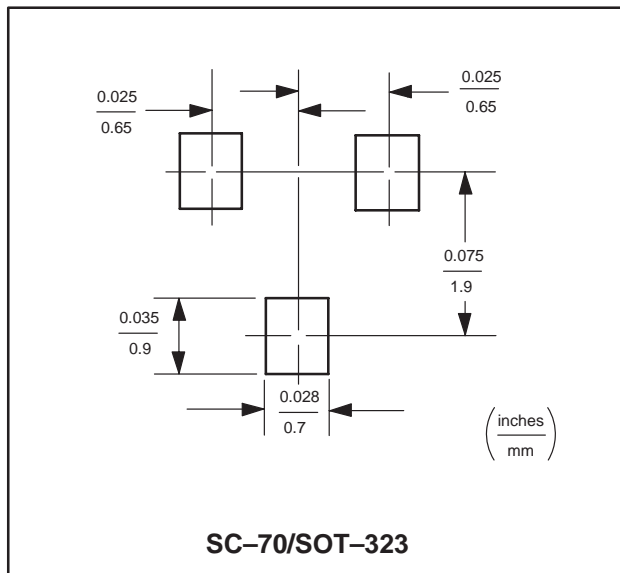
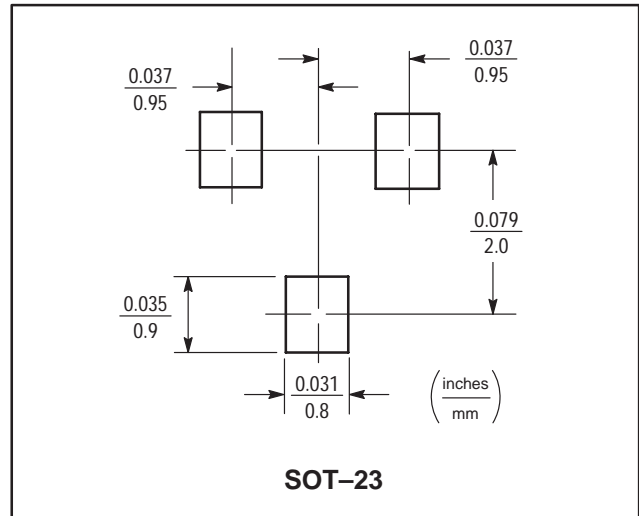
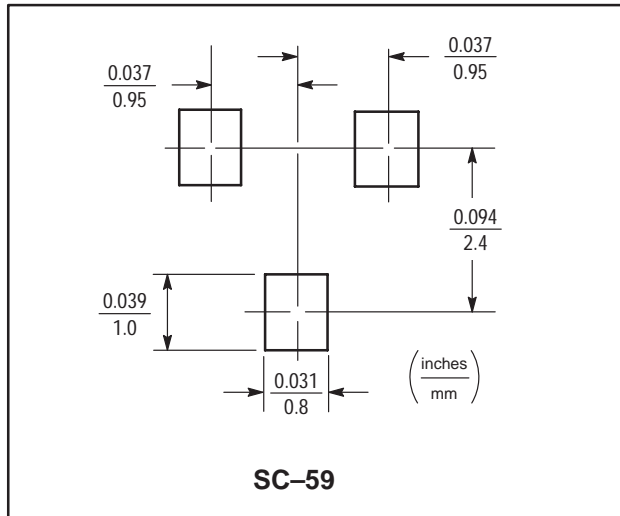
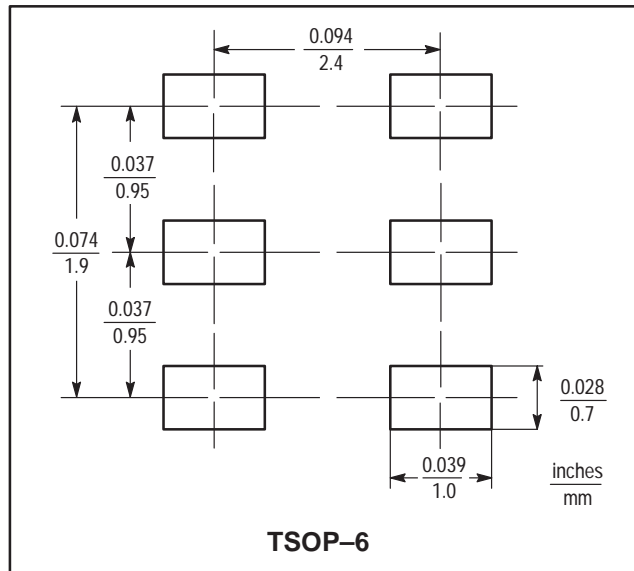
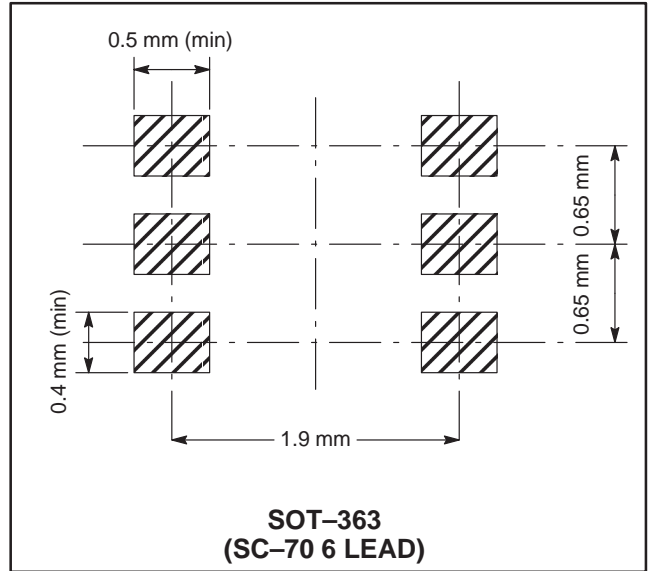
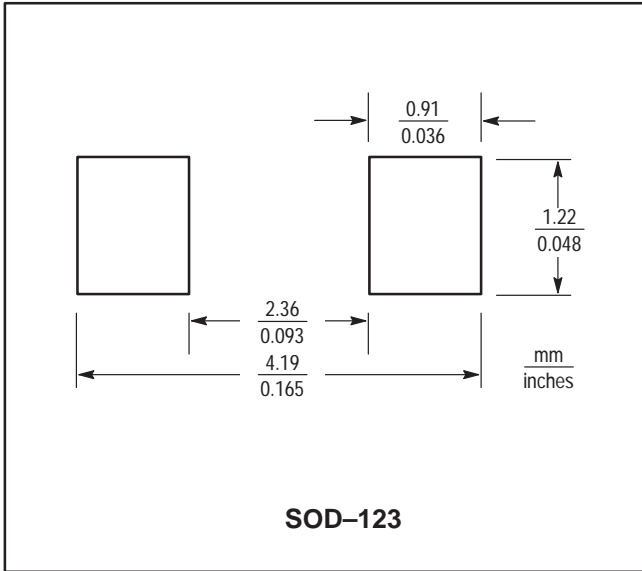


Figure 2. Typical Solder Heating Profile

Footprints for Soldering





Section 8

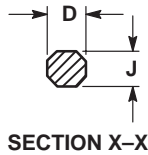
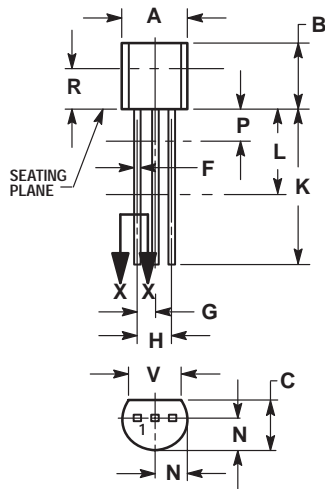
Package Outline Dimensions

In Brief . . .

The following pages contain information on the various packages referenced on the individual data sheets. Information includes: a picture of the package, dimensions in both millimeters and inches, the various pinout configurations (styles), a cross reference for case numbers, old JEDEC "TO" numbers, the new JEDEC "TO" designation, and footprint dimensions for surface mount packages to assist in board layout.

Package Outline Dimensions

Dimensions are in inches unless otherwise noted.



NOTES:

1. DIMENSIONING AND TOLERANCING PER ANSI Y14.5M, 1982.
2. CONTROLLING DIMENSION: INCH.
3. CONTOUR OF PACKAGE BEYOND DIMENSION R IS UNCONTROLLED.
4. DIMENSION F APPLIES BETWEEN P AND L. DIMENSION D AND J APPLY BETWEEN L AND K MINIMUM. LEAD DIMENSION IS UNCONTROLLED IN P AND BEYOND DIMENSION K MINIMUM.

DIM	INCHES		MILLIMETERS	
	MIN	MAX	MIN	MAX
A	0.175	0.205	4.45	5.20
B	0.170	0.210	4.32	5.33
C	0.125	0.165	3.18	4.19
D	0.016	0.022	0.41	0.55
F	0.016	0.019	0.41	0.48
G	0.045	0.055	1.15	1.39
H	0.095	0.105	2.42	2.66
J	0.015	0.020	0.39	0.50
K	0.500	---	12.70	---
L	0.250	---	6.35	---
N	0.080	0.105	2.04	2.66
P	---	0.100	---	2.54
R	0.115	---	2.93	---
V	0.135	---	3.43	---

STYLE 1:
PIN 1. EMITTER
2. BASE
3. COLLECTOR

STYLE 2:
PIN 1. BASE
2. EMITTER
3. COLLECTOR

STYLE 3:
PIN 1. ANODE
2. ANODE
3. CATHODE

STYLE 4:
PIN 1. CATHODE
2. CATHODE
3. ANODE

STYLE 5:
PIN 1. DRAIN
2. SOURCE
3. GATE

STYLE 7:
PIN 1. SOURCE
2. DRAIN
3. GATE

STYLE 14:
PIN 1. EMITTER
2. COLLECTOR
3. BASE

STYLE 15:
PIN 1. ANODE 1
2. CATHODE
3. ANODE 2

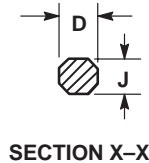
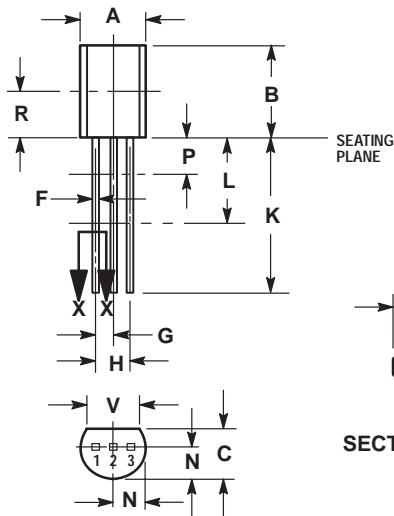
STYLE 17:
PIN 1. COLLECTOR
2. BASE
3. EMITTER

STYLE 21:
PIN 1. COLLECTOR
2. EMITTER
3. BASE

STYLE 22:
PIN 1. SOURCE
2. GATE
3. DRAIN

STYLE 30:
PIN 1. DRAIN
2. GATE
3. SOURCE

**CASE 029-04
(TO-226AA) TO-92
PLASTIC**



NOTES:

1. DIMENSIONING AND TOLERANCING PER ANSI Y14.5M, 1982.
2. CONTROLLING DIMENSION: INCH.
3. CONTOUR OF PACKAGE BEYOND DIMENSION R IS UNCONTROLLED.
4. DIMENSION F APPLIES BETWEEN P AND L. DIMENSIONS D AND J APPLY BETWEEN L AND K MINIMUM. LEAD DIMENSION IS UNCONTROLLED IN P AND BEYOND DIMENSION K MINIMUM.

DIM	INCHES		MILLIMETERS	
	MIN	MAX	MIN	MAX
A	0.175	0.205	4.44	5.21
B	0.290	0.310	7.37	7.87
C	0.125	0.165	3.18	4.19
D	0.018	0.022	0.46	0.56
F	0.016	0.019	0.41	0.48
G	0.045	0.055	1.15	1.39
H	0.095	0.105	2.42	2.66
J	0.018	0.024	0.46	0.61
K	0.500	---	12.70	---
L	0.250	---	6.35	---
N	0.080	0.105	2.04	2.66
P	---	0.100	---	2.54
R	0.135	---	3.43	---
V	0.135	---	3.43	---

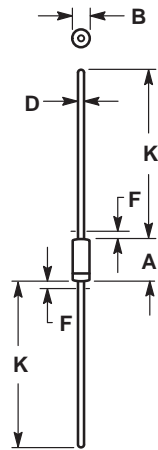
STYLE 1:
PIN 1. EMITTER
2. BASE
3. COLLECTOR

STYLE 14:
PIN 1. EMITTER
2. COLLECTOR
3. BASE

STYLE 22:
PIN 1. SOURCE
2. GATE
3. DRAIN

**CASE 029-05
(TO-226AE) TO-92
1-WATT PLASTIC**

PACKAGE OUTLINE DIMENSIONS (continued)



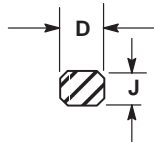
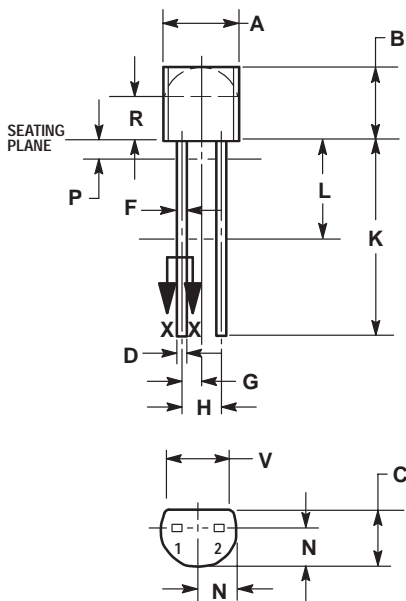
NOTES:

1. PACKAGE CONTOUR OPTIONAL WITHIN DIA B AND LENGTH A. HEAT SLUGS, IF ANY, SHALL BE INCLUDED WITHIN THIS CYLINDER, BUT SHALL NOT BE SUBJECT TO THE MIN LIMIT OF DIA B.
2. LEAD DIA NOT CONTROLLED IN ZONES F, TO ALLOW FOR FLASH, LEAD FINISH BUILDUP, AND MINOR IRREGULARITIES OTHER THAN HEAT SLUGS.

DIM	MILLIMETERS		INCHES	
	MIN	MAX	MIN	MAX
A	5.84	7.62	0.230	0.300
B	2.16	2.72	0.085	0.107
D	0.46	0.56	0.018	0.022
F	---	1.27	---	0.050
K	25.40	38.10	1.000	1.500

All JEDEC dimensions and notes apply.

CASE 51-02
(DO-204AA)
DO-7



SECTION X-X

NOTES:

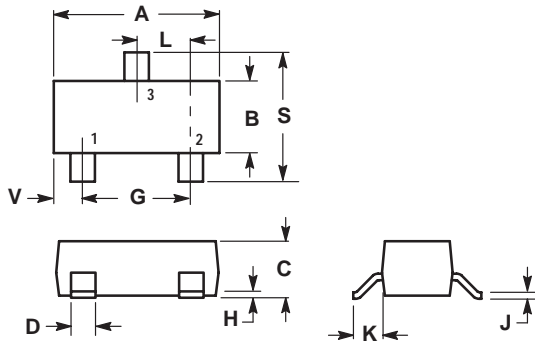
1. DIMENSIONING AND TOLERANCING PER ANSI Y14.5M, 1982.
2. CONTROLLING DIMENSION: INCH.
3. CONTOUR OF PACKAGE BEYOND ZONE R IS UNCONTROLLED.
4. DIMENSION F APPLIES BETWEEN P AND L. DIMENSIONS D AND J APPLY BETWEEN L AND K MINIMUM. LEAD DIMENSION IS UNCONTROLLED IN P AND BEYOND DIM K MINIMUM.

DIM	INCHES		MILLIMETERS	
	MIN	MAX	MIN	MAX
A	0.175	0.205	4.45	5.21
B	0.170	0.210	4.32	5.33
C	0.125	0.165	3.18	4.49
D	0.016	0.022	0.41	0.56
F	0.016	0.019	0.407	0.482
G	0.050 BSC		1.27 BSC	
H	0.100 BSC		3.54 BSC	
J	0.014	0.016	0.36	0.41
K	0.500	---	12.70	---
L	0.250	---	6.35	---
N	0.080	0.105	2.03	2.66
P	---	0.050	---	1.27
R	0.115	---	2.93	---
V	0.135	---	3.43	---

STYLE 1:
PIN 1. ANODE
2. CATHODE

CASE 182-02
(T0-226AC) TO-92
PLASTIC

PACKAGE OUTLINE DIMENSIONS (continued)



- NOTES:
1. DIMENSIONING AND TOLERANCING PER ANSI Y14.5M, 1982.
 2. CONTROLLING DIMENSION: INCH.
 3. MAXIMUM LEAD THICKNESS INCLUDES LEAD FINISH THICKNESS. MINIMUM LEAD THICKNESS IS THE MINIMUM THICKNESS OF BASE MATERIAL.

DIM	INCHES		MILLIMETERS	
	MIN	MAX	MIN	MAX
A	0.1102	0.1197	2.80	3.04
B	0.0472	0.0551	1.20	1.40
C	0.0350	0.0440	0.89	1.11
D	0.0150	0.0200	0.37	0.50
G	0.0701	0.0807	1.78	2.04
H	0.0005	0.0040	0.013	0.100
J	0.0034	0.0070	0.085	0.177
K	0.0140	0.0285	0.35	0.69
L	0.0350	0.0401	0.89	1.02
S	0.0830	0.1039	2.10	2.64
V	0.0177	0.0236	0.45	0.60

STYLE 6:
PIN 1. BASE
2. EMITTER
3. COLLECTOR

STYLE 8:
PIN 1. ANODE
2. NO CONNECTION
3. CATHODE

STYLE 9:
PIN 1. ANODE
2. ANODE
3. CATHODE

STYLE 10:
PIN 1. DRAIN
2. SOURCE
3. GATE

STYLE 11:
PIN 1. ANODE
2. CATHODE
3. CATHODE-ANODE

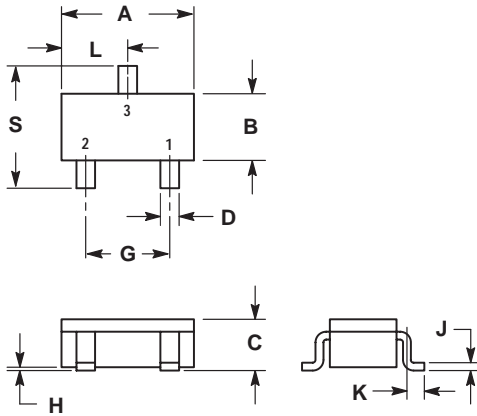
STYLE 12:
PIN 1. CATHODE
2. CATHODE
3. ANODE

STYLE 18:
PIN 1. NO CONNECTION
2. CATHODE
3. ANODE

STYLE 19:
PIN 1. CATHODE
2. ANODE
3. CATHODE-ANODE

STYLE 21:
PIN 1. GATE
2. SOURCE
3. DRAIN

**CASE 318-08
(TO-236AB) SOT-23
PLASTIC**



- NOTES:
1. DIMENSIONING AND TOLERANCING PER ANSI Y14.5M, 1982.
 2. CONTROLLING DIMENSION: MILLIMETER.

DIM	MILLIMETERS		INCHES	
	MIN	MAX	MIN	MAX
A	2.70	3.10	0.1063	0.1220
B	1.30	1.70	0.0512	0.0669
C	1.00	1.30	0.0394	0.0511
D	0.35	0.50	0.0138	0.0196
G	1.70	2.10	0.0670	0.0826
H	0.013	0.100	0.0005	0.0040
J	0.09	0.18	0.0034	0.0070
K	0.20	0.60	0.0079	0.0236
L	1.25	1.65	0.0493	0.0649
S	2.50	3.00	0.0985	0.1181

STYLE 1:
PIN 1. EMITTER
2. BASE
3. COLLECTOR

STYLE 2:
PIN 1. N.C.
2. ANODE
3. CATHODE

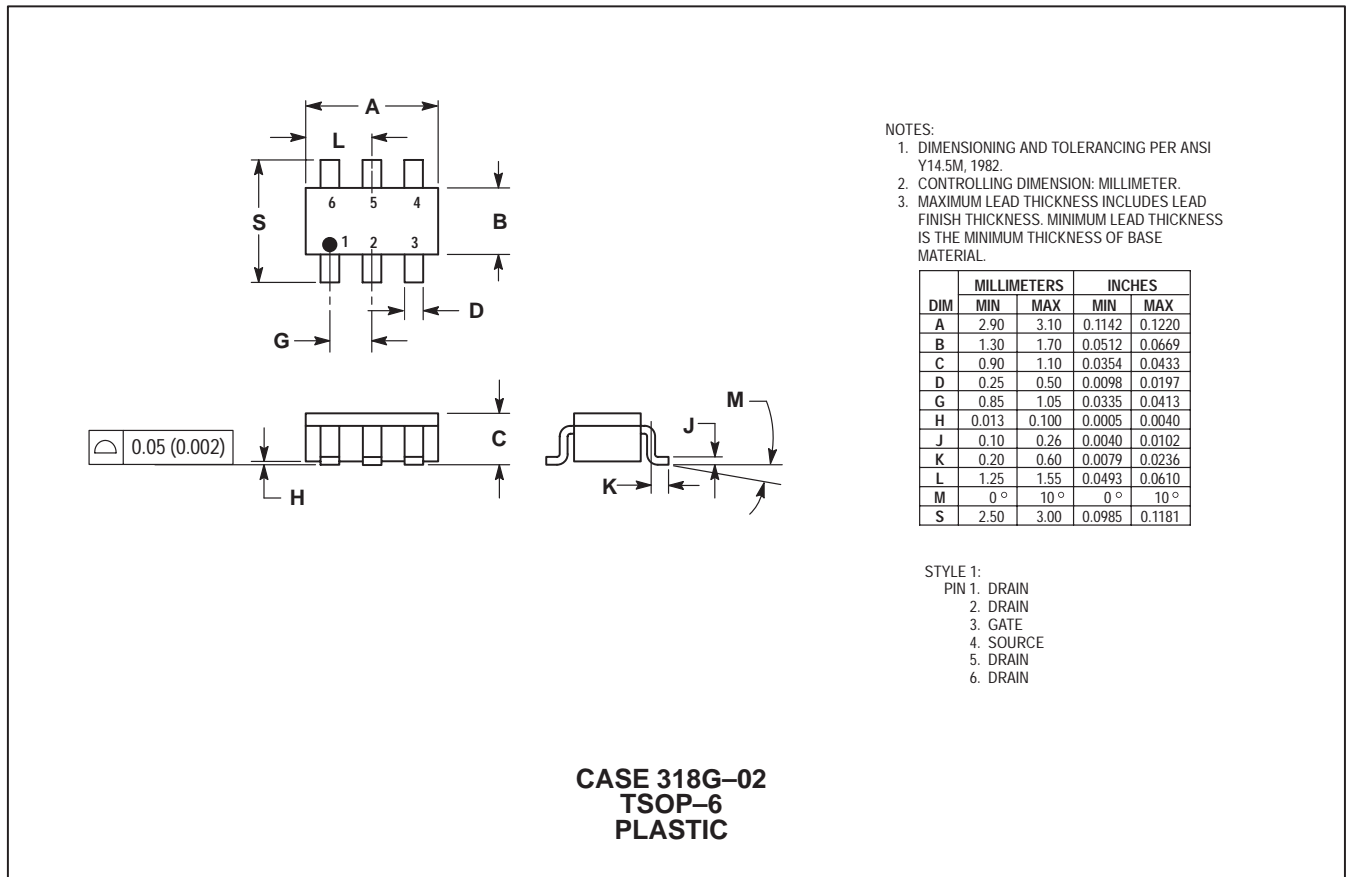
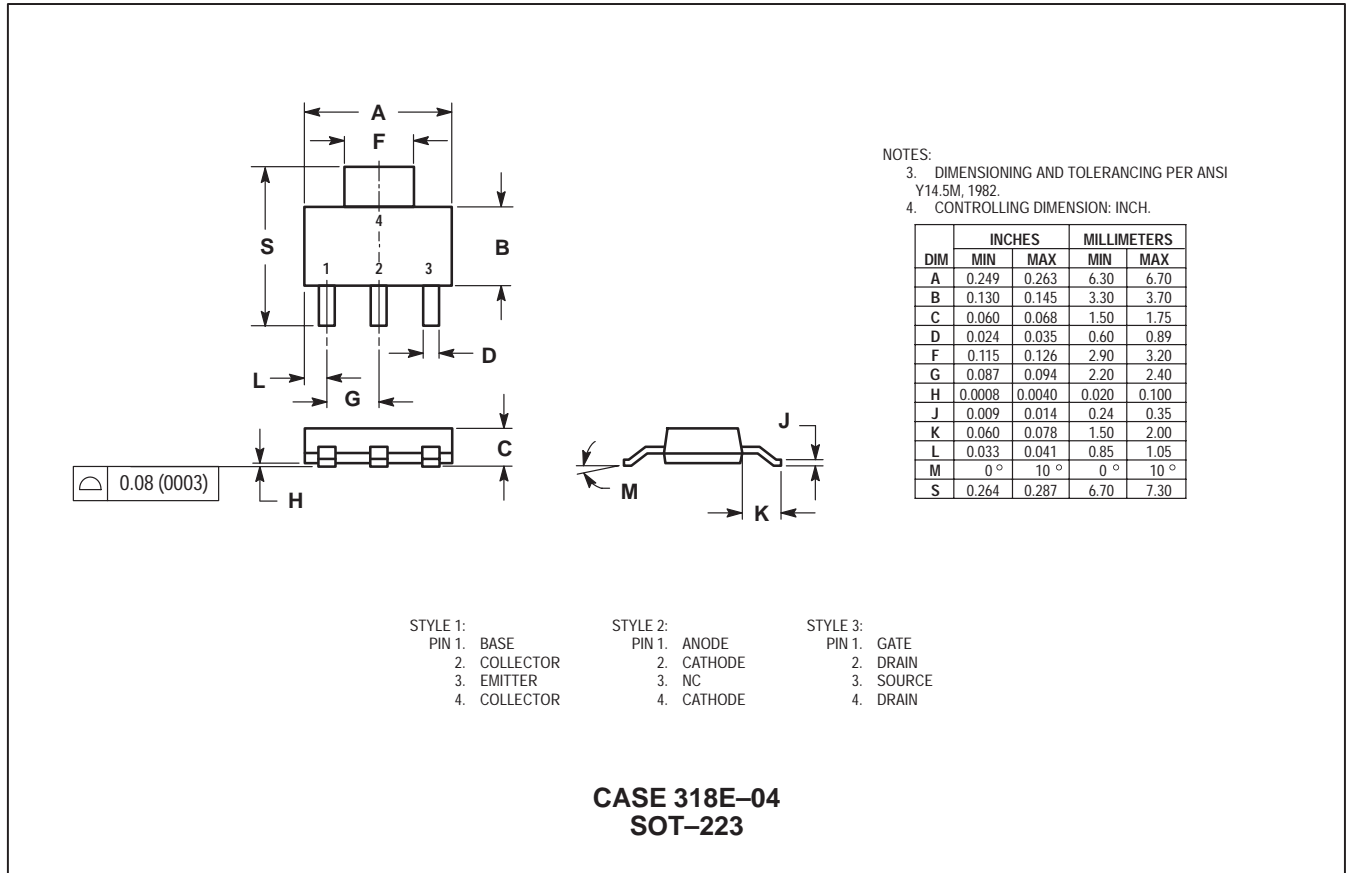
STYLE 3:
PIN 1. ANODE
2. ANODE
3. CATHODE

STYLE 4:
PIN 1. N.C.
2. CATHODE
3. ANODE

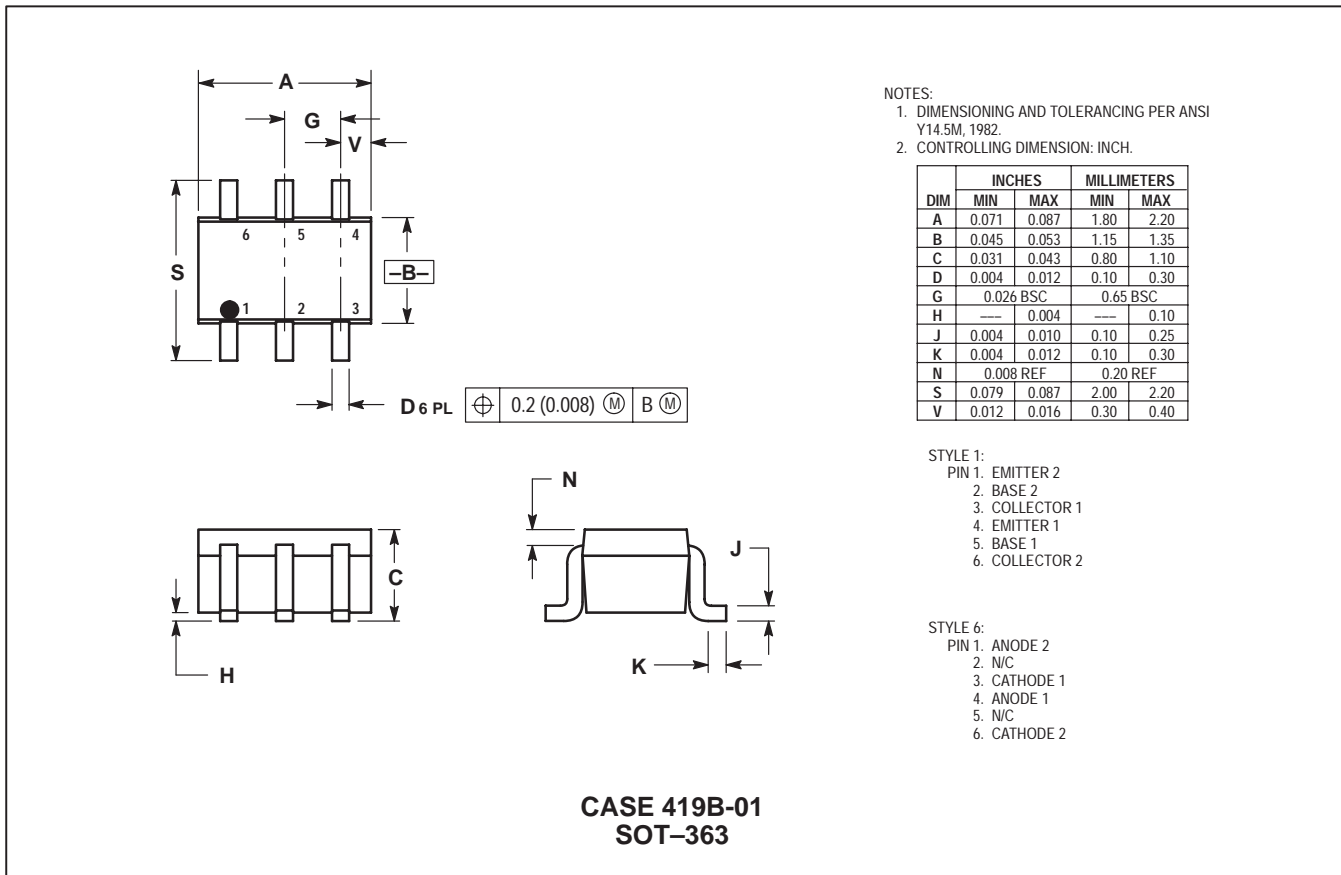
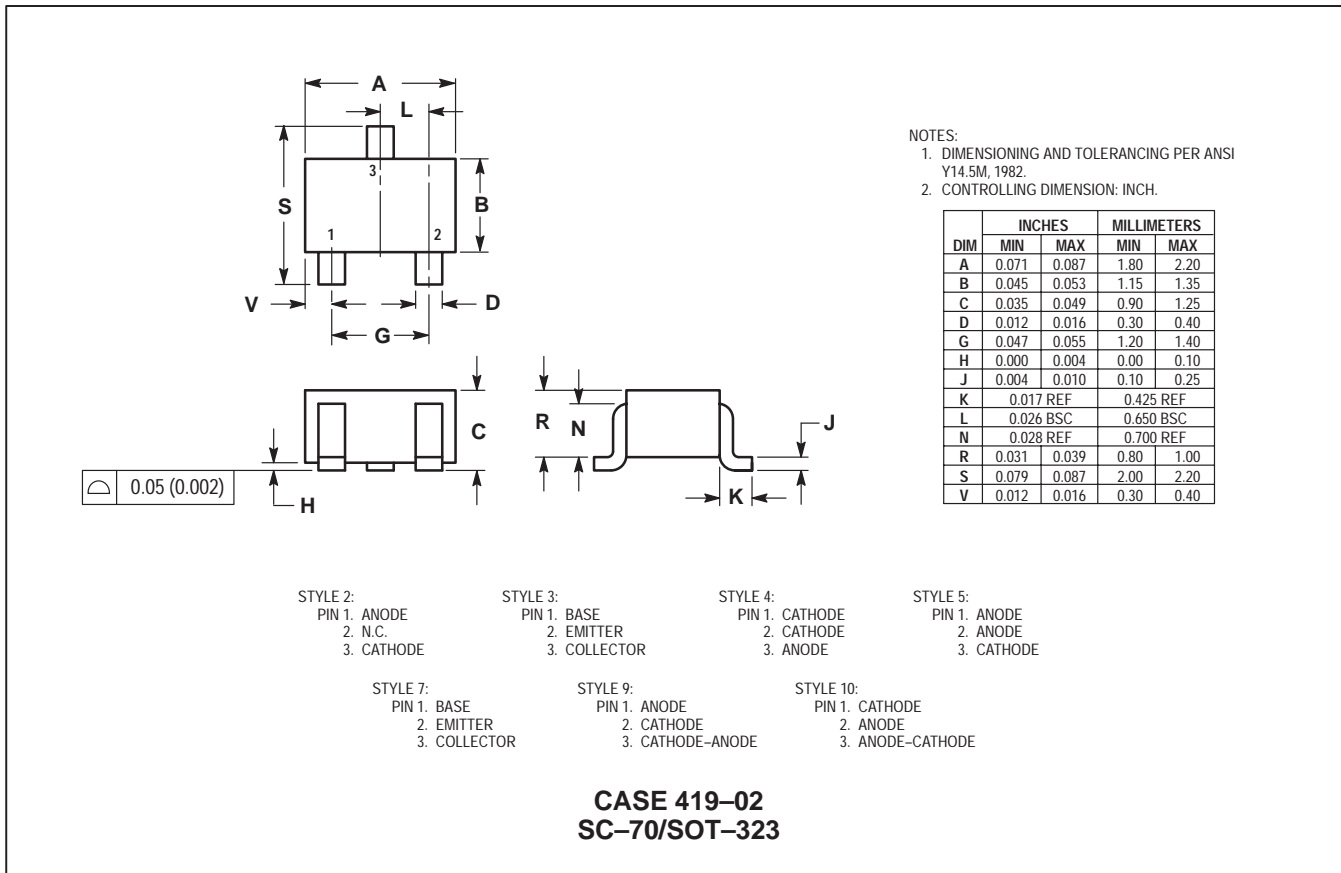
STYLE 5:
PIN 1. CATHODE
2. CATHODE
3. ANODE

**CASE 318D-04
SC-59**

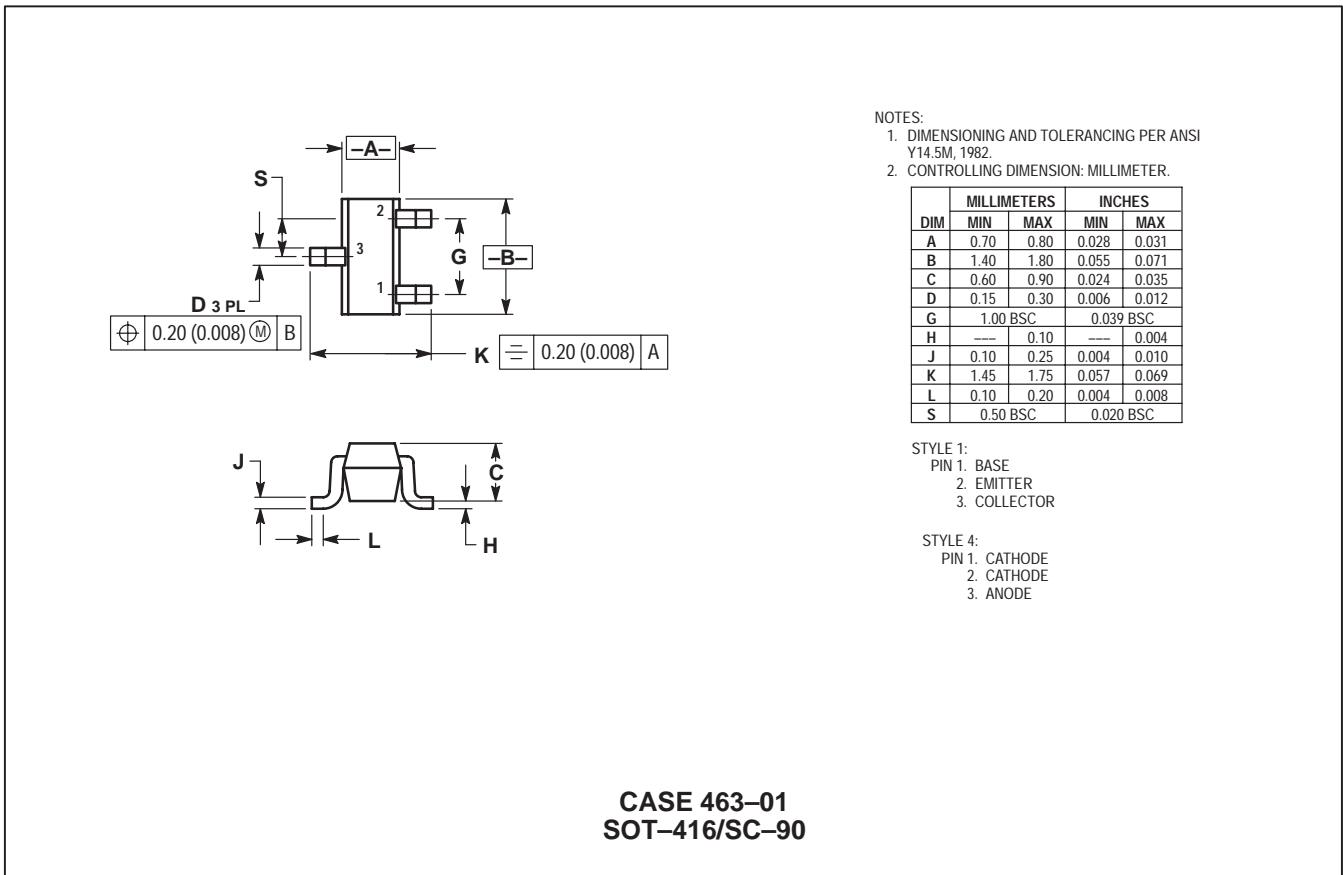
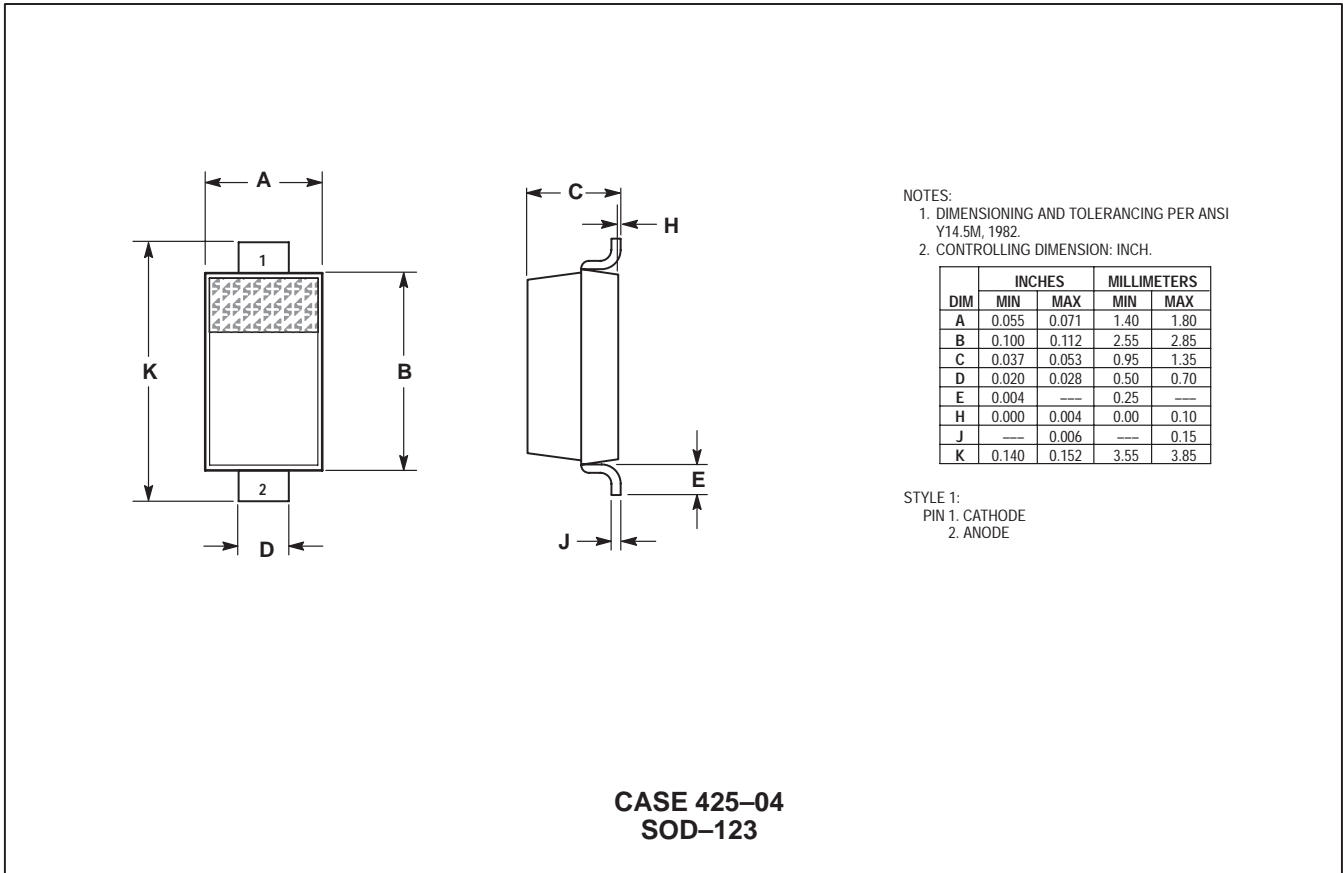
PACKAGE OUTLINE DIMENSIONS (continued)



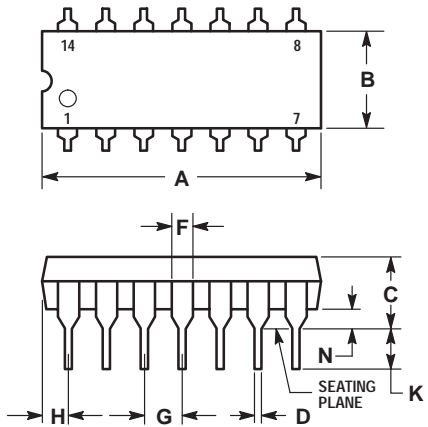
PACKAGE OUTLINE DIMENSIONS (continued)



PACKAGE OUTLINE DIMENSIONS (continued)



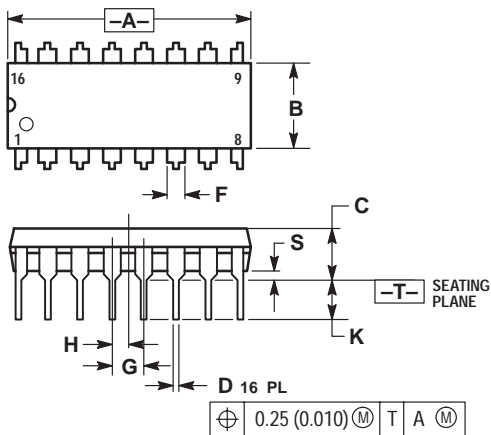
PACKAGE OUTLINE DIMENSIONS (continued)



- NOTES:
- LEADS WITHIN 0.13 (0.005) RADIUS OF TRUE POSITION AT SEATING PLANE AT MAXIMUM MATERIAL CONDITION.
 - DIMENSION L TO CENTER OF LEADS WHEN FORMED PARALLEL.
 - DIMENSION B DOES NOT INCLUDE MOLD FLASH.
 - ROUNDED CORNERS OPTIONAL.

DIM	INCHES		MILLIMETERS	
	MIN	MAX	MIN	MAX
A	0.715	0.770	18.16	19.56
B	0.240	0.260	6.10	6.60
C	0.145	0.185	3.69	4.69
D	0.015	0.021	0.38	0.53
F	0.040	0.070	1.02	1.78
G	0.100 BSC		2.54 BSC	
H	0.052	0.095	1.32	2.41
J	0.008	0.015	0.20	0.38
K	0.115	0.135	2.92	3.43
L	0.300 BSC		7.62 BSC	
M	0° - 10°		0° - 10°	
N	0.015	0.039	0.39	1.01

CASE 646-06
14-PIN DIP
PLASTIC

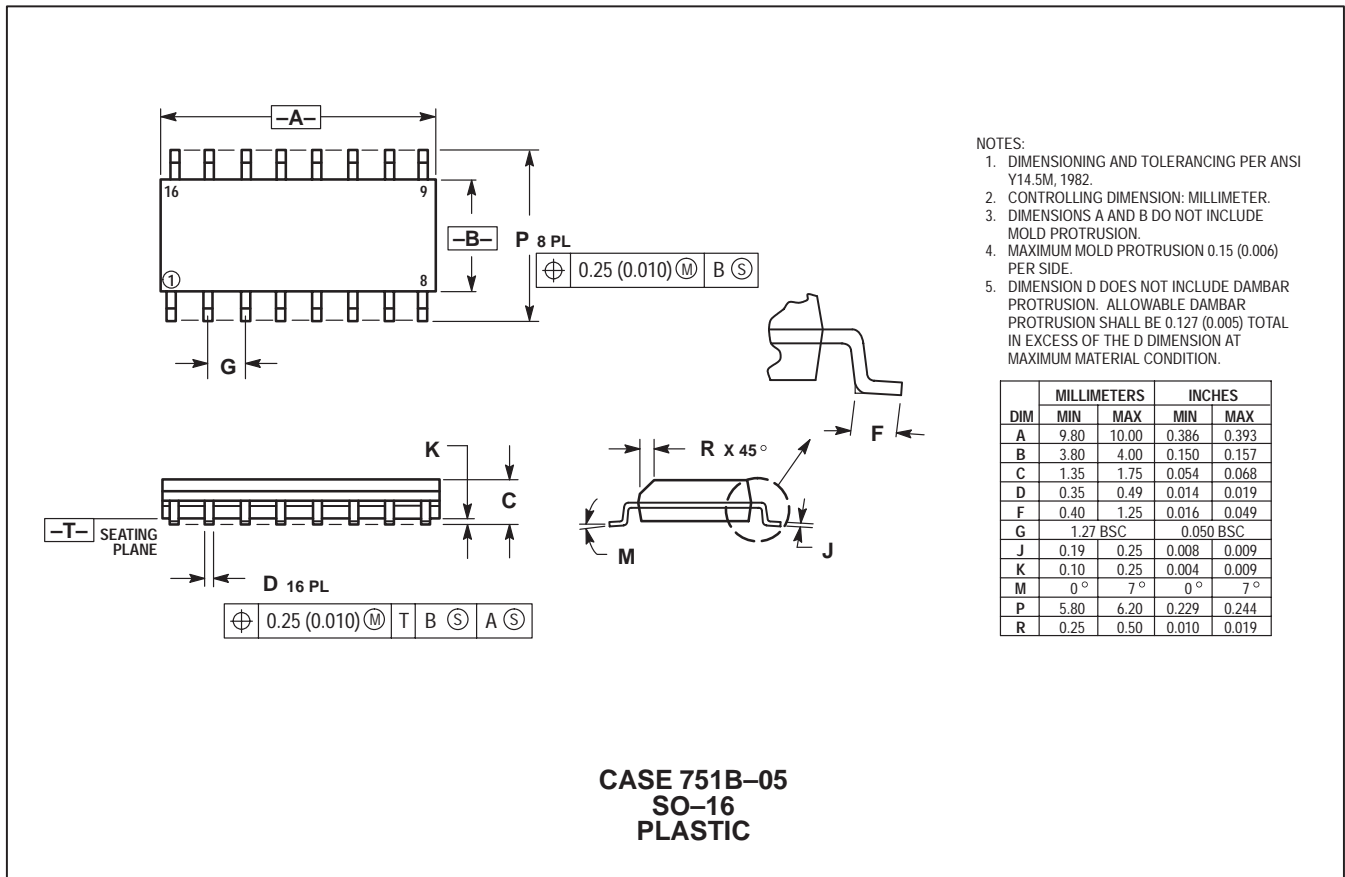
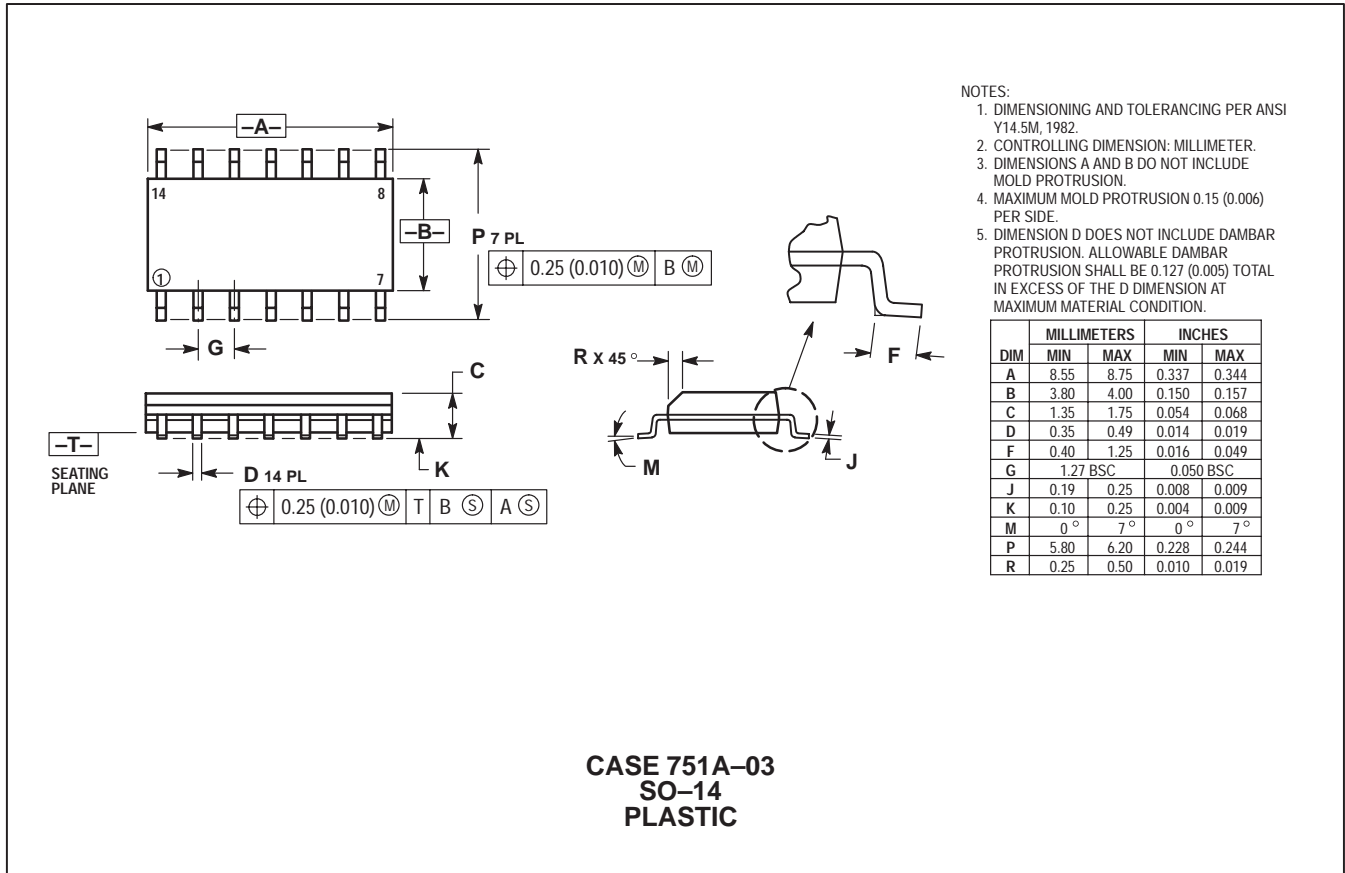


- NOTES:
- DIMENSIONING AND TOLERANCING PER ANSI Y14.5M, 1982.
 - CONTROLLING DIMENSION: INCH.
 - DIMENSION L TO CENTER OF LEADS WHEN FORMED PARALLEL.
 - DIMENSION B DOES NOT INCLUDE MOLD FLASH.
 - ROUNDED CORNERS OPTIONAL.

DIM	INCHES		MILLIMETERS	
	MIN	MAX	MIN	MAX
A	0.740	0.770	18.80	19.55
B	0.250	0.270	6.35	6.85
C	0.145	0.175	3.69	4.44
D	0.015	0.021	0.39	0.53
F	0.040	0.70	1.02	1.77
G	0.100 BSC		2.54 BSC	
H	0.050 BSC		1.27 BSC	
J	0.008	0.015	0.21	0.38
K	0.110	0.130	2.80	3.30
L	0.295	0.305	7.50	7.74
M	0° - 10°		0° - 10°	
S	0.020	0.040	0.51	1.01

CASE 648-08
16-PIN DIP
PLASTIC

PACKAGE OUTLINE DIMENSIONS (continued)



Section 9

Reliability and Quality Assurance

In Brief . . .

This Reliability and Quality Assurance section contains information on the measurement of outgoing quality, reliability data analysis, reliability stress test descriptions with the applicable MIL-STD methods, statistical process control techniques, and quality assurance processing.

OUTGOING QUALITY

The Average Outgoing Quality (AOQ) refers to the number of devices per million that are outside the specification limits at the time of shipment. Motorola has established Six Sigma goals to improve its outgoing quality and will continue its "error free performance" focus to achieve its goal of zero parts per million (PPM) outgoing quality. Motorola's present quality level has led to vendor certification programs with many of its customers. These programs ensure a level of quality which allows the customer either to reduce or eliminate the need for incoming inspections.

AVERAGE OUTGOING QUALITY (AOQ) CALCULATION

$$AOQ = (\text{Process Average}) \bullet (\text{Probability of Acceptance}) \bullet (10^6) \text{ (PPM)}$$

- Process Average = $\frac{\text{Total Projected Reject Devices}}{\text{Total Number of Devices}}$
- Projected Reject Devices = $\frac{\text{Defects in Sample}}{\text{Sample Size}} \bullet \text{Lot Size}$
- Total Number of Devices = Sum of units in each submitted lot
- Probability of Acceptance = $1 \pm \frac{\text{Number of Lots Rejected}}{\text{Number of Lots Tested}}$
- 10^6 = Conversion to parts per million (PPM)

RELIABILITY DATA ANALYSIS

Reliability is the probability that a semiconductor device will perform its specified function in a given environment for a specified period. In other words, reliability is quality over time and environmental conditions. The most frequently used reliability measure for semiconductor devices is the failure rate (λ). The failure rate is obtained by dividing the number of failures observed by the product of the number of devices on test and the interval in hours, usually expressed as percent per thousand hours or failures per billion device hours (FITS). This is called a point estimate because it is obtained from observations on a portion (sample) of the population of devices.

To project from the sample to the population in general, one must establish confidence intervals. The application of confidence intervals is a statement of how "confident" one is that the sample failure rate approximates that for the population. To obtain failure rates at different confidence levels, it is necessary to make use of specific probability distributions. The chi-square (χ^2) distribution that relates observed and expected frequencies of an event is frequently used to establish confidence intervals. The relationship between failure rate and the chi-square distribution is as follows:

$$\lambda = \frac{\chi^2(\alpha, \text{d. f.})}{2t}$$

where:

- λ = failure rate
- χ^2 = chi-square function
- α = (100 – confidence level) / 100
- d.f. = degrees of freedom = $2r + 2$
- r = number of failures
- t = device hours

Chi-square values for 60% and 90% confidence intervals for up to 12 failures are shown in Table 1-1.

Table 1-1 – Chi-Square Table

Chi-Square Distribution Function			
60% Confidence Level		90% Confidence Level	
No. Fails	χ^2 Quantity	No. Fails	χ^2 Quantity
0	1.833	0	4.605
1	4.045	1	7.779
2	6.211	2	10.645
3	8.351	3	13.362
4	10.473	4	15.987
5	12.584	5	18.549
6	14.685	6	21.064
7	16.780	7	23.542
8	18.868	8	25.989
9	20.951	9	28.412
10	23.031	10	30.813
11	25.106	11	33.196
12	27.179	12	35.563

The failure rate of semiconductor devices is inherently low. As a result, the industry uses a technique called accelerated testing to assess the reliability of semiconductors. During accelerated tests, elevated stresses are used to produce, in a short period, the same failure mechanisms as would be observed under normal use conditions. The objective of this testing is to identify these failure mechanisms and eliminate them as a cause of failure during the useful life of the product.

Temperature, relative humidity, and voltage are the most frequently used stresses during accelerated testing. Their relationship to failure rates has been shown to follow an Eyring type of equation of the form:

$$\lambda = A \exp(\phi/kT) \bullet \exp(B/RH) \bullet \exp(CE)$$

Where A, B, C, ϕ , and k are constants, more specifically B, C, and ϕ are numbers representing the apparent energy at which various failure mechanisms occur. These are called activation energies. "T" is the temperature, "RH" is the relative humidity, and "E" is the electric field. The most familiar form of this equation (shown on following page) deals with the first exponential term that shows an Arrhenius type relationship of the failure rate versus the junction temperature of semiconductors. The junction temperature is related to the ambient temperature through the thermal resistance and power dissipation. Thus, we can test devices near their maximum junction temperatures, analyze the failures to assure that they are the types that are accelerated by temperature and then by applying known acceleration factors, estimate the failure rates for lower junction.

The table on the following page shows observed activation energies with references.

**Table 1-2 – Time Dependent Failure Mechanisms in Semiconductor Devices
(Applicable to Discrete and Integrated Circuits)**

Device Association	Process	Relevant Factors	Accelerating Factors	Typical Activation Energy in eV	Model	Reference
Silicon Oxide Silicon-Silicon Oxide Interface	Surface Charges Inversion, Accumulation	Mobile Ions E/V, T	T, V	1.0	Fitch, et al. Peck	1A 2
	Oxide Pinholes	E/V, T	E, T	0.7–1.0 (Bipolar) 1.0 (Bipolar)	1984 WRS Hokari, et al.	18 5
	Dielectric Breakdown (TDDB)	E/V, T	E, T	0.3–0.4 (MOS) 0.3 (MOS)	Domangue, et al. Crook, D.L.	3 4
	Charge Loss	E, T	E, T	0.8 (MOS) EPROM	Gear, G.	11
Metallization	Electromigration	T, J	J, T	1.0 Large grain Al (glassivated)	Nanda, et al.	6
		Grain Size		0.5 Small grain Al	Black, J.R.	7
		Doping		0.7 Cu–Al/Cu–Si–Al (sputtered)	Black, J.R.	12
	Corrosion Chemical Galvanic Electrolytic	Contamination	H, E/V, T	0.6–0.7 (for electrolysis) E/V may have thresholds	Lycoudes, N.E.	8
Bond and Other Mechanical Interfaces	Intermetallic Growth	T, Impurities Bond Strength	T	1.0 (Au/Al)	Fitch, W.T	9
Various Water Fab, Assembly, and Silicon Defects	Metal Scratches Mask Defects, etc. Silicon Defects	T, V	T, V	0.5–0.7 eV	Howes, et al.	10
				0.5 eV	MMPD	13

V = voltage; E = electric field; T = temperature; J = current density; H = humidity

NO. REFERENCE

<p>1A 1.0 eV activation for leakage type failures. Fitch, W.T.; Greer, P.; Lycoudes, N.; "Data to Support 0.001%/1000 Hours for Plastic I/C's." Case study on linear product shows 0.914 eV activation energy which is within experimental error of 0.9 to 1.3 eV activation energies for reversible leakage (inversion) failures reported in the literature.</p> <p>1B 0.7 To 1.0 eV for oxide defect failures for bipolar structures. This is under investigation subsequent to information obtained from 1984 Wafer Reliability Symposium, especially for bipolar capacitors with silicon nitride as dielectric.</p> <p>2 1.0 eV activation for leakage type failures. Peck, D.S.; "New Concerns About Integrated Circuit Reliability" 1978 Reliability Physics Symposium.</p> <p>3 0.36 eV for dielectric breakdown for MOS gate structures. Domangue, E.; Rivera, R.; Shedard, C.; "Reliability Prediction Using Large MOS Capacitors", 1984 Reliability Physics Symposium.</p> <p>4 0.3 eV for dielectric breakdown. Crook, D.L.; "Method of Determining Reliability Screens for Time Dependent Dielectric Breakdown", 1979 Reliability Physics Symposium.</p> <p>5 1.0 eV for dielectric breakdown. Hokari, Y.; et al.; IEDM Technical Digest, 1982.</p>	<p>6 1.0 eV for large grain Al–Si (compared to line width). Nanda, Vangard, Gj–P; Black, J.R.; "Electromigration of Al–Si Alloy Films", 1978 Reliability Physics Symposium.</p> <p>7 0.5 eV Al, 0.7 eV Cu–Al small grain (compared to line width). Black, J.R.; "Current Limitation of Thin Film Conductor" 1982 Reliability Physics Symposium.</p> <p>8 0.65 eV for corrosion mechanism. Lycoudes, N.E.; "The Reliability of Plastic Microcircuits in Moist Environments", 1978 Solid State Technology.</p> <p>9 1.0 eV for open wires or high resistance bonds at the pad bond due to Au–Al intermetallics. Fitch, W.T.; "Operating Life vs Junction Temperatures for Plastic Encapsulated I/C (1.5 mil Au wire)", unpublished report.</p> <p>10 0.7 eV for assembly related defects. Howes, M.G.; Morgan, D.V.; "Reliability and Degradation, Semiconductor Devices and Circuits" John Wiley and Sons, 1981.</p> <p>11 Gear, G.; "FAMOUS PROM Reliability Studies", 1976 Reliability Physics Symposium.</p> <p>12 Black, J.R.: unpublished report.</p> <p>13 Motorola Memory Products Division; unpublished report.</p>
-------------------------------------------------------------------------------------------------------------------------------------------------------------------------------------------------------------------------------------------------------------------------------------------------------------------------------------------------------------------------------------------------------------------------------------------------------------------------------------------------------------------------------------------------------------------------------------------------------------------------------------------------------------------------------------------------------------------------------------------------------------------------------------------------------------------------------------------------------------------------------------------------------------------------------------------------------------------------------------------------------------------------------------------------------------------------------------------------------------------------------------------------------------------------------------------------------------------------------------------------------------------------------------	------------------------------------------------------------------------------------------------------------------------------------------------------------------------------------------------------------------------------------------------------------------------------------------------------------------------------------------------------------------------------------------------------------------------------------------------------------------------------------------------------------------------------------------------------------------------------------------------------------------------------------------------------------------------------------------------------------------------------------------------------------------------------------------------------------------------------------------------------------------------------------------------------------------------------------------------------------------------------------------------------------------------------------------------------------------------------------------------------------------------------------------------

THERMAL RESISTANCE

Circuit performance and long-term circuit reliability are affected by die temperature. Normally, both are improved by keeping the junction temperatures low.

Electrical power dissipated in any semiconductor device is a source of heat. This heat source increases the temperature of the die about some reference point, normally the ambient temperature of 25°C in still air. The temperature increase, then, depends on the amount of power dissipated in the circuit and on the net thermal resistance between the heat source and the reference point.

The temperature at the junction depends on the packaging and mounting system's ability to remove heat generated in the circuit from the junction region to the ambient environment. The basic formula for converting power dissipation to estimated junction temperature is:

$$T_J = T_A + P_D (\theta_{JC} + \theta_{CA}) \quad (1)$$

or

$$T_J = T_A + P_D \theta_{JA} \quad (2)$$

where:

T_J = maximum junction temperature

T_A = maximum ambient temperature

P_D = calculated maximum power dissipation, including effects of external loads when applicable

θ_{JC} = average thermal resistance, junction to case

θ_{CA} = average thermal resistance, case to ambient

θ_{JA} = average thermal resistance, junction to ambient

This Motorola recommended formula has been approved by RADC and DESC for calculating a "practical" maximum operating junction temperature for MIL-M-38510 devices.

Only two terms on the right side of equation (1) can be varied by the user, the ambient temperature and the device case-to-ambient thermal resistance, θ_{CA} . (To some extent the device power dissipation can also be controlled, but under recommended use the supply voltage and loading dictate a

fixed power dissipation.) Both system air flow and the package mounting technique affect the θ_{CA} thermal resistance term. θ_{JC} is essentially independent of air flow and external mounting method, but is sensitive to package material, die bonding method, and die area.

For applications where the case is held at essentially a fixed temperature by mounting on a large or temperature controlled heat sink, the estimated junction temperature is calculated by:

$$T_J = T_C + P_D \theta_{JC} \quad (3)$$

where T_C = maximum case temperature and the other parameters are as previously defined.

AIR FLOW

Air flow over the packages (due to a decrease in θ_{JC}) reduces the thermal resistance of the package, therefore permitting a corresponding increase in power dissipation without exceeding the maximum permissible operating junction temperature.

For thermal resistance values for specific packages, see the Motorola Data Book or Design Manual for the appropriate device family or contact your local Motorola sales office.

ACTIVATION ENERGY

Determination of activation energies is accomplished by testing randomly selected samples from the same population at various stress levels and comparing failure rates due to the same failure mechanism. The activation energy is represented by the slope of the curve relating to the natural logarithm of the failure rate to the various stress levels.

In calculating failure rates, the comprehensive method is to use the specific activation energy for each failure mechanism applicable to the technology and circuit under consideration. A common alternative method is to use a single activation energy value for the "expected" failure mechanism(s) with the lowest activation energy.

RELIABILITY STRESS TESTS

The following are brief descriptions of the reliability tests commonly used in the reliability monitoring program. Not all of the tests listed are performed by each product division. Other tests may be performed when appropriate.

AUTOCLAVE (aka, PRESSURE COOKER)

Autoclave is an environmental test which measures device resistance to moisture penetration and the resultant effect of galvanic corrosion. Autoclave is a highly accelerated and destructive test.

Typical Test Conditions: $T_A = 121^\circ\text{C}$, $\text{rh} = 100\%$, $p = 1$ atmosphere (15 psig), $t = 24$ to 96 hours

Common Failure Modes: Parametric shifts, high leakage and/or catastrophic

Common Failure Mechanisms: Die corrosion or contaminants such as foreign material on or within the package materials. Poor package sealing.

HIGH HUMIDITY HIGH TEMPERATURE BIAS (H3TB, H3TRB, or THB)

This is an environmental test designed to measure the moisture resistance of plastic encapsulated devices. A bias is applied to create an electrolytic cell necessary to accelerate corrosion of the die metallization. With time, this is a catastrophically destructive test.

Typical Test Conditions: $T_A = 85^\circ\text{C}$ to 95°C , $\text{rh} = 85\%$ to 95% , Bias = 80% to 100% of Data Book max. rating, $t = 96$ to 1750 hours

Common Failure Modes: Parametric shifts, high leakage and/or catastrophic

Common Failure Mechanisms: Die corrosion or contaminants such as foreign material on or within the package materials. Poor package sealing.

HIGH TEMPERATURE GATE BIAS (HTGB)

This test is designed to electrically stress the gate oxide under a bias condition at high temperature.

Typical Test Conditions: $T_A = 150^\circ\text{C}$, Bias = 80% of Data Book max. rating, $t = 120$ to 1000 hours

Common Failure Modes: Parametric shifts in gate leakage and gate threshold voltage

Common Failure Mechanisms: Random oxide defects and ionic contamination

Military Reference: MIL-STD-750, Method 1042

HIGH TEMPERATURE REVERSE BIAS (HTRB)

The purpose of this test is to align mobile ions by means of temperature and voltage stress to form a high-current leakage path between two or more junctions.

Typical Test Conditions: $T_A = 85^\circ\text{C}$ to 150°C , Bias = 80% to 100% of Data Book max. rating, $t = 120$ to 1000 hours

Common Failure Modes: Parametric shifts in leakage and gain

Common Failure Mechanisms: Ionic contamination on the surface or under the metallization of the die

Military Reference: MIL-STD-750, Method 1039

HIGH TEMPERATURE STORAGE LIFE (HTSL)

High temperature storage life testing is performed to accelerate failure mechanisms which are thermally activated through the application of extreme temperatures

Typical Test Conditions: $T_A = 70^\circ\text{C}$ to 200°C , no bias, $t = 24$ to 2500 hours

Common Failure Modes: Parametric shifts in leakage and gain

Common Failure Mechanisms: Bulk die and diffusion defects

Military Reference: MIL-STD-750, Method 1032

INTERMITTENT OPERATING LIFE (IOL)

The purpose of this test is the same as SSOL in addition to checking the integrity of both wire and die bonds by means of thermal stressing

Typical Test Conditions: $T_A = 25^\circ\text{C}$, $P_d =$ Data Book maximum rating, $T_{\text{ON}} = T_{\text{OFF}} = \Delta$ of 50°C to 100°C , $t = 42$ to 30000 cycles

Common Failure Modes: Parametric shifts and catastrophic

Common Failure Mechanisms: Foreign material, crack and bulk die defects, metallization, wire and die bond defects

Military Reference: MIL-STD-750, Method 1037

MECHANICAL SHOCK

This test is used to determine the ability of the device to withstand a sudden change in mechanical stress due to abrupt changes in motion as seen in handling, transportation, or actual use.

Typical Test Conditions: Acceleration = 1500 g's, Orientation = X_1, Y_1, Y_2 plane, $t = 0.5$ msec, Blows = 5

Common Failure Modes: Open, short, excessive leakage, mechanical failure

Common Failure Mechanisms: Die and wire bonds, cracked die, package defects

Military Reference: MIL-STD-750, Method 2015

MOISTURE RESISTANCE

The purpose of this test is to evaluate the moisture resistance of components under temperature/humidity conditions typical of tropical environments.

Typical Test Conditions: $T_A = -10^\circ\text{C}$ to 65°C , $rh = 80\%$ to 98% , $t = 24$ hours/cycles, cycle = 10

Common Failure Modes: Parametric shifts in leakage and mechanical failure

Common Failure Mechanisms: Corrosion or contaminants on or within the package materials. Poor package sealing

Military Reference: MIL-STD-750, Method 1021

SOLDERABILITY

The purpose of this test is to measure the ability of the device leads/terminals to be soldered after an extended period of storage (shelf life).

Typical Test Conditions: Steam aging = 8 hours, Flux = R, Solder = Sn60, Sn63

Common Failure Modes: Pin holes, dewetting, nonwetting

Common Failure Mechanisms: Poor plating, contaminated leads

Military Reference: MIL-STD-750, Method 2026

SOLDER HEAT

This test is used to measure the ability of a device to withstand the temperatures as may be seen in wave soldering operations. Electrical testing is the endpoint criterion for this stress.

Typical Test Conditions: Solder Temperature = 260°C , $t = 10$ seconds

Common Failure Modes: Parameter shifts, mechanical failure

Common Failure Mechanisms: Poor package design

Military Reference: MIL-STD-750, Method 2031

STEADY STATE OPERATING LIFE (SSOL)

The purpose of this test is to evaluate the bulk stability of the die and to generate defects resulting from manufacturing aberrations that are manifested as time and stress-dependent failures.

Typical Test Conditions: $T_A = 25^\circ\text{C}$, $P_D =$ Data Book maximum rating, $t = 16$ to 1000 hours

Common Failure Modes: Parametric shifts and catastrophic

Common Failure Mechanisms: Foreign material, crack die, bulk die, metallization, wire and die bond defects

Military Reference: MIL-STD-750, Method 1026

TEMPERATURE CYCLING (AIR TO AIR)

The purpose of this test is to evaluate the ability of the device to withstand both exposure to extreme temperatures and transitions between temperature extremes. This testing will also expose excessive thermal mismatch between materials.

Typical Test Conditions: $T_A = -65^\circ\text{C}$ to 200°C , cycle = 10 to 4000

Common Failure Modes: Parametric shifts and catastrophic

Common Failure Mechanisms: Wire bond, cracked or lifted die and package failure

Military Reference: MIL-STD-750, Method 1051

THERMAL SHOCK (LIQUID TO LIQUID)

The purpose of this test is to evaluate the ability of the device to withstand both exposure to extreme temperatures and sudden transitions between temperature extremes. This testing will also expose excessive thermal mismatch between materials.

Typical Test Conditions: $T_A = 0^\circ\text{C}$ to 100°C , cycle = 20 to 300

Common Failure Modes: Parametric shifts and catastrophic

Common Failure Mechanisms: Wire bond, cracked or lifted die and package failure

Military Reference: MIL-STD-750, Method 1056

VARIABLE FREQUENCY VIBRATION

This test is used to examine the ability of the device to withstand deterioration due to mechanical resonance.

Typical Test Conditions: Peak acceleration = 20 g's, Frequency range = 20 Hz to KHz, $t = 48$ minutes

Common Failure Modes: Open, short, excessive leakage, mechanical failure

Common Failure Mechanisms: Die and wire bonds, cracked die, package defects

Military Reference: MIL-STD-750, Method 2056

STATISTICAL PROCESS CONTROL

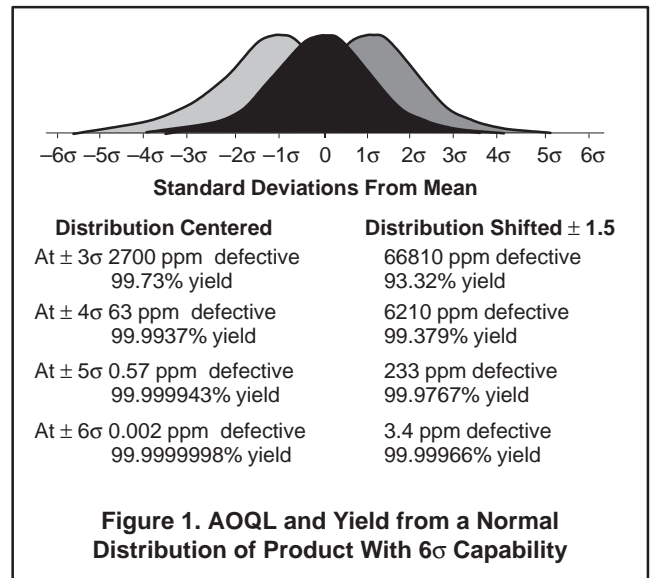
Communication Power & Signal Technologies Group (CPSTG) is continually pursuing new ways to improve product quality. Initial design improvement is one method that can be used to produce a superior product. Equally important to outgoing product quality is the ability to produce product that consistently conforms to specification. Process variability is the basic enemy of semiconductor manufacturing since it leads to product variability. Used in all phases of Motorola's product manufacturing, STATISTICAL PROCESS CONTROL (SPC) replaces variability with predictability. The traditional philosophy in the semiconductor industry has been adherence to the data sheet specification. Using SPC methods ensures that the product will meet specific process requirements throughout the manufacturing cycle. The emphasis is on defect prevention, not detection. Predictability through SPC methods requires the manufacturing culture to focus on constant and permanent improvements. Usually, these improvements cannot be bought with state-of-the-art equipment or automated factories. With quality in design, process, and material selection, coupled with manufacturing predictability, Motorola can produce world class products.

The immediate effect of SPC manufacturing is predictability through process controls. Product centered and distributed well within the product specification benefits Motorola with fewer rejects, improved yields, and lower cost. The direct benefit to Motorola's customers includes better incoming quality levels, less inspection time, and ship-to-stock capability. Circuit performance is often dependent on the cumulative effect of component variability. Tightly controlled component distributions give the customer greater circuit predictability. Many customers are also converting to just-in-time (JIT) delivery programs. These programs require improvements in cycle time and yield predictability achievable only through SPC techniques. The benefit derived from SPC helps the manufacturer meet the customer's expectations of higher quality and lower cost product.

Ultimately, Motorola will have Six Sigma capability on all products. This means parametric distributions will be centered within the specification limits, with a product distribution of plus or minus Six Sigma about mean. Six Sigma capability, shown graphically in Figure 1, details the benefit in terms of yield and outgoing quality levels. This compares a centered distribution versus a 1.5 sigma worst case distribution shift.

New product development at Motorola requires more robust design features that make them less sensitive to minor variations in processing. These features make the implementation of SPC much easier.

A complete commitment to SPC is present throughout Motorola. All managers, engineers, production operators, supervisors, and maintenance personnel have received multiple training courses on SPC techniques. Manufacturing has identified 22 wafer processing and 8 assembly steps considered critical to the processing of semiconductor products. Processes controlled by SPC methods that have shown significant improvement are in the diffusion, photolithography, and metallization areas.



To better understand SPC principles, brief explanations have been provided. These cover process capability, implementation, and use.

PROCESS CAPABILITY

One goal of SPC is to ensure a process is **CAPABLE**. Process capability is the measurement of a process to produce products consistently to specification requirements. The purpose of a process capability study is to separate the inherent **RANDOM VARIABILITY** from **ASSIGNABLE CAUSES**. Once completed, steps are taken to identify and eliminate the most significant assignable causes. Random variability is generally present in the system and does not fluctuate. Sometimes, the random variability is due to basic limitations associated with the machinery, materials, personnel skills, or manufacturing methods. Assignable cause inconsistencies relate to time variations in yield, performance, or reliability.

Traditionally, assignable causes appear to be random due to the lack of close examination or analysis. Figure 2 shows the impact on predictability that assignable cause can have. Figure 3 shows the difference between process control and process capability.

A process capability study involves taking periodic samples from the process under controlled conditions. The performance characteristics of these samples are charted against time. In time, assignable causes can be identified and engineered out. Careful documentation of the process is the key to accurate diagnosis and successful removal of the assignable causes. Sometimes, the assignable causes will remain unclear, requiring prolonged experimentation.

Elements which measure process variation control and capability are C_p and C_{pk} , respectively. C_p is the specification width divided by the process width or $C_p = (\text{specification width}) / 6\sigma$. C_{pk} is the absolute value of the closest specification value to the mean, minus the mean, divided by half the process width or $C_{pk} = |\text{closest specification} - \bar{x}| / 3\sigma$.

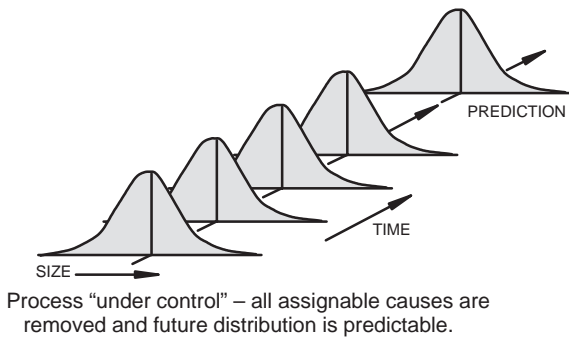


Figure 2. Impact of Assignable Causes on Process Predictable

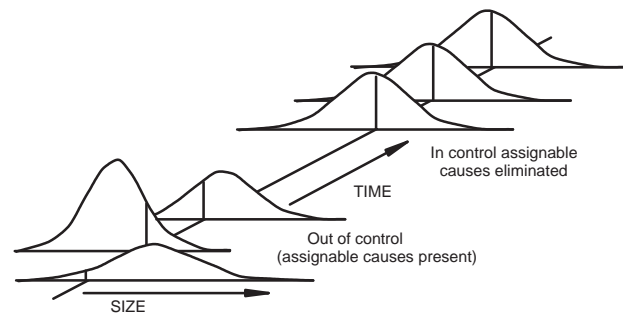


Figure 3. Difference Between Process Control and Process Capability

At Motorola, for critical parameters, the process capability is acceptable with a $Cpk = 1.50$ with continual improvement our goal. The desired process capability is a $Cpk = 2$ and the ideal is a $Cpk = 5$. Cpk , by definition, shows where the current production process fits with relationship to the specification limits. Off center distributions or excessive process variability will result in less than optimum conditions.

SPC IMPLEMENTATION AND USE

CPSTG uses many parameters that show conformance to specification. Some parameters are sensitive to process variations while others remain constant for a given product line. Often, specific parameters are influenced when changes to other parameters occur. It is both impractical and unnecessary to monitor all parameters using SPC methods. Only critical parameters that are sensitive to process variability are chosen for SPC monitoring. The process steps affecting these critical parameters must be identified as well. It is equally important to find a measurement in these process steps that correlates with product performance. This measurement is called a critical process parameter.

Once the critical process parameters are selected, a sample plan must be determined. The samples used for measurement are organized into **RATIONAL SUBGROUPS** of approximately two to five pieces. The subgroup size should be such that variation among the samples within the subgroup remain small. All samples must come from the same source e.g., the same mold press operator, etc. Subgroup data should

be collected at appropriate time intervals to detect variations in the process. As the process begins to show improved stability, the interval may be increased. The data collected must be carefully documented and maintained for later correlation. Examples of common documentation entries are operator, machine, time, settings, product type, etc.

Once the plan is established, data collection may begin. The data collected will generate \bar{X} and R values that are plotted with respect to time. \bar{X} refers to the mean of the values within a given subgroup, while R is the range or greatest value minus least value. When approximately 20 or more \bar{X} and R values have been generated, the average of these values is computed as follows:

$$\bar{\bar{X}} = (\bar{X}_1 + \bar{X}_2 + \bar{X}_3 + \dots) / K$$

$$\bar{R} = (R_1 + R_2 + R_3 + \dots) / K$$

where K = the number of subgroups measured.

The values of \bar{X} and R are used to create the process control chart. Control charts are the primary SPC tool used to signal a problem. Shown in Figure 4, process control charts show \bar{X} and R values with respect to time and concerning reference to upper and lower control limit values. Control limits are computed as follows:

$$R \text{ upper control limit} = UCLR = D_4 \bar{R}$$

$$R \text{ lower control limit} = LCLR = D_3 \bar{R}$$

$$\bar{X} \text{ upper control limit} = UCL\bar{X} = \bar{\bar{X}} + A_2 \bar{R}$$

$$\bar{X} \text{ lower control limit} = LCL\bar{X} = \bar{\bar{X}} - A_2 \bar{R}$$

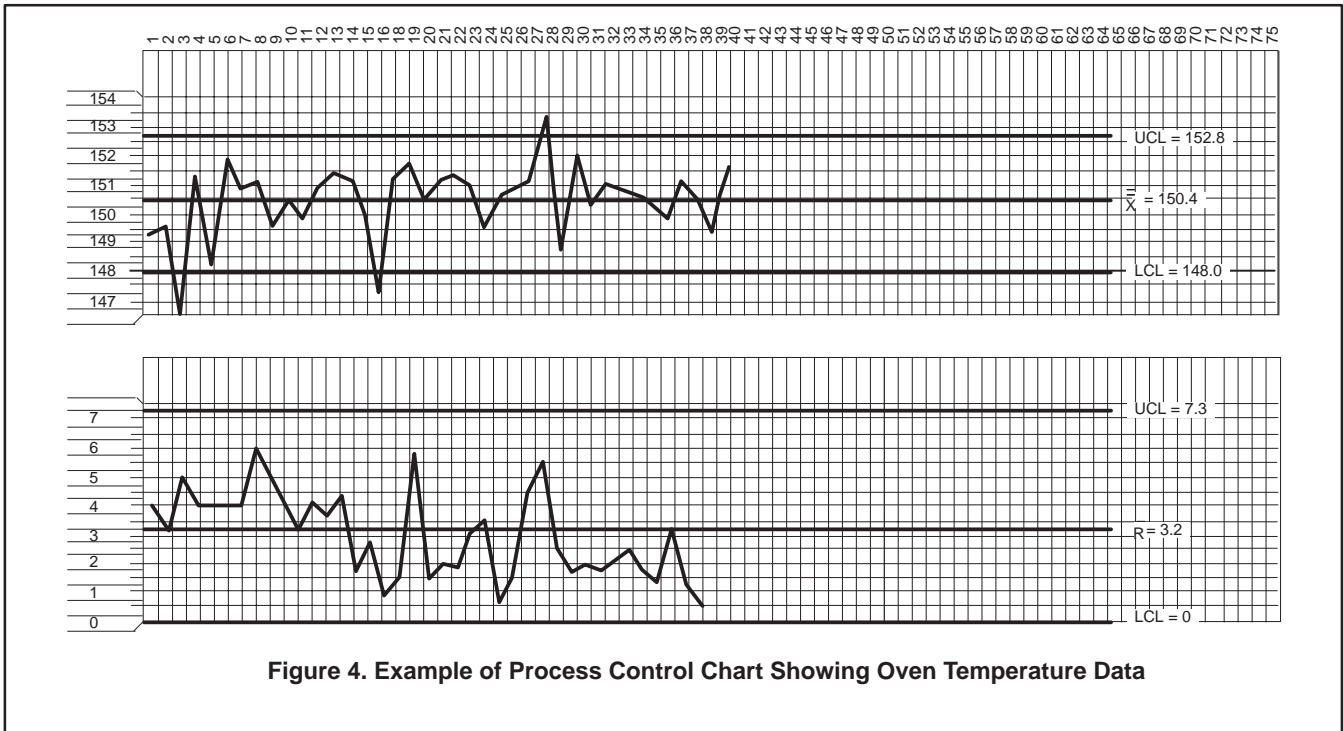


Figure 4. Example of Process Control Chart Showing Oven Temperature Data

Where D_4 , D_3 , and A_2 are constants varying by sample size, with values for sample sizes from 2 to 10 shown in the following partial table:

n	2	3	4	5	6	7	8	9	10
D_4	3.27	2.57	2.28	2.11	2.00	1.92	1.86	1.82	1.78
D_3	*	*	*	*	*	0.08	0.14	0.18	0.22
A_2	1.88	1.02	0.73	0.58	0.48	0.42	0.37	0.34	0.31

*For sample sizes below 7, the LCL_R would technically be a negative number; in those cases there is no lower control limit; this means that for a subgroup size 6, six "identical" measurements would not be unreasonable.

Control charts are used to monitor the variability of critical process parameters. The R chart shows basic problems with piece to piece variability related to the process. The X chart can often identify changes in people, machines, methods, etc. The source of the variability can be difficult to find and may require experimental design techniques to identify assignable causes.

Some general rules have been established to help determine when a process is **OUT-OF-CONTROL**. Figure 5 shows a control chart subdivided into zones A, B, and C corresponding to 3 sigma, 2 sigma, and 1 sigma limits respectively. In Figures 6 through 9 four of the tests that can be used to identify excessive variability and the presence of assignable causes are shown. As familiarity with a given process increases, more subtle tests may be employed successfully.

Once the variability is identified, the cause of the variability must be determined. Normally, only a few factors have a significant impact on the total variability of the process. The importance of correctly identifying these factors is stressed in the following example. Suppose a process variability depends on the variance of five factors A, B, C, D, and E. Each has a variance of 5, 3, 2, 1, and 0.4, respectively.

Since:

$$\sigma_{tot} = \sqrt{\sigma_A^2 + \sigma_B^2 + \sigma_C^2 + \sigma_D^2 + \sigma_E^2}$$

$$\sigma_{tot} = \sqrt{5^2 + 3^2 + 2^2 + 1^2 + (0.4)^2} = 6.3$$

If only D is identified and eliminated, then:

$$\sigma_{tot} = \sqrt{5^2 + 3^2 + 2^2 + (0.4)^2} = 6.2$$

This results in less than 2% total variability improvement. If B, C, and D were eliminated, then:

$$\sigma_{tot} = \sqrt{5^2 + (0.4)^2} = 5.02$$

This gives a considerably better improvement of 23%. If only A is identified and reduced from 5 to 2, then:

$$\sigma_{tot} = \sqrt{2^2 + 3^2 + 2^2 + 1^2 + (0.4)^2} = 4.3$$

Identifying and improving the variability from 5 to 2 yields a total variability improvement of nearly 40%.

Most techniques may be employed to identify the primary assignable cause(s). Out-of-control conditions may be correlated to documented process changes. The product may be analyzed in detail using best versus worst part comparisons or Product Analysis Lab equipment. Multi-variance analysis can be used to determine the family of variation (positional, critical, or temporal). Lastly, experiments may be run to test theoretical or factorial analysis. Whatever method is used, assignable causes must be identified and eliminated in the most expeditious manner possible.

After assignable causes have been eliminated, new control limits are calculated to provide a more challenging variability criteria for the process. As yields and variability improve, it may become more difficult to detect improvements because they become much smaller. When all assignable causes have been eliminated and the points remain within control limits for 25 groups, the process is said to be in a state of control.

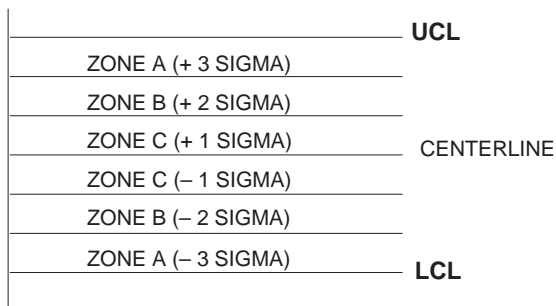


Figure 5. Control Chart Zones

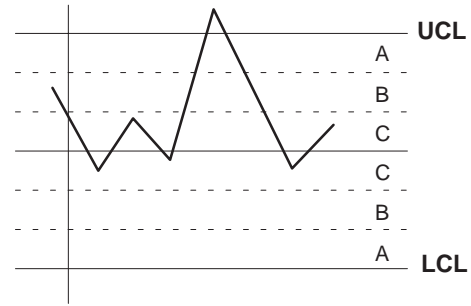


Figure 6. One Point Outside Control Limit Indicating Excessive Variability

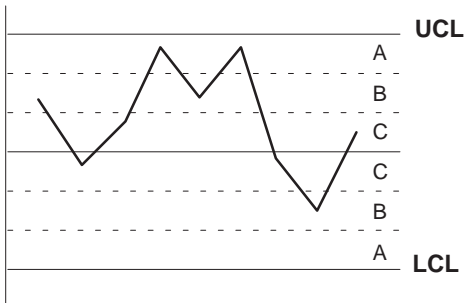


Figure 7. Two Out of Three Points in Zone A or Beyond Indicating Excessive Variability

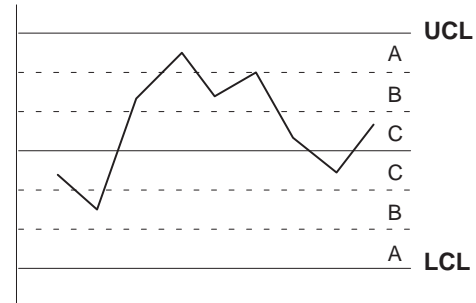


Figure 8. Four Out of Five Points in Zone B or Beyond Indicating Excessive Variability

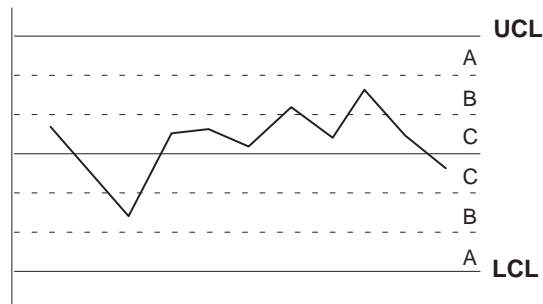


Figure 9. Seven Out of Eight Points in Zone C or Beyond Indicating Excessive Variability

SUMMARY

Motorola is committed to the use of STATISTICAL PROCESS CONTROLS. These principles, used throughout manufacturing have already resulted in many significant improvements to the processes. Continued dedication to the

SPC culture will allow Motorola to reach the Six Sigma and zero defect capability goals. SPC will further enhance the commitment to **TOTAL CUSTOMER SATISFACTION**.

Section 10

Replacement Devices

In Brief . . .

The Replacement Devices index provides you with a list of devices which had been supported with data sheets in the prior edition of the *Small-Signal Transistors, FETs and Diodes* data book (DL126 Rev 5) but are no longer supported in this new edition. A direct or similar replacement part is listed for those devices which have replacement parts.

REPLACEMENT DEVICES

DEVICE	REPLACEMENT	DEVICE	REPLACEMENT	DEVICE	REPLACEMENT
1N5139	MV2101	2N3053A	MPSA05	BC560B	BC560C
1N5139A	MV2101	2N3244	2N4403	BC849ALT1	BC848ALT1
1N5140	MMBV2103LT1	2N3250	2N4403	BC850ALT1	BC848ALT1
1N5140A	MMBV2103LT1	2N3251	MPS2907A	BC857CLT1	BC857ALT1
1N5141	MMBV2104LT1	2N3251A	MPS2907A	BCY70	MPS2222A
1N5141A	MMBV2104LT1	2N3467	MPSA56	BCY71	MPS2222A
1N5142	MMBV2105LT1	2N3468	MPSA56	BCY72	MPS2222A
1N5142A	MMBV2105LT1	2N3497	2N5401	BDB01D	BDB01C
1N5143	MMBV2105LT1	2N3500	2N5551	BDB02D	BDB02C
1N5143A	MMBV2105LT1	2N3501	2N5551	BDC02D	BDC01D
1N5144	MMBV2107LT1	2N3546	MPSH17	BDC05	MPSW42
1N5144A	MMBV2107LT1	2N3634	2N5401	BF244A	2N3819
1N5145	MMBV2108LT1	2N3635	2N5401	BF244B	2N3819
1N5145A	MMBV2108LT1	2N3636	MPSA92	BF245	BF245A
1N5146	MMBV2109LT1	2N3637	MPSA92	BF245A	BF245A
1N5146A	MV2109	2N3700	MPSA06	BF245B	BF245A
1N5147	MV2111	2N3799	MPSA18	BF245C	BF245A
1N5147A	MV2111	2N3947	MPS2222A	BF246A	BF245A
1N5441A	MV2101	2N3963	MPSA18	BF246B	BF245A
1N5443A	MV2103	2N3964	MPSA18	BF247B	BF245A
1N5444A	MV2104	2N4014	MPS2222A	BF256B	BF256A
1N5445A	MV2105	2N4032	MPS2907A	BF256C	BF256A
1N5449A	MV2108	2N4033	MPSA56	BF258	BF422
1N5450A	MV2109	2N4036	MPSA56	BF374	BC338
1N5451A	MV2111	2N4037	MPSA56	BF391	MPSA42
1N5452A	MV2111	2N4126	MPS4126	BF392	MPSA42
1N5453A	MV2111	2N4265	2N4264	BF492	MPSA92
1N5455A	MV2115	2N4405	MPS8599	BF493	MPSA92
2N697	MPSA20	2N4407	MPS8599	BFW43	2N5401
2N718A	MPSA05	2N4931	MPSA92	BSP20AT1	BF720T1
2N720A	MPSA06	2N5086	2N5087	BSS71	MPSA42
2N930	MPSA18	2N5668	2N3819	BSS72	MPSA42
2N930A	MPSA18	2N5669	2N3819	BSS73	MPSA42
2N956	MPSA05	2N5670	2N3819	BSS74	MPSA92
2N1613	2N4410	2N6431	MPSA42	BSS75	MPSA92
2N1711	MPSA05	2N6433	MPSA92	BSS76	MPSA92
2N1893	MPSA06	2N6516	2N6517	BSS89	BS107
2N2102	2N4410	BA582T1	MMBV3401LT1	BSV16-10	MPS2907A
2N2218A	MPS2222A	BC107	BC237	BSX20	MPS2369A
2N2219	MPS2222A	BC107A	BC237	CV12253	MPSA06
2N2219A	MPS2222A	BC107B	BC237	IRFD110	BSS123LT1
2N2222	MPS2222	BC108		IRFD113	MMBF170LT1
2N2222A	MPS2222A	BC109C	BC3338	IRFD120	BSS123LT1
2N2270	MPSA05	BC140-10	MPSW06	IRFD123	MMBF170LT1
2N2369	MPS2369	BC140-16	MPSW06	IRFD210	MMFT107T1
2N2369A	MPS2369A	BC141-10	MPSW06	IRFD213	MMFT107T1
2N2484	2N5087	BC141-16	MPSW06	IRFD220	MMFT107T1
2N2895	MPSA06	BC160-16	MPSW56	IRFD223	MMFT107T1
2N2896	2N5551	BC161-16	MPSW56	IRFD9120	BSS123LT1
2N2904	MPS2907	BC177	BC547	IRFD9123	2N7002LT1
2N2904A	MPS2907A	BC177A	BC547A	J111	J111RLRA
2N2905	MPS2907	BC177B	BC547B	J113	J113RL1
2N2905A	MPS2907A	BC238	BC238B	J203	2N5458
2N2906	MPS2907	BC309B	BC308C	J300	2N5486
2N2906A	MPS2907A	BC393	MPSA92	J305	MMBF5484LT1
2N2907	MPS2907	BC394	MPSA42	MAD130P	BAS16LT1
2N2907A	MPS2907A	BC450	MPSA92	MAD1103P	BAS16LT1
2N3019	MPSA06	BC450A	MPSA92	MAD1107P	BAS16LT1
2N3020	MPSA06	BC546A	BC546B	MAD1108P	BAS16LT1
2N3053	MPSA20	BC559	BC559B	MAD1109P	BAS16LT1

REPLACEMENT DEVICES

DEVICE	REPLACEMENT	DEVICE	REPLACEMENT	DEVICE	REPLACEMENT
MM3001	2N5551	MPS6530	MPS6530RLRM	MV2114	MV2115
MM3725	MPS2222A	MPS6531	MPS6530RLRM	MVAM108	MMBV2109LT1
MM4001	2N5401	MPS6562	MPS6651	MVAM109	MMBV2109LT1
MMAD1106	BAS16LT1	MPS6568A	MPS918	MVAM115	MMBV2109LT1
MMBF4856LT1	MMBF4391LT1	MPS6571	MPSA18	MVAM125	MMBV2109LT1
MMBF4860LT1	MMBF5457LT1	MPS6595	MPS3563	PBF259	MMBT6517LT1
MMBF5459LT1	MMBF5457LT1	MPS8093	2N4402	PBF259S	MMBT6517LT1
MMBF5486LT1	2N5486	MPSA16	MPSA17	PBF259RS	MMBT6517LT1
MMBT8599LT1	MMBT5551LT1	MPSH04	MPSH17	PBF493	MMBTA92LT1
MMBV2104LT1	MMBV2103LT1	MPSH07A	MPSH17	PBF493R	MMBTA92LT1
MMPQ3799	MMPQ3725	MPSH20	MPSH17	PBF493RS	MMBTA92LT1
MMSV3401T1	MMBV3401LT1	MPSH24	MPSH17	PBF493S	MMBTA92LT1
MPF970	MMBFJ175LT1	MPSH34	MPSH17	VN1706L	MMFT107T1
MPF971	MMBFJ175LT1	MPSH69	MPSH81		
MPF3821	MMBF5457LT1	MSA1022-BT1	MSA1022-CT1		
MPF3822	MMBF5457LT1	MSB709-ST1	MSB709-RT1		
MPF4856	MPF4391RLRA	MSB710-QT1	MSB710-RT1		
MPF4857	2N5639	MSB1218A-ST1	MSB1218A-RT1		
MPF4858	J112	MSC1621T1	MSD602-RT1		
MPF4859	2N5638RLRA	MSC2404-CT1	MSC2295-CT1		
MPF4860	2N5638RLRA	MSD1819A-ST1	MSD1819A-RT1		
MPF4861	J112	MV1620	MV2101		
MPQ6501	MPQ6502	MV1624	MMBV2103LT1		
MPS3638	MPS3638A	MV1636	MV2108		
MPS3866	BF224	MV1640	MV2109		
MPS4123	MPS4124	MV1642	MV2111		
MPS4125	MPS4126	MV1644	MV2111		
MPS4258	MPS3640	MV2103	MMBV2103LT1		
MPS5771	MPS3640	MV2107	MV2108		
MPS6520	MPS6521	MV2113	MV2111		

Section 11

Alphanumeric Index

Alphanumeric Index

Device	Page	Device	Page	Device	Page
1N5148	1-23, 1-24, 5-3	BAT54LT1	1-30, 5-27	BC517	1-4, 2-111
1N5148A	5-3	BAT54SLT1	1-30, 5-29	BC546	1-2, 2-116
1N5446ARL	1-24, 5-6	BAT54SWT1	1-30, 5-31	BC546B	1-2, 2-116
1N5448ARL	1-24, 5-6	BAT54T1	1-30, 5-33	BC547	1-2, 2-116
1N5456A	1-23, 1-24, 5-6	BAT54WT1	1-30, 5-35	BC547A	1-2, 2-116
2N3903	1-2, 2-3	BAV70LT1	1-33, 5-37	BC547B	1-2, 2-116
2N3904	1-2, 2-3	BAV70WT1	1-33, 5-39	BC547C	1-2, 2-116
2N3905	1-2, 2-9	BAV74LT1	1-33, 5-42	BC548	1-2, 2-116
2N3906	1-2, 2-9	BAV99LT1	1-33, 5-44	BC548A	1-2, 2-116
2N4123	1-2, 2-14	BAV99RWT1	1-33, 5-47	BC548B	1-2, 2-116
2N4124	1-2, 2-14	BAV99WT1	1-33, 5-47	BC548C	1-2, 2-116
2N4125	1-2, 2-18	BAV170LT1	1-34, 5-50	BC549B	1-3, 2-120
2N4264	1-6, 2-22	BAV199LT1	1-34, 5-52	BC549C	1-3, 2-120
2N4400	1-2, 2-27	BAW56LT1	1-33, 5-54	BC550B	1-3, 2-120
2N4401	1-2, 2-27	BAW56WT1	1-33, 5-56	BC550C	1-3, 2-120
2N4402	1-2, 2-32	BAW156LT1	1-34, 5-58	BC556	1-2, 2-123
2N4403	1-2, 2-32	BC182	1-2, 2-79	BC556B	1-2, 2-123
2N4410	1-2, 2-37	BC182A	2-79	BC557	1-2, 2-123
2N5087	1-3, 2-41	BC182B	2-79	BC557A	1-2, 2-123
2N5088	1-3, 2-47	BC183	2-79	BC557B	1-2, 2-123
2N5089	1-3, 2-47	BC184	2-79	BC557C	1-2, 2-123
2N5209	2-51	BC212	1-2, 2-82	BC558B	1-2, 2-123
2N5210	2-51	BC212B	2-82	BC559B	1-3, 2-128
2N5400	2-55	BC213	2-82	BC559C	1-3, 2-128
2N5401	1-5, 2-55	BC214	2-82	BC560C	1-3, 2-128
2N5457	1-18, 4-110	BC237	2-85	BC618	1-4, 2-131
2N5458	1-18	BC237A	2-85	BC635	2-136
2N5460	1-18, 4-113	BC237B	1-2, 2-85	BC636	2-139
2N5461	1-18, 4-113	BC237C	2-85	BC637	2-136
2N5462	1-18, 4-113	BC238B	2-85	BC638	2-139
2N5484	1-18, 4-116	BC238C	2-85	BC639	1-4, 2-136
2N5485	1-18	BC239	1-3, 2-85	BC640	1-4, 2-139
2N5486	1-18, 4-116	BC239C	2-85	BC807-16LT1	1-10, 2-142
2N5550	2-59	BC307	2-88	BC807-25LT1	1-10, 2-142
2N5551	1-5, 2-59	BC307B	1-2, 2-88	BC807-40LT1	1-10, 2-142
2N5555	1-19, 4-123	BC307C	2-88	BC808-25WT1	1-11
2N5639	1-19	BC308C	2-88	BC808-40WT1	1-11
2N5640	1-19, 4-130	BC327	1-2, 2-91	BC817-16LT1	1-10, 2-144
2N6426	1-4, 2-64	BC327-16	2-91	BC817-25LT1	1-10, 2-144
2N6427	1-4, 2-64	BC327-25	2-91	BC817-40LT1	1-10, 2-144
2N6515	2-69	BC328	1-2, 2-91	BC818-25WT1	1-11
2N6517	1-5, 2-69	BC328-16	2-91	BC818-40WT1	1-11
2N6519	1-5, 2-69	BC328-25	2-91	BC818WT1	1-11
2N6520	1-5, 2-69	BC337	1-2, 2-94	BC846ALT1	1-10, 2-146
2N7000	1-20, 4-3	BC337-16	2-94	BC846AWT1	1-11, 2-150
2N7002LT1	1-22, 1-37, 4-5	BC337-25	2-94	BC846BLT1	1-10, 2-146
2N7008	1-20	BC337-40	2-94	BC846BWT1	1-11, 2-150
2SA1774	1-12, 2-75	BC338	1-2, 2-94	BC847ALT1	1-10, 2-146
2SC4617	1-12, 2-77	BC338-16	2-94	BC847AWT1	1-11, 2-150
BAL99LT1	1-32, 5-9	BC338-25	2-94	BC847BLT1	1-10, 2-146
BAS16LT1	1-32, 5-11	BC338-40	2-94	BC847BWT1	1-11, 2-150
BAS16WT1	1-32, 5-13	BC368	1-4, 2-97	BC847CLT1	1-10, 2-146
BAS21LT1	1-32, 5-16	BC369	1-4, 2-97	BC847CWT1	1-11, 2-150
BAS40-04LT1	1-30, 5-19	BC372	2-99	BC848ALT1	1-10, 2-146
BAS40-06LT1	1-30, 5-20	BC373	1-4, 2-99	BC848AWT1	1-11, 2-150
BAS40LT1	1-30, 5-18	BC489	1-4, 2-101	BC848BLT1	1-10, 2-146
BAS70-04LT1	1-30, 5-22	BC489A	2-101	BC848BWT1	1-11, 2-150
BAS70LT1	1-30, 5-21	BC489B	2-101	BC848CLT1	1-10, 2-146
BAS116LT1	1-33, 5-23	BC490	1-4, 2-106	BC848CWT1	1-11, 2-150
BAT54ALT1	1-30, 5-25	BC490A	2-106	BC849BLT1	2-146

Alphanumeric Index

Device	Page	Device	Page	Device	Page
BC849CLT1	2-146	BS107	1-20, 4-8	MGSF1P02ELT11-22, 1-37, 3-15, 4-28	
BC850BLT1	2-146	BS107A	1-20, 4-8	MGSF1P02LT1	1-22, 1-37, 3-17, 4-30
BC850CLT1	2-146	BS170	1-20, 4-11	MGSF3441VT1	1-37, 3-20, 4-33
BC856ALT1	1-10, 2-154	BSP16T1	1-17, 2-264	MGSF3441XT1	1-37, 3-24, 4-37
BC856AWT1	1-11, 2-159	BSP19AT1	1-17, 2-266	MGSF3442VT1	1-37, 3-26, 4-39
BC856BLT1	1-10, 2-154	BSP52T1	1-17, 2-268	MGSF3442XT1	1-37, 3-30, 4-43
BC856BWT1	1-11, 2-159	BSP62T1	1-17, 2-270	MGSF3454VT1	1-37, 3-32, 4-45
BC857ALT1	1-10, 2-154	BSS63LT1	1-16, 2-273	MGSF3454XT1	1-37, 3-36, 4-49
BC857AWT1	1-11, 2-159	BSS64LT1	1-16, 2-275	MGSF3455VT1	1-37, 3-40, 4-53
BC857BLT1	1-10, 2-154	BSS84LT1	1-22, 1-37, 3-2, 4-13	MGSF3455XT1	1-37, 3-44, 4-57
BC857BWT1	1-11, 2-159	BSS123LT1	1-22, 1-37, 4-16	MMAD130	1-35, 5-93
BC858ALT1	1-10, 2-154	BSS138LT1	1-22, 1-37, 3-5, 4-18	MMAD1103	1-35, 5-93
BC858AWT1	1-11, 2-159	BSV52LT1	1-14, 2-277	MMAD1105	1-35, 5-93
BC858BLT1	1-10, 2-154	DAN222	1-33, 5-60	MMAD1106	1-35
BC858BWT1	1-11, 2-159	DAP222	1-33, 5-62	MMAD1107	1-35, 5-93
BC858CLT1	1-10, 2-154	DTA114YE	1-13, 2-279	MMAD1108	1-35, 5-96
BC858CWT1	1-11, 2-159	DTA143EE	1-13, 2-281	MMAD1109	1-35, 5-93
BCP53T1	1-16, 2-164	DTC114TE	1-13, 2-282	MMBD101LT1	1-29, 1-30, 5-80
BCP56T1	1-16, 2-166	DTC114YE	1-13, 2-283	MMBD301LT1	1-29, 1-30, 5-87
BCP68T1	1-17, 2-169	J110	1-19	MMBD330T1	1-30
BCP69T1	1-17, 2-172	J112	1-19, 4-138	MMBD352LT1	1-29, 1-30, 5-99
BCW29LT1	2-174	J202	1-18, 4-141	MMBD352WT1	1-30, 5-101
BCW30LT1	2-174	J304	4-144	MMBD353LT1	1-29, 1-30, 5-99
BCW33LT1	2-180	J308	1-18, 4-151	MMBD354LT1	1-29, 1-30, 5-99
BCW60ALT1	2-186	J309	1-18, 4-151	MMBD355LT1	5-99
BCW60BLT1	2-186	J310	1-18, 4-151	MMBD452LT1	5-103
BCW60DLT1	2-186	M1MA141KT1	1-32, 5-64	MMBD701LT1	1-29, 1-30, 5-89
BCW61BLT1	2-192	M1MA141WAT1	1-33, 5-66	MMBD717LT1	5-105
BCW61CLT1	2-192	M1MA141WKT1	1-33, 5-68	MMBD770T1	1-30
BCW61DLT1	2-192	M1MA142KT1	1-32, 5-64	MMBD914LT1	1-32, 5-107
BCW65ALT1	2-198	M1MA142WAT1	1-33, 5-66	MMBD1000LT11-33, 1-37, 3-46, 5-109	
BCW68GLT1	2-200	M1MA142WKT1	1-33, 5-68	MMBD1005LT11-34, 1-37, 3-48, 5-111	
BCW69LT1	2-202	M1MA151AT1	1-32, 5-70	MMBD1010LT11-34, 1-37, 3-50, 5-113	
BCW70LT1	2-202	M1MA151KT1	1-32, 5-72	MMBD2000T1	1-33, 1-37, 3-46, 5-109
BCW72LT1	2-208	M1MA151WAT1	1-33, 5-74	MMBD2005T1	1-34, 1-37, 3-48, 5-111
BCX17LT1	2-214	M1MA151WKT1	1-33, 5-76	MMBD2010T1	1-34, 1-37, 3-50, 5-113
BCX18LT1	2-214	M1MA152AT1	5-70	MMBD2835LT1	1-33, 5-115
BCX19LT1	2-214	M1MA152KT1	5-72	MMBD2836LT1	1-33, 5-115
BCX20LT1	2-214	M1MA152WAT1	5-74	MMBD2837LT1	1-33, 5-117
BCX70GLT1	2-216	M1MA152WKT1	5-76	MMBD2838LT1	1-33, 5-117
BCX70JLT1	2-216	M1MA174T1	1-32	MMBD3000T1	1-33, 1-37, 3-46, 5-109
BCX70KLT1	2-216	MBD54DWT1	5-78	MMBD3005T1	1-34, 1-37, 3-48, 5-111
BDB01C	1-3, 2-222	MBD101	1-29, 1-30, 5-80	MMBD3010T1	1-34, 1-37, 3-50, 5-113
BDB02C	1-3, 2-225	MBD110DWT1	1-30, 5-82	MMBD6050LT1	1-32, 5-119
BDC01D	1-3, 2-228	MBD301	1-29, 1-30, 5-87	MMBD6100LT1	1-33, 5-121
BF199	1-6, 2-231	MBD330DWT1	1-30, 5-82	MMBD7000LT1	1-33, 5-123
BF224	1-6, 2-235	MBD701	1-29, 1-30, 5-89	MMBF170LT1	1-22, 4-59
BF240	2-239	MBD770DWT1	1-30, 5-82	MMBF0201NLT11-22, 1-37, 3-52, 4-61	
BF393	1-5, 2-242	MBF4416DW1T1	1-21	MMBF0202PLT11-22, 1-37, 3-56, 4-65	
BF420	1-5, 2-245	MBF5457DW1T1	1-21	MMBF2201NT1	1-22, 1-37, 3-60, 4-69
BF421	1-5, 2-248	MBT3904DW1T1	1-11, 2-286	MMBF2201PT1	1-22
BF422	1-5, 2-245	MBT3904DW9T1	1-11	MMBF2202PT1	1-37, 3-63, 4-72
BF423	1-5, 2-248	MBT3906DW1T1	1-11, 1-12, 2-286	MMBF4391LT1	1-22, 4-156
BF493S	1-5, 2-251	MBT3906DW9T1	1-11	MMBF4392LT1	1-22, 4-156
BF720T1	1-17, 2-254	MBT3946DW1T1	2-286	MMBF4393LT1	1-22, 4-156
BF721T1	1-17, 2-256	MBV109T1	1-28, 5-91	MMBF4416LT1	1-21, 4-160
BF844	1-5, 2-258	MDC3105LT1	1-38, 2-818	MMBF5457LT1	1-21, 4-167
BF959	1-6, 2-262	MDC5001T1	1-38, 2-823	MMBF5460LT1	1-21, 4-170
BFR30LT1	4-134	MGSF1N02LT1	1-22, 1-37, 3-9, 4-22	MMBF5484LT1	1-21, 4-173
BFR31LT1	4-134	MGSF1N03LT1	1-22, 1-37, 3-12, 4-25	MMBFJ175LT1	1-22, 4-180

Alphanumeric Index

Device	Page	Device	Page	Device	Page
MMBFJ177LT1	1-22, 4-181	MMBV2105LT1	1-23, 1-25, 5-135	MPN3404	1-31, 1-32, 5-149
MMBFJ309LT1	1-21, 4-182	MMBV2107LT1	1-25, 5-135	MPN3700	1-31, 1-32, 5-142
MMBFJ310LT1	1-21, 4-182	MMBV2108LT1	1-25, 5-135	MPQ2222	2-460
MMBFU310LT1	1-21, 4-186	MMBV2109LT1	1-23, 1-25, 5-135	MPQ2222A	1-9, 2-460
MMBT404ALT1	1-15, 2-296	MMBV3102LT1	1-27, 1-28, 5-138	MPQ2369	1-9, 2-465
MMBT918LT1	1-14, 2-298	MMBV3401LT1	1-31, 1-32, 5-140	MPQ2483	1-9, 2-469
MMBT1010LT1	1-16, 1-36, 2-300, 3-67	MMBV3700LT1	1-31, 1-32, 5-142	MPQ2484	1-9, 2-469
MMBT2222ALT1	1-10, 2-303	MMFT107T1	1-22, 4-76	MPQ2906	2-471
MMBT2222AWT1	1-11, 2-301	MMFT960T1	1-22, 4-79	MPQ2907	2-471
MMBT2222LT1	2-303	MMFT2406T1	1-22, 4-82	MPQ2907A	1-9, 2-471
MMBT2369ALT1	1-14, 2-308	MMFT6661T1	1-22, 4-84	MPQ3467	1-9, 2-476
MMBT2369LT1	1-14, 2-308	MMPQ2222	2-428	MPQ3725	1-9, 2-479
MMBT2484LT1	1-15, 2-313	MMPQ2222A	1-9, 2-428	MPQ3762	1-9, 2-483
MMBT2907ALT1	1-10, 2-319	MMPQ2369	1-9, 2-430	MPQ3798	1-9, 2-486
MMBT2907AWT1	1-11, 2-317	MMPQ2907	2-432	MPQ3799	1-9, 2-486
MMBT2907LT1	2-319	MMPQ2907A	1-9, 2-432	MPQ3904	1-9, 2-489
MMBT3640LT1	1-14, 2-323	MMPQ3467	1-9, 2-434	MPQ3906	1-9, 2-495
MMBT3904LT1	1-10, 2-326	MMPQ3725	1-9, 2-436	MPQ6001	1-9, 2-500
MMBT3904WT1	1-11, 2-332	MMPQ3904	1-9, 2-438	MPQ6002	1-9, 2-500
MMBT3906LT1	1-10, 2-341	MMPQ3906	1-9, 2-440	MPQ6100A	1-9, 2-503
MMBT3906WT1	1-11, 2-332	MMPQ6700	1-9, 2-442	MPQ6426	1-9, 2-506
MMBT4401LT1	1-10, 2-346	MMPQ6842	2-443	MPQ6502	1-9, 2-500
MMBT4403LT1	1-10, 2-351	MMSD71RKT1	1-32	MPQ6600A1	1-9, 2-503
MMBT5087LT1	1-15, 2-356	MMSD101T1	1-30	MPQ6700	1-9, 2-509
MMBT5088LT1	2-362	MMSD301T1	1-30, 5-144	MPQ6842	1-9, 2-514
MMBT5089LT1	1-15, 2-362	MMSD701T1	1-30, 5-144	MPQ7041	2-518
MMBT5401LT1	1-16, 2-366	MMSD914T1	1-32, 5-147	MPQ7042	1-9, 2-518
MMBT5550LT1	2-370	MMSD1000T1	1-33, 1-37, 3-46, 5-109	MPQ7043	1-9, 2-518
MMBT5551LT1	1-16, 2-370	MMUN2111LT1	1-12, 2-445	MPQ7051	1-9, 2-520
MMBT6427LT1	2-374	MMUN2112LT1	1-12, 2-445	MPQ7091	2-523
MMBT6428LT1	1-15, 2-379	MMUN2113LT1	1-12, 2-445	MPQ7093	1-9, 2-523
MMBT6429LT1	1-15, 2-379	MMUN2114LT1	1-12, 2-445	MPS404A	1-7, 2-525
MMBT6517LT1	1-16, 2-383	MMUN2115LT1	1-12, 2-445	MPS650	1-4, 2-529
MMBT6520LT1	1-16, 2-388	MMUN2116LT1	1-12, 2-446	MPS651	1-4, 2-529
MMBTA05LT1	2-393	MMUN2130LT1	1-12, 2-446	MPS750	1-4, 2-529
MMBTA06LT1	1-16, 2-393	MMUN2131LT1	1-12, 2-446	MPS751	1-4, 2-529
MMBTA13LT1	1-15, 2-395	MMUN2132LT1	1-12, 2-446	MPS918	1-6, 2-532
MMBTA14LT1	1-15, 2-395	MMUN2133LT1	1-12, 2-446	MPS2222	2-534
MMBTA20LT1	2-400	MMUN2134LT1	1-12, 2-446	MPS2222A	1-2, 2-534
MMBTA42LT1	1-16, 2-406	MMUN2211LT1	1-12, 2-452	MPS2369	2-539
MMBTA43LT1	2-406	MMUN2212LT1	1-12, 2-452	MPS2369A	1-6, 2-539
MMBTA55LT1	2-409	MMUN2213LT1	1-12, 2-452	MPS2907	2-542
MMBTA56LT1	1-16, 2-409	MMUN2214LT1	1-12, 2-452	MPS2907A	1-2, 2-542
MMBTA63LT1	2-410	MMUN2215LT1	1-12, 2-452	MPS3563	1-6, 2-532
MMBTA64LT1	1-15, 2-410	MMUN2216LT1	1-12, 2-452	MPS3638A	2-546
MMBTA70LT1	2-412	MMUN2230LT1	1-12, 2-452	MPS3640	2-552
MMBTA92LT1	1-16, 2-417	MMUN2231LT1	1-12, 2-452	MPS3646	1-6, 2-555
MMBTA93LT1	2-417	MMUN2232LT1	1-12, 2-452	MPS3904	1-3, 2-560
MMBTH10LT1	1-14, 2-420	MMUN2233LT1	1-12, 2-452	MPS3906	1-3, 2-566
MMBTH24LT1	1-14, 2-424	MMUN2234LT1	1-12, 2-452	MPS4124	2-572
MMBTH69LT1	1-14, 2-426	MPF102	1-18, 4-190	MPS4126	2-574
MMBTH81LT1	1-14, 2-427	MPF910	1-20, 4-87	MPS4250	1-3, 2-576
MMBV105GLT1	1-26, 1-28, 5-125	MPF930	1-20, 4-90	MPS5179	1-6, 2-578
MMBV109LT1	1-26, 1-28, 5-91	MPF960	1-20, 4-90	MPS6428	1-3, 2-580
MMBV409LT1	1-27, 1-28, 5-127	MPF990	1-20, 4-90	MPS6507	2-582
MMBV432LT1	1-23, 1-25, 5-129	MPF4392	1-19, 4-197	MPS6521	1-3, 2-583
MMBV609LT1	1-27, 1-28, 5-131	MPF4393	1-19, 4-197	MPS6523	1-3, 2-583
MMBV809LT1	1-27, 1-28, 5-133	MPF6659	1-20, 4-93	MPS6560	2-594
MMBV2101LT1	1-23, 1-25, 5-135	MPF6660	1-20, 4-93	MPS6601	2-596
MMBV2103LT1	1-25, 5-135	MPF6661	1-20, 4-93	MPS6602	1-2, 2-596

Alphanumeric Index

Device	Page	Device	Page	Device	Page
MPS6651	2-596	MSB709-RT1	1-11, 2-717	MUN5211DW1T1	1-13, 2-761
MPS6652	1-2, 2-596	MSB710-RT1	1-11, 2-718	MUN5211T1	1-13, 2-769
MPS6714	2-602	MSB1218A-RT1	1-11, 2-720	MUN5212DW1T1	1-13, 2-761
MPS6715	1-4, 2-602	MSC2295-BT1	1-14, 2-723	MUN5212T1	1-13, 2-769
MPS6717	1-3, 2-605	MSC2295-CT1	1-14, 2-723	MUN5213DW1T1	1-13, 2-761
MPS6724	2-608	MSC3130T1	1-14, 2-724	MUN5213T1	1-13, 2-769
MPS6725	2-608	MSC3930-BT1	1-11	MUN5214DW1T1	1-13, 2-761
MPS6726	2-611	MSD601-RT1	1-11, 2-725	MUN5214T1	1-13, 2-769
MPS6727	1-4, 2-611	MSD601-ST1	1-11, 2-725	MUN5215DW1T1	1-13, 2-761
MPS8098	2-614	MSD602-RT1	1-11, 2-726	MUN5215T1	1-13, 2-769
MPS8099	1-2, 2-614	MSD1010T1	1-16, 1-36, 2-300, 3-67	MUN5216DW1T1	1-13, 2-761
MPS8598	2-614	MSD1328-RT1	1-11, 2-727	MUN5216T1	1-13, 2-769
MPS8599	1-2, 2-614	MSD1819A-RT1	1-11, 2-728	MUN5230DW1T1	1-13, 2-761
MPSA05	1-2, 2-619	MSD6100	5-151	MUN5230T1	1-13, 2-769
MPSA06	1-2, 2-619	MSD6150	5-153	MUN5231DW1T1	1-13, 2-761
MPSA13	1-4, 2-624	MUN2111T1	1-12, 2-731	MUN5231T1	1-13, 2-769
MPSA14	1-4, 2-624	MUN2112T1	1-12, 2-731	MUN5232DW1T1	1-13, 2-761
MPSA17	1-7, 2-629	MUN2113T1	1-12, 2-731	MUN5232T1	1-13, 2-769
MPSA18	1-3, 2-632	MUN2114T1	1-12, 2-731	MUN5233DW1T1	1-13, 2-761
MPSA20	1-2, 2-636	MUN2115T1	1-12, 2-731	MUN5233T1	1-13, 2-769
MPSA27	1-4, 2-642	MUN2116T1	1-12, 2-731	MUN5234DW1T1	1-13, 2-761
MPSA28	2-645	MUN2130T1	1-12, 2-731	MUN5234T1	1-13, 2-769
MPSA29	1-4, 2-645	MUN2131T1	1-12, 2-731	MUN5235DW1T1	1-13, 2-761
MPSA42	1-5, 2-648	MUN2132T1	1-12, 2-731	MUN5311DW1T1	1-13, 2-777
MPSA43	2-648	MUN2133T1	1-12, 2-731	MUN5312DW1T1	1-13, 2-777
MPSA44	1-5, 2-651	MUN2134T1	1-12, 2-731	MUN5313DW1T1	1-13, 2-777
MPSA55	1-2, 2-619	MUN2211T1	1-12, 2-738	MUN5314DW1T1	1-13, 2-777
MPSA56	1-2, 2-619	MUN2212T1	1-12, 2-738	MUN5315DW1T1	1-13, 2-777
MPSA62	2-655	MUN2213T1	1-12, 2-738	MUN5316DW1T1	1-13, 2-777
MPSA63	1-4, 2-655	MUN2214T1	1-12, 2-738	MUN5330DW1T1	1-13, 2-777
MPSA64	1-4, 2-655	MUN2215T1	1-12, 2-738	MUN5331DW1T1	1-13, 2-777
MPSA70	1-2, 2-658	MUN2216T1	1-12, 2-738	MUN5332DW1T1	1-13, 2-777
MPSA75	1-4, 2-664	MUN2230T1	1-12, 2-738	MUN5333DW1T1	1-13, 2-777
MPSA77	1-4, 2-664	MUN2231T1	1-12, 2-738	MUN5334DW1T1	1-13, 2-777
MPSA92	1-5, 2-666	MUN2232T1	1-12, 2-738	MUN5335DW1T1	2-777
MPSA93	2-666	MUN2233T1	1-12, 2-738	MV104	1-23, 1-25, 5-155
MPSH10	1-6, 2-669	MUN2234T1	1-12, 2-738	MV209	1-26, 1-28, 5-91
MPSH11	1-6, 2-669	MUN5111DW1T1	1-13, 2-746	MV409	1-27, 1-28, 5-127
MPSH17	1-6, 2-671	MUN5111T1	1-13, 2-754	MV1403	1-27, 1-28, 5-157
MPSH81	1-6, 2-673	MUN5112DW1T1	1-13, 2-746	MV1404	1-27, 1-28, 5-157
MPSL01	2-676	MUN5112T1	1-13, 2-754	MV1405	1-27, 1-28, 5-157
MPSL51	2-680	MUN5113DW1T1	1-13, 2-746	MV1626	1-24, 5-159
MPSW01	2-684	MUN5113T1	1-13, 2-754	MV1628	1-23, 1-24, 5-159
MPSW01A	1-4, 2-684	MUN5114DW1T1	1-13, 2-746	MV1630	1-24, 5-159
MPSW05	2-687	MUN5114T1	1-13, 2-754	MV1634	1-24, 5-159
MPSW06	1-3, 2-687	MUN5115DW1T1	1-13, 2-746	MV1638	1-23, 1-24, 5-159
MPSW10	2-690	MUN5115T1	1-13, 2-754	MV1648	1-24, 5-159
MPSW13	2-693	MUN5116DW1T1	1-13, 2-746	MV1650	1-23, 1-24, 5-159
MPSW14	2-693	MUN5116T1	1-13, 2-754	MV2101	1-23, 1-24, 5-135
MPSW42	1-5, 2-696	MUN5130DW1T1	1-13, 2-746	MV2104	1-24, 5-135
MPSW45	2-699	MUN5130T1	1-13, 2-754	MV2105	1-23, 1-24, 5-135
MPSW45A	1-4, 2-699	MUN5131DW1T1	1-13, 2-746	MV2108	1-24, 5-135
MPSW51	2-704	MUN5131T1	1-13, 2-754	MV2109	1-23, 1-24, 5-135
MPSW51A	1-4, 2-704	MUN5132DW1T1	1-13, 2-746	MV2111	1-24, 5-135
MPSW55	2-707	MUN5132T1	1-13, 2-754	MV2115	1-23, 1-24, 5-135
MPSW56	1-3, 2-707	MUN5133DW1T1	1-13, 2-746	MV7005T1	1-27, 1-28, 5-160
MPSW63	2-710	MUN5133T1	1-13, 2-754	MV7404T1	1-27, 1-28, 5-162
MPSW64	1-4, 2-710	MUN5134DW1T1	1-13, 2-746	P2N2222A	1-7, 2-789
MPSW92	1-5, 2-713	MUN5134T1	1-13, 2-754	P2N2907A	1-7, 2-794
MSA1022-CT1	1-14, 2-716	MUN5135DW1T1	1-13, 2-746	PZT651T1	1-17, 2-798

Alphanumeric Index

<u>Device</u>	<u>Page</u>	<u>Device</u>	<u>Page</u>	<u>Device</u>	<u>Page</u>
PZT751T1	1-17, 2-800	PZTA96T1	1-17, 2-817		
PZT2222AT1	1-17, 2-802	VN10LM	1-20, 4-101		
PZT2907AT1	1-17, 2-805	VN0300L	1-20, 4-96		
PZTA14T1	1-17, 2-808	VN0610LL	1-20, 4-98		
PZTA42T1	1-17, 2-811	VN2222LL	1-20, 4-103		
PZTA64T1	1-17, 2-813	VN2406L	1-20, 4-106		
PZTA92T1	1-17, 2-816	VN2410L	1-20, 4-108		

1 Selector Guide

2 Plastic-Encapsulated Transistors

3 GreenLine™ Portfolio Devices

4 Small-Signal Field-Effect Transistors and MOSFETs

5 Small-Signal Tuning and Switching Diodes

6 Tape and Reel Specifications and Packaging Specifications

7 Surface Mount Information

8 Package Outline Dimensions

9 Reliability and Quality Assurance

10 Replacement Devices

11 Alphanumeric Index



MOTOROLA

Mfax is a trademark of Motorola, Inc.

How to reach us:

USA/EURCPE/Locations Not Listed: Motorola Literature Distribution,
P.O. Box 5405, Denver, Colorado 80217, 1-303-675-2140 or 1-800-441-2447

JAPAN: Nippon Motorola Ltd. SPD, Strategic Planning Office, 4-32-1,
Nishi-Gotanda, Shinagawa-ku, Tokyo 141, Japan. 81-3-5467-8488

Customer Focus Center: 1-800-521-6274

Mfax™: RMFAX0@email.sps.mot.com – TOUCHTONE 1-602-244-6609
Motorola Fax Back System – US & Canada ONLY 1-800-774-1848
– <http://sps.motorola.com/mfax/>

ASIA/PACIFIC: Motorola Semiconductors H.K. Ltd. 9B Tai Ping Industrial Park,
51 Ting Kok Road, Tai Po, N.T., Hong Kong. 852-26629298

HOME PAGE: <http://motorola.com/sps/>